



**INSTRUCTOR
SOLUTIONS
MANUAL**

THOMAS' *Thirteenth Edition*
CALCULUS

Early Transcendentals

Single Variable

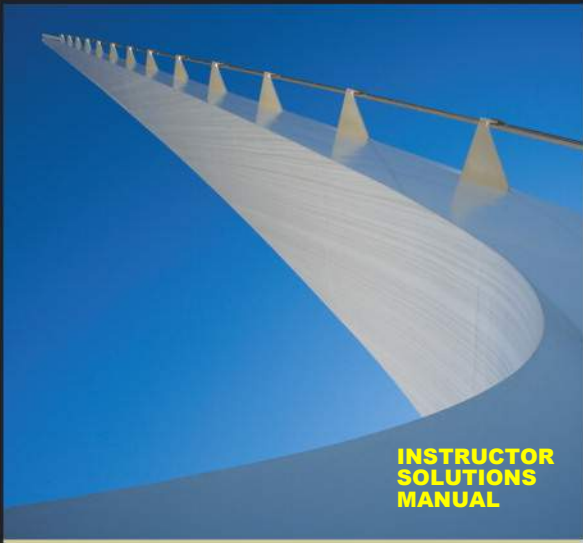

**INSTRUCTOR
SOLUTIONS
MANUAL**

THOMAS'

Thirteenth Edition

CALCULUS

Multivariable

INSTRUCTOR'S SOLUTIONS MANUAL SINGLE VARIABLE

ELKA BLOCK

FRANK PURCELL

THOMAS' CALCULUS EARLY TRANSCENDENTALS THIRTEENTH EDITION

Based on the original work by
George B. Thomas, Jr
Massachusetts Institute of Technology

as revised by
Maurice D. Weir
Naval Postgraduate School

Joel Hass
University of California, Davis

with the assistance of
Christopher Heil
Georgia Institute of Technology

PEARSON

Boston Columbus Indianapolis New York San Francisco Upper Saddle River
Amsterdam Cape Town Dubai London Madrid Milan Munich Paris Montreal Toronto
Delhi Mexico City São Paulo Sydney Hong Kong Seoul Singapore Taipei Tokyo



This work is protected by United States copyright laws and is provided solely for the use of instructors in teaching their courses and assessing student learning. Dissemination or sale of any part of this work (including on the World Wide Web) will destroy the integrity of the work and is not permitted. The work and materials from it should never be made available to students except by instructors using the accompanying text in their classes. All recipients of this work are expected to abide by these restrictions and to honor the intended pedagogical purposes and the needs of other instructors who rely on these materials.

The author and publisher of this book have used their best efforts in preparing this book. These efforts include the development, research, and testing of the theories and programs to determine their effectiveness. The author and publisher make no warranty of any kind, expressed or implied, with regard to these programs or the documentation contained in this book. The author and publisher shall not be liable in any event for incidental or consequential damages in connection with, or arising out of, the furnishing, performance, or use of these programs.

Reproduced by Pearson from electronic files supplied by the author.

Copyright © 2014, 2010, 2008 Pearson Education, Inc.
Publishing as Pearson, 75 Arlington Street, Boston, MA 02116.

All rights reserved. No part of this publication may be reproduced, stored in a retrieval system, or transmitted, in any form or by any means, electronic, mechanical, photocopying, recording, or otherwise, without the prior written permission of the publisher. Printed in the United States of America.

ISBN-13: 978-0-321-88408-4
ISBN-10: 0-321-88408-6

1 2 3 4 5 6 ?? 17 16 15 14 13

www.pearsonhighered.com

PEARSON

TABLE OF CONTENTS

1 Functions 1

- 1.1 Functions and Their Graphs 1
- 1.2 Combining Functions; Shifting and Scaling Graphs 8
- 1.3 Trigonometric Functions 18
- 1.4 Graphing with Software 26
- 1.5 Exponential Functions 31
- 1.6 Inverse Functions and Logarithms 34
 - Practice Exercises 43
 - Additional and Advanced Exercises 52

2 Limits and Continuity 59

- 2.1 Rates of Change and Tangents to Curves 59
- 2.2 Limit of a Function and Limit Laws 62
- 2.3 The Precise Definition of a Limit 73
- 2.4 One-Sided Limits 81
- 2.5 Continuity 86
- 2.6 Limits Involving Infinity; Asymptotes of Graphs 92
 - Practice Exercises 102
 - Additional and Advanced Exercises 108

3 Differentiation 115

- 3.1 Tangents and the Derivative at a Point 115
- 3.2 The Derivative as a Function 121
- 3.3 Differentiation Rules 131
- 3.4 The Derivative as a Rate of Change 138
- 3.5 Derivatives of Trigonometric Functions 144
- 3.6 The Chain Rule 152
- 3.7 Implicit Differentiation 162
- 3.8 Derivatives of Inverse Functions and Logarithms 170
- 3.9 Inverse Trigonometric Functions 180
- 3.10 Related Rates 186
- 3.11 Linearization and Differentials 192
 - Practice Exercises 199
 - Additional and Advanced Exercises 214

4 Applications of Derivatives 219

- 4.1 Extreme Values of Functions 219
- 4.2 The Mean Value Theorem 233
- 4.3 Monotonic Functions and the First Derivative Test 239
- 4.4 Concavity and Curve Sketching 253
- 4.5 Indeterminate Forms and L'Hôpital's Rule 280
- 4.6 Applied Optimization 290
- 4.7 Newton's Method 304
- 4.8 Antiderivatives 309
 - Practice Exercises 318
 - Additional and Advanced Exercises 336

5 Integration 343

- 5.1 Area and Estimating with Finite Sums 343
- 5.2 Sigma Notation and Limits of Finite Sums 348
- 5.3 The Definite Integral 354
- 5.4 The Fundamental Theorem of Calculus 369
- 5.5 Indefinite Integrals and the Substitution Method 379
- 5.6 Substitution and Area Between Curves 387
 - Practice Exercises 407
 - Additional and Advanced Exercises 422

6 Applications of Definite Integrals 431

- 6.1 Volumes Using Cross-Sections 431
- 6.2 Volumes Using Cylindrical Shells 443
- 6.3 Arc Length 454
- 6.4 Areas of Surfaces of Revolution 462
- 6.5 Work and Fluid Forces 468
- 6.6 Moments and Centers of Mass 479
 - Practice Exercises 492
 - Additional and Advanced Exercises 501

7 Integrals and Transcendental Functions 507

- 7.1 The Logarithm Defined as an Integral 507
- 7.2 Exponential Change and Separable Differential Equations 515
- 7.3 Hyperbolic Functions 521
- 7.4 Relative Rates of Growth 529
 - Practice Exercises 535
 - Additional and Advanced Exercises 540

8 Techniques of Integration 543

- 8.1 Using Basic Integration Formulas 543
- 8.2 Integration by Parts 555

- 8.3 Trigonometric Integrals 569
- 8.4 Trigonometric Substitutions 577
- 8.5 Integration of Rational Functions by Partial Fractions 585
- 8.6 Integral Tables and Computer Algebra Systems 594
- 8.7 Numerical Integration 607
- 8.8 Improper Integrals 617
- 8.9 Probability 629
 - Practice Exercises 637
 - Additional and Advanced Exercises 650

9 First-Order Differential Equations 661

- 9.1 Solutions, Slope Fields, and Euler's Method 661
- 9.2 First-Order Linear Equations 670
- 9.3 Applications 674
- 9.4 Graphical Solutions of Autonomous Equations 678
- 9.5 Systems of Equations and Phase Planes 986
 - Practice Exercises 692
 - Additional and Advanced Exercises 698

10 Infinite Sequences and Series 701

- 10.1 Sequences 701
- 10.2 Infinite Series 712
- 10.3 The Integral Test 720
- 10.4 Comparison Tests 728
- 10.5 Absolute Convergence; The Ratio and Root Tests 738
- 10.6 Alternating Series and Conditional Convergence 744
- 10.7 Power Series 752
- 10.8 Taylor and Maclaurin Series 764
- 10.9 Convergence of Taylor Series 769
- 10.10 The Binomial Series and Applications of Taylor Series 777
 - Practice Exercises 786
 - Additional and Advanced Exercises 795

11 Parametric Equations and Polar Coordinates 801

- 11.1 Parametrizations of Plane Curves 801
- 11.2 Calculus with Parametric Curves 809
- 11.3 Polar Coordinates 819
- 11.4 Graphing Polar Coordinate Equations 825
- 11.5 Areas and Lengths in Polar Coordinates 832
- 11.6 Conic Sections 838
- 11.7 Conics in Polar Coordinates 849
 - Practice Exercises 860
 - Additional and Advanced Exercises 871

CHAPTER 1 FUNCTIONS

1.1 FUNCTIONS AND THEIR GRAPHS

1. domain = $(-\infty, \infty)$; range = $[1, \infty)$
2. domain = $[0, \infty)$; range = $(-\infty, 1]$
3. domain = $[-2, \infty)$; y in range and $y = \sqrt{5x+10} \geq 0 \Rightarrow y$ can be any positive real number \Rightarrow range = $[0, \infty)$.
4. domain = $(-\infty, 0] \cup [3, \infty)$; y in range and $y = \sqrt{x^2 - 3x} \geq 0 \Rightarrow y$ can be any positive real number \Rightarrow range = $[0, \infty)$.
5. domain = $(-\infty, 3) \cup (3, \infty)$; y in range and $y = \frac{4}{3-t}$, now if $t < 3 \Rightarrow 3-t > 0 \Rightarrow \frac{4}{3-t} > 0$, or if $t > 3 \Rightarrow 3-t < 0 \Rightarrow \frac{4}{3-t} < 0 \Rightarrow y$ can be any nonzero real number \Rightarrow range = $(-\infty, 0) \cup (0, \infty)$.
6. domain = $(-\infty, -4) \cup (-4, 4) \cup (4, \infty)$; y in range and $y = \frac{2}{t^2-16}$, now if $t < -4 \Rightarrow t^2 - 16 > 0 \Rightarrow \frac{2}{t^2-16} > 0$, or if $-4 < t < 4 \Rightarrow -16 \leq t^2 - 16 < 0 \Rightarrow -\frac{2}{16} \geq \frac{2}{t^2-16}$, or if $t > 4 \Rightarrow t^2 - 16 > 0 \Rightarrow \frac{2}{t^2-16} > 0 \Rightarrow y$ can be any nonzero real number \Rightarrow range = $(-\infty, -\frac{1}{8}] \cup (0, \infty)$.
7. (a) Not the graph of a function of x since it fails the vertical line test.
(b) Is the graph of a function of x since any vertical line intersects the graph at most once.
8. (a) Not the graph of a function of x since it fails the vertical line test.
(b) Not the graph of a function of x since it fails the vertical line test.
9. base = x ; $(\text{height})^2 + \left(\frac{x}{2}\right)^2 = x^2 \Rightarrow \text{height} = \frac{\sqrt{3}}{2}x$; area is $a(x) = \frac{1}{2}(\text{base})(\text{height}) = \frac{1}{2}(x)\left(\frac{\sqrt{3}}{2}x\right) = \frac{\sqrt{3}}{4}x^2$;
perimeter is $p(x) = x + x + x = 3x$.
10. $s =$ side length $\Rightarrow s^2 + s^2 = d^2 \Rightarrow s = \frac{d}{\sqrt{2}}$; and area is $a = s^2 \Rightarrow a = \frac{1}{2}d^2$
11. Let $D =$ diagonal length of a face of the cube and $\ell =$ the length of an edge. Then $\ell^2 + D^2 = d^2$ and $D^2 = 2\ell^2 \Rightarrow 3\ell^2 = d^2 \Rightarrow \ell = \frac{d}{\sqrt{3}}$. The surface area is $6\ell^2 = \frac{6d^2}{3} = 2d^2$ and the volume is $\ell^3 = \left(\frac{d}{\sqrt{3}}\right)^3 = \frac{d^3}{3\sqrt{3}}$.
12. The coordinates of P are (x, \sqrt{x}) so the slope of the line joining P to the origin is $m = \frac{\sqrt{x}}{x} = \frac{1}{\sqrt{x}} (x > 0)$.
Thus, $(x, \sqrt{x}) = \left(\frac{1}{m^2}, \frac{1}{m}\right)$.
13. $2x + 4y = 5 \Rightarrow y = -\frac{1}{2}x + \frac{5}{4}$; $L = \sqrt{(x-0)^2 + (y-0)^2} = \sqrt{x^2 + \left(-\frac{1}{2}x + \frac{5}{4}\right)^2} = \sqrt{x^2 + \frac{1}{4}x^2 - \frac{5}{4}x + \frac{25}{16}}$
 $= \sqrt{\frac{5}{4}x^2 - \frac{5}{4}x + \frac{25}{16}} = \sqrt{\frac{20x^2 - 20x + 25}{16}} = \frac{\sqrt{20x^2 - 20x + 25}}{4}$
14. $y = \sqrt{x-3} \Rightarrow y^2 + 3 = x$; $L = \sqrt{(x-4)^2 + (y-0)^2} = \sqrt{(y^2 + 3 - 4)^2 + y^2} = \sqrt{(y^2 - 1)^2 + y^2}$
 $= \sqrt{y^4 - 2y^2 + 1 + y^2} = \sqrt{y^4 - y^2 + 1}$

2 Chapter 1 Functions

15. The domain is $(-\infty, \infty)$.

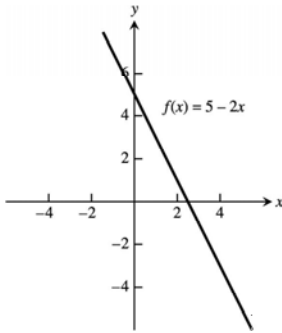

16. The domain is $(-\infty, \infty)$.

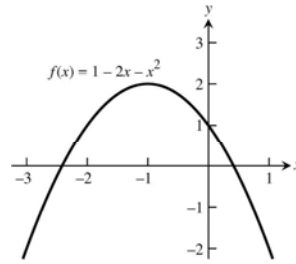

17. The domain is $(-\infty, \infty)$.

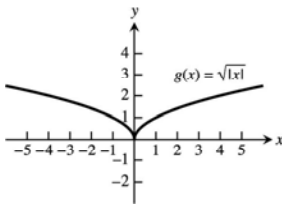

18. The domain is $(-\infty, 0]$.

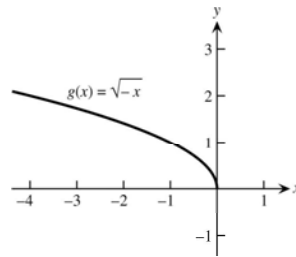

19. The domain is $(-\infty, 0) \cup (0, \infty)$.

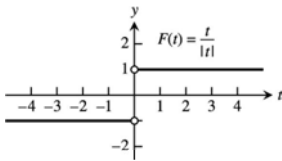

20. The domain is $(-\infty, 0) \cup (0, \infty)$.

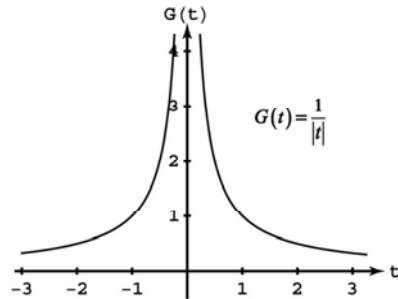

21. The domain is $(-\infty, -5) \cup (-5, -3] \cup [3, 5) \cup (5, \infty)$ 22. The range is $[2, 3)$.

23. Neither graph passes the vertical line test

(a)

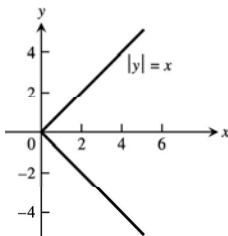

(b)

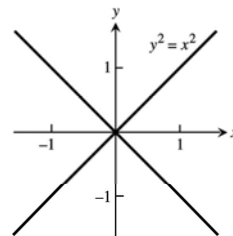

24. Neither graph passes the vertical line test

(a)

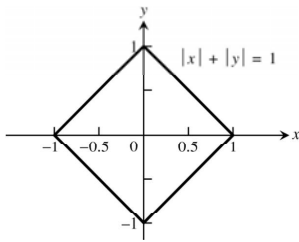

(b)

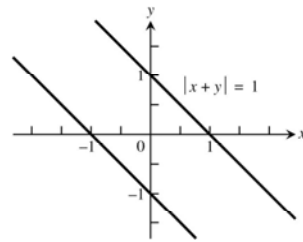

$$|x+y|=1 \Leftrightarrow \left\{ \begin{array}{l} x+y=1 \\ \text{or} \\ x+y=-1 \end{array} \right\} \Leftrightarrow \left\{ \begin{array}{l} y=1-x \\ \text{or} \\ y=-1-x \end{array} \right\}$$

25.

x	0	1	2
y	0	1	0

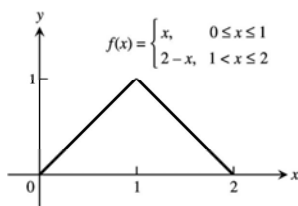

26.

x	0	1	2
y	1	0	0

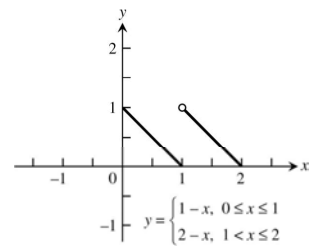

27. $F(x) = \begin{cases} 4-x^2, & x \leq 1 \\ x^2+2x, & x > 1 \end{cases}$

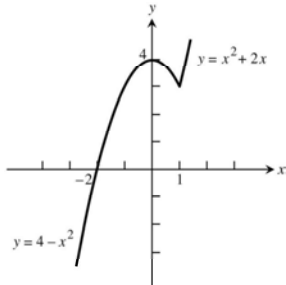

28. $G(x) = \begin{cases} \frac{1}{x}, & x < 0 \\ x, & 0 \leq x \end{cases}$

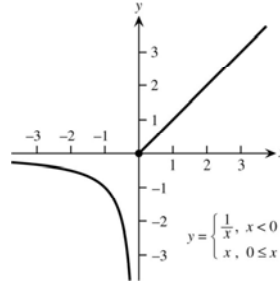

29. (a) Line through (0, 0) and (1, 1): $y = x$; Line through (1, 1) and (2, 0): $y = -x + 2$

$$f(x) = \begin{cases} x, & 0 \leq x \leq 1 \\ -x+2, & 1 < x \leq 2 \end{cases}$$

(b) $f(x) = \begin{cases} 2, & 0 \leq x < 1 \\ 0, & 1 \leq x < 2 \\ 2, & 2 \leq x < 3 \\ 0, & 3 \leq x \leq 4 \end{cases}$

30. (a) Line through (0, 2) and (2, 0): $y = -x + 2$

Line through (2, 1) and (5, 0): $m = \frac{0-1}{5-2} = \frac{-1}{3} = -\frac{1}{3}$, so $y = -\frac{1}{3}(x-2) + 1 = -\frac{1}{3}x + \frac{5}{3}$

$$f(x) = \begin{cases} -x+2, & 0 < x \leq 2 \\ -\frac{1}{3}x + \frac{5}{3}, & 2 < x \leq 5 \end{cases}$$

4 Chapter 1 Functions

(b) Line through $(-1, 0)$ and $(0, -3)$: $m = \frac{-3-0}{0-(-1)} = -3$, so $y = -3x - 3$

Line through $(0, 3)$ and $(2, -1)$: $m = \frac{-1-3}{2-0} = \frac{-4}{2} = -2$, so $y = -2x + 3$

$$f(x) = \begin{cases} -3x - 3, & -1 < x \leq 0 \\ -2x + 3, & 0 < x \leq 2 \end{cases}$$

31. (a) Line through $(-1, 1)$ and $(0, 0)$: $y = -x$

Line through $(0, 1)$ and $(1, 1)$: $y = 1$

Line through $(1, 1)$ and $(3, 0)$: $m = \frac{0-1}{3-1} = \frac{-1}{2} = -\frac{1}{2}$, so $y = -\frac{1}{2}(x-1) + 1 = -\frac{1}{2}x + \frac{3}{2}$

$$f(x) = \begin{cases} -x & -1 \leq x < 0 \\ 1 & 0 < x \leq 1 \\ -\frac{1}{2}x + \frac{3}{2} & 1 < x < 3 \end{cases}$$

(b) Line through $(-2, -1)$ and $(0, 0)$: $y = \frac{1}{2}x$

Line through $(0, 2)$ and $(1, 0)$: $y = -2x + 2$

Line through $(1, -1)$ and $(3, -1)$: $y = -1$

$$f(x) = \begin{cases} \frac{1}{2}x & -2 \leq x \leq 0 \\ -2x + 2 & 0 < x \leq 1 \\ -1 & 1 < x \leq 3 \end{cases}$$

32. (a) Line through $(\frac{T}{2}, 0)$ and $(T, 1)$: $m = \frac{1-0}{T-(T/2)} = \frac{2}{T}$, so $y = \frac{2}{T}(x - \frac{T}{2}) + 0 = \frac{2}{T}x - 1$

$$f(x) = \begin{cases} 0, & 0 \leq x \leq \frac{T}{2} \\ \frac{2}{T}x - 1, & \frac{T}{2} < x \leq T \end{cases}$$

$$(b) f(x) = \begin{cases} A, & 0 \leq x < \frac{T}{2} \\ -A, & \frac{T}{2} \leq x < T \\ A, & T \leq x < \frac{3T}{2} \\ -A, & \frac{3T}{2} \leq x \leq 2T \end{cases}$$

33. (a) $\lfloor x \rfloor = 0$ for $x \in [0, 1)$

(b) $\lceil x \rceil = 0$ for $x \in (-1, 0]$

34. $\lfloor x \rfloor = \lceil x \rceil$ only when x is an integer.

35. For any real number x , $n \leq x < n+1$, where n is an integer. Now: $n \leq x < n+1 \Rightarrow -(n+1) \leq -x < -n$.
By definition: $\lceil -x \rceil = -n$ and $\lfloor x \rfloor = n \Rightarrow -\lfloor x \rfloor = -n$. So $\lceil -x \rceil = -\lfloor x \rfloor$ for all real x .

36. To find $f(x)$ you delete the decimal or fractional portion of x , leaving only the integer part.

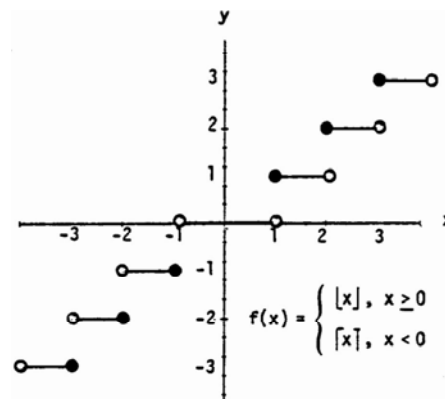

37. Symmetric about the origin
 Dec: $-\infty < x < \infty$
 Inc: nowhere

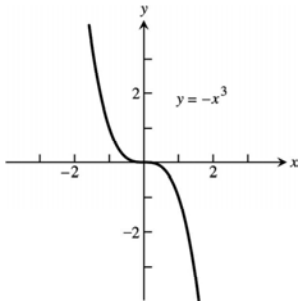

38. Symmetric about the y-axis
 Dec: $-\infty < x < 0$
 Inc: $0 < x < \infty$

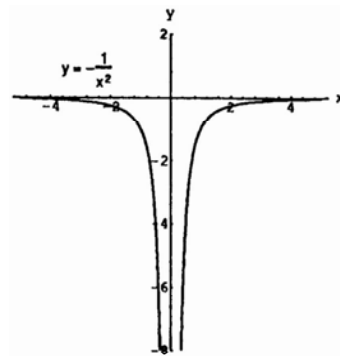

39. Symmetric about the origin
 Dec: nowhere
 Inc: $-\infty < x < 0$
 $0 < x < \infty$

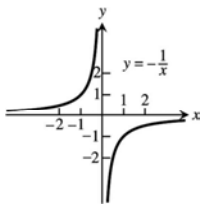

40. Symmetric about the y-axis
 Dec: $0 < x < \infty$
 Inc: $-\infty < x < 0$

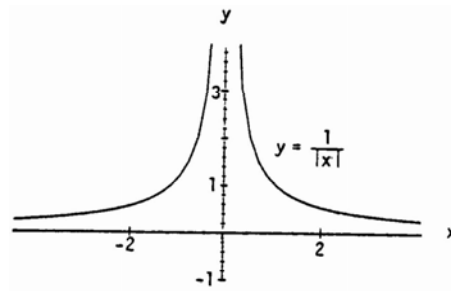

41. Symmetric about the y-axis
 Dec: $-\infty < x \leq 0$
 Inc: $0 \leq x < \infty$

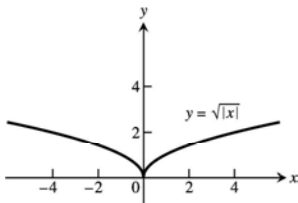

42. No symmetry
 Dec: $-\infty < x \leq 0$
 Inc: nowhere

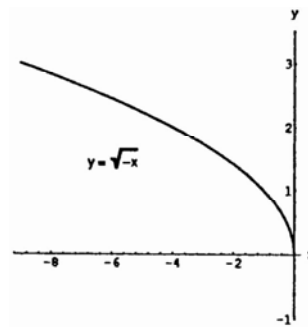

6 Chapter 1 Functions

43. Symmetric about the origin
Dec: nowhere
Inc: $-\infty < x < \infty$

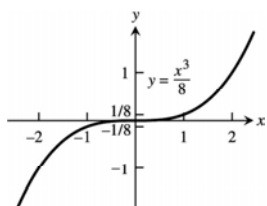

44. No symmetry
Dec: $0 \leq x < \infty$
Inc: nowhere

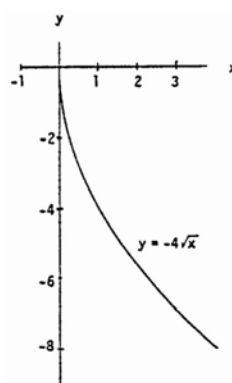

45. No symmetry
Dec: $0 \leq x < \infty$
Inc: nowhere

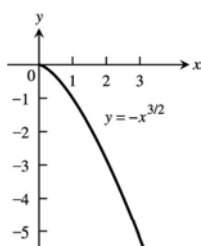

46. Symmetric about the y-axis
Dec: $-\infty < x \leq 0$
Inc: $0 \leq x < \infty$

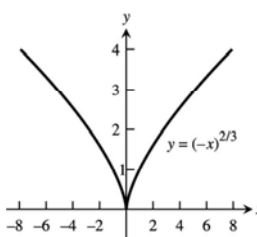

47. Since a horizontal line not through the origin is symmetric with respect to the y -axis, but not with respect to the origin, the function is even.

48. $f(x) = x^{-5} = \frac{1}{x^5}$ and $f(-x) = (-x)^{-5} = \frac{1}{(-x)^5} = -\left(\frac{1}{x^5}\right) = -f(x)$. Thus the function is odd.

49. Since $f(x) = x^2 + 1 = (-x)^2 + 1 = f(-x)$. The function is even.

50. Since $[f(x) = x^2 + x] \neq [f(-x) = (-x)^2 - x]$ and $[f(x) = x^2 + x] \neq [-f(x) = -(x)^2 - x]$ the function is neither even nor odd.

51. Since $g(x) = x^3 + x$, $g(-x) = -x^3 - x = -(x^3 + x) = -g(x)$. So the function is odd.

52. $g(x) = x^4 + 3x^2 - 1 = (-x)^4 + 3(-x)^2 - 1 = g(-x)$, thus the function is even.

53. $g(x) = \frac{1}{x^2-1} = \frac{1}{(-x)^2-1} = g(-x)$. Thus the function is even.

54. $g(x) = \frac{x}{x^2-1}$; $g(-x) = -\frac{x}{x^2-1} = -g(x)$. So the function is odd.

55. $h(t) = \frac{1}{t-1}$; $h(-t) = \frac{1}{-t-1}$; $-h(t) = \frac{1}{1-t}$. Since $h(t) \neq -h(t)$ and $h(t) \neq h(-t)$, the function is neither even nor odd.

56. Since $|t^3| = |(-t)^3|$, $h(t) = h(-t)$ and the function is even.
57. $h(t) = 2t + 1$, $h(-t) = -2t + 1$. So $h(t) \neq h(-t)$. $-h(t) = -2t - 1$, so $h(t) \neq -h(t)$. The function is neither even nor odd.
58. $h(t) = 2|t| + 1$ and $h(-t) = 2|-t| + 1 = 2|t| + 1$. So $h(t) = h(-t)$ and the function is even.
59. $s = kt \Rightarrow 25 = k(75) \Rightarrow k = \frac{1}{3} \Rightarrow s = \frac{1}{3}t$; $60 = \frac{1}{3}t \Rightarrow t = 180$
60. $K = cv^2 \Rightarrow 12960 = c(18)^2 \Rightarrow c = 40 \Rightarrow K = 40v^2$; $K = 40(10)^2 = 4000$ joules
61. $r = \frac{k}{s} \Rightarrow 6 = \frac{k}{4} \Rightarrow k = 24 \Rightarrow r = \frac{24}{s}$; $10 = \frac{24}{s} \Rightarrow s = \frac{12}{5}$
62. $P = \frac{k}{v} \Rightarrow 14.7 = \frac{k}{1000} \Rightarrow k = 14700 \Rightarrow P = \frac{14700}{v}$; $23.4 = \frac{14700}{v} \Rightarrow v = \frac{24500}{39} \approx 628.2$ in³
63. $v = f(x) = x(14 - 2x)(22 - 2x) = 4x^3 - 72x^2 + 308x$; $0 < x < 7$.
64. (a) Let h = height of the triangle. Since the triangle is isosceles, $(\overline{AB})^2 + (\overline{AB})^2 = 2^2 \Rightarrow \overline{AB} = \sqrt{2}$. So,
 $h^2 + 1^2 = (\sqrt{2})^2 \Rightarrow h = 1 \Rightarrow B$ is at $(0, 1) \Rightarrow$ slope of $AB = -1 \Rightarrow$ The equation of AB is
 $y = f(x) = -x + 1$; $x \in [0, 1]$.
- (b) $A(x) = 2xy = 2x(-x + 1) = -2x^2 + 2x$; $x \in [0, 1]$.
65. (a) Graph h because it is an even function and rises less rapidly than does Graph g .
 (b) Graph f because it is an odd function.
 (c) Graph g because it is an even function and rises more rapidly than does Graph h .
66. (a) Graph f because it is linear.
 (b) Graph g because it contains $(0, 1)$.
 (c) Graph h because it is a nonlinear odd function.
67. (a) From the graph, $\frac{x}{2} > 1 + \frac{4}{x} \Rightarrow x \in (-2, 0) \cup (4, \infty)$
 (b) $\frac{x}{2} > 1 + \frac{4}{x} \Rightarrow \frac{x}{2} - 1 - \frac{4}{x} > 0$
 $x > 0$: $\frac{x}{2} - 1 - \frac{4}{x} > 0 \Rightarrow \frac{x^2 - 2x - 8}{2x} > 0 \Rightarrow \frac{(x-4)(x+2)}{2x} > 0$
 $\Rightarrow x > 4$ since x is positive;
 $x < 0$: $\frac{x}{2} - 1 - \frac{4}{x} > 0 \Rightarrow \frac{x^2 - 2x - 8}{2x} < 0 \Rightarrow \frac{(x-4)(x+2)}{2x} < 0$
 $\Rightarrow x < -2$ since x is negative;
 sign of $(x-4)(x+2)$
-
- Solution interval: $(-2, 0) \cup (4, \infty)$

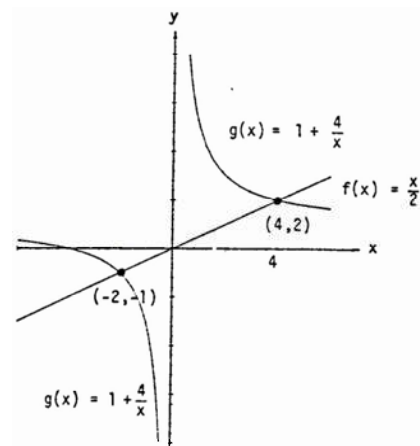

68. (a) From the graph, $\frac{3}{x-1} < \frac{2}{x+1} \Rightarrow x \in (-\infty, -5) \cup (-1, 1)$

(b) Case $x < -1$: $\frac{3}{x-1} < \frac{2}{x+1} \Rightarrow \frac{3(x+1)}{x-1} > 2$
 $\Rightarrow 3x+3 < 2x-2 \Rightarrow x < -5$.

Thus, $x \in (-\infty, -5)$ solves the inequality.

Case $-1 < x < 1$: $\frac{3}{x-1} < \frac{2}{x+1} \Rightarrow \frac{3(x+1)}{x-1} < 2$

$\Rightarrow 3x+3 > 2x-2 \Rightarrow x > -5$ which is true if $x > -1$. Thus, $x \in (-1, 1)$ solves the inequality.

Case $1 < x$: $\frac{3}{x-1} < \frac{2}{x+1} \Rightarrow 3x+3 < 2x-2 \Rightarrow x < -5$

which is never true if $1 < x$, so no solution here.

In conclusion, $x \in (-\infty, -5) \cup (-1, 1)$.

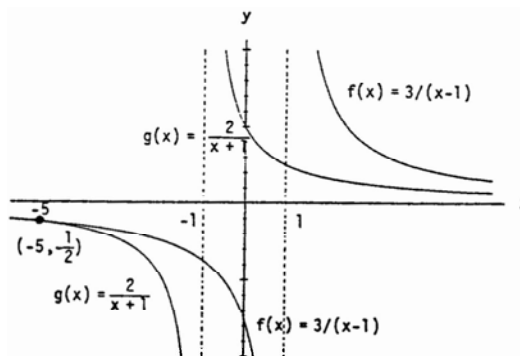

69. A curve symmetric about the x -axis will not pass the vertical line test because the points (x, y) and $(x, -y)$ lie on the same vertical line. The graph of the function $y = f(x) = 0$ is the x -axis, a horizontal line for which there is a single y -value, 0, for any x .

70. price = $40 + 5x$, quantity = $300 - 25x \Rightarrow R(x) = (40 + 5x)(300 - 25x)$

71. $x^2 + x^2 = h^2 \Rightarrow x = \frac{h}{\sqrt{2}} = \frac{\sqrt{2}h}{2}$; cost = $5(2x) + 10h \Rightarrow C(h) = 10\left(\frac{\sqrt{2}h}{2}\right) + 10h = 5h(\sqrt{2} + 2)$

72. (a) Note that 2 mi = 10,560 ft, so there are $\sqrt{800^2 + x^2}$ feet of river cable at \$180 per foot and $(10,560 - x)$ feet of land cable at \$100 per foot. The cost is $C(x) = 180\sqrt{800^2 + x^2} + 100(10,560 - x)$.

(b) $C(0) = \$1,200,000$

$C(500) \approx \$1,175,812$

$C(1000) \approx \$1,186,512$

$C(1500) \approx \$1,212,000$

$C(2000) \approx \$1,243,732$

$C(2500) \approx \$1,278,479$

$C(3000) \approx \$1,314,870$

Values beyond this are all larger. It would appear that the least expensive location is less than 2000 feet from the point P .

1.2 COMBINING FUNCTIONS; SHIFTING AND SCALING GRAPHS

1. $D_f: -\infty < x < \infty, D_g: x \geq 1 \Rightarrow D_{f+g} = D_{fg}: x \geq 1. R_f: -\infty < y < \infty, R_g: y \geq 0, R_{f+g}: y \geq 1, R_{fg}: y \geq 0$

2. $D_f: x+1 \geq 0 \Rightarrow x \geq -1, D_g: x-1 \geq 0 \Rightarrow x \geq 1$. Therefore $D_{f+g} = D_{fg}: x \geq 1$.

$R_f = R_g: y \geq 0, R_{f+g}: y \geq \sqrt{2}, R_{fg}: y \geq 0$

3. $D_f: -\infty < x < \infty, D_g: -\infty < x < \infty, D_{f/g}: -\infty < x < \infty, D_{g/f}: -\infty < x < \infty, R_f: y = 2, R_g: y \geq 1, R_{f/g}: 0 < y \leq 2, R_{g/f}: \frac{1}{2} \leq y < \infty$

4. $D_f: -\infty < x < \infty, D_g: x \geq 0, D_{f/g}: x \geq 0, D_{g/f}: x \geq 0; R_f: y = 1, R_g: y \geq 1, R_{f/g}: 0 < y \leq 1, R_{g/f}: 1 \leq y < \infty$

5. (a) 2 (b) 22 (c) $x^2 + 2$
 (d) $(x+5)^2 - 3 = x^2 + 10x + 22$ (e) 5 (f) -2
 (g) $x+10$ (h) $(x^2 - 3)^2 - 3 = x^4 - 6x^2 + 6$
6. (a) $-\frac{1}{3}$ (b) 2 (c) $\frac{1}{x+1} - 1 = \frac{-x}{x+1}$
 (d) $\frac{1}{x}$ (e) 0 (f) $\frac{3}{4}$
 (g) $x-2$ (h) $\frac{1}{\frac{1}{x+1} + 1} = \frac{1}{\frac{x+2}{x+1}} = \frac{x+1}{x+2}$
7. $(f \circ g \circ h)(x) = f(g(h(x))) = f(g(4-x)) = f(3(4-x)) = f(12-3x) = (12-3x) + 1 = 13-3x$
8. $(f \circ g \circ h)(x) = f(g(h(x))) = f(g(x^2)) = f(2(x^2) - 1) = f(2x^2 - 1) = 3(2x^2 - 1) + 4 = 6x^2 + 1$
9. $(f \circ g \circ h)(x) = f(g(h(x))) = f\left(g\left(\frac{1}{x}\right)\right) = f\left(\frac{1}{\frac{1}{x} + 4}\right) = f\left(\frac{x}{1+4x}\right) = \sqrt{\frac{x}{1+4x} + 1} = \sqrt{\frac{5x+1}{1+4x}}$
10. $(f \circ g \circ h)(x) = f(g(h(x))) = f\left(g\left(\sqrt{2-x}\right)\right) = f\left(\frac{(\sqrt{2-x})^2}{(\sqrt{2-x})^2 + 1}\right) = f\left(\frac{2-x}{3-x}\right) = \frac{\frac{2-x}{3-x} + 2}{3 - \frac{2-x}{3-x}} = \frac{8-3x}{7-2x}$
11. (a) $(f \circ g)(x)$ (b) $(j \circ g)(x)$ (c) $(g \circ g)(x)$
 (d) $(j \circ j)(x)$ (e) $(g \circ h \circ f)(x)$ (f) $(h \circ j \circ f)(x)$
12. (a) $(f \circ j)(x)$ (b) $(g \circ h)(x)$ (c) $(h \circ h)(x)$
 (d) $(f \circ f)(x)$ (e) $(j \circ g \circ f)(x)$ (f) $(g \circ f \circ h)(x)$
13.

$g(x)$	$f(x)$	$(f \circ g)(x)$
(a) $x-7$	\sqrt{x}	$\sqrt{x-7}$
(b) $x+2$	$3x$	$3(x+2) = 3x+6$
(c) x^2	$\sqrt{x-5}$	$\sqrt{x^2-5}$
(d) $\frac{x}{x-1}$	$\frac{x}{x-1}$	$\frac{\frac{x}{x-1}}{\frac{x}{x-1} - 1} = \frac{x}{x - (x-1)} = x$
(e) $\frac{1}{x-1}$	$1 + \frac{1}{x}$	x
(f) $\frac{1}{x}$	$\frac{1}{x}$	x
14. (a) $(f \circ g)(x) = |g(x)| = \frac{1}{|x-1|}$.
 (b) $(f \circ g)(x) = \frac{g(x)-1}{g(x)} = \frac{x}{x+1} \Rightarrow 1 - \frac{1}{g(x)} = \frac{x}{x+1} \Rightarrow 1 - \frac{x}{x+1} = \frac{1}{g(x)} \Rightarrow \frac{1}{x+1} = \frac{1}{g(x)}$, so $g(x) = x+1$.
 (c) Since $(f \circ g)(x) = \sqrt{g(x)} = |x|$, $g(x) = x^2$.
 (d) Since $(f \circ g)(x) = f(\sqrt{x}) = |x|$, $f(x) = x^2$. (Note that the domain of the composite is $[0, \infty)$.)

The completed table is shown. Note that the absolute value sign in part (d) is optional.

$g(x)$	$f(x)$	$(f \circ g)(x)$
$\frac{1}{x-1}$	$ x $	$\frac{1}{ x-1 }$
$x+1$	$\frac{x-1}{x}$	$\frac{x}{x+1}$
x^2	\sqrt{x}	$ x $
\sqrt{x}	x^2	$ x $

15. (a) $f(g(-1)) = f(1) = 1$ (b) $g(f(0)) = g(-2) = 2$ (c) $f(f(-1)) = f(0) = -2$
 (d) $g(g(2)) = g(0) = 0$ (e) $g(f(-2)) = g(1) = -1$ (f) $f(g(1)) = f(-1) = 0$

16. (a) $f(g(0)) = f(-1) = 2 - (-1) = 3$, where $g(0) = 0 - 1 = -1$
 (b) $g(f(3)) = g(-1) = -(-1) = 1$, where $f(3) = 2 - 3 = -1$
 (c) $g(g(-1)) = g(1) = 1 - 1 = 0$, where $g(-1) = -(-1) = 1$
 (d) $f(f(2)) = f(0) = 2 - 0 = 2$, where $f(2) = 2 - 2 = 0$
 (e) $g(f(0)) = g(2) = 2 - 1 = 1$, where $f(0) = 2 - 0 = 2$
 (f) $f\left(g\left(\frac{1}{2}\right)\right) = f\left(-\frac{1}{2}\right) = 2 - \left(-\frac{1}{2}\right) = \frac{5}{2}$, where $g\left(\frac{1}{2}\right) = \frac{1}{2} - 1 = -\frac{1}{2}$

17. (a) $(f \circ g)(x) = f(g(x)) = \sqrt{\frac{1}{x} + 1} = \sqrt{\frac{1+x}{x}}$
 $(g \circ f)(x) = g(f(x)) = \frac{1}{\sqrt{x+1}}$
 (b) Domain $(f \circ g)$: $(-\infty, -1] \cup (0, \infty)$, domain $(g \circ f)$: $(-1, \infty)$
 (c) Range $(f \circ g)$: $(1, \infty)$, range $(g \circ f)$: $(0, \infty)$

18. (a) $(f \circ g)(x) = f(g(x)) = 1 - 2\sqrt{x} + x$
 $(g \circ f)(x) = g(f(x)) = 1 - |x|$
 (b) Domain $(f \circ g)$: $[0, \infty)$, domain $(g \circ f)$: $(-\infty, \infty)$
 (c) Range $(f \circ g)$: $(0, \infty)$, range $(g \circ f)$: $(-\infty, 1]$

19. $(f \circ g)(x) = x \Rightarrow f(g(x)) = x \Rightarrow \frac{g(x)}{g(x)-2} = x \Rightarrow g(x) = (g(x)-2)x = x \cdot g(x) - 2x$
 $\Rightarrow g(x) - x \cdot g(x) = -2x \Rightarrow g(x) = -\frac{2x}{1-x} = \frac{2x}{x-1}$

20. $(f \circ g)(x) = x + 2 \Rightarrow f(g(x)) = x + 2 \Rightarrow 2(g(x))^3 - 4 = x + 2 \Rightarrow (g(x))^3 = \frac{x+6}{2} \Rightarrow g(x) = \sqrt[3]{\frac{x+6}{2}}$

21. (a) $y = -(x+7)^2$ (b) $y = -(x-4)^2$

22. (a) $y = x^2 + 3$ (b) $y = x^2 - 5$

23. (a) Position 4 (b) Position 1 (c) Position 2 (d) Position 3

24. (a) $y = -(x-1)^2 + 4$ (b) $y = -(x+2)^2 + 3$ (c) $y = -(x+4)^2 - 1$ (d) $y = -(x-2)^2$

25.

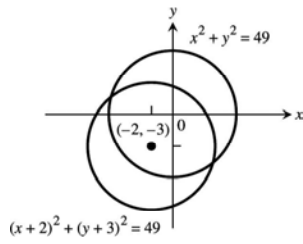

26.

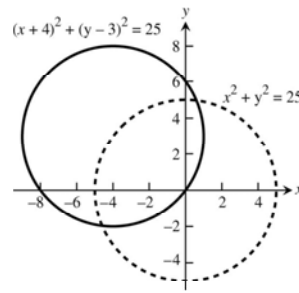

27.

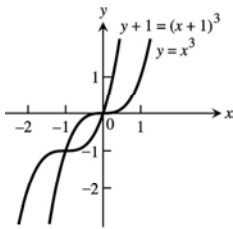

28.

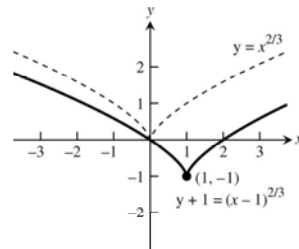

29.

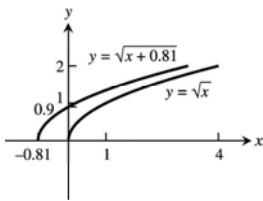

30.

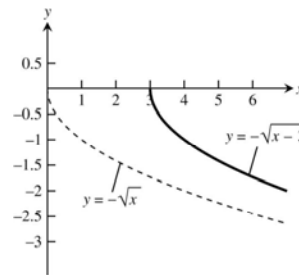

31.

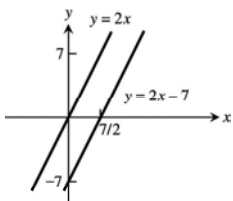

32.

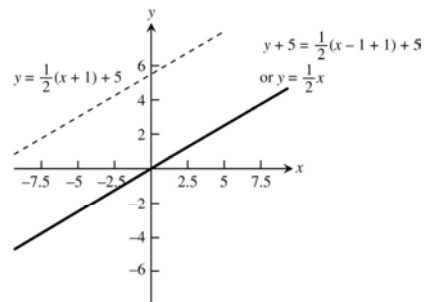

33.

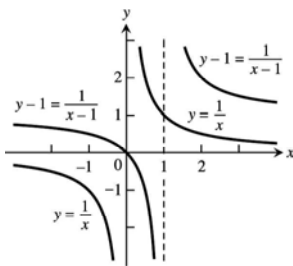

34.

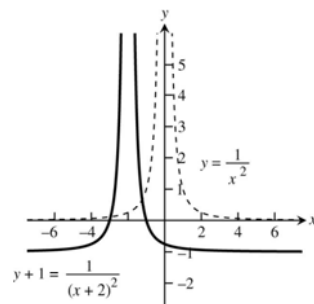

12 Chapter 1 Functions

35.

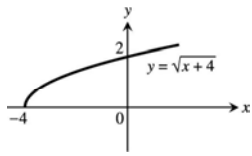

36.

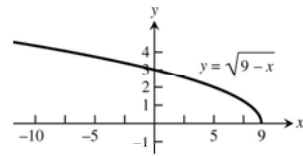

37.

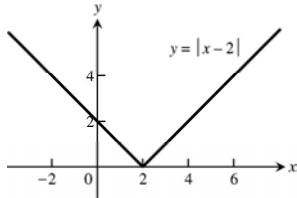

38.

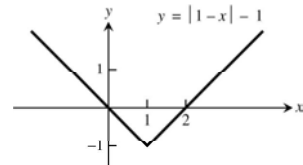

39.

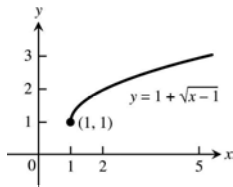

40.

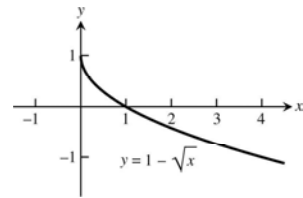

41.

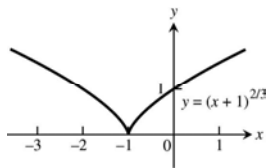

42.

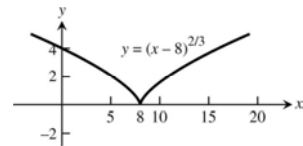

43.

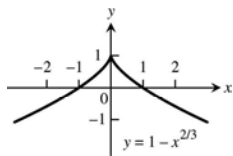

44.

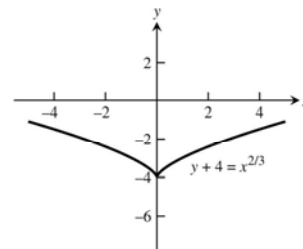

45.

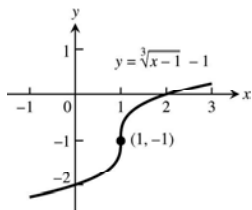

46.

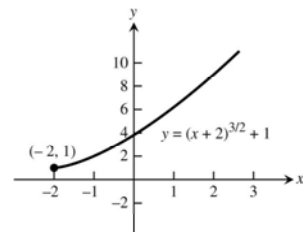

47.

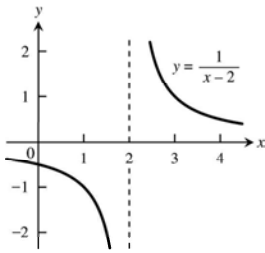

48.

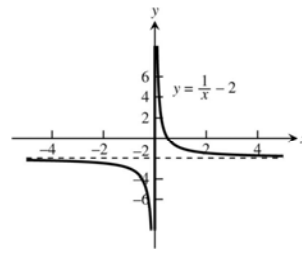

49.

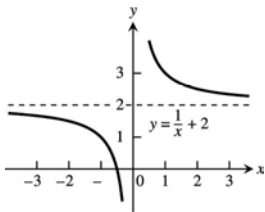

50.

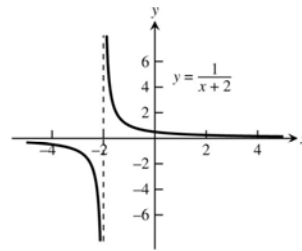

51.

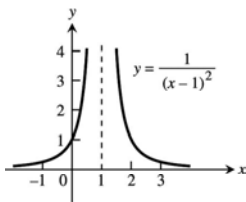

52.

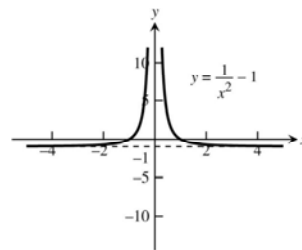

53.

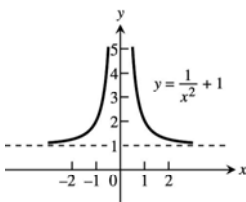

54.

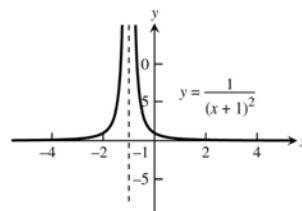

55. (a) domain: $[0, 2]$; range: $[2, 3]$

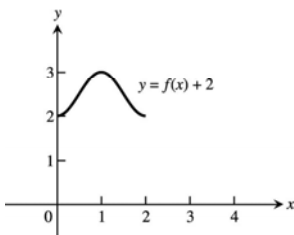

(b) domain: $[0, 2]$; range: $[-1, 0]$

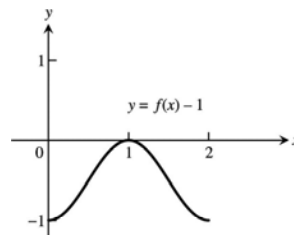

(c) domain: $[0, 2]$; range: $[0, 2]$

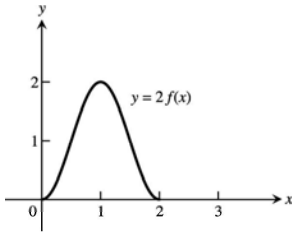

(d) domain: $[0, 2]$; range: $[-1, 0]$

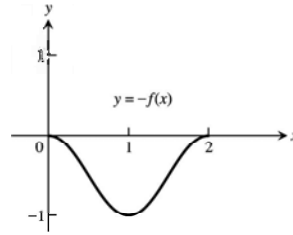

(e) domain: $[-2, 0]$; range: $[0, 1]$

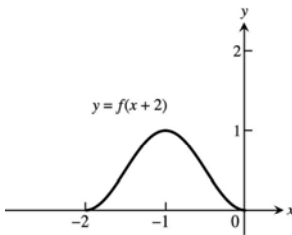

(f) domain: $[1, 3]$; range: $[0, 1]$

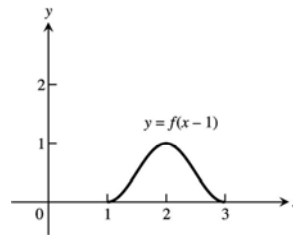

(g) domain: $[-2, 0]$; range: $[0, 1]$

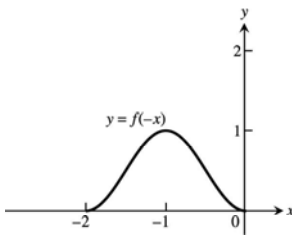

(h) domain: $[-1, 1]$; range: $[0, 1]$

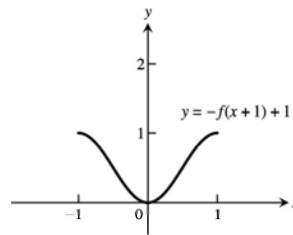

56. (a) domain: $[0, 4]$; range: $[-3, 0]$

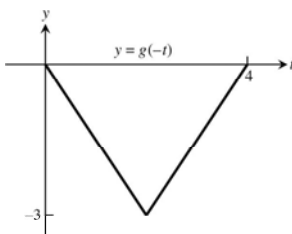

(b) domain: $[-4, 0]$; range: $[0, 3]$

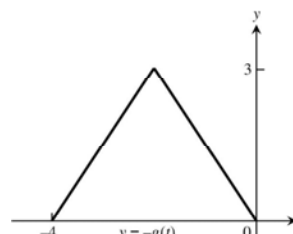

(c) domain: $[-4, 0]$; range: $[0, 3]$

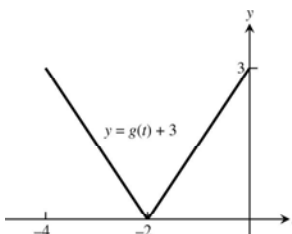

(d) domain: $[-4, 0]$; range: $[1, 4]$

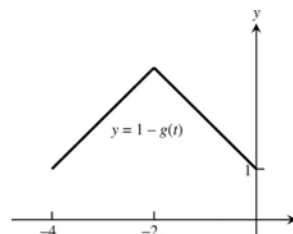

(e) domain: $[2, 4]$; range: $[-3, 0]$

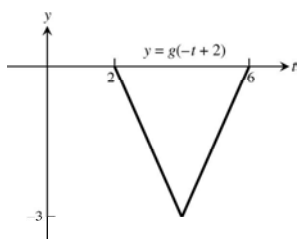

(f) domain: $[-2, 2]$; range: $[-3, 0]$

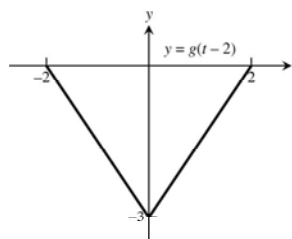

(g) domain: $[1, 5]$; range: $[-3, 0]$

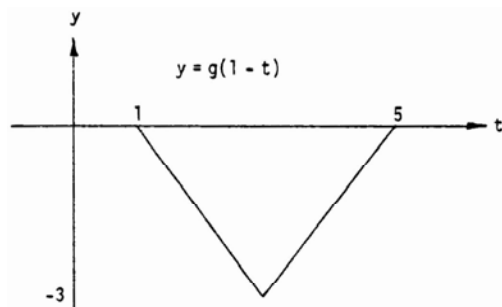

(h) domain: $[0, 4]$; range: $[0, 3]$

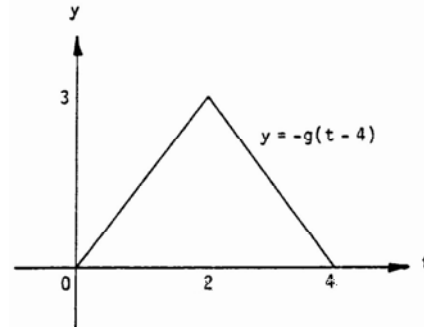

57. $y = 3x^2 - 3$

58. $y = (2x)^2 - 1 = 4x^2 - 1$

59. $y = \frac{1}{2} \left(1 + \frac{1}{x^2} \right) = \frac{1}{2} + \frac{1}{2x^2}$

60. $y = 1 + \frac{1}{(x/3)^2} = 1 + \frac{9}{x^2}$

61. $y = \sqrt{4x+1}$

62. $y = 3\sqrt{x+1}$

63. $y = \sqrt{4 - \left(\frac{x}{2}\right)^2} = \frac{1}{2} \sqrt{16 - x^2}$

64. $y = \frac{1}{3} \sqrt{4 - x^2}$

65. $y = 1 - (3x)^3 = 1 - 27x^3$

66. $y = 1 - \left(\frac{x}{2}\right)^3 = 1 - \frac{x^3}{8}$

67. Let $y = -\sqrt{2x+1} = f(x)$ and let $g(x) = x^{1/2}$, $h(x) = \left(x + \frac{1}{2}\right)^{1/2}$, $i(x) = \sqrt{2} \left(x + \frac{1}{2}\right)^{1/2}$, and $j(x) = -\left[\sqrt{2} \left(x + \frac{1}{2}\right)^{1/2}\right] = f(x)$. The graph of $h(x)$

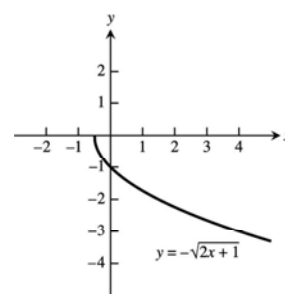

is the graph of $g(x)$ shifted left $\frac{1}{2}$ unit; the graph of $i(x)$ is the graph of $h(x)$ stretched vertically by a factor of $\sqrt{2}$; and the graph of $j(x) = f(x)$ is the graph of $i(x)$ reflected across the x -axis.

68. Let $y = \sqrt{1 - \frac{x}{2}} = f(x)$. Let $g(x) = (-x)^{1/2}$, $h(x) = (-x + 2)^{1/2}$, and $i(x) = \frac{1}{\sqrt{2}} (-x + 2)^{1/2} = \sqrt{1 - \frac{x}{2}} = f(x)$. The graph of $g(x)$ is the graph of $y = \sqrt{x}$ reflected across the x -axis. The graph of $h(x)$ is the graph of $g(x)$ shifted right two units. And the graph of $i(x)$ is the graph of $h(x)$ compressed vertically by a factor of $\sqrt{2}$.

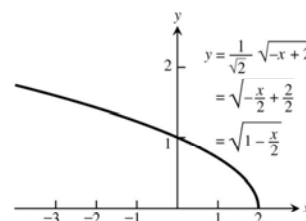

69. $y = f(x) = x^3$. Shift $f(x)$ one unit right followed by a shift two units up to get $g(x) = (x-1)^3 + 2$.

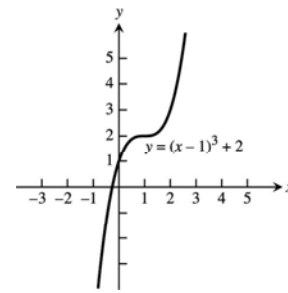

70. $y = (1-x)^3 + 2 = -[(x-1)^3 + (-2)] = f(x)$.
 Let $g(x) = x^3$, $h(x) = (x-1)^3$, $i(x) = (x-1)^3 + (-2)$,
 and $j(x) = -[(x-1)^3 + (-2)]$. The graph of $h(x)$ is the
 graph of $g(x)$ shifted right one unit; the graph of $i(x)$
 is the graph of $h(x)$ shifted down two units; and the
 graph of $f(x)$ is the graph of $i(x)$ reflected across
 the x -axis.

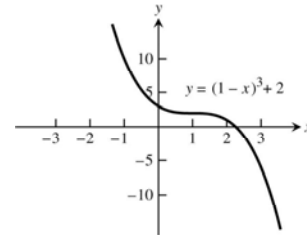

71. Compress the graph of $f(x) = \frac{1}{x}$ horizontally by a
 factor of 2 to get $g(x) = \frac{1}{2x}$. Then shift $g(x)$
 vertically down 1 unit to get $h(x) = \frac{1}{2x} - 1$.

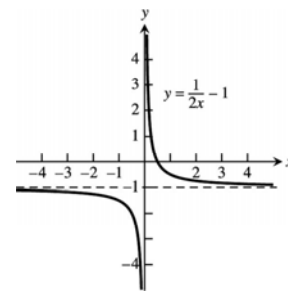

72. Let $f(x) = \frac{1}{x^2}$ and $g(x) = \frac{2}{x^2} + 1 = \frac{1}{\left(\frac{x}{\sqrt{2}}\right)^2} + 1$
 $= \frac{1}{\left(\frac{x}{1.4}\right)^2} + 1 = \frac{1}{\left[\left(\frac{1}{1.4}\right)x\right]^2} + 1$. Since $\sqrt{2} \approx 1.4$, we see
 that the graph of $f(x)$ stretched horizontally by
 a factor of 1.4 and shifted up 1 unit is the graph
 of $g(x)$.

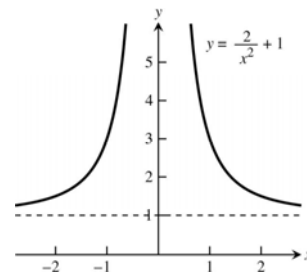

73. Reflect the graph of $y = f(x) = \sqrt[3]{x}$ across the x -axis
 to get $g(x) = -\sqrt[3]{x}$.

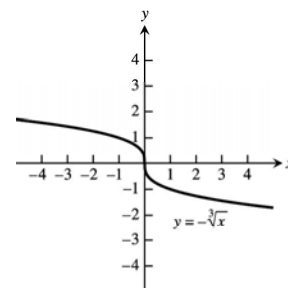

74. $y = f(x) = (-2x)^{2/3} = [(-1)(2x)]^{2/3} = (-1)^{2/3}(2x)^{2/3} = (2x)^{2/3}$. So the graph of $f(x)$ is the graph of $g(x) = x^{2/3}$ compressed horizontally by a factor of 2.

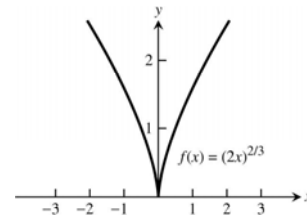

75.

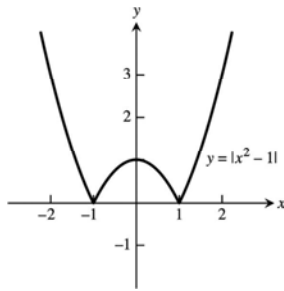

76.

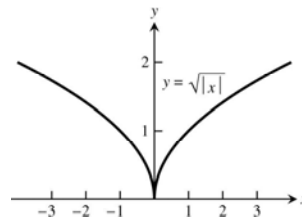

77. (a) $(fg)(-x) = f(-x)g(-x) = f(x)(-g(x)) = -(fg)(x)$, odd
 (b) $\left(\frac{f}{g}\right)(-x) = \frac{f(-x)}{g(-x)} = \frac{f(x)}{-g(x)} = -\left(\frac{f}{g}\right)(x)$, odd
 (c) $\left(\frac{g}{f}\right)(-x) = \frac{g(-x)}{f(-x)} = \frac{-g(x)}{f(x)} = -\left(\frac{g}{f}\right)(x)$, odd
 (d) $f^2(-x) = f(-x)f(-x) = f(x)f(x) = f^2(x)$, even
 (e) $g^2(-x) = (g(-x))^2 = (-g(x))^2 = g^2(x)$, even
 (f) $(f \circ g)(-x) = f(g(-x)) = f(-g(x)) = f(g(x)) = (f \circ g)(x)$, even
 (g) $(g \circ f)(-x) = g(f(-x)) = g(f(x)) = (g \circ f)(x)$, even
 (h) $(f \circ f)(-x) = f(f(-x)) = f(f(x)) = (f \circ f)(x)$, even
 (i) $(g \circ g)(-x) = g(g(-x)) = g(-g(x)) = -g(g(x)) = -(g \circ g)(x)$, odd
78. Yes, $f(x) = 0$ is both even and odd since $f(-x) = 0 = f(x)$ and $f(-x) = 0 = -f(x)$.

79. (a)

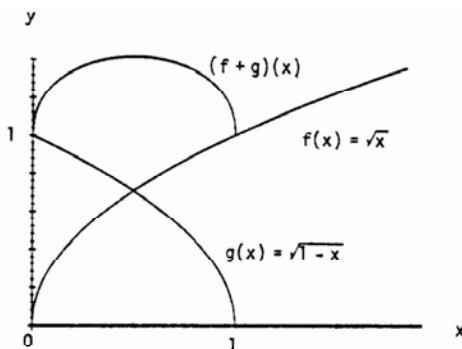

(b)

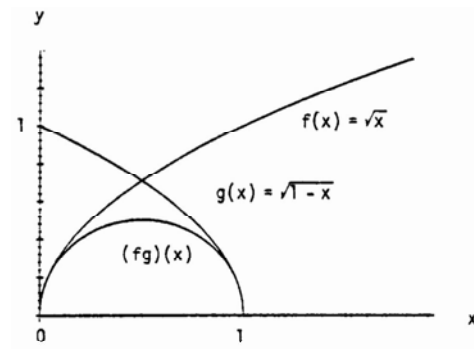

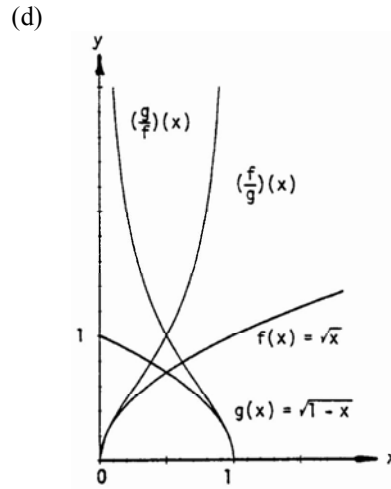
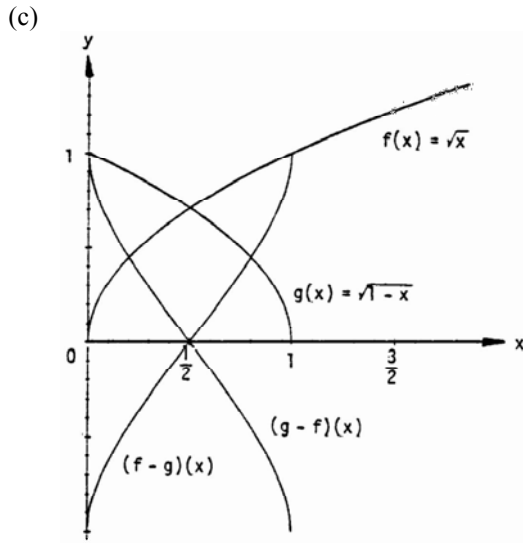

80.

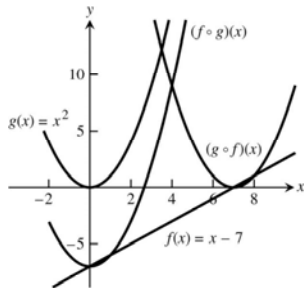

1.3 TRIGONOMETRIC FUNCTIONS

- (a) $s = r\theta = (10)\left(\frac{4\pi}{5}\right) = 8\pi m$

(b) $s = r\theta = (10)(110^\circ)\left(\frac{\pi}{180^\circ}\right) = \frac{110\pi}{18} = \frac{55\pi}{9} m$
- $\theta = \frac{s}{r} = \frac{10\pi}{8} = \frac{5\pi}{4}$ radians and $\frac{5\pi}{4}\left(\frac{180^\circ}{\pi}\right) = 225^\circ$
- $\theta = 80^\circ \Rightarrow \theta = 80^\circ\left(\frac{\pi}{180^\circ}\right) = \frac{4\pi}{9} \Rightarrow s = (6)\left(\frac{4\pi}{9}\right) = 8.4$ in. (since the diameter = 12 in. \Rightarrow radius = 6 in.)
- $d = 1$ meter $\Rightarrow r = 50$ cm $\Rightarrow \theta = \frac{s}{r} = \frac{30}{50} = 0.6$ rad or $0.6\left(\frac{180^\circ}{\pi}\right) \approx 34^\circ$

5.

θ	$-\pi$	$-\frac{2\pi}{3}$	0	$\frac{\pi}{2}$	$\frac{3\pi}{4}$
$\sin \theta$	0	$-\frac{\sqrt{3}}{2}$	0	1	$\frac{1}{\sqrt{2}}$
$\cos \theta$	-1	$-\frac{1}{2}$	1	0	$-\frac{1}{\sqrt{2}}$
$\tan \theta$	0	$\sqrt{3}$	0	und.	-1
$\cot \theta$	und.	$\frac{1}{\sqrt{3}}$	und.	0	-1
$\sec \theta$	-1	-2	1	und.	$-\sqrt{2}$
$\csc \theta$	und.	$-\frac{2}{\sqrt{3}}$	und.	1	$\sqrt{2}$

6.

θ	$-\frac{3\pi}{2}$	$-\frac{\pi}{3}$	$-\frac{\pi}{6}$	$\frac{\pi}{4}$	$\frac{5\pi}{6}$
$\sin \theta$	1	$-\frac{\sqrt{3}}{2}$	$-\frac{1}{2}$	$\frac{1}{\sqrt{2}}$	$\frac{1}{2}$
$\cos \theta$	0	$\frac{1}{2}$	$\frac{\sqrt{3}}{2}$	$\frac{1}{\sqrt{2}}$	$-\frac{\sqrt{3}}{2}$
$\tan \theta$	und.	$-\sqrt{3}$	$-\frac{1}{\sqrt{3}}$	1	$-\frac{1}{\sqrt{3}}$
$\cot \theta$	0	$-\frac{1}{\sqrt{3}}$	$-\sqrt{3}$	1	$-\sqrt{3}$
$\sec \theta$	und.	2	$\frac{2}{\sqrt{3}}$	$\sqrt{2}$	$-\frac{2}{\sqrt{3}}$
$\csc \theta$	1	$-\frac{2}{\sqrt{3}}$	-2	$\sqrt{2}$	2

7. $\cos x = -\frac{4}{5}, \tan x = -\frac{3}{4}$

9. $\sin x = -\frac{\sqrt{8}}{3}, \tan x = -\sqrt{8}$

11. $\sin x = -\frac{1}{\sqrt{5}}, \cos x = -\frac{2}{\sqrt{5}}$

13.

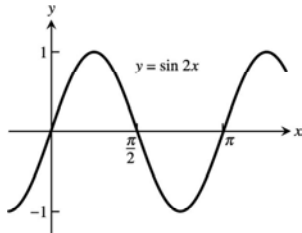

period = π

15.

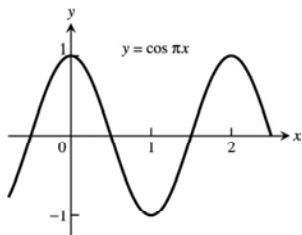

period = 2

17.

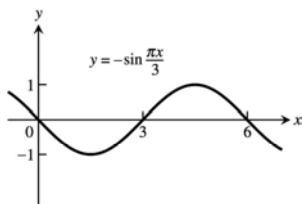

period = 6

19.

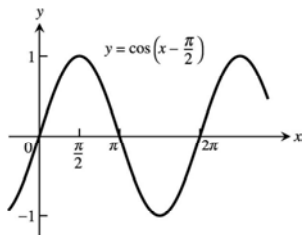

period = 2π

8. $\sin x = \frac{2}{\sqrt{5}}, \cos x = \frac{1}{\sqrt{5}}$

10. $\sin x = \frac{12}{13}, \tan x = -\frac{12}{5}$

12. $\cos x = -\frac{\sqrt{3}}{2}, \tan x = \frac{1}{\sqrt{3}}$

14.

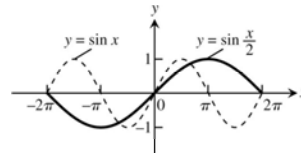

period = 4π

16.

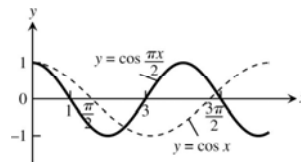

period = 4

18.

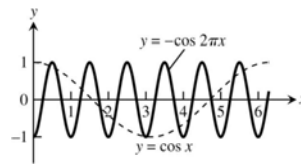

period = 1

20.

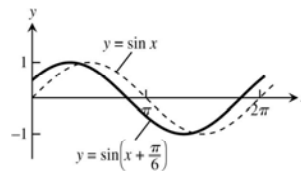

period = 2π

21.

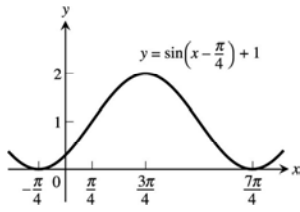

period = 2π

22.

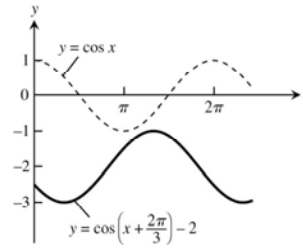

period = 2π

23. period = $\frac{\pi}{2}$, symmetric about the origin

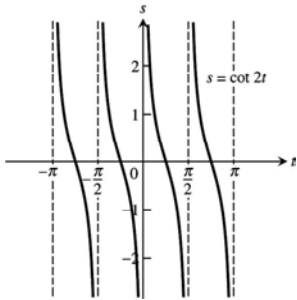

24. period = 1, symmetric about the origin

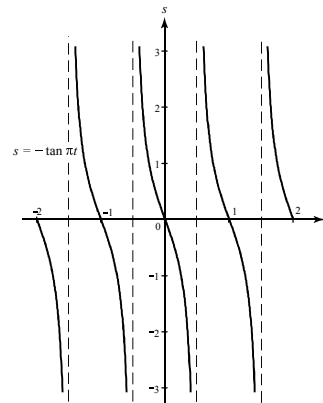

25. period = 4, symmetric about the s -axis

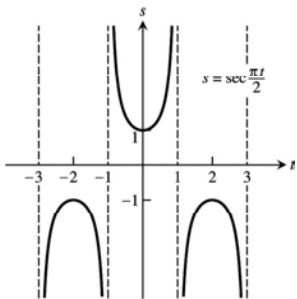

26. period = 4π , symmetric about the origin

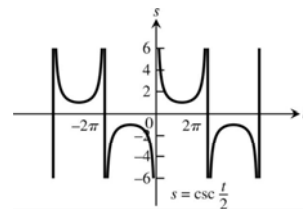

27. (a) $\cos x$ and $\sec x$ are positive for x in the interval $(-\frac{\pi}{2}, \frac{\pi}{2})$; and $\cos x$ and $\sec x$ are negative for x in the intervals $(-\frac{3\pi}{2}, -\frac{\pi}{2})$ and $(\frac{\pi}{2}, \frac{3\pi}{2})$. $\sec x$ is undefined when $\cos x$ is 0. The range of $\sec x$ is $(-\infty, -1] \cup [1, \infty)$; the range of $\cos x$ is $[-1, 1]$.

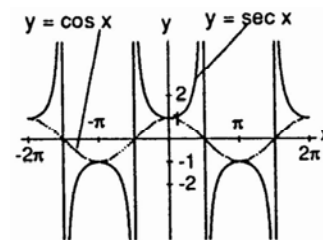

- (b) $\sin x$ and $\csc x$ are positive for x in the intervals $(-\frac{3\pi}{2}, -\pi)$ and $(0, \pi)$; and $\sin x$ and $\csc x$ are negative for x in the intervals $(-\pi, 0)$ and $(\pi, \frac{3\pi}{2})$. $\csc x$ is undefined when $\sin x$ is 0. The range of $\csc x$ is $(-\infty, -1] \cup [1, \infty)$; the range of $\sin x$ is $[-1, 1]$.

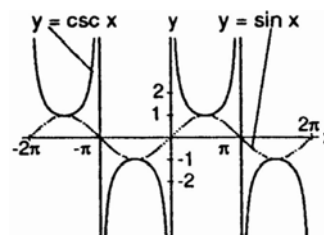

28. Since $\cot x = \frac{1}{\tan x}$, $\cot x$ is undefined when $\tan x = 0$ and is zero when $\tan x$ is undefined. As $\tan x$ approaches zero through positive values, $\cot x$ approaches infinity. Also, $\cot x$ approaches negative infinity as $\tan x$ approaches zero through negative values.

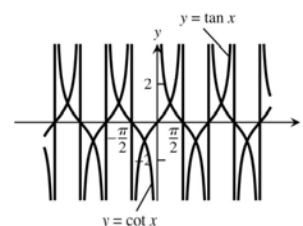

29. $D: -\infty < x < \infty$; $R: y = -1, 0, 1$

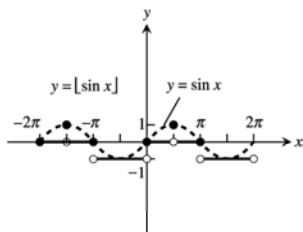

30. $D: -\infty < x < \infty$; $R: y = -1, 0, 1$

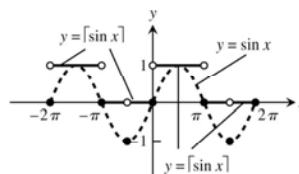

$$31. \cos\left(x - \frac{\pi}{2}\right) = \cos x \cos\left(-\frac{\pi}{2}\right) - \sin x \sin\left(-\frac{\pi}{2}\right) = (\cos x)(0) - (\sin x)(-1) = \sin x$$

$$32. \cos\left(x + \frac{\pi}{2}\right) = \cos x \cos\left(\frac{\pi}{2}\right) - \sin x \sin\left(\frac{\pi}{2}\right) = (\cos x)(0) - (\sin x)(1) = -\sin x$$

$$33. \sin\left(x + \frac{\pi}{2}\right) = \sin x \cos\left(\frac{\pi}{2}\right) + \cos x \sin\left(\frac{\pi}{2}\right) = (\sin x)(0) + (\cos x)(1) = \cos x$$

$$34. \sin\left(x - \frac{\pi}{2}\right) = \sin x \cos\left(-\frac{\pi}{2}\right) + \cos x \sin\left(-\frac{\pi}{2}\right) = (\sin x)(0) + (\cos x)(-1) = -\cos x$$

$$35. \cos(A - B) = \cos(A + (-B)) = \cos A \cos(-B) - \sin A \sin(-B) = \cos A \cos B - \sin A(-\sin B) \\ = \cos A \cos B + \sin A \sin B$$

$$36. \sin(A - B) = \sin(A + (-B)) = \sin A \cos(-B) + \cos A \sin(-B) = \sin A \cos B + \cos A(-\sin B) \\ = \sin A \cos B - \cos A \sin B$$

$$37. \text{ If } B = A, A - B = 0 \Rightarrow \cos(A - B) = \cos 0 = 1. \text{ Also } \cos(A - B) = \cos(A - A) = \cos A \cos A + \sin A \sin A \\ = \cos^2 A + \sin^2 A. \text{ Therefore, } \cos^2 A + \sin^2 A = 1.$$

$$38. \text{ If } B = 2\pi, \text{ then } \cos(A + 2\pi) = \cos A \cos 2\pi - \sin A \sin 2\pi = (\cos A)(1) - (\sin A)(0) = \cos A \text{ and} \\ \sin(A + 2\pi) = \sin A \cos 2\pi + \cos A \sin 2\pi = (\sin A)(1) + (\cos A)(0) = \sin A. \text{ The result agrees with the fact that the} \\ \text{cosine and sine functions have period } 2\pi.$$

$$39. \cos(\pi + x) = \cos \pi \cos x - \sin \pi \sin x = (-1)(\cos x) - (0)(\sin x) = -\cos x$$

40. $\sin(2\pi - x) = \sin 2\pi \cos(-x) + \cos(2\pi) \sin(-x) = (0)(\cos(-x)) + (1)(\sin(-x)) = -\sin x$

41. $\sin\left(\frac{3\pi}{2} - x\right) = \sin\left(\frac{3\pi}{2}\right)\cos(-x) + \cos\left(\frac{3\pi}{2}\right)\sin(-x) = (-1)(\cos x) + (0)(\sin(-x)) = -\cos x$

42. $\cos\left(\frac{3\pi}{2} + x\right) = \cos\left(\frac{3\pi}{2}\right)\cos x - \sin\left(\frac{3\pi}{2}\right)\sin x = (0)(\cos x) - (-1)(\sin x) = \sin x$

43. $\sin\frac{7\pi}{12} = \sin\left(\frac{\pi}{4} + \frac{\pi}{3}\right) = \sin\frac{\pi}{4}\cos\frac{\pi}{3} + \cos\frac{\pi}{4}\sin\frac{\pi}{3} = \left(\frac{\sqrt{2}}{2}\right)\left(\frac{1}{2}\right) + \left(\frac{\sqrt{2}}{2}\right)\left(\frac{\sqrt{3}}{2}\right) = \frac{\sqrt{6} + \sqrt{2}}{4}$

44. $\cos\frac{11\pi}{12} = \cos\left(\frac{\pi}{4} + \frac{2\pi}{3}\right) = \cos\frac{\pi}{4}\cos\frac{2\pi}{3} - \sin\frac{\pi}{4}\sin\frac{2\pi}{3} = \left(\frac{\sqrt{2}}{2}\right)\left(-\frac{1}{2}\right) - \left(\frac{\sqrt{2}}{2}\right)\left(\frac{\sqrt{3}}{2}\right) = -\frac{\sqrt{2} + \sqrt{6}}{4}$

45. $\cos\frac{\pi}{12} = \cos\left(\frac{\pi}{3} - \frac{\pi}{4}\right) = \cos\frac{\pi}{3}\cos\left(-\frac{\pi}{4}\right) - \sin\frac{\pi}{3}\sin\left(-\frac{\pi}{4}\right) = \left(\frac{1}{2}\right)\left(\frac{\sqrt{2}}{2}\right) - \left(\frac{\sqrt{3}}{2}\right)\left(-\frac{\sqrt{2}}{2}\right) = \frac{1 + \sqrt{3}}{2\sqrt{2}}$

46. $\sin\frac{5\pi}{12} = \sin\left(\frac{2\pi}{3} - \frac{\pi}{4}\right) = \sin\left(\frac{2\pi}{3}\right)\cos\left(-\frac{\pi}{4}\right) + \cos\left(\frac{2\pi}{3}\right)\sin\left(-\frac{\pi}{4}\right) = \left(\frac{\sqrt{3}}{2}\right)\left(\frac{\sqrt{2}}{2}\right) + \left(-\frac{1}{2}\right)\left(-\frac{\sqrt{2}}{2}\right) = \frac{1 + \sqrt{3}}{2\sqrt{2}}$

47. $\cos^2\frac{\pi}{8} = \frac{1 + \cos\left(\frac{2\pi}{8}\right)}{2} = \frac{1 + \frac{\sqrt{2}}{2}}{2} = \frac{2 + \sqrt{2}}{4}$

48. $\cos^2\frac{5\pi}{12} = \frac{1 + \cos\left(\frac{10\pi}{12}\right)}{2} = \frac{1 + \left(-\frac{\sqrt{3}}{2}\right)}{2} = \frac{2 - \sqrt{3}}{4}$

49. $\sin^2\frac{\pi}{12} = \frac{1 - \cos\left(\frac{2\pi}{12}\right)}{2} = \frac{1 - \frac{\sqrt{3}}{2}}{2} = \frac{2 - \sqrt{3}}{4}$

50. $\sin^2\frac{3\pi}{8} = \frac{1 - \cos\left(\frac{6\pi}{8}\right)}{2} = \frac{1 - \left(-\frac{\sqrt{2}}{2}\right)}{2} = \frac{2 + \sqrt{2}}{4}$

51. $\sin^2\theta = \frac{3}{4} \Rightarrow \sin\theta = \pm\frac{\sqrt{3}}{2} \Rightarrow \theta = \frac{\pi}{3}, \frac{2\pi}{3}, \frac{4\pi}{3}, \frac{5\pi}{3}$

52. $\sin^2\theta = \cos^2\theta \Rightarrow \frac{\sin^2\theta}{\cos^2\theta} = \frac{\cos^2\theta}{\cos^2\theta} \Rightarrow \tan^2\theta = 1 \Rightarrow \tan\theta = \pm 1 \Rightarrow \theta = \frac{\pi}{4}, \frac{3\pi}{4}, \frac{5\pi}{4}, \frac{7\pi}{4}$

53. $\sin 2\theta - \cos\theta = 0 \Rightarrow 2\sin\theta\cos\theta - \cos\theta = 0 \Rightarrow \cos\theta(2\sin\theta - 1) = 0 \Rightarrow \cos\theta = 0$ or $2\sin\theta - 1 = 0$
 $\Rightarrow \cos\theta = 0$ or $\sin\theta = \frac{1}{2} \Rightarrow \theta = \frac{\pi}{2}, \frac{3\pi}{2}$, or $\theta = \frac{\pi}{6}, \frac{5\pi}{6} \Rightarrow \theta = \frac{\pi}{6}, \frac{\pi}{2}, \frac{5\pi}{6}, \frac{3\pi}{2}$

54. $\cos 2\theta + \cos\theta = 0 \Rightarrow 2\cos^2\theta - 1 + \cos\theta = 0 \Rightarrow 2\cos^2\theta + \cos\theta - 1 = 0 \Rightarrow (\cos\theta + 1)(2\cos\theta - 1) = 0$
 $\Rightarrow \cos\theta + 1 = 0$ or $2\cos\theta - 1 = 0 \Rightarrow \cos\theta = -1$ or $\cos\theta = \frac{1}{2} \Rightarrow \theta = \pi$ or $\theta = \frac{\pi}{3}, \frac{5\pi}{3} \Rightarrow \theta = \frac{\pi}{3}, \pi, \frac{5\pi}{3}$

55. $\tan(A + B) = \frac{\sin(A + B)}{\cos(A + B)} = \frac{\sin A \cos B + \cos A \sin B}{\cos A \cos B - \sin A \sin B} = \frac{\frac{\sin A \cos B}{\cos A \cos B} + \frac{\cos A \sin B}{\cos A \cos B}}{\frac{\cos A \cos B}{\cos A \cos B} - \frac{\sin A \sin B}{\cos A \cos B}} = \frac{\tan A + \tan B}{1 - \tan A \tan B}$

56. $\tan(A - B) = \frac{\sin(A - B)}{\cos(A - B)} = \frac{\sin A \cos B - \cos A \sin B}{\cos A \cos B + \sin A \sin B} = \frac{\frac{\sin A \cos B}{\cos A \cos B} - \frac{\cos A \sin B}{\cos A \cos B}}{\frac{\cos A \cos B}{\cos A \cos B} + \frac{\sin A \sin B}{\cos A \cos B}} = \frac{\tan A - \tan B}{1 + \tan A \tan B}$

57. According to the figure in the text, we have the following: By the law of cosines, $c^2 = a^2 + b^2 - 2ab \cos\theta$
 $= 1^2 + 1^2 - 2\cos(A - B) = 2 - 2\cos(A - B)$. By distance formula, $c^2 = (\cos A - \cos B)^2 + (\sin A - \sin B)^2$
 $= \cos^2 A - 2\cos A \cos B + \cos^2 B + \sin^2 A - 2\sin A \sin B + \sin^2 B = 2 - 2(\cos A \cos B + \sin A \sin B)$. Thus
 $c^2 = 2 - 2\cos(A - B) = 2 - 2(\cos A \cos B + \sin A \sin B) \Rightarrow \cos(A - B) = \cos A \cos B + \sin A \sin B$.

58. (a) $\cos(A - B) = \cos A \cos B + \sin A \sin B$
 $\sin \theta = \cos\left(\frac{\pi}{2} - \theta\right)$ and $\cos \theta = \sin\left(\frac{\pi}{2} - \theta\right)$
 Let $\theta = A + B$
 $\sin(A + B) = \cos\left[\frac{\pi}{2} - (A + B)\right] = \cos\left[\left(\frac{\pi}{2} - A\right) - B\right] = \cos\left(\frac{\pi}{2} - A\right) \cos B + \sin\left(\frac{\pi}{2} - A\right) \sin B$
 $= \sin A \cos B + \cos A \sin B$
- (b) $\cos(A - B) = \cos A \cos B + \sin A \sin B$
 $\cos(A - (-B)) = \cos A \cos(-B) + \sin A \sin(-B)$
 $\Rightarrow \cos(A + B) = \cos A \cos(-B) + \sin A \sin(-B) = \cos A \cos B + \sin A(-\sin B) = \cos A \cos B - \sin A \sin B$
 Because the cosine function is even and the sine functions is odd.

59. $c^2 = a^2 + b^2 - 2ab \cos C = 2^2 + 3^2 - 2(2)(3) \cos(60^\circ) = 4 + 9 - 12 \cos(60^\circ) = 13 - 12\left(\frac{1}{2}\right) = 7$.
 Thus, $c = \sqrt{7} \approx 2.65$.

60. $c^2 = a^2 + b^2 - 2ab \cos C = 2^2 + 3^2 - 2(2)(3) \cos(40^\circ) = 13 - 12 \cos(40^\circ)$. Thus, $c = \sqrt{13 - 12 \cos 40^\circ} \approx 1.951$.

61. From the figures in the text, we see that $\sin B = \frac{h}{c}$. If C is an acute angle, then $\sin C = \frac{h}{b}$. On the other hand, if C is obtuse (as in the figure on the right in the text), then $\sin C = \sin(\pi - C) = \frac{h}{b}$. Thus, in either case,
 $h = b \sin C = c \sin B \Rightarrow ah = ab \sin C = ac \sin B$.

By the law of cosines, $\cos C = \frac{a^2 + b^2 - c^2}{2ab}$ and $\cos B = \frac{a^2 + c^2 - b^2}{2ac}$. Moreover, since the sum of the interior angles of triangle is π , we have $\sin A = \sin(\pi - (B + C)) = \sin(B + C) = \sin B \cos C + \cos B \sin C$
 $= \left(\frac{h}{c}\right) \left[\frac{a^2 + b^2 - c^2}{2ab}\right] + \left[\frac{a^2 + c^2 - b^2}{2ac}\right] \left(\frac{h}{b}\right) = \left(\frac{h}{2abc}\right)(2a^2 + b^2 - c^2 + c^2 - b^2) = \frac{ah}{bc} \Rightarrow ah = bc \sin A$.

Combining our results we have $ah = ab \sin C$, $ah = ac \sin B$, and $ah = bc \sin A$. Dividing by abc gives
 $\frac{h}{bc} = \frac{\sin A}{a} = \frac{\sin C}{c} = \frac{\sin B}{b}$.
 law of sines

62. By the law of sines, $\frac{\sin A}{2} = \frac{\sin B}{3} = \frac{\sqrt{3}/2}{c}$. By Exercise 59 we know that $c = \sqrt{7}$. Thus $\sin B = \frac{3\sqrt{3}}{2\sqrt{7}} \approx 0.982$.

63. From the figure at the right and the law of cosines,
 $b^2 = a^2 + 2^2 - 2(2a) \cos B$
 $= a^2 + 4 - 4a\left(\frac{1}{2}\right) = a^2 - 2a + 4$.

Applying the law of sines to the figure, $\frac{\sin A}{a} = \frac{\sin B}{b}$
 $\Rightarrow \frac{\sqrt{2}/2}{a} = \frac{\sqrt{3}/2}{b} \Rightarrow b = \sqrt{\frac{3}{2}} a$. Thus, combining results,

$a^2 - 2a + 4 = b^2 = \frac{3}{2}a^2 \Rightarrow 0 = \frac{1}{2}a^2 + 2a - 4 \Rightarrow 0 = a^2 + 4a - 8$. From the quadratic formula and the fact that $a > 0$, we have $a = \frac{-4 + \sqrt{4^2 - 4(1)(-8)}}{2} = \frac{4\sqrt{3} - 4}{2} \approx 1.464$.

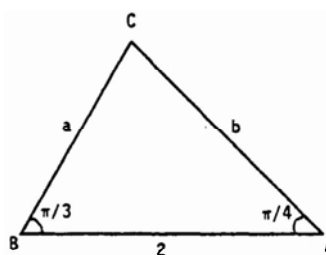

64. (a) The graphs of $y = \sin x$ and $y = x$ nearly coincide when x is near the origin (when the calculator is in radians mode).
 (b) In degree mode, when x is near zero degrees the sine of x is much closer to zero than x itself. The curves look like intersecting straight lines near the origin when the calculator is in degree mode.

65. $A = 2, B = 2\pi, C = -\pi, D = -1$

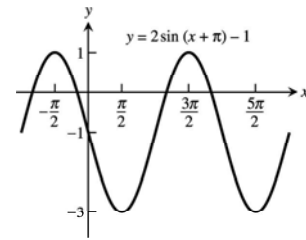

66. $A = \frac{1}{2}, B = 2, C = 1, D = \frac{1}{2}$

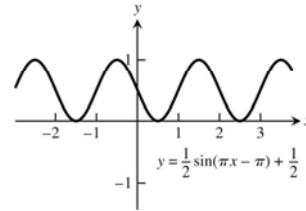

67. $A = -\frac{2}{\pi}, B = 4, C = 0, D = \frac{1}{\pi}$

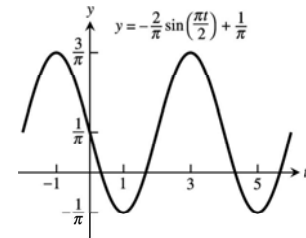

68. $A = \frac{L}{2\pi}, B = L, C = 0, D = 0$

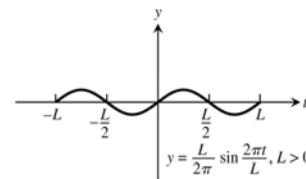

69–72. Example CAS commands:

Maple:

```
f := x -> A*sin((2*Pi/B)*(x-C))+D1;
A:=3; C:=0; D1:=0;
f_list := [seq(f(x), B=[1,3,2*Pi,5*Pi])];
plot(f_list, x=-4*Pi..4*Pi, scaling=constrained,
     color=[red,blue,green,cyan], linestyle=[1,3,4,7],
     legend=["B=1", "B=3", "B=2*Pi", "B=3*Pi"],
     title="#69 (Section 1.3)");
```

Mathematica:

```
Clear[a, b, c, d, f, x]
f[x_]:=a Sin[2π/b (x - c)] + d
Plot[f[x]/. {a -> 3, b -> 1, c -> 0, d -> 0}, {x, -4π, 4π}]
```

69. (a) The graph stretches horizontally.

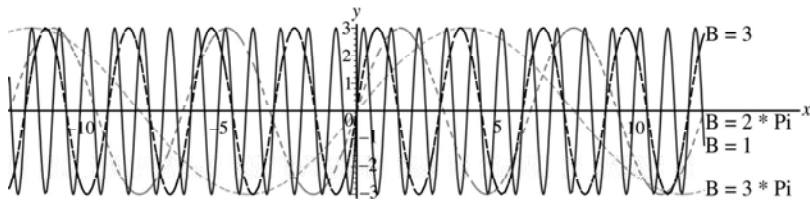

(b) The period remains the same: period = $|B|$. The graph has a horizontal shift of $\frac{1}{2}$ period.

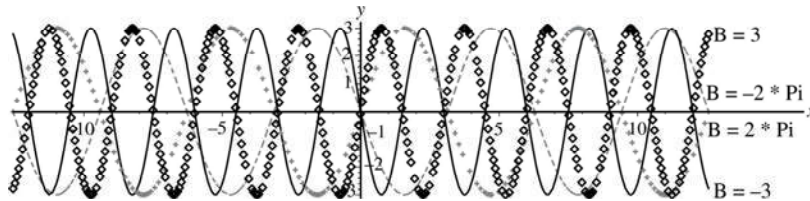

70. (a) The graph is shifted right C units.

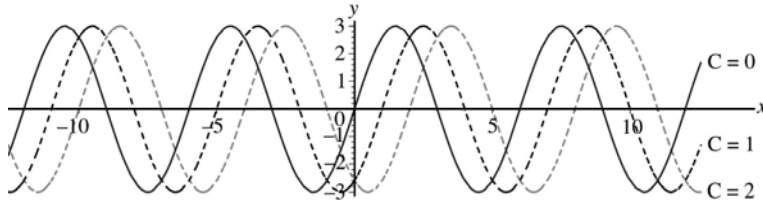

(b) The graph is shifted left C units.
 (c) A shift of \pm one period will produce no apparent shift. $|C| = 6$

71. (a) The graph shifts upwards $|D|$ units for $D > 0$
 (b) The graph shifts down $|D|$ units for $D < 0$.

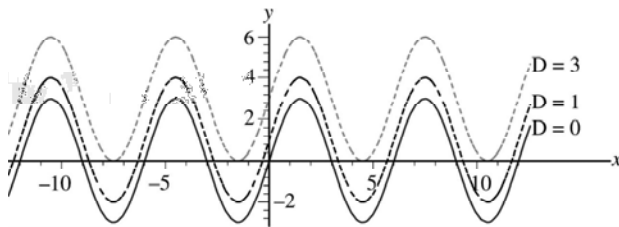

72. (a) The graph stretches $|A|$ units. (b) For $A < 0$, the graph is inverted.

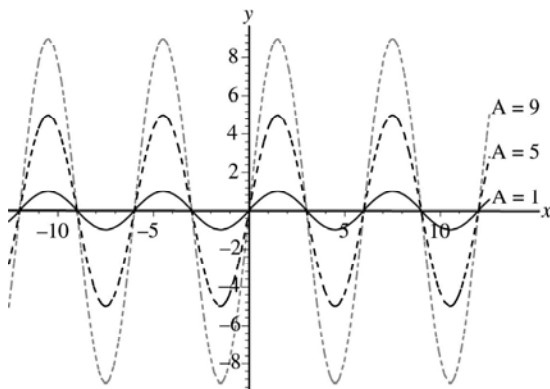

1.4 GRAPHING WITH SOFTWARE

1–4. The most appropriate viewing window displays the maxima, minima, intercepts, and end behavior of the graphs and has little unused space.

1. d.

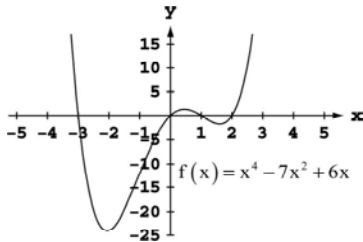

2. c.

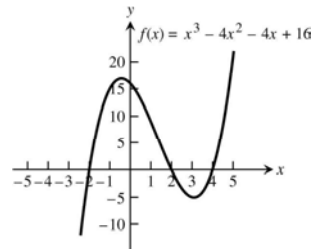

3. d.

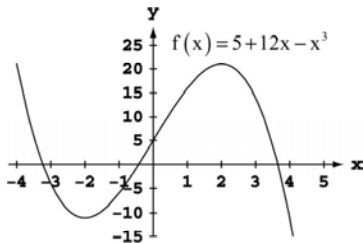

4. b.

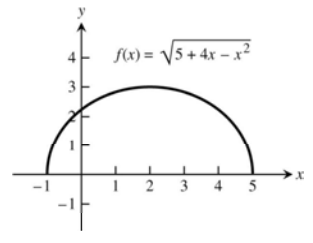

5–30. For any display there are many appropriate display widows. The graphs given as answers in Exercises 5–30 are not unique in appearance.

5. $[-2, 5]$ by $[-15, 40]$

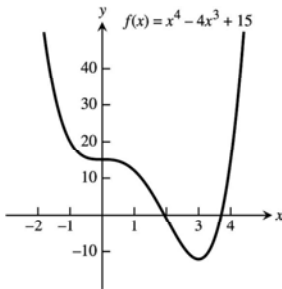

6. $[-4, 4]$ by $[-4, 4]$

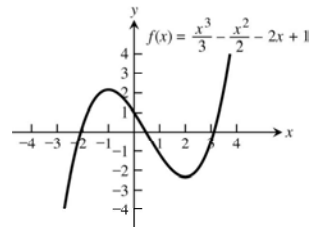

7. $[-2, 6]$ by $[-250, 50]$

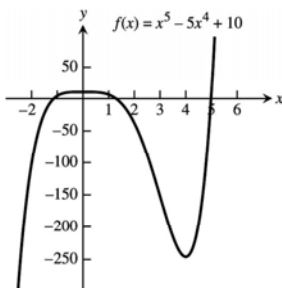

8. $[-1, 5]$ by $[-5, 30]$

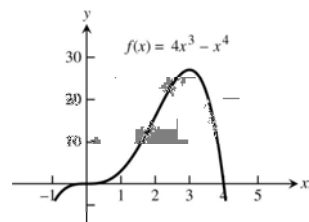

9. $[-4, 4]$ by $[-5, 5]$

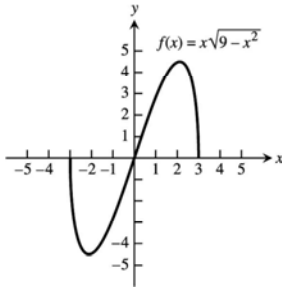

10. $[-2, 2]$ by $[-2, 8]$

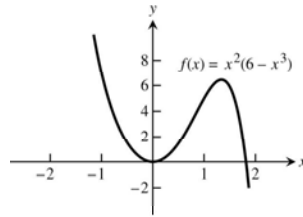

11. $[-2, 6]$ by $[-5, 4]$

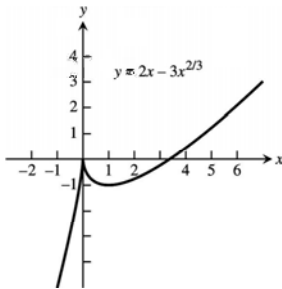

12. $[-4, 4]$ by $[-8, 8]$

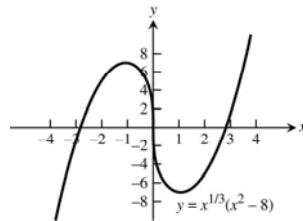

13. $[-1, 6]$ by $[-1, 4]$

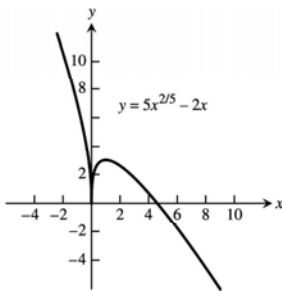

14. $[-1, 6]$ by $[-1, 5]$

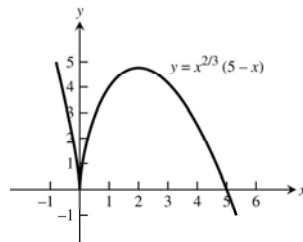

15. $[-3, 3]$ by $[0, 10]$

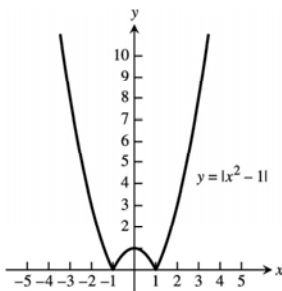

16. $[-1, 2]$ by $[0, 1]$

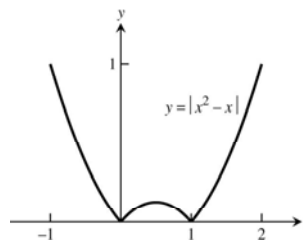

17. $[-5, 1]$ by $[-5, 5]$

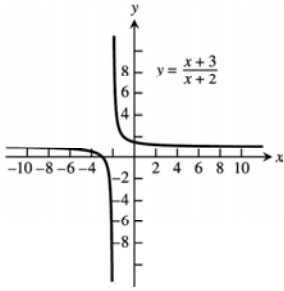

18. $[-5, 1]$ by $[-2, 4]$

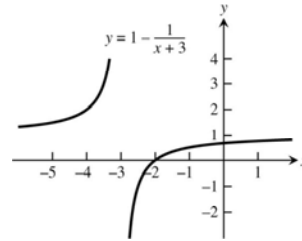

19. $[-4, 4]$ by $[0, 3]$

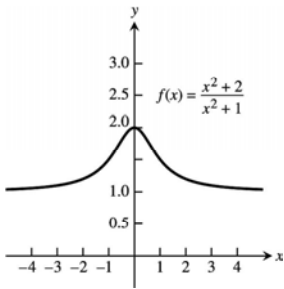

20. $[-5, 5]$ by $[-2, 2]$

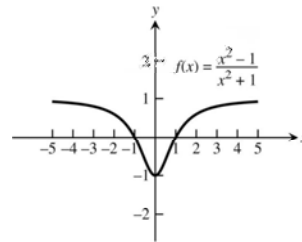

21. $[-10, 10]$ by $[-6, 6]$

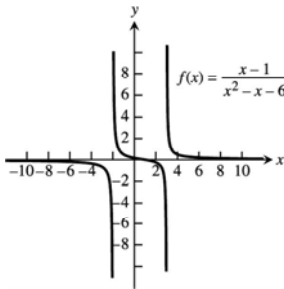

22. $[-5, 5]$ by $[-2, 2]$

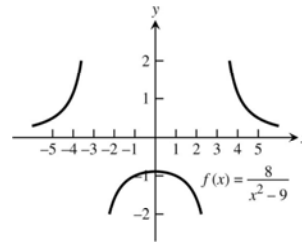

23. $[-6, 10]$ by $[-6, 6]$

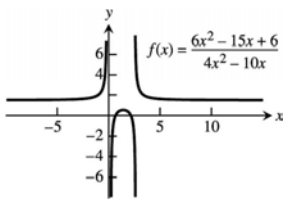

24. $[-3, 5]$ by $[-2, 10]$

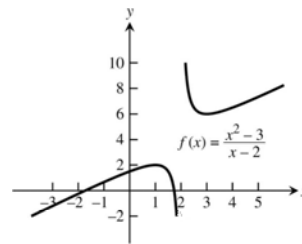

25. $[-0.03, 0.03]$ by $[-1.25, 1.25]$

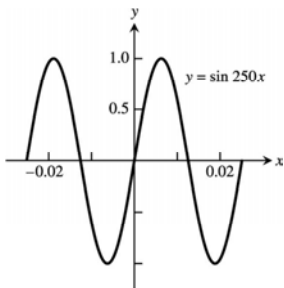

26. $[-0.1, 0.1]$ by $[-3, 3]$

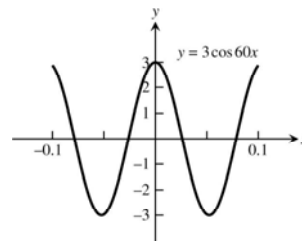

27. $[-300, 300]$ by $[-1.25, 1.25]$

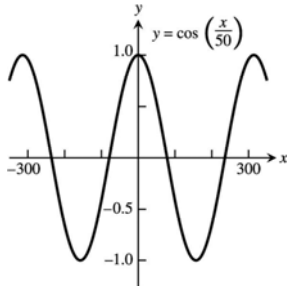

28. $[-50, 50]$ by $[-0.1, 0.1]$

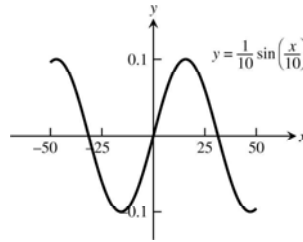

29. $[-0.25, 0.25]$ by $[-0.3, 0.3]$

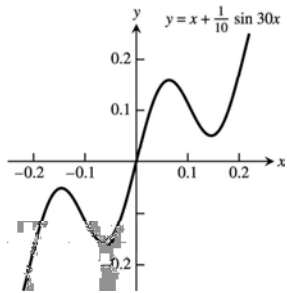

30. $[-0.15, 0.15]$ by $[-0.02, 0.05]$

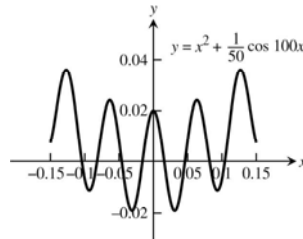

31. $x^2 + 2x = 4 + 4y - y^2 \Rightarrow y = 2 \pm \sqrt{-x^2 - 2x + 8}$.
The lower half is produced by graphing
 $y = 2 - \sqrt{-x^2 - 2x + 8}$.

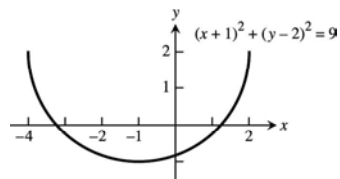

32. $y^2 - 16x^2 = 1 \Rightarrow y = \pm \sqrt{1 + 16x^2}$. The upper branch
is produced by graphing $y = \sqrt{1 + 16x^2}$.

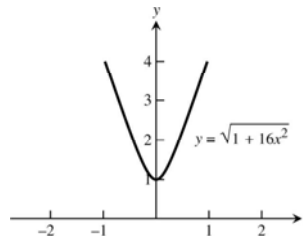

33.

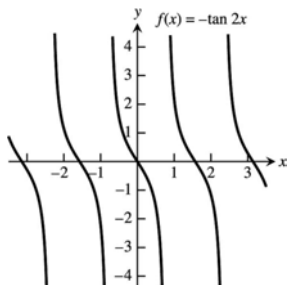

34.

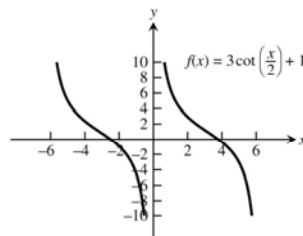

30 Chapter 1 Functions

35.

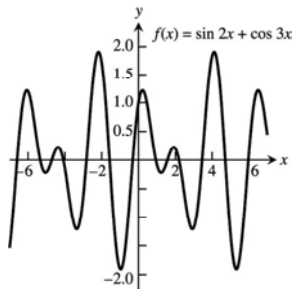

36.

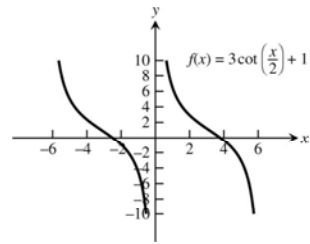

37.

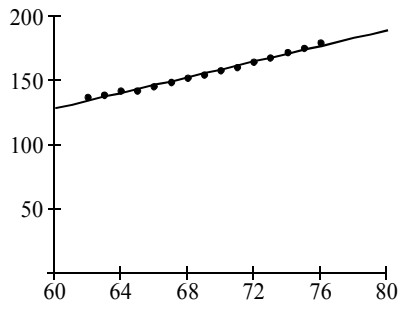

38.

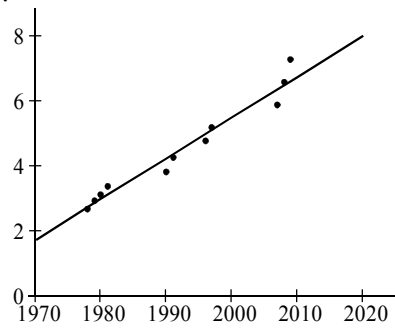

39.

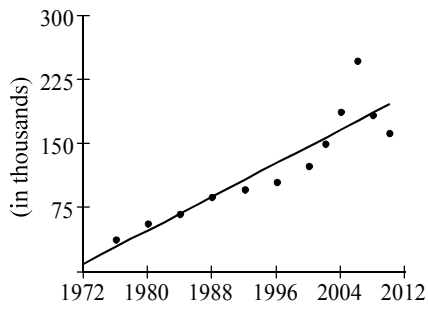

40.

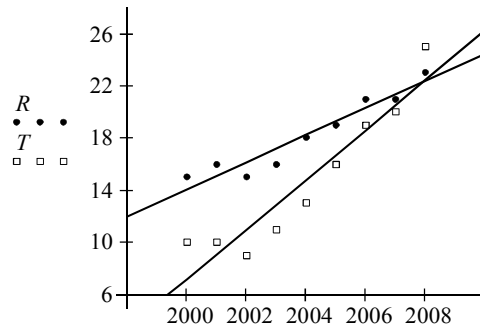

41.

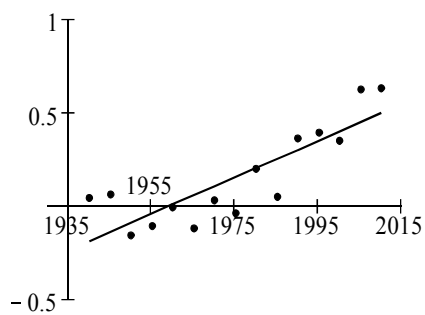

42.

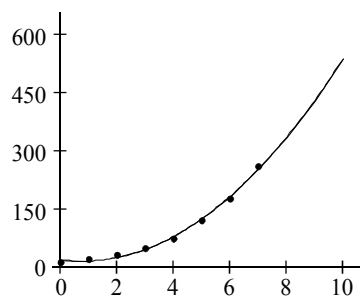

1.5 EXPONENTIAL FUNCTIONS

1.

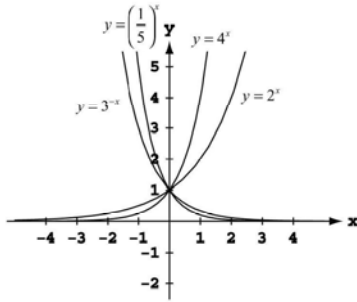

2.

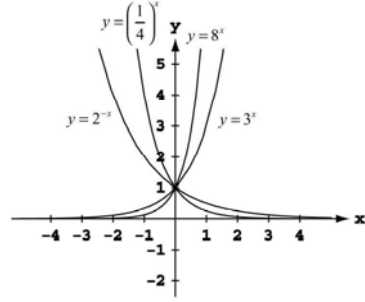

3.

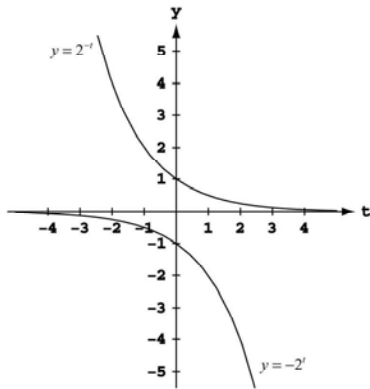

4.

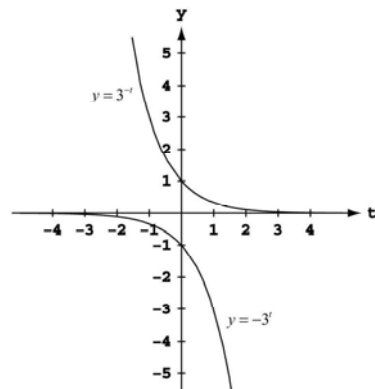

5.

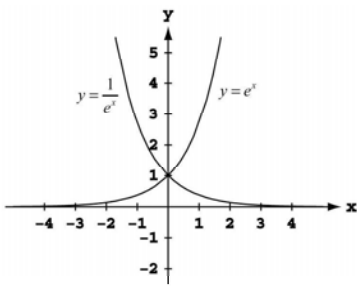

6.

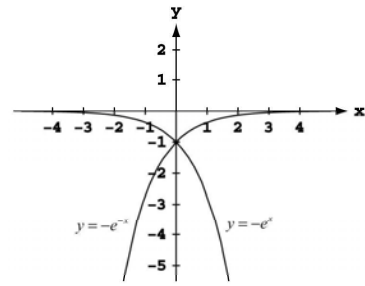

7.

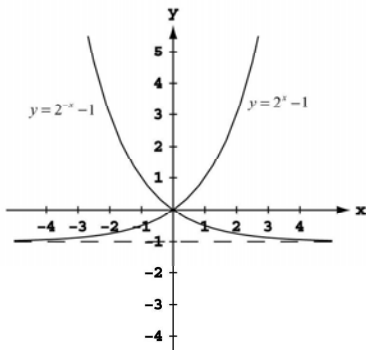

8.

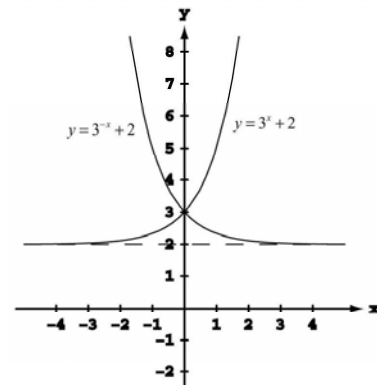

9.

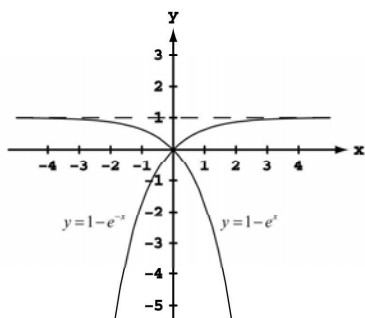

10.

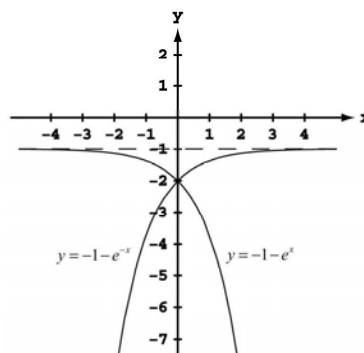

11. $16^2 \cdot 16^{-1.75} = 16^{2+(-1.75)} = 16^{0.25} = 16^{1/4} = 2$

12. $9^{1/3} \cdot 9^{1/6} = 9^{\frac{1}{3} + \frac{1}{6}} = 9^{1/2} = 3$

13. $\frac{4^{4.2}}{4^{3.7}} = 4^{4.2-3.7} = 4^{0.5} = 4^{1/2} = 2$

14. $\frac{3^{5/3}}{3^{2/3}} = 3^{\frac{5}{3} - \frac{2}{3}} = 3^1 = 3$

15. $(25^{1/8})^4 = 25^{4/8} = 25^{1/2} = 5$

16. $(13^{\sqrt{2}})^{\sqrt{2}/2} = 13^{2/2} = 13$

17. $2^{\sqrt{3}} \cdot 7^{\sqrt{3}} = (2 \cdot 7)^{\sqrt{3}} = 14^{\sqrt{3}}$

18. $(\sqrt{3})^{1/2} (\sqrt{12})^{1/2} = (\sqrt{3} \cdot \sqrt{12})^{1/2} = (\sqrt{36})^{1/2} = 6^{1/2}$

19. $\left(\frac{2}{\sqrt{2}}\right)^4 = \frac{2^4}{(2^{1/2})^4} = \frac{16}{2^2} = 4$

20. $\left(\frac{\sqrt{6}}{3}\right)^2 = \frac{(6^{1/2})^2}{3^2} = \frac{6}{9} = \frac{2}{3}$

21. Domain: $(-\infty, \infty)$; y in range $\Rightarrow y = \frac{1}{2+e^x}$. As x increases, e^x becomes infinitely large and y becomes a smaller and smaller positive real number. As x decreases, e^x becomes a smaller and smaller positive real number, $y < \frac{1}{2}$, and y gets arbitrarily close to $\frac{1}{2} \Rightarrow$ Range: $(0, \frac{1}{2})$.

22. Domain: $(-\infty, \infty)$; y in range $\Rightarrow y = \cos(e^{-t})$. Since the values of e^{-t} are $(0, \infty)$ and $-1 \leq \cos x \leq 1 \Rightarrow$ Range: $[-1, 1]$.

23. Domain: $(-\infty, \infty)$; y in range $\Rightarrow y = \sqrt{1+3^{-t}}$. Since the values of 3^{-t} are $(0, \infty) \Rightarrow$ Range: $(1, \infty)$.

24. If $e^{2x} = 1$, then $x = 0 \Rightarrow$ Domain: $(-\infty, 0) \cup (0, \infty)$; y in range $\Rightarrow y = \frac{3}{1-e^{2x}}$. If $x > 0$, then $1 < e^{2x} < \infty \Rightarrow -\infty < y < 0$. If $x < 0$, then $0 < e^{2x} < 1 \Rightarrow 3 < y < \infty \Rightarrow$ Range: $(-\infty, 0) \cup (3, \infty)$.

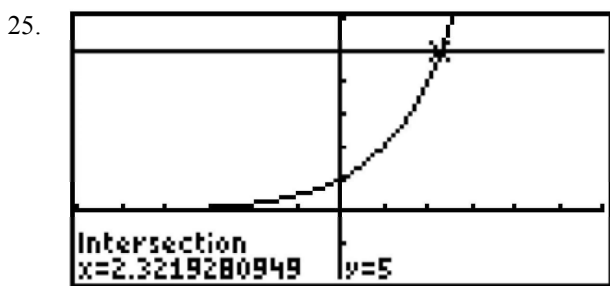

$[-6, 6]$ by $[-2, 6]$

$x \approx 2.3219$

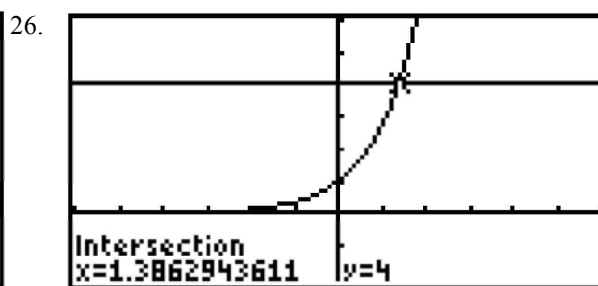

$[-6, 6]$ by $[-2, 6]$

$x \approx 1.3863$

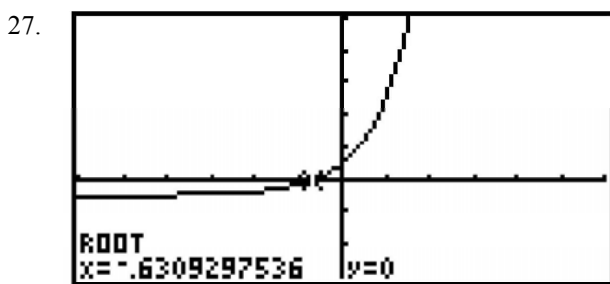

$[-6, 6]$ by $[-3, 5]$

$x \approx -0.6309$

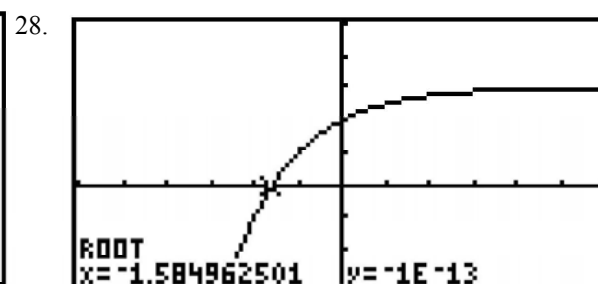

$[-6, 6]$ by $[-3, 5]$

$x \approx -1.5850$

29. Let t be the number of years. Solving $500,000(1.0375)^t = 1,000,000$ graphically, we find that $t \approx 18.828$. The population will reach 1 million in about 19 years.

30. (a) The population is given by $P(t) = 6250(1.0275)^t$, where t is the number of years after 1890.

Population in 1915: $P(25) \approx 12,315$

Population in 1940: $P(50) \approx 24,265$

(b) Solving $P(t) = 50,000$ graphically, we find that $t \approx 76.651$. The population reached 50,000 about 77 years after 1890, in 1967.

31. (a) $A(t) = 6.6\left(\frac{1}{2}\right)^{t/14}$

(b) Solving $A(t) = 1$ graphically, we find that $t \approx 38$. There will be 1 gram remaining after about 38.1145 days.

32. Let t be the number of years. Solving $2300(1.60)^t = 4150$ graphically, we find that $t \approx 10.129$. It will take about 10.129 years. (If the interest is not credited to the account until the end of each year, it will take 11 years.)

33. Let A be the amount of the initial investment, and let t be the number of years. We wish to solve $A(1.0625)^t = 2A$, which is equivalent to $1.0625^t = 2$. Solving graphically, we find that $t \approx 11.433$. It will take about 11.433 years. (If the interest is credited at the end of each year, it will take 12 years.)

34. Let A be the amount of the initial investment, and let t be the number of years. We wish to solve $Ae^{0.0575t} = 3A$, which is equivalent to $e^{0.0575t} = 3$. Solving graphically, we find that $t \approx 19.106$. It will take about 19.106 years.

35. After t hours, the population is $P(t) = 2^{t/0.5}$, or equivalently, $P(t) = 2^{2t}$. After 24 hours, the population is $P(24) = 2^{48} \approx 2.815 \times 10^{14}$ bacteria.
36. (a) Each year, the number of cases is $100\% - 20\% = 80\%$ of the previous year's number of cases. After t years, the number of cases will be $C(t) = 10,000(0.8)^t$. Solving $C(t) = 1000$ graphically, we find that $t \approx 10.319$. It will take 10.319 years.
- (b) Solving $C(t) = 1$ graphically, we find that $t \approx 41.275$. It will take about 41.275 years.

1.6 INVERSE FUNCTIONS AND LOGARITHMS

1. Yes one-to-one, the graph passes the horizontal line test.
2. Not one-to-one, the graph fails the horizontal line test.
3. Not one-to-one since (for example) the horizontal line $y = 2$ intersects the graph twice.
4. Not one-to-one, the graph fails the horizontal line test.
5. Yes one-to-one, the graph passes the horizontal line test.
6. Yes one-to-one, the graph passes the horizontal line test.
7. Not one-to-one since the horizontal line $y = 3$ intersects the graph an infinite number of times.
8. Yes one-to-one, the graph passes the horizontal line test.
9. Yes one-to one, graph passes the horizontal line test.
10. Not one-to-one since (for example) the horizontal line $y = 1$ intersects the graph twice.

11. Domain: $0 < x \leq 1$, Range: $0 \leq y$

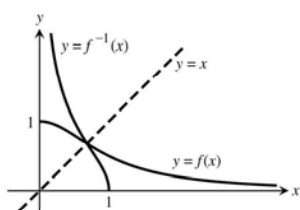

12. Domain: $x < 1$, Range: $y > 0$

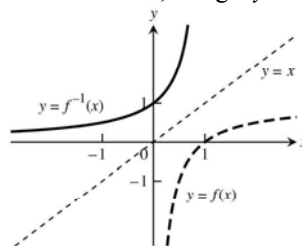

13. Domain: $-1 \leq x \leq 1$, Range: $-\frac{\pi}{2} \leq y \leq \frac{\pi}{2}$

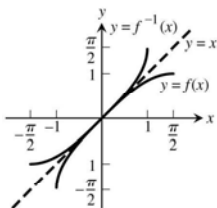

14. Domain: $-\infty < x < \infty$, Range: $-\frac{\pi}{2} < y \leq \frac{\pi}{2}$

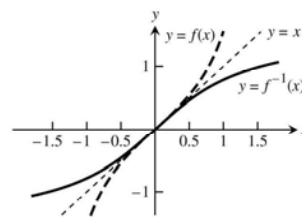

15. Domain:
- $0 \leq x \leq 6$
- , Range:
- $0 \leq y \leq 3$

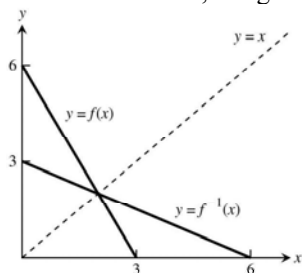

16. Domain:
- $-2 \leq x \leq 1$
- , Range:
- $-1 \leq y < 3$

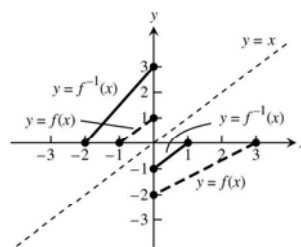

17. The graph is symmetric about
- $y = x$
- .

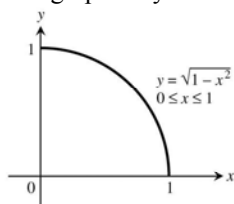

$$(b) \quad y = \sqrt{1-x^2} \Rightarrow y^2 = 1-x^2 \Rightarrow x^2 = 1-y^2 \Rightarrow x = \sqrt{1-y^2} \Rightarrow y = \sqrt{1-x^2} = f^{-1}(x)$$

18. (a) The graph is symmetric about
- $y = x$
- .

$$(b) \quad y = \frac{1}{x} \Rightarrow x = \frac{1}{y} \Rightarrow y = \frac{1}{x} = f^{-1}(x)$$

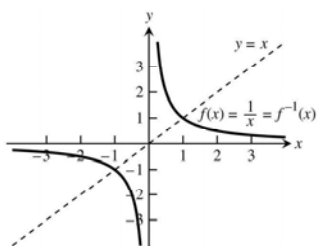

19. Step 1:
- $y = x^2 + 1 \Rightarrow x^2 = y - 1 \Rightarrow x = \sqrt{y - 1}$

$$\text{Step 2: } y = \sqrt{x - 1} = f^{-1}(x)$$

20. Step 1:
- $y = x^2 \Rightarrow x = -\sqrt{y}$
- , since
- $x \leq 0$
- .

$$\text{Step 2: } y = -\sqrt{x} = f^{-1}(x)$$

21. Step 1:
- $y = x^3 - 1 \Rightarrow x^3 = y + 1 \Rightarrow x = (y + 1)^{1/3}$

$$\text{Step 2: } y = \sqrt[3]{x + 1} = f^{-1}(x)$$

22. Step 1:
- $y = x^2 - 2x + 1 \Rightarrow y = (x - 1)^2 \Rightarrow \sqrt{y} = x - 1$
- , since
- $x \geq 1 \Rightarrow x = 1 + \sqrt{y}$

$$\text{Step 2: } y = 1 + \sqrt{x} = f^{-1}(x)$$

23. Step 1:
- $y = (x + 1)^2 \Rightarrow \sqrt{y} = x + 1$
- , since
- $x \geq -1 \Rightarrow x = \sqrt{y} - 1$

$$\text{Step 2: } y = \sqrt{x} - 1 = f^{-1}(x)$$

24. Step 1: $y = x^{2/3} \Rightarrow x = y^{3/2}$

Step 2: $y = x^{3/2} = f^{-1}(x)$

25. Step 1: $y = x^5 \Rightarrow x = y^{1/5}$

Step 2: $y = \sqrt[5]{x} = f^{-1}(x)$;

Domain and Range of f^{-1} : all reals;

$f(f^{-1}(x)) = (x^{1/5})^5 = x$ and $f^{-1}(f(x)) = (x^5)^{1/5} = x$

26. Step 1: $y = x^4 \Rightarrow x = y^{1/4}$

Step 2: $y = \sqrt[4]{x} = f^{-1}(x)$;

Domain of f^{-1} : $x \geq 0$, Range of f^{-1} : $y \geq 0$;

$f(f^{-1}(x)) = (x^{1/4})^4 = x$ and $f^{-1}(f(x)) = (x^4)^{1/4} = x$

27. Step 1: $y = x^3 + 1 \Rightarrow x^3 = y - 1 \Rightarrow x = (y - 1)^{1/3}$

Step 2: $y = \sqrt[3]{x - 1} = f^{-1}(x)$;

Domain and Range of f^{-1} : all reals;

$f(f^{-1}(x)) = ((x - 1)^{1/3})^3 + 1 = (x - 1) + 1 = x$ and $f^{-1}(f(x)) = ((x^3 + 1) - 1)^{1/3} = (x^3)^{1/3} = x$

28. Step 1: $y = \frac{1}{2}x - \frac{7}{2} \Rightarrow \frac{1}{2}x = y + \frac{7}{2} \Rightarrow x = 2y + 7$

Step 2: $y = 2x + 7 = f^{-1}(x)$;

Domain and Range of f^{-1} : all reals;

$f(f^{-1}(x)) = \frac{1}{2}(2x + 7) - \frac{7}{2} = \left(x + \frac{7}{2}\right) - \frac{7}{2} = x$ and $f^{-1}(f(x)) = 2\left(\frac{1}{2}x - \frac{7}{2}\right) + 7 = (x - 7) + 7 = x$

29. Step 1: $y = \frac{1}{x^2} \Rightarrow x^2 = \frac{1}{y} \Rightarrow x = \frac{1}{\sqrt{y}}$

Step 2: $y = \frac{1}{\sqrt{x}} = f^{-1}(x)$

Domain of f^{-1} : $x > 0$, Range of f^{-1} : $y > 0$;

$f(f^{-1}(x)) = \frac{1}{\left(\frac{1}{\sqrt{x}}\right)^2} = \frac{1}{\left(\frac{1}{x}\right)} = x$ and $f^{-1}(f(x)) = \frac{1}{\sqrt{\frac{1}{x^2}}} = \frac{1}{\left(\frac{1}{x}\right)} = x$ since $x > 0$.

30. Step 1: $y = \frac{1}{x^3} \Rightarrow x^3 = \frac{1}{y} \Rightarrow x = \frac{1}{y^{1/3}}$

Step 2: $y = \frac{1}{x^{1/3}} = \sqrt[3]{\frac{1}{x}} = f^{-1}(x)$;

Domain of f^{-1} : $x \neq 0$, Range of f^{-1} : $y \neq 0$;

$f(f^{-1}(x)) = \frac{1}{\left(x^{-1/3}\right)^3} = \frac{1}{x^{-1}} = x$ and $f^{-1}(f(x)) = \left(\frac{1}{x^3}\right)^{-1/3} = \left(\frac{1}{x}\right)^{-1} = x$

31. Step 1: $y = \frac{x+3}{x-2} \Rightarrow y(x-2) = x+3 \Rightarrow xy - 2y = x+3 \Rightarrow xy - x = 2y+3 \Rightarrow x = \frac{2y+3}{y-1}$

Step 2: $y = \frac{2x+3}{x-1} = f^{-1}(x)$;

Domain of f^{-1} : $x \neq 1$, Range of f^{-1} : $y \neq 2$;

$$f(f^{-1}(x)) = \frac{\left(\frac{2x+3}{x-1}\right)+3}{\left(\frac{2x+3}{x-1}\right)-2} = \frac{(2x+3)+3(x-1)}{(2x+3)-2(x-1)} = \frac{5x}{5} = x \text{ and } f^{-1}(f(x)) = \frac{2\left(\frac{x+3}{x-2}\right)+3}{\left(\frac{x+3}{x-2}\right)-1} = \frac{2(x+3)+3(x-2)}{(x+3)-(x-2)} = \frac{5x}{5} = x$$

32. Step 1: $y = \frac{\sqrt{x}}{\sqrt{x-3}} \Rightarrow y(\sqrt{x}-3) = \sqrt{x} \Rightarrow y\sqrt{x} - 3y = \sqrt{x} \Rightarrow y\sqrt{x} - \sqrt{x} = 3y \Rightarrow x = \left(\frac{3y}{y-1}\right)^2$

Step 2: $y = \left(\frac{3x}{x-1}\right)^2 = f^{-1}(x)$;

Domain of f^{-1} : $(-\infty, 0] \cup (1, \infty)$, Range of f^{-1} : $[0, 9) \cup (9, \infty)$;

$$f(f^{-1}(x)) = \frac{\sqrt{\left(\frac{3x}{x-1}\right)^2}}{\sqrt{\left(\frac{3x}{x-1}\right)^2}-3}; \text{ If } x > 1 \text{ or } x \leq 0 \Rightarrow \frac{3x}{x-1} \geq 0 \Rightarrow \frac{\sqrt{\left(\frac{3x}{x-1}\right)^2}}{\sqrt{\left(\frac{3x}{x-1}\right)^2}-3} = \frac{\frac{3x}{x-1}}{\frac{3x}{x-1}-3} = \frac{3x}{3x-3(x-1)} = \frac{3x}{3} = x \text{ and}$$

$$f^{-1}(f(x)) = \left(\frac{3\left(\frac{\sqrt{x}}{\sqrt{x-3}}\right)}{\frac{\sqrt{x}}{\sqrt{x-3}}-1}\right)^2 = \frac{9x}{(\sqrt{x}-\sqrt{x-3})^2} = \frac{9x}{9} = x$$

33. Step 1: $y = x^2 - 2x, x \leq 1 \Rightarrow y+1 = (x-1)^2, x \leq 1 \Rightarrow -\sqrt{y+1} = x-1, x \leq 1 \Rightarrow x = 1 - \sqrt{y+1}$

Step 2: $y = 1 - \sqrt{x+1} = f^{-1}(x)$;

Domain of f^{-1} : $[-1, \infty)$, Range of f^{-1} : $(-\infty, 1]$;

$$f(f^{-1}(x)) = (1 - \sqrt{x+1})^2 - 2(1 - \sqrt{x+1}) = 1 - 2\sqrt{x+1} + x + 1 - 2 + 2\sqrt{x+1} = x \text{ and}$$

$$f^{-1}(f(x)) = 1 - \sqrt{(x^2 - 2x) + 1}, x \leq 1 = 1 - \sqrt{(x-1)^2}, x \leq 1 = 1 - |x-1| = 1 - (1-x) = x$$

34. Step 1: $y = (2x^3 + 1)^{1/5} \Rightarrow y^5 = 2x^3 + 1 \Rightarrow y^5 - 1 = 2x^3 \Rightarrow \frac{y^5-1}{2} = x^3 \Rightarrow x = \sqrt[3]{\frac{y^5-1}{2}}$

Step 2: $y = \sqrt[3]{\frac{x^5-1}{2}} = f^{-1}(x)$;

Domain of f^{-1} : $(-\infty, \infty)$, Range of f^{-1} : $(-\infty, \infty)$;

$$f(f^{-1}(x)) = \left(2\left(\sqrt[3]{\frac{x^5-1}{2}}\right)^3 + 1\right)^{1/5} = \left(2\left(\frac{x^5-1}{2}\right) + 1\right)^{1/5} = ((x^5-1)+1)^{1/5} = (x^5)^{1/5} = x \text{ and}$$

$$f^{-1}(f(x)) = \sqrt[3]{\frac{[(2x^3+1)^{1/5}]^5-1}{2}} = \sqrt[3]{\frac{(2x^3+1)-1}{2}} = \sqrt[3]{\frac{2x^3}{2}} = x$$

35. (a) $y = mx \Rightarrow x = \frac{1}{m}y \Rightarrow f^{-1}(x) = \frac{1}{m}x$

(b) The graph of $y = f^{-1}(x)$ is a line through the origin with slope $\frac{1}{m}$.

36. $y = mx + b \Rightarrow x = \frac{y}{m} - \frac{b}{m} \Rightarrow f^{-1}(x) = \frac{1}{m}x - \frac{b}{m}$; the graph of $f^{-1}(x)$ is a line with slope $\frac{1}{m}$ and y -intercept $-\frac{b}{m}$.

37. (a) $y = x + 1 \Rightarrow x = y - 1 \Rightarrow f^{-1}(x) = x - 1$
 (b) $y = x + b \Rightarrow x = y - b \Rightarrow f^{-1}(x) = x - b$
 (c) Their graphs will be parallel to one another and lie on opposite sides of the line $y = x$ equidistant from that line.

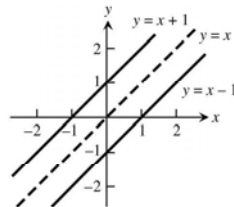

38. (a) $y = -x + 1 \Rightarrow x = -y + 1 \Rightarrow f^{-1}(x) = 1 - x$; the lines intersect at a right angle
 (b) $y = -x + b \Rightarrow x = -y + b \Rightarrow f^{-1}(x) = b - x$; the lines intersect at a right angle
 (c) Such a function is its own inverse

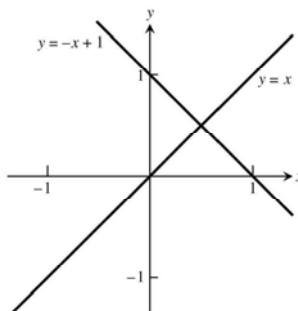

39. (a) $\ln 0.75 = \ln \frac{3}{4} = \ln 3 - \ln 4 = \ln 3 - \ln 2^2 = \ln 3 - 2 \ln 2$
 (b) $\ln \frac{4}{9} = \ln 4 - \ln 9 = \ln 2^2 - \ln 3^2 = 2 \ln 2 - 2 \ln 3$
 (c) $\ln \frac{1}{2} = \ln 1 - \ln 2 = -\ln 2$
 (d) $\ln \sqrt[3]{9} = \frac{1}{3} \ln 9 = \frac{1}{3} \ln 3^2 = \frac{2}{3} \ln 3$
 (e) $\ln 3\sqrt{2} = \ln 3 + \ln 2^{1/2} = \ln 3 + \frac{1}{2} \ln 2$
 (f) $\ln \sqrt{13.5} = \frac{1}{2} \ln 13.5 = \frac{1}{2} \ln \frac{27}{2} = \frac{1}{2} (\ln 3^3 - \ln 2) = \frac{1}{2} (3 \ln 3 - \ln 2)$

40. (a) $\ln \frac{1}{125} = \ln 1 - 3 \ln 5 = -3 \ln 5$
 (b) $\ln 9.8 = \ln \frac{49}{5} = \ln 7^2 - \ln 5 = 2 \ln 7 - \ln 5$
 (c) $\ln 7\sqrt{7} = \ln 7^{3/2} = \frac{3}{2} \ln 7$
 (d) $\ln 1225 = \ln 35^2 = 2 \ln 35 = 2 \ln 5 + 2 \ln 7$
 (e) $\ln 0.056 - \ln \frac{7}{125} = \ln 7 - \ln 5^3 = \ln 7 - 3 \ln 5$
 (f) $\frac{\ln 35 + \ln \frac{1}{7}}{\ln 25} = \frac{\ln 5 + \ln 7 - \ln 7}{2 \ln 5} = \frac{1}{2}$

41. (a) $\ln \sin \theta - \ln \left(\frac{\sin \theta}{5} \right) = \ln \left(\frac{\sin \theta}{\frac{\sin \theta}{5}} \right) = \ln 5$
 (b) $\ln(3x^2 - 9x) + \ln \left(\frac{1}{3x} \right) = \ln \left(\frac{3x^2 - 9x}{3x} \right) = \ln(x - 3)$
 (c) $\frac{1}{2} \ln(4t^4) - \ln 2 = \ln \sqrt{4t^4} - \ln 2 = \ln 2t^2 - \ln 2 = \ln \left(\frac{2t^2}{2} \right) = \ln(t^2)$

42. (a) $\ln \sec \theta + \ln \cos \theta = \ln[(\sec \theta)(\cos \theta)] = \ln 1 = 0$
 (b) $\ln(8x + 4) - \ln 2^2 = \ln(8x + 4) - \ln 4 = \ln \left(\frac{8x + 4}{4} \right) = \ln(2x + 1)$
 (c) $3 \ln \sqrt[3]{t^2 - 1} - \ln(t + 1) = 3 \ln(t^2 - 1)^{1/3} - \ln(t + 1) = 3 \left(\frac{1}{3} \right) \ln(t^2 - 1) - \ln(t + 1) = \ln \left(\frac{(t+1)(t-1)}{(t+1)} \right) = \ln(t - 1)$

43. (a) $e^{\ln 7.2} = 7.2$ (b) $e^{-\ln x^2} = \frac{1}{e^{\ln x^2}} = \frac{1}{x^2}$ (c) $e^{\ln x - \ln y} = e^{\ln(x/y)} = \frac{x}{y}$
44. (a) $e^{\ln(x^2+y^2)} = x^2 + y^2$ (b) $e^{-\ln 0.3} = \frac{1}{e^{\ln 0.3}} = \frac{1}{0.3}$ (c) $e^{\ln \pi x - \ln 2} = e^{\ln(\pi x/2)} = \frac{\pi x}{2}$
45. (a) $2 \ln \sqrt{e} = 2 \ln e^{1/2} = (2)\left(\frac{1}{2}\right) \ln e = 1$ (b) $\ln(\ln e^e) = \ln(e \ln e) = \ln e = 1$
(c) $\ln e^{(-x^2-y^2)} = (-x^2-y^2) \ln e = -x^2 - y^2$
46. (a) $\ln(e^{\sec \theta}) = (\sec \theta)(\ln e) = \sec \theta$ (b) $\ln e^{(e^x)} = (e^x)(\ln e) = e^x$
(c) $\ln(e^{2 \ln x}) = \ln(e^{\ln x^2}) = \ln x^2 = 2 \ln x$
47. $\ln y = 2t + 4 \Rightarrow e^{\ln y} = e^{2t+4} \Rightarrow y = e^{2t+4}$ 48. $\ln y = -t + 5 \Rightarrow e^{\ln y} = e^{-t+5} \Rightarrow y = e^{-t+5}$
49. $\ln(y - 40) = 5t \Rightarrow e^{\ln(y-40)} = e^{5t} \Rightarrow y - 40 = e^{5t} \Rightarrow y = e^{5t} + 40$
50. $\ln(1 - 2y) = t \Rightarrow e^{\ln(1-2y)} = e^t \Rightarrow 1 - 2y = e^t \Rightarrow -2y = e^t - 1 \Rightarrow y = -\left(\frac{e^t - 1}{2}\right)$
51. $\ln(y - 1) - \ln 2 = x + \ln x \Rightarrow \ln(y - 1) - \ln 2 - \ln x = x \Rightarrow \ln\left(\frac{y-1}{2x}\right) = x \Rightarrow e^{\ln\left(\frac{y-1}{2x}\right)} = e^x \Rightarrow \frac{y-1}{2x} = e^x$
 $\Rightarrow y - 1 = 2xe^x \Rightarrow y = 2xe^x + 1$
52. $\ln(y^2 - 1) - \ln(y + 1) = \ln(\sin x) \Rightarrow \ln\left(\frac{y^2-1}{y+1}\right) = \ln(\sin x) \Rightarrow \ln(y - 1) = \ln(\sin x) \Rightarrow e^{\ln(y-1)} = e^{\ln(\sin x)}$
 $\Rightarrow y - 1 = \sin x \Rightarrow y = \sin x + 1$
53. (a) $e^{2k} = 4 \Rightarrow \ln e^{2k} = \ln 4 \Rightarrow 2k \ln e = \ln 4 \Rightarrow 2k = 2 \ln 2 \Rightarrow k = \ln 2$
(b) $100e^{10k} = 200 \Rightarrow e^{10k} = 2 \Rightarrow \ln e^{10k} = \ln 2 \Rightarrow 10k \ln e = \ln 2 \Rightarrow 10k = \ln 2 \Rightarrow k = \frac{\ln 2}{10}$
(c) $e^{k/1000} = a \Rightarrow \ln e^{k/1000} = \ln a \Rightarrow \frac{k}{1000} \ln e = \ln a \Rightarrow \frac{k}{1000} = \ln a \Rightarrow k = 1000 \ln a$
54. (a) $e^{5k} = \frac{1}{4} \Rightarrow \ln e^{5k} = \ln 4^{-1} \Rightarrow 5k \ln e = -\ln 4 \Rightarrow 5k = -\ln 4 \Rightarrow k = -\frac{\ln 4}{5}$
(b) $80e^k = 1 \Rightarrow e^k = 80^{-1} \Rightarrow \ln e^k = \ln 80^{-1} \Rightarrow k \ln e = -\ln 80 \Rightarrow k = -\ln 80$
(c) $e^{(\ln 0.8)k} = 0.8 \Rightarrow (e^{\ln 0.8})^k = 0.8 \Rightarrow (0.8)^k = 0.8 \Rightarrow k = 1$
55. (a) $e^{-0.3t} = 27 \Rightarrow \ln e^{-0.3t} = \ln 3^3 \Rightarrow (-0.3t) \ln e = 3 \ln 3 \Rightarrow -0.3t = 3 \ln 3 \Rightarrow t = -10 \ln 3$
(b) $e^{kt} = \frac{1}{2} \Rightarrow \ln e^{kt} = \ln 2^{-1} = kt \ln e = -\ln 2 \Rightarrow t = -\frac{\ln 2}{k}$
(c) $e^{(\ln 0.2)t} = 0.4 \Rightarrow (e^{\ln 0.2})^t = 0.4 \Rightarrow 0.2^t = 0.4 \Rightarrow \ln 0.2^t = \ln 0.4 \Rightarrow t \ln 0.2 = \ln 0.4 \Rightarrow t = \frac{\ln 0.4}{\ln 0.2}$

56. (a) $e^{-0.01t} = 1000 \Rightarrow \ln e^{-0.01t} = \ln 1000 \Rightarrow (-0.01t)\ln e = \ln 1000 \Rightarrow -0.01t = \ln 1000 \Rightarrow t = -100 \ln 1000$

(b) $e^{kt} = \frac{1}{10} \Rightarrow \ln e^{kt} = \ln 10^{-1} = kt \ln e = -\ln 10 \Rightarrow kt = -\ln 10 \Rightarrow t = -\frac{\ln 10}{k}$

(c) $e^{(\ln 2)t} = \frac{1}{2} \Rightarrow (e^{\ln 2})^t = 2^{-1} \Rightarrow 2^t = 2^{-1} \Rightarrow t = -1$

57. $e^{\sqrt{t}} = x^2 \Rightarrow \ln e^{\sqrt{t}} = \ln x^2 \Rightarrow \sqrt{t} = 2 \ln x \Rightarrow t = 4(\ln x)^2$

58. $e^{x^2} e^{2x+1} = e^t \Rightarrow e^{x^2+2x+1} = e^t \Rightarrow \ln e^{x^2+2x+1} = \ln e^t \Rightarrow t = x^2 + 2x + 1$

59. (a) $5^{\log_5 7} = 7$ (b) $8^{\log_8 \sqrt{2}} = \sqrt{2}$ (c) $1.3^{\log_3 75} = 75$

(d) $\log_4 16 = \log_4 4^2 = 2 \log_4 4 = 2 \cdot 1 = 2$

(e) $\log_3 \sqrt{3} = \log_3 3^{1/2} = \frac{1}{2} \log_3 3 = \frac{1}{2} \cdot 1 = \frac{1}{2} = 0.5$

(f) $\log_4 \left(\frac{1}{4}\right) = \log_4 4^{-1} = -1 \log_4 4 = -1 \cdot 1 = -1$

60. (a) $2^{\log_2 3} = 3$ (b) $10^{\log_{10}(1/2)} = \frac{1}{2}$ (c) $\pi^{\log_\pi 7} = 7$

(d) $\log_{11} 121 = \log_{11} 11^2 = 2 \log_{11} 11 = 2 \cdot 1 = 2$

(e) $\log_{121} 11 = \log_{121} 121^{1/2} = \left(\frac{1}{2}\right) \log_{121} 121 = \left(\frac{1}{2}\right) \cdot 1 = \frac{1}{2}$

(f) $\log_3 \left(\frac{1}{9}\right) = \log_3 3^{-2} = -2 \log_3 3 = -2 \cdot 1 = -2$

61. (a) Let $z = \log_4 x \Rightarrow 4^z = x \Rightarrow 2^{2z} = x \Rightarrow (2^z)^2 = x \Rightarrow 2^z = \sqrt{x}$

(b) Let $z = \log_3 x \Rightarrow 3^z = x \Rightarrow (3^z)^2 = x^2 \Rightarrow 3^{2z} = x^2 \Rightarrow 9^z = x^2$

(c) $\log_2(e^{(\ln 2)\sin x}) = \log_2 2^{\sin x} = \sin x$

62. (a) Let $z = \log_5(3x^2) \Rightarrow 5^z = 3x^2 \Rightarrow 25^z = 9x^4$

(b) $\log_e(e^x) = x$

(c) $\log_4(2^{e^x \sin x}) = \log_4 4^{(e^x \sin x)/2} = \frac{e^x \sin x}{2}$

63. (a) $\frac{\log_2 x}{\log_3 x} = \frac{\ln x}{\ln 2} \div \frac{\ln x}{\ln 3} = \frac{\ln x}{\ln 2} \cdot \frac{\ln 3}{\ln x} = \frac{\ln 3}{\ln 2}$ (b) $\frac{\log_2 x}{\log_8 x} = \frac{\ln x}{\ln 2} \div \frac{\ln x}{\ln 8} = \frac{\ln x}{\ln 2} \cdot \frac{\ln 8}{\ln x} = \frac{3 \ln 2}{\ln 2} = 3$

(c) $\frac{\ln_x a}{\ln_{x^2} a} = \frac{\ln a}{\ln x} \div \frac{\ln a}{\ln x^2} = \frac{\ln a}{\ln x} \cdot \frac{\ln x^2}{\ln a} = \frac{2 \ln x}{\ln x} = 2$

64. (a) $\frac{\log_9 x}{\log_3 x} = \frac{\ln x}{\ln 9} \div \frac{\ln x}{\ln 3} = \frac{\ln x}{2 \ln 3} \cdot \frac{\ln 3}{\ln x} = \frac{1}{2}$

(b) $\frac{\log_{\sqrt{10}} x}{\log_{\sqrt{2}} x} = \frac{\ln x}{\ln \sqrt{10}} \div \frac{\ln x}{\ln \sqrt{2}} = \frac{\ln x}{\left(\frac{1}{2}\right) \ln 10} \cdot \frac{\left(\frac{1}{2}\right) \ln 2}{\ln x} = \frac{\ln 2}{\ln 10}$

(c) $\frac{\log_a b}{\log_b a} = \frac{\ln b}{\ln a} \div \frac{\ln a}{\ln b} = \frac{\ln b}{\ln a} \cdot \frac{\ln b}{\ln a} = \left(\frac{\ln b}{\ln a}\right)^2$

65. (a) $-\frac{\pi}{6}$ (b) $\frac{\pi}{4}$ (c) $-\frac{\pi}{3}$

66. (a) $\frac{\pi}{3}$ (b) $\frac{3\pi}{4}$ (c) $\frac{\pi}{6}$
67. (a) $\arccos(-1) = \pi$ since $\cos(\pi) = -1$ and $0 \leq \pi \leq \pi$.
 (b) $\arccos(0) = \frac{\pi}{2}$ since $\cos\left(\frac{\pi}{2}\right) = 0$ and $0 \leq \frac{\pi}{2} \leq \pi$.
68. (a) $\arcsin(-1) = -\frac{\pi}{2}$ since $\sin\left(-\frac{\pi}{2}\right) = -1$ and $-\frac{\pi}{2} \leq -\frac{\pi}{2} \leq \frac{\pi}{2}$.
 (b) $\arcsin\left(-\frac{1}{\sqrt{2}}\right) = -\frac{\pi}{4}$ since $\sin\left(-\frac{\pi}{4}\right) = -\frac{1}{\sqrt{2}}$ and $-\frac{\pi}{2} \leq -\frac{\pi}{4} \leq \frac{\pi}{2}$.
69. The function $g(x)$ is also one-to-one. The reasoning: $f(x)$ is one-to-one means that if $x_1 \neq x_2$ then $f(x_1) \neq f(x_2)$, so $-f(x_1) \neq -f(x_2)$ and therefore $g(x_1) \neq g(x_2)$. Therefore $g(x)$ is one-to-one as well.
70. The function $h(x)$ is also one-to-one. The reasoning: $f(x)$ is one-to-one means that if $x_1 \neq x_2$ then $f(x_1) \neq f(x_2)$, so $\frac{1}{f(x_1)} \neq \frac{1}{f(x_2)}$, and therefore $h(x_1) \neq h(x_2)$.
71. The composite is one-to-one also. The reasoning: If $x_1 \neq x_2$ then $g(x_1) \neq g(x_2)$ because g is one-to-one. Since $g(x_1) \neq g(x_2)$, we also have $f(g(x_1)) \neq f(g(x_2))$ because f is one-to-one; thus, $f \circ g$ is one-to-one because $x_1 \neq x_2 \Rightarrow f(g(x_1)) \neq f(g(x_2))$.
72. Yes, g must be one-to-one. If g were not one-to-one, there would exist numbers $x_1 \neq x_2$ in the domain of g with $g(x_1) = g(x_2)$. For these numbers we would also have $f(g(x_1)) = f(g(x_2))$, contradicting the assumption that $f \circ g$ is one-to-one.
73. (a) $y = \frac{100}{1+2^{-x}} \rightarrow 1+2^{-x} = \frac{100}{y} \rightarrow 2^{-x} = \frac{100}{y} - 1 \rightarrow \log_2(2^{-x}) = \log_2\left(\frac{100}{y} - 1\right) \rightarrow -x = \log_2\left(\frac{100}{y} - 1\right)$
 $x = -\log_2\left(\frac{100}{y} - 1\right) = -\log_2\left(\frac{100-y}{y}\right) = \log_2\left(\frac{y}{100-y}\right)$.
 Interchange x and y : $y = \log_2\left(\frac{x}{100-x}\right) \rightarrow f^{-1}(x) = \log_2\left(\frac{x}{100-x}\right)$
 Verify.
 $(f \circ f^{-1})(x) = f\left(\log_2\left(\frac{x}{100-x}\right)\right) = \frac{100}{1+2^{\log_2\left(\frac{x}{100-x}\right)}} = \frac{100}{1+2^{\log_2\left(\frac{100-x}{x}\right)}} = \frac{100}{1+\frac{100-x}{x}} = \frac{100}{\frac{x+100-x}{x}} = \frac{100x}{100} = x$
 $(f^{-1} \circ f)(x) = f^{-1}\left(\frac{100}{1+2^{-x}}\right) = \log_2\left(\frac{\frac{100}{1+2^{-x}}}{100-\frac{100}{1+2^{-x}}}\right) = \log_2\left(\frac{100}{100(1+2^{-x})-100}\right) = \log_2\left(\frac{1}{2^{-x}}\right) = \log_2(2^x) = x$
- (b) $y = \frac{50}{1+1.1^{-x}} \rightarrow 1+1.1^{-x} = \frac{50}{y} \rightarrow 1.1^{-x} = \frac{50}{y} - 1 \rightarrow \log_{1.1}(1.1^{-x}) = \log_{1.1}\left(\frac{50}{y} - 1\right) \rightarrow -x = \log_{1.1}\left(\frac{50}{y} - 1\right)$
 $x = -\log_{1.1}\left(\frac{50}{y} - 1\right) = -\log_{1.1}\left(\frac{50-y}{y}\right) = \log_{1.1}\left(\frac{y}{50-y}\right)$.
 Interchange x and y : $y = \log_{1.1}\left(\frac{x}{50-x}\right) \rightarrow f^{-1}(x) = \log_{1.1}\left(\frac{x}{50-x}\right)$
 Verify.

$$(f \circ f^{-1})(x) = f\left(\log_{1.1}\left(\frac{x}{50-x}\right)\right) = \frac{50}{1+1.1^{\log_{1.1}\left(\frac{x}{50-x}\right)}} = \frac{50}{1+1.1^{\log_{1.1}\left(\frac{50-x}{x}\right)}} = \frac{50}{1+\frac{50-x}{x}} = \frac{50x}{x+50-x} = \frac{50x}{50} = x$$

$$(f^{-1} \circ f)(x) = f^{-1}\left(\frac{50}{1+1.1^{-x}}\right) = \log_{1.1}\left(\frac{\frac{50}{1+1.1^{-x}}}{50-\frac{50}{1+1.1^{-x}}}\right) = \log_{1.1}\left(\frac{50}{50(1+1.1^{-x})-50}\right) = \log_{1.1}\left(\frac{1}{1.1^{-x}}\right) = \log_{1.1}(1.1^x) = x$$

74. $\sin^{-1}(1) + \cos^{-1}(1) = \frac{\pi}{2} + 0 = \frac{\pi}{2}$; $\sin^{-1}(0) + \cos^{-1}(0) = 0 + \frac{\pi}{2} = \frac{\pi}{2}$; and $\sin^{-1}(-1) + \cos^{-1}(-1) = -\frac{\pi}{2} + \pi = \frac{\pi}{2}$.

If $x \in (-1, 0)$ and $x = -a$, then $\sin^{-1}(x) + \cos^{-1}(x) = \sin^{-1}(-a) + \cos^{-1}(-a) = -\sin^{-1} a + (\pi - \cos^{-1} a)$
 $= \pi - (\sin^{-1} a + \cos^{-1} a) = \pi - \frac{\pi}{2} = \frac{\pi}{2}$ from Equations (3) and (4) in the text.

75. (a) Begin with $y = \ln x$ and reduce the y -value by 3 $\Rightarrow y = \ln x - 3$.
 (b) Begin with $y = \ln x$ and replace x with $x - 1 \Rightarrow y = \ln(x - 1)$.
 (c) Begin with $y = \ln x$, replace x with $x + 1$, and increase the y -value by 3 $\Rightarrow y = \ln(x + 1) + 3$.
 (d) Begin with $y = \ln x$, reduce the y -value by 4, and replace x with $x - 2 \Rightarrow y = \ln(x - 2) - 4$.
 (e) Begin with $y = \ln x$ and replace x with $-x \Rightarrow y = \ln(-x)$.
 (f) Begin with $y = \ln x$ and switch x and $y \Rightarrow x = \ln y$ or $y = e^x$.

76. (a) Begin with $y = \ln x$ and multiply the y -value by 2 $\Rightarrow y = 2 \ln x$.
 (b) Begin with $y = \ln x$ and replace x with $\frac{x}{3} \Rightarrow y = \ln\left(\frac{x}{3}\right)$.
 (c) Begin with $y = \ln x$ and multiply the y -value by $\frac{1}{4} \Rightarrow y = \frac{1}{4} \ln x$.
 (d) Begin with $y = \ln x$ and replace x with $2x \Rightarrow y = \ln 2x$.

77. From zooming in on the graph at the right, we estimate the third root to be $x \approx -0.76666$.

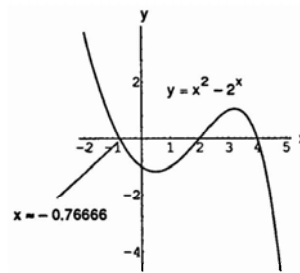

78. The functions $f(x) = x^{\ln 2}$ and $g(x) = 2^{\ln x}$ appear to have identical graphs for $x > 0$. This is no accident, because
 $x^{\ln 2} = e^{\ln 2 \cdot \ln x} = (e^{\ln 2})^{\ln x} = 2^{\ln x}$.

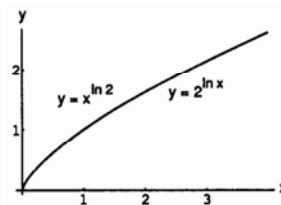

79. (a) Amount = $8\left(\frac{1}{2}\right)^{t/12}$
 (b) $8\left(\frac{1}{2}\right)^{t/12} = 1 \rightarrow \left(\frac{1}{2}\right)^{t/12} = \frac{1}{8} \rightarrow \left(\frac{1}{2}\right)^{t/12} = \left(\frac{1}{2}\right)^3 \rightarrow \frac{t}{12} = 3 \rightarrow t = 36$
 There will be 1 gram remaining after 36 hours.

80. $500(1.0475)^t = 1000 \rightarrow 1.0475^t = 2 \rightarrow \ln(1.0475^t) = \ln(2) \rightarrow t \ln(1.0475) = \ln(2) \rightarrow t = \frac{\ln(2)}{\ln(1.0475)} \approx 14.936$
 It will take about 14.936 years. (If the interest is paid at the end of each year, it will take 15 years.)

81. $375,000(1.0225)^t = 1,000,000 \rightarrow 1.0225^t = \frac{8}{3} \rightarrow \ln(1.0225^t) = \ln\left(\frac{8}{3}\right) \rightarrow t \ln(1.0225) = \ln\left(\frac{8}{3}\right)$
 $\rightarrow t = \frac{\ln\left(\frac{8}{3}\right)}{\ln(1.0225)} \approx 44.081$
 It will take about 44.081 years.

82. $y = y_0 e^{-0.18t}$ represents the decay equation; solving $(0.9)y_0 = y_0 e^{-0.18t} \Rightarrow t = \frac{\ln(0.9)}{-0.18} \approx 0.585$ days

CHAPTER 1 PRACTICE EXERCISES

1. The area is $A = \pi r^2$ and the circumference is $C = 2\pi r$. Thus, $r = \frac{C}{2\pi} \Rightarrow A = \pi\left(\frac{C}{2\pi}\right)^2 = \frac{C^2}{4\pi}$.
2. The surface area is $S = 4\pi r^2 \Rightarrow r = \left(\frac{S}{4\pi}\right)^{1/2}$. The volume is $V = \frac{4}{3}\pi r^3 \Rightarrow r = \sqrt[3]{\frac{3V}{4\pi}}$. Substitution into the formula for surface area gives $S = 4\pi r^2 = 4\pi\left(\frac{3V}{4\pi}\right)^{2/3}$.
3. The coordinates of a point on the parabola are (x, x^2) . The angle of inclination θ joining this point to the origin satisfies the equation $\tan \theta = \frac{x^2}{x} = x$. Thus the point has coordinates $(x, x^2) = (\tan \theta, \tan^2 \theta)$.
4. $\tan \theta = \frac{\text{rise}}{\text{run}} = \frac{h}{500} \Rightarrow h = 500 \tan \theta$ ft.

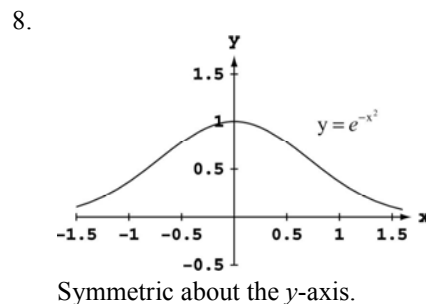
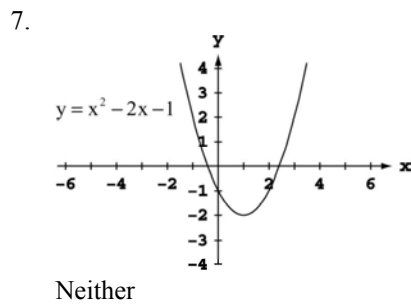
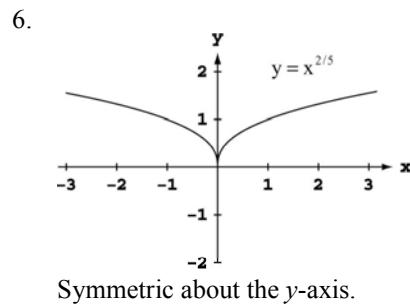
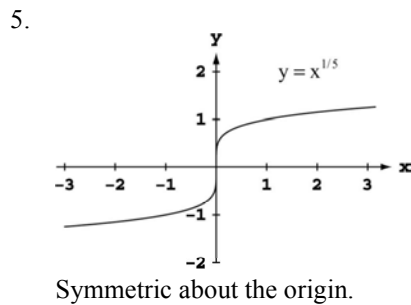

9. $y(-x) = (-x)^2 + 1 = x^2 + 1 = y(x)$. Even.

10. $y(-x) = (-x)^5 - (-x)^3 - (-x) = -x^5 + x^3 + x = -y(x)$. Odd.
11. $y(-x) = 1 - \cos(-x) = 1 - \cos x = y(x)$. Even.
12. $y(-x) = \sec(-x) \tan(-x) = \frac{\sin(-x)}{\cos^2(-x)} = \frac{-\sin x}{\cos^2 x} = -\sec x \tan x = -y(x)$. Odd.
13. $y(-x) = \frac{(-x)^4 + 1}{(-x)^3 - 2(-x)} = \frac{x^4 + 1}{-x^3 + 2x} = -\frac{x^4 + 1}{x^3 - 2x} = -y(x)$. Odd.
14. $y(-x) = (-x) - \sin(-x) = (-x) + \sin x = -(x - \sin x) = -y(x)$. Odd.
15. $y(-x) = -x + \cos(-x) = -x + \cos x$. Neither even nor odd.
16. $y(-x) = (-x) \cos(-x) = -x \cos x = -y(x)$. Odd.
17. Since f and g are odd $\Rightarrow f(-x) = -f(x)$ and $g(-x) = -g(x)$.
- (a) $(f \cdot g)(-x) = f(-x)g(-x) = [-f(x)][-g(x)] = f(x)g(x) = (f \cdot g)(x) \Rightarrow f \cdot g$ is even.
- (b) $f^3(-x) = f(-x)f(-x)f(-x) = [-f(x)][-f(x)][-f(x)] = -f(x) \cdot f(x) \cdot f(x) = -f^3(x) \Rightarrow f^3$ is odd.
- (c) $f(\sin(-x)) = f(-\sin(x)) = -f(\sin(x)) \Rightarrow f(\sin(x))$ is odd.
- (d) $g(\sec(-x)) = g(\sec(x)) \Rightarrow g(\sec(x))$ is even.
- (e) $|g(-x)| = |-g(x)| = |g(x)| \Rightarrow |g|$ is even.
18. Let $f(a-x) = f(a+x)$ and define $g(x) = f(x+a)$. Then $g(-x) = f((-x)+a) = f(a-x) = f(a+x) = f(x+a) = g(x) \Rightarrow g(x) = f(x+a)$ is even.
19. (a) The function is defined for all values of x , so the domain is $(-\infty, \infty)$.
 (b) Since $|x|$ attains all nonnegative values, the range is $[-2, \infty)$.
20. (a) Since the square root requires $1-x \geq 0$, the domain is $(-\infty, 1]$.
 (b) Since $\sqrt{1-x}$ attains all nonnegative values, the range is $[-2, \infty)$.
21. (a) Since the square root requires $16-x^2 \geq 0$, the domain is $[-4, 4]$.
 (b) For values of x in the domain, $0 \leq 16-x^2 \leq 16$, so $0 \leq \sqrt{16-x^2} \leq 4$. The range is $[0, 4]$.
22. (a) The function is defined for all values of x , so the domain is $(-\infty, \infty)$.
 (b) Since 3^{2-x} attains all positive values, the range is $(1, \infty)$.
23. (a) The function is defined for all values of x , so the domain is $(-\infty, \infty)$.
 (b) Since $2e^{-x}$ attains all positive values, the range is $(-3, \infty)$.
24. (a) The function is equivalent to $y = \tan 2x$, so we require $2x \neq \frac{k\pi}{2}$ for odd integers k . The domain is given by $x \neq \frac{k\pi}{4}$ for odd integers k .
 (b) Since the tangent function attains all values, the range is $(-\infty, \infty)$.
25. (a) The function is defined for all values of x , so the domain is $(-\infty, \infty)$.
 (b) The sine function attains values from -1 to 1 , so $-2 \leq 2 \sin(3x + \pi) \leq 2$ and hence $-3 \leq 2 \sin(3x + \pi) - 1 \leq 1$. The range is $[-3, 1]$.

26. (a) The function is defined for all values of x , so the domain is $(-\infty, \infty)$.
 (b) The function is equivalent to $y = \sqrt[5]{x^2}$, which attains all nonnegative values. The range is $[0, \infty)$.
27. (a) The logarithm requires $x - 3 > 0$, so the domain is $(3, \infty)$.
 (b) The logarithm attains all real values, so the range is $(-\infty, \infty)$.
28. (a) The function is defined for all values of x , so the domain is $(-\infty, \infty)$.
 (b) The cube root attains all real values, so the range is $(-\infty, \infty)$.
29. (a) Increasing because volume increases as radius increases.
 (b) Neither, since the greatest integer function is composed of horizontal (constant) line segments.
 (c) Decreasing because as the height increases, the atmospheric pressure decreases.
 (d) Increasing because the kinetic (motion) energy increases as the particles velocity increases.
30. (a) Increasing on $[2, \infty)$ (b) Increasing on $[-1, \infty)$
 (c) Increasing on $(-\infty, \infty)$ (d) Increasing on $[\frac{1}{2}, \infty)$
31. (a) The function is defined for $-4 \leq x \leq 4$, so the domain is $[-4, 4]$.
 (b) The function is equivalent to $y = \sqrt{|x|}$, $-4 \leq x \leq 4$, which attains values from 0 to 2 for x in the domain. The range is $[0, 2]$.
32. (a) The function is defined for $-2 \leq x \leq 2$, so the domain is $[-2, 2]$.
 (b) The range is $[-1, 1]$.
33. First piece: Line through $(0, 1)$ and $(1, 0)$. $m = \frac{0-1}{1-0} = \frac{-1}{1} = -1 \Rightarrow y = -x + 1 = 1 - x$
 Second piece: Line through $(1, 1)$ and $(2, 0)$. $m = \frac{0-1}{2-1} = \frac{-1}{1} = -1 \Rightarrow y = -(x-1) + 1 = -x + 2 = 2 - x$

$$f(x) = \begin{cases} 1-x, & 0 \leq x < 1 \\ 2-x, & 1 \leq x \leq 2 \end{cases}$$
34. First piece: Line through $(0, 0)$ and $(2, 5)$. $m = \frac{5-0}{2-0} = \frac{5}{2} \Rightarrow y = \frac{5}{2}x$
 Second piece: Line through $(2, 5)$ and $(4, 0)$. $m = \frac{0-5}{4-2} = \frac{-5}{2} = -\frac{5}{2} \Rightarrow y = -\frac{5}{2}(x-2) + 5 = -\frac{5}{2}x + 10 = 10 - \frac{5x}{2}$

$$f(x) = \begin{cases} \frac{5}{2}x, & 0 \leq x < 2 \\ 10 - \frac{5x}{2}, & 2 \leq x \leq 4 \end{cases} \quad (\text{Note: } x = 2 \text{ can be included on either piece.})$$
35. (a) $(f \circ g)(-1) = f(g(-1)) = f\left(\frac{1}{\sqrt{-1+2}}\right) = f(1) = \frac{1}{1} = 1$
 (b) $(g \circ f)(2) = g(f(2)) = g\left(\frac{1}{2}\right) = \frac{1}{\sqrt{\frac{1}{2}+2}} = \frac{1}{\sqrt{2.5}}$ or $\sqrt{\frac{2}{5}}$
 (c) $(f \circ f)(x) = f(f(x)) = f\left(\frac{1}{x}\right) = \frac{1}{1/x} = x, x \neq 0$
 (d) $(g \circ g)(x) = g(g(x)) = g\left(\frac{1}{\sqrt{x+2}}\right) = \frac{1}{\sqrt{\frac{1}{\sqrt{x+2}}+2}} = \frac{\sqrt[4]{x+2}}{\sqrt{1+2\sqrt{x+2}}}$
36. (a) $(f \circ g)(-1) = f(g(-1)) = f\left(\sqrt[3]{-1+1}\right) = f(0) = 2 - 0 = 2$
 (b) $(g \circ f)(2) = f(g(2)) = g(2-2) = g(0) = \sqrt[3]{0+1} = 1$
 (c) $(f \circ f)(x) = f(f(x)) = f(2-x) = 2 - (2-x) = x$
 (d) $(g \circ g)(x) = g(g(x)) = g\left(\sqrt[3]{x+1}\right) = \sqrt[3]{\sqrt[3]{x+1}+1}$

37. (a) $(f \circ g)(x) = f(g(x)) = f(\sqrt{x+2}) = 2 - (\sqrt{x+2})^2 = -x, x \geq -2.$
 $(g \circ f)(x) = g(f(x)) = g(2 - x^2) = \sqrt{(2 - x^2) + 2} = \sqrt{4 - x^2}$

- (b) Domain of $f \circ g$: $[-2, \infty)$.
 Domain of $g \circ f$: $[-2, 2]$.
 (c) Range of $f \circ g$: $(-\infty, 2]$.
 Range of $g \circ f$: $[0, 2]$.

38. (a) $(f \circ g)(x) = f(g(x)) = f(\sqrt{1-x}) = \sqrt{\sqrt{1-x}} = \sqrt[4]{1-x}.$
 $(g \circ f)(x) = g(f(x)) = g(\sqrt{x}) = \sqrt{1-\sqrt{x}}$

- (b) Domain of $f \circ g$: $(-\infty, 1]$.
 Domain of $g \circ f$: $[0, 1]$.
 (c) Range of $f \circ g$: $[0, \infty)$.
 Range of $g \circ f$: $[0, 1]$.

39. $y = f(x)$

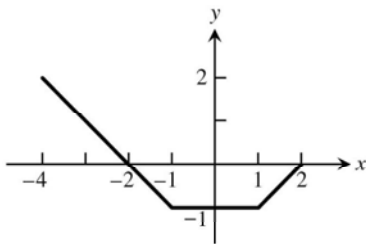

$y = (f \circ f)(x)$

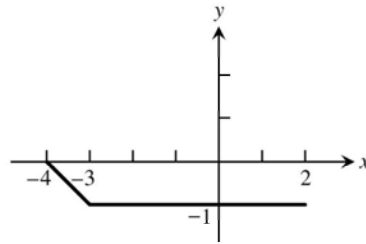

40.

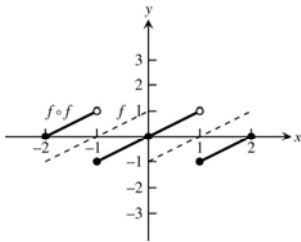

41.

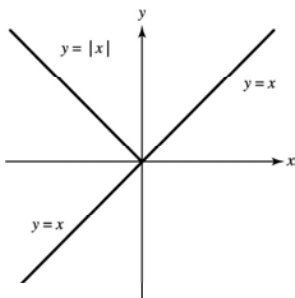

The graph of $f_2(x) = f_1(|x|)$ is the same as the graph of $f_1(x)$ to the right of the y -axis. The graph of $f_2(x)$ to the left of the y -axis is the reflection of $y = f_1(x), x \geq 0$ across the y -axis.

42.

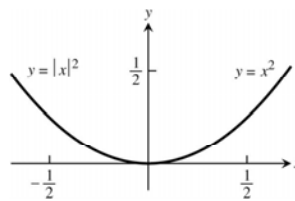

It does not change the graph.

43.

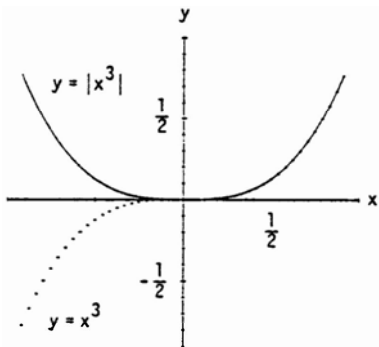

Whenever $g_1(x)$ is positive, the graph of $y = g_2(x) = |g_1(x)|$ is the same as the graph of $y = g_1(x)$. When $g_1(x)$ is negative, the graph of $y = g_2(x)$ is the reflection of the graph of $y = g_1(x)$ across the x -axis.

44.

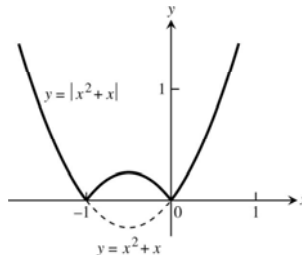

Whenever $g_1(x)$ is positive, the graph of $y = g_2(x) = |g_1(x)|$ is the same as the graph of $y = g_1(x)$. When $g_1(x)$ is negative, the graph of $y = g_2(x)$ is the reflection of the graph of $y = g_1(x)$ across the x -axis.

45.

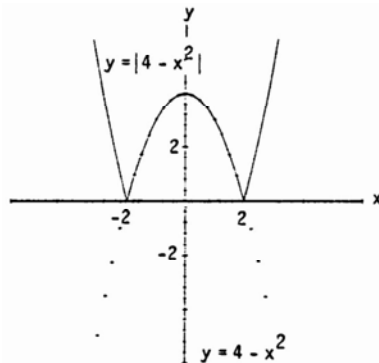

Whenever $g_1(x)$ is positive, the graph of $y = g_2(x) = |g_1(x)|$ is the same as graph of $y = g_1(x)$. When $g_1(x)$ is negative, the graph of $y = g_2(x)$ is the reflection of the graph of $y = g_1(x)$ across the x -axis.

46.

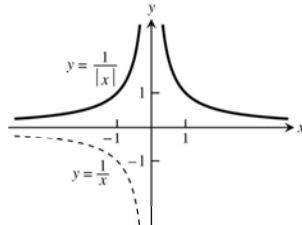

The graph of $f_2(x) = f_1(|x|)$ is the same as the graph of $f_1(x)$ to the right of the y -axis. The graph of $f_2(x)$ to the left of the y -axis is the reflection of $y = f_1(x)$, $x \geq 0$ across the y -axis.

47.

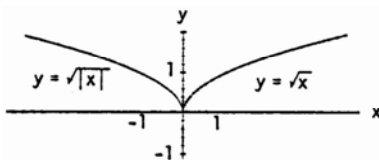

The graph of $f_2(x) = f_1(|x|)$ is the same as the graph of $f_1(x)$ to the right of the y -axis. The graph of $f_2(x)$ to the left of the y -axis is the reflection of $y = f_1(x)$, $x \geq 0$ across the y -axis.

48.

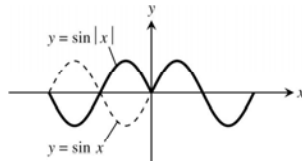

The graph of $f_2(x) = f_1(|x|)$ is the same as the graph of $f_1(x)$ to the right of the y -axis. The graph of $f_2(x)$ to the left of the y -axis is the reflection of $y = f_1(x)$, $x \geq 0$ across the y -axis.

49. (a) $y = g(x-3) + \frac{1}{2}$
 (c) $y = g(-x)$
 (e) $y = 5 \cdot g(x)$

- (b) $y = g\left(x + \frac{2}{3}\right) - 2$
 (d) $y = -g(x)$
 (f) $y = g(5x)$

50. (a) Shift the graph of f right 5 units
 (b) Horizontally compress the graph of f by a factor of 4
 (c) Horizontally compress the graph of f by a factor of 3 and then reflect the graph about the y -axis
 (d) Horizontally compress the graph of f by a factor of 2 and then shift the graph left $\frac{1}{2}$ unit.
 (e) Horizontally stretch the graph of f by a factor of 3 and then shift the graph down 4 units.
 (f) Vertically stretch the graph of f by a factor of 3, then reflect the graph about the x -axis, and finally shift the graph up $\frac{1}{4}$ unit.

51. Reflection of the graph of $y = \sqrt{x}$ about the x -axis followed by a horizontal compression by a factor of $\frac{1}{2}$ then a shift left 2 units.

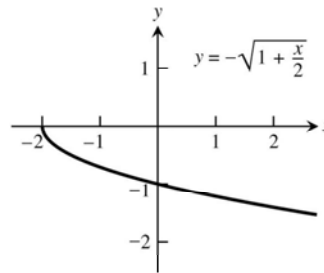

52. Reflect the graph of $y = x$ about the x -axis, followed by a vertical compression of the graph by a factor of 3, then shift the graph up 1 unit.

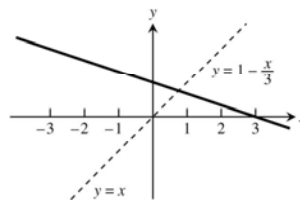

53. Vertical compression of the graph of $y = \frac{1}{x^2}$ by a factor of 2, then shift the graph up 1 unit.

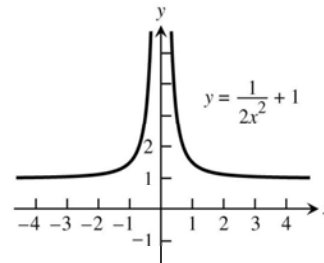

54. Reflect the graph of $y = x^{1/3}$ about the y -axis, then compress the graph horizontally by a factor of 5.

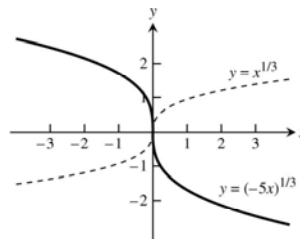

55.

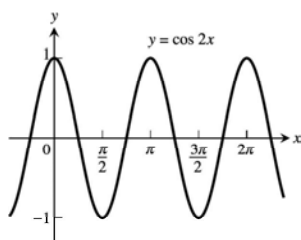

period = π

56.

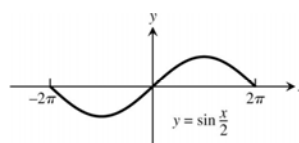

period = 4π

57.

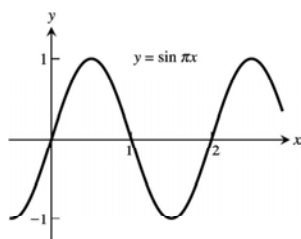

period = 2

58.

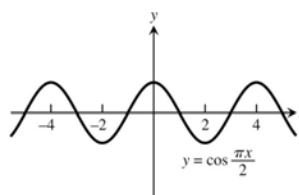

period = 4

59.

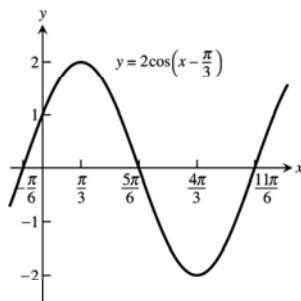

period = 2π

60.

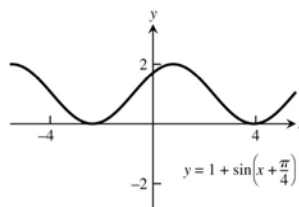

period = 2π

61. (a) $\sin B = \sin \frac{\pi}{3} = \frac{b}{c} = \frac{b}{2} \Rightarrow b = 2 \sin \frac{\pi}{3} = 2 \left(\frac{\sqrt{3}}{2} \right) = \sqrt{3}$. By the theorem of Pythagoras,
 $a^2 + b^2 = c^2 \Rightarrow a = \sqrt{c^2 - b^2} = \sqrt{4 - 3} = 1$.

(b) $\sin B = \sin \frac{\pi}{3} = \frac{b}{c} = \frac{2}{c} \Rightarrow c = \frac{2}{\sin \frac{\pi}{3}} = \frac{2}{\left(\frac{\sqrt{3}}{2} \right)} = \frac{4}{\sqrt{3}}$. Thus, $a = \sqrt{c^2 - b^2} = \sqrt{\left(\frac{4}{\sqrt{3}} \right)^2 - (2)^2} = \sqrt{\frac{16}{3} - 4} = \sqrt{\frac{4}{3}} = \frac{2}{\sqrt{3}}$.

62. (a) $\sin A = \frac{a}{c} \Rightarrow a = c \sin A$

(b) $\tan A = \frac{a}{b} \Rightarrow a = b \tan A$

63. (a) $\tan B = \frac{b}{a} \Rightarrow a = \frac{b}{\tan B}$

(b) $\sin A = \frac{a}{c} \Rightarrow c = \frac{a}{\sin A}$

64. (a) $\sin A = \frac{a}{c}$

(b) $\sin A = \frac{a}{c} = \frac{\sqrt{c^2 - b^2}}{c}$

65. Let h = height of vertical pole, and let b and c denote the distances of points B and C from the base of the pole, measured along the flat ground, respectively. Then, $\tan 50^\circ = \frac{h}{c}$, $\tan 35^\circ = \frac{h}{b}$, and $b - c = 10$. Thus, $h = c \tan 50^\circ$ and $h = b \tan 35^\circ = (c + 10) \tan 35^\circ$
 $\Rightarrow c \tan 50^\circ = (c + 10) \tan 35^\circ$
 $\Rightarrow c(\tan 50^\circ - \tan 35^\circ) = 10 \tan 35^\circ$
 $\Rightarrow c = \frac{10 \tan 35^\circ}{\tan 50^\circ - \tan 35^\circ} \Rightarrow h = c \tan 50^\circ$
 $= \frac{10 \tan 35^\circ \tan 50^\circ}{\tan 50^\circ - \tan 35^\circ} \approx 16.98 \text{ m.}$

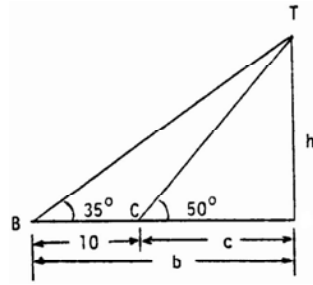

66. Let h = height of balloon above ground. From the figure at the right, $\tan 40^\circ = \frac{h}{a}$, $\tan 70^\circ = \frac{h}{b}$, and $a + b = 2$. Thus, $h = b \tan 70^\circ \Rightarrow h = (2 - a) \tan 70^\circ$ and $h = a \tan 40^\circ \Rightarrow (2 - a) \tan 70^\circ = a \tan 40^\circ$
 $\Rightarrow a(\tan 40^\circ + \tan 70^\circ) = 2 \tan 70^\circ$
 $\Rightarrow a = \frac{2 \tan 70^\circ}{\tan 40^\circ + \tan 70^\circ} \Rightarrow h = a \tan 40^\circ$
 $= \frac{2 \tan 70^\circ \tan 40^\circ}{\tan 40^\circ + \tan 70^\circ} \approx 1.3 \text{ km.}$

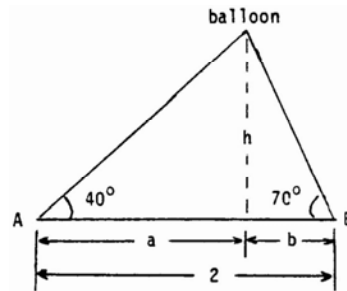

67. (a)

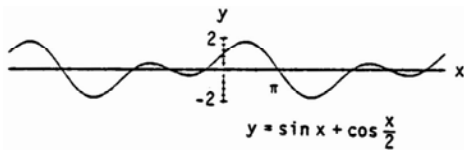

- (b) The period appears to be 4π .
 (c) $f(x + 4\pi) = \sin(x + 4\pi) + \cos\left(\frac{x + 4\pi}{2}\right) = \sin(x + 2\pi) + \cos\left(\frac{x}{2} + 2\pi\right) = \sin x + \cos \frac{x}{2}$
 since the period of sine and cosine is 2π . Thus, $f(x)$ has period 4π .

68. (a)

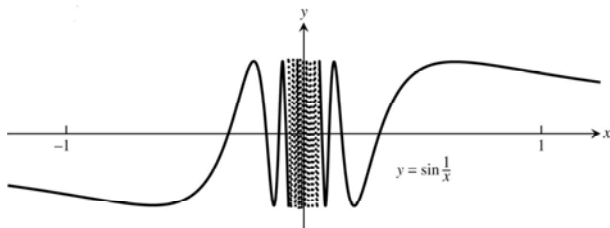

- (b) $D = (-\infty, 0) \cup (0, \infty); R = [-1, 1]$
 (c) f is not periodic. For suppose f has period p . Then $f\left(\frac{1}{2\pi} + kp\right) = f\left(\frac{1}{2\pi}\right) = \sin 2\pi = 0$ for all integers k .
 Choose k so large that $\frac{1}{2\pi} + kp > \frac{1}{\pi} \Rightarrow 0 < \frac{1}{(1/(2\pi)) + kp} < \pi$. But then $f\left(\frac{1}{2\pi} + kp\right) = \sin\left(\frac{1}{(1/(2\pi)) + kp}\right) > 0$
 which is a contradiction. Thus f has no period, as claimed.

69. (a) $D: -\infty < x < \infty$
 (b) $D: x > 0$

70. (a) $D = (-\infty, 0) \cup (0, \infty)$

(b) $D = (-\infty, -2) \cup (-2, 2) \cup (2, \infty)$

71. (a) $D: -3 \leq x \leq 3$

(b) $D: 0 \leq x \leq 4$

72. (a) $D = [-1, 1]$

(b) $D = [-1, 1]$

73. $(f \circ g)(x) = \ln(4 - x^2)$ and domain: $-2 < x < 2$;

$(g \circ f)(x) = 4 - (\ln x)^2$ and domain: $x > 0$;

$(f \circ f)(x) = \ln(\ln x)$ and domain: $x > 1$;

$(g \circ g)(x) = -x^4 + 8x^2 - 12$ and domain: $-\infty < x < \infty$.

74. (a) Even (b) Neither even nor odd (c) Neither even nor odd (d) Even

76. For $c > 0$, $D = (-\infty, \infty)$

For $c \leq 0$, $D = (-\infty, -\sqrt{c}) \cup (\sqrt{c}, \infty)$

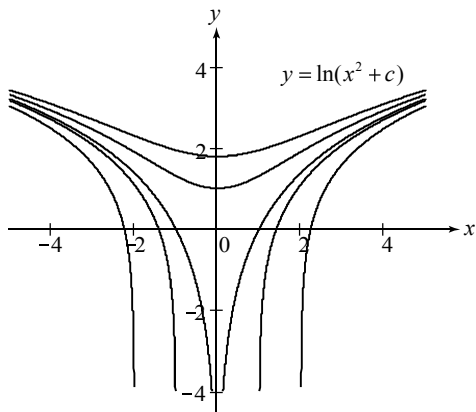

78. For large values of x , $y = a^x$ has the largest values; $y = \log_a x$ has the smallest.

79. (a) $D: (-\infty, \infty)$ $R: \left[-\frac{\pi}{2}, \frac{\pi}{2}\right]$

(b) $D: [-1, 1]$ $R: [-1, 1]$

80. (a) $D: -\infty < x < \infty$; $R: 0 \leq y \leq \pi$

(b) $D: -1 \leq x \leq 1$; $R: -1 \leq y \leq 1$

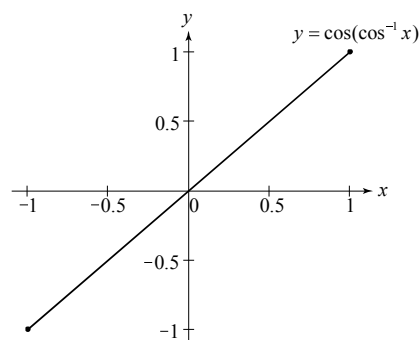
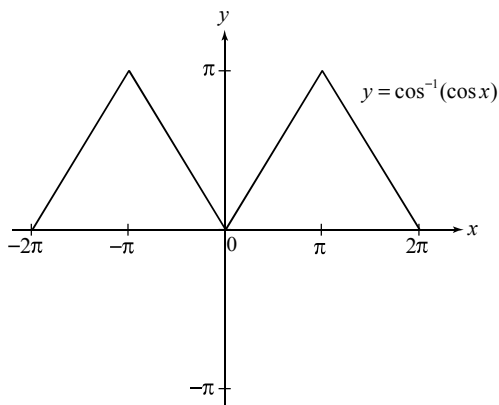

81. (a) No (b) Yes

82. Answers depend on the view screen used. For $[15, 17] \times [5 \cdot 10^6, 10^7]$ it appears that $e^x > 10^7$ for $x \geq 16.128$.83. (a) $f(g(x)) = (\sqrt[3]{x})^3 = x$, $g(f(x)) = \sqrt[3]{x^3} = x$

(b)

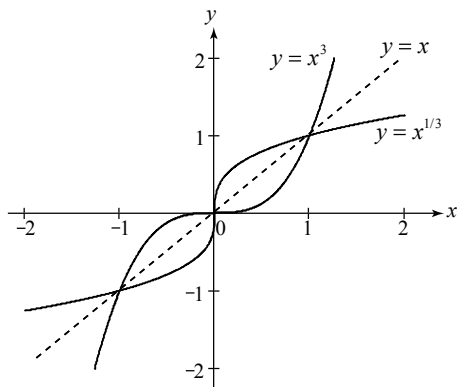
84. (a) $h(k(x)) = \frac{1}{4}((4x)^{1/3})^3 = x$, $k(h(x)) = \left(4 \cdot \frac{x^3}{4}\right)^{1/3} = x$

(b)

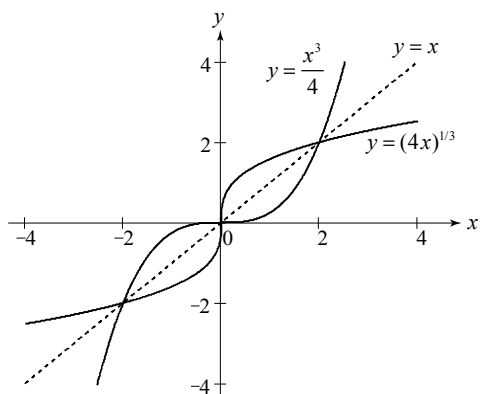
**CHAPTER 1 ADDITIONAL AND ADVANCED EXERCISES**

- There are (infinitely) many such function pairs. For example, $f(x) = 3x$ and $g(x) = 4x$ satisfy $f(g(x)) = f(4x) = 3(4x) = 12x = 4(3x) = g(3x) = g(f(x))$.
- Yes, there are many such function pairs. For example, if $g(x) = (2x + 3)^3$ and $f(x) = x^{1/3}$, then $(f \circ g)(x) = f(g(x)) = f((2x + 3)^3) = ((2x + 3)^3)^{1/3} = 2x + 3$.
- If f is odd and defined at x , then $f(-x) = -f(x)$. Thus $g(-x) = f(-x) - 2 = -f(x) - 2$ whereas $-g(x) = -(f(x) - 2) = -f(x) + 2$. Then g cannot be odd because $g(-x) = -g(x) \Rightarrow -f(x) - 2 = -f(x) + 2 \Rightarrow 4 = 0$, which is a contradiction. Also, $g(x)$ is not even unless $f(x) = 0$ for all x . On the other hand, if f is even, then $g(x) = f(x) - 2$ is also even: $g(-x) = f(-x) - 2 = f(x) - 2 = g(x)$.
- If g is odd and $g(0)$ is defined, then $g(0) = g(-0) = -g(0)$. Therefore, $2g(0) = 0 \Rightarrow g(0) = 0$.

5. For (x, y) in the 1st quadrant, $|x| + |y| = 1 + x$
 $\Leftrightarrow x + y = 1 + x \Leftrightarrow y = 1$. For (x, y) in the 2nd quadrant, $|x| + |y| = x + 1 \Leftrightarrow -x + y = x + 1$
 $\Leftrightarrow y = 2x + 1$. In the 3rd quadrant, $|x| + |y| = x + 1$
 $\Leftrightarrow -x - y = x + 1 \Leftrightarrow y = -2x - 1$. In the 4th quadrant, $|x| + |y| = x + 1 \Leftrightarrow x + (-y) = x + 1$
 $\Leftrightarrow y = -1$. The graph is given at the right.

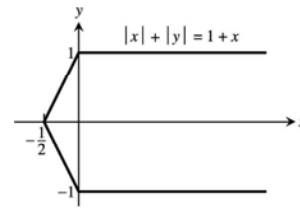

6. We use reasoning similar to Exercise 5.

- (1) 1st quadrant: $y + |y| = x + |x|$
 $\Leftrightarrow 2y = 2x \Leftrightarrow y = x$.
 (2) 2nd quadrant: $y + |y| = x + |x|$
 $\Leftrightarrow 2y = x + (-x) = 0 \Leftrightarrow y = 0$.
 (3) 3rd quadrant: $y + |y| = x + |x|$
 $\Leftrightarrow y + (-y) = x + (-x) \Leftrightarrow 0 = 0$
 \Rightarrow all points in the 3rd quadrant satisfy the equation.
 (4) 4th quadrant: $y + |y| = x + |x|$
 $\Leftrightarrow y + (-y) = 2x \Leftrightarrow 0 = x$. Combining these results we have the graph given at the right:

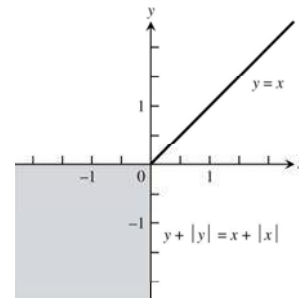

7. (a) $\sin^2 x + \cos^2 x = 1 \Rightarrow \sin^2 x = 1 - \cos^2 x = (1 - \cos x)(1 + \cos x) \Rightarrow (1 - \cos x) = \frac{\sin^2 x}{1 + \cos x} \Rightarrow \frac{1 - \cos x}{\sin x} = \frac{\sin x}{1 + \cos x}$
 (b) Using the definition of the tangent function and the double angle formulas, we have

$$\tan^2\left(\frac{x}{2}\right) = \frac{\sin^2\left(\frac{x}{2}\right)}{\cos^2\left(\frac{x}{2}\right)} = \frac{\frac{1 - \cos\left(2\left(\frac{x}{2}\right)\right)}{2}}{\frac{1 + \cos\left(2\left(\frac{x}{2}\right)\right)}{2}} = \frac{1 - \cos x}{1 + \cos x}$$

8. The angles labeled γ in the accompanying figure are equal since both angles subtend arc CD . Similarly, the two angles labeled α are equal since they both subtend arc AB . Thus, triangles AED and BEC are similar which implies $\frac{a - c}{b} = \frac{2a \cos \theta - b}{a + c}$

$$\begin{aligned} \Rightarrow (a - c)(a + c) &= b(2a \cos \theta - b) \\ \Rightarrow a^2 - c^2 &= 2ab \cos \theta - b^2 \\ \Rightarrow c^2 - a^2 + b^2 &= 2ab \cos \theta. \end{aligned}$$

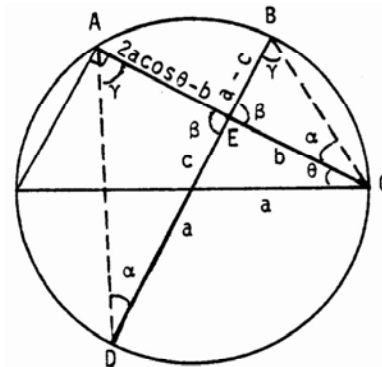

9. As in the proof of the law of sines of Section 1.3, Exercise 61, $ah = bc \sin A = ab \sin C = ac \sin B$
 \Rightarrow the area of $ABC = \frac{1}{2}(\text{base})(\text{height}) = \frac{1}{2}ah = \frac{1}{2}bc \sin A = \frac{1}{2}ab \sin C = \frac{1}{2}ac \sin B$.

10. As in Section 1.3, Exercise 61, $(\text{Area of } ABC)^2 = \frac{1}{4}(\text{base})^2(\text{height})^2 = \frac{1}{4}a^2h^2 = \frac{1}{4}a^2b^2 \sin^2 C$
 $= \frac{1}{4}a^2b^2(1 - \cos^2 C)$. By the law of cosines, $c^2 = a^2 + b^2 - 2ab \cos C \Rightarrow \cos C = \frac{a^2 + b^2 - c^2}{2ab}$. Thus,

$$\begin{aligned} (\text{area of } ABC)^2 &= \frac{1}{4}a^2b^2(1 - \cos^2 C) = \frac{1}{4}a^2b^2 \left(1 - \left(\frac{a^2 + b^2 - c^2}{2ab}\right)^2\right) = \frac{a^2b^2}{4} \left(1 - \frac{(a^2 + b^2 - c^2)^2}{4a^2b^2}\right) \\ &= \frac{1}{16} \left(4a^2b^2 - (a^2 + b^2 - c^2)^2\right) = \frac{1}{16} [(2ab + (a^2 + b^2 - c^2))(2ab - (a^2 + b^2 - c^2))] \\ &= \frac{1}{16} [((a + b)^2 - c^2)(c^2 - (a - b)^2)] = \frac{1}{16} [(a + b + c)((a + b) - c)(c + (a - b))(c - (a - b))] \\ &= \left[\left(\frac{a + b + c}{2}\right)\left(\frac{-a + b + c}{2}\right)\left(\frac{a - b + c}{2}\right)\left(\frac{a + b - c}{2}\right)\right] = s(s - a)(s - b)(s - c), \text{ where } s = \frac{a + b + c}{2}. \end{aligned}$$

Therefore, the area of ABC equals $\sqrt{s(s - a)(s - b)(s - c)}$.

11. If f is even and odd, then $f(-x) = -f(x)$ and $f(-x) = f(x) \Rightarrow f(x) = -f(x)$ for all x in the domain of f . Thus $2f(x) = 0 \Rightarrow f(x) = 0$.
12. (a) As suggested, let $E(x) = \frac{f(x) + f(-x)}{2} \Rightarrow E(-x) = \frac{f(-x) + f(-(-x))}{2} = \frac{f(-x) + f(x)}{2} = E(x) \Rightarrow E$ is an even function. Define $O(x) = f(x) - E(x) = f(x) - \frac{f(x) + f(-x)}{2} = \frac{f(x) - f(-x)}{2}$. Then $O(-x) = \frac{f(-x) - f(-(-x))}{2} = \frac{f(-x) - f(x)}{2} = -\left(\frac{f(x) - f(-x)}{2}\right) = -O(x) \Rightarrow O$ is an odd function $\Rightarrow f(x) = E(x) + O(x)$ is the sum of an even and an odd function.
- (b) Part (a) shows that $f(x) = E(x) + O(x)$ is the sum of an even and an odd function. If also $f(x) = E_1(x) + O_1(x)$, where E_1 is even and O_1 is odd, then $f(x) - f(x) = 0 = (E_1(x) + O_1(x)) - (E(x) + O(x))$. Thus, $E(x) - E_1(x) = O_1(x) - O(x)$ for all x in the domain of f (which is the same as the domain of $E - E_1$ and $O - O_1$). Now $(E - E_1)(-x) = E(-x) - E_1(-x) = E(x) - E_1(x)$ (since E and E_1 are even) $= (E - E_1)(x) \Rightarrow E - E_1$ is even. Likewise, $(O_1 - O)(-x) = O_1(-x) - O(-x) = -O_1(x) - (-O(x)) = -(O_1(x) - O(x)) = -(O_1 - O)(x) \Rightarrow O_1 - O$ is odd. Therefore, $E - E_1$ and $O_1 - O$ are both even and odd so they must be zero at each x in the domain of f by Exercise 11. That is, $E_1 = E$ and $O_1 = O$, so the decomposition of f found in part (a) is unique.
13. $y = ax^2 + bx + c = a\left(x^2 + \frac{b}{a}x + \frac{b^2}{4a^2}\right) - \frac{b^2}{4a} + c = a\left(x + \frac{b}{2a}\right)^2 - \frac{b^2}{4a} + c$
- (a) If $a > 0$ the graph is a parabola that opens upward. Increasing a causes a vertical stretching and a shift of the vertex toward the y -axis and upward. If $a < 0$ the graph is a parabola that opens downward. Decreasing a causes a vertical stretching and a shift of the vertex toward the y -axis and downward.
- (b) If $a > 0$ the graph is a parabola that opens upward. If also $b > 0$, then increasing b causes a shift of the graph downward to the left; if $b < 0$, then decreasing b causes a shift of the graph downward and to the right. If $a < 0$ the graph is a parabola that opens downward. If $b > 0$, increasing b shifts the graph upward to the right. If $b < 0$, decreasing b shifts the graph upward to the left.
- (c) Changing c (for fixed a and b) by Δc shifts the graph upward Δc units if $\Delta c > 0$, and downward $-\Delta c$ units if $\Delta c < 0$.
14. (a) If $a > 0$, the graph rises to the right of the vertical line $x = -b$ and falls to the left. If $a < 0$, the graph falls to the right of the line $x = -b$ and rises to the left. If $a = 0$, the graph reduces to the horizontal line $y = c$. As $|a|$ increases, the slope at any given point $x = x_0$ increases in magnitude and the graph becomes steeper. As $|a|$ decreases, the slope at x_0 decreases in magnitude and the graph rises or falls more gradually.
- (b) Increasing b shifts the graph to the left; decreasing b shifts it to the right.
- (c) Increasing c shifts the graph upward; decreasing c shifts it downward.

15. Each of the triangles pictured has the same base $b = v\Delta t = v(1 \text{ sec})$. Moreover, the height of each triangle is the same value h . Thus $\frac{1}{2}(\text{base})(\text{height}) = \frac{1}{2}bh = A_1 = A_2 = A_3 = \dots$. In conclusion, the object sweeps out equal areas in each one second interval.

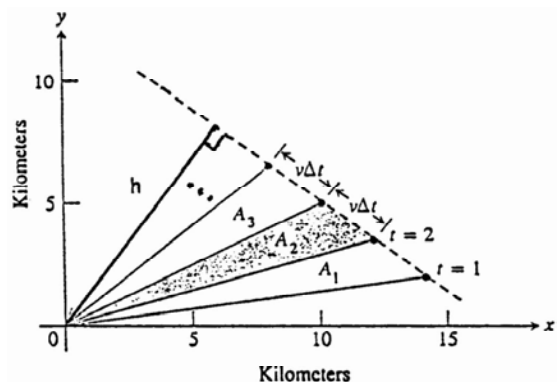

16. (a) Using the midpoint formula, the coordinates of P are $\left(\frac{a+0}{2}, \frac{b+0}{2}\right) = \left(\frac{a}{2}, \frac{b}{2}\right)$. Thus the slope of $\overline{OP} = \frac{\Delta y}{\Delta x} = \frac{b/2}{a/2} = \frac{b}{a}$.
- (b) The slope of $\overline{AB} = \frac{b-0}{0-a} = -\frac{b}{a}$. The line segments \overline{AB} and \overline{OP} are perpendicular when the product of their slopes is $-1 = \left(\frac{b}{a}\right)\left(-\frac{b}{a}\right) = -\frac{b^2}{a^2}$. Thus, $b^2 = a^2 \Rightarrow a = b$ (since both are positive). Therefore, \overline{AB} is perpendicular to \overline{OP} when $a = b$.

17. From the figure we see that $0 \leq \theta \leq \frac{\pi}{2}$ and $AB = AD = 1$. From trigonometry we have the following:

$$\sin \theta = \frac{EB}{AB} = EB, \cos \theta = \frac{AE}{AB} = AE, \tan \theta = \frac{CD}{AD} = CD, \text{ and } \tan \theta = \frac{EB}{AE} = \frac{\sin \theta}{\cos \theta}. \text{ We can see that:}$$

$$\text{area } \triangle AEB < \text{area sector } \overline{DB} < \text{area } \triangle ADC \Rightarrow \frac{1}{2}(AE)(EB) < \frac{1}{2}(AD)^2 \theta < \frac{1}{2}(AD)(CD)$$

$$\Rightarrow \frac{1}{2} \sin \theta \cos \theta < \frac{1}{2} (1)^2 \theta < \frac{1}{2} (1)(\tan \theta) \Rightarrow \frac{1}{2} \sin \theta \cos \theta < \frac{1}{2} \theta < \frac{1}{2} \frac{\sin \theta}{\cos \theta}$$

18. $(f \circ g)(x) = f(g(x)) = a(cx+d) + b = acx + ad + b$ and $(g \circ f)(x) = g(f(x)) = c(ax+b) + d = acx + cb + d$
Thus $(f \circ g)(x) = (g \circ f)(x) \Rightarrow acx + ad + b = acx + bc + d \Rightarrow ad + b = bc + d$. Note that $f(d) = ad + b$ and $g(b) = cb + d$, thus $(f \circ g)(x) = (g \circ f)(x)$ if $f(d) = g(b)$.

19. (a) The expression $a(b^{c-x}) + d$ is defined for all values of x , so the domain is $(-\infty, \infty)$. Since b^{c-x} attains all positive values, the range is (d, ∞) if $a > 0$ and the range is $(-\infty, d)$ if $a < 0$.
- (b) The expression $a \log_b(x-c) + d$ is defined when $x-c > 0$, so the domain is (c, ∞) . Since $a \log_b(x-c) + d$ attains every real value for some value of x , the range is $(-\infty, \infty)$.

20. (a) Suppose $f(x_1) = f(x_2)$. Then:

$$\frac{ax_1+b}{cx_1+d} = \frac{ax_2+b}{cx_2+d}$$

$$(ax_1+b)(cx_2+d) = (ax_2+b)(cx_1+d)$$

$$acx_1x_2 + adx_1 + bcx_2 + bd = acx_1x_2 + adx_2 + bcx_1 + bd$$

$$adx_1 + bcx_2 = adx_2 + bcx_1$$

$$(ad-bc)x_1 = (ad-bc)x_2$$

Since $ad - bc \neq 0$, this means that $x_1 = x_2$.

- (b) $y = \frac{ax+b}{cx+d}$
 $cx + dy = ax + b$
 $(cy - a)x = -dy + b$
 $x = \frac{-dy+b}{cy-a}$

Interchange x and y .

$$y = \frac{-dx+b}{cx-a}$$

$$f^{-1}(x) = \frac{-dx+b}{cx-a}$$

21. (a) $y = 100,000 - 10,000x, 0 \leq x \leq 10$

(b) $y = 55,000$

$100,000 - 10,000x = 55,000$

$-10,000x = 55,000$

$x = 4.5$

The value is \$55,000 after 4.5 years.

22. (a) $f(0) = 90$ units

(b) $f(2) = 90 - 52 \ln 3 \approx 32.8722$ units

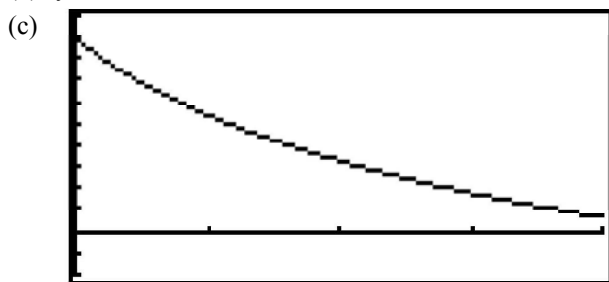

$[0, 4]$ by $[-20, 100]$

23. $1500(1.08)^t = 5000 \rightarrow 1.08^t = \frac{5000}{1500} = \frac{10}{3} \rightarrow \ln(1.08)^t = \ln \frac{10}{3} \rightarrow t \ln 1.08 = \ln \frac{10}{3} \rightarrow t = \frac{\ln(10/3)}{\ln 1.08} \approx 15.6439$

It will take about 15.6439 years. (If the bank only pays interest at the end of the year, it will take 16 years.)

24. $A(t) = A_0 e^{rt}; A(t) = 2A_0 \Rightarrow 2A_0 = A_0 e^{rt} \Rightarrow e^{rt} = 2 \Rightarrow rt = \ln 2 \Rightarrow t = \frac{\ln 2}{r} \Rightarrow t \approx \frac{0.7}{r} = \frac{70}{100r} = \frac{70}{(r\%)}$

25. $\ln x^{(x^x)} = x^x \ln x$ and $\ln(x^x)^x = x \ln(x^x) = x^2 \ln x$; then, $x^x \ln x = x^2 \ln x \Rightarrow x^x = x^2 \Rightarrow x \ln x = 2 \ln x \Rightarrow x = 2$.

Therefore, $x^{(x^x)} = (x^x)^x$ when $x = 2$.

26. (a) No, there are two intersections: one at $x = 2$ and the other at $x = 4$.

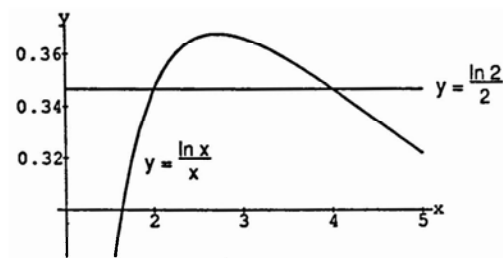

(b) Yes, because there is only one intersection.

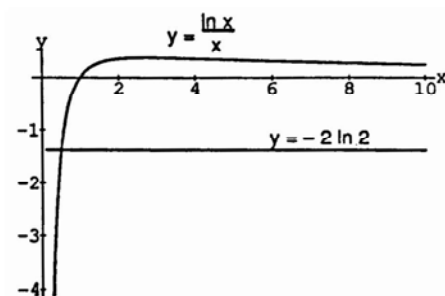

27. $\frac{\log_4 x}{\log_2 x} = \frac{\left(\frac{\ln x}{\ln 4}\right)}{\left(\frac{\ln x}{\ln 2}\right)} = \frac{\ln x}{\ln 4} \cdot \frac{\ln 2}{\ln x} = \frac{\ln 2}{\ln 4} = \frac{\ln 2}{2 \ln 2} = \frac{1}{2}$

28. (a) $f(x) = \frac{\ln 2}{\ln x}, g(x) = \frac{\ln x}{\ln 2}$

(b) f is negative when g is negative, positive when g is positive, and undefined when $g = 0$; the values of f decrease as those of g increase.

(c) $\frac{\ln 2}{\ln x} = \frac{\ln x}{\ln 2} \Rightarrow (\ln 2)^2 = (\ln x)^2$
 $\Rightarrow (\ln 2 \ln x)(\ln 2 + \ln x) = 0 \Rightarrow \ln x = \ln 2$
 or $\ln x = -\ln 2 \Rightarrow e^{\ln x} = e^{\ln 2}$ or
 $e^{\ln x} = e^{\ln(1/2)} \Rightarrow x = 2$ or $x = \frac{1}{2}$.

Therefore, the two curves cross at the two points $\left(\frac{1}{2}, \frac{\ln(1/2)}{\ln 2}\right) = \left(\frac{1}{2}, -1\right)$ and $\left(2, \frac{\ln 2}{\ln 2}\right) = (2, 1)$.

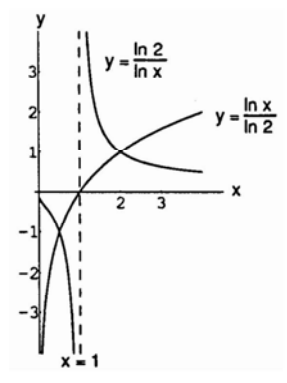

CHAPTER 2 LIMITS AND CONTINUITY

2.1 RATES OF CHANGE AND TANGENTS TO CURVES

1. (a) $\frac{\Delta f}{\Delta x} = \frac{f(3)-f(2)}{3-2} = \frac{28-9}{1} = 19$ (b) $\frac{\Delta f}{\Delta x} = \frac{f(1)-f(-1)}{1-(-1)} = \frac{2-0}{2} = 1$
2. (a) $\frac{\Delta g}{\Delta x} = \frac{g(3)-g(1)}{3-1} = \frac{3-(-1)}{2} = 2$ (b) $\frac{\Delta g}{\Delta x} = \frac{g(4)-g(-2)}{4-(-2)} = \frac{8-8}{6} = 0$
3. (a) $\frac{\Delta h}{\Delta t} = \frac{h(\frac{3\pi}{4})-h(\frac{\pi}{4})}{\frac{3\pi}{4}-\frac{\pi}{4}} = \frac{-1-1}{\frac{\pi}{2}} = -\frac{4}{\pi}$ (b) $\frac{\Delta h}{\Delta t} = \frac{h(\frac{\pi}{2})-h(\frac{\pi}{6})}{\frac{\pi}{2}-\frac{\pi}{6}} = \frac{0-\sqrt{3}}{\frac{\pi}{3}} = \frac{-3\sqrt{3}}{\pi}$
4. (a) $\frac{\Delta g}{\Delta t} = \frac{g(\pi)-g(0)}{\pi-0} = \frac{(2-1)-(2+1)}{\pi-0} = -\frac{2}{\pi}$ (b) $\frac{\Delta g}{\Delta t} = \frac{g(\pi)-g(-\pi)}{\pi-(-\pi)} = \frac{(2-1)-(2-1)}{2\pi} = 0$
5. $\frac{\Delta R}{\Delta \theta} = \frac{R(2)-R(0)}{2-0} = \frac{\sqrt{8+1}-\sqrt{1}}{2} = \frac{3-1}{2} = 1$
6. $\frac{\Delta P}{\Delta \theta} = \frac{P(2)-P(1)}{2-1} = \frac{(8-16+10)-(1-4+5)}{1} = 2-2 = 0$
7. (a) $\frac{\Delta y}{\Delta x} = \frac{((2+h)^2-5)-(2^2-5)}{h} = \frac{4+4h+h^2-5+1}{h} = \frac{4h+h^2}{h} = 4+h$. As $h \rightarrow 0$, $4+h \rightarrow 4 \Rightarrow$ at $P(2, -1)$ the slope is 4.
(b) $y - (-1) = 4(x - 2) \Rightarrow y + 1 = 4x - 8 \Rightarrow y = 4x - 9$
8. (a) $\frac{\Delta y}{\Delta x} = \frac{(7-(2+h)^2)-(7-2^2)}{h} = \frac{7-4-4h-h^2-3}{h} = \frac{-4h-h^2}{h} = -4-h$. As $h \rightarrow 0$, $-4-h \rightarrow -4 \Rightarrow$ at $P(2, 3)$ the slope is -4 .
(b) $y - 3 = (-4)(x - 2) \Rightarrow y - 3 = -4x + 8 \Rightarrow y = -4x + 11$
9. (a) $\frac{\Delta y}{\Delta x} = \frac{((2+h)^2-2(2+h)-3)-(2^2-2(2)-3)}{h} = \frac{4+4h+h^2-4-2h-3-(-3)}{h} = \frac{2h+h^2}{h} = 2+h$. As $h \rightarrow 0$, $2+h \rightarrow 2 \Rightarrow$ at $P(2, -3)$ the slope is 2.
(b) $y - (-3) = 2(x - 2) \Rightarrow y + 3 = 2x - 4 \Rightarrow y = 2x - 7$.
10. (a) $\frac{\Delta y}{\Delta x} = \frac{((1+h)^2-4(1+h))-(1^2-4(1))}{h} = \frac{1+2h+h^2-4-4h-(-3)}{h} = \frac{h^2-2h}{h} = h-2$. As $h \rightarrow 0$, $h-2 \rightarrow -2 \Rightarrow$ at $P(1, -3)$ the slope is -2 .
(b) $y - (-3) = (-2)(x - 1) \Rightarrow y + 3 = -2x + 2 \Rightarrow y = -2x - 1$.
11. (a) $\frac{\Delta y}{\Delta x} = \frac{(2+h)^3-2^3}{h} = \frac{8+12h+4h^2+h^3-8}{h} = \frac{12h+4h^2+h^3}{h} = 12+4h+h^2$. As $h \rightarrow 0$, $12+4h+h^2 \rightarrow 12$, \Rightarrow at $P(2, 8)$ the slope is 12.
(b) $y - 8 = 12(x - 2) \Rightarrow y - 8 = 12x - 24 \Rightarrow y = 12x - 16$.
12. (a) $\frac{\Delta y}{\Delta x} = \frac{2-(1+h)^3-(-2-1^3)}{h} = \frac{2-1-3h-3h^2-h^3-1}{h} = \frac{-3h-3h^2-h^3}{h} = -3-3h-h^2$. As $h \rightarrow 0$, $-3-3h-h^2 \rightarrow -3$, \Rightarrow at $P(1, 1)$ the slope is -3 .
(b) $y - 1 = (-3)(x - 1) \Rightarrow y - 1 = -3x + 3 \Rightarrow y = -3x + 4$.

13. (a) $\frac{\Delta y}{\Delta x} = \frac{(1+h)^3 - 12(1+h) - (1^3 - 12(1))}{h} = \frac{1+3h+3h^2+h^3-12-12h-(-11)}{h} = \frac{-9h+3h^2+h^3}{h} = -9+3h+h^2$.
As $h \rightarrow 0$, $-9+3h+h^2 \rightarrow -9 \Rightarrow$ at $P(1, -11)$ the slope is -9 .
(b) $y - (-11) = (-9)(x - 1) \Rightarrow y + 11 = -9x + 9 \Rightarrow y = -9x - 2$.
14. (a) $\frac{\Delta y}{\Delta x} = \frac{(2+h)^3 - 3(2+h)^2 + 4 - (2^3 - 3(2)^2 + 4)}{h} = \frac{8+12h+6h^2+h^3-12-12h-3h^2+4-0}{h} = \frac{3h^2+h^3}{h} = 3h+h^2$.
As $h \rightarrow 0$, $3h+h^2 \rightarrow 0 \Rightarrow$ at $P(2, 0)$ the slope is 0 .
(b) $y - 0 = 0(x - 2) \Rightarrow y = 0$.

15. (a)
- | Q | Slope of $PQ = \frac{\Delta p}{\Delta t}$ |
|------------------|---|
| $Q_1(10, 225)$ | $\frac{650-225}{20-10} = 42.5$ m/sec |
| $Q_2(14, 375)$ | $\frac{650-375}{20-14} = 45.83$ m/sec |
| $Q_3(16.5, 475)$ | $\frac{650-475}{20-16.5} = 50.00$ m/sec |
| $Q_4(18, 550)$ | $\frac{650-550}{20-18} = 50.00$ m/sec |
- (b) At $t = 20$, the sportscar was traveling approximately 50 m/sec or 180 km/h.

16. (a)
- | Q | Slope of $PQ = \frac{\Delta p}{\Delta t}$ |
|----------------|---|
| $Q_1(5, 20)$ | $\frac{80-20}{10-5} = 12$ m/sec |
| $Q_2(7, 39)$ | $\frac{80-39}{10-7} = 13.7$ m/sec |
| $Q_3(8.5, 58)$ | $\frac{80-58}{10-8.5} = 14.7$ m/sec |
| $Q_4(9.5, 72)$ | $\frac{80-72}{10-9.5} = 16$ m/sec |
- (b) Approximately 16 m/sec

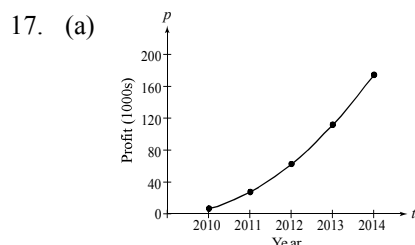

- (b) $\frac{\Delta p}{\Delta t} = \frac{174-62}{2014-2012} = \frac{112}{2} = 56$ thousand dollars per year
- (c) The average rate of change from 2011 to 2012 is $\frac{\Delta p}{\Delta t} = \frac{62-27}{2012-2011} = 35$ thousand dollars per year.
The average rate of change from 2012 to 2013 is $\frac{\Delta p}{\Delta t} = \frac{111-62}{2013-2012} = 49$ thousand dollars per year.
So, the rate at which profits were changing in 2012 is approximately $\frac{1}{2}(35+49) = 42$ thousand dollars per year.
18. (a)
- | x | 1.2 | 1.1 | 1.01 | 1.001 | 1.0001 | 1 |
|--------|------|------|-------|--------|---------|----|
| $F(x)$ | -4.0 | -3.4 | -3.04 | -3.004 | -3.0004 | -3 |
- $\frac{\Delta F}{\Delta x} = \frac{-4.0-(-3)}{1.2-1} = -5.0;$ $\frac{\Delta F}{\Delta x} = \frac{-3.4-(-3)}{1.1-1} = -4.4;$
 $\frac{\Delta F}{\Delta x} = \frac{-3.04-(-3)}{1.01-1} = -4.04;$ $\frac{\Delta F}{\Delta x} = \frac{-3.004-(-3)}{1.001-1} = -4.004;$
 $\frac{\Delta F}{\Delta x} = \frac{-3.0004-(-3)}{1.0001-1} = -4.0004;$
- (b) The rate of change of $F(x)$ at $x = 1$ is -4 .

19. (a) $\frac{\Delta g}{\Delta x} = \frac{g(2)-g(1)}{2-1} = \frac{\sqrt{2}-1}{2-1} \approx 0.414213$ $\frac{\Delta g}{\Delta x} = \frac{g(1.5)-g(1)}{1.5-1} = \frac{\sqrt{1.5}-1}{0.5} \approx 0.449489$

$\frac{\Delta g}{\Delta x} = \frac{g(1+h)-g(1)}{(1+h)-1} = \frac{\sqrt{1+h}-1}{h}$

(b) $g(x) = \sqrt{x}$

$1+h$	1.1	1.01	1.001	1.0001	1.00001	1.000001
$\sqrt{1+h}$	1.04880	1.004987	1.0004998	1.0000499	1.000005	1.0000005
$(\sqrt{1+h}-1)/h$	0.4880	0.4987	0.4998	0.499	0.5	0.5

(c) The rate of change of $g(x)$ at $x = 1$ is 0.5.

(d) The calculator gives $\lim_{h \rightarrow 0} \frac{\sqrt{1+h}-1}{h} = \frac{1}{2}$.

20. (a) i) $\frac{f(3)-f(2)}{3-2} = \frac{\frac{1}{3}-\frac{1}{2}}{1} = \frac{-\frac{1}{6}}{1} = -\frac{1}{6}$
 ii) $\frac{f(T)-f(2)}{T-2} = \frac{\frac{1}{T}-\frac{1}{2}}{T-2} = \frac{\frac{2-T}{2T}}{T-2} = \frac{2-T}{2T(T-2)} = -\frac{1}{2T}, T \neq 2$

T	2.1	2.01	2.001	2.0001	2.00001	2.000001
$f(T)$	0.476190	0.497512	0.499750	0.4999750	0.499997	0.499999
$(f(T)-f(2))/(T-2)$	-0.2381	-0.2488	-0.2500	-0.2500	-0.2500	-0.2500

(c) The table indicates the rate of change is -0.25 at $t = 2$.

(d) $\lim_{T \rightarrow 2} \left(\frac{1}{-2T} \right) = -\frac{1}{4}$

NOTE: Answers will vary in Exercises 21 and 22.

21. (a) $[0, 1]: \frac{\Delta s}{\Delta t} = \frac{15-0}{1-0} = 15$ mph; $[1, 2.5]: \frac{\Delta s}{\Delta t} = \frac{20-15}{2.5-1} = \frac{10}{3}$ mph; $[2.5, 3.5]: \frac{\Delta s}{\Delta t} = \frac{30-20}{3.5-2.5} = 10$ mph

(b) At $P\left(\frac{1}{2}, 7.5\right)$: Since the portion of the graph from $t = 0$ to $t = 1$ is nearly linear, the instantaneous rate of change will be almost the same as the average rate of change, thus the instantaneous speed at $t = \frac{1}{2}$ is $\frac{15-7.5}{1-0.5} = 15$ mi/hr. At $P(2, 20)$: Since the portion of the graph from $t = 2$ to $t = 2.5$ is nearly linear, the instantaneous rate of change will be nearly the same as the average rate of change, thus $v = \frac{20-20}{2.5-2} = 0$ mi/hr. For values of t less than 2, we have

Q	Slope of $PQ = \frac{\Delta s}{\Delta t}$
$Q_1(1, 15)$	$\frac{15-20}{1-2} = 5$ mi/hr
$Q_2(1.5, 19)$	$\frac{19-20}{1.5-2} = 2$ mi/hr
$Q_3(1.9, 19.9)$	$\frac{19.9-20}{1.9-2} = 1$ mi/hr

Thus, it appears that the instantaneous speed at $t = 2$ is 0 mi/hr.

At $P(3, 22)$:

Q	Slope of $PQ = \frac{\Delta s}{\Delta t}$	Q	Slope of $PQ = \frac{\Delta s}{\Delta t}$
$Q_1(4, 35)$	$\frac{35-22}{4-3} = 13$ mi/hr	$Q_1(2, 20)$	$\frac{20-22}{2-3} = 2$ mi/hr
$Q_2(3.5, 30)$	$\frac{30-22}{3.5-3} = 16$ mi/hr	$Q_2(2.5, 20)$	$\frac{20-22}{2.5-3} = 4$ mi/hr
$Q_3(3.1, 23)$	$\frac{23-22}{3.1-3} = 10$ mi/hr	$Q_3(2.9, 21.6)$	$\frac{21.6-22}{2.9-3} = 4$ mi/hr

Thus, it appears that the instantaneous speed at $t = 3$ is about 7 mi/hr.

- (c) It appears that the curve is increasing the fastest at
- $t = 3.5$
- . Thus for
- $P(3.5, 30)$

Q	Slope of $PQ = \frac{\Delta s}{\Delta t}$	Q	Slope of $PQ = \frac{\Delta s}{\Delta t}$
$Q_1(4, 35)$	$\frac{35-30}{4-3.5} = 10$ mi/hr	$Q_1(3, 22)$	$\frac{22-30}{3-3.5} = 16$ mi/hr
$Q_2(3.75, 34)$	$\frac{34-30}{3.75-3.5} = 16$ mi/hr	$Q_2(3.25, 25)$	$\frac{25-30}{3.25-3.5} = 20$ mi/hr
$Q_3(3.6, 32)$	$\frac{32-30}{3.6-3.5} = 20$ mi/hr	$Q_3(3.4, 28)$	$\frac{28-30}{3.4-3.5} = 20$ mi/hr

Thus, it appears that the instantaneous speed at $t = 3.5$ is about 20 mi/hr.

22. (a)
- $[0, 3]: \frac{\Delta A}{\Delta t} = \frac{10-15}{3-0} \approx -1.67 \frac{\text{gal}}{\text{day}}$
- ;
- $[0, 5]: \frac{\Delta A}{\Delta t} = \frac{3.9-15}{5-0} \approx -2.2 \frac{\text{gal}}{\text{day}}$
- ;
- $[7, 10]: \frac{\Delta A}{\Delta t} = \frac{0-1.4}{10-7} \approx -0.5 \frac{\text{gal}}{\text{day}}$

- (b) At
- $P(1, 14)$
- :

Q	Slope of $PQ = \frac{\Delta A}{\Delta t}$	Q	Slope of $PQ = \frac{\Delta A}{\Delta t}$
$Q_1(2, 12.2)$	$\frac{12.2-14}{2-1} = -1.8$ gal/day	$Q_1(0, 15)$	$\frac{15-14}{0-1} = -1$ gal/day
$Q_2(1.5, 13.2)$	$\frac{13.2-14}{1.5-1} = -1.6$ gal/day	$Q_2(0.5, 14.6)$	$\frac{14.6-14}{0.5-1} = -1.2$ gal/day
$Q_3(1.1, 13.85)$	$\frac{13.85-14}{1.1-1} = -1.5$ gal/day	$Q_3(0.9, 14.86)$	$\frac{14.86-14}{0.9-1} = -1.4$ gal/day

Thus, it appears that the instantaneous rate of consumption at $t = 1$ is about -1.45 gal/day.

At $P(4, 6)$:

Q	Slope of $PQ = \frac{\Delta A}{\Delta t}$	Q	Slope of $PQ = \frac{\Delta A}{\Delta t}$
$Q_1(5, 3.9)$	$\frac{3.9-6}{5-4} = -2.1$ gal/day	$Q_1(3, 10)$	$\frac{10-6}{3-4} = -4$ gal/day
$Q_2(4.5, 4.8)$	$\frac{4.8-6}{4.5-4} = -2.4$ gal/day	$Q_2(3.5, 7.8)$	$\frac{7.8-6}{3.5-4} = -3.6$ gal/day
$Q_3(4.1, 5.7)$	$\frac{5.7-6}{4.1-4} = -3$ gal/day	$Q_3(3.9, 6.3)$	$\frac{6.3-6}{3.9-4} = -3$ gal/day

Thus, it appears that the instantaneous rate of consumption at $t = 1$ is -3 gal/day.

At $P(8, 1)$:

Q	Slope of $PQ = \frac{\Delta A}{\Delta t}$	Q	Slope of $PQ = \frac{\Delta A}{\Delta t}$
$Q_1(9, 0.5)$	$\frac{0.5-1}{9-8} = -0.5$ gal/day	$Q_1(7, 1.4)$	$\frac{1.4-1}{7-8} = -0.6$ gal/day
$Q_2(8.5, 0.7)$	$\frac{0.7-1}{8.5-8} = -0.6$ gal/day	$Q_2(7.5, 1.3)$	$\frac{1.3-1}{7.5-8} = -0.6$ gal/day
$Q_3(8.1, 0.95)$	$\frac{0.95-1}{8.1-8} = -0.5$ gal/day	$Q_3(7.9, 1.04)$	$\frac{1.04-1}{7.9-8} = -0.6$ gal/day

Thus, it appears that the instantaneous rate of consumption at $t = 1$ is -0.55 gal/day.

- (c) It appears that the curve (the consumption) is decreasing the fastest at
- $t = 3.5$
- . Thus for
- $P(3.5, 7.8)$

Q	Slope of $PQ = \frac{\Delta A}{\Delta t}$	Q	Slope of $PQ = \frac{\Delta s}{\Delta t}$
$Q_1(4.5, 4.8)$	$\frac{4.8-7.8}{4.5-3.5} = -3$ gal/day	$Q_1(2.5, 11.2)$	$\frac{11.2-7.8}{2.5-3.5} = -3.4$ gal/day
$Q_2(4, 6)$	$\frac{6-7.8}{4-3.5} = -3.6$ gal/day	$Q_2(3, 10)$	$\frac{10-7.8}{3-3.5} = -4.4$ gal/day
$Q_3(3.6, 7.4)$	$\frac{7.4-7.8}{3.6-3.5} = -4$ gal/day	$Q_3(3.4, 8.2)$	$\frac{8.2-7.8}{3.4-3.5} = -4$ gal/day

Thus, it appears that the rate of consumption at $t = 3.5$ is about -4 gal/day.

2.2 LIMIT OF A FUNCTION AND LIMIT LAWS

- Does not exist. As x approaches 1 from the right, $g(x)$ approaches 0. As x approaches 1 from the left, $g(x)$ approaches 1. There is no single number L that all the values $g(x)$ get arbitrarily close to as $x \rightarrow 1$.
 - 1
 - 0
 - 0.5
- 0
 - 1

- (c) Does not exist. As t approaches 0 from the left, $f(t)$ approaches -1 . As t approaches 0 from the right, $f(t)$ approaches 1. There is no single number L that $f(t)$ gets arbitrarily close to as $t \rightarrow 0$.
- (d) -1
3. (a) True (b) True (c) False
(d) False (e) False (f) True
(g) True
4. (a) False (b) False (c) True
(d) True (e) True
5. $\lim_{x \rightarrow 0} \frac{x}{|x|}$ does not exist because $\frac{x}{|x|} = \frac{x}{x} = 1$ if $x > 0$ and $\frac{x}{|x|} = \frac{x}{-x} = -1$ if $x < 0$. As x approaches 0 from the left, $\frac{x}{|x|}$ approaches -1 . As x approaches 0 from the right, $\frac{x}{|x|}$ approaches 1. There is no single number L that all the function values get arbitrarily close to as $x \rightarrow 0$.
6. As x approaches 1 from the left, the values of $\frac{1}{x-1}$ become increasingly large and negative. As x approaches 1 from the right, the values become increasingly large and positive. There is no number L that all the function values get arbitrarily close to as $x \rightarrow 1$, so $\lim_{x \rightarrow 1} \frac{1}{x-1}$ does not exist.
7. Nothing can be said about $f(x)$ because the existence of a limit as $x \rightarrow x_0$ does not depend on how the function is defined at x_0 . In order for a limit to exist, $f(x)$ must be arbitrarily close to a single real number L when x is close enough to x_0 . That is, the existence of a limit depends on the values of $f(x)$ for x near x_0 , not on the definition of $f(x)$ at x_0 itself.
8. Nothing can be said. In order for $\lim_{x \rightarrow 0} f(x)$ to exist, $f(x)$ must close to a single value for x near 0 regardless of the value $f(0)$ itself.
9. No, the definition does not require that f be defined at $x = 1$ in order for a limiting value to exist there. If $f(1)$ is defined, it can be any real number, so we can conclude nothing about $f(1)$ from $\lim_{x \rightarrow 1} f(x) = 5$.
10. No, because the existence of a limit depends on the values of $f(x)$ when x is near 1, not on $f(1)$ itself. If $\lim_{x \rightarrow 1} f(x)$ exists, its value may be some number other than $f(1) = 5$. We can conclude nothing about $\lim_{x \rightarrow 1} f(x)$, whether it exists or what its value is if it does exist, from knowing the value of $f(1)$ alone.
11. $\lim_{x \rightarrow -3} (x^2 - 13) = (-3)^2 - 13 = 9 - 13 = -4$
12. $\lim_{x \rightarrow 2} (-x^2 + 5x - 2) = -(2)^2 + 5(2) - 2 = -4 + 10 - 2 = 4$
13. $\lim_{t \rightarrow 6} 8(t-5)(t-7) = 8(6-5)(6-7) = -8$
14. $\lim_{x \rightarrow -2} (x^3 - 2x^2 + 4x + 8) = (-2)^3 - 2(-2)^2 + 4(-2) + 8 = -8 - 8 - 8 + 8 = -16$
15. $\lim_{x \rightarrow 2} \frac{2x+5}{11-x^3} = \frac{2(2)+5}{11-(2)^3} = \frac{9}{3} = 3$

$$16. \lim_{t \rightarrow 2/3} (8-3s)(2s-1) = \left(8-5\left(\frac{2}{3}\right)\right)\left(2\left(\frac{2}{3}\right)-1\right) = (8-2)\left(\left(\frac{4}{3}\right)-1\right) = (6)\left(\frac{1}{3}\right) = 2$$

$$17. \lim_{x \rightarrow -1/2} 4x(3x+4)^2 = 4\left(-\frac{1}{2}\right)\left(3\left(-\frac{1}{2}\right)+4\right)^2 = (-2)\left(-\frac{3}{2}+4\right)^2 = (-2)\left(\frac{5}{2}\right)^2 = -\frac{25}{2}$$

$$18. \lim_{y \rightarrow 2} \frac{y+2}{y^2+5y+6} = \frac{2+2}{(2)^2+5(2)+6} = \frac{4}{4+10+6} = \frac{4}{20} = \frac{1}{5}$$

$$19. \lim_{y \rightarrow -3} (5-y)^{4/3} = [5-(-3)]^{4/3} = (8)^{4/3} = \left((8)^{1/3}\right)^4 = 2^4 = 16$$

$$20. \lim_{z \rightarrow 4} \sqrt{z^2-10} = \sqrt{4^2-10} = \sqrt{16-10} = \sqrt{6}$$

$$21. \lim_{h \rightarrow 0} \frac{3}{\sqrt{3h+1}+1} = \frac{3}{\sqrt{3(0)+1}+1} = \frac{3}{\sqrt{1}+1} = \frac{3}{2}$$

$$22. \lim_{h \rightarrow 0} \frac{\sqrt{5h+4}-2}{h} = \lim_{h \rightarrow 0} \frac{\sqrt{5h+4}-2}{h} \cdot \frac{\sqrt{5h+4}+2}{\sqrt{5h+4}+2} = \lim_{h \rightarrow 0} \frac{(5h+4)-4}{h(\sqrt{5h+4}+2)} = \lim_{h \rightarrow 0} \frac{5h}{h(\sqrt{5h+4}+2)} = \lim_{h \rightarrow 0} \frac{5}{\sqrt{5h+4}+2} = \frac{5}{\sqrt{4+2}} = \frac{5}{4}$$

$$23. \lim_{x \rightarrow 5} \frac{x-5}{x^2-25} = \lim_{x \rightarrow 5} \frac{x-5}{(x+5)(x-5)} = \lim_{x \rightarrow 5} \frac{1}{x+5} = \frac{1}{5+5} = \frac{1}{10}$$

$$24. \lim_{x \rightarrow -3} \frac{x+3}{x^2+4x+3} = \lim_{x \rightarrow -3} \frac{x+3}{(x+3)(x+1)} = \lim_{x \rightarrow -3} \frac{1}{x+1} = \frac{1}{-3+1} = -\frac{1}{2}$$

$$25. \lim_{x \rightarrow -5} \frac{x^2+3x-10}{x+5} = \lim_{x \rightarrow -5} \frac{(x+5)(x-2)}{x+5} = \lim_{x \rightarrow -5} (x-2) = -5-2 = -7$$

$$26. \lim_{x \rightarrow 2} \frac{x^2-7x-10}{x-2} = \lim_{x \rightarrow 2} \frac{(x-5)(x-2)}{x-2} = \lim_{x \rightarrow 2} (x-5) = 2-5 = -3$$

$$27. \lim_{t \rightarrow 1} \frac{t^2+t-2}{t^2-1} = \lim_{t \rightarrow 1} \frac{(t+2)(t-1)}{(t-1)(t+1)} = \lim_{t \rightarrow 1} \frac{t+2}{t+1} = \frac{1+2}{1+1} = \frac{3}{2}$$

$$28. \lim_{t \rightarrow -1} \frac{t^2+3t+2}{t^2-t-2} = \lim_{t \rightarrow -1} \frac{(t+2)(t+1)}{(t-2)(t+1)} = \lim_{t \rightarrow -1} \frac{t+2}{t-2} = \frac{-1+2}{-1-2} = -\frac{1}{3}$$

$$29. \lim_{x \rightarrow -2} \frac{-2x-4}{x^3+2x^2} = \lim_{x \rightarrow -2} \frac{-2(x+2)}{x^2(x+2)} = \lim_{x \rightarrow -2} \frac{-2}{x^2} = \frac{-2}{4} = -\frac{1}{2}$$

$$30. \lim_{y \rightarrow 0} \frac{5y^3+8y^2}{3y^4-16y^2} = \lim_{y \rightarrow 0} \frac{y^2(5y+8)}{y^2(3y^2-16)} = \lim_{y \rightarrow 0} \frac{5y+8}{3y^2-16} = \frac{8}{-16} = -\frac{1}{2}$$

$$31. \lim_{x \rightarrow 1} \frac{x^{-1}-1}{x-1} = \lim_{x \rightarrow 1} \frac{\frac{1-x}{x}}{x-1} = \lim_{x \rightarrow 1} \left(\frac{1-x}{x} \cdot \frac{1}{x-1}\right) = \lim_{x \rightarrow 1} -\frac{1}{x} = -1$$

$$32. \lim_{x \rightarrow 0} \frac{\frac{1}{x-1} + \frac{1}{x+1}}{x} = \lim_{x \rightarrow 0} \frac{\frac{(x+1)+(x-1)}{(x-1)(x+1)}}{x} = \lim_{x \rightarrow 0} \left(\frac{2x}{(x-1)(x+1)} \cdot \frac{1}{x}\right) = \lim_{x \rightarrow 0} \frac{2}{(x-1)(x+1)} = \frac{2}{-1} = -2$$

$$33. \lim_{u \rightarrow 1} \frac{u^4 - 1}{u^3 - 1} = \lim_{u \rightarrow 1} \frac{(u^2 + 1)(u + 1)(u - 1)}{(u^2 + u + 1)(u - 1)} = \lim_{u \rightarrow 1} \frac{(u^2 + 1)(u + 1)}{u^2 + u + 1} = \frac{(1 + 1)(1 + 1)}{1 + 1 + 1} = \frac{4}{3}$$

$$34. \lim_{v \rightarrow 2} \frac{v^3 - 8}{v^4 - 16} = \lim_{v \rightarrow 2} \frac{(v - 2)(v^2 + 2v + 4)}{(v - 2)(v + 2)(v^2 + 4)} = \lim_{v \rightarrow 2} \frac{v^2 + 2v + 4}{(v + 2)(v^2 + 4)} = \frac{4 + 4 + 4}{(4)(8)} = \frac{12}{32} = \frac{3}{8}$$

$$35. \lim_{x \rightarrow 9} \frac{\sqrt{x} - 3}{x - 9} = \lim_{x \rightarrow 9} \frac{\sqrt{x} - 3}{(\sqrt{x} - 3)(\sqrt{x} + 3)} = \lim_{x \rightarrow 9} \frac{1}{\sqrt{x} + 3} = \frac{1}{\sqrt{9} + 3} = \frac{1}{6}$$

$$36. \lim_{x \rightarrow 4} \frac{4x - x^2}{2 - \sqrt{x}} = \lim_{x \rightarrow 4} \frac{x(4 - x)}{2 - \sqrt{x}} = \lim_{x \rightarrow 4} \frac{x(2 + \sqrt{x})(2 - \sqrt{x})}{2 - \sqrt{x}} = \lim_{x \rightarrow 4} x(2 + \sqrt{x}) = 4(2 + 2) = 16$$

$$37. \lim_{x \rightarrow 1} \frac{x - 1}{\sqrt{x + 3} - 2} = \lim_{x \rightarrow 1} \frac{(x - 1)(\sqrt{x + 3} + 2)}{(\sqrt{x + 3} - 2)(\sqrt{x + 3} + 2)} = \lim_{x \rightarrow 1} \frac{(x - 1)(\sqrt{x + 3} + 2)}{(x + 3) - 4} = \lim_{x \rightarrow 1} (\sqrt{x + 3} + 2) = \sqrt{4} + 2 = 4$$

$$38. \lim_{x \rightarrow -1} \frac{\sqrt{x^2 + 8} - 3}{x + 1} = \lim_{x \rightarrow -1} \frac{(\sqrt{x^2 + 8} - 3)(\sqrt{x^2 + 8} + 3)}{(x + 1)(\sqrt{x^2 + 8} + 3)} = \lim_{x \rightarrow -1} \frac{(x^2 + 8) - 9}{(x + 1)(\sqrt{x^2 + 8} + 3)} = \lim_{x \rightarrow -1} \frac{(x + 1)(x - 1)}{(x + 1)(\sqrt{x^2 + 8} + 3)}$$

$$= \lim_{x \rightarrow -1} \frac{x - 1}{\sqrt{x^2 + 8} + 3} = \frac{-2}{3 + 3} = -\frac{1}{3}$$

$$39. \lim_{x \rightarrow 2} \frac{\sqrt{x^2 + 12} - 4}{x - 2} = \lim_{x \rightarrow 2} \frac{(\sqrt{x^2 + 12} - 4)(\sqrt{x^2 + 12} + 4)}{(x - 2)(\sqrt{x^2 + 12} + 4)} = \lim_{x \rightarrow 2} \frac{(x^2 + 12) - 16}{(x - 2)(\sqrt{x^2 + 12} + 4)} = \lim_{x \rightarrow 2} \frac{(x - 2)(x + 2)}{(x - 2)(\sqrt{x^2 + 12} + 4)}$$

$$= \lim_{x \rightarrow 2} \frac{x + 2}{\sqrt{x^2 + 12} + 4} = \frac{4}{\sqrt{16} + 4} = \frac{1}{2}$$

$$40. \lim_{x \rightarrow -2} \frac{x + 2}{\sqrt{x^2 + 5} - 3} = \lim_{x \rightarrow -2} \frac{(x + 2)(\sqrt{x^2 + 5} + 3)}{(\sqrt{x^2 + 5} - 3)(\sqrt{x^2 + 5} + 3)} = \lim_{x \rightarrow -2} \frac{(x + 2)(\sqrt{x^2 + 5} + 3)}{(x^2 + 5) - 9} = \lim_{x \rightarrow -2} \frac{(x + 2)(\sqrt{x^2 + 5} + 3)}{(x + 2)(x - 2)}$$

$$= \lim_{x \rightarrow -2} \frac{\sqrt{x^2 + 5} + 3}{x - 2} = \frac{\sqrt{9} + 3}{-4} = -\frac{3}{2}$$

$$41. \lim_{x \rightarrow -3} \frac{2 - \sqrt{x^2 - 5}}{x + 3} = \lim_{x \rightarrow -3} \frac{(2 - \sqrt{x^2 - 5})(2 + \sqrt{x^2 - 5})}{(x + 3)(2 + \sqrt{x^2 - 5})} = \lim_{x \rightarrow -3} \frac{4 - (x^2 - 5)}{(x + 3)(2 + \sqrt{x^2 - 5})} = \lim_{x \rightarrow -3} \frac{9 - x^2}{(x + 3)(2 + \sqrt{x^2 - 5})}$$

$$= \lim_{x \rightarrow -3} \frac{(3 - x)(3 + x)}{(x + 3)(2 + \sqrt{x^2 - 5})} = \lim_{x \rightarrow -3} \frac{3 - x}{2 + \sqrt{x^2 - 5}} = \frac{6}{2 + \sqrt{4}} = \frac{3}{2}$$

$$42. \lim_{x \rightarrow 4} \frac{4 - x}{5 - \sqrt{x^2 + 9}} = \lim_{x \rightarrow 4} \frac{(4 - x)(5 + \sqrt{x^2 + 9})}{(5 - \sqrt{x^2 + 9})(5 + \sqrt{x^2 + 9})} = \lim_{x \rightarrow 4} \frac{(4 - x)(5 + \sqrt{x^2 + 9})}{25 - (x^2 + 9)} = \lim_{x \rightarrow 4} \frac{(4 - x)(5 + \sqrt{x^2 + 9})}{16 - x^2}$$

$$= \lim_{x \rightarrow 4} \frac{(4 - x)(5 + \sqrt{x^2 + 9})}{(4 - x)(4 + x)} = \lim_{x \rightarrow 4} \frac{5 + \sqrt{x^2 + 9}}{4 + x} = \frac{5 + \sqrt{25}}{8} = \frac{5}{4}$$

$$43. \lim_{x \rightarrow 0} (2 \sin x - 1) = 2 \sin 0 - 1 = 0 - 1 = -1$$

$$44. \lim_{x \rightarrow 0} \sin^2 x = \left(\lim_{x \rightarrow 0} \sin x \right)^2 = (\sin 0)^2 = 0^2 = 0$$

$$45. \lim_{x \rightarrow 0} \sec x = \lim_{x \rightarrow 0} \frac{1}{\cos x} = \frac{1}{\cos 0} = \frac{1}{1} = 1$$

$$46. \lim_{x \rightarrow 0} \tan x = \lim_{x \rightarrow 0} \frac{\sin x}{\cos x} = \frac{\sin 0}{\cos 0} = \frac{0}{1} = 0$$

$$47. \lim_{x \rightarrow 0} \frac{1+x+\sin x}{3\cos x} = \frac{1+0+\sin 0}{3\cos 0} = \frac{1+0+0}{3} = \frac{1}{3}$$

$$48. \lim_{x \rightarrow 0} (x^2 - 1)(2 - \cos x) = (0^2 - 1)(2 - \cos 0) = (-1)(2 - 1) = (-1)(1) = -1$$

$$49. \lim_{x \rightarrow -\pi} \sqrt{x+4} \cos(x + \pi) = \lim_{x \rightarrow -\pi} \sqrt{x+4} \cdot \lim_{x \rightarrow -\pi} \cos(x + \pi) = \sqrt{-\pi+4} \cdot \cos 0 = \sqrt{4-\pi} \cdot 1 = \sqrt{4-\pi}$$

$$50. \lim_{x \rightarrow 0} \sqrt{7 + \sec^2 x} = \sqrt{\lim_{x \rightarrow 0} (7 + \sec^2 x)} = \sqrt{7 + \lim_{x \rightarrow 0} \sec^2 x} = \sqrt{7 + \sec^2 0} = \sqrt{7 + (1)^2} = 2\sqrt{2}$$

51. (a) quotient rule (b) difference and power rules
(c) sum and constant multiple rules

52. (a) quotient rule (b) power and product rules
(c) difference and constant multiple rules

$$53. (a) \lim_{x \rightarrow c} f(x)g(x) = \left[\lim_{x \rightarrow c} f(x) \right] \left[\lim_{x \rightarrow c} g(x) \right] = (5)(-2) = -10$$

$$(b) \lim_{x \rightarrow c} 2f(x)g(x) = 2 \left[\lim_{x \rightarrow c} f(x) \right] \left[\lim_{x \rightarrow c} g(x) \right] = 2(5)(-2) = -20$$

$$(c) \lim_{x \rightarrow c} [f(x) + 3g(x)] = \lim_{x \rightarrow c} f(x) + 3 \lim_{x \rightarrow c} g(x) = 5 + 3(-2) = -1$$

$$(d) \lim_{x \rightarrow c} \frac{f(x)}{f(x)-g(x)} = \frac{\lim_{x \rightarrow c} f(x)}{\lim_{x \rightarrow c} f(x) - \lim_{x \rightarrow c} g(x)} = \frac{5}{5 - (-2)} = \frac{5}{7}$$

$$54. (a) \lim_{x \rightarrow 4} [g(x) + 3] = \lim_{x \rightarrow 4} g(x) + \lim_{x \rightarrow 4} 3 = -3 + 3 = 0$$

$$(b) \lim_{x \rightarrow 4} xf(x) = \lim_{x \rightarrow 4} x \cdot \lim_{x \rightarrow 4} f(x) = (4)(0) = 0$$

$$(c) \lim_{x \rightarrow 4} [g(x)]^2 = \left[\lim_{x \rightarrow 4} g(x) \right]^2 = [-3]^2 = 9$$

$$(d) \lim_{x \rightarrow 4} \frac{g(x)}{f(x)-1} = \frac{\lim_{x \rightarrow 4} g(x)}{\lim_{x \rightarrow 4} f(x) - \lim_{x \rightarrow 4} 1} = \frac{-3}{0-1} = 3$$

$$55. (a) \lim_{x \rightarrow b} [f(x) + g(x)] = \lim_{x \rightarrow b} f(x) + \lim_{x \rightarrow b} g(x) = 7 + (-3) = 4$$

$$(b) \lim_{x \rightarrow b} f(x) \cdot g(x) = \left[\lim_{x \rightarrow b} f(x) \right] \left[\lim_{x \rightarrow b} g(x) \right] = (7)(-3) = -21$$

$$(c) \lim_{x \rightarrow b} 4g(x) = \left[\lim_{x \rightarrow b} 4 \right] \left[\lim_{x \rightarrow b} g(x) \right] = (4)(-3) = -12$$

$$(d) \lim_{x \rightarrow b} f(x)/g(x) = \lim_{x \rightarrow b} f(x) / \lim_{x \rightarrow b} g(x) = \frac{7}{-3} = -\frac{7}{3}$$

$$56. (a) \lim_{x \rightarrow -2} [p(x) + r(x) + s(x)] = \lim_{x \rightarrow -2} p(x) + \lim_{x \rightarrow -2} r(x) + \lim_{x \rightarrow -2} s(x) = 4 + 0 + (-3) = 1$$

$$(b) \lim_{x \rightarrow -2} p(x) \cdot r(x) \cdot s(x) = \left[\lim_{x \rightarrow -2} p(x) \right] \left[\lim_{x \rightarrow -2} r(x) \right] \left[\lim_{x \rightarrow -2} s(x) \right] = (4)(0)(-3) = 0$$

$$(c) \lim_{x \rightarrow -2} [-4p(x) + 5r(x)]/s(x) = \left[-4 \lim_{x \rightarrow -2} p(x) + 5 \lim_{x \rightarrow -2} r(x) \right] / \lim_{x \rightarrow -2} s(x) = [-4(4) + 5(0)] / -3 = \frac{16}{3}$$

$$57. \lim_{h \rightarrow 0} \frac{(1+h)^2 - 1^2}{h} = \lim_{h \rightarrow 0} \frac{1+2h+h^2-1}{h} = \lim_{h \rightarrow 0} \frac{h(2+h)}{h} = \lim_{h \rightarrow 0} (2+h) = 2$$

58. $\lim_{h \rightarrow 0} \frac{(-2+h)^2 - (-2)^2}{h} = \lim_{h \rightarrow 0} \frac{4-4h+h^2-4}{h} = \lim_{h \rightarrow 0} \frac{h(h-4)}{h} = \lim_{h \rightarrow 0} (h-4) = -4$

59. $\lim_{h \rightarrow 0} \frac{[3(2+h)-4]-[3(2)-4]}{h} = \lim_{h \rightarrow 0} \frac{3h}{h} = 3$

60. $\lim_{h \rightarrow 0} \frac{(\frac{1}{-2+h}) - (\frac{1}{-2})}{h} = \lim_{h \rightarrow 0} \frac{\frac{-2}{-2+h} - 1}{-2h} = \lim_{h \rightarrow 0} \frac{-2 - (-2+h)}{-2h(-2+h)} = \lim_{h \rightarrow 0} \frac{-h}{h(4-2h)} = -\frac{1}{4}$

61. $\lim_{h \rightarrow 0} \frac{\sqrt{7+h} - \sqrt{7}}{h} = \lim_{h \rightarrow 0} \frac{(\sqrt{7+h} - \sqrt{7})(\sqrt{7+h} + \sqrt{7})}{h(\sqrt{7+h} + \sqrt{7})} = \lim_{h \rightarrow 0} \frac{(7+h)-7}{h(\sqrt{7+h} + \sqrt{7})} = \lim_{h \rightarrow 0} \frac{h}{h(\sqrt{7+h} + \sqrt{7})} = \lim_{h \rightarrow 0} \frac{1}{\sqrt{7+h} + \sqrt{7}} = \frac{1}{2\sqrt{7}}$

62. $\lim_{h \rightarrow 0} \frac{\sqrt{3(0+h)+1} - \sqrt{3(0)+1}}{h} = \lim_{h \rightarrow 0} \frac{(\sqrt{3h+1}-1)(\sqrt{3h+1}+1)}{h(\sqrt{3h+1}+1)} = \lim_{h \rightarrow 0} \frac{(3h+1)-1}{h(\sqrt{3h+1}+1)} = \lim_{h \rightarrow 0} \frac{3h}{h(\sqrt{3h+1}+1)} = \lim_{h \rightarrow 0} \frac{3}{\sqrt{3h+1}+1} = \frac{3}{2}$

63. $\lim_{x \rightarrow 0} \sqrt{5-2x^2} = \sqrt{5-2(0)^2} = \sqrt{5}$ and $\lim_{x \rightarrow 0} \sqrt{5-x^2} = \sqrt{5-(0)^2} = \sqrt{5}$; by the sandwich theorem, $\lim_{x \rightarrow 0} f(x) = \sqrt{5}$

64. $\lim_{x \rightarrow 0} (2-x^2) = 2-0 = 2$ and $\lim_{x \rightarrow 0} 2 \cos x = 2(1) = 2$; by the sandwich theorem, $\lim_{x \rightarrow 0} g(x) = 2$

65. (a) $\lim_{x \rightarrow 0} (1 - \frac{x^2}{6}) = 1 - \frac{0}{6} = 1$ and $\lim_{x \rightarrow 0} 1 = 1$; by the sandwich theorem, $\lim_{x \rightarrow 0} \frac{x \sin x}{2-2 \cos x} = 1$

(b) For $x \neq 0$, $y = (x \sin x)/(2 - 2 \cos x)$ lies between the other two graphs in the figure, and the graphs converge as $x \rightarrow 0$.

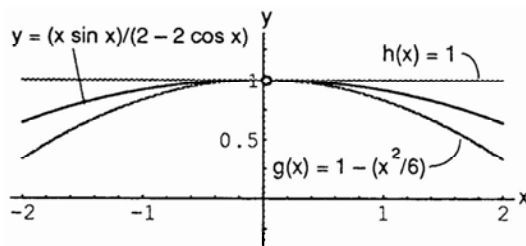

66. (a) $\lim_{x \rightarrow 0} (\frac{1}{2} - \frac{x^2}{24}) = \lim_{x \rightarrow 0} \frac{1}{2} - \lim_{x \rightarrow 0} \frac{x^2}{24} = \frac{1}{2} - 0 = \frac{1}{2}$ and $\lim_{x \rightarrow 0} \frac{1}{2} = \frac{1}{2}$; by the sandwich theorem, $\lim_{x \rightarrow 0} \frac{1 - \cos x}{x^2} = \frac{1}{2}$.

(b) For all $x \neq 0$, the graph of $f(x) = (1 - \cos x)/x^2$ lies between the line $y = \frac{1}{2}$ and the parabola $y = \frac{1}{2} - x^2/24$, and the graphs converge as $x \rightarrow 0$.

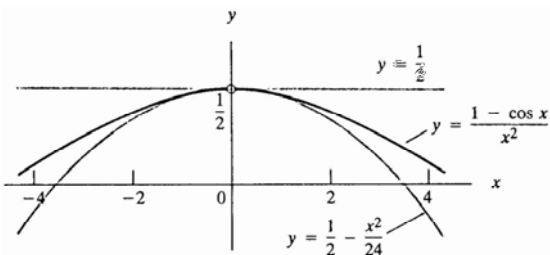

67. (a) $f(x) = (x^2 - 9)/(x + 3)$

x	-3.1	-3.01	-3.001	-3.0001	-3.00001	-3.000001
$f(x)$	-6.1	-6.01	-6.001	-6.0001	-6.00001	-6.000001

x	-2.9	-2.99	-2.999	-2.9999	-2.99999	-2.999999
$f(x)$	-5.9	-5.99	-5.999	-5.9999	-5.99999	-5.999999

The estimate is $\lim_{x \rightarrow -3} f(x) = -6$.

(b)

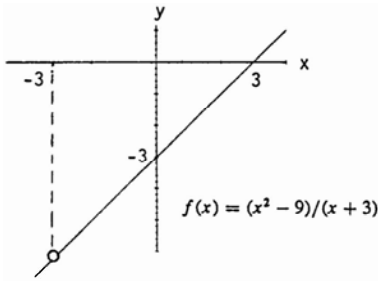

(c) $f(x) = \frac{x^2 - 9}{x + 3} = \frac{(x + 3)(x - 3)}{x + 3} = x - 3$ if $x \neq -3$, and $\lim_{x \rightarrow -3} (x - 3) = -3 - 3 = -6$.

68. (a) $g(x) = (x^2 - 2)/(x - \sqrt{2})$

x	1.4	1.41	1.414	1.4142	1.41421	1.414213
$g(x)$	2.81421	2.82421	2.82821	2.828413	2.828423	2.828426

(b)

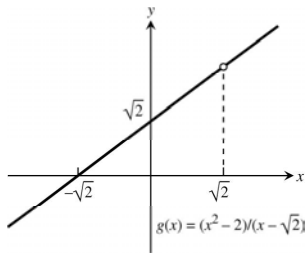

(c) $g(x) = \frac{x^2 - 2}{x - \sqrt{2}} = \frac{(x + \sqrt{2})(x - \sqrt{2})}{(x - \sqrt{2})} = x + \sqrt{2}$ if $x \neq \sqrt{2}$, and $\lim_{x \rightarrow \sqrt{2}} (x + \sqrt{2}) = \sqrt{2} + \sqrt{2} = 2\sqrt{2}$.

69. (a) $G(x) = (x + 6)/(x^2 + 4x - 12)$

x	-5.9	-5.99	-5.999	-5.9999	-5.99999	-5.999999
$G(x)$	-1.126582	-1.1251564	-1.1250156	-1.1250015	-1.1250001	-1.1250000

x	-6.1	-6.01	-6.001	-6.0001	-6.00001	-6.000001
$G(x)$	-1.123456	-1.124843	-1.124984	-1.124998	-1.124999	-1.124999

(b)

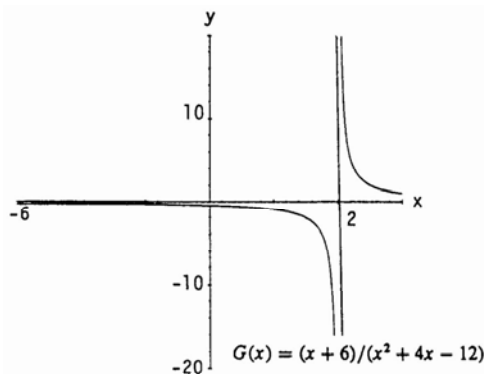

(c) $G(x) = \frac{x + 6}{(x^2 + 4x - 12)} = \frac{x + 6}{(x + 6)(x - 2)} = \frac{1}{x - 2}$ if $x \neq -6$, and $\lim_{x \rightarrow -6} \frac{1}{x - 2} = \frac{1}{-6 - 2} = -\frac{1}{8} = -0.125$.

70. (a) $h(x) = (x^2 - 2x - 3)/(x^2 - 4x + 3)$

x	2.9	2.99	2.999	2.9999	2.99999	2.999999
$h(x)$	2.052631	2.005025	2.000500	2.000050	2.000005	2.0000005
x	3.1	3.01	3.001	3.0001	3.00001	3.000001
$h(x)$	1.952380	1.995024	1.999500	1.999950	1.999995	1.999999

(b)

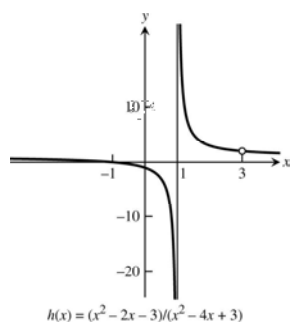

(c) $h(x) = \frac{x^2 - 2x - 3}{x^2 - 4x + 3} = \frac{(x-3)(x+1)}{(x-3)(x-1)} = \frac{x+1}{x-1}$ if $x \neq 3$, and $\lim_{x \rightarrow 3} \frac{x+1}{x-1} = \frac{3+1}{3-1} = \frac{4}{2} = 2$.

71. (a) $f(x) = (x^2 - 1)/(|x| - 1)$

x	-1.1	-1.01	-1.001	-1.0001	-1.00001	-1.000001
$f(x)$	2.1	2.01	2.001	2.0001	2.00001	2.000001
x	-0.9	-0.99	-0.999	-0.9999	-0.99999	-0.999999
$f(x)$	1.9	1.99	1.999	1.9999	1.99999	1.999999

(b)

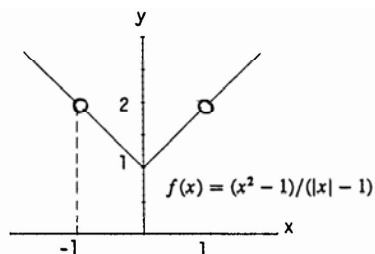

(c) $f(x) = \frac{x^2 - 1}{|x| - 1} = \begin{cases} \frac{(x+1)(x-1)}{x-1} = x+1, & x > 0 \text{ and } x \neq 1 \\ \frac{(x+1)(x-1)}{-(x+1)} = 1-x, & x < 0 \text{ and } x \neq -1 \end{cases}$, and $\lim_{x \rightarrow -1} (1-x) = 1 - (-1) = 2$.

72. (a) $F(x) = (x^2 + 3x + 2)/(2 - |x|)$

x	-2.1	-2.01	-2.001	-2.0001	-2.00001	-2.000001
$F(x)$	-1.1	-1.01	-1.001	-1.0001	-1.00001	-1.000001
x	-1.9	-1.99	-1.999	-1.9999	-1.99999	-1.999999
$F(x)$	-0.9	-0.99	-0.999	-0.9999	-0.99999	-0.999999

(b)

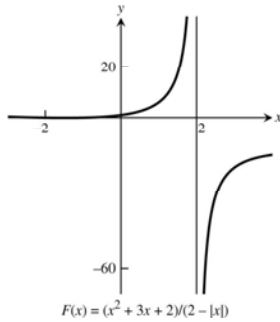

(c)
$$F(x) = \frac{x^2 + 3x + 2}{2 - |x|} = \begin{cases} \frac{(x+2)(x+1)}{2-x}, & x \geq 0 \\ \frac{(x+2)(x+1)}{2+x} = x+1, & x < 0 \text{ and } x \neq -2 \end{cases}, \text{ and } \lim_{x \rightarrow -2} (x+1) = -2+1 = -1.$$

73. (a) $g(\theta) = (\sin \theta)/\theta$

θ	.1	.01	.001	.0001	.00001	.000001
$g(\theta)$.998334	.999983	.999999	.999999	.999999	.999999
θ	-.1	-.01	-.001	-.0001	-.00001	-.000001
$g(\theta)$.998334	.999983	.999999	.999999	.999999	.999999

$\lim_{\theta \rightarrow 0} g(\theta) = 1$

(b)

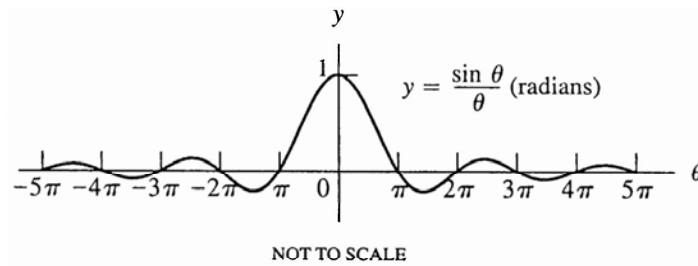

74. (a) $G(t) = (1 - \cos t)/t^2$

t	.1	.01	.001	.0001	.00001	.000001
$G(t)$.499583	.499995	.499999	.5	.5	.5
t	-.1	-.01	-.001	-.0001	-.00001	-.000001
$G(t)$.499583	.499995	.499999	.5	.5	.5

$\lim_{t \rightarrow 0} G(t) = 0.5$

(b)

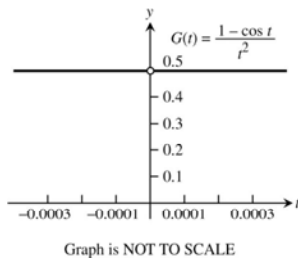

75. (a) $f(x) = x^{1/(1-x)}$

x	.9	.99	.999	.9999	.99999	.999999
$f(x)$.348678	.366032	.367695	.367861	.367877	.367879

x	1.1	1.01	1.001	1.0001	1.00001	1.000001
$f(x)$.385543	.369711	.368063	.367897	.367881	.367878

$\lim_{x \rightarrow 1} f(x) \approx 0.36788$

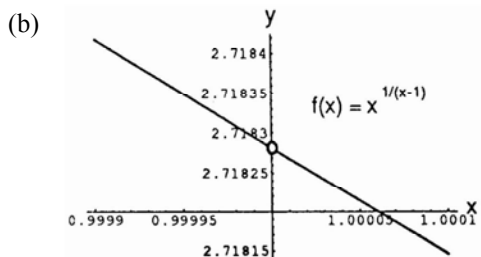

Graph is NOT TO SCALE. Also, the intersection of the axes is not the origin: the axes intersect at the point (1, 2.71820).

76. (a) $f(x) = (3^x - 1)/x$

x	.1	.01	.001	.0001	.00001	.000001
$f(x)$	1.161231	1.104669	1.099215	1.098672	1.098618	1.098612

x	-.1	-.01	-.001	-.0001	-.00001	-.000001
$f(x)$	1.040415	1.092599	1.098009	1.098551	1.098606	1.098611

$\lim_{x \rightarrow 1} f(x) \approx 1.0986$

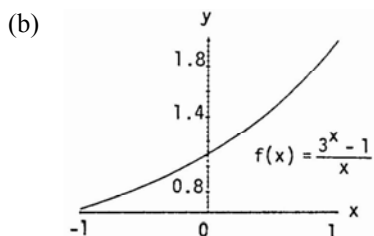

77. $\lim_{x \rightarrow c} f(x)$ exists at those points c where $\lim_{x \rightarrow c} x^4 = \lim_{x \rightarrow c} x^2$. Thus, $c^4 = c^2 \Rightarrow c^2(1 - c^2) = 0 \Rightarrow c = 0, 1, \text{ or } -1$.

Moreover, $\lim_{x \rightarrow 0} f(x) = \lim_{x \rightarrow 0} x^2 = 0$ and $\lim_{x \rightarrow -1} f(x) = \lim_{x \rightarrow 1} f(x) = 1$.

78. Nothing can be concluded about the values of f , g , and h at $x = 2$. Yes, $f(2)$ could be 0. Since the conditions of the sandwich theorem are satisfied, $\lim_{x \rightarrow 2} f(x) = -5 \neq 0$.

79. $1 = \lim_{x \rightarrow 4} \frac{f(x)-5}{x-2} = \frac{\lim_{x \rightarrow 4} f(x) - \lim_{x \rightarrow 4} 5}{\lim_{x \rightarrow 4} x - \lim_{x \rightarrow 4} 2} = \frac{\lim_{x \rightarrow 4} f(x) - 5}{4 - 2} \Rightarrow \lim_{x \rightarrow 4} f(x) - 5 = 2(1) \Rightarrow \lim_{x \rightarrow 4} f(x) = 2 + 5 = 7$.

80. (a) $1 = \lim_{x \rightarrow -2} \frac{f(x)}{x^2} = \frac{\lim_{x \rightarrow -2} f(x)}{\lim_{x \rightarrow -2} x^2} = \frac{\lim_{x \rightarrow -2} f(x)}{4} \Rightarrow \lim_{x \rightarrow -2} f(x) = 4$.

$$(b) 1 = \lim_{x \rightarrow -2} \frac{f(x)}{x^2} = \left[\lim_{x \rightarrow -2} \frac{f(x)}{x} \right] \left[\lim_{x \rightarrow -2} \frac{1}{x} \right] = \left[\lim_{x \rightarrow -2} \frac{f(x)}{x} \right] \left(\frac{1}{-2} \right) \Rightarrow \lim_{x \rightarrow -2} \frac{f(x)}{x} = -2.$$

$$81. (a) 0 = 3 \cdot 0 = \left[\lim_{x \rightarrow 2} \frac{f(x)-5}{x-2} \right] \left[\lim_{x \rightarrow 2} (x-2) \right] = \lim_{x \rightarrow 2} \left[\left(\frac{f(x)-5}{x-2} \right) (x-2) \right] = \lim_{x \rightarrow 2} [f(x)-5]$$

$$= \lim_{x \rightarrow 2} f(x) - 5 \Rightarrow \lim_{x \rightarrow 2} f(x) = 5.$$

$$(b) 0 = 4 \cdot 0 = \left[\lim_{x \rightarrow 2} \frac{f(x)-5}{x-2} \right] \left[\lim_{x \rightarrow 2} (x-2) \right] \Rightarrow \lim_{x \rightarrow 2} f(x) = 5 \text{ as in part (a).}$$

$$82. (a) 0 = 1 \cdot 0 = \left[\lim_{x \rightarrow 0} \frac{f(x)}{x^2} \right] \left[\lim_{x \rightarrow 0} x \right]^2 = \left[\lim_{x \rightarrow 0} \frac{f(x)}{x^2} \right] \left[\lim_{x \rightarrow 0} x^2 \right] = \lim_{x \rightarrow 0} \left[\frac{f(x)}{x^2} \cdot x^2 \right] = \lim_{x \rightarrow 0} f(x).$$

That is, $\lim_{x \rightarrow 0} f(x) = 0$.

$$(b) 0 = 1 \cdot 0 = \left[\lim_{x \rightarrow 0} \frac{f(x)}{x^2} \right] \left[\lim_{x \rightarrow 0} x \right] = \lim_{x \rightarrow 0} \left[\frac{f(x)}{x^2} \cdot x \right] = \lim_{x \rightarrow 0} \frac{f(x)}{x}. \text{ That is, } \lim_{x \rightarrow 0} \frac{f(x)}{x} = 0.$$

$$83. (a) \lim_{x \rightarrow 0} x \sin \frac{1}{x} = 0$$

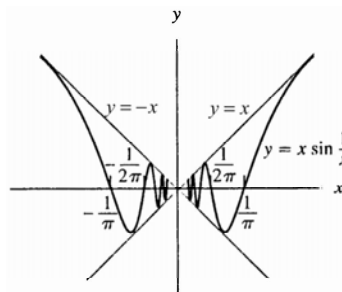

$$(b) -1 \leq \sin \frac{1}{x} \leq 1 \text{ for } x \neq 0:$$

$$x > 0 \Rightarrow -x \leq x \sin \frac{1}{x} \leq x \Rightarrow \lim_{x \rightarrow 0} x \sin \frac{1}{x} = 0 \text{ by the sandwich theorem;}$$

$$x < 0 \Rightarrow -x \geq x \sin \frac{1}{x} \geq x \Rightarrow \lim_{x \rightarrow 0} x \sin \frac{1}{x} = 0 \text{ by the sandwich theorem.}$$

$$84. (a) \lim_{x \rightarrow 0} x^2 \cos \left(\frac{1}{x^3} \right) = 0$$

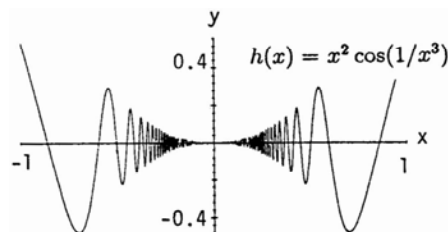

$$(b) -1 \leq \cos \left(\frac{1}{x^3} \right) \leq 1 \text{ for } x \neq 0 \Rightarrow -x^2 \leq x^2 \cos \left(\frac{1}{x^3} \right) \leq x^2 \Rightarrow \lim_{x \rightarrow 0} x^2 \cos \left(\frac{1}{x^3} \right) = 0 \text{ by the sandwich theorem since}$$

$$\lim_{x \rightarrow 0} x^2 = 0.$$

85-90. Example CAS commands:

Maple:

```
f := x -> (x^4 - 16)/(x - 2);
x0 := 2;
plot( f(x), x = x0-1..x0+1, color = black,
      title = "Section 2.2, #85(a)" );
limit( f(x), x = x0 );
```

In Exercise 87, note that the standard cube root, $x^{1/3}$, is not defined for $x < 0$ in many CASs. This can be overcome in Maple by entering the function as $f := x \rightarrow (\text{surd}(x+1, 3) - 1)/x$.

Mathematica: (assigned function and values for x_0 and h may vary)

```
Clear[f, x]
f[x_]:= (x^3 - x^2 - 5x - 3)/(x + 1)^2
x0 = -1; h = 0.1;
Plot[f[x], {x, x0 - h, x0 + h}]
Limit[f[x], x -> x0]
```

2.3 THE PRECISE DEFINITION OF A LIMIT



Step 1: $|x - 5| < \delta \Rightarrow -\delta < x - 5 < \delta \Rightarrow -\delta + 5 < x < \delta + 5$

Step 2: $\delta + 5 = 7 \Rightarrow \delta = 2$, or $-\delta + 5 = 1 \Rightarrow \delta = 4$.

The value of δ which assures $|x - 5| < \delta \Rightarrow 1 < x < 7$ is the smaller value, $\delta = 2$.



Step 1: $|x - 2| < \delta \Rightarrow -\delta < x - 2 < \delta \Rightarrow -\delta + 2 < x < \delta + 2$

Step 2: $-\delta + 2 = 1 \Rightarrow \delta = 1$, or $\delta + 2 = 7 \Rightarrow \delta = 5$.

The value of δ which assures $|x - 2| < \delta \Rightarrow 1 < x < 7$ is the smaller value, $\delta = 1$.



Step 1: $|x - (-3)| < \delta \Rightarrow -\delta < x + 3 < \delta \Rightarrow -\delta - 3 < x < \delta - 3$

Step 2: $-\delta - 3 = -7/2 \Rightarrow \delta = 1/2$, or $\delta - 3 = -1/2 \Rightarrow \delta = 5/2$.

The value of δ which assures $|x - (-3)| < \delta \Rightarrow -7/2 < x < -1/2$ is the smaller value, $\delta = 1/2$.

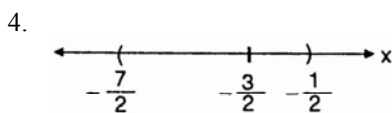

Step 1: $|x - (-3/2)| < \delta \Rightarrow -\delta < x + 3/2 < \delta \Rightarrow -\delta - 3/2 < x < \delta - 3/2$

Step 2: $-\delta - 3/2 = -7/2 \Rightarrow \delta = 2$, or $\delta - 3/2 = -1/2 \Rightarrow \delta = 1$.

The value of δ which assures $|x - (-3/2)| < \delta \Rightarrow -7/2 < x < -1/2$ is the smaller value, $\delta = 1$.

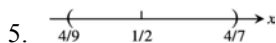

Step 1: $|x - 1/2| < \delta \Rightarrow -\delta < x - 1/2 < \delta \Rightarrow -\delta + 1/2 < x < \delta + 1/2$

Step 2: $-\delta + 1/2 = 4/9 \Rightarrow \delta = 1/18$, or $\delta + 1/2 = 4/7 \Rightarrow \delta = 1/14$.

The value of δ which assures $|x - 1/2| < \delta \Rightarrow 4/9 < x < 4/7$ is the smaller value, $\delta = 1/18$.

6.

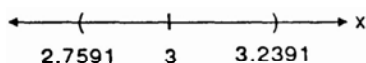

Step 1: $|x-3| < \delta \Rightarrow -\delta < x-3 < \delta \Rightarrow -\delta+3 < x < \delta+3$

Step 2: $-\delta+3 = 2.7591 \Rightarrow \delta = 0.2409$, or $\delta+3 = 3.2391 \Rightarrow \delta = 0.2391$.

The value of δ which assures $|x-3| < \delta \Rightarrow 2.7591 < x < 3.2391$ is the smaller value, $\delta = 0.2391$.

7. Step 1: $|x-5| < \delta \Rightarrow -\delta < x-5 < \delta \Rightarrow -\delta+5 < x < \delta+5$
 Step 2: From the graph, $-\delta+5 = 4.9 \Rightarrow \delta = 0.1$, or $\delta+5 = 5.1 \Rightarrow \delta = 0.1$; thus $\delta = 0.1$ in either case.
8. Step 1: $|x-(-3)| < \delta \Rightarrow -\delta < x+3 < \delta \Rightarrow -\delta-3 < x < \delta-3$
 Step 2: From the graph, $-\delta-3 = -3.1 \Rightarrow \delta = 0.1$, or $\delta-3 = -2.9 \Rightarrow \delta = 0.1$; thus $\delta = 0.1$.
9. Step 1: $|x-1| < \delta \Rightarrow -\delta < x-1 < \delta \Rightarrow -\delta+1 < x < \delta+1$
 Step 2: From the graph, $-\delta+1 = \frac{9}{16} \Rightarrow \delta = \frac{7}{16}$, or $\delta+1 = \frac{25}{16} \Rightarrow \delta = \frac{9}{16}$; thus $\delta = \frac{7}{16}$.
10. Step 1: $|x-3| < \delta \Rightarrow -\delta < x-3 < \delta \Rightarrow -\delta+3 < x < \delta+3$
 Step 2: From the graph, $-\delta+3 = 2.61 \Rightarrow \delta = 0.39$, or $\delta+3 = 3.41 \Rightarrow \delta = 0.41$; thus $\delta = 0.39$.
11. Step 1: $|x-2| < \delta \Rightarrow -\delta < x-2 < \delta \Rightarrow -\delta+2 < x < \delta+2$
 Step 2: From the graph, $-\delta+2 = \sqrt{3} \Rightarrow \delta = 2-\sqrt{3} \approx 0.2679$, or $\delta+2 = \sqrt{5} \Rightarrow \delta = \sqrt{5}-2 \approx 0.2361$; thus $\delta = \sqrt{5}-2$.
12. Step 1: $|x-(-1)| < \delta \Rightarrow -\delta < x+1 < \delta \Rightarrow -\delta-1 < x < \delta-1$
 Step 2: From the graph, $-\delta-1 = -\frac{\sqrt{5}}{2} \Rightarrow \delta = \frac{\sqrt{5}-2}{2} \approx 0.118$ or $\delta-1 = -\frac{\sqrt{3}}{2} \Rightarrow \delta = \frac{2-\sqrt{3}}{2} \approx 0.1340$; thus $\delta = \frac{\sqrt{5}-2}{2}$.
13. Step 1: $|x-(-1)| < \delta \Rightarrow -\delta < x+1 < \delta \Rightarrow -\delta-1 < x < \delta-1$
 Step 2: From the graph, $-\delta-1 = -\frac{16}{9} \Rightarrow \delta = \frac{7}{9} \approx 0.77$, or $\delta-1 = -\frac{16}{25} \Rightarrow \frac{9}{25} = 0.36$; thus $\delta = \frac{9}{25} = 0.36$.
14. Step 1: $|x-\frac{1}{2}| < \delta \Rightarrow -\delta < x-\frac{1}{2} < \delta \Rightarrow -\delta+\frac{1}{2} < x < \delta+\frac{1}{2}$
 Step 2: From the graph, $-\delta+\frac{1}{2} = \frac{1}{2.01} \Rightarrow \delta = \frac{1}{2} - \frac{1}{2.01} \approx 0.00248$, or $\delta+\frac{1}{2} = \frac{1}{1.99} \Rightarrow \delta = \frac{1}{1.99} - \frac{1}{2} \approx 0.00251$; thus $\delta = 0.00248$.
15. Step 1: $|(x+1)-5| < 0.01 \Rightarrow |x-4| < 0.01 \Rightarrow -0.01 < x-4 < 0.01 \Rightarrow 3.99 < x < 4.01$
 Step 2: $|x-4| < \delta \Rightarrow -\delta < x-4 < \delta \Rightarrow -\delta+4 < x < \delta+4 \Rightarrow \delta = 0.01$.
16. Step 1: $|(2x-2)-(-6)| < 0.02 \Rightarrow |2x+4| < 0.02 \Rightarrow -0.02 < 2x+4 < 0.02$
 $\Rightarrow -4.02 < 2x < -3.98 \Rightarrow -2.01 < x < -1.99$
 Step 2: $|x-(-2)| < \delta \Rightarrow -\delta < x+2 < \delta \Rightarrow -\delta-2 < x < \delta-2 \Rightarrow \delta = 0.01$.
17. Step 1: $|\sqrt{x+1}-1| < 0.1 \Rightarrow -0.1 < \sqrt{x+1}-1 < 0.1 \Rightarrow 0.9 < \sqrt{x+1} < 1.1 \Rightarrow 0.81 < x+1 < 1.21$
 $\Rightarrow -0.19 < x < 0.21$
 Step 2: $|x-0| < \delta \Rightarrow -\delta < x < \delta$. Then, $-\delta = -0.19 \Rightarrow \delta = 0.19$ or $\delta = 0.21$; thus, $\delta = 0.19$.

18. Step 1: $\left|\sqrt{x} - \frac{1}{2}\right| < 0.1 \Rightarrow -0.1 < \sqrt{x} - \frac{1}{2} < 0.1 \Rightarrow 0.4 < \sqrt{x} < 0.6 \Rightarrow 0.16 < x < 0.36$
 Step 2: $\left|x - \frac{1}{4}\right| < \delta \Rightarrow -\delta < x - \frac{1}{4} < \delta \Rightarrow -\delta + \frac{1}{4} < x < \delta + \frac{1}{4}$.
 Then $-\delta + \frac{1}{4} = 0.16 \Rightarrow \delta = 0.09$ or $\delta + \frac{1}{4} = 0.36 \Rightarrow \delta = 0.11$; thus $\delta = 0.09$.
19. Step 1: $\left|\sqrt{19-x} - 3\right| < 1 \Rightarrow -1 < \sqrt{19-x} - 3 < 1 \Rightarrow 2 < \sqrt{19-x} < 4 \Rightarrow 4 < 19-x < 16$
 $\Rightarrow -4 > x - 19 > -16 \Rightarrow 15 > x > 3$ or $3 < x < 15$
 Step 2: $|x - 10| < \delta \Rightarrow -\delta < x - 10 < \delta \Rightarrow -\delta + 10 < x < \delta + 10$.
 Then $-\delta + 10 = 3 \Rightarrow \delta = 7$, or $\delta + 10 = 15 \Rightarrow \delta = 5$; thus $\delta = 5$.
20. Step 1: $\left|\sqrt{x-7} - 4\right| < 1 \Rightarrow -1 < \sqrt{x-7} - 4 < 1 \Rightarrow 3 < \sqrt{x-7} < 5 \Rightarrow 9 < x-7 < 25 \Rightarrow 16 < x < 32$
 Step 2: $|x - 23| < \delta \Rightarrow -\delta < x - 23 < \delta \Rightarrow -\delta + 23 < x < \delta + 23$.
 Then $-\delta + 23 = 16 \Rightarrow \delta = 7$, or $\delta + 23 = 32 \Rightarrow \delta = 9$; thus $\delta = 7$.
21. Step 1: $\left|\frac{1}{x} - \frac{1}{4}\right| < 0.05 \Rightarrow -0.05 < \frac{1}{x} - \frac{1}{4} < 0.05 \Rightarrow 0.2 < \frac{1}{x} < 0.3 \Rightarrow \frac{10}{2} > x > \frac{10}{3}$ or $\frac{10}{3} < x < 5$.
 Step 2: $|x - 4| < \delta \Rightarrow -\delta < x - 4 < \delta \Rightarrow -\delta + 4 < x < \delta + 4$.
 Then $-\delta + 4 = \frac{10}{3}$ or $\delta = \frac{2}{3}$, or $\delta + 4 = 5$ or $\delta = 1$; thus $\delta = \frac{2}{3}$.
22. Step 1: $|x^2 - 3| < 0.1 \Rightarrow -0.1 < x^2 - 3 < 0.1 \Rightarrow 2.9 < x^2 < 3.1 \Rightarrow \sqrt{2.9} < x < \sqrt{3.1}$
 Step 2: $|x - \sqrt{3}| < \delta \Rightarrow -\delta < x - \sqrt{3} < \delta \Rightarrow -\delta + \sqrt{3} < x < \delta + \sqrt{3}$.
 Then $-\delta + \sqrt{3} = \sqrt{2.9} \Rightarrow \delta = \sqrt{3} - \sqrt{2.9} \approx 0.0291$, or $\delta + \sqrt{3} = \sqrt{3.1} \Rightarrow \delta = \sqrt{3.1} - \sqrt{3} \approx 0.0286$;
 thus $\delta = 0.0286$
23. Step 1: $|x^2 - 4| < 0.5 \Rightarrow -0.5 < x^2 - 4 < 0.5 \Rightarrow 3.5 < x^2 < 4.5 \Rightarrow \sqrt{3.5} < |x| < \sqrt{4.5} \Rightarrow -\sqrt{4.5} < x < -\sqrt{3.5}$,
 for x near -2 .
 Step 2: $|x - (-2)| < \delta \Rightarrow -\delta < x + 2 < \delta \Rightarrow -\delta - 2 < x < \delta - 2$.
 Then $-\delta - 2 = -\sqrt{4.5} \Rightarrow \delta = \sqrt{4.5} - 2 \approx 0.1213$, or $\delta - 2 = -\sqrt{3.5} \Rightarrow \delta = 2 - \sqrt{3.5} \approx 0.1292$;
 thus $\delta = \sqrt{4.5} - 2 \approx 0.12$.
24. Step 1: $\left|\frac{1}{x} - (-1)\right| < 0.1 \Rightarrow -0.1 < \frac{1}{x} + 1 < 0.1 \Rightarrow -\frac{11}{10} < \frac{1}{x} < -\frac{9}{10} \Rightarrow -\frac{10}{11} > x > -\frac{10}{9}$ or $-\frac{10}{9} < x < -\frac{10}{11}$.
 Step 2: $|x - (-1)| < \delta \Rightarrow -\delta < x + 1 < \delta \Rightarrow -\delta - 1 < x < \delta - 1$.
 Then $-\delta - 1 = -\frac{10}{9} \Rightarrow \delta = \frac{1}{9}$, or $\delta - 1 = -\frac{10}{11} \Rightarrow \delta = \frac{1}{11}$; thus $\delta = \frac{1}{11}$.
25. Step 1: $\left|(x^2 - 5) - 11\right| < 1 \Rightarrow |x^2 - 16| < 1 \Rightarrow -1 < x^2 - 16 < 1 \Rightarrow 15 < x^2 < 17 \Rightarrow \sqrt{15} < x < \sqrt{17}$.
 Step 2: $|x - 4| < \delta \Rightarrow -\delta < x - 4 < \delta \Rightarrow -\delta + 4 < x < \delta + 4$.
 Then $-\delta + 4 = \sqrt{15} \Rightarrow \delta = 4 - \sqrt{15} \approx 0.1270$, or $\delta + 4 = \sqrt{17} \Rightarrow \delta = \sqrt{17} - 4 \approx 0.1231$; thus
 $\delta = \sqrt{17} - 4 \approx 0.12$.
26. Step 1: $\left|\frac{120}{x} - 5\right| < 1 \Rightarrow -1 < \frac{120}{x} - 5 < 1 \Rightarrow 4 < \frac{120}{x} < 6 \Rightarrow \frac{1}{4} > \frac{x}{120} > \frac{1}{6} \Rightarrow 30 > x > 20$ or $20 < x < 30$.
 Step 2: $|x - 24| < \delta \Rightarrow -\delta < x - 24 < \delta \Rightarrow -\delta + 24 < x < \delta + 24$.
 Then $-\delta + 24 = 20 \Rightarrow \delta = 4$, or $\delta + 24 = 30 \Rightarrow \delta = 6$; thus $\delta = 4$.
27. Step 1: $|mx - 2m| < 0.03 \Rightarrow -0.03 < mx - 2m < 0.03 \Rightarrow -0.03 + 2m < mx < 0.03 + 2m \Rightarrow 2 - \frac{0.03}{m} < x < 2 + \frac{0.03}{m}$.
 Step 2: $|x - 2| < \delta \Rightarrow -\delta < x - 2 < \delta \Rightarrow -\delta + 2 < x < \delta + 2$.
 Then $-\delta + 2 = 2 - \frac{0.03}{m} \Rightarrow \delta = \frac{0.03}{m}$, or $\delta + 2 = 2 + \frac{0.03}{m} \Rightarrow \delta = \frac{0.03}{m}$. In either case, $\delta = \frac{0.03}{m}$.

28. Step 1: $|mx - 3m| < c \Rightarrow -c < mx - 3m < c \Rightarrow -c + 3m < mx < c + 3m \Rightarrow 3 - \frac{c}{m} < x < 3 + \frac{c}{m}$
 Step 2: $|x - 3| < \delta \Rightarrow -\delta < x - 3 < \delta \Rightarrow -\delta + 3 < x < \delta + 3$.
 Then $-\delta + 3 = 3 - \frac{c}{m} \Rightarrow \delta = \frac{c}{m}$, or $\delta + 3 = 3 + \frac{c}{m} \Rightarrow \delta = \frac{c}{m}$. In either case, $\delta = \frac{c}{m}$.
29. Step 1: $\left| (mx + b) - \left(\frac{m}{2} + b \right) \right| < c \Rightarrow -c < mx - \frac{m}{2} < c \Rightarrow -c + \frac{m}{2} < mx < c + \frac{m}{2} \Rightarrow \frac{1}{2} - \frac{c}{m} < x < \frac{1}{2} + \frac{c}{m}$.
 Step 2: $\left| x - \frac{1}{2} \right| < \delta \Rightarrow -\delta < x - \frac{1}{2} < \delta \Rightarrow -\delta + \frac{1}{2} < x < \delta + \frac{1}{2}$.
 Then $-\delta + \frac{1}{2} = \frac{1}{2} - \frac{c}{m} \Rightarrow \delta = \frac{c}{m}$, or $\delta + \frac{1}{2} = \frac{1}{2} + \frac{c}{m} \Rightarrow \delta = \frac{c}{m}$. In either case, $\delta = \frac{c}{m}$.
30. Step 1: $\left| (mx + b) - (m + b) \right| < 0.05 \Rightarrow -0.05 < mx - m < 0.05 \Rightarrow -0.05 + m < mx < 0.05 + m$
 $\Rightarrow 1 - \frac{0.05}{m} < x < 1 + \frac{0.05}{m}$.
 Step 2: $|x - 1| < \delta \Rightarrow -\delta < x - 1 < \delta \Rightarrow -\delta + 1 < x < \delta + 1$.
 Then $-\delta + 1 = 1 - \frac{0.05}{m} \Rightarrow \delta = \frac{0.05}{m}$, or $\delta + 1 = 1 + \frac{0.05}{m} \Rightarrow \delta = \frac{0.05}{m}$. In either case, $\delta = \frac{0.05}{m}$.
31. $\lim_{x \rightarrow 3} (3 - 2x) = 3 - 2(3) = -3$
 Step 1: $\left| (3 - 2x) - (-3) \right| < 0.02 \Rightarrow -0.02 < 6 - 2x < 0.02 \Rightarrow -6.02 < -2x < -5.98 \Rightarrow 3.01 > x > 2.99$ or
 $2.99 < x < 3.01$.
 Step 2: $0 < |x - 3| < \delta \Rightarrow -\delta < x - 3 < \delta \Rightarrow -\delta + 3 < x < \delta + 3$.
 Then $-\delta + 3 = 2.99 \Rightarrow \delta = 0.01$, or $\delta + 3 = 3.01 \Rightarrow \delta = 0.01$; thus $\delta = 0.01$.
32. $\lim_{x \rightarrow -1} (-3x - 2) = (-3)(-1) - 2 = 1$
 Step 1: $\left| (-3x - 2) - 1 \right| < 0.03 \Rightarrow -0.03 < -3x - 3 < 0.03 \Rightarrow 0.01 > x + 1 > -0.01 \Rightarrow -1.01 < x < -0.99$.
 Step 2: $|x - (-1)| < \delta \Rightarrow -\delta < x + 1 < \delta \Rightarrow -\delta - 1 < x < \delta - 1$.
 Then $-\delta - 1 = -1.01 \Rightarrow \delta = 0.01$, or $\delta - 1 = -0.99 \Rightarrow \delta = 0.01$; thus $\delta = 0.01$.
33. $\lim_{x \rightarrow 2} \frac{x^2 - 4}{x - 2} = \lim_{x \rightarrow 2} \frac{(x+2)(x-2)}{(x-2)} = \lim_{x \rightarrow 2} (x + 2) = 2 + 2 = 4, x \neq 2$
 Step 1: $\left| \left(\frac{x^2 - 4}{x - 2} \right) - 4 \right| < 0.05 \Rightarrow -0.05 < \frac{(x+2)(x-2)}{(x-2)} - 4 < 0.05 \Rightarrow 3.95 < x + 2 < 4.05, x \neq 2$
 $\Rightarrow 1.95 < x < 2.05, x \neq 2$.
 Step 2: $|x - 2| < \delta \Rightarrow -\delta < x - 2 < \delta \Rightarrow -\delta + 2 < x < \delta + 2$.
 Then $-\delta + 2 = 1.95 \Rightarrow \delta = 0.05$, or $\delta + 2 = 2.05 \Rightarrow \delta = 0.05$; thus $\delta = 0.05$.
34. $\lim_{x \rightarrow -5} \frac{x^2 + 6x + 5}{x + 5} = \lim_{x \rightarrow -5} \frac{(x+5)(x+1)}{(x+5)} = \lim_{x \rightarrow -5} (x + 1) = -4, x \neq -5$.
 Step 1: $\left| \left(\frac{x^2 + 6x + 5}{x + 5} \right) - (-4) \right| < 0.05 \Rightarrow -0.05 < \frac{(x+5)(x+1)}{(x+5)} + 4 < 0.05 \Rightarrow -4.05 < x + 1 < -3.95, x \neq -5$
 $\Rightarrow -5.05 < x < -4.95, x \neq -5$.
 Step 2: $|x - (-5)| < \delta \Rightarrow -\delta < x + 5 < \delta \Rightarrow -\delta - 5 < x < \delta - 5$.
 Then $-\delta - 5 = -5.05 \Rightarrow \delta = 0.05$, or $\delta - 5 = -4.95 \Rightarrow \delta = 0.05$; thus $\delta = 0.05$.
35. $\lim_{x \rightarrow -3} \sqrt{1 - 5x} = \sqrt{1 - 5(-3)} = \sqrt{16} = 4$
 Step 1: $\left| \sqrt{1 - 5x} - 4 \right| < 0.5 \Rightarrow -0.5 < \sqrt{1 - 5x} - 4 < 0.5 \Rightarrow 3.5 < \sqrt{1 - 5x} < 4.5 \Rightarrow 12.25 < 1 - 5x < 20.25$
 $\Rightarrow 11.25 < -5x < 19.25 \Rightarrow -3.85 < x < 2.25$.
 Step 2: $|x - (-3)| < \delta \Rightarrow -\delta < x + 3 < \delta \Rightarrow -\delta - 3 < x < \delta - 3$.
 Then $-\delta - 3 = -3.85 \Rightarrow \delta = 0.85$, or $\delta - 3 = -2.25 \Rightarrow \delta = 0.75$; thus $\delta = 0.75$.

36. $\lim_{x \rightarrow 2} \frac{4}{x} = \frac{4}{2} = 2$
 Step 1: $\left| \frac{4}{x} - 2 \right| < 0.4 \Rightarrow -0.4 < \frac{4}{x} - 2 < 0.4 \Rightarrow 1.6 < \frac{4}{x} < 2.4 \Rightarrow \frac{10}{16} > \frac{x}{4} > \frac{10}{24} \Rightarrow \frac{10}{4} > x > \frac{10}{6}$ or $\frac{5}{3} < x < \frac{5}{2}$.
 Step 2: $|x-2| < \delta \Rightarrow -\delta < x-2 < \delta \Rightarrow -\delta+2 < x < \delta+2$.
 Then $-\delta+2 = \frac{5}{3} \Rightarrow \delta = \frac{1}{3}$, or $\delta+2 = \frac{5}{2} \Rightarrow \delta = \frac{1}{2}$; thus $\delta = \frac{1}{3}$.
37. Step 1: $|(9-x)-5| < \epsilon \Rightarrow -\epsilon < 4-x < \epsilon \Rightarrow -\epsilon-4 < -x < \epsilon-4 \Rightarrow \epsilon+4 > x > 4-\epsilon \Rightarrow 4-\epsilon < x < 4+\epsilon$.
 Step 2: $|x-4| < \delta \Rightarrow -\delta < x-4 < \delta \Rightarrow -\delta+4 < x < \delta+4$.
 Then $-\delta+4 = -\epsilon+4 \Rightarrow \delta = \epsilon$, or $\delta+4 = \epsilon+4 \Rightarrow \delta = \epsilon$. Thus choose $\delta = \epsilon$.
38. Step 1: $|(3x-7)-2| < \epsilon \Rightarrow -\epsilon < 3x-9 < \epsilon \Rightarrow 9-\epsilon < 3x < 9+\epsilon \Rightarrow 3-\frac{\epsilon}{3} < x < 3+\frac{\epsilon}{3}$.
 Step 2: $|x-3| < \delta \Rightarrow -\delta < x-3 < \delta \Rightarrow -\delta+3 < x < \delta+3$.
 Then $-\delta+3 = 3-\frac{\epsilon}{3} \Rightarrow \delta = \frac{\epsilon}{3}$, or $\delta+3 = 3+\frac{\epsilon}{3} \Rightarrow \delta = \frac{\epsilon}{3}$. Thus choose $\delta = \frac{\epsilon}{3}$.
39. Step 1: $|\sqrt{x-5}-2| < \epsilon \Rightarrow -\epsilon < \sqrt{x-5}-2 < \epsilon \Rightarrow 2-\epsilon < \sqrt{x-5} < 2+\epsilon \Rightarrow (2-\epsilon)^2 < x-5 < (2+\epsilon)^2$
 $\Rightarrow (2-\epsilon)^2 + 5 < x < (2+\epsilon)^2 + 5$.
 Step 2: $|x-9| < \delta \Rightarrow -\delta < x-9 < \delta \Rightarrow -\delta+9 < x < \delta+9$.
 Then $-\delta+9 = \epsilon^2 - 4\epsilon + 9 \Rightarrow \delta = 4\epsilon - \epsilon^2$, or $\delta+9 = \epsilon^2 + 4\epsilon + 9 \Rightarrow \delta = 4\epsilon + \epsilon^2$. Thus choose the smaller distance, $\delta = 4\epsilon - \epsilon^2$.
40. Step 1: $|\sqrt{4-x}-2| < \epsilon \Rightarrow -\epsilon < \sqrt{4-x}-2 < \epsilon \Rightarrow 2-\epsilon < \sqrt{4-x} < 2+\epsilon \Rightarrow (2-\epsilon)^2 < 4-x < (2+\epsilon)^2$
 $\Rightarrow -(2+\epsilon)^2 < x-4 < -(2-\epsilon)^2 \Rightarrow -(2+\epsilon)^2 + 4 < x < -(2-\epsilon)^2 + 4$.
 Step 2: $|x-0| < \delta \Rightarrow -\delta < x < \delta$.
 Then $-\delta = -(2+\epsilon)^2 + 4 = -\epsilon^2 - 4\epsilon \Rightarrow \delta = 4\epsilon + \epsilon^2$, or $\delta = -(2-\epsilon)^2 + 4 = 4\epsilon - \epsilon^2$. Thus choose the smaller distance, $\delta = 4\epsilon - \epsilon^2$.
41. Step 1: For $x \neq 1$, $|x^2-1| < \epsilon \Rightarrow -\epsilon < x^2-1 < \epsilon \Rightarrow 1-\epsilon < x^2 < 1+\epsilon \Rightarrow \sqrt{1-\epsilon} < |x| < \sqrt{1+\epsilon}$
 $\Rightarrow \sqrt{1-\epsilon} < x < \sqrt{1+\epsilon}$ near $x=1$.
 Step 2: $|x-1| < \delta \Rightarrow -\delta < x-1 < \delta \Rightarrow -\delta+1 < x < \delta+1$.
 Then $-\delta+1 = \sqrt{1-\epsilon} \Rightarrow \delta = 1-\sqrt{1-\epsilon}$, or $\delta+1 = \sqrt{1+\epsilon} \Rightarrow \delta = \sqrt{1+\epsilon}-1$. Choose
 $\delta = \min\{1-\sqrt{1-\epsilon}, \sqrt{1+\epsilon}-1\}$, that is, the smaller of the two distances.
42. Step 1: For $x \neq -2$, $|x^2-4| < \epsilon \Rightarrow -\epsilon < x^2-4 < \epsilon \Rightarrow 4-\epsilon < x^2 < 4+\epsilon \Rightarrow \sqrt{4-\epsilon} < |x| < \sqrt{4+\epsilon} \Rightarrow -\sqrt{4+\epsilon} < x < -\sqrt{4-\epsilon}$ near $x=-2$.
 Step 2: $|x-(-2)| < \delta \Rightarrow -\delta < x+2 < \delta \Rightarrow -\delta-2 < x < \delta-2$.
 Then $-\delta-2 = -\sqrt{4+\epsilon} \Rightarrow \delta = \sqrt{4+\epsilon}-2$, or $\delta-2 = -\sqrt{4-\epsilon} \Rightarrow \delta = 2-\sqrt{4-\epsilon}$. Choose
 $\delta = \min\{\sqrt{4+\epsilon}-2, 2-\sqrt{4-\epsilon}\}$.
43. Step 1: $\left| \frac{1}{x} - 1 \right| < \epsilon \Rightarrow -\epsilon < \frac{1}{x} - 1 < \epsilon \Rightarrow 1-\epsilon < \frac{1}{x} < 1+\epsilon \Rightarrow \frac{1}{1+\epsilon} < x < \frac{1}{1-\epsilon}$.
 Step 2: $|x-1| < \delta \Rightarrow -\delta < x-1 < \delta \Rightarrow 1-\delta < x < 1+\delta$.
 Then $1-\delta = \frac{1}{1+\epsilon} \Rightarrow \delta = 1 - \frac{1}{1+\epsilon} = \frac{\epsilon}{1+\epsilon}$, or $1+\delta = \frac{1}{1-\epsilon} \Rightarrow \delta = \frac{1}{1-\epsilon} - 1 = \frac{\epsilon}{1-\epsilon}$.
 Choose $\delta = \frac{\epsilon}{1+\epsilon}$, the smaller of the two distances.
44. Step 1: $\left| \frac{1}{x^2} - \frac{1}{3} \right| < \epsilon \Rightarrow -\epsilon < \frac{1}{x^2} - \frac{1}{3} < \epsilon \Rightarrow \frac{1}{3} - \epsilon < \frac{1}{x^2} < \frac{1}{3} + \epsilon \Rightarrow \frac{1-3\epsilon}{3} < \frac{1}{x^2} < \frac{1+3\epsilon}{3}$
 $\Rightarrow \frac{3}{1-3\epsilon} > x^2 > \frac{3}{1+3\epsilon} \Rightarrow \sqrt{\frac{3}{1+3\epsilon}} < |x| < \sqrt{\frac{3}{1-3\epsilon}}$, or $\sqrt{\frac{3}{1+3\epsilon}} < x < \sqrt{\frac{3}{1-3\epsilon}}$ for x near $\sqrt{3}$.

Step 2: $|x - \sqrt{3}| < \delta \Rightarrow -\delta < x - \sqrt{3} < \delta \Rightarrow \sqrt{3} - \delta < x < \sqrt{3} + \delta.$

Then $\sqrt{3} - \delta = \sqrt{\frac{3}{1+3\epsilon}} \Rightarrow \delta = \sqrt{3} - \sqrt{\frac{3}{1+3\epsilon}}$, or $\sqrt{3} + \delta = \sqrt{\frac{3}{1-3\epsilon}} \Rightarrow \delta = \sqrt{\frac{3}{1-3\epsilon}} - \sqrt{3}.$

Choose $\delta = \min\left\{\sqrt{3} - \sqrt{\frac{3}{1+3\epsilon}}, \sqrt{\frac{3}{1-3\epsilon}} - \sqrt{3}\right\}.$

45. Step 1: $\left|\left(\frac{x^2-9}{x+3}\right) - (-6)\right| < \epsilon \Rightarrow -\epsilon < (x-3) + 6 < \epsilon, x \neq -3 \Rightarrow -\epsilon < x+3 < \epsilon \Rightarrow -\epsilon-3 < x < \epsilon-3.$

Step 2: $|x - (-3)| < \delta \Rightarrow -\delta < x+3 < \delta \Rightarrow -\delta-3 < x < \delta-3.$

Then $-\delta-3 = -\epsilon-3 \Rightarrow \delta = \epsilon$, or $\delta-3 = \epsilon-3 \Rightarrow \delta = \epsilon$. Choose $\delta = \epsilon$.

46. Step 1: $\left|\left(\frac{x^2-1}{x-1}\right) - 2\right| < \epsilon \Rightarrow -\epsilon < (x+1) - 2 < \epsilon, x \neq 1 \Rightarrow 1-\epsilon < x < 1+\epsilon.$

Step 2: $|x-1| < \delta \Rightarrow -\delta < x-1 < \delta \Rightarrow 1-\delta < x < 1+\delta.$

Then $1-\delta = 1-\epsilon \Rightarrow \delta = \epsilon$, or $1+\delta = 1+\epsilon \Rightarrow \delta = \epsilon$. Choose $\delta = \epsilon$.

47. Step 1: $x < 1: |(4-2x) - 2| < \epsilon \Rightarrow 0 < 2-2x < \epsilon$ since $x < 1$. Thus, $1 - \frac{\epsilon}{2} < x < 0$;

$x \geq 1: |(6x-4) - 2| < \epsilon \Rightarrow 0 \leq 6x-6 < \epsilon$ since $x \geq 1$. Thus, $1 \leq x < 1 + \frac{\epsilon}{6}.$

Step 2: $|x-1| < \delta \Rightarrow -\delta < x-1 < \delta \Rightarrow 1-\delta < x < 1+\delta.$

Then $1-\delta = 1 - \frac{\epsilon}{2} \Rightarrow \delta = \frac{\epsilon}{2}$, or $1+\delta = 1 + \frac{\epsilon}{6} \Rightarrow \delta = \frac{\epsilon}{6}$. Choose $\delta = \frac{\epsilon}{6}$.

48. Step 1: $x < 0: |2x-0| < \epsilon \Rightarrow -\epsilon < 2x < 0 \Rightarrow -\frac{\epsilon}{2} < x < 0$;

$x \geq 0: \left|\frac{x}{2} - 0\right| < \epsilon \Rightarrow 0 \leq x < 2\epsilon.$

Step 2: $|x-0| < \delta \Rightarrow -\delta < x < \delta.$

Then $-\delta = -\frac{\epsilon}{2} \Rightarrow \delta = \frac{\epsilon}{2}$, or $\delta = 2\epsilon \Rightarrow \delta = 2\epsilon$. Choose $\delta = \frac{\epsilon}{2}$.

49. By the figure, $-x \leq x \sin \frac{1}{x} \leq x$ for all $x > 0$ and $-x \geq x \sin \frac{1}{x} \geq x$ for $x < 0$. Since $\lim_{x \rightarrow 0} (-x) = \lim_{x \rightarrow 0} x = 0$, then by the sandwich theorem, in either case, $\lim_{x \rightarrow 0} x \sin \frac{1}{x} = 0$.

50. By the figure, $-x^2 \leq x^2 \sin \frac{1}{x} \leq x^2$ for all x except possibly at $x = 0$. Since $\lim_{x \rightarrow 0} (-x^2) = \lim_{x \rightarrow 0} x^2 = 0$, then by the sandwich theorem, $\lim_{x \rightarrow 0} x^2 \sin \frac{1}{x} = 0$.

51. As x approaches the value 0, the values of $g(x)$ approach k . Thus for every number $\epsilon > 0$, there exists a $\delta > 0$ such that $0 < |x-0| < \delta \Rightarrow |g(x) - k| < \epsilon$.

52. Write $x = h + c$. Then $0 < |x-c| < \delta \Leftrightarrow -\delta < x-c < \delta, x \neq c \Leftrightarrow -\delta < (h+c) - c < \delta, h+c \neq c \Leftrightarrow -\delta < h < \delta, h \neq 0 \Leftrightarrow 0 < |h-0| < \delta.$

Thus, $\lim_{x \rightarrow c} f(x) = L \Leftrightarrow$ for any $\epsilon > 0$, there exists $\delta > 0$ such that $|f(x) - L| < \epsilon$ whenever $0 < |x-c| < \delta \Leftrightarrow$

$|f(h+c) - L| < \epsilon$ whenever $0 < |h-0| < \delta \Leftrightarrow \lim_{h \rightarrow 0} f(h+c) = L.$

53. Let $f(x) = x^2$. The function values do get closer to -1 as x approaches 0, but $\lim_{x \rightarrow 0} f(x) = 0$, not -1 . The function $f(x) = x^2$ never gets arbitrarily close to -1 for x near 0.

54. Let $f(x) = \sin x$, $L = \frac{1}{2}$, and $x_0 = 0$. There exists a value of x (namely $x = \frac{\pi}{6}$) for which $|\sin x - \frac{1}{2}| < \epsilon$ for any given $\epsilon > 0$. However, $\lim_{x \rightarrow 0} \sin x = 0$, not $\frac{1}{2}$. The wrong statement does not require x to be arbitrarily close to x_0 . As another example, let $g(x) = \sin \frac{1}{x}$, $L = \frac{1}{2}$, and $x_0 = 0$. We can choose infinitely many values of x near 0 such that $\sin \frac{1}{x} = \frac{1}{2}$ as you can see from the accompanying figure. However, $\lim_{x \rightarrow 0} \sin \frac{1}{x}$ fails to exist. The wrong statement does not require all values of x arbitrarily close to $x_0 = 0$ to lie within $\epsilon > 0$ of $L = \frac{1}{2}$. Again you can see from the figure that there are also infinitely many values of x near 0 such that $\sin \frac{1}{x} = 0$. If we choose $\epsilon < \frac{1}{4}$ we cannot satisfy the inequality $|\sin \frac{1}{x} - \frac{1}{2}| < \epsilon$ for all values of x sufficiently near $x_0 = 0$.

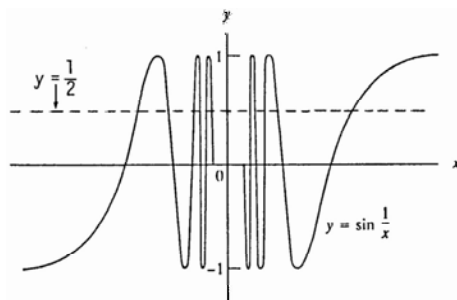

55. $|A - 9| \leq 0.01 \Rightarrow -0.01 \leq \pi \left(\frac{x}{2}\right)^2 - 9 \leq 0.01 \Rightarrow 8.99 \leq \frac{\pi x^2}{4} \leq 9.01 \Rightarrow \frac{4}{\pi}(8.99) \leq x^2 \leq \frac{4}{\pi}(9.01)$
 $\Rightarrow 2\sqrt{\frac{8.99}{\pi}} \leq x \leq 2\sqrt{\frac{9.01}{\pi}}$ or $3.384 \leq x \leq 3.387$. To be safe, the left endpoint was rounded up and the right endpoint was rounded down.
56. $V = RI \Rightarrow \frac{V}{R} = I \Rightarrow \left|\frac{V}{R} - 5\right| \leq 0.1 \Rightarrow -0.1 \leq \frac{120}{R} - 5 \leq 0.1 \Rightarrow 4.9 \leq \frac{120}{R} \leq 5.1 \Rightarrow \frac{10}{49} \geq \frac{R}{120} \geq \frac{10}{51}$
 $\Rightarrow \frac{(120)(10)}{51} \leq R \leq \frac{(120)(10)}{49} \Rightarrow 23.53 \leq R \leq 24.48$.
 To be safe, the left endpoint was rounded up and the right endpoint was rounded down.
57. (a) $-\delta < x - 1 < 0 \Rightarrow 1 - \delta < x < 1 \Rightarrow f(x) = x$. Then $|f(x) - 2| = |x - 2| = 2 - x > 2 - 1 = 1$. That is, $|f(x) - 2| \geq 1 \geq \frac{1}{2}$ no matter how small δ is taken when $1 - \delta < x < 1 \Rightarrow \lim_{x \rightarrow 1} f(x) \neq 2$.
- (b) $0 < x - 1 < \delta \Rightarrow 1 < x < 1 + \delta \Rightarrow f(x) = x + 1$. Then $|f(x) - 1| = |(x + 1) - 1| = |x| = x > 1$. That is, $|f(x) - 1| \geq 1$ no matter how small δ is taken when $1 < x < 1 + \delta \Rightarrow \lim_{x \rightarrow 1} f(x) \neq 1$.
- (c) $-\delta < x - 1 < 0 \Rightarrow 1 - \delta < x < 1 \Rightarrow f(x) = x$. Then $|f(x) - 1.5| = |x - 1.5| = 1.5 - x > 1.5 - 1 = 0.5$. Also, $0 < x - 1 < \delta \Rightarrow 1 < x < 1 + \delta \Rightarrow f(x) = x + 1$. Then $|f(x) - 1.5| = |(x + 1) - 1.5| = |x - 0.5| = x - 0.5 > 1 - 0.5 = 0.5$. Thus, no matter how small δ is taken, there exists a value of x such that $-\delta < x - 1 < \delta$ but $|f(x) - 1.5| \geq \frac{1}{2} \Rightarrow \lim_{x \rightarrow 1} f(x) \neq 1.5$.
58. (a) For $2 < x < 2 + \delta \Rightarrow h(x) = 2 \Rightarrow |h(x) - 4| = 2$. Thus for $\epsilon < 2$, $|h(x) - 4| \geq \epsilon$ whenever $2 < x < 2 + \delta$ no matter how small we choose $\delta > 0 \Rightarrow \lim_{x \rightarrow 2} h(x) \neq 4$.
- (b) For $2 < x < 2 + \delta \Rightarrow h(x) = 2 \Rightarrow |h(x) - 3| = 1$. Thus for $\epsilon < 1$, $|h(x) - 3| \geq \epsilon$ whenever $2 < x < 2 + \delta$ no matter how small we choose $\delta > 0 \Rightarrow \lim_{x \rightarrow 2} h(x) \neq 3$.
- (c) For $2 - \delta < x < 2 \Rightarrow h(x) = x^2$ so $|h(x) - 2| = |x^2 - 2|$. No matter how small $\delta > 0$ is chosen, x^2 is close to 4 when x is near 2 and to the left on the real line $\Rightarrow |x^2 - 2|$ will be close to 2. Thus if $\epsilon < 1$, $|h(x) - 2| \geq \epsilon$ whenever $2 - \delta < x < 2$ no matter how small we choose $\delta > 0 \Rightarrow \lim_{x \rightarrow 2} h(x) \neq 2$.

59. (a) For $3 - \delta < x < 3 \Rightarrow f(x) > 4.8 \Rightarrow |f(x) - 4| \geq 0.8$. Thus for $\epsilon < 0.8$, $|f(x) - 4| \geq \epsilon$ whenever $3 - \delta < x < 3$ no matter how small we choose $\delta > 0 \Rightarrow \lim_{x \rightarrow 3} f(x) \neq 4$.
- (b) For $3 < x < 3 + \delta \Rightarrow f(x) < 3 \Rightarrow |f(x) - 4.8| \geq 1.8$. Thus for $\epsilon < 1.8$, $|f(x) - 4.8| \geq \epsilon$ whenever $3 < x < 3 + \delta$ no matter how small we choose $\delta > 0 \Rightarrow \lim_{x \rightarrow 3} f(x) \neq 4.8$.
- (c) For $3 - \delta < x < 3 \Rightarrow f(x) > 4.8 \Rightarrow |f(x) - 3| \geq 1.8$. Again, for $\epsilon < 1.8$, $|f(x) - 3| \geq \epsilon$ whenever $3 - \delta < x < 3$ no matter how small we choose $\delta > 0 \Rightarrow \lim_{x \rightarrow 3} f(x) \neq 3$.
60. (a) No matter how small we choose $\delta > 0$, for x near -1 satisfying $-1 - \delta < x < -1 + \delta$, the values of $g(x)$ are near $1 \Rightarrow |g(x) - 2|$ is near 1 . Then, for $\epsilon = \frac{1}{2}$ we have $|g(x) - 2| \geq \frac{1}{2}$ for some x satisfying $-1 - \delta < x < -1 + \delta$, or $0 < |x + 1| < \delta \Rightarrow \lim_{x \rightarrow -1} g(x) \neq 2$.
- (b) Yes, $\lim_{x \rightarrow -1} g(x) = 1$ because from the graph we can find a $\delta > 0$ such that $|g(x) - 1| < \epsilon$ if $0 < |x - (-1)| < \delta$.

61-66. Example CAS commands (values of del may vary for a specified eps):

Maple:

```
f := x -> (x^4-81)/(x-3); x0 := 3;
plot( f(x), x=x0-1..x0+1, color=black, # (a)
      title="Section 2.3, #61(a)");
L := limit( f(x), x=x0 ); # (b)
epsilon := 0.2; # (c)
plot( [f(x), L-epsilon, L+epsilon], x=x0-0.01..x0+0.01,
      color=black, linestyle=[1,3,3], title="Section 2.3, #61(c)");
q := fsolve( abs( f(x)-L ) = epsilon, x=x0-1..x0+1 ); # (d)
delta := abs(x0-q);
plot( [f(x), L-epsilon, L+epsilon], x=x0-delta..x0+delta, color=black, title="Section 2.3, #61(d)");
for eps in [0.1, 0.005, 0.001 ] do # (e)
  q := fsolve( abs( f(x)-L ) = eps, x=x0-1..x0+1 );
  delta := abs(x0-q);
  head := sprintf("Section 2.3, #61(e)\n epsilon = %5f, delta = %5f\n", eps, delta );
  print(plot( [f(x), L-eps, L+eps], x=x0-delta..x0+delta,
             color=black, linestyle=[1,3,3], title=head ));
end do;
```

Mathematica (assigned function and values for x0, eps and del may vary):

```
Clear[f, x]
y1 = L - eps; y2 = L + eps; x0 = 1;
f[x_] := (3x^2 - (7x + 1)Sqrt[x] + 5)/(x - 1)
Plot[f[x], {x, x0 - 0.2, x0 + 0.2}]
L := Limit[f[x], x -> x0]
eps = 0.1; del = 0.2;
Plot[{f[x], y1, y2}, {x, x0 - del, x0 + del}, PlotRange -> {L - 2eps, L + 2eps}]
```

2.4 ONE-SIDED LIMITS

1. (a) True (b) True (c) False (d) True
 (e) True (f) True (g) False (h) False
 (i) False (j) False (k) True (l) False

2. (a) True (b) False (c) False (d) True
 (e) True (f) True (g) True (h) True
 (i) True (j) False (k) True

3. (a) $\lim_{x \rightarrow 2^+} f(x) = \frac{2}{2} + 1 = 2$, $\lim_{x \rightarrow 2^-} f(x) = 3 - 2 = 1$
 (b) No, $\lim_{x \rightarrow 2} f(x)$ does not exist because $\lim_{x \rightarrow 2^+} f(x) \neq \lim_{x \rightarrow 2^-} f(x)$
 (c) $\lim_{x \rightarrow 4^-} f(x) = \frac{4}{2} + 1 = 3$, $\lim_{x \rightarrow 4^+} f(x) = \frac{4}{2} + 1 = 3$
 (d) Yes, $\lim_{x \rightarrow 4} f(x) = 3$ because $3 = \lim_{x \rightarrow 4^-} f(x) = \lim_{x \rightarrow 4^+} f(x)$

4. (a) $\lim_{x \rightarrow 2^+} f(x) = \frac{2}{2} = 1$, $\lim_{x \rightarrow 2^-} f(x) = 3 - 2 = 1$, $f(2) = 2$
 (b) Yes, $\lim_{x \rightarrow 2} f(x) = 1$ because $1 = \lim_{x \rightarrow 2^+} f(x) = \lim_{x \rightarrow 2^-} f(x)$
 (c) $\lim_{x \rightarrow -1^-} f(x) = 3 - (-1) = 4$, $\lim_{x \rightarrow -1^+} f(x) = 3 - (-1) = 4$
 (d) Yes, $\lim_{x \rightarrow -1} f(x) = 4$ because $4 = \lim_{x \rightarrow -1^-} f(x) = \lim_{x \rightarrow -1^+} f(x)$

5. (a) No, $\lim_{x \rightarrow 0^+} f(x)$ does not exist since $\sin\left(\frac{1}{x}\right)$ does not approach any single value as x approaches 0
 (b) $\lim_{x \rightarrow 0^-} f(x) = \lim_{x \rightarrow 0^-} 0 = 0$
 (c) $\lim_{x \rightarrow 0} f(x)$ does not exist because $\lim_{x \rightarrow 0^+} f(x)$ does not exist

6. (a) Yes, $\lim_{x \rightarrow 0^+} g(x) = 0$ by the sandwich theorem since $-\sqrt{x} \leq g(x) \leq \sqrt{x}$ when $x > 0$
 (b) No, $\lim_{x \rightarrow 0^-} g(x)$ does not exist since \sqrt{x} is not defined for $x < 0$
 (c) No, $\lim_{x \rightarrow 0} g(x)$ does not exist since $\lim_{x \rightarrow 0^-} g(x)$ does not exist

7. (a)

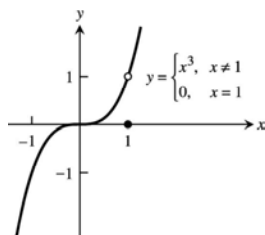

- (b) $\lim_{x \rightarrow 1^-} f(x) = 1 = \lim_{x \rightarrow 1^+} f(x)$
 (c) Yes, $\lim_{x \rightarrow 1} f(x) = 1$ since the right-hand and left-hand limits exist and equal 1

8. (a)

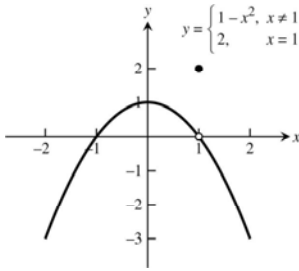

(b) $\lim_{x \rightarrow 1^+} f(x) = 0 = \lim_{x \rightarrow 1^-} f(x)$

(c) Yes, $\lim_{x \rightarrow 1} f(x) = 0$ since the right-hand and left-hand limits exist and equal 0

9. (a) domain: $0 \leq x \leq 2$
range: $0 < y \leq 1$ and $y = 2$

- (b) $\lim_{x \rightarrow c} f(x)$ exists for c belonging to $(0, 1) \cup (1, 2)$
 (c) $x = 2$
 (d) $x = 0$

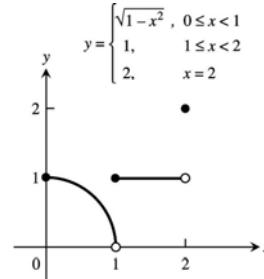

10. (a) domain: $-\infty < x < \infty$
range: $-1 \leq y \leq 1$
 (b) $\lim_{x \rightarrow c} f(x)$ exists for c belonging to $(-\infty, -1) \cup (-1, 1) \cup (1, \infty)$
 (c) none
 (d) none

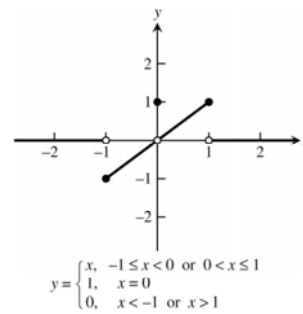

11. $\lim_{x \rightarrow -0.5^-} \sqrt{\frac{x+2}{x-1}} = \sqrt{\frac{-0.5+2}{-0.5-1}} = \sqrt{\frac{3/2}{-1/2}} = \sqrt{3}$

12. $\lim_{x \rightarrow 1^+} \sqrt{\frac{x-1}{x+2}} = \sqrt{\frac{1-1}{1+2}} = \sqrt{0} = 0$

13. $\lim_{x \rightarrow -2^+} \left(\frac{x}{x+1}\right) \left(\frac{2x+5}{x^2+x}\right) = \left(\frac{-2}{-2+1}\right) \left(\frac{2(-2)+5}{(-2)^2+(-2)}\right) = (2) \left(\frac{1}{2}\right) = 1$

14. $\lim_{x \rightarrow 1^-} \left(\frac{1}{x+1}\right) \left(\frac{x+6}{x}\right) \left(\frac{3-x}{7}\right) = \left(\frac{1}{1+1}\right) \left(\frac{1+6}{1}\right) \left(\frac{3-1}{7}\right) = \left(\frac{1}{2}\right) \left(\frac{7}{1}\right) \left(\frac{2}{7}\right) = 1$

15. $\lim_{h \rightarrow 0^+} \frac{\sqrt{h^2+4h+5}-\sqrt{5}}{h} = \lim_{h \rightarrow 0^+} \left(\frac{\sqrt{h^2+4h+5}-\sqrt{5}}{h}\right) \left(\frac{\sqrt{h^2+4h+5}+\sqrt{5}}{\sqrt{h^2+4h+5}+\sqrt{5}}\right) = \lim_{h \rightarrow 0^+} \frac{(h^2+4h+5)-5}{h(\sqrt{h^2+4h+5}+\sqrt{5})}$
 $= \lim_{h \rightarrow 0^+} \frac{h(h+4)}{h(\sqrt{h^2+4h+5}+\sqrt{5})} = \frac{0+4}{\sqrt{5}+\sqrt{5}} = \frac{2}{\sqrt{5}}$

16. $\lim_{h \rightarrow 0^-} \frac{\sqrt{6-\sqrt{5h^2+11h+6}}}{h} = \lim_{h \rightarrow 0^-} \left(\frac{\sqrt{6-\sqrt{5h^2+11h+6}}}{h}\right) \left(\frac{\sqrt{6+\sqrt{5h^2+11h+6}}}{\sqrt{6+\sqrt{5h^2+11h+6}}}\right)$
 $= \lim_{h \rightarrow 0^-} \frac{6-(5h^2+11h+6)}{h(\sqrt{6+\sqrt{5h^2+11h+6}})} = \lim_{h \rightarrow 0^-} \frac{-h(5h+11)}{h(\sqrt{6+\sqrt{5h^2+11h+6}})} = \frac{-(0+11)}{\sqrt{6}+\sqrt{6}} = -\frac{11}{2\sqrt{6}}$

17. (a) $\lim_{x \rightarrow -2^+} (x+3) \frac{|x+2|}{x+2} = \lim_{x \rightarrow -2^+} (x+3) \frac{(x+2)}{(x+2)} \quad (|x+2| = (x+2) \text{ for } x > -2)$
 $= \lim_{x \rightarrow -2^+} (x+3) = ((-2)+3) = 1$

(b) $\lim_{x \rightarrow -2^-} (x+3) \frac{|x+2|}{x+2} = \lim_{x \rightarrow -2^-} (x+3) \left[\frac{-(x+2)}{(x+2)} \right] \quad (|x+2| = -(x+2) \text{ for } x < -2)$
 $= \lim_{x \rightarrow -2^-} (x+3)(-1) = -((-2)+3) = -1$

18. (a) $\lim_{x \rightarrow 1^+} \frac{\sqrt{2x(x-1)}}{|x-1|} = \lim_{x \rightarrow 1^+} \frac{\sqrt{2x(x-1)}}{(x-1)} \quad (|x-1| = x-1 \text{ for } x > 1)$
 $= \lim_{x \rightarrow 1^+} \sqrt{2x} = \sqrt{2}$

(b) $\lim_{x \rightarrow 1^-} \frac{\sqrt{2x(x-1)}}{|x-1|} = \lim_{x \rightarrow 1^-} \frac{\sqrt{2x(x-1)}}{-(x-1)} \quad (|x-1| = -(x-1) \text{ for } x < 1)$
 $= \lim_{x \rightarrow 1^-} -\sqrt{2x} = -\sqrt{2}$

19. (a) $\lim_{\theta \rightarrow 3^+} \frac{|\theta|}{\theta} = \frac{3}{3} = 1$

(b) $\lim_{\theta \rightarrow 3^-} \frac{|\theta|}{\theta} = \frac{2}{3}$

20. (a) $\lim_{t \rightarrow 4^+} (t - \lfloor t \rfloor) = 4 - 4 = 0$

(b) $\lim_{t \rightarrow 4^-} (t - \lfloor t \rfloor) = 4 - 3 = 1$

21. $\lim_{\theta \rightarrow 0} \frac{\sin \sqrt{2}\theta}{\sqrt{2}\theta} = \lim_{x \rightarrow 0} \frac{\sin x}{x} = 1 \quad (\text{where } x = \sqrt{2}\theta)$

22. $\lim_{t \rightarrow 0} \frac{\sin kt}{t} = \lim_{t \rightarrow 0} \frac{k \sin kt}{kt} = \lim_{\theta \rightarrow 0} \frac{k \sin \theta}{\theta} = k \lim_{\theta \rightarrow 0} \frac{\sin \theta}{\theta} = k \cdot 1 = k \quad (\text{where } \theta = kt)$

23. $\lim_{y \rightarrow 0} \frac{\sin 3y}{4y} = \frac{1}{4} \lim_{y \rightarrow 0} \frac{3 \sin 3y}{3y} = \frac{3}{4} \lim_{y \rightarrow 0} \frac{\sin 3y}{3y} = \frac{3}{4} \lim_{\theta \rightarrow 0} \frac{\sin \theta}{\theta} = \frac{3}{4} \quad (\text{where } \theta = 3y)$

24. $\lim_{h \rightarrow 0^-} \frac{h}{\sin 3h} = \lim_{h \rightarrow 0^-} \left(\frac{1}{3} \cdot \frac{3h}{\sin 3h} \right) = \frac{1}{3} \lim_{h \rightarrow 0^-} \frac{1}{\left(\frac{\sin 3h}{3h} \right)} = \frac{1}{3} \left(\frac{1}{\lim_{\theta \rightarrow 0^-} \frac{\sin \theta}{\theta}} \right) = \frac{1}{3} \cdot 1 = \frac{1}{3} \quad (\text{where } \theta = 3h)$

25. $\lim_{x \rightarrow 0} \frac{\tan 2x}{x} = \lim_{x \rightarrow 0} \frac{\left(\frac{\sin 2x}{\cos 2x} \right)}{x} = \lim_{x \rightarrow 0} \frac{\sin 2x}{x \cos 2x} = \left(\lim_{x \rightarrow 0} \frac{1}{\cos 2x} \right) \left(\lim_{x \rightarrow 0} \frac{2 \sin 2x}{2x} \right) = 1 \cdot 2 = 2$

26. $\lim_{t \rightarrow 0} \frac{2t}{\tan t} = 2 \lim_{t \rightarrow 0} \frac{t}{\left(\frac{\sin t}{\cos t} \right)} = 2 \lim_{t \rightarrow 0} \frac{t \cos t}{\sin t} = 2 \left(\lim_{t \rightarrow 0} \cos t \right) \left(\frac{1}{\lim_{t \rightarrow 0} \frac{\sin t}{t}} \right) = 2 \cdot 1 \cdot 1 = 2$

27. $\lim_{x \rightarrow 0} \frac{x \csc 2x}{\cos 5x} = \lim_{x \rightarrow 0} \left(\frac{x}{\sin 2x} \cdot \frac{1}{\cos 5x} \right) = \left(\frac{1}{2} \lim_{x \rightarrow 0} \frac{2x}{\sin 2x} \right) \left(\lim_{x \rightarrow 0} \frac{1}{\cos 5x} \right) = \left(\frac{1}{2} \cdot 1 \right) (1) = \frac{1}{2}$

28. $\lim_{x \rightarrow 0} 6x^2 (\cot x)(\csc 2x) = \lim_{x \rightarrow 0} \frac{6x^2 \cos x}{\sin x \sin 2x} = \lim_{x \rightarrow 0} \left(3 \cos x \cdot \frac{x}{\sin x} \cdot \frac{2x}{\sin 2x} \right) = 3 \cdot 1 \cdot 1 = 3$

29. $\lim_{x \rightarrow 0} \frac{x+x \cos x}{\sin x \cos x} = \lim_{x \rightarrow 0} \left(\frac{x}{\sin x \cos x} + \frac{x \cos x}{\sin x \cos x} \right) = \lim_{x \rightarrow 0} \left(\frac{x}{\sin x} \cdot \frac{1}{\cos x} \right) + \lim_{x \rightarrow 0} \frac{x}{\sin x}$
 $= \lim_{x \rightarrow 0} \left(\frac{1}{\frac{\sin x}{x}} \right) \cdot \lim_{x \rightarrow 0} \left(\frac{1}{\cos x} \right) + \lim_{x \rightarrow 0} \left(\frac{1}{\frac{\sin x}{x}} \right) = (1)(1) + 1 = 2$

$$30. \lim_{x \rightarrow 0} \frac{x^2 - x + \sin x}{2x} = \lim_{x \rightarrow 0} \left(\frac{x}{2} - \frac{1}{2} + \frac{1}{2} \left(\frac{\sin x}{x} \right) \right) = 0 - \frac{1}{2} + \frac{1}{2}(1) = 0$$

$$31. \lim_{\theta \rightarrow 0} \frac{1 - \cos \theta}{\sin 2\theta} = \lim_{\theta \rightarrow 0} \frac{(1 - \cos \theta)(1 + \cos \theta)}{(2 \sin \theta \cos \theta)(1 + \cos \theta)} = \lim_{\theta \rightarrow 0} \frac{1 - \cos^2 \theta}{(2 \sin \theta \cos \theta)(1 + \cos \theta)} = \lim_{\theta \rightarrow 0} \frac{\sin^2 \theta}{(2 \sin \theta \cos \theta)(1 + \cos \theta)}$$

$$= \lim_{\theta \rightarrow 0} \frac{\sin \theta}{(2 \cos \theta)(1 + \cos \theta)} = \frac{0}{(2)(2)} = 0$$

$$32. \lim_{x \rightarrow 0} \frac{x - x \cos x}{\sin^2 3x} = \lim_{x \rightarrow 0} \frac{x(1 - \cos x)}{\sin^2 3x} = \lim_{x \rightarrow 0} \frac{\frac{x(1 - \cos x)}{9x^2}}{\frac{\sin^2 3x}{9x^2}} = \lim_{x \rightarrow 0} \frac{\frac{1 - \cos x}{9x}}{\left(\frac{\sin 3x}{3x} \right)^2} = \frac{\frac{1}{9} \lim_{x \rightarrow 0} \left(\frac{1 - \cos x}{x} \right)}{\lim_{x \rightarrow 0} \left(\frac{\sin 3x}{3x} \right)^2} = \frac{\frac{1}{9}(0)}{1^2} = 0$$

$$33. \lim_{t \rightarrow 0} \frac{\sin(1 - \cos t)}{1 - \cos t} = \lim_{\theta \rightarrow 0} \frac{\sin \theta}{\theta} = 1 \text{ since } \theta = 1 - \cos t \rightarrow 0 \text{ as } t \rightarrow 0$$

$$34. \lim_{h \rightarrow 0} \frac{\sin(\sin h)}{\sin h} = \lim_{\theta \rightarrow 0} \frac{\sin \theta}{\theta} = 1 \text{ since } \theta = \sin h \rightarrow 0 \text{ as } h \rightarrow 0$$

$$35. \lim_{\theta \rightarrow 0} \frac{\sin \theta}{\sin 2\theta} = \lim_{\theta \rightarrow 0} \left(\frac{\sin \theta}{\sin 2\theta} \cdot \frac{2\theta}{2\theta} \right) = \frac{1}{2} \lim_{\theta \rightarrow 0} \left(\frac{\sin \theta}{\theta} \cdot \frac{2\theta}{\sin 2\theta} \right) = \frac{1}{2} \cdot 1 \cdot 1 = \frac{1}{2}$$

$$36. \lim_{x \rightarrow 0} \frac{\sin 5x}{\sin 4x} = \lim_{x \rightarrow 0} \left(\frac{\sin 5x}{\sin 4x} \cdot \frac{4x}{5x} \cdot \frac{5}{4} \right) = \frac{5}{4} \lim_{x \rightarrow 0} \left(\frac{\sin 5x}{5x} \cdot \frac{4x}{\sin 4x} \right) = \frac{5}{4} \cdot 1 \cdot 1 = \frac{5}{4}$$

$$37. \lim_{\theta \rightarrow 0} \theta \cos \theta = 0 \cdot 1 = 0$$

$$38. \lim_{\theta \rightarrow 0} \sin \theta \cot 2\theta = \lim_{\theta \rightarrow 0} \sin \theta \frac{\cos 2\theta}{\sin 2\theta} = \lim_{\theta \rightarrow 0} \sin \theta \frac{\cos 2\theta}{2 \sin \theta \cos \theta} = \lim_{\theta \rightarrow 0} \frac{\cos 2\theta}{2 \cos \theta} = \frac{1}{2}$$

$$39. \lim_{x \rightarrow 0} \frac{\tan 3x}{\sin 8x} = \lim_{x \rightarrow 0} \left(\frac{\sin 3x}{\cos 3x} \cdot \frac{1}{\sin 8x} \right) = \lim_{x \rightarrow 0} \left(\frac{\sin 3x}{\cos 3x} \cdot \frac{1}{\sin 8x} \cdot \frac{8x}{3x} \cdot \frac{3}{8} \right)$$

$$= \frac{3}{8} \lim_{x \rightarrow 0} \left(\frac{1}{\cos 3x} \right) \left(\frac{\sin 3x}{3x} \right) \left(\frac{8x}{\sin 8x} \right) = \frac{3}{8} \cdot 1 \cdot 1 \cdot 1 = \frac{3}{8}$$

$$40. \lim_{y \rightarrow 0} \frac{\sin 3y \cot 5y}{y \cot 4y} = \lim_{y \rightarrow 0} \frac{\sin 3y \sin 4y \cos 5y}{y \cos 4y \sin 5y} = \lim_{y \rightarrow 0} \left(\frac{\sin 3y}{y} \right) \left(\frac{\sin 4y}{\cos 4y} \right) \left(\frac{\cos 5y}{\sin 5y} \right) \left(\frac{3 \cdot 4 \cdot 5y}{3 \cdot 4 \cdot 5y} \right)$$

$$= \lim_{y \rightarrow 0} \left(\frac{\sin 3y}{3y} \right) \left(\frac{\sin 4y}{4y} \right) \left(\frac{5y}{\sin 5y} \right) \left(\frac{\cos 5y}{\cos 4y} \right) \left(\frac{3 \cdot 4}{5} \right) = 1 \cdot 1 \cdot 1 \cdot 1 \cdot \frac{12}{5} = \frac{12}{5}$$

$$41. \lim_{\theta \rightarrow 0} \frac{\tan \theta}{\theta^2 \cot 3\theta} = \lim_{\theta \rightarrow 0} \frac{\frac{\sin \theta}{\cos \theta}}{\theta^2 \frac{\cos 3\theta}{\sin 3\theta}} = \lim_{\theta \rightarrow 0} \frac{\sin \theta \sin 3\theta}{\theta^2 \cos \theta \cos 3\theta} = \lim_{\theta \rightarrow 0} \left(\frac{\sin \theta}{\theta} \right) \left(\frac{\sin 3\theta}{3\theta} \right) \left(\frac{3}{\cos \theta \cos 3\theta} \right) = (1)(1) \left(\frac{3}{1 \cdot 1} \right) = 3$$

$$42. \lim_{\theta \rightarrow 0} \frac{\theta \cot 4\theta}{\sin^2 \theta \cot^2 2\theta} = \lim_{\theta \rightarrow 0} \frac{\frac{\theta \cos 4\theta}{\sin 4\theta}}{\sin^2 \theta \frac{\cos^2 2\theta}{\sin^2 2\theta}} = \lim_{\theta \rightarrow 0} \frac{\theta \cos 4\theta \sin^2 2\theta}{\sin^2 \theta \cos^2 2\theta \sin 4\theta} = \lim_{\theta \rightarrow 0} \frac{\theta \cos 4\theta (2 \sin \theta \cos \theta)^2}{\sin^2 \theta \cos^2 2\theta \sin 4\theta} = \lim_{\theta \rightarrow 0} \frac{\theta \cos 4\theta (4 \sin^2 \theta \cos^2 \theta)}{\sin^2 \theta \cos^2 2\theta \sin 4\theta}$$

$$= \lim_{\theta \rightarrow 0} \frac{4\theta \cos 4\theta \cos^2 \theta}{\cos^2 2\theta \sin 4\theta} = \lim_{\theta \rightarrow 0} \left(\frac{4\theta}{\sin 4\theta} \right) \left(\frac{\cos 4\theta \cos^2 \theta}{\cos^2 2\theta} \right) = \lim_{\theta \rightarrow 0} \left(\frac{1}{\frac{\sin 4\theta}{4\theta}} \right) \left(\frac{\cos 4\theta \cos^2 \theta}{\cos^2 2\theta} \right) = \left(\frac{1}{1} \right) \left(\frac{1 \cdot 1^2}{1^2} \right) = 1$$

43. Yes. If $\lim_{x \rightarrow a^+} f(x) = L = \lim_{x \rightarrow a^-} f(x)$, then $\lim_{x \rightarrow a} f(x) = L$. If $\lim_{x \rightarrow a^+} f(x) \neq \lim_{x \rightarrow a^-} f(x)$, then $\lim_{x \rightarrow a} f(x)$ does not exist.

44. Since $\lim_{x \rightarrow c} f(x) = L$ if and only if $\lim_{x \rightarrow c^+} f(x) = L$ and $\lim_{x \rightarrow c^-} f(x) = L$, then $\lim_{x \rightarrow c} f(x)$ can be found by calculating $\lim_{x \rightarrow c^+} f(x)$.
45. If f is an odd function of x , then $f(-x) = -f(x)$. Given $\lim_{x \rightarrow 0^+} f(x) = 3$, then $\lim_{x \rightarrow 0^-} f(x) = -3$.
46. If f is an even function of x , then $f(-x) = f(x)$. Given $\lim_{x \rightarrow 2^-} f(x) = 7$ then $\lim_{x \rightarrow -2^+} f(x) = 7$. However, nothing can be said about $\lim_{x \rightarrow -2^-} f(x)$ because we don't know $\lim_{x \rightarrow 2^+} f(x)$.
47. $I = (5, 5 + \delta) \Rightarrow 5 < x < 5 + \delta$. Also, $\sqrt{x-5} < \epsilon \Rightarrow x-5 < \epsilon^2 \Rightarrow x < 5 + \epsilon^2$. Choose $\delta = \epsilon^2 \Rightarrow \lim_{x \rightarrow 5^+} \sqrt{x-5} = 0$.
48. $I = (4 - \delta, 4) \Rightarrow 4 - \delta < x < 4$. Also, $\sqrt{4-x} < \epsilon \Rightarrow 4-x < \epsilon^2 \Rightarrow x > 4 - \epsilon^2$. Choose $\delta = \epsilon^2 \Rightarrow \lim_{x \rightarrow 4^-} \sqrt{4-x} = 0$.
49. As $x \rightarrow 0^-$ the number x is always negative. Thus, $\left| \frac{x}{|x|} - (-1) \right| < \epsilon \Rightarrow \left| \frac{x}{-x} + 1 \right| < \epsilon \Rightarrow 0 < \epsilon$ which is always true independent of the value of x . Hence we can choose any $\delta > 0$ with $-\delta < x < 0 \Rightarrow \lim_{x \rightarrow 0^-} \frac{x}{|x|} = -1$.
50. Since $x \rightarrow 2^+$ we have $x > 2$ and $|x-2| = x-2$. Then, $\left| \frac{x-2}{|x-2|} - 1 \right| = \left| \frac{x-2}{x-2} - 1 \right| < \epsilon \Rightarrow 0 < \epsilon$ which is always true so long as $x > 2$. Hence we can choose any $\delta > 0$, and thus $2 < x < 2 + \delta \Rightarrow \left| \frac{x-2}{|x-2|} - 1 \right| < \epsilon$. Thus, $\lim_{x \rightarrow 2^+} \frac{x-2}{|x-2|} = 1$.
51. (a) $\lim_{x \rightarrow 400^+} \lfloor x \rfloor = 400$. Just observe that if $400 < x < 401$, then $\lfloor x \rfloor = 400$. Thus if we choose $\delta = 1$, we have for any number $\epsilon > 0$ that $400 < x < 400 + \delta \Rightarrow \left| \lfloor x \rfloor - 400 \right| = |400 - 400| = 0 < \epsilon$.
- (b) $\lim_{x \rightarrow 400^-} \lfloor x \rfloor = 399$. Just observe that if $399 < x < 400$ then $\lfloor x \rfloor = 399$. Thus if we choose $\delta = 1$, we have for any number $\epsilon > 0$ that $400 - \delta < x < 400 \Rightarrow \left| \lfloor x \rfloor - 399 \right| = |399 - 399| = 0 < \epsilon$.
- (c) Since $\lim_{x \rightarrow 400^+} \lfloor x \rfloor \neq \lim_{x \rightarrow 400^-} \lfloor x \rfloor$ we conclude that $\lim_{x \rightarrow 400} \lfloor x \rfloor$ does not exist.
52. (a) $\lim_{x \rightarrow 0^+} f(x) = \lim_{x \rightarrow 0^+} \sqrt{x} = \sqrt{0} = 0$; $|\sqrt{x} - 0| < \epsilon \Rightarrow -\epsilon < \sqrt{x} < \epsilon \Rightarrow 0 < x < \epsilon^2$ for x positive. Choose $\delta = \epsilon^2 \Rightarrow \lim_{x \rightarrow 0^+} f(x) = 0$.
- (b) $\lim_{x \rightarrow 0^-} f(x) = \lim_{x \rightarrow 0^-} x^2 \sin\left(\frac{1}{x}\right) = 0$ by the sandwich theorem since $-x^2 \leq x^2 \sin\left(\frac{1}{x}\right) \leq x^2$ for all $x \neq 0$. Since $|x^2 - 0| = |-x^2 - 0| = x^2 < \epsilon$ whenever $|x| < \sqrt{\epsilon}$, we choose $\delta = \sqrt{\epsilon}$ and obtain $\left| x^2 \sin\left(\frac{1}{x}\right) - 0 \right| < \epsilon$ if $-\delta < x < 0$.
- (c) The function f has limit 0 at $x_0 = 0$ since both the right-hand and left-hand limits exist and equal 0.

2.5 CONTINUITY

1. No, discontinuous at $x = 2$, not defined at $x = 2$
2. No, discontinuous at $x = 3$, $1 = \lim_{x \rightarrow 3^-} g(x) \neq g(3) = 1.5$
3. Continuous on $[-1, 3]$
4. No, discontinuous at $x = 1$, $1.5 = \lim_{x \rightarrow 1^-} k(x) \neq \lim_{x \rightarrow 1^+} k(x) = 0$
5. (a) Yes (b) Yes, $\lim_{x \rightarrow -1^+} f(x) = 0$
(c) Yes (d) Yes
6. (a) Yes, $f(1) = 1$ (b) Yes, $\lim_{x \rightarrow 1} f(x) = 2$
(c) No (d) No
7. (a) No (b) No
8. $[-1, 0) \cup (0, 1) \cup (1, 2) \cup (2, 3)$
9. $f(2) = 0$, since $\lim_{x \rightarrow 2^-} f(x) = -2(2) + 4 = 0 = \lim_{x \rightarrow 2^+} f(x)$
10. $f(1)$ should be changed to $2 = \lim_{x \rightarrow 1} f(x)$
11. Nonremovable discontinuity at $x = 1$ because $\lim_{x \rightarrow 1} f(x)$ fails to exist ($\lim_{x \rightarrow 1^-} f(x) = 1$ and $\lim_{x \rightarrow 1^+} f(x) = 0$).
Removable discontinuity at $x = 0$ by assigning the number $\lim_{x \rightarrow 0} f(x) = 0$ to be the value of $f(0)$ rather than $f(0) = 1$.
12. Nonremovable discontinuity at $x = 1$ because $\lim_{x \rightarrow 1} f(x)$ fails to exist ($\lim_{x \rightarrow 1^-} f(x) = 2$ and $\lim_{x \rightarrow 1^+} f(x) = 1$).
Removable discontinuity at $x = 2$ by assigning the number $\lim_{x \rightarrow 2} f(x) = 1$ to be the value of $f(2)$ rather than $f(2) = 2$.
13. Discontinuous only when $x - 2 = 0 \Rightarrow x = 2$
14. Discontinuous only when $(x + 2)^2 = 0 \Rightarrow x = -2$
15. Discontinuous only when $x^2 - 4x + 3 = 0 \Rightarrow (x - 3)(x - 1) = 0 \Rightarrow x = 3$ or $x = 1$
16. Discontinuous only when $x^2 - 3x - 10 = 0 \Rightarrow (x - 5)(x + 2) = 0 \Rightarrow x = 5$ or $x = -2$
17. Continuous everywhere. ($|x - 1| + \sin x$ defined for all x ; limits exist and are equal to function values.)
18. Continuous everywhere. ($|x| + 1 \neq 0$ for all x ; limits exist and are equal to function values.)

19. Discontinuous only at $x = 0$
20. Discontinuous at odd integer multiples of $\frac{\pi}{2}$, i.e., $x = (2n-1)\frac{\pi}{2}$, n an integer, but continuous at all other x .
21. Discontinuous when $2x$ is an integer multiple of π , i.e., $2x = n\pi$, n an integer $\Rightarrow x = \frac{n\pi}{2}$, n an integer, but continuous at all other x .
22. Discontinuous when $\frac{\pi x}{2}$ is an odd integer multiple of $\frac{\pi}{2}$, i.e., $\frac{\pi x}{2} = (2n-1)\frac{\pi}{2}$, n an integer $\Rightarrow x = 2n-1$, n an integer (i.e., x is an odd integer). Continuous everywhere else.
23. Discontinuous at odd integer multiples of $\frac{\pi}{2}$, i.e., $x = (2n-1)\frac{\pi}{2}$, n an integer, but continuous at all other x .
24. Continuous everywhere since $x^4 + 1 \geq 1$ and $-1 \leq \sin x \leq 1 \Rightarrow 0 \leq \sin^2 x \leq 1 \Rightarrow 1 + \sin^2 x \geq 1$; limits exist and are equal to the function values.
25. Discontinuous when $2x + 3 < 0$ or $x < -\frac{3}{2} \Rightarrow$ continuous on the interval $[-\frac{3}{2}, \infty)$.
26. Discontinuous when $3x - 1 < 0$ or $x < \frac{1}{3} \Rightarrow$ continuous on the interval $[\frac{1}{3}, \infty)$.
27. Continuous everywhere: $(2x - 1)^{1/3}$ is defined for all x ; limits exist and are equal to function values.
28. Continuous everywhere: $(2 - x)^{1/5}$ is defined for all x ; limits exist and are equal to function values.
29. Continuous everywhere since $\lim_{x \rightarrow 3} \frac{x^2 - x - 6}{x - 3} = \lim_{x \rightarrow 3} \frac{(x-3)(x+2)}{x-3} = \lim_{x \rightarrow 3} (x+2) = 5 = g(3)$
30. Discontinuous at $x = -2$ since $\lim_{x \rightarrow -2} f(x)$ does not exist while $f(-2) = 4$.
31. $\lim_{x \rightarrow \pi} \sin(x - \sin x) = \sin(\pi - \sin \pi) = \sin(\pi - 0) = \sin \pi = 0$, and function continuous at $x = \pi$.
32. $\lim_{t \rightarrow 0} \sin\left(\frac{\pi}{2} \cos(\tan t)\right) = \sin\left(\frac{\pi}{2} \cos(\tan(0))\right) = \sin\left(\frac{\pi}{2} \cos(0)\right) = \sin\left(\frac{\pi}{2}\right) = 1$, and function continuous at $t = 0$.
33. $\lim_{y \rightarrow 1} \sec(y \sec^2 y - \tan^2 y - 1) = \lim_{y \rightarrow 1} \sec(y \sec^2 y - \sec^2 y) = \lim_{y \rightarrow 1} \sec((y-1)\sec^2 y) = \sec((1-1)\sec^2 1) = \sec 0 = 1$, and function continuous at $y = 1$.
34. $\lim_{x \rightarrow 0} \tan\left[\frac{\pi}{4} \cos(\sin x^{1/3})\right] = \tan\left[\frac{\pi}{4} \cos(\sin(0))\right] = \tan\left(\frac{\pi}{4} \cos(0)\right) = \tan\left(\frac{\pi}{4}\right) = 1$, and function continuous at $x = 0$.
35. $\lim_{t \rightarrow 0} \cos\left[\frac{\pi}{\sqrt{19-3 \sec 2t}}\right] = \cos\left[\frac{\pi}{\sqrt{19-3 \sec 0}}\right] = \cos \frac{\pi}{\sqrt{16}} = \cos \frac{\pi}{4} = \frac{\sqrt{2}}{2}$, and function continuous at $t = 0$.
36. $\lim_{x \rightarrow \frac{\pi}{6}} \sqrt{\csc^2 x + 5\sqrt{3} \tan x} = \sqrt{\csc^2\left(\frac{\pi}{6}\right) + 5\sqrt{3} \tan\left(\frac{\pi}{6}\right)} = \sqrt{4 + 5\sqrt{3}\left(\frac{1}{\sqrt{3}}\right)} = \sqrt{9} = 3$, and function continuous at $x = \frac{\pi}{6}$.

37. $\lim_{x \rightarrow 0^+} \sin\left(\frac{\pi}{2} e^{\sqrt{x}}\right) = \sin\left(\frac{\pi}{2} e^0\right) = \sin\left(\frac{\pi}{2}\right) = 1$, and the function is continuous at $x = 0$.
38. $\lim_{x \rightarrow 1} \cos^{-1}(\ln \sqrt{x}) = \cos^{-1}(\ln \sqrt{1}) = \cos^{-1}(0) = \frac{\pi}{2}$, and the function is continuous at $x = 1$.
39. $g(x) = \frac{x^2-9}{x-3} = \frac{(x+3)(x-3)}{(x-3)} = x+3, x \neq 3 \Rightarrow g(3) = \lim_{x \rightarrow 3} (x+3) = 6$
40. $h(t) = \frac{t^2+3t-10}{t-2} = \frac{(t+5)(t-2)}{t-2} = t+5, t \neq 2 \Rightarrow h(2) = \lim_{t \rightarrow 2} (t+5) = 7$
41. $f(s) = \frac{s^3-1}{s^3-1} = \frac{(s^2+s+1)(s-1)}{(s+1)(s-1)} = \frac{s^2+s+1}{s+1}, s \neq 1 \Rightarrow f(1) = \lim_{s \rightarrow 1} \left(\frac{s^2+s+1}{s+1}\right) = \frac{3}{2}$
42. $g(x) = \frac{x^2-16}{x^2-3x-4} = \frac{(x+4)(x-4)}{(x-4)(x+1)} = \frac{x+4}{x+1}, x \neq 4 \Rightarrow g(4) = \lim_{x \rightarrow 4} \left(\frac{x+4}{x+1}\right) = \frac{8}{5}$
43. As defined, $\lim_{x \rightarrow 3^-} f(x) = (3)^2 - 1 = 8$ and $\lim_{x \rightarrow 3^+} (2a)(3) = 6a$. For $f(x)$ to be continuous we must have $6a = 8 \Rightarrow a = \frac{4}{3}$.
44. As defined, $\lim_{x \rightarrow -2^-} g(x) = -2$ and $\lim_{x \rightarrow -2^+} g(x) = b(-2)^2 = 4b$. For $g(x)$ to be continuous we must have $4b = -2 \Rightarrow b = -\frac{1}{2}$.
45. As defined, $\lim_{x \rightarrow 2^-} f(x) = 12$ and $\lim_{x \rightarrow 2^+} f(x) = a^2(2) - 2a = 2a^2 - 2a$. For $f(x)$ to be continuous we must have $12 = 2a^2 - 2a \Rightarrow a = 3$ or $a = -2$.
46. As defined, $\lim_{x \rightarrow 0^-} g(x) = \frac{0-b}{b+1} = \frac{-b}{b+1}$ and $\lim_{x \rightarrow 0^+} g(x) = (0)^2 + b = b$. For $g(x)$ to be continuous we must have $\frac{-b}{b+1} = b \Rightarrow b = 0$ or $b = -2$.
47. As defined, $\lim_{x \rightarrow -1^-} f(x) = -2$ and $\lim_{x \rightarrow -1^+} f(x) = a(-1) + b = -a + b$, and $\lim_{x \rightarrow 1^-} f(x) = a(1) + b = a + b$ and $\lim_{x \rightarrow 1^+} f(x) = 3$. For $f(x)$ to be continuous we must have $-2 = -a + b$ and $a + b = 3 \Rightarrow a = \frac{5}{2}$ and $b = \frac{1}{2}$.
48. As defined, $\lim_{x \rightarrow 0^-} g(x) = a(0) + 2b = 2b$ and $\lim_{x \rightarrow 0^+} g(x) = (0)^2 + 3a - b = 3a - b$, and $\lim_{x \rightarrow 2^-} g(x) = (2)^2 + 3a - b = 4 + 3a - b$ and $\lim_{x \rightarrow 2^+} g(x) = 3(2) - 5 = 1$. For $g(x)$ to be continuous we must have $2b = 3a - b$ and $4 + 3a - b = 1 \Rightarrow a = -\frac{3}{2}$ and $b = -\frac{3}{2}$.

49. The function can be extended: $f(0) \approx 2.3$.

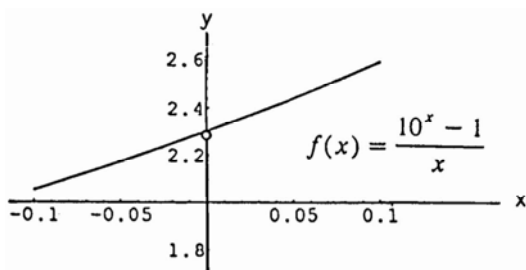

50. The function cannot be extended to be continuous at $x = 0$. If $f(0) \approx 2.3$, it will be continuous from the right. Or if $f(0) \approx -2.3$, it will be continuous from the left.

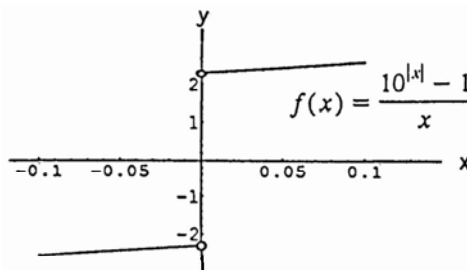

51. The function cannot be extended to be continuous at $x = 0$. If $f(0) = 1$, it will be continuous from the right. Or if $f(0) = -1$, it will be continuous from the left.

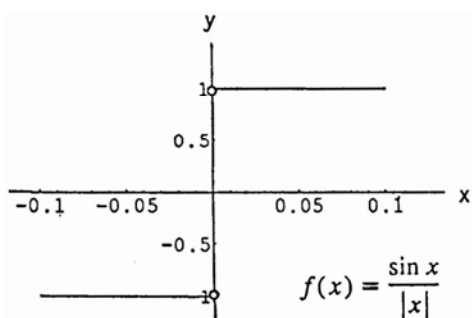

52. The function can be extended: $f(0) \approx 7.39$.

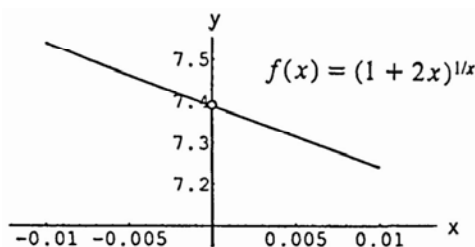

53. $f(x)$ is continuous on $[0, 1]$ and $f(0) < 0$, $f(1) > 0 \Rightarrow$ by the Intermediate Value Theorem $f(x)$ takes on every value between $f(0)$ and $f(1) \Rightarrow$ the equation $f(x) = 0$ has at least one solution between $x = 0$ and $x = 1$.

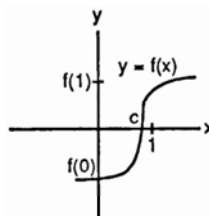

54. $\cos x = x \Rightarrow (\cos x) - x = 0$. If $x = -\frac{\pi}{2}$, $\cos\left(-\frac{\pi}{2}\right) - \left(-\frac{\pi}{2}\right) > 0$. If $x = \frac{\pi}{2}$, $\cos\left(\frac{\pi}{2}\right) - \frac{\pi}{2} < 0$. Thus $\cos x - x = 0$ for some x between $-\frac{\pi}{2}$ and $\frac{\pi}{2}$ according to the Intermediate Value Theorem, since the function $\cos x - x$ is continuous.

55. Let $f(x) = x^3 - 15x + 1$, which is continuous on $[-4, 4]$. Then $f(-4) = -3$, $f(-1) = 15$, $f(1) = -13$, and $f(4) = 5$. By the Intermediate Value Theorem, $f(x) = 0$ for some x in each of the intervals $-4 < x < -1$, $-1 < x < 1$, and $1 < x < 4$. That is, $x^3 - 15x + 1 = 0$ has three solutions in $[-4, 4]$. Since a polynomial of degree 3 can have at most 3 solutions, these are the only solutions.

56. Without loss of generality, assume that $a < b$. Then $F(x) = (x-a)^2(x-b)^2 + x$ is continuous for all values of x , so it is continuous on the interval $[a, b]$. Moreover $F(a) = a$ and $F(b) = b$. By the Intermediate Value Theorem, since $a < \frac{a+b}{2} < b$, there is a number c between a and b such that $F(x) = \frac{a+b}{2}$.

57. Answers may vary. Note that f is continuous for every value of x .
- (a) $f(0) = 10$, $f(1) = 1^3 - 8(1) + 10 = 3$. Since $3 < \pi < 10$, by the Intermediate Value Theorem, there exists a c so that $0 < c < 1$ and $f(c) = \pi$.
- (b) $f(0) = 10$, $f(-4) = (-4)^3 - 8(-4) + 10 = -22$. Since $-22 < -\sqrt{3} < 10$, by the Intermediate Value Theorem, there exists a c so that $-4 < c < 0$ and $f(c) = -\sqrt{3}$.
- (c) $f(0) = 10$, $f(1000) = (1000)^3 - 8(1000) + 10 = 999,992,010$. Since $10 < 5,000,000 < 999,992,010$, by the Intermediate Value Theorem, there exists a c so that $0 < c < 1000$ and $f(c) = 5,000,000$.
58. All five statements ask for the same information because of the intermediate value property of continuous functions.
- (a) A root of $f(x) = x^3 - 3x - 1$ is a point c where $f(c) = 0$.
- (b) The point where $y = x^3$ crosses $y = 3x + 1$ have the same y -coordinate, or $y = x^3 = 3x + 1 \Rightarrow f(x) = x^3 - 3x - 1 = 0$.
- (c) $x^3 - 3x = 1 \Rightarrow x^3 - 3x - 1 = 0$. The solutions to the equation are the roots of $f(x) = x^3 - 3x - 1$.
- (d) The points where $y = x^3 - 3x$ crosses $y = 1$ have common y -coordinates, or $y = x^3 - 3x = 1 \Rightarrow f(x) = x^3 - 3x - 1 = 0$.
- (e) The solutions of $x^3 - 3x - 1 = 0$ are those points where $f(x) = x^3 - 3x - 1$ has value 0.
59. Answers may vary. For example, $f(x) = \frac{\sin(x-2)}{x-2}$ is discontinuous at $x = 2$ because it is not defined there. However, the discontinuity can be removed because f has a limit (namely 1) as $x \rightarrow 2$.
60. Answers may vary. For example, $g(x) = \frac{1}{x+1}$ has a discontinuity at $x = -1$ because $\lim_{x \rightarrow -1} g(x)$ does not exist.
- $$\left(\lim_{x \rightarrow -1^-} g(x) = -\infty \text{ and } \lim_{x \rightarrow -1^+} g(x) = +\infty. \right)$$
61. (a) Suppose x_0 is rational $\Rightarrow f(x_0) = 1$. Choose $\epsilon = \frac{1}{2}$. For any $\delta > 0$ there is an irrational number x (actually infinitely many) in the interval $(x_0 - \delta, x_0 + \delta) \Rightarrow f(x) = 0$. Then $0 < |x - x_0| < \delta$ but $|f(x) - f(x_0)| = 1 > \frac{1}{2} = \epsilon$, so $\lim_{x \rightarrow x_0} f(x)$ fails to exist $\Rightarrow f$ is discontinuous at x_0 rational.
- On the other hand, x_0 irrational $\Rightarrow f(x_0) = 0$ and there is a rational number x in $(x_0 - \delta, x_0 + \delta) \Rightarrow f(x) = 1$. Again $\lim_{x \rightarrow x_0} f(x)$ fails to exist $\Rightarrow f$ is discontinuous at x_0 irrational. That is, f is discontinuous at every point.
- (b) f is neither right-continuous nor left-continuous at any point x_0 because in every interval $(x_0 - \delta, x_0)$ or $(x_0, x_0 + \delta)$ there exist both rational and irrational real numbers. Thus neither limits $\lim_{x \rightarrow x_0^-} f(x)$ and $\lim_{x \rightarrow x_0^+} f(x)$ exist by the same arguments used in part (a).
62. Yes. Both $f(x) = x$ and $g(x) = x - \frac{1}{2}$ are continuous on $[0, 1]$. However $\frac{f(x)}{g(x)}$ is undefined at $x = \frac{1}{2}$ since $g\left(\frac{1}{2}\right) = 0 \Rightarrow \frac{f(x)}{g(x)}$ is discontinuous at $x = \frac{1}{2}$.
63. No. For instance, if $f(x) = 0$, $g(x) = \lceil x \rceil$, then $h(x) = 0(\lceil x \rceil) = 0$ is continuous at $x = 0$ and $g(x)$ is not.
64. Let $f(x) = \frac{1}{x-1}$ and $g(x) = x+1$. Both functions are continuous at $x = 0$. The composition $f \circ g = f(g(x)) = \frac{1}{(x+1)-1} = \frac{1}{x}$ is discontinuous at $x = 0$, since it is not defined there. Theorem 10 requires that $f(x)$ be continuous at $g(0)$, which is not the case here since $g(0) = 1$ and f is undefined at 1.

65. Yes, because of the Intermediate Value Theorem. If $f(a)$ and $f(b)$ did have different signs then f would have to equal zero at some point between a and b since f is continuous on $[a, b]$.
66. Let $f(x)$ be the new position of point x and let $d(x) = f(x) - x$. The displacement function d is negative if x is the left-hand point of the rubber band and positive if x is the right-hand point of the rubber band. By the Intermediate Value Theorem, $d(x) = 0$ for some point in between. That is, $f(x) = x$ for some point x , which is then in its original position.
67. If $f(0) = 0$ or $f(1) = 1$, we are done (i.e., $c = 0$ or $c = 1$ in those cases). Then let $f(0) = a > 0$ and $f(1) = b < 1$ because $0 \leq f(x) \leq 1$. Define $g(x) = f(x) - x \Rightarrow g$ is continuous on $[0, 1]$. Moreover, $g(0) = f(0) - 0 = a > 0$ and $g(1) = f(1) - 1 = b - 1 < 0 \Rightarrow$ by the Intermediate Value Theorem there is a number c in $(0, 1)$ such that $g(c) = 0 \Rightarrow f(c) - c = 0$ or $f(c) = c$.
68. Let $\epsilon = \frac{|f(c)|}{2} > 0$. Since f is continuous at $x = c$ there is a $\delta > 0$ such that $|x - c| < \delta \Rightarrow |f(x) - f(c)| < \epsilon \Rightarrow f(c) - \epsilon < f(x) < f(c) + \epsilon$.
 If $f(c) > 0$, then $\epsilon = \frac{1}{2}f(c) \Rightarrow \frac{1}{2}f(c) < f(x) < \frac{3}{2}f(c) \Rightarrow f(x) > 0$ on the interval $(c - \delta, c + \delta)$.
 If $f(c) < 0$, then $\epsilon = -\frac{1}{2}f(c) \Rightarrow \frac{3}{2}f(c) < f(x) < \frac{1}{2}f(c) \Rightarrow f(x) < 0$ on the interval $(c - \delta, c + \delta)$.

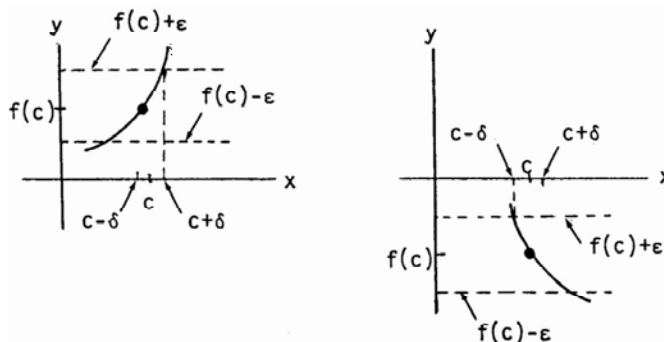

Thus, $f(x)$ is continuous at $x = c \Leftrightarrow \lim_{x \rightarrow c} f(x) = f(c) \Leftrightarrow \lim_{h \rightarrow 0} f(c+h) = f(c)$.

70. By Exercise 67, it suffices to show that $\lim_{h \rightarrow 0} \sin(c+h) = \sin c$ and $\lim_{h \rightarrow 0} \cos(c+h) = \cos c$.

Now $\lim_{h \rightarrow 0} \sin(c+h) = \lim_{h \rightarrow 0} [(\sin c)(\cos h) + (\cos c)(\sin h)] = (\sin c) \left(\lim_{h \rightarrow 0} \cos h \right) + (\cos c) \left(\lim_{h \rightarrow 0} \sin h \right)$.

By Example 11 Section 2.2, $\lim_{h \rightarrow 0} \cos h = 1$ and $\lim_{h \rightarrow 0} \sin h = 0$. So $\lim_{h \rightarrow 0} \sin(c+h) = \sin c$ and thus $f(x) = \sin x$ is continuous at $x = c$. Similarly,

$\lim_{h \rightarrow 0} \cos(c+h) = \lim_{h \rightarrow 0} [(\cos c)(\cos h) - (\sin c)(\sin h)] = (\cos c) \left(\lim_{h \rightarrow 0} \cos h \right) - (\sin c) \left(\lim_{h \rightarrow 0} \sin h \right) = \cos c$. Thus, $g(x) = \cos x$ is continuous at $x = c$.

- | | |
|--|---|
| 71. $x \approx 1.8794, -1.5321, -0.3473$ | 72. $x \approx 1.4516, -0.8547, 0.4030$ |
| 73. $x \approx 1.7549$ | 74. $x \approx 1.5596$ |
| 75. $x \approx 3.5156$ | 76. $x \approx -3.9058, 3.8392, 0.0667$ |
| 77. $x \approx 0.7391$ | 78. $x \approx -1.8955, 0, 1.8955$ |

2.6 LIMITS INVOLVING INFINITY; ASYMPTOTES OF GRAPHS

- | | |
|---|---|
| 1. (a) $\lim_{x \rightarrow 2} f(x) = 0$ | (b) $\lim_{x \rightarrow -3^+} f(x) = -2$ |
| (c) $\lim_{x \rightarrow -3^-} f(x) = 2$ | (d) $\lim_{x \rightarrow 3} f(x) = \text{does not exist}$ |
| (e) $\lim_{x \rightarrow 0^+} f(x) = -1$ | (f) $\lim_{x \rightarrow 0^-} f(x) = +\infty$ |
| (g) $\lim_{x \rightarrow 0} f(x) = \text{does not exist}$ | (h) $\lim_{x \rightarrow \infty} f(x) = 1$ |
| (i) $\lim_{x \rightarrow -\infty} f(x) = 0$ | |
| 2. (a) $\lim_{x \rightarrow 4} f(x) = 2$ | (b) $\lim_{x \rightarrow 2^+} f(x) = -3$ |
| (c) $\lim_{x \rightarrow 2^-} f(x) = 1$ | (d) $\lim_{x \rightarrow 2} f(x) = \text{does not exist}$ |
| (e) $\lim_{x \rightarrow -3^+} f(x) = +\infty$ | (f) $\lim_{x \rightarrow -3^-} f(x) = +\infty$ |
| (g) $\lim_{x \rightarrow -3} f(x) = +\infty$ | (h) $\lim_{x \rightarrow 0^+} f(x) = +\infty$ |
| (i) $\lim_{x \rightarrow 0^-} f(x) = -\infty$ | (j) $\lim_{x \rightarrow 0} f(x) = \text{does not exist}$ |
| (k) $\lim_{x \rightarrow \infty} f(x) = 0$ | (l) $\lim_{x \rightarrow -\infty} f(x) = -1$ |

Note: In these exercises we use the result $\lim_{x \rightarrow \pm \infty} \frac{1}{x^{m/n}} = 0$ whenever $\frac{m}{n} > 0$. This result follows immediately from

Theorem 8 and the power rule in Theorem 1: $\lim_{x \rightarrow \pm \infty} \left(\frac{1}{x^{m/n}}\right) = \lim_{x \rightarrow \pm \infty} \left(\frac{1}{x}\right)^{m/n} = \left(\lim_{x \rightarrow \pm \infty} \frac{1}{x}\right)^{m/n} = 0^{m/n} = 0$.

- | | |
|--|--------------------|
| 3. (a) -3 | (b) -3 |
| 4. (a) π | (b) π |
| 5. (a) $\frac{1}{2}$ | (b) $\frac{1}{2}$ |
| 6. (a) $\frac{1}{8}$ | (b) $\frac{1}{8}$ |
| 7. (a) $-\frac{5}{3}$ | (b) $-\frac{5}{3}$ |
| 8. (a) $\frac{3}{4}$ | (b) $\frac{3}{4}$ |
| 9. $-\frac{1}{x} \leq \frac{\sin 2x}{x} \leq \frac{1}{x} \Rightarrow \lim_{x \rightarrow \infty} \frac{\sin 2x}{x} = 0$ by the Sandwich Theorem | |
| 10. $-\frac{1}{3\theta} \leq \frac{\cos \theta}{3\theta} \leq \frac{1}{3\theta} \Rightarrow \lim_{\theta \rightarrow -\infty} \frac{\cos \theta}{3\theta} = 0$ by the Sandwich Theorem | |
| 11. $\lim_{t \rightarrow \infty} \frac{2-t+\sin t}{t+\cos t} = \lim_{t \rightarrow \infty} \frac{\frac{2}{t}-1+\left(\frac{\sin t}{t}\right)}{1+\left(\frac{\cos t}{t}\right)} = \frac{0-1+0}{1+0} = -1$ | |
| 12. $\lim_{r \rightarrow \infty} \frac{r+\sin r}{2r+7-5\sin r} = \lim_{r \rightarrow \infty} \frac{1+\left(\frac{\sin r}{r}\right)}{2+\frac{7}{r}-5\left(\frac{\sin r}{r}\right)} = \lim_{r \rightarrow \infty} \frac{1+0}{2+0-0} = \frac{1}{2}$ | |

13. (a) $\lim_{x \rightarrow \infty} \frac{2x+3}{5x+7} = \lim_{x \rightarrow \infty} \frac{2+\frac{3}{x}}{5+\frac{7}{x}} = \frac{2}{5}$ (b) $\frac{2}{5}$ (same process as part (a))
14. (a) $\lim_{x \rightarrow \infty} \frac{2x^3+7}{x^3-x^2+x+7} = \lim_{x \rightarrow \infty} \frac{2+\left(\frac{7}{x^3}\right)}{1-\frac{1}{x}+\frac{1}{x^2}+\frac{7}{x^3}} = 2$
 (b) 2 (same process as part (a))
15. (a) $\lim_{x \rightarrow \infty} \frac{x+1}{x^2+3} = \lim_{x \rightarrow \infty} \frac{\frac{1}{x}+\frac{1}{x^2}}{1+\frac{3}{x^2}} = 0$ (b) 0 (same process as part (a))
16. (a) $\lim_{x \rightarrow \infty} \frac{3x+7}{x^2-2} = \lim_{x \rightarrow \infty} \frac{\frac{3}{x}+\frac{7}{x^2}}{1-\frac{2}{x^2}} = 0$ (b) 0 (same process as part (a))
17. (a) $\lim_{x \rightarrow \infty} \frac{7x^3}{x^3-3x^2+6x} = \lim_{x \rightarrow \infty} \frac{7}{1-\frac{3}{x}+\frac{6}{x^2}} = 7$ (b) 7 (same process as part (a))
18. (a) $\lim_{x \rightarrow \infty} \frac{9x^4+x}{2x^4+5x^2-x+6} = \lim_{x \rightarrow \infty} \frac{9+\frac{1}{x^3}}{2+\frac{5}{x^2}-\frac{1}{x}+\frac{6}{x^4}} = \frac{9}{2}$ (b) $\frac{9}{2}$ (same process as part (a))
19. (a) $\lim_{x \rightarrow \infty} \frac{10x^5+x^4+31}{x^6} = \lim_{x \rightarrow \infty} \frac{\frac{10}{x}+\frac{1}{x^2}+\frac{31}{x^6}}{1} = 0$ (b) 0 (same process as part (a))
20. (a) $\lim_{x \rightarrow \infty} \frac{x^3+7x^2-2}{x^2-x-1} = \lim_{x \rightarrow \infty} \frac{x+7-2x^{-1}}{1-x^{-1}-x^{-2}} = \infty$, since $x^{-n} \rightarrow 0$ and $x+7 \rightarrow \infty$.
 (b) $\lim_{x \rightarrow -\infty} \frac{x^3+7x^2-2}{x^2-x-1} = \lim_{x \rightarrow -\infty} \frac{x+7-2x^{-1}}{1-x^{-1}-x^{-2}} = -\infty$, since $x^{-n} \rightarrow 0$ and $x+7 \rightarrow -\infty$.
21. (a) $\lim_{x \rightarrow \infty} \frac{3x^7+5x^2-1}{6x^3-7x+3} = \lim_{x \rightarrow \infty} \frac{3x^4+5x^{-1}-x^{-3}}{6-7x^{-2}+3x^{-3}} = \infty$, since $x^{-n} \rightarrow 0$ and $3x^4 \rightarrow \infty$.
 (b) $\lim_{x \rightarrow -\infty} \frac{3x^7+5x^2-1}{6x^3-7x+3} = \lim_{x \rightarrow -\infty} \frac{3x^4+5x^{-1}-x^{-3}}{6-7x^{-2}+3x^{-3}} = \infty$, since $x^{-n} \rightarrow 0$ and $3x^4 \rightarrow \infty$.
22. (a) $\lim_{x \rightarrow \infty} \frac{5x^8-2x^3+9}{3+x-4x^5} = \lim_{x \rightarrow \infty} \frac{5x^3-2x^{-2}+9x^{-5}}{3x^{-5}+x^{-4}-4} = -\infty$, since $x^{-n} \rightarrow 0$, $5x^3 \rightarrow \infty$, and the denominator $\rightarrow -4$.
 (b) $\lim_{x \rightarrow -\infty} \frac{5x^8-2x^3+9}{3+x-4x^5} = \lim_{x \rightarrow -\infty} \frac{5x^3-2x^{-2}+9x^{-5}}{3x^{-5}+x^{-4}-4} = \infty$, since $x^{-n} \rightarrow 0$, $5x^3 \rightarrow -\infty$, and the denominator $\rightarrow -4$.
23. $\lim_{x \rightarrow \infty} \sqrt{\frac{8x^2-3}{2x^2+x}} = \lim_{x \rightarrow \infty} \sqrt{\frac{8-\frac{3}{x^2}}{2+\frac{1}{x}}} = \sqrt{\lim_{x \rightarrow \infty} \frac{8-\frac{3}{x^2}}{2+\frac{1}{x}}} = \sqrt{\frac{8-0}{2+0}} = \sqrt{4} = 2$
24. $\lim_{x \rightarrow -\infty} \left(\frac{x^2+x-1}{8x^2-3}\right)^{1/3} = \lim_{x \rightarrow -\infty} \left(\frac{1+\frac{1}{x}-\frac{1}{x^2}}{8-\frac{3}{x^2}}\right)^{1/3} = \left(\lim_{x \rightarrow -\infty} \frac{1+\frac{1}{x}-\frac{1}{x^2}}{8-\frac{3}{x^2}}\right)^{1/3} = \left(\frac{1+0-0}{8-0}\right)^{1/3} = \left(\frac{1}{8}\right)^{1/3} = \frac{1}{2}$
25. $\lim_{x \rightarrow -\infty} \left(\frac{1-x^3}{x^2-7x}\right)^5 = \lim_{x \rightarrow -\infty} \left(\frac{\frac{1}{x^2}-x}{1-\frac{7}{x}}\right)^5 = \left(\lim_{x \rightarrow -\infty} \frac{\frac{1}{x^2}-x}{1-\frac{7}{x}}\right)^5 = \left(\frac{0+\infty}{1-0}\right)^5 = \infty$

$$26. \lim_{x \rightarrow \infty} \sqrt{\frac{x^2 - 5x}{x^3 + x - 2}} = \lim_{x \rightarrow \infty} \sqrt{\frac{\frac{1-5}{x} \cdot \frac{1}{x^2}}{1 + \frac{1}{x^2} - \frac{2}{x^3}}} = \sqrt{\lim_{x \rightarrow \infty} \frac{\frac{1-5}{x} \cdot \frac{1}{x^2}}{1 + \frac{1}{x^2} - \frac{2}{x^3}}} = \sqrt{\frac{0-0}{1+0-0}} = \sqrt{0} = 0$$

$$27. \lim_{x \rightarrow \infty} \frac{2\sqrt{x} + x^{-1}}{3x - 7} = \lim_{x \rightarrow \infty} \frac{\left(\frac{2}{x^{1/2}}\right) + \left(\frac{1}{x^2}\right)}{3 - \frac{7}{x}} = 0$$

$$28. \lim_{x \rightarrow \infty} \frac{2 + \sqrt{x}}{2 - \sqrt{x}} = \lim_{x \rightarrow \infty} \frac{\left(\frac{2}{x^{1/2}}\right) + 1}{\left(\frac{2}{x^{1/2}}\right) - 1} = -1$$

$$29. \lim_{x \rightarrow -\infty} \frac{\sqrt[3]{x} - \sqrt[5]{x}}{\sqrt[3]{x} + \sqrt[5]{x}} = \lim_{x \rightarrow -\infty} \frac{1 - x^{(1/5)-(1/3)}}{1 + x^{(1/5)-(1/3)}} = \lim_{x \rightarrow -\infty} \frac{1 - \left(\frac{1}{x^{2/15}}\right)}{1 + \left(\frac{1}{x^{2/15}}\right)} = 1$$

$$30. \lim_{x \rightarrow \infty} \frac{x^{-1} + x^{-4}}{x^{-2} - x^{-3}} = \lim_{x \rightarrow \infty} \frac{\frac{x+1}{x^2}}{1 - \frac{1}{x}} = \infty$$

$$31. \lim_{x \rightarrow \infty} \frac{2x^{5/3} - x^{1/3} + 7}{x^{8/5} + 3x + \sqrt{x}} = \lim_{x \rightarrow \infty} \frac{2x^{1/15} - \frac{1}{x^{19/15}} + \frac{7}{x^{8/5}}}{1 + \frac{3}{x^{3/5}} + \frac{1}{x^{11/10}}} = \infty$$

$$32. \lim_{x \rightarrow -\infty} \frac{\sqrt[3]{x} - 5x + 3}{2x + x^{2/3} - 4} = \lim_{x \rightarrow -\infty} \frac{\frac{1}{x^{2/3}} - 5 + \frac{3}{x}}{2 + \frac{1}{x^{1/3}} - \frac{4}{x}} = -\frac{5}{2}$$

$$33. \lim_{x \rightarrow \infty} \frac{\sqrt{x^2+1}}{x+1} = \lim_{x \rightarrow \infty} \frac{\sqrt{x^2+1}/\sqrt{x^2}}{(x+1)/\sqrt{x^2}} = \lim_{x \rightarrow \infty} \frac{\sqrt{(x^2+1)/x^2}}{(x+1)/x} = \lim_{x \rightarrow \infty} \frac{\sqrt{1+1/x^2}}{(1+1/x)} = \frac{\sqrt{1+0}}{(1+0)} = 1$$

$$34. \lim_{x \rightarrow -\infty} \frac{\sqrt{x^2+1}}{x+1} = \lim_{x \rightarrow -\infty} \frac{\sqrt{x^2+1}/\sqrt{x^2}}{(x+1)/\sqrt{x^2}} = \lim_{x \rightarrow -\infty} \frac{\sqrt{(x^2+1)/x^2}}{(x+1)/(-x)} = \lim_{x \rightarrow -\infty} \frac{\sqrt{1+1/x^2}}{(-1-1/x)} = \frac{\sqrt{1+0}}{(-1-0)} = -1$$

$$35. \lim_{x \rightarrow \infty} \frac{x-3}{\sqrt{4x^2+25}} = \lim_{x \rightarrow \infty} \frac{(x-3)/\sqrt{x^2}}{\sqrt{4x^2+25}/\sqrt{x^2}} = \lim_{x \rightarrow \infty} \frac{(x-3)/x}{\sqrt{(4x^2+25)/x^2}} = \lim_{x \rightarrow \infty} \frac{(1-3/x)}{\sqrt{4+25/x^2}} = \frac{(1-0)}{\sqrt{4+0}} = \frac{1}{2}$$

$$36. \lim_{x \rightarrow -\infty} \frac{4-3x^3}{\sqrt{x^6+9}} = \lim_{x \rightarrow -\infty} \frac{(4-3x^3)/\sqrt{x^6}}{\sqrt{x^6+9}/\sqrt{x^6}} = \lim_{x \rightarrow -\infty} \frac{(4-3x^3)/(-x^3)}{\sqrt{(x^6+9)/x^6}} = \lim_{x \rightarrow -\infty} \frac{(-4/x^3+3)}{\sqrt{1+9/x^6}} = \frac{(0+3)}{\sqrt{1+0}} = 3$$

$$37. \lim_{x \rightarrow 0^+} \frac{1}{3x} = \infty \quad \left(\frac{\text{positive}}{\text{positive}} \right)$$

$$38. \lim_{x \rightarrow 0^-} \frac{5}{2x} = -\infty \quad \left(\frac{\text{positive}}{\text{negative}} \right)$$

$$39. \lim_{x \rightarrow 2^-} \frac{3}{x-2} = -\infty \quad \left(\frac{\text{positive}}{\text{negative}} \right)$$

$$40. \lim_{x \rightarrow 3^+} \frac{1}{x-3} = \infty \quad \left(\frac{\text{positive}}{\text{positive}} \right)$$

$$41. \lim_{x \rightarrow -8^+} \frac{2x}{x+8} = -\infty \quad \left(\frac{\text{negative}}{\text{positive}} \right)$$

$$42. \lim_{x \rightarrow -5^-} \frac{3x}{2x+10} = \infty \quad \left(\frac{\text{negative}}{\text{negative}} \right)$$

$$43. \lim_{x \rightarrow 7} \frac{4}{(x-7)^2} = \infty \quad \left(\frac{\text{positive}}{\text{positive}} \right)$$

$$44. \lim_{x \rightarrow 0} \frac{-1}{x^2(x+1)} = -\infty \quad \left(\frac{\text{negative}}{\text{positive} \cdot \text{positive}} \right)$$

$$45. (a) \lim_{x \rightarrow 0^+} \frac{2}{3x^{1/3}} = \infty$$

$$(b) \lim_{x \rightarrow 0^-} \frac{2}{3x^{1/3}} = -\infty$$

46. (a) $\lim_{x \rightarrow 0^+} \frac{2}{x^{1/5}} = \infty$

(b) $\lim_{x \rightarrow 0^-} \frac{2}{x^{1/5}} = -\infty$

47. $\lim_{x \rightarrow 0} \frac{4}{x^{2/5}} = \lim_{x \rightarrow 0} \frac{4}{(x^{1/5})^2} = \infty$

48. $\lim_{x \rightarrow 0} \frac{1}{x^{2/3}} = \lim_{x \rightarrow 0} \frac{1}{(x^{1/3})^2} = \infty$

49. $\lim_{x \rightarrow (\frac{\pi}{2})^-} \tan x = \infty$

50. $\lim_{x \rightarrow (\frac{-\pi}{2})^+} \sec x = \infty$

51. $\lim_{\theta \rightarrow 0^-} (1 + \csc \theta) = -\infty$

52. $\lim_{\theta \rightarrow 0^+} (2 - \cot \theta) = -\infty$ and $\lim_{\theta \rightarrow 0^-} (2 - \cot \theta) = \infty$, so the limit does not exist

53. (a) $\lim_{x \rightarrow 2^+} \frac{1}{x^2 - 4} = \lim_{x \rightarrow 2^+} \frac{1}{(x+2)(x-2)} = \infty$ $\left(\frac{\text{positive}}{\text{positive} \cdot \text{positive}} \right)$

(b) $\lim_{x \rightarrow 2^-} \frac{1}{x^2 - 4} = \lim_{x \rightarrow 2^-} \frac{1}{(x+2)(x-2)} = -\infty$ $\left(\frac{\text{positive}}{\text{positive} \cdot \text{negative}} \right)$

(c) $\lim_{x \rightarrow -2^+} \frac{1}{x^2 - 4} = \lim_{x \rightarrow -2^+} \frac{1}{(x+2)(x-2)} = -\infty$ $\left(\frac{\text{positive}}{\text{positive} \cdot \text{negative}} \right)$

(d) $\lim_{x \rightarrow -2^-} \frac{1}{x^2 - 4} = \lim_{x \rightarrow -2^-} \frac{1}{(x+2)(x-2)} = \infty$ $\left(\frac{\text{positive}}{\text{negative} \cdot \text{negative}} \right)$

54. (a) $\lim_{x \rightarrow 1^+} \frac{x}{x^2 - 1} = \lim_{x \rightarrow 1^+} \frac{x}{(x+1)(x-1)} = \infty$ $\left(\frac{\text{positive}}{\text{positive} \cdot \text{positive}} \right)$

(b) $\lim_{x \rightarrow 1^-} \frac{x}{x^2 - 1} = \lim_{x \rightarrow 1^-} \frac{x}{(x+1)(x-1)} = -\infty$ $\left(\frac{\text{positive}}{\text{positive} \cdot \text{negative}} \right)$

(c) $\lim_{x \rightarrow -1^+} \frac{x}{x^2 - 1} = \lim_{x \rightarrow -1^+} \frac{x}{(x+1)(x-1)} = \infty$ $\left(\frac{\text{negative}}{\text{positive} \cdot \text{negative}} \right)$

(d) $\lim_{x \rightarrow -1^-} \frac{x}{x^2 - 1} = \lim_{x \rightarrow -1^-} \frac{x}{(x+1)(x-1)} = -\infty$ $\left(\frac{\text{negative}}{\text{negative} \cdot \text{negative}} \right)$

55. (a) $\lim_{x \rightarrow 0^+} \left(\frac{x^2}{2} - \frac{1}{x} \right) = 0 + \lim_{x \rightarrow 0^+} \frac{1}{-x} = -\infty$ $\left(\frac{\text{negative}}{\text{negative}} \right)$

(b) $\lim_{x \rightarrow 0^-} \left(\frac{x^2}{2} - \frac{1}{x} \right) = 0 + \lim_{x \rightarrow 0^-} \frac{1}{-x} = \infty$ $\left(\frac{\text{positive}}{\text{positive}} \right)$

(c) $\lim_{x \rightarrow \sqrt[3]{2}} \left(\frac{x^2}{2} - \frac{1}{x} \right) = \frac{2^{2/3}}{2} - \frac{1}{2^{1/3}} = 2^{-1/3} - 2^{-1/3} = 0$

(d) $\lim_{x \rightarrow -1} \left(\frac{x^2}{2} - \frac{1}{x} \right) = \frac{1}{2} - \left(\frac{1}{-1} \right) = \frac{3}{2}$

56. (a) $\lim_{x \rightarrow -2^+} \frac{x^2 - 1}{2x + 4} = \infty$ $\left(\frac{\text{positive}}{\text{positive}} \right)$

(b) $\lim_{x \rightarrow -2^-} \frac{x^2 - 1}{2x + 4} = -\infty$ $\left(\frac{\text{positive}}{\text{negative}} \right)$

(c) $\lim_{x \rightarrow 1^+} \frac{x^2 - 1}{2x + 4} = \lim_{x \rightarrow 1^+} \frac{(x+1)(x-1)}{2x+4} = \frac{2 \cdot 0}{2+4} = 0$

(d) $\lim_{x \rightarrow 0^-} \frac{x^2 - 1}{2x + 4} = \frac{-1}{4}$

57. (a) $\lim_{x \rightarrow 0^+} \frac{x^2 - 3x + 2}{x^3 - 2x^2} = \lim_{x \rightarrow 0^+} \frac{(x-2)(x-1)}{x^2(x-2)} = -\infty$ $\left(\begin{array}{l} \text{negative-negative} \\ \text{positive-negative} \end{array} \right)$
 (b) $\lim_{x \rightarrow 2^+} \frac{x^2 - 3x + 2}{x^3 - 2x^2} = \lim_{x \rightarrow 2^+} \frac{(x-2)(x-1)}{x^2(x-2)} = \lim_{x \rightarrow 2^+} \frac{x-1}{x^2} = \frac{1}{4}, x \neq 2$
 (c) $\lim_{x \rightarrow 2^-} \frac{x^2 - 3x + 2}{x^3 - 2x^2} = \lim_{x \rightarrow 2^-} \frac{(x-2)(x-1)}{x^2(x-2)} = \lim_{x \rightarrow 2^-} \frac{x-1}{x^2} = \frac{1}{4}, x \neq 2$
 (d) $\lim_{x \rightarrow 2} \frac{x^2 - 3x + 2}{x^3 - 2x^2} = \lim_{x \rightarrow 2} \frac{(x-2)(x-1)}{x^2(x-2)} = \lim_{x \rightarrow 2} \frac{x-1}{x^2} = \frac{1}{4}, x \neq 2$
 (e) $\lim_{x \rightarrow 0} \frac{x^2 - 3x + 2}{x^3 - 2x^2} = \lim_{x \rightarrow 0} \frac{(x-2)(x-1)}{x^2(x-2)} = -\infty$ $\left(\begin{array}{l} \text{negative-negative} \\ \text{positive-negative} \end{array} \right)$

58. (a) $\lim_{x \rightarrow 2^+} \frac{x^2 - 3x + 2}{x^3 - 4x} = \lim_{x \rightarrow 2^+} \frac{(x-2)(x-1)}{x(x-2)(x+2)} = \lim_{x \rightarrow 2^+} \frac{(x-1)}{x(x+2)} = \frac{1}{2(4)} = \frac{1}{8}$
 (b) $\lim_{x \rightarrow -2^+} \frac{x^2 - 3x + 2}{x^3 - 4x} = \lim_{x \rightarrow -2^+} \frac{(x-2)(x-1)}{x(x-2)(x+2)} = \lim_{x \rightarrow -2^+} \frac{(x-1)}{x(x+2)} = \infty$ $\left(\begin{array}{l} \text{negative} \\ \text{negative-positive} \end{array} \right)$
 (c) $\lim_{x \rightarrow 0^-} \frac{x^2 - 3x + 2}{x^3 - 4x} = \lim_{x \rightarrow 0^-} \frac{(x-2)(x-1)}{x(x-2)(x+2)} = \lim_{x \rightarrow 0^-} \frac{(x-1)}{x(x+2)} = \infty$ $\left(\begin{array}{l} \text{negative} \\ \text{negative-positive} \end{array} \right)$
 (d) $\lim_{x \rightarrow 1^+} \frac{x^2 - 3x + 2}{x^3 - 4x} = \lim_{x \rightarrow 1^+} \frac{(x-2)(x-1)}{x(x-2)(x+2)} = \lim_{x \rightarrow 1^+} \frac{(x-1)}{x(x+2)} = \frac{0}{(1)(3)} = 0$
 (e) $\lim_{x \rightarrow 0^+} \frac{x-1}{x(x+2)} = -\infty$ $\left(\begin{array}{l} \text{negative} \\ \text{positive-positive} \end{array} \right)$
 and $\lim_{x \rightarrow 0^-} \frac{x-1}{x(x+2)} = \infty$ $\left(\begin{array}{l} \text{negative} \\ \text{negative-positive} \end{array} \right)$
 so the function has no limit as $x \rightarrow 0$.

59. (a) $\lim_{t \rightarrow 0^+} \left[2 - \frac{3}{t^{1/3}} \right] = -\infty$ (b) $\lim_{t \rightarrow 0^-} \left[2 - \frac{3}{t^{1/3}} \right] = \infty$

60. (a) $\lim_{t \rightarrow 0^+} \left[\frac{1}{t^{3/5}} + 7 \right] = \infty$ (b) $\lim_{t \rightarrow 0^-} \left[\frac{1}{t^{3/5}} + 7 \right] = -\infty$

61. (a) $\lim_{x \rightarrow 0^+} \left[\frac{1}{x^{2/3}} + \frac{2}{(x-1)^{2/3}} \right] = \infty$ (b) $\lim_{x \rightarrow 0^-} \left[\frac{1}{x^{2/3}} + \frac{2}{(x-1)^{2/3}} \right] = \infty$

(c) $\lim_{x \rightarrow 1^+} \left[\frac{1}{x^{2/3}} + \frac{2}{(x-1)^{2/3}} \right] = \infty$ (d) $\lim_{x \rightarrow 1^-} \left[\frac{1}{x^{2/3}} + \frac{2}{(x-1)^{2/3}} \right] = \infty$

62. (a) $\lim_{x \rightarrow 0^+} \left[\frac{1}{x^{1/3}} - \frac{1}{(x-1)^{4/3}} \right] = \infty$ (b) $\lim_{x \rightarrow 0^-} \left[\frac{1}{x^{1/3}} - \frac{1}{(x-1)^{4/3}} \right] = -\infty$

(c) $\lim_{x \rightarrow 1^+} \left[\frac{1}{x^{1/3}} - \frac{1}{(x-1)^{4/3}} \right] = -\infty$ (d) $\lim_{x \rightarrow 1^-} \left[\frac{1}{x^{1/3}} - \frac{1}{(x-1)^{4/3}} \right] = -\infty$

63. $y = \frac{1}{x-1}$

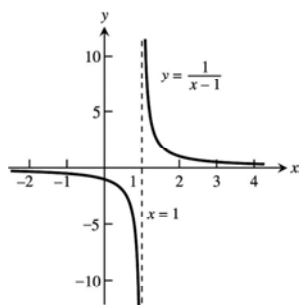

64. $y = \frac{1}{x+1}$

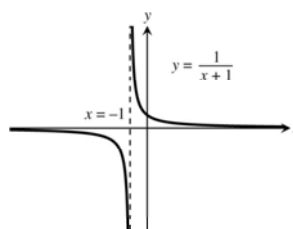

65. $y = \frac{1}{2x+4}$

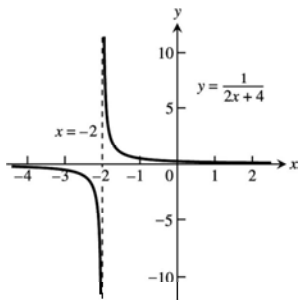

66. $y = \frac{-3}{x-3}$

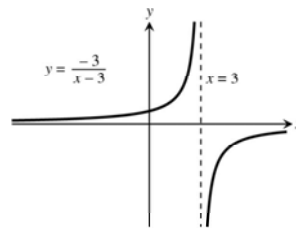

67. $y = \frac{x+3}{x+2} = 1 + \frac{1}{x+2}$

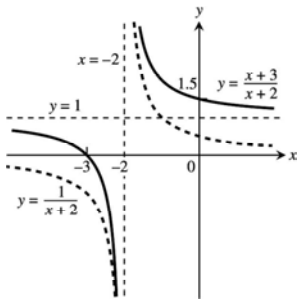

68. $y = \frac{2x}{x+1} = 2 - \frac{2}{x+1}$

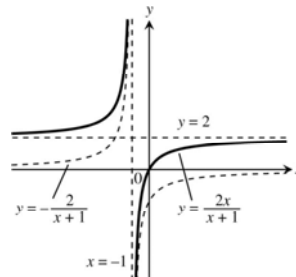

69. Here is one possibility.

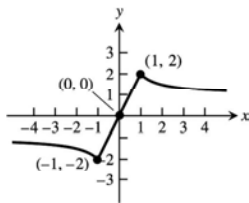

70. Here is one possibility.

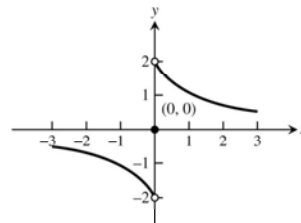

71. Here is one possibility.

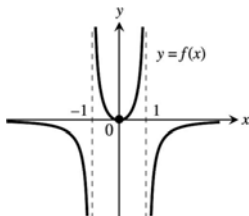

72. Here is one possibility.

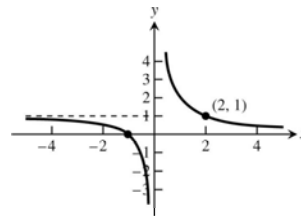

73. Here is one possibility.

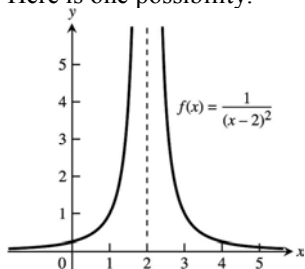

74. Here is one possibility.

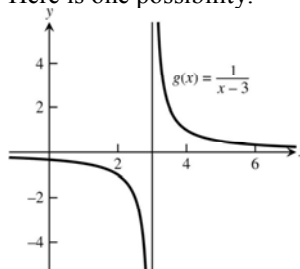

75. Here is one possibility.

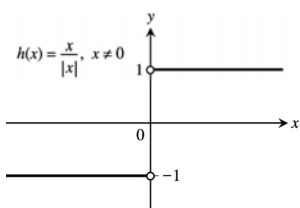

76. Here is one possibility.

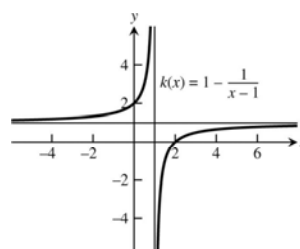

77. Yes. If $\lim_{x \rightarrow \infty} \frac{f(x)}{g(x)} = 2$ then the ratio the polynomials' leading coefficients is 2, so $\lim_{x \rightarrow -\infty} \frac{f(x)}{g(x)} = 2$ as well.

78. Yes, it can have a horizontal or oblique asymptote.

79. At most 1 horizontal asymptote: If $\lim_{x \rightarrow \infty} \frac{f(x)}{g(x)} = L$, then the ratio of the polynomials' leading coefficients is L , so $\lim_{x \rightarrow -\infty} \frac{f(x)}{g(x)} = L$ as well.

$$\begin{aligned} 80. \lim_{x \rightarrow \infty} (\sqrt{x+9} - \sqrt{x+4}) &= \lim_{x \rightarrow \infty} \left[\sqrt{x+9} - \sqrt{x+4} \right] \cdot \left[\frac{\sqrt{x+9} + \sqrt{x+4}}{\sqrt{x+9} + \sqrt{x+4}} \right] = \lim_{x \rightarrow \infty} \frac{(x+9) - (x+4)}{\sqrt{x+9} + \sqrt{x+4}} \\ &= \lim_{x \rightarrow \infty} \frac{5}{\sqrt{x+9} + \sqrt{x+4}} = \lim_{x \rightarrow \infty} \frac{\frac{5}{\sqrt{x}}}{\sqrt{1 + \frac{9}{x}} + \sqrt{1 + \frac{4}{x}}} = \frac{0}{1+1} = 0 \end{aligned}$$

$$\begin{aligned} 81. \lim_{x \rightarrow \infty} (\sqrt{x^2 + 25} - \sqrt{x^2 - 1}) &= \lim_{x \rightarrow \infty} \left[\sqrt{x^2 + 25} - \sqrt{x^2 - 1} \right] \cdot \left[\frac{\sqrt{x^2 + 25} + \sqrt{x^2 - 1}}{\sqrt{x^2 + 25} + \sqrt{x^2 - 1}} \right] = \lim_{x \rightarrow \infty} \frac{(x^2 + 25) - (x^2 - 1)}{\sqrt{x^2 + 25} + \sqrt{x^2 - 1}} \\ &= \lim_{x \rightarrow \infty} \frac{26}{\sqrt{x^2 + 25} + \sqrt{x^2 - 1}} = \lim_{x \rightarrow \infty} \frac{\frac{26}{x}}{\sqrt{1 + \frac{25}{x^2}} + \sqrt{1 - \frac{1}{x^2}}} = \frac{0}{1+1} = 0 \end{aligned}$$

$$\begin{aligned} 82. \lim_{x \rightarrow -\infty} (\sqrt{x^2 + 3} + x) &= \lim_{x \rightarrow -\infty} \left[\sqrt{x^2 + 3} + x \right] \cdot \left[\frac{\sqrt{x^2 + 3} - x}{\sqrt{x^2 + 3} - x} \right] = \lim_{x \rightarrow -\infty} \frac{(x^2 + 3) - (x^2)}{\sqrt{x^2 + 3} - x} = \lim_{x \rightarrow -\infty} \frac{3}{\sqrt{x^2 + 3} - x} \\ &= \lim_{x \rightarrow -\infty} \frac{\frac{3}{\sqrt{x^2}}}{\sqrt{1 + \frac{3}{x^2}} - \frac{x}{\sqrt{x^2}}} = \lim_{x \rightarrow -\infty} \frac{\frac{3}{x}}{\sqrt{1 + \frac{3}{x^2}} + 1} = \frac{0}{1+1} = 0 \end{aligned}$$

$$\begin{aligned}
 83. \quad \lim_{x \rightarrow -\infty} \left(2x + \sqrt{4x^2 + 3x - 2} \right) &= \lim_{x \rightarrow -\infty} \left[2x + \sqrt{4x^2 + 3x - 2} \right] \cdot \left[\frac{2x - \sqrt{4x^2 + 3x - 2}}{2x - \sqrt{4x^2 + 3x - 2}} \right] = \lim_{x \rightarrow -\infty} \frac{(4x^2) - (4x^2 + 3x - 2)}{2x - \sqrt{4x^2 + 3x - 2}} \\
 &= \lim_{x \rightarrow -\infty} \frac{-3x + 2}{2x - \sqrt{4x^2 + 3x - 2}} = \lim_{x \rightarrow -\infty} \frac{\frac{-3x + 2}{\sqrt{x^2}}}{\frac{2x}{\sqrt{x^2}} - \sqrt{4 + \frac{3}{x} - \frac{2}{x^2}}} = \lim_{x \rightarrow -\infty} \frac{\frac{-3x + 2}{-x}}{\frac{2x}{-x} - \sqrt{4 + \frac{3}{x} - \frac{2}{x^2}}} \\
 &= \lim_{x \rightarrow -\infty} \frac{3 - \frac{2}{x}}{-2 - \sqrt{4 + \frac{3}{x} - \frac{2}{x^2}}} = \frac{3 - 0}{-2 - 2} = -\frac{3}{4}
 \end{aligned}$$

$$\begin{aligned}
 84. \quad \lim_{x \rightarrow \infty} \left(\sqrt{9x^2 - x} - 3x \right) &= \lim_{x \rightarrow \infty} \left[\sqrt{9x^2 - x} - 3x \right] \cdot \left[\frac{\sqrt{9x^2 - x} + 3x}{\sqrt{9x^2 - x} + 3x} \right] = \lim_{x \rightarrow \infty} \frac{(9x^2 - x) - (9x^2)}{\sqrt{9x^2 - x} + 3x} = \lim_{x \rightarrow \infty} \frac{-x}{\sqrt{9x^2 - x} + 3x} \\
 &= \lim_{x \rightarrow \infty} \frac{\frac{-x}{x}}{\sqrt{\frac{9x^2 - x}{x^2} + \frac{3x}{x^2}}} = \lim_{x \rightarrow \infty} \frac{-1}{\sqrt{9 - \frac{1}{x} + 3}} = \frac{-1}{3 + 3} = -\frac{1}{6}
 \end{aligned}$$

$$\begin{aligned}
 85. \quad \lim_{x \rightarrow \infty} \left(\sqrt{x^2 + 3x} - \sqrt{x^2 - 2x} \right) &= \lim_{x \rightarrow \infty} \left[\sqrt{x^2 + 3x} - \sqrt{x^2 - 2x} \right] \cdot \left[\frac{\sqrt{x^2 + 3x} + \sqrt{x^2 - 2x}}{\sqrt{x^2 + 3x} + \sqrt{x^2 - 2x}} \right] = \lim_{x \rightarrow \infty} \frac{(x^2 + 3x) - (x^2 - 2x)}{\sqrt{x^2 + 3x} + \sqrt{x^2 - 2x}} \\
 &= \lim_{x \rightarrow \infty} \frac{5x}{\sqrt{x^2 + 3x} + \sqrt{x^2 - 2x}} = \lim_{x \rightarrow \infty} \frac{5}{\sqrt{1 + \frac{3}{x}} + \sqrt{1 - \frac{2}{x}}} = \frac{5}{1 + 1} = \frac{5}{2}
 \end{aligned}$$

$$\begin{aligned}
 86. \quad \lim_{x \rightarrow \infty} \sqrt{x^2 + x} - \sqrt{x^2 - x} &= \lim_{x \rightarrow \infty} \left[\sqrt{x^2 + x} - \sqrt{x^2 - x} \right] \cdot \left[\frac{\sqrt{x^2 + x} + \sqrt{x^2 - x}}{\sqrt{x^2 + x} + \sqrt{x^2 - x}} \right] = \lim_{x \rightarrow \infty} \frac{(x^2 + x) - (x^2 - x)}{\sqrt{x^2 + x} + \sqrt{x^2 - x}} = \lim_{x \rightarrow \infty} \frac{2x}{\sqrt{x^2 + x} + \sqrt{x^2 - x}} \\
 &= \lim_{x \rightarrow \infty} \frac{2}{\sqrt{1 + \frac{1}{x}} + \sqrt{1 - \frac{1}{x}}} = \frac{2}{1 + 1} = 1
 \end{aligned}$$

87. For any $\epsilon > 0$, take $N = 1$. Then for all $x > N$ we have that $|f(x) - k| = |k - k| = 0 < \epsilon$.

88. For any $\epsilon > 0$, take $N = 1$. Then for all $y < -N$ we have that $|f(x) - k| = |k - k| = 0 < \epsilon$.

89. For every real number $-B < 0$, we must find a $\delta > 0$ such that for all x , $0 < |x - 0| < \delta \Rightarrow \frac{-1}{x^2} < -B$.
 Now, $-\frac{1}{x^2} < -B < 0 \Leftrightarrow \frac{1}{x^2} > B > 0 \Leftrightarrow x^2 < \frac{1}{B} \Leftrightarrow |x| < \frac{1}{\sqrt{B}}$. Choose $\delta = \frac{1}{\sqrt{B}}$, then $0 < |x| < \delta \Rightarrow |x| < \frac{1}{\sqrt{B}} \Rightarrow \frac{-1}{x^2} < -B$ so that $\lim_{x \rightarrow 0} \frac{-1}{x^2} = -\infty$.

90. For every real number $B > 0$, we must find a $\delta > 0$ such that for all x , $0 < |x - 0| < \delta \Rightarrow \frac{1}{|x|} > B$. Now,
 $\frac{1}{|x|} > B > 0 \Leftrightarrow |x| < \frac{1}{B}$. Choose $\delta = \frac{1}{B}$. Then $0 < |x - 0| < \delta \Rightarrow |x| < \frac{1}{B} \Rightarrow \frac{1}{|x|} > B$ so that $\lim_{x \rightarrow 0} \frac{1}{|x|} = \infty$.

91. For every real number $-B < 0$, we must find a $\delta > 0$ such that for all x , $0 < |x - 3| < \delta \Rightarrow \frac{-2}{(x-3)^2} < -B$. Now,
 $\frac{-2}{(x-3)^2} < -B < 0 \Leftrightarrow \frac{2}{(x-3)^2} > B > 0 \Leftrightarrow \frac{(x-3)^2}{2} < \frac{1}{B} \Leftrightarrow (x-3)^2 < \frac{2}{B} \Leftrightarrow 0 < |x - 3| < \sqrt{\frac{2}{B}}$. Choose $\delta = \sqrt{\frac{2}{B}}$, then
 $0 < |x - 3| < \delta \Rightarrow \frac{-2}{(x-3)^2} < -B < 0$ so that $\lim_{x \rightarrow 3} \frac{-2}{(x-3)^2} = -\infty$.

92. For every real number $B > 0$, we must find a $\delta > 0$ such that for all x , $0 < |x - (-5)| < \delta \Rightarrow \frac{1}{(x+5)^2} > B$.
 Now, $\frac{1}{(x+5)^2} > B > 0 \Leftrightarrow (x+5)^2 < \frac{1}{B} \Leftrightarrow |x+5| < \frac{1}{\sqrt{B}}$. Choose $\delta = \frac{1}{\sqrt{B}}$. Then $0 < |x - (-5)| < \delta \Rightarrow |x+5| < \frac{1}{\sqrt{B}} \Rightarrow \frac{1}{(x+5)^2} > B$ so that $\lim_{x \rightarrow -5} \frac{1}{(x+5)^2} = \infty$.

93. (a) We say that $f(x)$ approaches infinity as x approaches x_0 from the left, and write $\lim_{x \rightarrow x_0^-} f(x) = \infty$, if for every positive number B , there exists a corresponding number $\delta > 0$ such that for all x , $x_0 - \delta < x < x_0 \Rightarrow f(x) > B$.
- (b) We say that $f(x)$ approaches minus infinity as x approaches x_0 from the right, and write $\lim_{x \rightarrow x_0^+} f(x) = -\infty$, if for every positive number B (or negative number $-B$) there exists a corresponding number $\delta > 0$ such that for all x , $x_0 < x < x_0 + \delta \Rightarrow f(x) < -B$.
- (c) We say that $f(x)$ approaches minus infinity as x approaches x_0 from the left, and write $\lim_{x \rightarrow x_0^-} f(x) = -\infty$, if for every positive number B (or negative number $-B$) there exists a corresponding number $\delta > 0$ such that for all x , $x_0 - \delta < x < x_0 \Rightarrow f(x) < -B$.

94. For $B > 0$, $\frac{1}{x} > B > 0 \Leftrightarrow x < \frac{1}{B}$. Choose $\delta = \frac{1}{B}$. Then $0 < x < \delta \Rightarrow 0 < x < \frac{1}{B} \Rightarrow \frac{1}{x} > B$ so that $\lim_{x \rightarrow 0^+} \frac{1}{x} = \infty$.

95. For $B > 0$, $\frac{1}{x} < -B < 0 \Leftrightarrow -\frac{1}{x} > B > 0 \Leftrightarrow -x < \frac{1}{B} \Leftrightarrow -\frac{1}{B} < x$. Choose $\delta = \frac{1}{B}$. Then $-\delta < x < 0 \Rightarrow -\frac{1}{B} < x < 0 \Rightarrow \frac{1}{x} < -B$ so that $\lim_{x \rightarrow 0^-} \frac{1}{x} = -\infty$.

96. For $B > 0$, $\frac{1}{x-2} < -B \Leftrightarrow -\frac{1}{x-2} > B \Leftrightarrow -(x-2) < \frac{1}{B} \Leftrightarrow x-2 > -\frac{1}{B} \Leftrightarrow x > 2 - \frac{1}{B}$. Choose $\delta = \frac{1}{B}$. Then $2 - \delta < x < 2 \Rightarrow -\delta < x-2 < 0 \Rightarrow -\frac{1}{B} < x-2 < 0 \Rightarrow \frac{1}{x-2} < -B < 0$ so that $\lim_{x \rightarrow 2^-} \frac{1}{x-2} = -\infty$.

97. For $B > 0$, $\frac{1}{x-2} > B > 0 \Leftrightarrow 0 < x-2 < \frac{1}{B}$. Choose $\delta = \frac{1}{B}$. Then $2 < x < 2 + \delta \Rightarrow 0 < x-2 < \delta \Rightarrow 0 < x-2 < \frac{1}{B} \Rightarrow \frac{1}{x-2} > B > 0$ so that $\lim_{x \rightarrow 2^+} \frac{1}{x-2} = \infty$.

98. For $B > 0$ and $0 < x < 1$, $\frac{1}{1-x^2} > B \Leftrightarrow 1-x^2 < \frac{1}{B} \Leftrightarrow (1-x)(1+x) < \frac{1}{B}$. Now $\frac{1+x}{2} < 1$ since $x < 1$. Choose $\delta < \frac{1}{2B}$. Then $1-\delta < x < 1 \Rightarrow -\delta < x-1 < 0 \Rightarrow 1-x < \delta < \frac{1}{2B} \Rightarrow (1-x)(1+x) < \frac{1}{B} \left(\frac{1+x}{2}\right) < \frac{1}{B} \Rightarrow \frac{1}{1-x^2} > B$ for $0 < x < 1$ and x near 1 $\Rightarrow \lim_{x \rightarrow 1^-} \frac{1}{1-x^2} = \infty$.

99. $y = \frac{x^2}{x-1} = x + 1 + \frac{1}{x-1}$

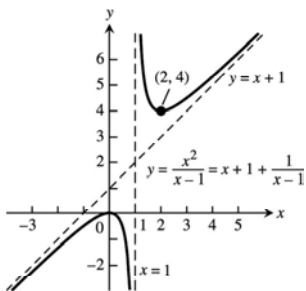

100. $y = \frac{x^2+1}{x-1} = x + 1 + \frac{2}{x-1}$

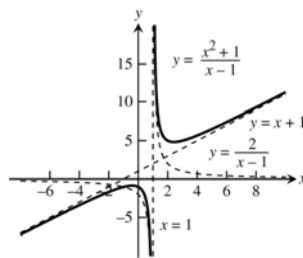

101. $y = \frac{x^2-4}{x-1} = x+1 - \frac{3}{x-1}$

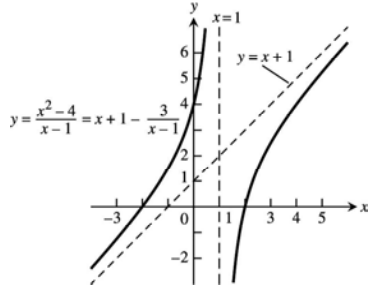

102. $y = \frac{x^2-1}{2x+4} = \frac{1}{2}x - 1 + \frac{3}{2x+4}$

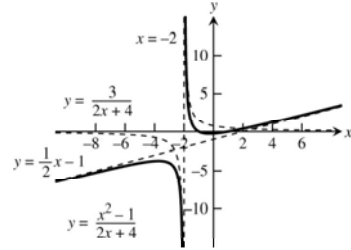

103. $y = \frac{x^2-1}{x} = x - \frac{1}{x}$

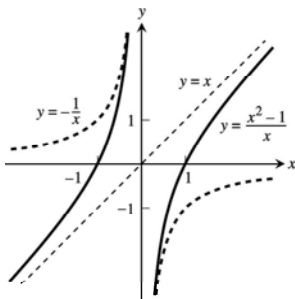

104. $y = \frac{x^3+1}{x^2} = x + \frac{1}{x^2}$

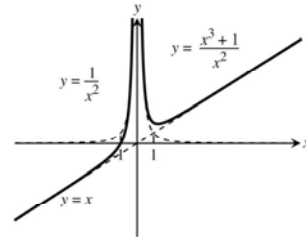

105. $y = \frac{x}{\sqrt{4-x^2}}$

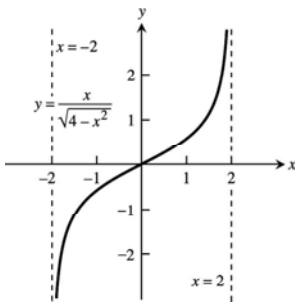

106. $y = \frac{-1}{\sqrt{4-x^2}}$

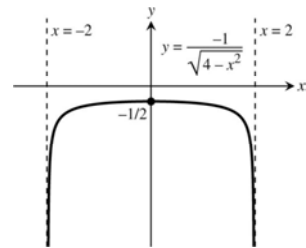

107. $y = x^{2/3} + \frac{1}{x^{1/3}}$

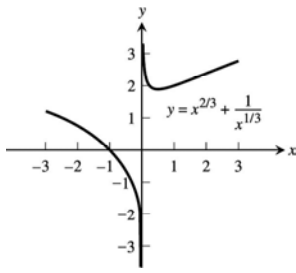

108. $y = \sin\left(\frac{\pi}{x^2+1}\right)$

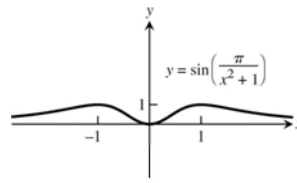

109. (a) $y \rightarrow \infty$ (see accompanying graph)
 (b) $y \rightarrow \infty$ (see accompanying graph)
 (c) cusps at $x = \pm 1$ (see accompanying graph)

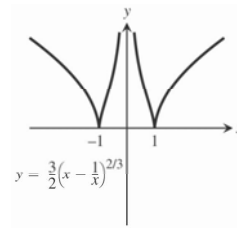

110. (a) $y \rightarrow 0$ and a cusp at $x = 0$ (see the accompanying graph)
 (b) $y \rightarrow \frac{3}{2}$ (see accompanying graph)
 (c) a vertical asymptote at $x = 1$ and contains the point $\left(-1, \frac{3}{2\sqrt[3]{4}}\right)$ (see accompanying graph)

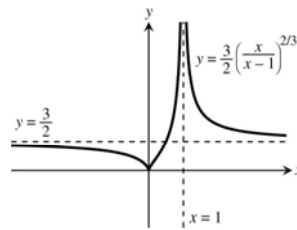

CHAPTER 2 PRACTICE EXERCISES

1. At $x = -1$: $\lim_{x \rightarrow -1^-} f(x) = \lim_{x \rightarrow -1^+} f(x) = 1$
 $\Rightarrow \lim_{x \rightarrow -1} f(x) = 1 = f(-1)$
 $\Rightarrow f$ is continuous at $x = -1$.

- At $x = 0$: $\lim_{x \rightarrow 0^-} f(x) = \lim_{x \rightarrow 0^+} f(x) = 0$
 $\Rightarrow \lim_{x \rightarrow 0} f(x) = 0$.

But $f(0) = 1 \neq \lim_{x \rightarrow 0} f(x)$

$\Rightarrow f$ is discontinuous at $x = 0$.

If we define $f(0) = 0$, then the discontinuity at $x = 0$ is removable.

- At $x = 1$: $\lim_{x \rightarrow 1^-} f(x) = -1$ and $\lim_{x \rightarrow 1^+} f(x) = 1$

$\Rightarrow \lim_{x \rightarrow 1} f(x)$ does not exist

$\Rightarrow f$ is discontinuous at $x = 1$.

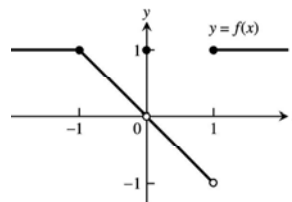

2. At $x = -1$: $\lim_{x \rightarrow -1^-} f(x) = 0$ and $\lim_{x \rightarrow -1^+} f(x) = -1$
 $\Rightarrow \lim_{x \rightarrow -1} f(x)$ does not exist
 $\Rightarrow f$ is discontinuous at $x = -1$.

- At $x = 0$: $\lim_{x \rightarrow 0^-} f(x) = -\infty$ and $\lim_{x \rightarrow 0^+} f(x) = \infty$
 $\Rightarrow \lim_{x \rightarrow 0} f(x)$ does not exist
 $\Rightarrow f$ is discontinuous at $x = 0$.

- At $x = 1$: $\lim_{x \rightarrow 1^-} f(x) = \lim_{x \rightarrow 1^+} f(x) = 1 \Rightarrow \lim_{x \rightarrow 1} f(x) = 1$.
 But $f(1) = 0 \neq \lim_{x \rightarrow 1} f(x)$
 $\Rightarrow f$ is discontinuous at $x = 1$.
 If we define $f(1) = 1$, then the discontinuity at $x = 1$ is removable.

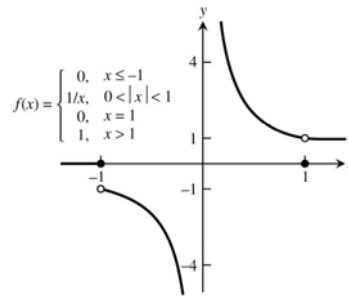

3. (a) $\lim_{t \rightarrow t_0} (3f(t)) = 3 \lim_{t \rightarrow t_0} f(t) = 3(-7) = -21$
 (b) $\lim_{t \rightarrow t_0} (f(t))^2 = \left(\lim_{t \rightarrow t_0} f(t) \right)^2 = (-7)^2 = 49$
 (c) $\lim_{t \rightarrow t_0} (f(t) \cdot g(t)) = \lim_{t \rightarrow t_0} f(t) \cdot \lim_{t \rightarrow t_0} g(t) = (-7)(0) = 0$
 (d) $\lim_{t \rightarrow t_0} \frac{f(t)}{g(t)-7} = \frac{\lim_{t \rightarrow t_0} f(t)}{\lim_{t \rightarrow t_0} (g(t)-7)} = \frac{\lim_{t \rightarrow t_0} f(t)}{\lim_{t \rightarrow t_0} g(t) - \lim_{t \rightarrow t_0} 7} = \frac{-7}{0-7} = 1$
 (e) $\lim_{t \rightarrow t_0} \cos(g(t)) = \cos\left(\lim_{t \rightarrow t_0} g(t)\right) = \cos 0 = 1$
 (f) $\lim_{t \rightarrow t_0} |f(t)| = \left| \lim_{t \rightarrow t_0} f(t) \right| = |-7| = 7$
 (g) $\lim_{t \rightarrow t_0} (f(t) + g(t)) = \lim_{t \rightarrow t_0} f(t) + \lim_{t \rightarrow t_0} g(t) = -7 + 0 = -7$
 (h) $\lim_{t \rightarrow t_0} \left(\frac{1}{f(t)} \right) = \frac{1}{\lim_{t \rightarrow t_0} f(t)} = \frac{1}{-7} = -\frac{1}{7}$

4. (a) $\lim_{x \rightarrow 0} -g(x) = -\lim_{x \rightarrow 0} g(x) = -\sqrt{2}$
 (b) $\lim_{x \rightarrow 0} (g(x) \cdot f(x)) = \lim_{x \rightarrow 0} g(x) \cdot \lim_{x \rightarrow 0} f(x) = (\sqrt{2})\left(\frac{1}{2}\right) = \frac{\sqrt{2}}{2}$
 (c) $\lim_{x \rightarrow 0} (f(x) + g(x)) = \lim_{x \rightarrow 0} f(x) + \lim_{x \rightarrow 0} g(x) = \frac{1}{2} + \sqrt{2}$
 (d) $\lim_{x \rightarrow 0} \frac{1}{f(x)} = \frac{1}{\lim_{x \rightarrow 0} f(x)} = \frac{1}{\frac{1}{2}} = 2$
 (e) $\lim_{x \rightarrow 0} (x + f(x)) = \lim_{x \rightarrow 0} x + \lim_{x \rightarrow 0} f(x) = 0 + \frac{1}{2} = \frac{1}{2}$
 (f) $\lim_{x \rightarrow 0} \frac{f(x) \cdot \cos x}{x-1} = \frac{\lim_{x \rightarrow 0} f(x) \cdot \lim_{x \rightarrow 0} \cos x}{\lim_{x \rightarrow 0} x - \lim_{x \rightarrow 0} 1} = \frac{\left(\frac{1}{2}\right)(1)}{0-1} = -\frac{1}{2}$

5. Since $\lim_{x \rightarrow 0} x = 0$ we must have that $\lim_{x \rightarrow 0} (4 - g(x)) = 0$. Otherwise, if $\lim_{x \rightarrow 0} (4 - g(x))$ is a finite positive number, we would have $\lim_{x \rightarrow 0^-} \left[\frac{4-g(x)}{x} \right] = -\infty$ and $\lim_{x \rightarrow 0^+} \left[\frac{4-g(x)}{x} \right] = \infty$ so the limit could not equal 1 as $x \rightarrow 0$. Similar reasoning holds if $\lim_{x \rightarrow 0} (4 - g(x))$ is a finite negative number. We conclude that $\lim_{x \rightarrow 0} g(x) = 4$.

6. $2 = \lim_{x \rightarrow -4} \left[x \lim_{x \rightarrow 0} g(x) \right] = \lim_{x \rightarrow -4} x \cdot \lim_{x \rightarrow -4} \left[\lim_{x \rightarrow 0} g(x) \right] = -4 \lim_{x \rightarrow -4} \left[\lim_{x \rightarrow 0} g(x) \right] = -4 \lim_{x \rightarrow 0} g(x)$ (since $\lim_{x \rightarrow 0} g(x)$ is a constant) $\Rightarrow \lim_{x \rightarrow 0} g(x) = \frac{2}{-4} = -\frac{1}{2}$.
7. (a) $\lim_{x \rightarrow c} f(x) = \lim_{x \rightarrow c} x^{1/3} = c^{1/3} = f(c)$ for every real number $c \Rightarrow f$ is continuous on $(-\infty, \infty)$.
 (b) $\lim_{x \rightarrow c} g(x) = \lim_{x \rightarrow c} x^{3/4} = c^{3/4} = g(c)$ for every nonnegative real number $c \Rightarrow g$ is continuous on $[0, \infty)$.
 (c) $\lim_{x \rightarrow c} h(x) = \lim_{x \rightarrow c} x^{-2/3} = \frac{1}{c^{2/3}} = h(c)$ for every nonzero real number $c \Rightarrow h$ is continuous on $(-\infty, 0)$ and $(0, \infty)$.
 (d) $\lim_{x \rightarrow c} k(x) = \lim_{x \rightarrow c} x^{-1/6} = \frac{1}{c^{1/6}} = k(c)$ for every positive real number $c \Rightarrow k$ is continuous on $(0, \infty)$.
8. (a) $\bigcup_{n \in I} \left(\left(n - \frac{1}{2} \right) \pi, \left(n + \frac{1}{2} \right) \pi \right)$, where I = the set of all integers.
 (b) $\bigcup_{n \in I} (n\pi, (n+1)\pi)$, where I = the set of all integers.
 (c) $(-\infty, \pi) \cup (\pi, \infty)$
 (d) $(-\infty, 0) \cup (0, \infty)$
9. (a) $\lim_{x \rightarrow 0} \frac{x^2 - 4x + 4}{x^3 + 5x^2 - 14x} = \lim_{x \rightarrow 0} \frac{(x-2)(x-2)}{x(x+7)(x-2)} = \lim_{x \rightarrow 0} \frac{x-2}{x(x+7)}$, $x \neq 2$; the limit does not exist because $\lim_{x \rightarrow 0^-} \frac{x-2}{x(x+7)} = \infty$ and $\lim_{x \rightarrow 0^+} \frac{x-2}{x(x+7)} = -\infty$
 (b) $\lim_{x \rightarrow 2} \frac{x^2 - 4x + 4}{x^3 + 5x^2 - 14x} = \lim_{x \rightarrow 2} \frac{(x-2)(x-2)}{x(x+7)(x-2)} = \lim_{x \rightarrow 2} \frac{x-2}{x(x+7)}$, $x \neq 2$, and $\lim_{x \rightarrow 2} \frac{x-2}{x(x+7)} = \frac{0}{2(9)} = 0$
10. (a) $\lim_{x \rightarrow 0} \frac{x^2 + x}{x^5 + 2x^4 + x^3} = \lim_{x \rightarrow 0} \frac{x(x+1)}{x^3(x^2 + 2x + 1)} = \lim_{x \rightarrow 0} \frac{x+1}{x^2(x+1)(x+1)} = \lim_{x \rightarrow 0} \frac{1}{x^2(x+1)}$, $x \neq 0$ and $x \neq -1$.
 Now $\lim_{x \rightarrow 0^-} \frac{1}{x^2(x+1)} = \infty$ and $\lim_{x \rightarrow 0^+} \frac{1}{x^2(x+1)} = \infty \Rightarrow \lim_{x \rightarrow 0} \frac{x^2 + x}{x^5 + 2x^4 + x^3} = \infty$.
 (b) $\lim_{x \rightarrow -1} \frac{x^2 + x}{x^5 + 2x^4 + x^3} = \lim_{x \rightarrow -1} \frac{x(x+1)}{x^3(x^2 + 2x + 1)} = \lim_{x \rightarrow -1} \frac{1}{x^2(x+1)}$, $x \neq 0$ and $x \neq -1$. The limit does not exist because $\lim_{x \rightarrow -1^-} \frac{1}{x^2(x+1)} = -\infty$ and $\lim_{x \rightarrow -1^+} \frac{1}{x^2(x+1)} = \infty$.
11. $\lim_{x \rightarrow 1} \frac{1 - \sqrt{x}}{1 - x} = \lim_{x \rightarrow 1} \frac{1 - \sqrt{x}}{(1 - \sqrt{x})(1 + \sqrt{x})} = \lim_{x \rightarrow 1} \frac{1}{1 + \sqrt{x}} = \frac{1}{2}$
12. $\lim_{x \rightarrow a} \frac{x^2 - a^2}{x^4 - a^4} = \lim_{x \rightarrow a} \frac{(x^2 - a^2)}{(x^2 + a^2)(x^2 - a^2)} = \lim_{x \rightarrow a} \frac{1}{x^2 + a^2} = \frac{1}{2a^2}$
13. $\lim_{h \rightarrow 0} \frac{(x+h)^2 - x^2}{h} = \lim_{h \rightarrow 0} \frac{(x^2 + 2hx + h^2) - x^2}{h} = \lim_{h \rightarrow 0} (2x + h) = 2x$
14. $\lim_{x \rightarrow 0} \frac{(x+h)^2 - x^2}{h} = \lim_{x \rightarrow 0} \frac{(x^2 + 2hx + h^2) - x^2}{h} = \lim_{x \rightarrow 0} (2x + h) = h$
15. $\lim_{x \rightarrow 0} \frac{\frac{1}{2+x} - \frac{1}{2}}{x} = \lim_{x \rightarrow 0} \frac{2 - (2+x)}{2x(2+x)} = \lim_{x \rightarrow 0} \frac{-1}{4+2x} = -\frac{1}{4}$
16. $\lim_{x \rightarrow 0} \frac{(2+x)^3 - 8}{x} = \lim_{x \rightarrow 0} \frac{(x^3 + 6x^2 + 12x + 8) - 8}{x} = \lim_{x \rightarrow 0} (x^2 + 6x + 12) = 12$

17. $\lim_{x \rightarrow 1} \frac{x^{1/3}-1}{\sqrt{x}-1} = \lim_{x \rightarrow 1} \frac{(x^{1/3}-1) \cdot (x^{2/3}+x^{1/3}+1)(\sqrt{x}+1)}{(\sqrt{x}-1)(x^{2/3}+x^{1/3}+1)} = \lim_{x \rightarrow 1} \frac{(x-1)(\sqrt{x}+1)}{(x-1)(x^{2/3}+x^{1/3}+1)} = \lim_{x \rightarrow 1} \frac{\sqrt{x}+1}{x^{2/3}+x^{1/3}+1} = \frac{1+1}{1+1+1} = \frac{2}{3}$
18. $\lim_{x \rightarrow 64} \frac{x^{2/3}-16}{\sqrt{x}-8} = \lim_{x \rightarrow 64} \frac{(x^{1/3}-4)(x^{1/3}+4)}{\sqrt{x}-8} = \lim_{x \rightarrow 64} \frac{(x^{1/3}-4)(x^{1/3}+4) \cdot (x^{2/3}+4x^{1/3}+16)(\sqrt{x}+8)}{(\sqrt{x}-8)(x^{2/3}+4x^{1/3}+16)}$
 $= \lim_{x \rightarrow 64} \frac{(x-64)(x^{1/3}+4)(\sqrt{x}+8)}{(x-64)(x^{2/3}+4x^{1/3}+16)} = \lim_{x \rightarrow 64} \frac{(x^{1/3}+4)(\sqrt{x}+8)}{x^{2/3}+4x^{1/3}+16} = \frac{(4+4)(8+8)}{16+16+16} = \frac{8}{3}$
19. $\lim_{x \rightarrow 0} \frac{\tan 2x}{\tan \pi x} = \lim_{x \rightarrow 0} \frac{\sin 2x}{\cos 2x} \cdot \frac{\cos \pi x}{\sin \pi x} = \lim_{x \rightarrow 0} \left(\frac{\sin 2x}{2x} \right) \left(\frac{\cos \pi x}{\cos 2x} \right) \left(\frac{\pi x}{\sin \pi x} \right) \left(\frac{2x}{\pi x} \right) = 1 \cdot 1 \cdot 1 \cdot \frac{2}{\pi} = \frac{2}{\pi}$
20. $\lim_{x \rightarrow \pi^-} \csc x = \lim_{x \rightarrow \pi^-} \frac{1}{\sin x} = \infty$
21. $\lim_{x \rightarrow \pi} \sin\left(\frac{x}{2} + \sin x\right) = \sin\left(\frac{\pi}{2} + \sin \pi\right) = \sin\left(\frac{\pi}{2}\right) = 1$
22. $\lim_{x \rightarrow \pi} \cos^2(x - \tan x) = \cos^2(\pi - \tan \pi) = \cos^2(\pi) = (-1)^2 = 1$
23. $\lim_{x \rightarrow 0} \frac{8x}{3 \sin x - x} = \lim_{x \rightarrow 0} \frac{8}{3 \frac{\sin x}{x} - 1} = \frac{8}{3(1) - 1} = 4$
24. $\lim_{x \rightarrow 0} \frac{\cos 2x - 1}{\sin x} = \lim_{x \rightarrow 0} \left(\frac{\cos 2x - 1}{\sin x} \cdot \frac{\cos 2x + 1}{\cos 2x + 1} \right) = \lim_{x \rightarrow 0} \frac{\cos^2 2x - 1}{\sin x(\cos 2x + 1)} = \lim_{x \rightarrow 0} \frac{-\sin^2 2x}{\sin x(\cos 2x + 1)}$
 $= \lim_{x \rightarrow 0} \frac{-4 \sin x \cos^2 x}{\cos 2x + 1} = \frac{-4(0)(1)^2}{1+1} = 0$
25. Let $x = t - 3 \Rightarrow \lim_{t \rightarrow 3^+} \ln(t - 3) = \lim_{x \rightarrow 0^+} \ln x = -\infty$
26. $\lim_{t \rightarrow 1} t^2 \ln(2 - \sqrt{t}) = \ln 1 = 0$
27. $-1 \leq \cos\left(\frac{\pi}{\theta}\right) \leq 1 \Rightarrow e^{-1} \leq e^{\cos(\pi/\theta)} \leq e^1 \Rightarrow \sqrt{\theta}e^{-1} \leq \sqrt{\theta}e^{\cos(\pi/\theta)} \leq \sqrt{\theta}e \Rightarrow \lim_{\theta \rightarrow 0^+} \sqrt{\theta}e^{\cos(\pi/\theta)} = 0$ by the Sandwich Theorem
28. $\lim_{z \rightarrow 0^+} \frac{2e^{1/z}}{e^{1/z} + 1} = \lim_{z \rightarrow 0^+} \frac{2}{1 + e^{1/z}} = \frac{2}{1+0} = 2$
29. $\lim_{x \rightarrow 0^+} [4g(x)]^{1/3} = 2 \Rightarrow \left[\lim_{x \rightarrow 0^+} 4g(x) \right]^{1/3} = 2 \Rightarrow \lim_{x \rightarrow 0^+} 4g(x) = 8$, since $2^3 = 8$. Then $\lim_{x \rightarrow 0^+} g(x) = 2$.
30. $\lim_{x \rightarrow \sqrt{5}} \frac{1}{x+g(x)} = 2 \Rightarrow \lim_{x \rightarrow \sqrt{5}} (x+g(x)) = \frac{1}{2} \Rightarrow \sqrt{5} + \lim_{x \rightarrow \sqrt{5}} g(x) = \frac{1}{2} \Rightarrow \lim_{x \rightarrow \sqrt{5}} g(x) = \frac{1}{2} - \sqrt{5}$
31. $\lim_{x \rightarrow 1} \frac{3x^2+1}{g(x)} = \infty \Rightarrow \lim_{x \rightarrow 1} g(x) = 0$ since $\lim_{x \rightarrow 1} (3x^2 + 1) = 4$
32. $\lim_{x \rightarrow -2} \frac{5-x^2}{\sqrt{g(x)}} = 0 \Rightarrow \lim_{x \rightarrow -2} g(x) = \infty$ since $\lim_{x \rightarrow -2} (5-x^2) = 1$

33. At $x = -1$: $\lim_{x \rightarrow -1^-} f(x) = \lim_{x \rightarrow -1^-} \frac{x(x^2-1)}{|x^2-1|}$
 $= \lim_{x \rightarrow -1^-} \frac{x(x^2-1)}{x^2-1} = \lim_{x \rightarrow -1^-} x = -1$, and
 $\lim_{x \rightarrow -1^+} f(x) = \lim_{x \rightarrow -1^+} \frac{x(x^2-1)}{|x^2-1|} = \lim_{x \rightarrow -1^+} \frac{x(x^2-1)}{-(x^2-1)}$
 $= \lim_{x \rightarrow -1^+} (-x) = -(-1) = 1$. Since $\lim_{x \rightarrow -1^-} f(x) \neq \lim_{x \rightarrow -1^+} f(x) \Rightarrow \lim_{x \rightarrow -1} f(x)$ does not exist, the function f cannot be extended to a continuous function at $x = -1$.

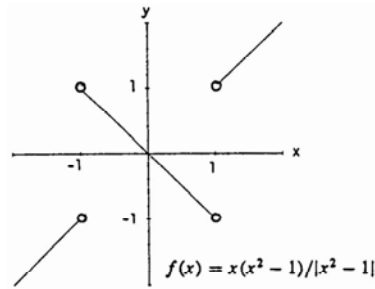

At $x = 1$: $\lim_{x \rightarrow 1^-} f(x) = \lim_{x \rightarrow 1^-} \frac{x(x^2-1)}{|x^2-1|} = \lim_{x \rightarrow 1^-} \frac{x(x^2-1)}{-(x^2-1)} = \lim_{x \rightarrow 1^-} (-x) = -1$, and $\lim_{x \rightarrow 1^+} f(x) = \lim_{x \rightarrow 1^+} \frac{x(x^2-1)}{|x^2-1|}$
 $= \lim_{x \rightarrow 1^+} \frac{x(x^2-1)}{x^2-1} = \lim_{x \rightarrow 1^+} x = 1$.

Again $\lim_{x \rightarrow 1} f(x)$ does not exist so f cannot be extended to a continuous function at $x = 1$ either.

34. The discontinuity at $x = 0$ of $f(x) = \sin\left(\frac{1}{x}\right)$ is nonremovable because $\lim_{x \rightarrow 0} \sin\frac{1}{x}$ does not exist.

35. Yes, f does have a continuous extension at $a = 1$:
 define $f(1) = \lim_{x \rightarrow 1} \frac{x-1}{x-\sqrt{x}} = \frac{4}{3}$.

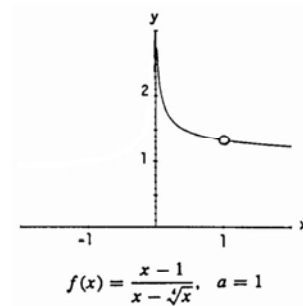

36. Yes, g does have a continuous extension at $a = \frac{\pi}{2}$:
 $g\left(\frac{\pi}{2}\right) = \lim_{\theta \rightarrow \frac{\pi}{2}} \frac{5 \cos \theta}{4\theta - 2\pi} = -\frac{5}{4}$.

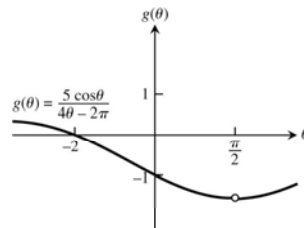

37. From the graph we see that $\lim_{t \rightarrow 0^-} h(t) \neq \lim_{t \rightarrow 0^+} h(t)$
 so h cannot be extended to a continuous function at $a = 0$.

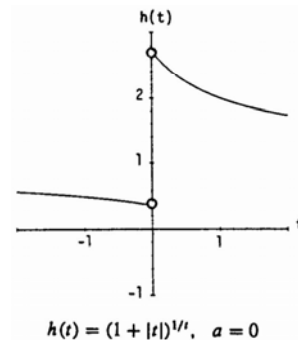

38. From the graph we see that $\lim_{x \rightarrow 0^-} k(x) \neq \lim_{x \rightarrow 0^+} k(x)$
so k cannot be extended to a continuous function at $a = 0$.

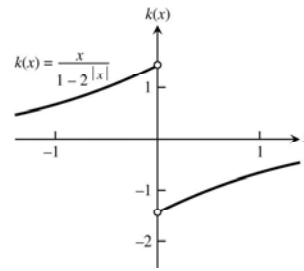

39. (a) $f(-1) = -1$ and $f(2) = 5 \Rightarrow f$ has a root between -1 and 2 by the Intermediate Value Theorem.
(b), (c) root is 1.32471795724
40. (a) $f(-2) = -2$ and $f(0) = 2 \Rightarrow f$ has a root between -2 and 0 by the Intermediate Value Theorem.
(b), (c) root is -1.76929235424

$$41. \lim_{x \rightarrow -\infty} \frac{2x+3}{5x+7} = \lim_{x \rightarrow \infty} \frac{2+\frac{3}{x}}{5+\frac{7}{x}} = \frac{2+0}{5+0} = \frac{2}{5}$$

$$42. \lim_{x \rightarrow -\infty} \frac{2x^2+3}{5x^2+7} = \lim_{x \rightarrow -\infty} \frac{2+\frac{3}{x^2}}{5+\frac{7}{x^2}} = \frac{2+0}{5+0} = \frac{2}{5}$$

$$43. \lim_{x \rightarrow -\infty} \frac{x^2-4x+8}{3x^3} = \lim_{x \rightarrow -\infty} \left(\frac{1}{3x} - \frac{4}{3x^2} + \frac{8}{3x^3} \right) = 0 - 0 + 0 = 0$$

$$44. \lim_{x \rightarrow \infty} \frac{1}{x^2-7x+1} = \lim_{x \rightarrow \infty} \frac{\frac{1}{x^2}}{1-\frac{7}{x}+\frac{1}{x^2}} = \frac{0}{1-0+0} = 0$$

$$45. \lim_{x \rightarrow -\infty} \frac{x^2-7x}{x+1} = \lim_{x \rightarrow -\infty} \frac{x-7}{1+\frac{1}{x}} = -\infty$$

$$46. \lim_{x \rightarrow \infty} \frac{x^4+x^3}{12x^3+128} = \lim_{x \rightarrow -\infty} \frac{x+1}{12+\frac{128}{x^3}} = \infty$$

$$47. \lim_{x \rightarrow \infty} \frac{\sin x}{[x]} \leq \lim_{x \rightarrow \infty} \frac{1}{[x]} = 0 \text{ since } [x] \rightarrow \infty \text{ as } x \rightarrow \infty \Rightarrow \lim_{x \rightarrow \infty} \frac{\sin x}{[x]} = 0.$$

$$48. \lim_{\theta \rightarrow \infty} \frac{\cos \theta - 1}{\theta} \leq \lim_{\theta \rightarrow \infty} \frac{2}{\theta} = 0 \Rightarrow \lim_{\theta \rightarrow \infty} \frac{\cos \theta - 1}{\theta} = 0.$$

$$49. \lim_{x \rightarrow \infty} \frac{x + \sin x + 2\sqrt{x}}{x + \sin x} = \lim_{x \rightarrow \infty} \frac{1 + \frac{\sin x}{x} + \frac{2}{\sqrt{x}}}{1 + \frac{\sin x}{x}} = \frac{1+0+0}{1+0} = 1$$

$$50. \lim_{x \rightarrow \infty} \frac{x^{2/3} + x^{-1}}{x^{2/3} + \cos^2 x} = \lim_{x \rightarrow \infty} \left(\frac{1 + x^{-5/3}}{1 + \frac{\cos^2 x}{x^{2/3}}} \right) = \frac{1+0}{1+0} = 1$$

$$51. \lim_{x \rightarrow \infty} e^{1/x} \cos\left(\frac{1}{x}\right) = e^0 \cdot \cos(0) = 1 \cdot 1 = 1$$

$$52. \lim_{x \rightarrow \infty} \ln\left(1 + \frac{1}{t}\right) = \ln 1 = 0$$

$$53. \lim_{x \rightarrow -\infty} \tan^{-1} x = -\frac{\pi}{2}$$

54. $\lim_{t \rightarrow -\infty} e^{3t} \sin^{-1}\left(\frac{1}{t}\right) = 0 \cdot \sin^{-1}(0) = 0 \cdot 0 = 0$

55. (a) $y = \frac{x^2+4}{x-3}$ is undefined at $x = 3$: $\lim_{x \rightarrow 3^-} \frac{x^2+4}{x-3} = -\infty$ and $\lim_{x \rightarrow 3^+} \frac{x^2+4}{x-3} = +\infty$, thus $x = 3$ is a vertical asymptote.

(b) $y = \frac{x^2-x-2}{x^2-2x+1}$ is undefined at $x = 1$: $\lim_{x \rightarrow 1^-} \frac{x^2-x-2}{x^2-2x+1} = -\infty$ and $\lim_{x \rightarrow 1^+} \frac{x^2-x-2}{x^2-2x+1} = -\infty$, thus $x = 1$ is a vertical asymptote.

(c) $y = \frac{x^2+x-6}{x^2+2x-8}$ is undefined at $x = 2$ and -4 : $\lim_{x \rightarrow 2} \frac{x^2+x-6}{x^2+2x-8} = \lim_{x \rightarrow 2} \frac{x+3}{x+4} = \frac{5}{6}$; $\lim_{x \rightarrow -4^-} \frac{x^2+x-6}{x^2+2x-8} = \lim_{x \rightarrow -4^-} \frac{x+3}{x+4} = \infty$
 $\lim_{x \rightarrow -4^+} \frac{x^2+x-6}{x^2+2x-8} = \lim_{x \rightarrow -4^+} \frac{x+3}{x+4} = -\infty$. Thus $x = -4$ is a vertical asymptote.

56. (a) $y = \frac{1-x^2}{x^2+1}$: $\lim_{x \rightarrow \infty} \frac{1-x^2}{x^2+1} = \lim_{x \rightarrow \infty} \frac{\frac{1}{x^2}-1}{1+\frac{1}{x^2}} = \frac{-1}{1} = -1$ and $\lim_{x \rightarrow -\infty} \frac{1-x^2}{x^2+1} = \lim_{x \rightarrow -\infty} \frac{\frac{1}{x^2}-1}{1+\frac{1}{x^2}} = \frac{-1}{1} = -1$, thus $y = -1$ is a horizontal asymptote.

(b) $y = \frac{\sqrt{x+4}}{\sqrt{x+4}}$: $\lim_{x \rightarrow \infty} \frac{\sqrt{x+4}}{\sqrt{x+4}} = \lim_{x \rightarrow \infty} \frac{1+\frac{4}{x}}{\sqrt{1+\frac{4}{x}}} = \frac{1+0}{\sqrt{1+0}} = 1$, thus $y = 1$ is a horizontal asymptote.

(c) $y = \frac{\sqrt{x^2+4}}{x}$: $\lim_{x \rightarrow \infty} \frac{\sqrt{x^2+4}}{x} = \lim_{x \rightarrow \infty} \frac{\sqrt{1+\frac{4}{x^2}}}{1} = \frac{\sqrt{1+0}}{1} = 1$ and $\lim_{x \rightarrow -\infty} \frac{\sqrt{x^2+4}}{x} = \lim_{x \rightarrow -\infty} \frac{\sqrt{1+\frac{4}{x^2}}}{\frac{x}{x^2}}$
 $= \lim_{x \rightarrow -\infty} \frac{\sqrt{1+\frac{4}{x^2}}}{\frac{1}{-x}} = \lim_{x \rightarrow -\infty} \frac{\sqrt{1+\frac{4}{x^2}}}{-1} = \frac{\sqrt{1+0}}{-1} = -1$,

thus $y = 1$ and $y = -1$ are horizontal asymptotes.

(d) $y = \frac{\sqrt{x^2+9}}{\sqrt{9x^2+1}}$: $\lim_{x \rightarrow \infty} \frac{\sqrt{x^2+9}}{\sqrt{9x^2+1}} = \lim_{x \rightarrow \infty} \sqrt{\frac{1+\frac{9}{x^2}}{9+\frac{1}{x^2}}} = \sqrt{\frac{1+0}{9+0}} = \frac{1}{3}$ and $\lim_{x \rightarrow -\infty} \frac{\sqrt{x^2+9}}{\sqrt{9x^2+1}} = \lim_{x \rightarrow -\infty} \sqrt{\frac{1+\frac{9}{x^2}}{9+\frac{1}{x^2}}} = \sqrt{\frac{1+0}{9+0}} = \frac{1}{3}$,
 thus $y = \frac{1}{3}$ is a horizontal asymptote.

CHAPTER 2 ADDITIONAL AND ADVANCED EXERCISES

1. (a)

x	0.1	0.01	0.001	0.0001	0.00001
x^x	0.7943	0.9550	0.9931	0.9991	0.9999

Apparently, $\lim_{x \rightarrow 0^+} x^x = 1$

(b)

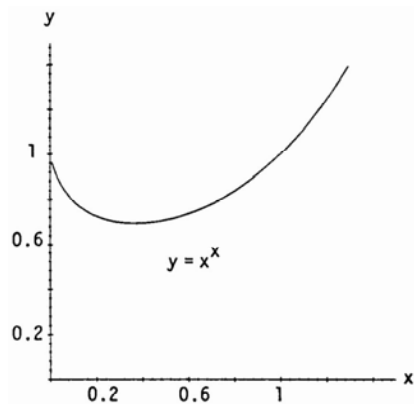

2. (a)

x	10	100	1000
$\left(\frac{1}{x}\right)^{1/(\ln x)}$	0.3679	0.3679	0.3679

 Apparently, $\lim_{x \rightarrow \infty} \left(\frac{1}{x}\right)^{1/(\ln x)} = 0.3678 = \frac{1}{e}$

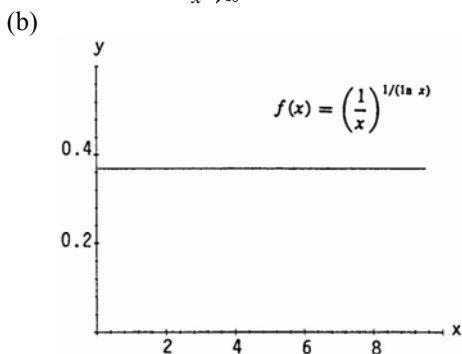

3. $\lim_{v \rightarrow c^-} L = \lim_{v \rightarrow c^-} L_0 \sqrt{1 - \frac{v^2}{c^2}} = L_0 \sqrt{1 - \frac{\lim_{v \rightarrow c^-} v^2}{c^2}} = L_0 \sqrt{1 - \frac{c^2}{c^2}} = 0$

The left-hand limit was needed because the function L is undefined if $v > c$ (the rocket cannot move faster than the speed of light).

4. (a) $\left| \frac{\sqrt{x}}{2} - 1 \right| < 0.2 \Rightarrow -0.2 < \frac{\sqrt{x}}{2} - 1 < 0.2 \Rightarrow 0.8 < \frac{\sqrt{x}}{2} < 1.2 \Rightarrow 1.6 < \sqrt{x} < 2.4 \Rightarrow 2.56 < x < 5.76$.

(b) $\left| \frac{\sqrt{x}}{2} - 1 \right| < 0.1 \Rightarrow -0.1 < \frac{\sqrt{x}}{2} - 1 < 0.1 \Rightarrow 0.9 < \frac{\sqrt{x}}{2} < 1.1 \Rightarrow 1.8 < \sqrt{x} < 2.2 \Rightarrow 3.24 < x < 4.84$.

5. $|10 + (t - 70) \times 10^{-4} - 10| < 0.0005 \Rightarrow |(t - 70) \times 10^{-4}| < 0.0005 \Rightarrow -0.0005 < (t - 70) \times 10^{-4} < 0.0005 \Rightarrow -5 < t - 70 < 5 \Rightarrow 65^\circ < t < 75^\circ \Rightarrow$ Within 5° F.

6. We want to know in what interval to hold values of h to make V satisfy the inequality $|V - 1000| = |36\pi h - 1000| \leq 10$. To find out, we solve the inequality:

$$|36\pi h - 1000| \leq 10 \Rightarrow -10 \leq 36\pi h - 1000 \leq 10 \Rightarrow 990 \leq 36\pi h \leq 1010 \Rightarrow \frac{990}{36\pi} \leq h \leq \frac{1010}{36\pi} \Rightarrow 8.8 \leq h \leq 8.9$$

where 8.8 was rounded up, to be safe, and 8.9 was rounded down, to be safe.

The interval in which we should hold h is about $8.9 - 8.8 = 0.1$ cm wide (1 mm). With stripes 1 mm wide, we can expect to measure a liter of water with an accuracy of 1%, which is more than enough accuracy for cooking.

7. Show $\lim_{x \rightarrow 1} f(x) = \lim_{x \rightarrow 1} (x^2 - 7) = -6 = f(1)$.

Step 1: $|(x^2 - 7) + 6| < \epsilon \Rightarrow -\epsilon < x^2 - 1 < \epsilon \Rightarrow 1 - \epsilon < x^2 < 1 + \epsilon \Rightarrow \sqrt{1 - \epsilon} < x < \sqrt{1 + \epsilon}$.

Step 2: $|x - 1| < \delta \Rightarrow -\delta < x - 1 < \delta \Rightarrow -\delta + 1 < x < \delta + 1$.

Then $-\delta + 1 = \sqrt{1 - \epsilon}$ or $\delta + 1 = \sqrt{1 + \epsilon}$. Choose $\delta = \min\{1 - \sqrt{1 - \epsilon}, \sqrt{1 + \epsilon} - 1\}$, then $0 < |x - 1| < \delta \Rightarrow$

$|(x^2 - 7) - (-6)| < \epsilon$ and $\lim_{x \rightarrow 1} f(x) = -6$. By the continuity text, $f(x)$ is continuous at $x = 1$.

8. Show $\lim_{x \rightarrow \frac{1}{4}} g(x) = \lim_{x \rightarrow \frac{1}{4}} \frac{1}{2x} = 2 = g\left(\frac{1}{4}\right)$.

Step 1: $\left| \frac{1}{2x} - 2 \right| < \epsilon \Rightarrow -\epsilon < \frac{1}{2x} - 2 < \epsilon \Rightarrow 2 - \epsilon < \frac{1}{2x} < 2 + \epsilon \Rightarrow \frac{1}{4 - 2\epsilon} > x > \frac{1}{4 + 2\epsilon}$.

Step 2: $\left|x - \frac{1}{4}\right| < \delta \Rightarrow -\delta < x - \frac{1}{4} < \delta \Rightarrow -\delta + \frac{1}{4} < x < \delta + \frac{1}{4}$.

Then $-\delta + \frac{1}{4} = \frac{1}{4+2\epsilon} \Rightarrow \delta = \frac{1}{4} - \frac{1}{4+2\epsilon} = \frac{\epsilon}{4(2-\epsilon)}$, or $\delta + \frac{1}{4} = \frac{1}{4-2\epsilon} \Rightarrow \delta = \frac{1}{4-2\epsilon} - \frac{1}{4} = \frac{\epsilon}{4(2+\epsilon)}$.

Choose $\delta = \frac{\epsilon}{4(2+\epsilon)}$, the smaller of the two values. Then $0 < \left|x - \frac{1}{4}\right| < \delta \Rightarrow \left|\frac{1}{2x} - 2\right| < \epsilon$ and $\lim_{x \rightarrow \frac{1}{4}} \frac{1}{2x} = 2$.

By the continuity test, $g(x)$ is continuous at $x = \frac{1}{4}$.

9. Show $\lim_{x \rightarrow 2} h(x) = \lim_{x \rightarrow 2} \sqrt{2x-3} = 1 = h(2)$.

Step 1: $\left|\sqrt{2x-3} - 1\right| < \epsilon \Rightarrow -\epsilon < \sqrt{2x-3} - 1 < \epsilon \Rightarrow 1 - \epsilon < \sqrt{2x-3} < 1 + \epsilon \Rightarrow \frac{(1-\epsilon)^2+3}{2} < x < \frac{(1+\epsilon)^2+3}{2}$.

Step 2: $|x - 2| < \delta \Rightarrow -\delta < x - 2 < \delta$ or $-\delta + 2 < x < \delta + 2$.

Then $-\delta + 2 = \frac{(1-\epsilon)^2+3}{2} \Rightarrow \delta = 2 - \frac{(1-\epsilon)^2+3}{2} = \frac{1-(1-\epsilon)^2}{2} = \epsilon - \frac{\epsilon^2}{2}$, or $\delta + 2 = \frac{(1+\epsilon)^2+3}{2} \Rightarrow \delta = \frac{(1+\epsilon)^2+3}{2} - 2 = \frac{(1+\epsilon)^2-1}{2} = \epsilon + \frac{\epsilon^2}{2}$. Choose $\delta = \epsilon - \frac{\epsilon^2}{2}$, the smaller of the two values. Then, $0 < |x - 2| < \delta \Rightarrow \left|\sqrt{2x-3} - 1\right| < \epsilon$,

so $\lim_{x \rightarrow 2} \sqrt{2x-3} = 1$. By the continuity test, $h(x)$ is continuous at $x = 2$.

10. Show $\lim_{x \rightarrow 5} F(x) = \lim_{x \rightarrow 5} \sqrt{9-x} = 2 = F(5)$.

Step 1: $\left|\sqrt{9-x} - 2\right| < \epsilon \Rightarrow -\epsilon < \sqrt{9-x} - 2 < \epsilon \Rightarrow 9 - (2-\epsilon)^2 > x > 9 - (2+\epsilon)^2$.

Step 2: $0 < |x - 5| < \delta \Rightarrow -\delta < x - 5 < \delta \Rightarrow -\delta + 5 < x < \delta + 5$.

Then $-\delta + 5 = 9 - (2+\epsilon)^2 \Rightarrow \delta = (2+\epsilon)^2 - 4 = \epsilon^2 + 2\epsilon$, or $\delta + 5 = 9 - (2-\epsilon)^2 \Rightarrow \delta = 4 - (2-\epsilon)^2 = \epsilon^2 - 2\epsilon$.

Choose $\delta = \epsilon^2 - 2\epsilon$, the smaller of the two values. Then, $0 < |x - 5| < \delta \Rightarrow \left|\sqrt{9-x} - 2\right| < \epsilon$, so $\lim_{x \rightarrow 5} \sqrt{9-x} = 2$.

By the continuity test, $F(x)$ is continuous at $x = 5$.

11. Suppose L_1 and L_2 are two different limits. Without loss of generality assume $L_2 > L_1$. Let $\epsilon = \frac{1}{3}(L_2 - L_1)$. Since

$\lim_{x \rightarrow x_0} f(x) = L_1$ there is a $\delta_1 > 0$ such that $0 < |x - x_0| < \delta_1 \Rightarrow |f(x) - L_1| < \epsilon \Rightarrow -\epsilon < f(x) - L_1 < \epsilon$

$\Rightarrow -\frac{1}{3}(L_2 - L_1) + L_1 < f(x) < \frac{1}{3}(L_2 - L_1) + L_1 \Rightarrow 4L_1 - L_2 < 3f(x) < 2L_1 + L_2$. Likewise, $\lim_{x \rightarrow x_0} f(x) = L_2$ so

there is a δ_2

such that $0 < |x - x_0| < \delta_2 \Rightarrow |f(x) - L_2| < \epsilon \Rightarrow -\epsilon < f(x) - L_2 < \epsilon \Rightarrow -\frac{1}{3}(L_2 - L_1) + L_2 < f(x) < \frac{1}{3}(L_2 - L_1) + L_2$

$\Rightarrow 2L_2 + L_1 < 3f(x) < 4L_2 - L_1 \Rightarrow L_1 - 4L_2 < -3f(x) < -2L_2 - L_1$. If $\delta = \min\{\delta_1, \delta_2\}$ both inequalities must

hold for $0 < |x - x_0| < \delta$: $\left. \begin{array}{l} 4L_1 - L_2 < 3f(x) < 2L_1 + L_2 \\ L_1 - 4L_2 < -3f(x) < -2L_2 - L_1 \end{array} \right\} \Rightarrow 5(L_1 - L_2) < 0 < L_1 - L_2$. That is, $L_1 - L_2 < 0$ and

$L_1 - L_2 > 0$, a contradiction.

12. Suppose $\lim_{x \rightarrow c} f(x) = L$. If $k = 0$, then $\lim_{x \rightarrow c} kf(x) = \lim_{x \rightarrow c} 0 = 0 = 0 \cdot \lim_{x \rightarrow c} f(x)$ and we are done. If $k \neq 0$, then given

any $\epsilon > 0$, there is a $\delta > 0$ so that $0 < |x - c| < \delta \Rightarrow |f(x) - L| < \frac{\epsilon}{|k|} \Rightarrow |k||f(x) - L| < \epsilon \Rightarrow |k(f(x) - L)| < \epsilon$

$\Rightarrow |(kf(x)) - (kL)| < \epsilon$. Thus $\lim_{x \rightarrow c} kf(x) = kL = k \left(\lim_{x \rightarrow c} f(x) \right)$.

13. (a) Since $x \rightarrow 0^+$, $0 < x^3 < x < 1 \Rightarrow (x^3 - x) \rightarrow 0^- \Rightarrow \lim_{x \rightarrow 0^+} f(x^3 - x) = \lim_{y \rightarrow 0^-} f(y) = B$ where $y = x^3 - x$.

(b) Since $x \rightarrow 0^-$, $-1 < x < x^3 < 0 \Rightarrow (x^3 - x) \rightarrow 0^+ \Rightarrow \lim_{x \rightarrow 0^-} f(x^3 - x) = \lim_{y \rightarrow 0^+} f(y) = A$ where $y = x^3 - x$.

(c) Since $x \rightarrow 0^+$, $0 < x^4 < x^2 < 1 \Rightarrow (x^2 - x^4) \rightarrow 0^+ \Rightarrow \lim_{x \rightarrow 0^+} f(x^2 - x^4) = \lim_{y \rightarrow 0^+} f(y) = A$ where $y = x^2 - x^4$.

(d) Since $x \rightarrow 0^-$, $-1 < x < 0 \Rightarrow 0 < x^4 < x^2 < 1 \Rightarrow (x^2 - x^4) \rightarrow 0^+ \Rightarrow \lim_{x \rightarrow 0^-} f(x^2 - x^4) = A$ as in part (c).

14. (a) True, because if $\lim_{x \rightarrow a} (f(x) + g(x))$ exists then $\lim_{x \rightarrow a} (f(x) + g(x)) - \lim_{x \rightarrow a} f(x) = \lim_{x \rightarrow a} [(f(x) + g(x)) - f(x)] = \lim_{x \rightarrow a} g(x)$ exists, contrary to assumption.
- (b) False; for example take $f(x) = \frac{1}{x}$ and $g(x) = -\frac{1}{x}$. Then neither $\lim_{x \rightarrow 0} f(x)$ nor $\lim_{x \rightarrow 0} g(x)$ exists, but $\lim_{x \rightarrow 0} (f(x) + g(x)) = \lim_{x \rightarrow 0} \left(\frac{1}{x} - \frac{1}{x}\right) = \lim_{x \rightarrow 0} 0 = 0$ exists.
- (c) True, because $g(x) = |x|$ is continuous $\Rightarrow g(f(x)) = |f(x)|$ is continuous (it is the composite of continuous functions).
- (d) False; for example let $f(x) = \begin{cases} -1, & x \leq 0 \\ 1, & x > 0 \end{cases} \Rightarrow f(x)$ is discontinuous at $x = 0$. However $|f(x)| = 1$ is continuous at $x = 0$.

15. Show $\lim_{x \rightarrow -1} f(x) = \lim_{x \rightarrow -1} \frac{x^2 - 1}{x + 1} = \lim_{x \rightarrow -1} \frac{(x + 1)(x - 1)}{(x + 1)} = -2, x \neq -1$.

Define the continuous extension of $f(x)$ as $F(x) = \begin{cases} \frac{x^2 - 1}{x + 1}, & x \neq -1 \\ -2, & x = -1 \end{cases}$. We now prove the limit of $f(x)$ as $x \rightarrow -1$

exists and has the correct value.

Step 1: $\left| \frac{x^2 - 1}{x + 1} - (-2) \right| < \epsilon \Rightarrow -\epsilon < \frac{(x + 1)(x - 1)}{(x + 1)} + 2 < \epsilon \Rightarrow -\epsilon < (x - 1) + 2 < \epsilon, x \neq -1 \Rightarrow -\epsilon - 1 < x < \epsilon - 1$.

Step 2: $|x - (-1)| < \delta \Rightarrow -\delta < x + 1 < \delta \Rightarrow -\delta - 1 < x < \delta - 1$.

Then $-\delta - 1 = -\epsilon - 1 \Rightarrow \delta = \epsilon$, or $\delta - 1 = \epsilon - 1 \Rightarrow \delta = \epsilon$. Choose $\delta = \epsilon$. Then $0 < |x - (-1)| < \delta$

$\Rightarrow \left| \frac{x^2 - 1}{x + 1} - (-2) \right| < \epsilon \Rightarrow \lim_{x \rightarrow -1} F(x) = -2$. Since the conditions of the continuity test are met by $F(x)$, then $f(x)$ has a continuous extension to $F(x)$ at $x = -1$.

16. Show $\lim_{x \rightarrow 3} g(x) = \lim_{x \rightarrow 3} \frac{x^2 - 2x - 3}{2x - 6} = \lim_{x \rightarrow 3} \frac{(x - 3)(x + 1)}{2(x - 3)} = 2, x \neq 3$.

Define the continuous extension of $g(x)$ as $G(x) = \begin{cases} \frac{x^2 - 2x - 3}{2x - 6}, & x \neq 3 \\ 2, & x = 3 \end{cases}$. We now prove the limit of $g(x)$ as $x \rightarrow 3$

exists and has the correct value.

Step 1: $\left| \frac{x^2 - 2x - 3}{2x - 6} - 2 \right| < \epsilon \Rightarrow -\epsilon < \frac{(x - 3)(x + 1)}{2(x - 3)} - 2 < \epsilon \Rightarrow -\epsilon < \frac{x + 1}{2} - 2 < \epsilon, x \neq 3 \Rightarrow 3 - 2\epsilon < x < 3 + 2\epsilon$.

Step 2: $|x - 3| < \delta \Rightarrow -\delta < x - 3 < \delta \Rightarrow 3 - \delta < x < \delta + 3$.

Then, $3 - \delta = 3 - 2\epsilon \Rightarrow \delta = 2\epsilon$, or $\delta + 3 = 3 + 2\epsilon \Rightarrow \delta = 2\epsilon$. Choose $\delta = 2\epsilon$. Then $0 < |x - 3| < \delta$

$\Rightarrow \left| \frac{x^2 - 2x - 3}{2x - 6} - 2 \right| < \epsilon \Rightarrow \lim_{x \rightarrow 3} \frac{(x - 3)(x + 1)}{2(x - 3)} = 2$. Since the conditions of the continuity test hold for $G(x)$, $g(x)$ can be continuously extended to $G(x)$ at $x = 3$.

17. (a) Let $\epsilon > 0$ be given. If x is rational, then $f(x) = x \Rightarrow |f(x) - 0| = |x - 0| < \epsilon \Leftrightarrow |x - 0| < \epsilon$; i.e., choose $\delta = \epsilon$. Then $|x - 0| < \delta \Rightarrow |f(x) - 0| < \epsilon$ for x rational. If x is irrational, then $f(x) = 0 \Rightarrow |f(x) - 0| < \epsilon \Leftrightarrow 0 < \epsilon$ which is true no matter how close irrational x is to 0, so again we can choose $\delta = \epsilon$. In either case, given $\epsilon > 0$ there is a $\delta = \epsilon > 0$ such that $0 < |x - 0| < \delta \Rightarrow |f(x) - 0| < \epsilon$. Therefore, f is continuous at $x = 0$.
- (b) Choose $x = c > 0$. Then within any interval $(c - \delta, c + \delta)$ there are both rational and irrational numbers. If c is rational, pick $\epsilon = \frac{c}{2}$. No matter how small we choose $\delta > 0$ there is an irrational number x in $(c - \delta, c + \delta) \Rightarrow |f(x) - f(c)| = |0 - c| = c > \frac{c}{2} = \epsilon$. That is, f is not continuous at any rational $c > 0$. On the other hand, suppose c is irrational $\Rightarrow f(c) = 0$. Again pick $\epsilon = \frac{c}{2}$. No matter how small we choose $\delta > 0$ there is a rational number x in $(c - \delta, c + \delta)$ with $|x - c| < \frac{c}{2} = \epsilon \Leftrightarrow \frac{c}{2} < x < \frac{3c}{2}$. Then $|f(x) - f(c)| = |x - 0| = |x| > \frac{c}{2} = \epsilon \Rightarrow f$ is not continuous at any irrational $c > 0$.
- If $x = c < 0$, repeat the argument picking $\epsilon = \frac{|c|}{2} = \frac{-c}{2}$. Therefore f fails to be continuous at any nonzero value $x = c$.

18. (a) Let $c = \frac{m}{n}$ be a rational number in $[0, 1]$ reduced to lowest terms $\Rightarrow f(c) = \frac{1}{n}$. Pick $\epsilon = \frac{1}{2n}$. No matter how small $\delta > 0$ is taken, there is an irrational number x in the interval $(c - \delta, c + \delta) \Rightarrow |f(x) - f(c)| = \left|0 - \frac{1}{n}\right| = \frac{1}{n} > \frac{1}{2n} = \epsilon$. Therefore f is discontinuous at $x = c$, a rational number.
- (b) Now suppose c is an irrational number $\Rightarrow f(c) = 0$. Let $\epsilon > 0$ be given. Notice that $\frac{1}{2}$ is the only rational number reduced to lowest terms with denominator 2 and belonging to $[0, 1]$; $\frac{1}{3}$ and $\frac{2}{3}$ the only rationals with denominator 3 belonging to $[0, 1]$; $\frac{1}{4}$ and $\frac{3}{4}$ with denominator 4 in $[0, 1]$; $\frac{1}{5}, \frac{2}{5}, \frac{3}{5}$ and $\frac{4}{5}$ with denominator 5 in $[0, 1]$; etc. In general, choose N so that $\frac{1}{N} < \epsilon \Rightarrow$ there exist only finitely many rationals in $[0, 1]$ having

denominator $\leq N$, say r_1, r_2, \dots, r_p . Let $\delta = \min \{|c - r_i| : i = 1, \dots, p\}$. Then the interval $(c - \delta, c + \delta)$ contains no rational numbers with denominator $\leq N$. Thus, $0 < |x - c| < \delta \Rightarrow |f(x) - f(c)| = |f(x) - 0| = |f(x)| \leq \frac{1}{N} < \epsilon \Rightarrow f$ is continuous at $x = c$ irrational.

- (c) The graph looks like the markings on a typical ruler when the points $(x, f(x))$ on the graph of $f(x)$ are connected to the x -axis with vertical lines.

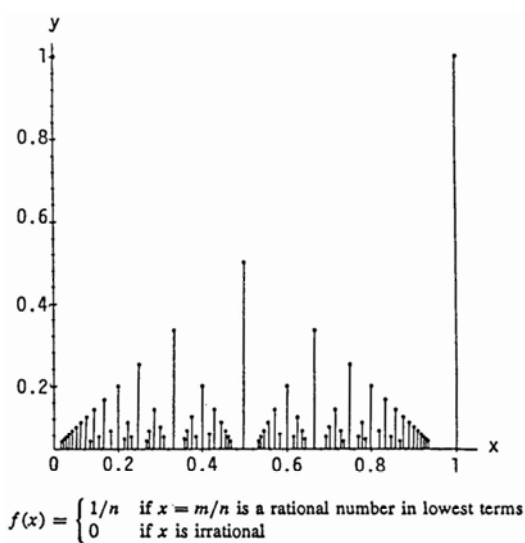

19. Yes. Let R be the radius of the equator (earth) and suppose at a fixed instant of time we label noon as the zero point, 0, on the equator $\Rightarrow 0 + \pi R$ represents the midnight point (at the same exact time). Suppose x_1 is a point on the equator “just after” noon $\Rightarrow x_1 + \pi R$ is simultaneously “just after” midnight. It seems reasonable that the temperature T at a point just after noon is hotter than it would be at the diametrically opposite point just after midnight: That is, $T(x_1) - T(x_1 + \pi R) > 0$. At exactly the same moment in time pick x_2 to be a point just before midnight $\Rightarrow x_2 + \pi R$ is just before noon. Then $T(x_2) - T(x_2 + \pi R) < 0$. Assuming the temperature function T is continuous along the equator (which is reasonable), the Intermediate Value Theorem says there is a point c between 0 (noon) and πR (simultaneously midnight) such that $T(c) - T(c + \pi R) = 0$; i.e., there is always a pair of antipodal points on the earth’s equator where the temperatures are the same.

20.
$$\lim_{x \rightarrow c} f(x)g(x) = \lim_{x \rightarrow c} \frac{1}{4} \left[(f(x) + g(x))^2 - (f(x) - g(x))^2 \right] = \frac{1}{4} \left[\left(\lim_{x \rightarrow c} (f(x) + g(x)) \right)^2 - \left(\lim_{x \rightarrow c} (f(x) - g(x)) \right)^2 \right]$$

$$= \frac{1}{4} (3^2 - (-1)^2) = 2.$$

21. (a) At $x = 0$: $\lim_{a \rightarrow 0} r_+(a) = \lim_{a \rightarrow 0} \frac{-1 + \sqrt{1+a}}{a} = \lim_{a \rightarrow 0} \left(\frac{-1 + \sqrt{1+a}}{a} \right) \left(\frac{-1 - \sqrt{1+a}}{-1 - \sqrt{1+a}} \right) = \lim_{a \rightarrow 0} \frac{1 - (1+a)}{a(-1 - \sqrt{1+a})} = \frac{-1}{-1 - \sqrt{1+0}} = \frac{1}{2}$
 At $x = -1$: $\lim_{a \rightarrow -1^+} r_+(a) = \lim_{a \rightarrow -1^+} \frac{1 - (1+a)}{a(-1 - \sqrt{1+a})} = \lim_{a \rightarrow -1} \frac{-a}{a(-1 - \sqrt{1+a})} = \frac{-1}{-1 - \sqrt{0}} = 1$

(b) At $x = 0$: $\lim_{a \rightarrow 0^-} r_-(a) = \lim_{a \rightarrow 0^-} \frac{-1 - \sqrt{1+a}}{a} = \lim_{a \rightarrow 0^-} \left(\frac{-1 - \sqrt{1+a}}{a} \right) \left(\frac{-1 + \sqrt{1+a}}{-1 + \sqrt{1+a}} \right) = \lim_{a \rightarrow 0^-} \frac{1 - (1+a)}{a(-1 + \sqrt{1+a})} = \lim_{a \rightarrow 0^-} \frac{-a}{a(-1 + \sqrt{1+a})}$
 $= \lim_{a \rightarrow 0^-} \frac{-1}{-1 + \sqrt{1+a}} = \infty$ (because the denominator is always negative); $\lim_{a \rightarrow 0^+} r_-(a)$
 $= \lim_{a \rightarrow 0^+} \frac{-1}{-1 + \sqrt{1+a}} = -\infty$ (because the denominator is always positive).

Therefore, $\lim_{a \rightarrow 0} r_-(a)$ does not exist.

At $x = -1$: $\lim_{a \rightarrow -1^+} r_-(a) = \lim_{a \rightarrow -1^+} \frac{-1 - \sqrt{1+a}}{a} = \lim_{a \rightarrow -1^+} \frac{-1}{-1 + \sqrt{1+a}} = 1$

(c)

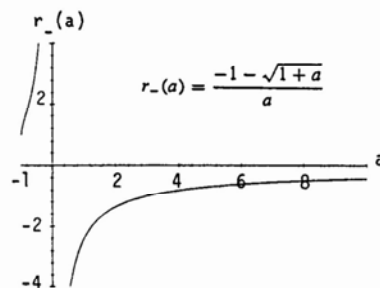
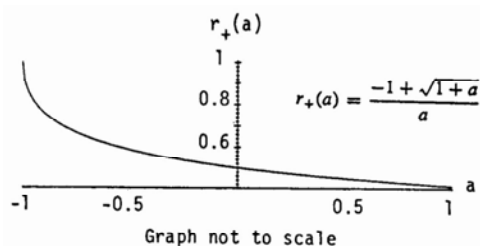

(d)

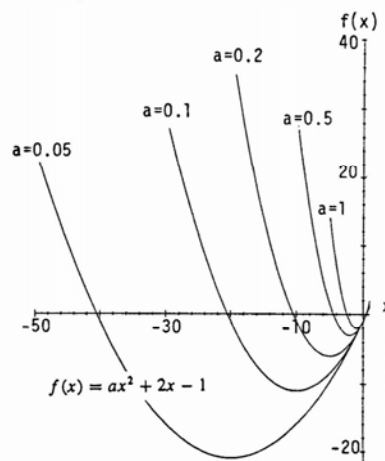
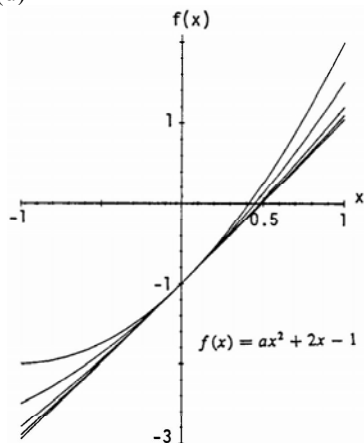

22. $f(x) = x + 2 \cos x \Rightarrow f(0) = 0 + 2 \cos 0 = 2 > 0$ and $f(-\pi) = -\pi + 2 \cos(-\pi) = -\pi - 2 < 0$. Since $f(x)$ is continuous on $[-\pi, 0]$, by the Intermediate Value Theorem, $f(x)$ must take on every value between $[-\pi - 2, 2]$. Thus there is some number c in $[-\pi, 0]$ such that $f(c) = 0$; i.e., c is a solution to $x + 2 \cos x = 0$.

23. (a) The function f is bounded on D if $f(x) \geq M$ and $f(x) \leq N$ for all x in D . This means $M \leq f(x) \leq N$ for all x in D . Choose B to be $\max\{|M|, |N|\}$. Then $|f(x)| \leq B$. On the other hand, if $|f(x)| \leq B$, then $-B \leq f(x) \leq B \Rightarrow f(x) \geq -B$ and $f(x) \leq B \Rightarrow f(x)$ is bounded on D with $N = B$ an upper bound and $M = -B$ a lower bound.

(b) Assume $f(x) \leq N$ for all x and that $L > N$. Let $\epsilon = \frac{L-N}{2}$. Since $\lim_{x \rightarrow x_0} f(x) = L$ there is a $\delta > 0$ such that $0 < |x - x_0| < \delta \Rightarrow |f(x) - L| < \epsilon \Leftrightarrow L - \epsilon < f(x) < L + \epsilon \Leftrightarrow L - \frac{L-N}{2} < f(x) < L + \frac{L-N}{2} \Leftrightarrow \frac{L+N}{2} < f(x) < \frac{3L-N}{2}$. But $L > N \Rightarrow \frac{L+N}{2} > N \Rightarrow N < f(x)$ contrary to the boundedness assumption $f(x) \leq N$. This contradiction proves $L \leq N$.

(c) Assume $M \leq f(x)$ for all x and that $L < M$. Let $\epsilon = \frac{M-L}{2}$. As in part (b), $0 < |x - x_0| < \delta \Rightarrow L - \frac{M-L}{2} < f(x) < L + \frac{M-L}{2} \Leftrightarrow \frac{3L-M}{2} < f(x) < \frac{M+L}{2} < M$, a contradiction.

24. (a) If $a \geq b$, then $a - b \geq 0 \Rightarrow |a - b| = a - b \Rightarrow \max \{a, b\} = \frac{a+b}{2} + \frac{|a-b|}{2} = \frac{a+b}{2} + \frac{a-b}{2} = \frac{2a}{2} = a$.
 If $a \leq b$, then $a - b \leq 0 \Rightarrow |a - b| = -(a - b) = b - a \Rightarrow \max \{a, b\} = \frac{a+b}{2} + \frac{|a-b|}{2} = \frac{a+b}{2} + \frac{b-a}{2} = \frac{2b}{2} = b$.
- (b) Let $\min \{a, b\} = \frac{a+b}{2} - \frac{|a-b|}{2}$.

$$25. \lim_{x \rightarrow 0} \frac{\sin(1 - \cos x)}{x} = \lim_{x \rightarrow 0} \frac{\sin(1 - \cos x)}{1 - \cos x} \cdot \frac{1 - \cos x}{x} \cdot \frac{1 + \cos x}{1 + \cos x} = \lim_{x \rightarrow 0} \frac{\sin(1 - \cos x)}{1 - \cos x} \cdot \lim_{x \rightarrow 0} \frac{1 - \cos^2 x}{x(1 + \cos x)}$$

$$= 1 \cdot \lim_{x \rightarrow 0} \frac{\sin^2 x}{x(1 + \cos x)} = \lim_{x \rightarrow 0} \frac{\sin x}{x} \cdot \frac{\sin x}{1 + \cos x} = 1 \cdot \left(\frac{0}{2}\right) = 0.$$

$$26. \lim_{x \rightarrow 0^+} \frac{\sin x}{\sin \sqrt{x}} = \lim_{x \rightarrow 0^+} \frac{\sin x}{x} \cdot \frac{\sqrt{x}}{\sin \sqrt{x}} \cdot \frac{x}{\sqrt{x}} = 1 \cdot \lim_{x \rightarrow 0^+} \frac{1}{\left(\frac{\sin \sqrt{x}}{\sqrt{x}}\right)} \cdot \lim_{x \rightarrow 0^+} \sqrt{x} = 1 \cdot 1 \cdot 0 = 0.$$

$$27. \lim_{x \rightarrow 0} \frac{\sin(\sin x)}{x} = \lim_{x \rightarrow 0} \frac{\sin(\sin x)}{\sin x} \cdot \frac{\sin x}{x} = \lim_{x \rightarrow 0} \frac{\sin(\sin x)}{\sin x} \cdot \lim_{x \rightarrow 0} \frac{\sin x}{x} = 1 \cdot 1 = 1.$$

$$28. \lim_{x \rightarrow 0} \frac{\sin(x^2 + x)}{x} = \lim_{x \rightarrow 0} \frac{\sin(x^2 + x)}{x^2 + x} \cdot (x + 1) = \lim_{x \rightarrow 0} \frac{\sin(x^2 + x)}{x^2 + x} \cdot \lim_{x \rightarrow 0} (x + 1) = 1 \cdot 1 = 1.$$

$$29. \lim_{x \rightarrow 2} \frac{\sin(x^2 - 4)}{x - 2} = \lim_{x \rightarrow 2} \frac{\sin(x^2 - 4)}{x^2 - 4} \cdot (x + 2) = \lim_{x \rightarrow 2} \frac{\sin(x^2 - 4)}{x^2 - 4} \cdot \lim_{x \rightarrow 2} (x + 2) = 1 \cdot 4 = 4.$$

$$30. \lim_{x \rightarrow 9} \frac{\sin(\sqrt{x} - 3)}{x - 9} = \lim_{x \rightarrow 9} \frac{\sin(\sqrt{x} - 3)}{\sqrt{x} - 3} \cdot \frac{1}{\sqrt{x} + 3} = \lim_{x \rightarrow 9} \frac{\sin(\sqrt{x} - 3)}{\sqrt{x} - 3} \cdot \lim_{x \rightarrow 9} \frac{1}{\sqrt{x} + 3} = 1 \cdot \frac{1}{6} = \frac{1}{6}.$$

31. Since the highest power of x in the numerator is 1 more than the highest power of x in the denominator, there is an oblique asymptote. $y = \frac{2x^{3/2} + 2x - 3}{\sqrt{x} + 1} = 2x - \frac{3}{\sqrt{x} + 1}$, thus the oblique asymptote is $y = 2x$.

32. As $x \rightarrow \pm\infty$, $\frac{1}{x} \rightarrow 0 \Rightarrow \sin\left(\frac{1}{x}\right) \rightarrow 0 \Rightarrow 1 + \sin\left(\frac{1}{x}\right) \rightarrow 1$, thus as $x \rightarrow \pm\infty$, $y = x + x \sin\left(\frac{1}{x}\right) = x\left(1 + \sin\left(\frac{1}{x}\right)\right) \rightarrow x$; thus the oblique asymptote is $y = x$.

33. As $x \rightarrow \pm\infty$, $x^2 + 1 \rightarrow x^2 \Rightarrow \sqrt{x^2 + 1} \rightarrow \sqrt{x^2}$; as $x \rightarrow -\infty$, $\sqrt{x^2} = -x$, and as $x \rightarrow +\infty$, $\sqrt{x^2} = x$; thus the oblique asymptotes are $y = x$ and $y = -x$.

34. As $x \rightarrow \pm\infty$, $x + 2 \rightarrow x \Rightarrow \sqrt{x^2 + 2x} = \sqrt{x(x + 2)} \rightarrow \sqrt{x^2}$; as $x \rightarrow -\infty$, $\sqrt{x^2} = -x$, and as $x \rightarrow +\infty$, $\sqrt{x^2} = x$; asymptotes are $y = x$ and $y = -x$.

CHAPTER 3 DERIVATIVES

3.1 TANGENTS AND THE DERIVATIVE AT A POINT

1. $P_1: m_1 = 1, P_2: m_2 = 5$

2. $P_1: m_1 = -2, P_2: m_2 = 0$

3. $P_1: m_1 = \frac{5}{2}, P_2: m_2 = -\frac{1}{2}$

4. $P_1: m_1 = 3, P_2: m_2 = -3$

5.
$$m = \lim_{h \rightarrow 0} \frac{[4 - (-1+h)^2] - [4 - (-1)^2]}{h} = \lim_{h \rightarrow 0} \frac{-(1-2h+h^2)+1}{h}$$

$$= \lim_{h \rightarrow 0} \frac{h(2-h)}{h} = 2; \text{ at } (-1, 3): y = 3 + 2(x - (-1))$$

$$\Rightarrow y = 2x + 5, \text{ tangent line}$$

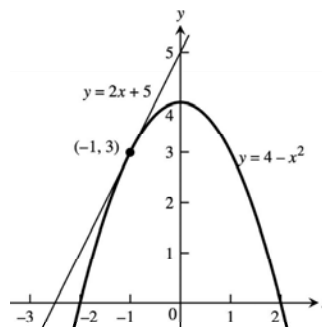

6.
$$m = \lim_{h \rightarrow 0} \frac{[(1+h-1)^2 + 1] - [(1-1)^2 + 1]}{h} = \lim_{h \rightarrow 0} \frac{h^2}{h} = \lim_{h \rightarrow 0} h = 0;$$
 at $(1, 1): y = 1 + 0(x - 1) \Rightarrow y = 1, \text{ tangent line}$

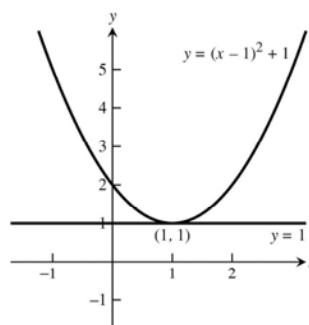

7.
$$m = \lim_{h \rightarrow 0} \frac{2\sqrt{1+h} - 2\sqrt{1}}{h} = \lim_{h \rightarrow 0} \frac{2\sqrt{1+h} - 2}{h} \cdot \frac{2\sqrt{1+h} + 2}{2\sqrt{1+h} + 2}$$

$$= \lim_{h \rightarrow 0} \frac{4(1+h) - 4}{2h(\sqrt{1+h} + 1)} = \lim_{h \rightarrow 0} \frac{2}{\sqrt{1+h} + 1} = 1;$$
 at $(1, 2): y = 2 + 1(x - 1) \Rightarrow y = x + 1, \text{ tangent line}$

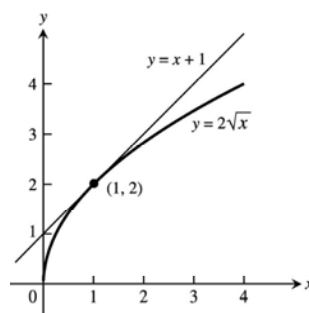

8.
$$m = \lim_{h \rightarrow 0} \frac{\frac{1}{(-1+h)^2} - \frac{1}{(-1)^2}}{h} = \lim_{h \rightarrow 0} \frac{1 - (-1+h)^2}{h(-1+h)^2}$$

$$= \lim_{h \rightarrow 0} \frac{-(-2h+h^2)}{h(-1+h)^2} = \lim_{h \rightarrow 0} \frac{2-h}{(-1+h)^2} = 2; \text{ at } (-1, 1):$$

$$y = 1 + 2(x - (-1)) \Rightarrow y = 2x + 3, \text{ tangent line}$$

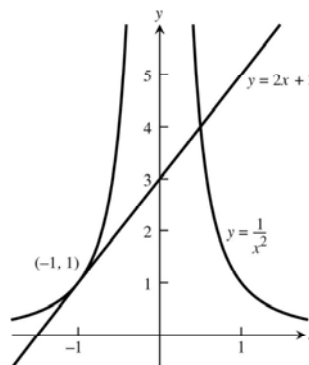

$$9. m = \lim_{h \rightarrow 0} \frac{(-2+h)^3 - (-2)^3}{h} = \lim_{h \rightarrow 0} \frac{-8+12h-6h^2+h^3+8}{h}$$

$$= \lim_{h \rightarrow 0} (12 - 6h + h^2) = 12;$$

at $(-2, -8)$: $y = -8 + 12(x - (-2)) \Rightarrow y = 12x + 16$,
tangent line

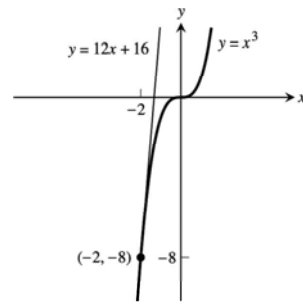

$$10. m = \lim_{h \rightarrow 0} \frac{\frac{1}{(-2+h)^3} - \frac{1}{(-2)^3}}{h} = \lim_{h \rightarrow 0} \frac{-8 - (-2+h)^3}{-8h(-2+h)^3}$$

$$= \lim_{h \rightarrow 0} \frac{-(12h-6h^2+h^3)}{-8h(-2+h)^3} = \lim_{h \rightarrow 0} \frac{12-6h+h^2}{8(-2+h)^3}$$

$$= \frac{12}{8(-8)} = -\frac{3}{16};$$

at $(-2, -1/8)$: $y = -\frac{1}{8} - \frac{3}{16}(x - (-2))$
 $\Rightarrow y = -\frac{3}{16}x - \frac{1}{2}$, tangent line

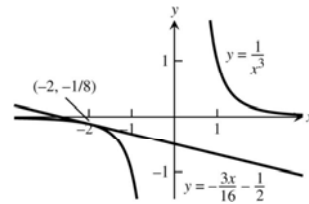

$$11. m = \lim_{h \rightarrow 0} \frac{[(2+h)^2 + 1] - 5}{h} = \lim_{h \rightarrow 0} \frac{(5+4h+h^2) - 5}{h} = \lim_{h \rightarrow 0} \frac{h(4+h)}{h} = 4;$$

at $(2, 5)$: $y - 5 = 4(x - 2)$, tangent line

$$12. m = \lim_{h \rightarrow 0} \frac{[(1+h) - 2(1+h)^2] - (-1)}{h} = \lim_{h \rightarrow 0} \frac{(1+h-2-4h-2h^2)+1}{h} = \lim_{h \rightarrow 0} \frac{h(-3-2h)}{h} = -3;$$

at $(1, -1)$: $y + 1 = -3(x - 1)$, tangent line

$$13. m = \lim_{h \rightarrow 0} \frac{\frac{3+h}{(3+h)-2} - 3}{h} = \lim_{h \rightarrow 0} \frac{(3+h) - 3(h+1)}{h(h+1)} = \lim_{h \rightarrow 0} \frac{-2h}{h(h+1)} = -2;$$

at $(3, 3)$: $y - 3 = -2(x - 3)$, tangent line

$$14. m = \lim_{h \rightarrow 0} \frac{\frac{8}{(2+h)^2} - 2}{h} = \lim_{h \rightarrow 0} \frac{8 - 2(2+h)^2}{h(2+h)^2} = \lim_{h \rightarrow 0} \frac{8 - 2(4+4h+h^2)}{h(2+h)^2} = \lim_{h \rightarrow 0} \frac{-2h(4+h)}{h(2+h)^2} = \frac{-8}{4} = -2;$$

at $(2, 2)$: $y - 2 = -2(x - 2)$

$$15. m = \lim_{h \rightarrow 0} \frac{(2+h)^3 - 8}{h} = \lim_{h \rightarrow 0} \frac{(8+12h+6h^2+h^3) - 8}{h} = \lim_{h \rightarrow 0} \frac{h(12+6h+h^2)}{h} = 12;$$

at $(2, 8)$: $y - 8 = 12(t - 2)$, tangent line

$$16. m = \lim_{h \rightarrow 0} \frac{[(1+h)^3 + 3(1+h)] - 4}{h} = \lim_{h \rightarrow 0} \frac{(1+3h+3h^2+h^3+3+3h) - 4}{h} = \lim_{h \rightarrow 0} \frac{h(6+3h+h^2)}{h} = 6;$$

at $(1, 4)$: $y - 4 = 6(t - 1)$, tangent line

$$17. m = \lim_{h \rightarrow 0} \frac{\sqrt{4+h} - 2}{h} = \lim_{h \rightarrow 0} \frac{\sqrt{4+h} - 2}{h} \cdot \frac{\sqrt{4+h} + 2}{\sqrt{4+h} + 2} = \lim_{h \rightarrow 0} \frac{(4+h) - 4}{h(\sqrt{4+h} + 2)} = \lim_{h \rightarrow 0} \frac{h}{h(\sqrt{4+h} + 2)} = \frac{1}{\sqrt{4+2}} = \frac{1}{4};$$

at $(4, 2)$: $y - 2 = \frac{1}{4}(x - 4)$, tangent line

$$18. m = \lim_{h \rightarrow 0} \frac{\sqrt{(8+h)+1} - 3}{h} = \lim_{h \rightarrow 0} \frac{\sqrt{9+h} - 3}{h} \cdot \frac{\sqrt{9+h} + 3}{\sqrt{9+h} + 3} = \lim_{h \rightarrow 0} \frac{(9+h) - 9}{h(\sqrt{9+h} + 3)} = \lim_{h \rightarrow 0} \frac{h}{h(\sqrt{9+h} + 3)} = \frac{1}{\sqrt{9+3}} = \frac{1}{6};$$

at $(8, 3)$: $y - 3 = \frac{1}{6}(x - 8)$, tangent line

$$19. \text{At } x = -1, y = 5 \Rightarrow m = \lim_{h \rightarrow 0} \frac{5(-1+h)^2 - 5}{h} = \lim_{h \rightarrow 0} \frac{5(1-2h+h^2) - 5}{h} = \lim_{h \rightarrow 0} \frac{5h(-2+h)}{h} = -10, \text{ slope}$$

20. At $x = 2, y = -3 \Rightarrow m = \lim_{h \rightarrow 0} \frac{[1-(2+h)^2]-(-3)}{h} = \lim_{h \rightarrow 0} \frac{(1-4-4h-h^2)+3}{h} = \lim_{h \rightarrow 0} \frac{-h(4+h)}{h} = -4$, slope
21. At $x = 3, y = \frac{1}{2} \Rightarrow m = \lim_{h \rightarrow 0} \frac{\frac{1}{(3+h)-1} - \frac{1}{2}}{h} = \lim_{h \rightarrow 0} \frac{2-(2+h)}{2h(2+h)} = \lim_{h \rightarrow 0} \frac{-h}{2h(2+h)} = -\frac{1}{4}$, slope
22. At $x = 0, y = -1 \Rightarrow m = \lim_{h \rightarrow 0} \frac{\frac{h-1}{h+1} - (-1)}{h} = \lim_{h \rightarrow 0} \frac{(h-1)+(h+1)}{h(h+1)} = \lim_{h \rightarrow 0} \frac{2h}{h(h+1)} = 2$
23. (a) It is the rate of change of the number of cells when $t = 5$. The units are the number of cells per hour.
 (b) $P'(3)$ because the slope of the curve is greater there.
 (c) $P'(5) = \lim_{h \rightarrow 0} \frac{6.10(5+h)^2 - 9.28(5+h) + 16.43 - [6.10(5)^2 - 9.28(5) + 16.43]}{h} = \lim_{h \rightarrow 0} \frac{61.0h + 6.10h^2 - 9.28h}{h} = \lim_{h \rightarrow 0} 51.72 + 6.10h = 51.72 \approx 52$ cells/hr.
24. (a) From $t = 0$ to $t = 3$, the derivative is positive.
 (b) At $t = 3$, the derivative appears to be 0. From $t = 2$ to $t = 3$, the derivative is positive but decreasing.
25. At a horizontal tangent the slope $m = 0 \Rightarrow 0 = m = \lim_{h \rightarrow 0} \frac{[(x+h)^2 + 4(x+h) - 1] - (x^2 + 4x - 1)}{h}$
 $= \lim_{h \rightarrow 0} \frac{(x^2 + 2xh + h^2 + 4x + 4h - 1) - (x^2 + 4x - 1)}{h} = \lim_{h \rightarrow 0} \frac{(2xh + h^2 + 4h)}{h} = \lim_{h \rightarrow 0} (2x + h + 4) = 2x + 4; 2x + 4 = 0$
 $\Rightarrow x = -2$. Then $f(-2) = 4 - 8 - 1 = -5 \Rightarrow (-2, -5)$ is the point on the graph where there is a horizontal tangent.
26. $0 = m = \lim_{h \rightarrow 0} \frac{[(x+h)^3 - 3(x+h)] - (x^3 - 3x)}{h} = \lim_{h \rightarrow 0} \frac{(x^3 + 3x^2h + 3xh^2 + h^3 - 3x - 3h) - (x^3 - 3x)}{h} = \lim_{h \rightarrow 0} \frac{3x^2h + 3xh^2 + h^3 - 3h}{h} =$
 $\lim_{h \rightarrow 0} (3x^2 + 3xh + h^2 - 3) = 3x^2 - 3; 3x^2 - 3 = 0 \Rightarrow x = -1$ or $x = 1$. Then $f(-1) = 2$ and $f(1) = -2 \Rightarrow (-1, 2)$ and $(1, -2)$ are the points on the graph where a horizontal tangent exists.
27. $-1 = m = \lim_{h \rightarrow 0} \frac{\frac{1}{(x+h)-1} - \frac{1}{x-1}}{h} = \lim_{h \rightarrow 0} \frac{(x-1) - (x+h-1)}{h(x-1)(x+h-1)} = \lim_{h \rightarrow 0} \frac{-h}{h(x-1)(x+h-1)} = -\frac{1}{(x-1)^2} \Rightarrow (x-1)^2 = 1 \Rightarrow x^2 - 2x = 0$
 $\Rightarrow x(x-2) = 0 \Rightarrow x = 0$ or $x = 2$. If $x = 0$, then $y = -1$ and $m = -1 \Rightarrow y = -1 - (x-0) = -(x+1)$. If $x = 2$, then $y = 1$ and $m = -1 \Rightarrow y = 1 - (x-2) = -(x-3)$.
28. $\frac{1}{4} = m = \lim_{h \rightarrow 0} \frac{\sqrt{x+h} - \sqrt{x}}{h} = \lim_{h \rightarrow 0} \frac{\sqrt{x+h} - \sqrt{x}}{h} \cdot \frac{\sqrt{x+h} + \sqrt{x}}{\sqrt{x+h} + \sqrt{x}} = \lim_{h \rightarrow 0} \frac{(x+h) - x}{h(\sqrt{x+h} + \sqrt{x})} = \lim_{h \rightarrow 0} \frac{h}{h(\sqrt{x+h} + \sqrt{x})} = \frac{1}{2\sqrt{x}}$.
 Thus, $\frac{1}{4} = \frac{1}{2\sqrt{x}} \Rightarrow \sqrt{x} = 2 \Rightarrow x = 4 \Rightarrow y = 2$. The tangent line is $y = 2 + \frac{1}{4}(x-4) = \frac{x}{4} + 1$.
29. $\lim_{h \rightarrow 0} \frac{f(2+h) - f(2)}{h} = \lim_{h \rightarrow 0} \frac{(100 - 4.9(2+h)^2) - (100 - 4.9(2)^2)}{h} = \lim_{h \rightarrow 0} \frac{-4.9(4+4h+h^2) + 4.9(4)}{h} = \lim_{h \rightarrow 0} (-19.6 - 4.9h) = -19.6$.
 The minus sign indicates the object is falling downward at a speed of 19.6 m/sec.
30. $\lim_{h \rightarrow 0} \frac{f(10+h) - f(10)}{h} = \lim_{h \rightarrow 0} \frac{3(10+h)^2 - 3(10)^2}{h} = \lim_{h \rightarrow 0} \frac{3(20h + h^2)}{h} = 60$ ft/sec.
31. $\lim_{h \rightarrow 0} \frac{f(3+h) - f(3)}{h} = \lim_{h \rightarrow 0} \frac{\pi(3+h)^2 - \pi(3)^2}{h} = \lim_{h \rightarrow 0} \frac{\pi[9+6h+h^2-9]}{h} = \lim_{h \rightarrow 0} \pi(6+h) = 6\pi$

32. $\lim_{h \rightarrow 0} \frac{f(2+h)-f(2)}{h} = \lim_{h \rightarrow 0} \frac{\frac{4\pi}{3}(2+h)^3 - \frac{4\pi}{3}(2)^3}{h} = \lim_{h \rightarrow 0} \frac{\frac{4\pi}{3}[12h+6h^2+h^3]}{h} = \lim_{h \rightarrow 0} \frac{4\pi}{3}[12+6h+h^2] = 16\pi$

33. At $(x_0, mx_0 + b)$ the slope of the tangent line is $\lim_{h \rightarrow 0} \frac{m(x_0+h)+b-(mx_0+b)}{(x_0+h)-x_0} = \lim_{h \rightarrow 0} \frac{mh}{h} = \lim_{h \rightarrow 0} m = m$.
 The equation of the tangent line is $y - (mx_0 + b) = m(x - x_0) \Rightarrow y = mx + b$.

34. At $x = 4, y = \frac{1}{\sqrt{4}} = \frac{1}{2}$ and $m = \lim_{h \rightarrow 0} \frac{\frac{1}{\sqrt{4+h}} - \frac{1}{2}}{h} = \lim_{h \rightarrow 0} \left[\frac{\frac{1}{\sqrt{4+h}} - \frac{1}{2}}{h} \cdot \frac{2\sqrt{4+h}}{2\sqrt{4+h}} \right] = \lim_{h \rightarrow 0} \left(\frac{2-\sqrt{4+h}}{2h\sqrt{4+h}} \right) = \lim_{h \rightarrow 0} \left[\frac{2-\sqrt{4+h}}{2h\sqrt{4+h}} \cdot \frac{2+\sqrt{4+h}}{2+\sqrt{4+h}} \right]$
 $= \lim_{h \rightarrow 0} \left(\frac{4-(4+h)}{2h\sqrt{4+h}(2+\sqrt{4+h})} \right) = \lim_{h \rightarrow 0} \left(\frac{-h}{2h\sqrt{4+h}(2+\sqrt{4+h})} \right) = \lim_{h \rightarrow 0} \left(\frac{-1}{2\sqrt{4+h}(2+\sqrt{4+h})} \right) = -\frac{1}{2\sqrt{4}(2+\sqrt{4})} = -\frac{1}{16}$

35. Slope at origin $= \lim_{h \rightarrow 0} \frac{f(0+h)-f(0)}{h} = \lim_{h \rightarrow 0} \frac{h^2 \sin(\frac{1}{h})}{h} = \lim_{h \rightarrow 0} h \sin(\frac{1}{h}) = 0 \Rightarrow$ yes, $f(x)$ does have a tangent at the origin with slope 0.

36. $\lim_{h \rightarrow 0} \frac{g(0+h)-g(0)}{h} = \lim_{h \rightarrow 0} \frac{h \sin(\frac{1}{h})}{h} = \lim_{h \rightarrow 0} \sin \frac{1}{h}$. Since $\lim_{h \rightarrow 0} \sin \frac{1}{h}$ does not exist, $f(x)$ has no tangent at the origin.

37. $\lim_{h \rightarrow 0^-} \frac{f(0+h)-f(0)}{h} = \lim_{h \rightarrow 0^-} \frac{-1-0}{h} = \infty$, and $\lim_{h \rightarrow 0^+} \frac{f(0+h)-f(0)}{h} = \lim_{h \rightarrow 0^+} \frac{1-0}{h} = \infty$. Therefore, $\lim_{h \rightarrow 0} \frac{f(0+h)-f(0)}{h} = \infty \Rightarrow$ yes, the graph of f has a vertical tangent at the origin.

38. $\lim_{h \rightarrow 0^-} \frac{U(0+h)-U(0)}{h} = \lim_{h \rightarrow 0^-} \frac{0-1}{h} = \infty$, and $\lim_{h \rightarrow 0^+} \frac{U(0+h)-U(0)}{h} = \lim_{h \rightarrow 0^+} \frac{1-1}{h} = 0 \Rightarrow$ no, the graph of f does not have a vertical tangent at $(0, 1)$ because the limit does not exist.

39. (a) The graph appears to have a cusp at $x = 0$.

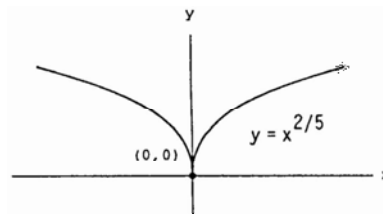

(b) $\lim_{h \rightarrow 0^-} \frac{f(0+h)-f(0)}{h} = \lim_{h \rightarrow 0^-} \frac{h^{2/5}-0}{h} = \lim_{h \rightarrow 0^-} \frac{1}{h^{3/5}} = -\infty$ and $\lim_{h \rightarrow 0^+} \frac{1}{h^{3/5}} = \infty \Rightarrow$ limit does not exist \Rightarrow the graph of $y = x^{2/5}$ does not have a vertical tangent at $x = 0$.

40. (a) The graph appears to have a cusp at $x = 0$.

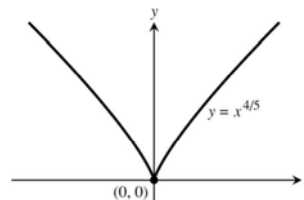

(b) $\lim_{h \rightarrow 0^-} \frac{f(0+h)-f(0)}{h} = \lim_{h \rightarrow 0^-} \frac{h^{4/5}-0}{h} = \lim_{h \rightarrow 0^-} \frac{1}{h^{1/5}} = -\infty$ and $\lim_{h \rightarrow 0^+} \frac{1}{h^{1/5}} = \infty \Rightarrow$ limit does not exist $\Rightarrow y = x^{4/5}$ does not have a vertical tangent at $x = 0$.

41. (a) The graph appears to have a vertical tangent at $x = 0$.

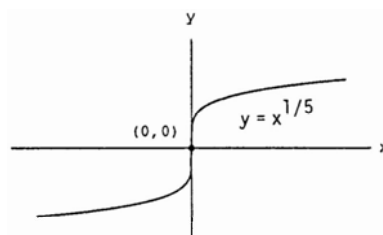

(b) $\lim_{h \rightarrow 0} \frac{f(0+h)-f(0)}{h} = \lim_{h \rightarrow 0} \frac{h^{1/5}-0}{h} = \lim_{h \rightarrow 0} \frac{1}{h^{4/5}} = \infty \Rightarrow y = x^{1/5}$ has a vertical tangent at $x = 0$.

42. (a) The graph appears to have a vertical tangent at $x = 0$.

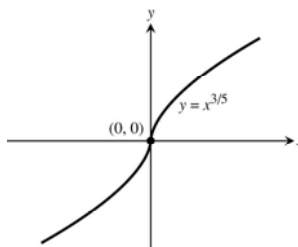

(b) $\lim_{h \rightarrow 0} \frac{f(0+h)-f(0)}{h} = \lim_{h \rightarrow 0} \frac{h^{3/5}-0}{h} = \lim_{h \rightarrow 0} \frac{1}{h^{2/5}} = \infty \Rightarrow$ the graph of $y = x^{3/5}$ has a vertical tangent at $x = 0$.

43. (a) The graph appears to have a cusp at $x = 0$.

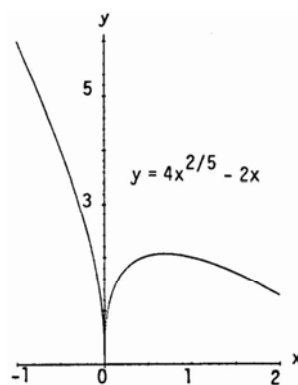

(b) $\lim_{h \rightarrow 0^-} \frac{f(0+h)-f(0)}{h} = \lim_{h \rightarrow 0^-} \frac{4h^{2/5}-2h}{h} = \lim_{h \rightarrow 0^-} \left(\frac{4}{h^{3/5}} - 2 \right) = -\infty$ and $\lim_{h \rightarrow 0^+} \left(\frac{4}{h^{3/5}} - 2 \right) = \infty \Rightarrow$ limit does not exist \Rightarrow the graph of $y = 4x^{2/5} - 2x$ does not have a vertical tangent at $x = 0$.

44. (a) The graph appears to have a cusp at $x = 0$.

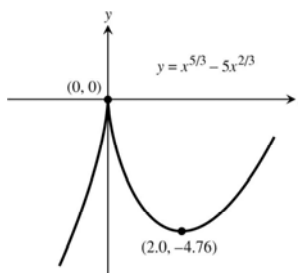

(b) $\lim_{h \rightarrow 0} \frac{f(0+h)-f(0)}{h} = \lim_{h \rightarrow 0} \frac{h^{5/3}-5h^{2/3}}{h} = \lim_{h \rightarrow 0} \left(h^{2/3} - \frac{5}{h^{1/3}} \right) = 0 - \lim_{h \rightarrow 0} \frac{5}{h^{1/3}}$ does not exist \Rightarrow the graph of $y = x^{5/3} - 5x^{2/3}$ does not have a vertical tangent at $x = 0$.

45. (a) The graph appears to have a vertical tangent at $x = 1$ and a cusp at $x = 0$.

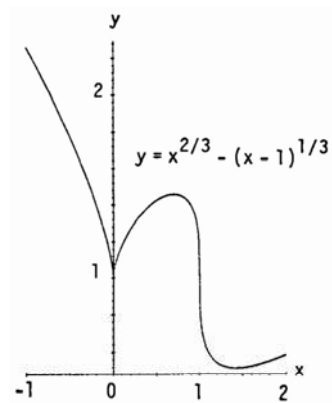

(b) $x = 1$: $\lim_{h \rightarrow 0} \frac{(1+h)^{2/3} - (1+h-1)^{1/3} - 1}{h} = \lim_{h \rightarrow 0} \frac{(1+h)^{2/3} - h^{1/3} - 1}{h} = -\infty \Rightarrow y = x^{2/3} - (x-1)^{1/3}$ has a vertical tangent at $x = 1$;

$x = 0$: $\lim_{h \rightarrow 0} \frac{f(0+h) - f(0)}{h} = \lim_{h \rightarrow 0} \frac{h^{2/3} - (h-1)^{1/3} - (-1)^{1/3}}{h} = \lim_{h \rightarrow 0} \left[\frac{1}{h^{1/3}} - \frac{(h-1)^{1/3}}{h} + \frac{1}{h} \right]$ does not exist
 $\Rightarrow y = x^{2/3} - (x-1)^{1/3}$ does not have a vertical tangent at $x = 0$.

46. (a) The graph appears to have vertical tangents at $x = 0$ and $x = 1$.

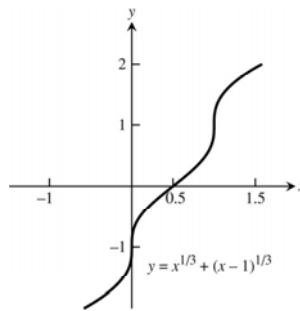

(b) $x = 0$: $\lim_{h \rightarrow 0} \frac{f(0+h) - f(0)}{h} = \lim_{h \rightarrow 0} \frac{h^{1/3} + (h-1)^{1/3} - (-1)^{1/3}}{h} = \infty \Rightarrow y = x^{1/3} + (x-1)^{1/3}$ has a vertical tangent at $x = 0$;

$x = 1$: $\lim_{h \rightarrow 0} \frac{f(1+h) - f(1)}{h} = \lim_{h \rightarrow 0} \frac{(1+h)^{1/3} + (1+h-1)^{1/3} - 1}{h} = \infty \Rightarrow y = x^{1/3} + (x-1)^{1/3}$ has a vertical tangent at $x = 1$.

47. (a) The graph appears to have a vertical tangent at $x = 0$.

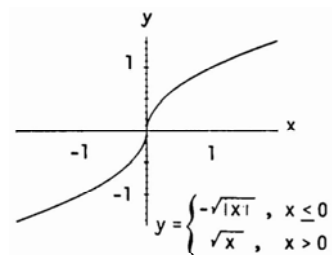

(b) $\lim_{h \rightarrow 0^+} \frac{f(0+h) - f(0)}{h} = \lim_{x \rightarrow 0^+} \frac{\sqrt{x} - 0}{x} = \lim_{h \rightarrow 0^+} \frac{1}{\sqrt{h}} = \infty$; $\lim_{h \rightarrow 0^-} \frac{f(0+h) - f(0)}{h} = \lim_{h \rightarrow 0^-} \frac{-\sqrt{|h|} - 0}{h} = \lim_{h \rightarrow 0^-} \frac{-\sqrt{|h|}}{-|h|}$
 $= \lim_{h \rightarrow 0^-} \frac{1}{\sqrt{|h|}} = \infty \Rightarrow y$ has a vertical tangent at $x = 0$.

48. (a) The graph appears to have a cusp at $x = 4$.

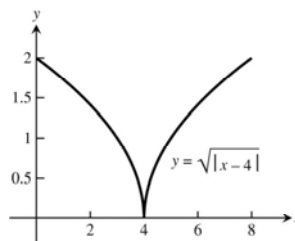

$$\begin{aligned} \text{(b)} \quad \lim_{h \rightarrow 0^+} \frac{f(4+h)-f(4)}{h} &= \lim_{h \rightarrow 0^+} \frac{\sqrt{4-(4+h)}-0}{h} = \lim_{h \rightarrow 0^+} \frac{\sqrt{-h}}{h} = \lim_{h \rightarrow 0^+} \frac{1}{\sqrt{h}} = \infty; \quad \lim_{h \rightarrow 0^-} \frac{f(4+h)-f(4)}{h} = \lim_{h \rightarrow 0^-} \frac{\sqrt{4-(4+h)}}{h} \\ &= \lim_{h \rightarrow 0^-} \frac{\sqrt{|h|}}{-|h|} = \lim_{h \rightarrow 0^-} \frac{-1}{\sqrt{|h|}} = -\infty \Rightarrow y = \sqrt{4-x} \text{ does not have a vertical tangent at } x = 4. \end{aligned}$$

49-52. Example CAS commands:

Maple:

```
f := x -> x^3 + 2*x; x0 := 0;
plot( f(x), x=x0-1/2..x0+3, color=black, # part (a)
      title="Section 3.1, #49(a)");
q := unapply( (f(x0+h)-f(x0))/h, h ); # part (b)
L := limit( q(h), h=0); # part (c)
sec_lines := seq( f(x0)+q(h)*(x-x0), h=1..3 ); # part (d)
tan_line := f(x0) + L*(x-x0);
plot( [f(x), tan_line, sec_lines], x=x0-1/2..x0+3, color=black,
      linestyle=[1,2,5,6,7], title="Section 3.1, #49(d)",
      legend=["y=f(x)", "Tangent line at x=0", "Secant line (h=1)",
             "Secant line (h=2)", "Secant line (h=3)"]);
```

Mathematica: (function and value for x0 may change)

```
Clear[f, m, x, h]
x0 = p;
f[x_] := Cos[x] + 4Sin[2x]
Plot[f[x], {x, x0-1, x0+3}]
dq[h_] := (f[x0+h] - f[x0])/h
m = Limit[dq[h], h -> 0]
ytan = f[x0] + m(x - x0)
y1 = f[x0] + dq[1](x - x0)
y2 = f[x0] + dq[2](x - x0)
y3 = f[x0] + dq[3](x - x0)
Plot[{f[x], ytan, y1, y2, y3}, {x, x0-1, x0+3}]
```

3.2 THE DERIVATIVE AS A FUNCTION

1. Step 1: $f(x) = 4 - x^2$ and $f(x+h) = 4 - (x+h)^2$
- Step 2: $\frac{f(x+h)-f(x)}{h} = \frac{[4-(x+h)^2]-(4-x^2)}{h} = \frac{(4-x^2-2xh-h^2)-4+x^2}{h} = \frac{-2xh-h^2}{h} = \frac{h(-2x-h)}{h} = -2x-h$
- Step 3: $f'(x) = \lim_{h \rightarrow 0} (-2x-h) = -2x$; $f'(-3) = 6$, $f'(0) = 0$, $f'(1) = -2$

$$\begin{aligned}
2. \quad F(x) &= (x-1)^2 + 1 \text{ and } F(x+h) = (x+h-1)^2 + 1 \Rightarrow F'(x) = \lim_{h \rightarrow 0} \frac{[(x+h-1)^2 + 1] - [(x-1)^2 + 1]}{h} \\
&= \lim_{h \rightarrow 0} \frac{(x^2 + 2xh + h^2 - 2x - 2h + 1 + 1) - (x^2 - 2x + 1 + 1)}{h} = \lim_{h \rightarrow 0} \frac{2xh + h^2 - 2h}{h} = \lim_{h \rightarrow 0} (2x + h - 2) = 2(x-1); \\
F'(-1) &= -4, F'(0) = -2, F'(2) = 2
\end{aligned}$$

$$3. \text{ Step 1: } g(t) = \frac{1}{t^2} \text{ and } g(t+h) = \frac{1}{(t+h)^2}$$

$$\text{Step 2: } \frac{g(t+h) - g(t)}{h} = \frac{\frac{1}{(t+h)^2} - \frac{1}{t^2}}{h} = \frac{\frac{t^2 - (t+h)^2}{(t+h)^2 \cdot t^2}}{h} = \frac{t^2 - (t^2 + 2th + h^2)}{(t+h)^2 \cdot t^2 \cdot h} = \frac{-2th - h^2}{(t+h)^2 \cdot t^2 \cdot h} = \frac{h(-2t-h)}{(t+h)^2 \cdot t^2 \cdot h} = \frac{-2t-h}{(t+h)^2 \cdot t^2}$$

$$\text{Step 3: } g'(t) = \lim_{h \rightarrow 0} \frac{-2t-h}{(t+h)^2 \cdot t^2} = \frac{-2t}{t^2 \cdot t^2} = \frac{-2}{t^3}; g'(-1) = 2, g'(2) = -\frac{1}{4}, g'(\sqrt{3}) = -\frac{2}{3\sqrt{3}}$$

$$\begin{aligned}
4. \quad k(z) &= \frac{1-z}{2z} \text{ and } k(z+h) = \frac{1-(z+h)}{2(z+h)} \Rightarrow k'(z) = \lim_{h \rightarrow 0} \frac{\frac{1-(z+h)}{2(z+h)} - \frac{1-z}{2z}}{h} = \lim_{h \rightarrow 0} \frac{(1-z-h)z - (1-z)(z+h)}{2(z+h)zh} = \lim_{h \rightarrow 0} \frac{z-z^2-zh-z-h+z^2+zh}{2(z+h)zh} \\
&= \lim_{h \rightarrow 0} \frac{-h}{2(z+h)zh} = \lim_{h \rightarrow 0} \frac{-1}{2(z+h)z} = \frac{-1}{2z^2}; k'(-1) = -\frac{1}{2}, k'(1) = -\frac{1}{2}, k'(\sqrt{2}) = -\frac{1}{4}
\end{aligned}$$

$$5. \text{ Step 1: } p(\theta) = \sqrt{3\theta} \text{ and } p(\theta+h) = \sqrt{3(\theta+h)}$$

$$\text{Step 2: } \frac{p(\theta+h) - p(\theta)}{h} = \frac{\sqrt{3(\theta+h)} - \sqrt{3\theta}}{h} = \frac{(\sqrt{3\theta+3h} - \sqrt{3\theta}) \cdot (\sqrt{3\theta+3h} + \sqrt{3\theta})}{h(\sqrt{3\theta+3h} + \sqrt{3\theta})} = \frac{(3\theta+3h) - 3\theta}{h(\sqrt{3\theta+3h} + \sqrt{3\theta})} = \frac{3h}{h(\sqrt{3\theta+3h} + \sqrt{3\theta})} = \frac{3}{\sqrt{3\theta+3h} + \sqrt{3\theta}}$$

$$\text{Step 3: } p'(\theta) = \lim_{h \rightarrow 0} \frac{3}{\sqrt{3\theta+3h} + \sqrt{3\theta}} = \frac{3}{\sqrt{3\theta} + \sqrt{3\theta}} = \frac{3}{2\sqrt{3\theta}}; p'(1) = \frac{3}{2\sqrt{3}}, p'(3) = \frac{1}{2}, p'\left(\frac{2}{3}\right) = \frac{3}{2\sqrt{2}}$$

$$6. \quad r(s) = \sqrt{2s+1} \text{ and } r(s+h) = \sqrt{2(s+h)+1} \Rightarrow r'(s) = \lim_{h \rightarrow 0} \frac{\sqrt{2s+2h+1} - \sqrt{2s+1}}{h}$$

$$\begin{aligned}
&= \lim_{h \rightarrow 0} \frac{(\sqrt{2s+2h+1} - \sqrt{2s+1}) \cdot (\sqrt{2s+2h+1} + \sqrt{2s+1})}{h(\sqrt{2s+2h+1} + \sqrt{2s+1})} = \lim_{h \rightarrow 0} \frac{(2s+2h+1) - (2s+1)}{h(\sqrt{2s+2h+1} + \sqrt{2s+1})} \\
&= \lim_{h \rightarrow 0} \frac{2h}{h(\sqrt{2s+2h+1} + \sqrt{2s+1})} = \lim_{h \rightarrow 0} \frac{2}{\sqrt{2s+2h+1} + \sqrt{2s+1}} = \frac{2}{\sqrt{2s+1} + \sqrt{2s+1}} = \frac{2}{2\sqrt{2s+1}} = \frac{1}{\sqrt{2s+1}};
\end{aligned}$$

$$r'(0) = 1, r'(1) = \frac{1}{\sqrt{3}}, r'\left(\frac{1}{2}\right) = \frac{1}{\sqrt{2}}$$

$$7. \quad y = f(x) = 2x^3 \text{ and } f(x+h) = 2(x+h)^3 \Rightarrow \frac{dy}{dx} = \lim_{h \rightarrow 0} \frac{2(x+h)^3 - 2x^3}{h} = \lim_{h \rightarrow 0} \frac{2(x^3 + 3x^2h + 3xh^2 + h^3) - 2x^3}{h}$$

$$= \lim_{h \rightarrow 0} \frac{6x^2h + 6xh^2 + 2h^3}{h} = \lim_{h \rightarrow 0} \frac{h(6x^2 + 6xh + 2h^2)}{h} = \lim_{h \rightarrow 0} (6x^2 + 6xh + 2h^2) = 6x^2$$

$$8. \quad r = s^3 - 2s^2 + 3 \Rightarrow \frac{dr}{ds} = \lim_{h \rightarrow 0} \frac{((s+h)^3 - 2(s+h)^2 + 3) - (s^3 - 2s^2 + 3)}{h} = \lim_{h \rightarrow 0} \frac{s^3 + 3s^2h + 3sh^2 + h^3 - 2s^2 - 4sh - 2h^2 + 3 - s^3 + 2s^2 - 3}{h}$$

$$= \lim_{h \rightarrow 0} \frac{3s^2h + 3sh^2 + h^3 - 4sh - 2h^2}{h} = \lim_{h \rightarrow 0} \frac{h(3s^2 + 3sh + h^2 - 4s - 2h)}{h} = \lim_{h \rightarrow 0} (3s^2 + 3sh + h^2 - 4s - 2h) = 3s^2 - 2s$$

9. $s = r(t) = \frac{t}{2t+1}$ and $r(t+h) = \frac{t+h}{2(t+h)+1} \Rightarrow \frac{ds}{dt} = \lim_{h \rightarrow 0} \frac{\left(\frac{t+h}{2(t+h)+1}\right) - \left(\frac{t}{2t+1}\right)}{h} = \lim_{h \rightarrow 0} \frac{\left(\frac{(t+h)(2t+1) - t(2t+2h+1)}{(2t+2h+1)(2t+1)}\right)}{h}$
 $= \lim_{h \rightarrow 0} \frac{(t+h)(2t+1) - t(2t+2h+1)}{(2t+2h+1)(2t+1)h} = \lim_{h \rightarrow 0} \frac{2t^2 + t + 2ht + h - 2t^2 - 2ht - t}{(2t+2h+1)(2t+1)h} = \lim_{h \rightarrow 0} \frac{h}{(2t+2h+1)(2t+1)h} = \lim_{h \rightarrow 0} \frac{1}{(2t+2h+1)(2t+1)}$
 $= \frac{1}{(2t+1)(2t+1)} = \frac{1}{(2t+1)^2}$
10. $\frac{dv}{dt} = \lim_{h \rightarrow 0} \frac{\left[\frac{(t+h) - \frac{1}{t+h}}{h}\right] - \left(\frac{t - \frac{1}{t}}{t}\right)}{h} = \lim_{h \rightarrow 0} \frac{h - \frac{1}{t+h} + \frac{1}{t}}{h} = \lim_{h \rightarrow 0} \frac{\left(\frac{h(t+h)t - t + (t+h)}{(t+h)t}\right)}{h} = \lim_{h \rightarrow 0} \frac{ht^2 + h^2t + h}{h(t+h)t} = \lim_{h \rightarrow 0} \frac{t^2 + ht + 1}{(t+h)t} = \frac{t^2 + 1}{t^2} = 1 + \frac{1}{t^2}$
11. $\frac{dp}{dq} = \lim_{h \rightarrow 0} \frac{(q+h)^{3/2} - q^{3/2}}{h} = \lim_{h \rightarrow 0} \frac{(q+h)(q+h)^{1/2} - q \cdot q^{1/2}}{h} = \lim_{h \rightarrow 0} \left(\frac{q[(q+h)^{1/2} - q^{1/2}]}{h} + \frac{h(q+h)^{1/2}}{h} \right) =$
 $\lim_{h \rightarrow 0} \left(\frac{q[(q+h)^{1/2} - q^{1/2}][(q+h)^{1/2} + q^{1/2}]}{h[(q+h)^{1/2} + q^{1/2}]} + (q+h)^{1/2} \right) = \lim_{h \rightarrow 0} \left(\frac{q[(q+h) - q]}{h[(q+h)^{1/2} + q^{1/2}]} + (q+h)^{1/2} \right) = \lim_{h \rightarrow 0} \left(\frac{q}{(q+h)^{1/2} + q^{1/2}} + (q+h)^{1/2} \right) = \frac{q^{1/2}}{2} + q^{1/2} = \frac{3}{2}q^{1/2}$
12. $\frac{dz}{dw} = \lim_{h \rightarrow 0} \frac{\frac{1}{\sqrt{(w+h)^2 - 1}} - \frac{1}{\sqrt{w^2 - 1}}}{h} = \lim_{h \rightarrow 0} \frac{\sqrt{w^2 - 1} - \sqrt{(w+h)^2 - 1}}{h\sqrt{(w+h)^2 - 1}\sqrt{w^2 - 1}} = \lim_{h \rightarrow 0} \frac{(\sqrt{w^2 - 1} - \sqrt{(w+h)^2 - 1})(\sqrt{w^2 - 1} + \sqrt{(w+h)^2 - 1})}{h\sqrt{(w+h)^2 - 1}\sqrt{w^2 - 1}(\sqrt{w^2 - 1} + \sqrt{(w+h)^2 - 1})} =$
 $\lim_{h \rightarrow 0} \frac{w^2 - 1 - (w^2 + 2wh + h^2 - 1)}{h\sqrt{(w+h)^2 - 1}\sqrt{w^2 - 1}(\sqrt{w^2 - 1} + \sqrt{(w+h)^2 - 1})} = \lim_{h \rightarrow 0} \frac{-2w - h}{h\sqrt{(w+h)^2 - 1}\sqrt{w^2 - 1}(\sqrt{w^2 - 1} + \sqrt{(w+h)^2 - 1})} = -\frac{w}{(w^2 - 1)^{3/2}}$
13. $f(x) = x + \frac{9}{x}$ and $f(x+h) = (x+h) + \frac{9}{(x+h)} \Rightarrow \frac{f(x+h) - f(x)}{h} = \frac{\left[\frac{(x+h) + \frac{9}{(x+h)}\right] - \left[x + \frac{9}{x}\right]}{h} = \frac{x(x+h)^2 + 9x - x^2(x+h) - 9(x+h)}{x(x+h)h}$
 $= \frac{x^3 + 2x^2h + xh^2 + 9x - x^3 - x^2h - 9x - 9h}{x(x+h)h} = \frac{x^2h + xh^2 - 9h}{x(x+h)h} = \frac{h(x^2 + xh - 9)}{x(x+h)h} = \frac{x^2 + xh - 9}{x(x+h)}$; $f'(x) = \lim_{h \rightarrow 0} \frac{x^2 + xh - 9}{x(x+h)} = \frac{x^2 - 9}{x^2} = 1 - \frac{9}{x^2}$;
 $m = f'(-3) = 0$
14. $k(x) = \frac{1}{2+x}$ and $k(x+h) = \frac{1}{2+(x+h)} \Rightarrow k'(x) = \lim_{h \rightarrow 0} \frac{k(x+h) - k(x)}{h} = \lim_{h \rightarrow 0} \frac{\left(\frac{1}{2+x+h} - \frac{1}{2+x}\right)}{h} = \lim_{h \rightarrow 0} \frac{(2+x) - (2+x+h)}{h(2+x)(2+x+h)}$
 $= \lim_{h \rightarrow 0} \frac{-h}{h(2+x)(2+x+h)} = \lim_{h \rightarrow 0} \frac{-1}{(2+x)(2+x+h)} = \frac{-1}{(2+x)^2}$; $k'(2) = -\frac{1}{16}$
15. $\frac{ds}{dt} = \lim_{h \rightarrow 0} \frac{[(t+h)^3 - (t+h)^2] - (t^3 - t^2)}{h} = \lim_{h \rightarrow 0} \frac{(t^3 + 3t^2h + 3th^2 + h^3) - (t^2 + 2th + h^2) - t^3 + t^2}{h} = \lim_{h \rightarrow 0} \frac{3t^2h + 3th^2 + h^3 - 2th - h^2}{h}$
 $= \lim_{h \rightarrow 0} \frac{h(3t^2 + 3th + h^2 - 2t - h)}{h} = \lim_{h \rightarrow 0} (3t^2 + 3th + h^2 - 2t - h) = 3t^2 - 2t$; $m = \left.\frac{ds}{dt}\right|_{t=-1} = 5$
16. $\frac{dy}{dx} = \lim_{h \rightarrow 0} \frac{\frac{(x+h)+3}{1-(x+h)} - \frac{x+3}{1-x}}{h} = \lim_{h \rightarrow 0} \frac{(x+h+3)(1-x) - (x+3)(1-x-h)}{h(1-x-h)(1-x)} = \lim_{h \rightarrow 0} \frac{xh+3-x^2-xh-3x-x-3+x^2+3x+3h+3h}{h(1-x-h)(1-x)} = \lim_{h \rightarrow 0} \frac{4h}{h(1-x-h)(1-x)}$
 $= \lim_{h \rightarrow 0} \frac{4}{(1-x-h)(1-x)} = \frac{4}{(1-x)^2}$; $\left.\frac{dy}{dx}\right|_{x=-2} = \frac{4}{(3)^2} = \frac{4}{9}$
17. $f(x) = \frac{8}{\sqrt{x-2}}$ and $f(x+h) = \frac{8}{\sqrt{(x+h)-2}} \Rightarrow \frac{f(x+h) - f(x)}{h} = \frac{\frac{8}{\sqrt{(x+h)-2}} - \frac{8}{\sqrt{x-2}}}{h} = \frac{8(\sqrt{x-2} - \sqrt{x+h-2})}{h\sqrt{x+h-2}\sqrt{x-2}} \cdot \frac{(\sqrt{x-2} + \sqrt{x+h-2})}{(\sqrt{x-2} + \sqrt{x+h-2})}$
 $= \frac{8[(x-2) - (x+h-2)]}{h\sqrt{x+h-2}\sqrt{x-2}(\sqrt{x-2} + \sqrt{x+h-2})} = \frac{-8h}{h\sqrt{x+h-2}\sqrt{x-2}(\sqrt{x-2} + \sqrt{x+h-2})} \Rightarrow f'(x) = \lim_{h \rightarrow 0} \frac{-8}{\sqrt{x+h-2}\sqrt{x-2}(\sqrt{x-2} + \sqrt{x+h-2})}$
 $= \frac{-8}{\sqrt{x-2}\sqrt{x-2}(\sqrt{x-2} + \sqrt{x-2})} = \frac{-4}{(x-2)\sqrt{x-2}}$; $m = f'(6) = \frac{-4}{4\sqrt{4}} = -\frac{1}{2} \Rightarrow$ the equation of the tangent line at (6, 4) is
 $y - 4 = -\frac{1}{2}(x - 6) \Rightarrow y = -\frac{1}{2}x + 3 + 4 \Rightarrow y = -\frac{1}{2}x + 7$.

$$\begin{aligned}
 18. \quad g'(z) &= \lim_{h \rightarrow 0} \frac{(1+\sqrt{4-(z+h)})-(1+\sqrt{4-z})}{h} = \lim_{h \rightarrow 0} \frac{(\sqrt{4-z-h}-\sqrt{4-z})}{h} \cdot \frac{(\sqrt{4-z-h}+\sqrt{4-z})}{(\sqrt{4-z-h}+\sqrt{4-z})} = \lim_{h \rightarrow 0} \frac{(4-z-h)-(4-z)}{h(\sqrt{4-z-h}+\sqrt{4-z})} \\
 &= \lim_{h \rightarrow 0} \frac{-h}{h(\sqrt{4-z-h}+\sqrt{4-z})} = \lim_{h \rightarrow 0} \frac{-1}{(\sqrt{4-z-h}+\sqrt{4-z})} = \frac{-1}{2\sqrt{4-z}}; m = g'(3) = \frac{-1}{2\sqrt{4-3}} = -\frac{1}{2} \Rightarrow \text{the equation} \\
 &\text{of the tangent line at } (3, 2) \text{ is } w-2 = -\frac{1}{2}(z-3) \Rightarrow w = -\frac{1}{2}z + \frac{3}{2} + 2 \Rightarrow w = -\frac{1}{2}z + \frac{7}{2}.
 \end{aligned}$$

$$\begin{aligned}
 19. \quad s &= f(t) = 1 - 3t^2 \text{ and } f(t+h) = 1 - 3(t+h)^2 = 1 - 3t^2 - 6th - 3h^2 \Rightarrow \frac{ds}{dt} = \lim_{h \rightarrow 0} \frac{f(t+h)-f(t)}{h} \\
 &= \lim_{h \rightarrow 0} \frac{(1-3t^2-6th-3h^2)-(1-3t^2)}{h} = \lim_{h \rightarrow 0} (-6t-3h) = -6t \Rightarrow \left. \frac{ds}{dt} \right|_{t=-1} = 6
 \end{aligned}$$

$$\begin{aligned}
 20. \quad y &= f(x) = 1 - \frac{1}{x} \text{ and } f(x+h) = 1 - \frac{1}{x+h} \Rightarrow \frac{dy}{dx} = \lim_{h \rightarrow 0} \frac{f(x+h)-f(x)}{h} = \lim_{h \rightarrow 0} \frac{(1-\frac{1}{x+h})-(1-\frac{1}{x})}{h} = \lim_{h \rightarrow 0} \frac{\frac{1}{x}-\frac{1}{x+h}}{h} \\
 &= \lim_{h \rightarrow 0} \frac{h}{x(x+h)h} = \lim_{h \rightarrow 0} \frac{1}{x(x+h)} = \frac{1}{x^2} \Rightarrow \left. \frac{dy}{dx} \right|_{x=\sqrt{3}} = \frac{1}{3}
 \end{aligned}$$

$$\begin{aligned}
 21. \quad r &= f(\theta) = \frac{2}{\sqrt{4-\theta}} \text{ and } f(\theta+h) = \frac{2}{\sqrt{4-(\theta+h)}} \Rightarrow \frac{dr}{d\theta} = \lim_{h \rightarrow 0} \frac{f(\theta+h)-f(\theta)}{h} = \lim_{h \rightarrow 0} \frac{\frac{2}{\sqrt{4-\theta-h}}-\frac{2}{\sqrt{4-\theta}}}{h} = \lim_{h \rightarrow 0} \frac{2\sqrt{4-\theta}-2\sqrt{4-\theta-h}}{h\sqrt{4-\theta}\sqrt{4-\theta-h}} \\
 &= \lim_{h \rightarrow 0} \frac{2\sqrt{4-\theta}-2\sqrt{4-\theta-h}}{h\sqrt{4-\theta}\sqrt{4-\theta-h}} \cdot \frac{(2\sqrt{4-\theta}+2\sqrt{4-\theta-h})}{(2\sqrt{4-\theta}+2\sqrt{4-\theta-h})} = \lim_{h \rightarrow 0} \frac{4(4-\theta)-4(4-\theta-h)}{2h\sqrt{4-\theta}\sqrt{4-\theta-h}(\sqrt{4-\theta}+\sqrt{4-\theta-h})} \\
 &= \lim_{h \rightarrow 0} \frac{2}{\sqrt{4-\theta}\sqrt{4-\theta-h}(\sqrt{4-\theta}+\sqrt{4-\theta-h})} = \frac{2}{(4-\theta)(2\sqrt{4-\theta})} = \frac{1}{(4-\theta)\sqrt{4-\theta}} \Rightarrow \left. \frac{dr}{d\theta} \right|_{\theta=0} = \frac{1}{8}
 \end{aligned}$$

$$\begin{aligned}
 22. \quad w &= f(z) = z + \sqrt{z} \text{ and } f(z+h) = (z+h) + \sqrt{z+h} \Rightarrow \frac{dw}{dz} = \lim_{h \rightarrow 0} \frac{f(z+h)-f(z)}{h} = \lim_{h \rightarrow 0} \frac{(z+h+\sqrt{z+h})-(z+\sqrt{z})}{h} \\
 &= \lim_{h \rightarrow 0} \frac{h+\sqrt{z+h}-\sqrt{z}}{h} = \lim_{h \rightarrow 0} \left[1 + \frac{\sqrt{z+h}-\sqrt{z}}{h} \cdot \frac{(\sqrt{z+h}+\sqrt{z})}{(\sqrt{z+h}+\sqrt{z})} \right] = 1 + \lim_{h \rightarrow 0} \frac{(z+h)-z}{h(\sqrt{z+h}+\sqrt{z})} = 1 + \lim_{h \rightarrow 0} \frac{1}{\sqrt{z+h}+\sqrt{z}} = 1 + \frac{1}{2\sqrt{z}} \\
 &\Rightarrow \left. \frac{dw}{dz} \right|_{z=4} = \frac{5}{4}
 \end{aligned}$$

$$23. \quad f'(x) = \lim_{z \rightarrow x} \frac{f(z)-f(x)}{z-x} = \lim_{z \rightarrow x} \frac{\frac{1}{z+2}-\frac{1}{x+2}}{z-x} = \lim_{z \rightarrow x} \frac{(x+2)-(z+2)}{(z-x)(z+2)(x+2)} = \lim_{z \rightarrow x} \frac{x-z}{(z-x)(z+2)(x+2)} = \lim_{z \rightarrow x} \frac{-1}{(z+2)(x+2)} = \frac{-1}{(x+2)^2}$$

$$\begin{aligned}
 24. \quad f'(x) &= \lim_{z \rightarrow x} \frac{f(z)-f(x)}{z-x} = \lim_{z \rightarrow x} \frac{(z^2-3z+4)-(x^2-3x+4)}{z-x} = \lim_{z \rightarrow x} \frac{z^2-3z-x^2+3x}{z-x} = \lim_{z \rightarrow x} \frac{z^2-x^2-3z+3x}{z-x} = \lim_{z \rightarrow x} \frac{(z-x)(z+x)-3(z-x)}{z-x} \\
 &= \lim_{z \rightarrow x} \frac{(z-x)[(z+x)-3]}{z-x} = \lim_{z \rightarrow x} [(z+x)-3] = 2x-3
 \end{aligned}$$

$$25. \quad g'(x) = \lim_{z \rightarrow x} \frac{g(z)-g(x)}{z-x} = \lim_{z \rightarrow x} \frac{\frac{z}{z-1}-\frac{x}{x-1}}{z-x} = \lim_{z \rightarrow x} \frac{z(x-1)-x(z-1)}{(z-x)(z-1)(x-1)} = \lim_{z \rightarrow x} \frac{-z+x}{(z-x)(z-1)(x-1)} = \lim_{z \rightarrow x} \frac{-1}{(z-1)(x-1)} = \frac{-1}{(x-1)^2}$$

$$26. \quad g'(x) = \lim_{z \rightarrow x} \frac{g(z)-g(x)}{z-x} = \lim_{z \rightarrow x} \frac{(1+\sqrt{z})-(1+\sqrt{x})}{z-x} = \lim_{z \rightarrow x} \frac{\sqrt{z}-\sqrt{x}}{z-x} \cdot \frac{\sqrt{z}+\sqrt{x}}{\sqrt{z}+\sqrt{x}} = \lim_{z \rightarrow x} \frac{z-x}{(z-x)(\sqrt{z}+\sqrt{x})} = \lim_{z \rightarrow x} \frac{1}{\sqrt{z}+\sqrt{x}} = \frac{1}{2\sqrt{x}}$$

27. Note that as x increases, the slope of the tangent line to the curve is first negative, then zero (when $x = 0$), then positive \Rightarrow the slope is always increasing which matches (b).

28. Note that the slope of the tangent line is never negative. For x negative, $f_2'(x)$ is positive but decreasing as x increases. When $x = 0$, the slope of the tangent line to x is 0. For $x > 0$, $f_2'(x)$ is positive and increasing. This graph matches (a).

29. $f_3(x)$ is an oscillating function like the cosine. Everywhere that the graph of f_3 has a horizontal tangent we expect f'_3 to be zero, and (d) matches this condition.

30. The graph matches with (c).

31. (a) f' is not defined at $x = 0, 1, 4$. At these points, the left-hand and right-hand derivatives do not agree. For example, $\lim_{x \rightarrow 0^-} \frac{f(x)-f(0)}{x-0} = \text{slope of line joining } (-4, 0) \text{ and } (0, 2) = \frac{1}{2}$ but $\lim_{x \rightarrow 0^+} \frac{f(x)-f(0)}{x-0} = \text{slope of line joining } (0, 2) \text{ and } (1, -2) = -4$. Since these values are not equal, $f'(0) = \lim_{x \rightarrow 0} \frac{f(x)-f(0)}{x-0}$ does not exist.

(b)

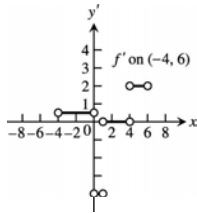

32. (a)

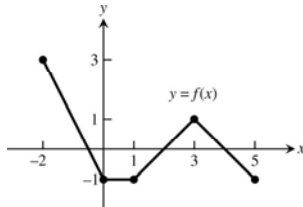

(b) Shift the graph in (a) down 3 units

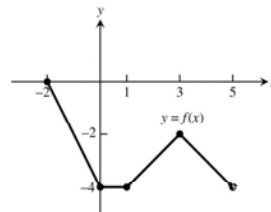

33.

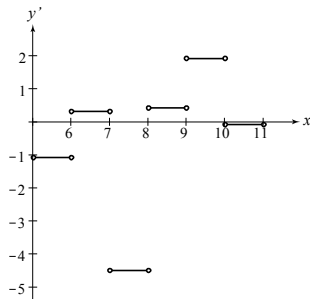

34. (a)

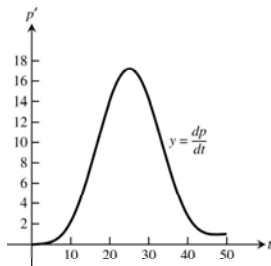

(b) The fastest is between the 20th and 30th days; slowest is between the 40th and 50th days.

35. Answers may vary. In each case, draw a tangent line and estimate its slope.

(a) i) slope $\approx 1.54 \Rightarrow \frac{dT}{dt} \approx 1.54 \frac{^\circ\text{F}}{\text{hr}}$

ii) slope $\approx 2.86 \Rightarrow \frac{dT}{dt} \approx 2.86 \frac{^\circ\text{F}}{\text{hr}}$

iii) slope $\approx 0 \Rightarrow \frac{dT}{dt} \approx 0 \frac{^\circ\text{F}}{\text{hr}}$

iv) slope $\approx -3.75 \Rightarrow \frac{dT}{dt} \approx -3.75 \frac{^\circ\text{F}}{\text{hr}}$

- (b) The tangent with the steepest positive slope appears to occur at $t = 6 \Rightarrow 12$ p.m. and slope ≈ 7.27
 $\Rightarrow \frac{dT}{dt} \approx 7.27 \frac{^{\circ}\text{F}}{\text{hr}}$. The tangent with the steepest negative slope appears to occur at $t = 12 \Rightarrow 6$ p.m. and
 slope $\approx -8.00 \Rightarrow \frac{dT}{dt} \approx -8.00 \frac{^{\circ}\text{F}}{\text{hr}}$

(c)

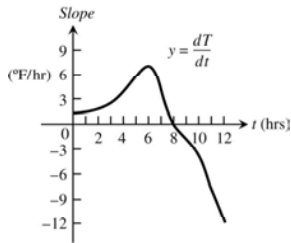

36. Answers may vary. In each case, draw a tangent line and estimate the slope.

- (a) i) slope $\approx -20.83 \Rightarrow \frac{dW}{dt} \approx -20.83 \frac{\text{lb}}{\text{month}}$ ii) slope $\approx -35.00 \Rightarrow \frac{dW}{dt} \approx -35.00 \frac{\text{lb}}{\text{month}}$
 iii) slope $\approx -6.25 \Rightarrow \frac{dW}{dt} \approx -6.25 \frac{\text{lb}}{\text{month}}$

- (b) The tangent with the steepest positive slope appears to occur at $t = 2.7$ months. and slope ≈ 7.27
 $\Rightarrow \frac{dW}{dt} \approx -53.13 \frac{\text{lb}}{\text{month}}$

(c)

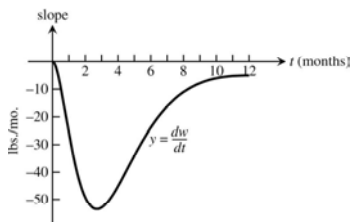

37. Left-hand derivative: For $h < 0, f(0+h) = f(h) = h^2$ (using $y = x^2$ curve) $\Rightarrow \lim_{h \rightarrow 0^-} \frac{f(0+h)-f(0)}{h}$

$$= \lim_{h \rightarrow 0^-} \frac{h^2-0}{h} = \lim_{h \rightarrow 0^-} h = 0;$$

Right-hand derivative: For $h > 0, f(0+h) = f(h) = h$ (using $y = x$ curve) $\Rightarrow \lim_{h \rightarrow 0^+} \frac{f(0+h)-f(0)}{h}$

$$= \lim_{h \rightarrow 0^+} \frac{h-0}{h} = \lim_{h \rightarrow 0^+} 1 = 1; \text{ Then } \lim_{h \rightarrow 0^-} \frac{f(0+h)-f(0)}{h} \neq \lim_{h \rightarrow 0^+} \frac{f(0+h)-f(0)}{h} \Rightarrow \text{the derivative } f'(0) \text{ does not exist.}$$

38. Left-hand derivative: When $h < 0, 1+h < 1 \Rightarrow f(1+h) = 2 \Rightarrow \lim_{h \rightarrow 0^-} \frac{f(1+h)-f(1)}{h} = \lim_{h \rightarrow 0^-} \frac{2-2}{h} = \lim_{h \rightarrow 0^-} 0 = 0;$

Right-hand derivative: When $h > 0, 1+h > 1 \Rightarrow f(1+h) = 2(1+h) = 2+2h \Rightarrow \lim_{h \rightarrow 0^+} \frac{f(1+h)-f(1)}{h} = \lim_{h \rightarrow 0^+} \frac{(2+2h)-2}{h}$

$$= \lim_{h \rightarrow 0^+} \frac{2h}{h} = \lim_{h \rightarrow 0^+} 2 = 2;$$

Then $\lim_{h \rightarrow 0^-} \frac{f(1+h)-f(1)}{h} \neq \lim_{h \rightarrow 0^+} \frac{f(1+h)-f(1)}{h} \Rightarrow \text{the derivative } f'(1) \text{ does not exist.}$

39. Left-hand derivative: When $h < 0, 1+h < 1 \Rightarrow f(1+h) = \sqrt{1+h} \Rightarrow \lim_{h \rightarrow 0^-} \frac{f(1+h)-f(1)}{h} = \lim_{h \rightarrow 0^-} \frac{\sqrt{1+h}-1}{h}$

$$= \lim_{h \rightarrow 0^-} \frac{(\sqrt{1+h}-1) \cdot (\sqrt{1+h}+1)}{h \cdot (\sqrt{1+h}+1)} = \lim_{h \rightarrow 0^-} \frac{(1+h)-1}{h(\sqrt{1+h}+1)} = \lim_{h \rightarrow 0^-} \frac{1}{\sqrt{1+h}+1} = \frac{1}{2};$$

Right-hand derivative: When $h > 0, 1+h > 1 \Rightarrow f(1+h) = 2(1+h) - 1 = 2h + 1 \Rightarrow \lim_{h \rightarrow 0^+} \frac{f(1+h)-f(1)}{h}$
 $= \lim_{h \rightarrow 0^+} \frac{(2h+1)-1}{h} = \lim_{h \rightarrow 0^+} 2 = 2;$
 Then $\lim_{h \rightarrow 0^-} \frac{f(1+h)-f(1)}{h} \neq \lim_{h \rightarrow 0^+} \frac{f(1+h)-f(1)}{h} \Rightarrow$ the derivative $f'(1)$ does not exist.

40. Left-hand derivative: $\lim_{h \rightarrow 0^-} \frac{f(1+h)-f(1)}{h} = \lim_{h \rightarrow 0^-} \frac{(1+h)-1}{h} = \lim_{h \rightarrow 0^-} 1 = 1;$
 Right-hand derivative: $\lim_{h \rightarrow 0^+} \frac{f(1+h)-f(1)}{h} = \lim_{h \rightarrow 0^+} \frac{\left(\frac{1}{1+h}\right)-1}{h} = \lim_{h \rightarrow 0^+} \frac{\left(\frac{1-(1+h)}{1+h}\right)}{h} = \lim_{h \rightarrow 0^+} \frac{-h}{h(1+h)} = \lim_{h \rightarrow 0^+} \frac{-1}{1+h} = -1;$
 Then $\lim_{h \rightarrow 0^-} \frac{f(1+h)-f(1)}{h} \neq \lim_{h \rightarrow 0^+} \frac{f(1+h)-f(1)}{h} \Rightarrow$ the derivative $f'(1)$ does not exist.

41. f is not continuous at $x = 0$ since $\lim_{x \rightarrow 0} f(x) =$ does not exist and $f(0) = -1$

42. Left-hand derivative: $\lim_{h \rightarrow 0^-} \frac{g(h)-g(0)}{h} = \lim_{h \rightarrow 0^-} \frac{h^{1/3}-0}{h} = \lim_{h \rightarrow 0^-} \frac{1}{h^{2/3}} = +\infty;$
 Right-hand derivative: $\lim_{h \rightarrow 0^+} \frac{g(h)-g(0)}{h} = \lim_{h \rightarrow 0^+} \frac{h^{2/3}-0}{h} = \lim_{h \rightarrow 0^+} \frac{1}{h^{1/3}} = +\infty;$
 Then $\lim_{h \rightarrow 0^-} \frac{g(h)-g(0)}{h} \neq \lim_{h \rightarrow 0^+} \frac{g(h)-g(0)}{h} = +\infty \Rightarrow$ the derivative $g'(0)$ does not exist.

43. (a) The function is differentiable on its domain $-3 \leq x \leq 2$ (it is smooth)
 (b) none
 (c) none

44. (a) The function is differentiable on its domain $-2 \leq x \leq 3$ (it is smooth)
 (b) none
 (c) none

45. (a) The function is differentiable on $-3 \leq x < 0$ and $0 < x \leq 3$
 (b) none
 (c) The function is neither continuous nor differentiable at $x = 0$ since $\lim_{h \rightarrow 0^-} f(x) \neq \lim_{h \rightarrow 0^+} f(x)$

46. (a) f is differentiable on $-2 \leq x < -1, -1 < x < 0, 0 < x < 2,$ and $2 < x \leq 3$
 (b) f is continuous but not differentiable at $x = -1$: $\lim_{x \rightarrow -1} f(x) = 0$ exists but there is a corner at $x = -1$ since
 $\lim_{h \rightarrow 0^-} \frac{f(-1+h)-f(-1)}{h} = -3$ and $\lim_{h \rightarrow 0^+} \frac{f(-1+h)-f(-1)}{h} = 3 \Rightarrow f'(-1)$ does not exist
 (c) f is neither continuous nor differentiable at $x = 0$ and $x = 2$:
 at $x = 0, \lim_{x \rightarrow 0^-} f(x) = 3$ but $\lim_{x \rightarrow 0^+} f(x) = 0 \Rightarrow \lim_{x \rightarrow 0} f(x)$ does not exist;
 at $x = 2, \lim_{x \rightarrow 2} f(x)$ exists but $\lim_{x \rightarrow 2} f(x) \neq f(2)$

47. (a) f is differentiable on $-1 \leq x < 0$ and $0 < x \leq 2$
 (b) f is continuous but not differentiable at $x = 0$: $\lim_{x \rightarrow 0} f(x) = 0$ exists but there is a cusp at $x = 0,$
 so $f'(0) = \lim_{h \rightarrow 0} \frac{f(0+h)-f(0)}{h}$ does not exist
 (c) none

48. (a) f is differentiable on $-3 \leq x < -2$, $-2 < x < 2$, and $2 < x \leq 3$
 (b) f is continuous but not differentiable at $x = -2$ and $x = 2$: there are corners at those points
 (c) none

49. (a) $f'(x) = \lim_{h \rightarrow 0} \frac{f(x+h)-f(x)}{h} = \lim_{h \rightarrow 0} \frac{-(x+h)^2 - (-x^2)}{h} = \lim_{h \rightarrow 0} \frac{-x^2 - 2xh - h^2 + x^2}{h} = \lim_{h \rightarrow 0} (-2x - h) = -2x$
 (b)

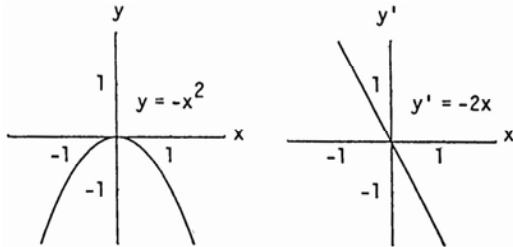

- (c) $y' = -2x$ is positive for $x < 0$, y' is zero when $x = 0$, y' is negative when $x > 0$
 (d) $y = -x^2$ is increasing for $-\infty < x < 0$ and decreasing for $0 < x < \infty$; the function is increasing on intervals where $y' > 0$ and decreasing on intervals where $y' < 0$

50. (a) $f'(x) = \lim_{h \rightarrow 0} \frac{f(x+h)-f(x)}{h} = \lim_{h \rightarrow 0} \frac{\left(\frac{-1}{x+h} - \frac{-1}{x}\right)}{h} = \lim_{h \rightarrow 0} \frac{-x+(x+h)}{x(x+h)h} = \lim_{h \rightarrow 0} \frac{1}{x(x+h)} = \frac{1}{x^2}$
 (b)

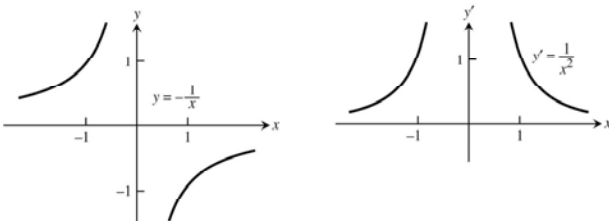

- (c) y' is positive for all $x \neq 0$, y' is never 0, y' is never negative
 (d) $y = -\frac{1}{x}$ is increasing for $-\infty < x < 0$ and $0 < x < \infty$

51. (a) Using the alternate formula for calculating derivatives: $f'(x) = \lim_{z \rightarrow x} \frac{f(z)-f(x)}{z-x} = \lim_{z \rightarrow x} \frac{\left(\frac{z^3}{3} - \frac{x^3}{3}\right)}{z-x} = \lim_{z \rightarrow x} \frac{z^3 - x^3}{3(z-x)}$
 $= \lim_{z \rightarrow x} \frac{(z-x)(z^2 + zx + x^2)}{3(z-x)} = \lim_{z \rightarrow x} \frac{z^2 + zx + x^2}{3} = x^2 \Rightarrow f'(x) = x^2$
 (b)

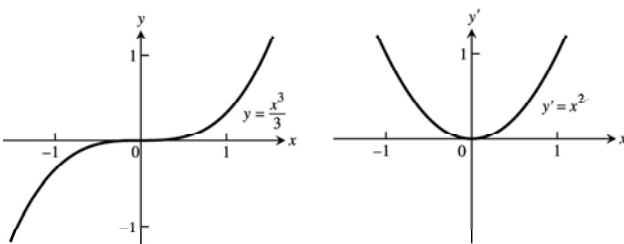

- (c) y' is positive for all $x \neq 0$, and $y' = 0$ when $x = 0$; y' is never negative
 (d) $y = \frac{x^3}{3}$ is increasing for all $x \neq 0$ (the graph is horizontal at $x = 0$) because y is increasing where $y' > 0$; y is never decreasing

52. (a) Using the alternate form for calculating derivatives: $f'(x) = \lim_{z \rightarrow x} \frac{f(z) - f(x)}{z - x} = \lim_{z \rightarrow x} \frac{\left(\frac{z^4 - x^4}{4}\right)}{z - x}$
 $= \lim_{z \rightarrow x} \frac{z^4 - x^4}{4(z - x)} = \lim_{z \rightarrow x} \frac{(z - x)(z^3 + xz^2 + x^2z + x^3)}{4(z - x)} = \lim_{z \rightarrow x} \frac{z^3 + xz^2 + x^2z + x^3}{4} = x^3 \Rightarrow f'(x) = x^3$

(b)

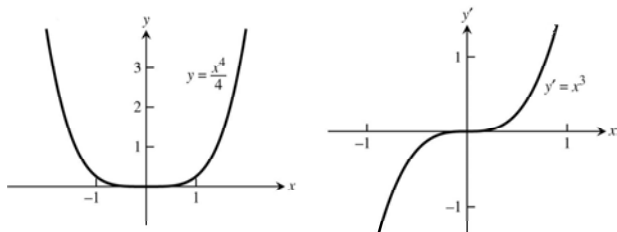

(c) y' is positive for $x > 0$, y' is zero for $x = 0$, y' is negative for $x < 0$

(d) $y = \frac{x^4}{4}$ is increasing on $0 < x < \infty$ and decreasing on $-\infty < x < 0$

53. $y' = \lim_{h \rightarrow 0} \frac{(2(x+h)^2 - 13(x+h) + 5) - (2x^2 - 13x + 5)}{h} = \lim_{h \rightarrow 0} \frac{2x^2 + 4xh + 2h^2 - 13x - 13h + 5 - 2x^2 + 13x - 5}{h} = \lim_{h \rightarrow 0} \frac{4xh + 2h^2 - 13h}{h}$
 $= \lim_{h \rightarrow 0} (4x + 2h - 13) = 4x - 13$, slope at x . The slope is -1 when $4x - 13 = -1 \Rightarrow 4x = 12 \Rightarrow x = 3$
 $\Rightarrow y = 2 \cdot 3^2 - 13 \cdot 3 + 5 = -16$. Thus the tangent line is $y + 16 = (-1)(x - 3) \Rightarrow y = -x - 13$ and the point of tangency is $(3, -16)$.

54. For the curve $y = \sqrt{x}$, we have $y' = \lim_{h \rightarrow 0} \frac{(\sqrt{x+h} - \sqrt{x})}{h} \cdot \frac{(\sqrt{x+h} + \sqrt{x})}{(\sqrt{x+h} + \sqrt{x})} = \lim_{h \rightarrow 0} \frac{(x+h) - x}{(\sqrt{x+h} + \sqrt{x})h} = \lim_{h \rightarrow 0} \frac{1}{\sqrt{x+h} + \sqrt{x}} = \frac{1}{2\sqrt{x}}$.

Suppose (a, \sqrt{a}) is the point of tangency of such a line and $(-1, 0)$ is the point on the line where it crosses the x -axis. Then the slope of the line is $\frac{\sqrt{a} - 0}{a - (-1)} = \frac{\sqrt{a}}{a + 1}$ which must also equal $\frac{1}{2\sqrt{a}}$; using the derivative formula at $x = a \Rightarrow \frac{\sqrt{a}}{a + 1} = \frac{1}{2\sqrt{a}} \Rightarrow 2a = a + 1 \Rightarrow a = 1$. Thus such a line does exist: its point of tangency is $(1, 1)$, its slope is $\frac{1}{2\sqrt{a}} = \frac{1}{2}$; and an equation of the line is $y - 1 = \frac{1}{2}(x - 1) \Rightarrow y = \frac{1}{2}x + \frac{1}{2}$.

55. Yes; the derivative of $-f$ is $-f'$ so that $f'(x_0)$ exists $\Rightarrow -f'(x_0)$ exists as well.

56. Yes; the derivative of $3g$ is $3g'$ so that $g'(7)$ exists $\Rightarrow 3g'(7)$ exists as well.

57. Yes, $\lim_{t \rightarrow 0} \frac{g(t)}{h(t)}$ can exist but it need not equal zero. For example, let $g(t) = mt$ and $h(t) = t$. Then $g(0) = h(0) = 0$, but $\lim_{t \rightarrow 0} \frac{g(t)}{h(t)} = \lim_{t \rightarrow 0} \frac{mt}{t} = \lim_{t \rightarrow 0} m = m$, which need not be zero.

58. (a) Suppose $|f(x)| \leq x^2$ for $-1 \leq x \leq 1$. Then $|f(0)| \leq 0^2 \Rightarrow f(0) = 0$. Then $f'(0) = \lim_{h \rightarrow 0} \frac{f(0+h) - f(0)}{h}$
 $= \lim_{h \rightarrow 0} \frac{f(h) - 0}{h} = \lim_{h \rightarrow 0} \frac{f(h)}{h}$. For $|h| \leq 1, -h^2 \leq f(h) \leq h^2 \Rightarrow -h \leq \frac{f(h)}{h} \leq h \Rightarrow f'(0) = \lim_{h \rightarrow 0} \frac{f(h)}{h} = 0$ by the

Sandwich Theorem for limits.

(b) Note that for $x \neq 0$,

$|f(x)| = |x^2 \sin \frac{1}{x}| = |x^2| |\sin \frac{1}{x}| \leq |x^2| \cdot 1 = x^2$ (since $-1 \leq \sin x \leq 1$). By part (a), f is differentiable at $x = 0$ and $f'(0) = 0$.

59. The graphs are shown below for $h = 1, 0.5, 0.1$. The function $y = \frac{1}{2\sqrt{x}}$ is the derivative of the function $y = \sqrt{x}$ so that $\frac{1}{2\sqrt{x}} = \lim_{h \rightarrow 0} \frac{\sqrt{x+h} - \sqrt{x}}{h}$. The graphs reveal that $y = \frac{\sqrt{x+h} - \sqrt{x}}{h}$ gets closer to $y = \frac{1}{2\sqrt{x}}$ as h gets smaller and smaller.

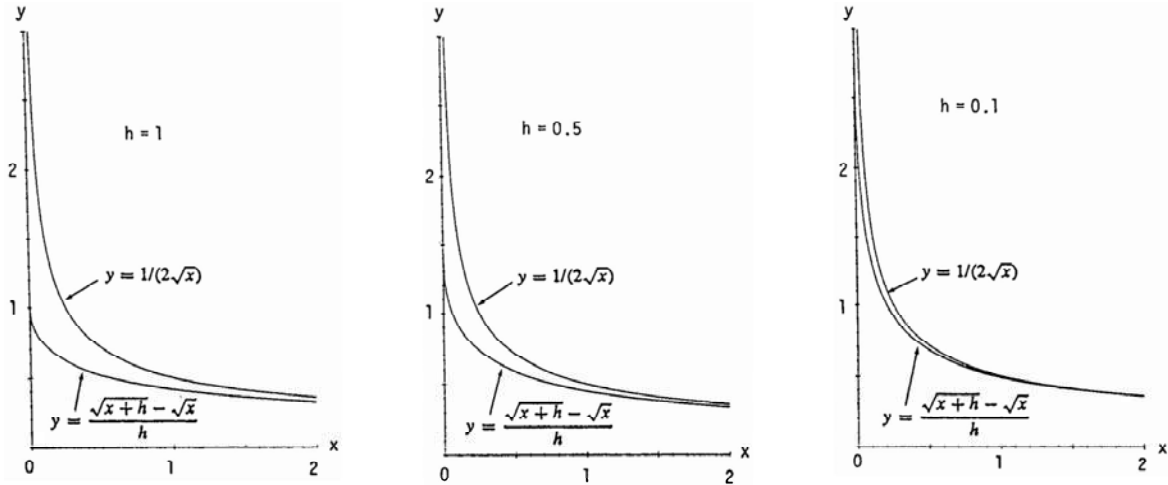

60. The graphs are shown below for $h = 2, 1, 0.5$. The function $y = 3x^2$ is the derivative of the function $y = x^3$ so that $3x^2 = \lim_{h \rightarrow 0} \frac{(x+h)^3 - x^3}{h}$. The graphs reveal that $y = \frac{(x+h)^3 - x^3}{h}$ gets closer to $y = 3x^2$ as h gets smaller and smaller.

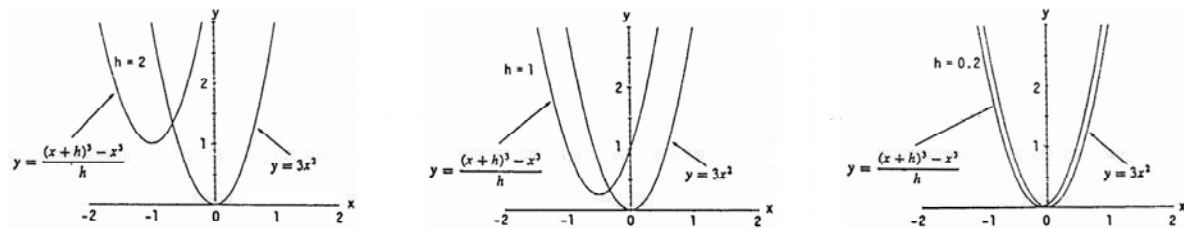

61. The graphs are the same. So we know that for $f(x) = |x|$, we have $f'(x) = \frac{|x|}{x}$.

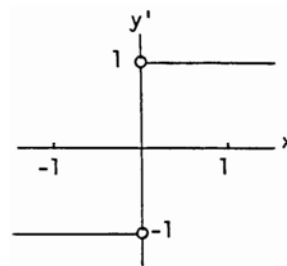

62. Weierstrass's nowhere differentiable continuous function.

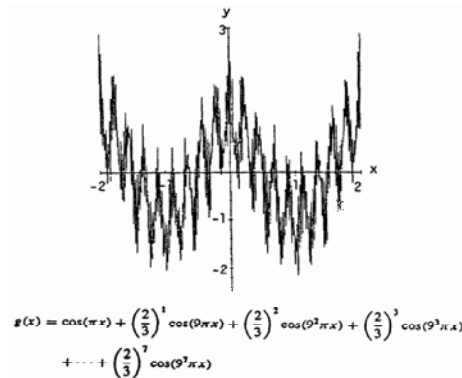

63-68. Example CAS commands:

Maple:

```
f := x -> x^3 + x^2 - x;
x0 := 1;
plot( f(x), x=x0-5..x0+2, color=black,
      title="Section 3.2, #63(a)");
q := unapply( f(x+h)-f(x))/h, (x,h) );          # (b)
L := limit( q(x,h), h=0 );                      # (c)
m := eval( L, x=x0 );
tan_line := f(x0) + m*(x-x0);
plot( [f(x),tan_line], x=x0-2..x0+3, color=black,
      linestyle=[1, 7], title="Section 3.2 #63(d)",
      legend=["y=f(x)", "Tangent line at x=1"] );
Xvals := sort( [x0+2^(-k) $ k=0..5, x0-2^(-k) $ k=0..5 ] ); # (e)
Yvals := map( f, Xvals );
evalf[4]( <convert(Xvals,Matrix) , convert(Yvals,Matrix) > );
plot( L, x=x0-5..x0+3, color=black, title="Section 3.2 #63(f)");
```

Mathematica: (functions and x0 may vary) (see section 2.5 re. RealOnly):

```
<<Miscellaneous`RealOnly`
Clear[f, m, x, y, h]
x0= pi/4;
f[x_]:=x^2Cos[x]
Plot[f[x], {x, x0-3, x0+3}]
q[x_,h_]:= (f[x+h]-f[x])/h
m[x_]:=Limit[q[x,h], h -> 0]
ytan:=f[x0]+m[x0](x-x0)
Plot[{f[x], ytan}, {x, x0-3, x0+3}]
m[x0-1]/N
m[x0+1]/N
Plot[{f[x], m[x]}, {x, x0-3, x0+3}]
```

3.3 DIFFERENTIATION RULES

- $y = -x^2 + 3 \Rightarrow \frac{dy}{dx} = \frac{d}{dx}(-x^2) + \frac{d}{dx}(3) = -2x + 0 = -2x \Rightarrow \frac{d^2y}{dx^2} = -2$
- $y = x^2 + x + 8 \Rightarrow \frac{dy}{dx} = 2x + 1 + 0 = 2x + 1 \Rightarrow \frac{d^2y}{dx^2} = 2$
- $s = 5t^3 - 3t^5 \Rightarrow \frac{ds}{dt} = \frac{d}{dt}(5t^3) - \frac{d}{dt}(3t^5) = 15t^2 - 15t^4 \Rightarrow \frac{d^2s}{dt^2} = \frac{d}{dt}(15t^2) - \frac{d}{dt}(15t^4) = 30t - 60t^3$
- $w = 3z^7 - 7z^3 + 21z^2 \Rightarrow \frac{dw}{dz} = 21z^6 - 21z^2 + 42z \Rightarrow \frac{d^2w}{dz^2} = 126z^5 - 42z + 42$
- $y = \frac{4}{3}x^3 - x + 2e^x \Rightarrow \frac{dy}{dx} = 4x^2 - 1 + 2e^x \Rightarrow \frac{d^2y}{dx^2} = 8x + 2e^x$

6. $y = \frac{x^3}{3} + \frac{x^2}{2} + e^{-x} \Rightarrow \frac{dy}{dx} = x^2 + x + e^{-x} \Rightarrow \frac{d^2y}{dx^2} = 2x + 1 + e^{-x}$ NOTE: $\frac{dy}{dx}(e^{-x}) = -e^{-x}$ from Example 8(b).
7. $w = 3z^{-2} - z^{-1} \Rightarrow \frac{dw}{dz} = -6z^{-3} + z^{-2} = \frac{-6}{z^3} + \frac{1}{z^2} \Rightarrow \frac{d^2w}{dz^2} = 18z^{-4} - 2z^{-3} = \frac{18}{z^4} - \frac{2}{z^3}$
8. $s = -2t^{-1} + 4t^{-2} \Rightarrow \frac{ds}{dt} = 2t^{-2} - 8t^{-3} = \frac{2}{t^2} - \frac{8}{t^3} \Rightarrow \frac{d^2s}{dt^2} = -4t^{-3} + 24t^{-4} = \frac{-4}{t^3} + \frac{24}{t^4}$
9. $y = 6x^2 - 10x - 5x^{-2} \Rightarrow \frac{dy}{dx} = 12x - 10 + 10x^{-3} = 12x - 10 + \frac{10}{x^3} \Rightarrow \frac{d^2y}{dx^2} = 12 - 0 - 30x^{-4} = 12 - \frac{30}{x^4}$
10. $y = 4 - 2x - x^{-3} \Rightarrow \frac{dy}{dx} = -2 + 3x^{-4} = -2 + \frac{3}{x^4} \Rightarrow \frac{d^2y}{dx^2} = 0 - 12x^{-5} = \frac{-12}{x^5}$
11. $r = \frac{1}{3}s^{-2} - \frac{5}{2}s^{-1} \Rightarrow \frac{dr}{ds} = -\frac{2}{3}s^{-3} + \frac{5}{2}s^{-2} = \frac{-2}{3s^3} + \frac{5}{2s^2} \Rightarrow \frac{d^2r}{ds^2} = 2s^{-4} - 5s^{-3} = \frac{2}{s^4} - \frac{5}{s^3}$
12. $r = 12\theta^{-1} - 4\theta^{-3} + \theta^{-4} \Rightarrow \frac{dr}{d\theta} = -12\theta^{-2} + 12\theta^{-4} - 4\theta^{-5} = \frac{-12}{\theta^2} + \frac{12}{\theta^4} - \frac{4}{\theta^5} \Rightarrow \frac{d^2r}{d\theta^2} = 24\theta^{-3} - 48\theta^{-5} + 20\theta^{-6}$
 $= \frac{24}{\theta^3} - \frac{48}{\theta^5} + \frac{20}{\theta^6}$
13. (a) $y = (3-x^2)(x^3-x+1) \Rightarrow y' = (3-x^2) \cdot \frac{d}{dx}(x^3-x+1) + (x^3-x+1) \cdot \frac{d}{dx}(3-x^2)$
 $= (3-x^2)(3x^2-1) + (x^3-x+1)(-2x) = -5x^4 + 12x^2 - 2x - 3$
 (b) $y = -x^5 + 4x^3 - x^2 - 3x + 3 \Rightarrow y' = -5x^4 + 12x^2 - 2x - 3$
14. (a) $y = (2x+3)(5x^2-4x) \Rightarrow y' = (2x+3)(10x-4) + (5x^2-4x)(2) = 30x^2 + 14x - 12$
 (b) $y = (2x+3)(5x^2-4x) = 10x^3 + 7x^2 - 12x \Rightarrow y' = 30x^2 + 14x - 12$
15. (a) $y = (x^2+1)(x+5+\frac{1}{x}) \Rightarrow y' = (x^2+1) \cdot \frac{d}{dx}(x+5+\frac{1}{x}) + (x+5+\frac{1}{x}) \cdot \frac{d}{dx}(x^2+1)$
 $= (x^2+1)(1-x^{-2}) + (x+5+x^{-1})(2x) = (x^2-1+1-x^{-2}) + (2x^2+10x+2) = 3x^2 + 10x + 2 - \frac{1}{x^2}$
 (b) $y = x^3 + 5x^2 + 2x + 5 + \frac{1}{x} \Rightarrow y' = 3x^2 + 10x + 2 - \frac{1}{x^2}$
16. $y = (1+x^2)(x^{3/4} - x^{-3})$
 (a) $y' = (1+x^2) \cdot \left(\frac{3}{4}x^{-1/4} + 3x^{-4}\right) + (x^{3/4} - x^{-3})(2x) = \frac{3}{4x^{1/4}} + \frac{3}{x^4} + \frac{11}{4}x^{7/4} + \frac{1}{x^2}$
 (b) $y = x^{3/4} - x^{-3} + x^{11/4} - x^{-1} \Rightarrow y' = \frac{3}{4x^{1/4}} + \frac{3}{x^4} + \frac{11}{4}x^{7/4} + \frac{1}{x^2}$
17. $y = \frac{2x+5}{3x-2}$; use the quotient rule: $u = 2x + 5$ and $v = 3x - 2 \Rightarrow u' = 2$ and $v' = 3 \Rightarrow y' = \frac{vu' - uv'}{v^2} = \frac{(3x-2)(2) - (2x+5)(3)}{(3x-2)^2}$
 $= \frac{6x-4-6x-15}{(3x-2)^2} = \frac{-19}{(3x-2)^2}$
18. $y = \frac{4-3x}{3x^2+x}$; use the quotient rule: $u = 4 - 3x$ and $v = 3x^2 + x \Rightarrow u' = -3$ and $v' = 6x + 1 \Rightarrow y' = \frac{vu' - uv'}{v^2}$
 $= \frac{(3x^2+x)(-3) - (4-3x)(6x+1)}{(3x^2+x)^2} = \frac{-9x^2-3x+18x^2-21x-4}{(3x^2+x)^2} = \frac{9x^2-24x-4}{(3x^2+x)^2}$
19. $g(x) = \frac{x^2-4}{x+0.5}$; use the quotient rule: $u = x^2 - 4$ and $v = x + 0.5 \Rightarrow u' = 2x$ and $v' = 1 \Rightarrow g'(x) = \frac{vu' - uv'}{v^2}$
 $= \frac{(x+0.5)(2x) - (x^2-4)(1)}{(x+0.5)^2} = \frac{2x^2+x-x^2+4}{(x+0.5)^2} = \frac{x^2+x+4}{(x+0.5)^2}$

$$20. f(t) = \frac{t^2-1}{t^2+t-2} = \frac{(t-1)(t+1)}{(t+2)(t-1)} = \frac{t+1}{t+2}, t \neq -1 \Rightarrow f'(t) = \frac{(t+2)(1)-(t+1)(1)}{(t+2)^2} = \frac{t+2-t-1}{(t+2)^2} = \frac{1}{(t+2)^2}$$

$$21. v = (1-t)(1+t^2)^{-1} = \frac{1-t}{1+t^2} \Rightarrow \frac{dv}{dt} = \frac{(1+t^2)(-1)-(1-t)(2t)}{(1+t^2)^2} = \frac{-1-t^2-2t+2t^2}{(1+t^2)^2} = \frac{t^2-2t-1}{(1+t^2)^2}$$

$$22. w = \frac{x+5}{2x-7} \Rightarrow w' = \frac{(2x-7)(1)-(x+5)(2)}{(2x-7)^2} = \frac{2x-7-2x-10}{(2x-7)^2} = \frac{-17}{(2x-7)^2}$$

$$23. f(s) = \frac{\sqrt{s}-1}{\sqrt{s}+1} \Rightarrow f'(s) = \frac{(\sqrt{s}+1)\left(\frac{1}{2\sqrt{s}}\right) - (\sqrt{s}-1)\left(\frac{1}{2\sqrt{s}}\right)}{(\sqrt{s}+1)^2} = \frac{(\sqrt{s}+1) - (\sqrt{s}-1)}{2\sqrt{s}(\sqrt{s}+1)^2} = \frac{1}{\sqrt{s}(\sqrt{s}+1)^2}$$

NOTE: $\frac{d}{ds}(\sqrt{s}) = \frac{1}{2\sqrt{s}}$ from Example 2 in Section 3.2

$$24. u = \frac{5x+1}{2\sqrt{x}} \Rightarrow \frac{du}{dx} = \frac{(2\sqrt{x})(5)-(5x+1)\left(\frac{1}{\sqrt{x}}\right)}{4x} = \frac{5x-1}{4x^{3/2}}$$

$$25. v = \frac{1+x-4\sqrt{x}}{x} \Rightarrow v' = \frac{x\left(1-\frac{2}{\sqrt{x}}\right) - (1+x-4\sqrt{x})}{x^2} = \frac{2\sqrt{x}-1}{x^2}$$

$$26. r = 2\left(\frac{1}{\sqrt{\theta}} + \sqrt{\theta}\right) \Rightarrow r' = 2\left(\frac{\sqrt{\theta}(0) - 1\left(\frac{1}{2\sqrt{\theta}}\right)}{\theta} + \frac{1}{2\sqrt{\theta}}\right) = -\frac{1}{\theta^{3/2}} + \frac{1}{\theta^{1/2}}$$

$$27. y = \frac{1}{(x^2-1)(x^2+x+1)}; \text{ use the quotient rule: } u = 1 \text{ and } v = (x^2-1)(x^2+x+1) \Rightarrow u' = 0 \text{ and}$$

$$v' = (x^2-1)(2x+1) + (x^2+x+1)(2x) = 2x^3+x^2-2x-1+2x^3+2x^2+2x = 4x^3+3x^2-1 \Rightarrow \frac{dy}{dx} = \frac{vu' - uv'}{v^2} \\ = \frac{0 - 1(4x^3+3x^2-1)}{(x^2-1)^2(x^2+x+1)^2} = \frac{-4x^3-3x^2+1}{(x^2-1)^2(x^2+x+1)^2}$$

$$28. y = \frac{(x+1)(x+2)}{(x-1)(x-2)} = \frac{x^2+3x+2}{x^2-3x+2} \Rightarrow y' = \frac{(x^2-3x+2)(2x+3) - (x^2+3x+2)(2x-3)}{(x-1)^2(x-2)^2} = \frac{-6x^2+12}{(x-1)^2(x-2)^2} = \frac{-6(x^2-2)}{(x-1)^2(x-2)^2}$$

$$29. y = 2e^{-x} + e^{3x} = 2e^{-x} + e^{2x} \cdot e^x \Rightarrow y' = 2(-e^{-x}) + e^{2x} \cdot e^x + e^x \cdot (2e^{2x}) \Rightarrow y' = -2e^{-x} + 3e^{3x}$$

NOTE: $\frac{d}{dx}(e^{2x}) = 2e^{2x}$ from part b of Example 6 and $\frac{d}{dx}(e^{-x}) = -e^{-x}$ from part b of Example 8

$$30. y = \frac{x^2+3e^x}{2e^x-x} \Rightarrow y' = \frac{(2e^x-x)(2x+3e^x) - (x^2+3e^x)(2e^x-1)}{(2e^x-x)^2} = \frac{(4xe^x+6e^{2x}-2x^2-3xe^x) - (2x^2e^x-x^2+6e^{2x}-3e^x)}{(2e^x-x)^2} \\ y' = \frac{xe^x-x^2-2x^2e^x+3e^x}{(2e^x-x)^2}$$

$$31. y = x^3e^x \Rightarrow y' = x^3 \cdot e^x + 3x^2 \cdot e^x = (x^3 + 3x^2)e^x$$

$$32. w = re^{-r} \Rightarrow w' = r \cdot e^{-r}(-1) + (1) \cdot e^{-r} = (1-r)e^{-r}$$

$$33. y = x^{9/4} + e^{-2x} = x^{9/4} + \frac{1}{e^{2x}} \Rightarrow y' = \frac{9}{4}x^{5/4} + \frac{e^{2x} \cdot 0 - 1(2e^{2x})}{(e^{2x})^2} \Rightarrow y' = \frac{9}{4}x^{5/4} - 2e^{-2x}$$

NOTE: $\frac{d}{dx}(e^{2x}) = 2e^{2x}$ from part b of Example 6

$$34. y = x^{-3/5} + \pi^{3/2} \Rightarrow y' = -\frac{3}{5}x^{-8/5} + 0 \Rightarrow y' = -\frac{3}{5}x^{-8/5}$$

$$35. s = 2t^{3/2} + 3e^2 \Rightarrow s' = 3t^{1/2} + 0 \Rightarrow s' = 3t^{1/2}$$

$$36. w = \frac{1}{z^{1/4}} + \frac{\pi}{\sqrt{z}} = z^{-1/4} + \pi z^{-1/2} \Rightarrow w' = -1.4z^{-2.4} - \frac{\pi}{2}z^{-3/2} \Rightarrow w' = -\frac{1.4}{z^{2.4}} - \frac{\pi}{2z^{3/2}}$$

$$37. y = \sqrt[7]{x^2} - x^e = x^{2/7} - x^e \Rightarrow y' = \frac{2}{7}x^{-5/7} - ex^{e-1} \Rightarrow y' = \frac{2}{7x^{5/7}} - ex^{e-1}$$

$$38. y = \sqrt[3]{x^{9.6}} + 2e^{1.3} = x^{9.6/3} + 2e^{1.3} = x^{3.2} + 2e^{1.3} \Rightarrow y' = 3.2x^{2.2} + 0 \Rightarrow y' = 3.2x^{2.2}$$

$$39. r = \frac{e^s}{s} \Rightarrow r' = \frac{s \cdot e^s - e^s(1)}{s^2} \Rightarrow r' = \frac{e^s(s-1)}{s^2}$$

$$40. r = e^\theta \left(\frac{1}{\theta^2} + \theta^{-\pi/2} \right) = e^\theta (\theta^{-2} + \theta^{-\pi/2}) \Rightarrow r' = e^\theta \left(-2\theta^{-3} - \frac{\pi}{2}\theta^{-\pi/2-1} \right) + (\theta^{-2} + \theta^{-\pi/2})e^\theta$$

$$\Rightarrow r' = e^\theta \left(-2\theta^{-3} - \frac{\pi}{2}\theta^{-\pi/2} + \theta^{-2} + \theta^{-\pi/2} \right) \Rightarrow r' = e^\theta \left(-\frac{2}{\theta^3} - \frac{\pi}{2\theta^{\pi/2+1}} + \frac{1}{\theta^2} + \frac{1}{\theta^{\pi/2}} \right)$$

$$\Rightarrow r' = e^\theta \left(\frac{\theta-2}{\theta^3} + \frac{2\theta-\pi}{2\theta^{\pi/2+1}} \right)$$

$$41. y = \frac{1}{2}x^4 - \frac{3}{2}x^2 - x \Rightarrow y' = 2x^3 - 3x - 1 \Rightarrow y'' = 6x^2 - 3 \Rightarrow y''' = 12x \Rightarrow y^{(4)} = 12 \Rightarrow y^{(n)} = 0 \text{ for all } n \geq 5$$

$$42. y = \frac{1}{120}x^5 \Rightarrow y' = \frac{1}{24}x^4 \Rightarrow y'' = \frac{1}{6}x^3 \Rightarrow y''' = \frac{1}{2}x^2 \Rightarrow y^{(4)} = x \Rightarrow y^{(5)} = 1 \Rightarrow y^{(n)} = 0 \text{ for all } n \geq 6$$

$$43. y = (x-1)(x+2)(x+3) = y' = (x+2)(x+3) + (x-1)(x+3) + (x-1)(x+2) = x^2 + 5x + 6 + x^2 + 2x - 3 + x^2 + x - 2 = 3x^2 + 8x + 1 \Rightarrow y'' = 6x + 8 \Rightarrow y''' = 6 \Rightarrow y^{(n)} = 0 \text{ for } n \geq 4.$$

$$44. y = (4x^3 + 3x)(2-x)x = (-4x^3 + 8x^2 - 3x + 6)x = -4x^4 + 8x^3 - 3x^2 + 6x \Rightarrow y' = -16x^3 + 24x^2 - 6x + 6 \Rightarrow y'' = -48x^2 + 48x - 6 \Rightarrow y''' = -96x + 48 \Rightarrow y^{(4)} = -96 \Rightarrow y^{(n)} = 0 \text{ for } n \geq 5$$

$$45. y = \frac{x^3+7}{x} = x^2 + 7x^{-1} \Rightarrow \frac{dy}{dx} = 2x - 7x^{-2} = 2x - \frac{7}{x^2} \Rightarrow \frac{d^2y}{dx^2} = 2 + 14x^{-3} = 2 + \frac{14}{x^3}$$

$$46. s = \frac{t^2+5t-1}{t^2} = 1 + \frac{5}{t} - \frac{1}{t^2} = 1 + 5t^{-1} - t^{-2} \Rightarrow \frac{ds}{dt} = 0 - 5t^{-2} + 2t^{-3} = -5t^{-2} + 2t^{-3} = \frac{-5}{t^2} + \frac{2}{t^3}$$

$$\Rightarrow \frac{d^2s}{dt^2} = 10t^{-3} - 6t^{-4} = \frac{10}{t^3} - \frac{6}{t^4}$$

$$47. r = \frac{(\theta-1)(\theta^2+\theta+1)}{\theta^3} = \frac{\theta^3-1}{\theta^3} = 1 - \frac{1}{\theta^3} = 1 - \theta^{-3} \Rightarrow \frac{dr}{d\theta} = 0 + 3\theta^{-4} = 3\theta^{-4} = \frac{3}{\theta^4} \Rightarrow \frac{d^2r}{d\theta^2} = -12\theta^{-5} = \frac{-12}{\theta^5}$$

48. $u = \frac{(x^2+x)(x^2-x+1)}{x^4} = \frac{x(x+1)(x^2-x+1)}{x^4} = \frac{x(x^3+1)}{x^4} = \frac{x^4+x}{x^4} = 1 + \frac{x}{x^4} = 1 + x^{-3}$
 $\Rightarrow \frac{du}{dx} = 0 - 3x^{-4} = -3x^{-4} = -\frac{3}{x^4} \Rightarrow \frac{d^2u}{dx^2} = 12x^{-5} = \frac{12}{x^5}$
49. $w = \left(\frac{1+3z}{3z}\right)(3-z) = \left(\frac{1}{3}z^{-1} + 1\right)(3-z) = z^{-1} - \frac{1}{3} + 3 - z = z^{-1} + \frac{8}{3} - z \Rightarrow \frac{dw}{dz} = -z^{-2} + 0 - 1 = -z^{-2} - 1 = -\frac{1}{z^2} - 1$
 $\Rightarrow \frac{d^2w}{dz^2} = 2z^{-3} - 0 = 2z^{-3} = \frac{2}{z^3}$
50. $p = \frac{q^2+3}{(q-1)^3+(q+1)^3} = \frac{q^2+3}{(q^3-3q^2+3q-1)+(q^3+3q^2+3q+1)} = \frac{q^2+3}{2q^3+6q} = \frac{q^2+3}{2q(q^2+3)} = \frac{1}{2q} = \frac{1}{2}q^{-1} \Rightarrow \frac{dp}{dq} = -\frac{1}{2}q^{-2} = -\frac{1}{2q^2}$
 $\Rightarrow \frac{d^2p}{dq^2} = q^{-3} = \frac{1}{q^3}$
51. $w = 3z^2e^{2z} \Rightarrow \frac{dw}{dz} = 3z^2(2e^{2z}) + 6ze^{2z} \Rightarrow \frac{dw}{dz} = 6ze^{2z}(1+z) \Rightarrow \frac{d^2w}{dz^2} = 6ze^{2z}(1) + (1+z)(6z(2e^{2z}) + 6e^{2z})$
 $\Rightarrow \frac{d^2w}{dz^2} = 6e^{2z}(1+4z+2z^2)$, NOTE: $\frac{d}{dz}(e^{2z}) = 2e^{2z}$ from part b of Example 6
52. $w = e^z(z-1)(z^2+1) = e^z(z^3-z^2+z-1) \Rightarrow w' = e^z \cdot (z^3-z^2+z-1) + (3z^2-2z+1) \cdot e^z = e^z(z^3+2z^2-z)$
and $w'' = e^z \cdot (z^3+2z^2-z) + (3z^2+4z-1) \cdot e^z = e^z(z^3+5z^2+3z-1)$
53. $u(0) = 5, u'(0) = -3, v(0) = -1, v'(0) = 2$
(a) $\frac{d}{dx}(uv) = uv' + vu' \Rightarrow \frac{d}{dx}(uv)\Big|_{x=0} = u(0)v'(0) + v(0)u'(0) = 5 \cdot 2 + (-1)(-3) = 13$
(b) $\frac{d}{dx}\left(\frac{u}{v}\right) = \frac{vu' - uv'}{v^2} \Rightarrow \frac{d}{dx}\left(\frac{u}{v}\right)\Big|_{x=0} = \frac{v(0)u'(0) - u(0)v'(0)}{(v(0))^2} = \frac{(-1)(-3) - (5)(2)}{(-1)^2} = -7$
(c) $\frac{d}{dx}\left(\frac{v}{u}\right) = \frac{uv' - vu'}{u^2} \Rightarrow \frac{d}{dx}\left(\frac{v}{u}\right)\Big|_{x=0} = \frac{u(0)v'(0) - v(0)u'(0)}{(u(0))^2} = \frac{(5)(2) - (-1)(-3)}{(5)^2} = \frac{7}{25}$
(d) $\frac{d}{dx}(7v - 2u) = 7v' - 2u' \Rightarrow \frac{d}{dx}(7v - 2u)\Big|_{x=0} = 7v'(0) - 2u'(0) = 7 \cdot 2 - 2(-3) = 20$
54. $u(1) = 2, u'(1) = 0, v(1) = 5, v'(1) = -1$
(a) $\frac{d}{dx}(uv)\Big|_{x=1} = u(1)v'(1) + v(1)u'(1) = 2 \cdot (-1) + 5 \cdot 0 = -2$
(b) $\frac{d}{dx}\left(\frac{u}{v}\right)\Big|_{x=1} = \frac{v(1)u'(1) - u(1)v'(1)}{(v(1))^2} = \frac{5 \cdot 0 - 2 \cdot (-1)}{(5)^2} = \frac{2}{25}$
(c) $\frac{d}{dx}\left(\frac{v}{u}\right)\Big|_{x=1} = \frac{u(1)v'(1) - v(1)u'(1)}{(u(1))^2} = \frac{2 \cdot (-1) - 5 \cdot 0}{(2)^2} = -\frac{1}{2}$
(d) $\frac{d}{dx}(7v - 2u)\Big|_{x=1} = 7v'(1) - 2u'(1) = 7 \cdot (-1) - 2 \cdot 0 = -7$
55. $y = x^3 - 4x + 1$. Note that (2, 1) is on the curve: $1 = 2^3 - 4(2) + 1$
(a) Slope of the tangent at (x, y) is $y' = 3x^2 - 4 \Rightarrow$ slope of the tangent at (2, 1) is $y'(2) = 3(2)^2 - 4 = 8$. Thus the slope of the line perpendicular to the tangent at (2, 1) is $-\frac{1}{8} \Rightarrow$ the equation of the line perpendicular to the tangent line at (2, 1) is $y - 1 = -\frac{1}{8}(x - 2)$ or $y = -\frac{x}{8} + \frac{5}{4}$.
(b) The slope of the curve at x is $m = 3x^2 - 4$ and the smallest value for m is -4 when $x = 0$ and $y = 1$.
(c) We want the slope of the curve to be 8 $\Rightarrow y' = 8 \Rightarrow 3x^2 - 4 = 8 \Rightarrow 3x^2 = 12 \Rightarrow x^2 = 4 \Rightarrow x = \pm 2$. When $x = 2, y = 1$ and the tangent line has equation $y - 1 = 8(x - 2)$ or $y = 8x - 15$; When $x = -2, y = (-2)^3 - 4(-2) + 1 = 1$, and the tangent line has equation $y - 1 = 8(x + 2)$ or $y = 8x + 17$.

56. (a) $y = x^3 - 3x - 2 \Rightarrow y' = 3x^2 - 3$. For the tangent to be horizontal, we need $m = y' = 0 \Rightarrow 0 = 3x^2 - 3$
 $\Rightarrow 3x^2 = 3 \Rightarrow x = \pm 1$. When $x = -1$, $y = 0 \Rightarrow$ the tangent line has equation $y = 0$. The line perpendicular to this line at $(-1, 0)$ is $x = -1$. When $x = 1$, $y = -4 \Rightarrow$ the tangent line has equation $y = -4$. The line perpendicular to this line at $(1, -4)$ is $x = 1$.
- (b) The smallest value of y' is -3 , and this occurs when $x = 0$ and $y = -2$. The tangent to the curve at $(0, -2)$ has slope $-3 \Rightarrow$ the line perpendicular to the tangent at $(0, -2)$ has slope $\frac{1}{3} \Rightarrow y + 2 = \frac{1}{3}(x - 0)$ or $y = \frac{1}{3}x - 2$ is an equation of the perpendicular line.
57. $y = \frac{4x}{x^2 + 1} \Rightarrow \frac{dy}{dx} = \frac{(x^2 + 1)(4) - (4x)(2x)}{(x^2 + 1)^2} = \frac{4x^2 + 4 - 8x^2}{(x^2 + 1)^2} = \frac{4(-x^2 + 1)}{(x^2 + 1)^2}$. When $x = 0$, $y = 0$ and $y' = \frac{4(0+1)}{1} = 4$, so the tangent to the curve at $(0, 0)$ is the line $y = 4x$. When $x = 1$, $y = 2 \Rightarrow y' = 0$, so the tangent to the curve at $(1, 2)$ is the line $y = 2$.
58. $y = \frac{8}{x^2 + 4} \Rightarrow y' = \frac{(x^2 + 4)(0) - 8(2x)}{(x^2 + 4)^2} = \frac{-16x}{(x^2 + 4)^2}$. When $x = 2$, $y = 1$ and $y' = \frac{-16(2)}{(2^2 + 4)^2} = -\frac{1}{2}$, so the tangent line to the curve at $(2, 1)$ has the equation $y - 1 = -\frac{1}{2}(x - 2)$, or $y = -\frac{x}{2} + 2$.
59. $y = ax^2 + bx + c$ passes through $(0, 0) \Rightarrow 0 = a(0) + b(0) + c \Rightarrow c = 0$; $y = ax^2 + bx$ passes through $(1, 2) \Rightarrow 2 = a + b$; $y' = 2ax + b$ and since the curve is tangent to $y = x$ at the origin, its slope is 1 at $x = 0 \Rightarrow y' = 1$ when $x = 0 \Rightarrow 1 = 2a(0) + b \Rightarrow b = 1$. Then $a + b = 2 \Rightarrow a = 1$. In summary $a = b = 1$ and $c = 0$ so the curve is $y = x^2 + x$.
60. $y = cx - x^2$ passes through $(1, 0) \Rightarrow 0 = c(1) - 1 \Rightarrow c = 1 \Rightarrow$ the curve is $y = x - x^2$. For this curve, $y' = 1 - 2x$ and $x = 1 \Rightarrow y' = -1$. Since $y = x - x^2$ and $y = x^2 + ax + b$ have common tangents at $x = 1$, $y = x^2 + ax + b$ must also have slope -1 at $x = 1$. Thus $y' = 2x + a \Rightarrow -1 = 2 \cdot 1 + a \Rightarrow a = -3 \Rightarrow y = x^2 - 3x + b$. Since this last curve passes through $(1, 0)$, we have $0 = 1 - 3 + b \Rightarrow b = 2$. In summary, $a = -3$, $b = 2$ and $c = 1$ so the curves are $y = x^2 - 3x + 2$ and $y = x - x^2$.
61. $y = 8x + 5 \Rightarrow m = 8$; $f(x) = 3x^2 - 4x \Rightarrow f'(x) = 6x - 4$; $6x - 4 = 8 \Rightarrow x = 2 \Rightarrow f(2) = 3(2)^2 - 4(2) = 4 \Rightarrow (2, 4)$
62. $8x - 2y = 1 \Rightarrow y = 4x - \frac{1}{2} \Rightarrow m = 4$; $g(x) = \frac{1}{3}x^3 - \frac{3}{2}x^2 + 1 \Rightarrow g'(x) = x^2 - 3x$; $x^2 - 3x = 4 \Rightarrow x = 4$ or $x = -1$
 $\Rightarrow g(4) = \frac{1}{3}(4)^3 - \frac{3}{2}(4)^2 + 1 = -\frac{5}{3}$, $g(-1) = \frac{1}{3}(-1)^3 - \frac{3}{2}(-1)^2 + 1 = -\frac{5}{6} \Rightarrow (4, -\frac{5}{3})$ or $(-1, -\frac{5}{6})$
63. $y = 2x + 3 \Rightarrow m = 2 \Rightarrow m_{\perp} = -\frac{1}{2}$; $y = \frac{x}{x-2} \Rightarrow y' = \frac{(x-2)(1) - x(1)}{(x-2)^2} = \frac{-2}{(x-2)^2}$; $\frac{-2}{(x-2)^2} = -\frac{1}{2} \Rightarrow 4 = (x-2)^2$
 $\Rightarrow \pm 2 = x - 2 \Rightarrow x = 4$ or $x = 0 \Rightarrow$ if $x = 4$, $y = \frac{4}{4-2} = 2$, and if $x = 0$, $y = \frac{0}{0-2} = 0 \Rightarrow (4, 2)$ or $(0, 0)$.
64. $m = \frac{y-8}{x-3}$; $f(x) = x^2 \Rightarrow f'(x) = 2x$; $m = f'(x) \Rightarrow \frac{y-8}{x-3} = 2x \Rightarrow \frac{x^2-8}{x-3} = 2x \Rightarrow x^2 - 8 = 2x^2 - 6x \Rightarrow x^2 - 6x + 8 = 0$
 $\Rightarrow x = 4$ or $x = 2 \Rightarrow f(4) = 4^2 = 16$, $f(2) = 2^2 = 4 \Rightarrow (4, 16)$ or $(2, 4)$.
65. (a) $y = x^3 - x \Rightarrow y' = 3x^2 - 1$. When $x = -1$, $y = 0$ and $y' = 2 \Rightarrow$ the tangent line to the curve at $(-1, 0)$ is $y = 2(x + 1)$ or $y = 2x + 2$.

(b)

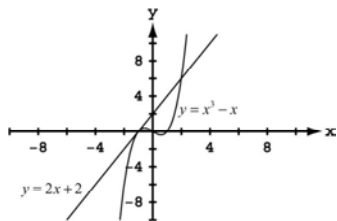

(c) $\left. \begin{matrix} y = x^3 - x \\ y = 2x + 2 \end{matrix} \right\} \Rightarrow x^3 - x = 2x + 2 \Rightarrow x^3 - 3x - 2 = (x - 2)(x + 1)^2 = 0 \Rightarrow x = 2 \text{ or } x = -1$. Since $y = 2(2) + 2 = 6$; the other intersection point is $(2, 6)$

66. (a) $y = x^3 - 6x^2 + 5x \Rightarrow y' = 3x^2 - 12x + 5$. When $x = 0$, $y = 0$ and $y' = 5 \Rightarrow$ the tangent line to the curve at $(0, 0)$ is $y = 5x$.

(b)

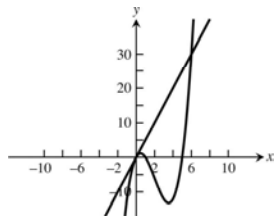

(c) $\left. \begin{matrix} y = x^3 - 6x^2 + 5x \\ y = 5x \end{matrix} \right\} \Rightarrow x^3 - 6x^2 + 5x = 5x \Rightarrow x^3 - 6x^2 = 0 \Rightarrow x^2(x - 6) = 0 \Rightarrow x = 0 \text{ or } x = 6$. Since $y = 5(6) = 30$, the other intersection point is $(6, 30)$.

67. $\lim_{x \rightarrow 1} \frac{x^{50} - 1}{x - 1} = 50x^{49} \Big|_{x=1} = 50(1)^{49} = 50$

68. $\lim_{x \rightarrow -1} \frac{x^{2/9} - 1}{x + 1} = \frac{2}{9} x^{-7/9} \Big|_{x=-1} = \frac{2}{9(-1)^{7/9}} = -\frac{2}{9}$

69. $g'(x) = \begin{cases} 2x - 3 & x > 0 \\ a & x < 0 \end{cases}$, since g is differentiable at $x = 0 \Rightarrow \lim_{x \rightarrow 0^+} (2x - 3) = -3$ and $\lim_{x \rightarrow 0^-} a = a \Rightarrow a = -3$

70. $f'(x) = \begin{cases} a & x > -1 \\ 2bx & x < -1 \end{cases}$, since f is differentiable at $x = -1 \Rightarrow \lim_{x \rightarrow -1^+} a = a$ and $\lim_{x \rightarrow -1^-} (2bx) = -2b \Rightarrow a = -2b$, and since f is continuous at $x = -1 \Rightarrow \lim_{x \rightarrow -1^+} (ax + b) = -a + b$ and $\lim_{x \rightarrow -1^-} (bx^2 - 3) = b - 3 \Rightarrow -a + b = b - 3 \Rightarrow a = 3 \Rightarrow 3 = -2b \Rightarrow b = -\frac{3}{2}$.

71. $P(x) = a_n x^n + a_{n-1} x^{n-1} + \dots + a_2 x^2 + a_1 x + a_0 \Rightarrow P'(x) = n a_n x^{n-1} + (n-1) a_{n-1} x^{n-2} + \dots + 2 a_2 x + a_1$

72. $R = M^2 \left(\frac{C}{2} - \frac{M}{3} \right) = \frac{C}{2} M^2 - \frac{1}{3} M^3$, where C is a constant $\Rightarrow \frac{dR}{dM} = CM - M^2$

73. Let c be a constant $\Rightarrow \frac{dc}{dx} = 0 \Rightarrow \frac{d}{dx}(u \cdot c) = u \cdot \frac{dc}{dx} + c \cdot \frac{du}{dx} = u \cdot 0 + c \frac{du}{dx} = c \frac{du}{dx}$. Thus when one of the functions is a constant, the Product Rule is just the Constant Multiple Rule \Rightarrow the Constant Multiple Rule is a special case of the Product Rule.

74. (a) We use the Quotient rule to derive the Reciprocal Rule (with $u = 1$): $\frac{d}{dx}\left(\frac{1}{v}\right) = \frac{v \cdot 0 - 1 \cdot \frac{dv}{dx}}{v^2} = \frac{-1 \cdot \frac{dv}{dx}}{v^2} = -\frac{1}{v^2} \cdot \frac{dv}{dx}$.

(b) Now, using the Reciprocal Rule and the Product Rule, we'll derive the Quotient Rule:

$$\frac{d}{dx}\left(\frac{u}{v}\right) = \frac{d}{dx}\left(u \cdot \frac{1}{v}\right) = u \cdot \frac{d}{dx}\left(\frac{1}{v}\right) + \frac{1}{v} \cdot \frac{du}{dx} \quad (\text{Product Rule}) = u \cdot \left(\frac{-1}{v^2}\right) \frac{dv}{dx} + \frac{1}{v} \frac{du}{dx} \quad (\text{Reciprocal Rule})$$

$$\Rightarrow \frac{d}{dx}\left(\frac{u}{v}\right) = \frac{-u \frac{dv}{dx} + v \frac{du}{dx}}{v^2} = \frac{v \frac{du}{dx} - u \frac{dv}{dx}}{v^2}, \quad \text{the Quotient Rule.}$$

75. (a) $\frac{d}{dx}(uvw) = \frac{d}{dx}((uv) \cdot w) = (uv) \frac{dw}{dx} + w \cdot \frac{d}{dx}(uv) = uv \frac{dw}{dx} + w \left(u \frac{dv}{dx} + v \frac{du}{dx}\right) = uv \frac{dw}{dx} + wu \frac{dv}{dx} + wv \frac{du}{dx}$
 $= uvw' + uv'w + u'vw$

(b) $\frac{d}{dx}(u_1 u_2 u_3 u_4) = \frac{d}{dx}((u_1 u_2 u_3) u_4) = (u_1 u_2 u_3) \frac{du_4}{dx} + u_4 \frac{d}{dx}(u_1 u_2 u_3)$
 $\Rightarrow \frac{d}{dx}(u_1 u_2 u_3 u_4) = u_1 u_2 u_3 \frac{du_4}{dx} + u_4 \left(u_1 u_2 \frac{du_3}{dx} + u_3 u_1 \frac{du_2}{dx} + u_3 u_2 \frac{du_1}{dx}\right)$ (using (a) above)

$$\Rightarrow \frac{d}{dx}(u_1 u_2 u_3 u_4) = u_1 u_2 u_3 \frac{du_4}{dx} + u_1 u_2 u_4 \frac{du_3}{dx} + u_1 u_3 u_4 \frac{du_2}{dx} + u_2 u_3 u_4 \frac{du_1}{dx}$$

$$= u_1 u_2 u_3 u_4' + u_1 u_2 u_3' u_4 + u_1 u_2' u_3 u_4 + u_1' u_2 u_3 u_4$$

(c) Generalizing (a) and (b) above, $\frac{d}{dx}(u_1 \cdots u_n) = u_1 u_2 \cdots u_{n-1} u_n' + u_1 u_2 \cdots u_{n-2} u_{n-1}' u_n + \cdots + u_1' u_2 \cdots u_n$

76. $\frac{d}{dx}(x^{-m}) = \frac{d}{dx}\left(\frac{1}{x^m}\right) = \frac{x^m \cdot 0 - 1(m \cdot x^{m-1})}{(x^m)^2} = \frac{-m \cdot x^{m-1}}{x^{2m}} = -m \cdot x^{m-1-2m} = -m \cdot x^{-m-1}$

77. $P = \frac{nRT}{V-nb} - \frac{an^2}{V^2}$. We are holding T constant, and a, b, n, R are also constant so their derivatives are zero

$$\Rightarrow \frac{dP}{dV} = \frac{(V-nb) \cdot 0 - (nRT)(1)}{(V-nb)^2} - \frac{V^2(0) - (an^2)(2V)}{(V^2)^2} = \frac{-nRT}{(V-nb)^2} + \frac{2an^2}{V^3}$$

78. $A(q) = \frac{km}{q} + cm + \frac{hq}{2} = (km)q^{-1} + cm + \left(\frac{h}{2}\right)q \Rightarrow \frac{dA}{dq} = -(km)q^{-2} + \left(\frac{h}{2}\right) = -\frac{km}{q^2} + \frac{h}{2} \Rightarrow \frac{d^2A}{dq^2} = 2(km)q^{-3} = \frac{2km}{q^3}$

3.4 THE DERIVATIVE AS A RATE OF CHANGE

1. $s = t^2 - 3t + 2, 0 \leq t \leq 2$

(a) displacement $= \Delta s = s(2) - s(0) = 0 \text{ m} - 2 \text{ m} = -2 \text{ m}$, $v_{av} = \frac{\Delta s}{\Delta t} = \frac{-2}{2} = -1 \text{ m/sec}$

(b) $v = \frac{ds}{dt} = 2t - 3 \Rightarrow |v(0)| = |-3| = 3 \text{ m/sec}$ and $|v(2)| = 1 \text{ m/sec}$; $a = \frac{d^2s}{dt^2} = 2 \Rightarrow a(0) = 2 \text{ m/sec}^2$ and $a(2) = 2 \text{ m/sec}^2$

(c) $v = 0 \Rightarrow 2t - 3 = 0 \Rightarrow t = \frac{3}{2}$. v is negative in the interval $0 < t < \frac{3}{2}$ and v is positive when $\frac{3}{2} < t < 2 \Rightarrow$ the body changes direction at $t = \frac{3}{2}$.

2. $s = 6t - t^2, 0 \leq t \leq 6$

(a) displacement $= \Delta s = s(6) - s(0) = 0 \text{ m}$, $v_{av} = \frac{\Delta s}{\Delta t} = \frac{0}{6} = 0 \text{ m/sec}$

(b) $v = \frac{ds}{dt} = 6 - 2t \Rightarrow |v(0)| = |6| = 6 \text{ m/sec}$ and $|v(6)| = |-6| = 6 \text{ m/sec}$; $a = \frac{d^2s}{dt^2} = -2 \Rightarrow a(0) = -2 \text{ m/sec}^2$ and $a(6) = -2 \text{ m/sec}^2$

(c) $v = 0 \Rightarrow 6 - 2t = 0 \Rightarrow t = 3$. v is positive in the interval $0 < t < 3$ and v is negative when $3 < t < 6 \Rightarrow$ the body changes direction at $t = 3$.

3. $s = -t^3 + 3t^2 - 3t, 0 \leq t \leq 3$
- (a) displacement $= \Delta s = s(3) - s(0) = -9$ m, $v_{av} = \frac{\Delta s}{\Delta t} = \frac{-9}{3} = -3$ m/sec
- (b) $v = \frac{ds}{dt} = -3t^2 + 6t - 3 \Rightarrow |v(0)| = |-3| = 3$ m/sec and $|v(3)| = |-12| = 12$ m/sec; $a = \frac{d^2s}{dt^2} = -6t + 6$
 $\Rightarrow a(0) = 6$ m/sec² and $a(3) = -12$ m/sec²
- (c) $v = 0 \Rightarrow -3t^2 + 6t - 3 = 0 \Rightarrow t^2 - 2t + 1 = 0 \Rightarrow (t-1)^2 = 0 \Rightarrow t = 1$. For all other values of t in the interval the velocity v is negative (the graph of $v = -3t^2 + 6t - 3$ is a parabola with vertex at $t = 1$ which opens downward \Rightarrow the body never changes direction).
4. $s = \frac{t^4}{4} - t^3 + t^2, 0 \leq t \leq 3$
- (a) $\Delta s = s(3) - s(0) = \frac{9}{4}$ m, $v_{av} = \frac{\Delta s}{\Delta t} = \frac{9}{4} = \frac{3}{4}$ m/sec
- (b) $v = t^3 - 3t^2 + 2t \Rightarrow |v(0)| = 0$ m/sec and $|v(3)| = 6$ m/sec; $a = 3t^2 - 6t + 2 \Rightarrow a(0) = 2$ m/sec² and $a(3) = 11$ m/sec²
- (c) $v = 0 \Rightarrow t^3 - 3t^2 + 2t = 0 \Rightarrow t(t-2)(t-1) = 0 \Rightarrow t = 0, 1, 2 \Rightarrow v = t(t-2)(t-1)$ is positive in the interval for $0 < t < 1$ and v is negative for $1 < t < 2$ and v is positive for $2 < t < 3 \Rightarrow$ the body changes direction at $t = 1$ and at $t = 2$.
5. $s = \frac{25}{t^2} - \frac{5}{t}, 1 \leq t \leq 5$
- (a) $\Delta s = s(5) - s(1) = -20$ m, $v_{av} = \frac{-20}{4} = -5$ m/sec
- (b) $v = \frac{-50}{t^3} + \frac{5}{t^2} \Rightarrow |v(1)| = 45$ m/sec and $|v(5)| = \frac{1}{5}$ m/sec; $a = \frac{150}{t^4} - \frac{10}{t^3} \Rightarrow a(1) = 140$ m/sec² and $a(5) = \frac{4}{25}$ m/sec²
- (c) $v = 0 \Rightarrow \frac{-50+5t}{t^3} = 0 \Rightarrow -50 + 5t = 0 \Rightarrow t = 10 \Rightarrow$ the body does not change direction in the interval
6. $s = \frac{25}{t+5}, -4 \leq t \leq 0$
- (a) $\Delta s = s(0) - s(-4) = -20$ m, $v_{av} = \frac{-20}{4} = -5$ m/sec
- (b) $v = \frac{-25}{(t+5)^2} \Rightarrow |v(-4)| = 25$ m/sec and $|v(0)| = 1$ m/sec; $a = \frac{50}{(t+5)^3} \Rightarrow a(-4) = 50$ m/sec² and $a(0) = \frac{2}{5}$ m/sec²
- (c) $v = 0 \Rightarrow \frac{-25}{(t+5)^2} = 0 \Rightarrow v$ is never 0 \Rightarrow the body never changes direction
7. $s = t^3 - 6t^2 + 9t$ and let the positive direction be to the right on the s -axis.
- (a) $v = 3t^2 - 12t + 9$ so that $v = 0 \Rightarrow t^2 - 4t + 3 = (t-3)(t-1) = 0 \Rightarrow t = 1$ or 3 ; $a = 6t - 12 \Rightarrow a(1) = -6$ m/sec² and $a(3) = 6$ m/sec². Thus the body is motionless but being accelerated left when $t = 1$, and motionless but being accelerated right when $t = 3$.
- (b) $a = 0 \Rightarrow 6t - 12 = 0 \Rightarrow t = 2$ with speed $|v(2)| = |12 - 24 + 9| = 3$ m/sec
- (c) The body moves to the right or forward on $0 \leq t < 1$, and to the left or backward on $1 < t < 2$. The positions are $s(0) = 0$, $s(1) = 4$ and $s(2) = 2 \Rightarrow$ total distance $= |s(1) - s(0)| + |s(2) - s(1)| = |4| + |-2| = 6$ m.
8. $v = t^2 - 4t + 3 \Rightarrow a = 2t - 4$
- (a) $v = 0 \Rightarrow t^2 - 4t + 3 = 0 \Rightarrow t = 1$ or $3 \Rightarrow a(1) = -2$ m/sec² and $a(3) = 2$ m/sec²
- (b) $v > 0 \Rightarrow (t-3)(t-1) > 0 \Rightarrow 0 \leq t < 1$ or $t > 3$ and the body is moving forward; $v < 0 \Rightarrow (t-3)(t-1) < 0 \Rightarrow 1 < t < 3$ and the body is moving backward
- (c) velocity increasing $\Rightarrow a > 0 \Rightarrow 2t - 4 > 0 \Rightarrow t > 2$; velocity decreasing $\Rightarrow a < 0 \Rightarrow 2t - 4 < 0 \Rightarrow 0 \leq t < 2$
9. $s_m = 1.86t^2 \Rightarrow v_m = 3.72t$ and solving $3.72t = 27.8 \Rightarrow t \approx 7.5$ sec on Mars; $s_j = 11.44t^2 \Rightarrow v_j = 22.88t$ and solving $22.88t = 27.8 \Rightarrow t \approx 1.2$ sec on Jupiter.

10. (a) $v(t) = s'(t) = 24 - 1.6t$ m/sec, and $a(t) = v'(t) = s''(t) = -1.6$ m/sec²
 (b) Solve $v(t) = 0 \Rightarrow 24 - 1.6t = 0 \Rightarrow t = 15$ sec
 (c) $s(15) = 24(15) - .8(15)^2 = 180$ m
 (d) Solve $s(t) = 90 \Rightarrow 24t - .8t^2 = 90 \Rightarrow t = \frac{30 \pm 15\sqrt{2}}{2} \approx 4.39$ sec going up and 25.6 sec going down
 (e) Twice the time it took to reach its highest point or 30 sec

11. $s = 15t - \frac{1}{2}g_s t^2 \Rightarrow v = 15 - g_s t$ so that $v = 0 \Rightarrow 15 - g_s t = 0 \Rightarrow g_s = \frac{15}{t}$. Therefore $g_s = \frac{15}{20} = \frac{3}{4} = 0.75$ m/sec²

12. Solving $s_m = 832t - 2.6t^2 = 0 \Rightarrow t(832 - 2.6t) = 0 \Rightarrow t = 0$ or $320 \Rightarrow 320$ sec on the moon;
 solving $s_e = 832t - 16t^2 = 0 \Rightarrow t(832 - 16t) = 0 \Rightarrow t = 0$ or $52 \Rightarrow 52$ sec on the earth. Also, $v_m = 832 - 5.2t = 0 \Rightarrow t = 160$ and $s_m(160) = 66,560$ ft, the height it reaches above the moon's surface; $v_e = 832 - 32t = 0 \Rightarrow t = 26$ and $s_e(26) = 10,816$ ft, the height it reaches above the earth's surface.

13. (a) $s = 179 - 16t^2 \Rightarrow v = -32t \Rightarrow \text{speed} = |v| = 32t$ ft/sec and $a = -32$ ft/sec²
 (b) $s = 0 \Rightarrow 179 - 16t^2 = 0 \Rightarrow t = \sqrt{\frac{179}{16}} \approx 3.3$ sec
 (c) When $t = \sqrt{\frac{179}{16}}$, $v = -32\sqrt{\frac{179}{16}} = -8\sqrt{179} \approx -107.0$ ft/sec

14. (a) $\lim_{\theta \rightarrow \frac{\pi}{2}} v = \lim_{\theta \rightarrow \frac{\pi}{2}} 9.8(\sin \theta)t = 9.8t$ so we expect $v = 9.8t$ m/sec in free fall
 (b) $a = \frac{dv}{dt} = 9.8$ m/sec²

15. (a) at 2 and 7 seconds (b) between 3 and 6 seconds: $3 \leq t \leq 6$
 (c) (d)

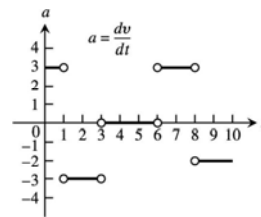
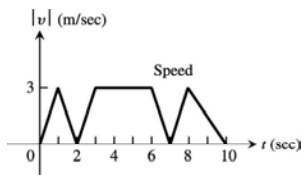

16. (a) P is moving to the left when $2 < t < 3$ or $5 < t < 6$; P is moving to the right when $0 < t < 1$; P is standing still when $1 < t < 2$ or $3 < t < 5$

(b)

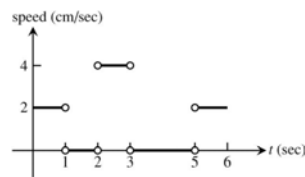
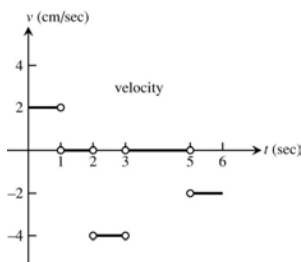

17. (a) 190 ft/sec (b) 2 sec
 (c) at 8 sec, 0 ft/sec (d) 10.8 sec, 90 ft/sec
 (e) From $t = 8$ until $t = 10.8$ sec, a total of 2.8 sec
 (f) Greatest acceleration happens 2 sec after launch
 (g) From $t = 2$ to $t = 10.8$ sec; during this period, $a = \frac{v(10.8) - v(2)}{10.8 - 2} \approx -32$ ft/sec²

18. (a) Forward: $0 \leq t < 1$ and $5 < t < 7$; Backward: $1 < t < 5$; Speeds up: $1 < t < 2$ and $5 < t < 6$; Slows down: $0 \leq t < 1$, $3 < t < 5$, and $6 < t < 7$
 (b) Positive: $3 < t < 6$; negative: $0 \leq t < 2$ and $6 < t < 7$; zero: $2 < t < 3$ and $7 < t < 9$
 (c) $t = 0$ and $2 \leq t \leq 3$
 (d) $7 \leq t \leq 9$

19. $s = 490t^2 \Rightarrow v = 980t \Rightarrow a = 980$
 (a) Solving $160 = 490t^2 \Rightarrow t = \frac{4}{7}$ sec. The average velocity was $\frac{s(4/7)-s(0)}{4/7} = 280$ cm/sec.
 (b) At the 160 cm mark the balls are falling at $v(4/7) = 560$ cm/sec. The acceleration at the 160 cm mark was 980 cm/sec².
 (c) The light was flashing at a rate of $\frac{17}{4/7} = 29.75$ flashes per second.

20. (a)

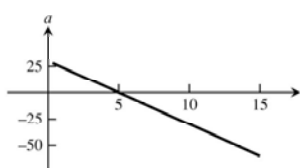
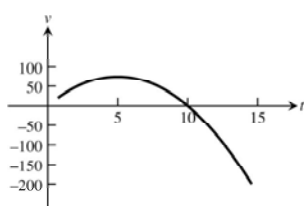

- (b)

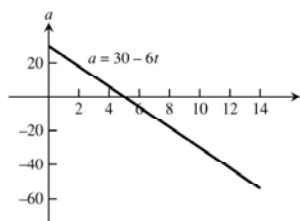
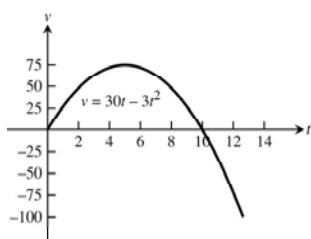

21. $C =$ position, $A =$ velocity, and $B =$ acceleration. Neither A nor C can be the derivative of B because B 's derivative is constant. Graph C cannot be the derivative of A either, because A has some negative slopes while C has only positive values. So, C (being the derivative of neither A nor B) must be the graph of position. Curve C has both positive and negative slopes, so its derivative, the velocity, must be A and not B . That leaves B for acceleration.

22. $C =$ position, $B =$ velocity, and $A =$ acceleration. Curve C cannot be the derivative of either A or B because C has only negative values while both A and B have some positive slopes. So, C represents position. Curve C has no positive slopes, so its derivative, the velocity, must be B . That leaves A for acceleration. Indeed, A is negative where B has negative slopes and positive where B has positive slopes.

23. (a) $c(100) = 11,000 \Rightarrow c_{av} = \frac{11,000}{100} = \110
 (b) $c(x) = 2000 + 100x - .1x^2 \Rightarrow c'(x) = 100 - .2x$. Marginal cost = $c'(x) \Rightarrow$ the marginal cost of producing 100 machines is $c'(100) = \$80$
 (c) The cost of producing the 101st machine is $c(101) - c(100) = 100 - \frac{201}{10} = \79.90

24. (a) $r(x) = 20000\left(1 - \frac{1}{x}\right) \Rightarrow r'(x) = \frac{20000}{x^2}$, which is marginal revenue. $r'(100) = \frac{20000}{100^2} = \2 .
 (b) $r'(101) = \$1.96$.
 (c) $\lim_{x \rightarrow \infty} r'(x) = \lim_{x \rightarrow \infty} \frac{20000}{x^2} = 0$. The increase in revenue as the number of items increases without bound will approach zero.

25. $b(t) = 10^6 + 10^4 t - 10^3 t^2 \Rightarrow b'(t) = 10^4 - (2)(10^3 t) = 10^3(10 - 2t)$

- (a) $b'(0) = 10^4$ bacteria/hr (b) $b'(5) = 0$ bacteria/hr
 (c) $b'(10) = -10^4$ bacteria/hr

26. $S'(w) = \frac{1}{120} \sqrt{\frac{180}{w}} = \frac{1}{\sqrt{80w}}$; S increases more rapidly at lower weights where the derivative is greater.

27. (a) $y = 6\left(1 - \frac{t}{12}\right)^2 = 6\left(1 - \frac{t}{6} + \frac{t^2}{144}\right) \Rightarrow \frac{dy}{dt} = \frac{t}{12} - 1$

- (b) The largest value of $\frac{dy}{dt}$ is 0 m/h when $t = 12$ and the fluid level is falling the slowest at that time.
 The smallest value of $\frac{dy}{dt}$ is -1 m/h, when $t = 0$, and the fluid level is falling the fastest at that time.

- (c) In this situation, $\frac{dy}{dt} \leq 0 \Rightarrow$ the graph of y is always decreasing. As $\frac{dy}{dt}$ increases in value, the slope of the graph of y increases from -1 to 0 over the interval $0 \leq t \leq 12$.

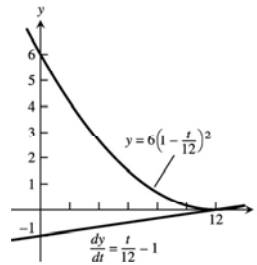

28. $Q(t) = 200(30 - t)^2 = 200(900 - 60t + t^2) \Rightarrow Q'(t) = 200(-60 + 2t) \Rightarrow Q'(10) = -8,000$ gallons/min is the rate the water is running at the end of 10 min. Then $\frac{Q(10) - Q(0)}{10} = -10,000$ gallons/min is the average rate the water flows during the first 10 min. The negative signs indicate water is leaving the tank.

29. $s'(v) = 1.1 + 0.108v$; $s'(35) = 4.88$, $s'(70) = 8.66$. The units of ds/dv are ft/mph; ds/dv gives, roughly, the number of additional feet required to stop the car if its speed increases by 1 mph.

30. (a) $V = \frac{4}{3}\pi r^3 \Rightarrow \frac{dV}{dr} = 4\pi r^2 \Rightarrow \left.\frac{dV}{dr}\right|_{r=2} = 4\pi(2)^2 = 16\pi$ ft³/ft

- (b) When $r = 2$, $\frac{dV}{dr} = 16\pi$ so that when r changes by 1 unit, we expect V to change by approximately 16π .
 Therefore when r changes by 0.2 units V changes by approximately $(16\pi)(0.2) = 3.2\pi \approx 10.05$ ft³.
 Note that $V(2.2) - V(2) \approx 11.09$ ft³.

31. $200 \text{ km/hr} = 55\frac{5}{9} \text{ m/sec} = \frac{500}{9} \text{ m/sec}$, and $D = \frac{10}{9}t^2 \Rightarrow V = \frac{20}{9}t$. Thus $V = \frac{500}{9} \Rightarrow \frac{20}{9}t = \frac{500}{9} \Rightarrow t = 25 \text{ sec}$. When $t = 25$, $D = \frac{10}{9}(25)^2 = \frac{6250}{9} \text{ m}$

32. $s = v_0 t - 16t^2 \Rightarrow v = v_0 - 32t$; $v = 0 \Rightarrow t = \frac{v_0}{32}$; $1900 = v_0 t - 16t^2$ so that $t = \frac{v_0}{32} \Rightarrow 1900 = \frac{v_0^2}{32} - \frac{v_0^2}{64} \Rightarrow v_0 = \sqrt{(64)(1900)} = 80\sqrt{19}$ ft/sec and, finally, $\frac{80\sqrt{19} \text{ ft}}{\text{sec}} \cdot \frac{60 \text{ sec}}{1 \text{ min}} \cdot \frac{60 \text{ min}}{1 \text{ hr}} \cdot \frac{1 \text{ mi}}{5280 \text{ ft}} \approx 238 \text{ mph}$.

33.

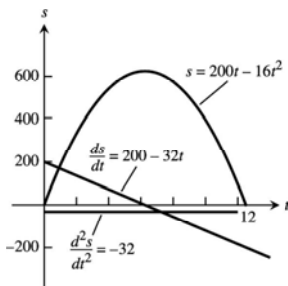

- (a) $v = 0$ when $t = 6.25 \text{ sec}$
 (b) $v > 0$ when $0 \leq t < 6.25 \Rightarrow$ body moves right (up); $v < 0$ when $6.25 < t \leq 12.5 \Rightarrow$ body moves left (down)

- (c) body changes direction at $t = 6.25$ sec
- (d) body speeds up on $(6.25, 12.5]$ and slows down on $[0, 6.25)$
- (e) The body is moving fastest at the endpoints $t = 0$ and $t = 12.5$ when it is traveling 200 ft/sec. It's moving slowest at $t = 6.25$ when the speed is 0.
- (f) When $t = 6.25$ the body is $s = 625$ m from the origin and farthest away.

34.

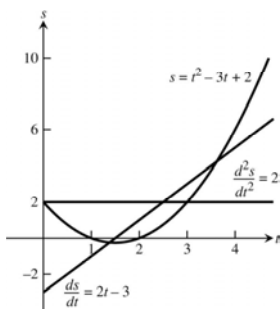

- (a) $v = 0$ when $t = \frac{3}{2}$ sec
- (b) $v < 0$ when $0 \leq t < 1.5 \Rightarrow$ body moves left (down); $v > 0$ when $1.5 < t \leq 5 \Rightarrow$ body moves right (up)
- (c) body changes direction at $t = \frac{3}{2}$ sec
- (d) body speeds up on $(\frac{3}{2}, 5]$ and slows down on $[0, \frac{3}{2})$
- (e) body is moving fastest at $t = 5$ when the speed $= |v(5)| = 7$ units/sec; it is moving slowest at $t = \frac{3}{2}$ when the speed is 0
- (f) When $t = 5$ the body is $s = 12$ units from the origin and farthest away.

35.

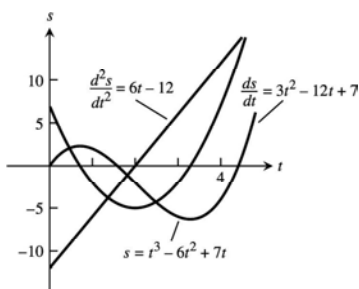

- (a) $v = 0$ when $t = \frac{6 \pm \sqrt{15}}{3}$ sec
- (b) $v < 0$ when $\frac{6 - \sqrt{15}}{3} < t < \frac{6 + \sqrt{15}}{3} \Rightarrow$ body moves left (down); $v > 0$ when $0 \leq t < \frac{6 - \sqrt{15}}{3}$ or $\frac{6 + \sqrt{15}}{3} < t \leq 4 \Rightarrow$ body moves right (up)
- (c) body changes direction at $t = \frac{6 \pm \sqrt{15}}{3}$ sec
- (d) body speeds up on $(\frac{6 - \sqrt{15}}{3}, 2) \cup (\frac{6 + \sqrt{15}}{3}, 4]$ and slows down on $[0, \frac{6 - \sqrt{15}}{3}) \cup (2, \frac{6 + \sqrt{15}}{3})$.
- (e) The body is moving fastest at $t = 0$ and $t = 4$ when it is moving 7 units/sec and slowest at $t = \frac{6 \pm \sqrt{15}}{3}$ sec
- (f) When $t = \frac{6 + \sqrt{15}}{3}$ the body is at position $s \approx -6.303$ units and farthest from the origin.

36.

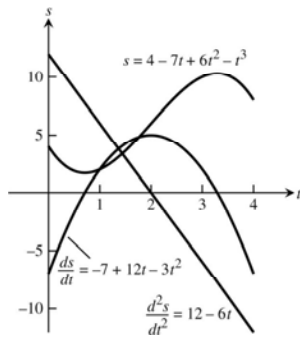

- (a) $v = 0$ when $t = \frac{6 \pm \sqrt{15}}{3}$
- (b) $v < 0$ when $0 \leq t < \frac{6 - \sqrt{15}}{3}$ or $\frac{6 + \sqrt{15}}{3} < t \leq 4 \Rightarrow$ body is moving left (down); $v > 0$ when $\frac{6 - \sqrt{15}}{3} < t < \frac{6 + \sqrt{15}}{3} \Rightarrow$ body is moving right (up)
- (c) body changes direction at $t = \frac{6 \pm \sqrt{15}}{3}$ sec
- (d) body speeds up on $\left(\frac{6 - \sqrt{15}}{3}, 2\right) \cup \left(\frac{6 + \sqrt{15}}{3}, 4\right]$ and slows down on $\left[0, \frac{6 - \sqrt{15}}{3}\right) \cup \left(2, \frac{6 + \sqrt{15}}{3}\right)$
- (e) The body is moving fastest at 7 units/sec when $t = 0$ and $t = 4$; it is moving slowest and stationary at $t = \frac{6 \pm \sqrt{15}}{3}$
- (f) When $t = \frac{6 + \sqrt{15}}{3}$ the position is $s \approx 10.303$ units and the body is farthest from the origin.

3.5 DERIVATIVES OF TRIGONOMETRIC FUNCTIONS

1. $y = -10x + 3 \cos x \Rightarrow \frac{dy}{dx} = -10 + 3 \frac{d}{dx}(\cos x) = -10 - 3 \sin x$
2. $y = \frac{3}{x} + 5 \sin x \Rightarrow \frac{dy}{dx} = \frac{-3}{x^2} + 5 \frac{d}{dx}(\sin x) = \frac{-3}{x^2} + 5 \cos x$
3. $y = x^2 \cos x \Rightarrow \frac{dy}{dx} = x^2(-\sin x) + 2x \cos x = -x^2 \sin x + 2x \cos x$
4. $y = \sqrt{x} \sec x + 3 \Rightarrow \frac{dy}{dx} = \sqrt{x} \sec x \tan x + \frac{\sec x}{2\sqrt{x}} + 0 = \sqrt{x} \sec x \tan x + \frac{\sec x}{2\sqrt{x}}$
5. $y = \csc x - 4\sqrt{x} + \frac{7}{e^x} \Rightarrow \frac{dy}{dx} = -\csc x \cot x - \frac{4}{2\sqrt{x}} - \frac{7}{e^x}$
6. $y = x^2 \cot x - \frac{1}{x^2} \Rightarrow \frac{dy}{dx} = x^2 \frac{d}{dx}(\cot x) + \cot x \cdot \frac{d}{dx}(x^2) + \frac{2}{x^3} = -x^2 \csc^2 x + (\cot x)(2x) + \frac{2}{x^3} = -x^2 \csc^2 x + 2x \cot x + \frac{2}{x^3}$
7. $f(x) = \sin x \tan x \Rightarrow f'(x) = \sin x \sec^2 x + \cos x \tan x = \sin x \sec^2 x + \cos x \frac{\sin x}{\cos x} = \sin x(\sec^2 x + 1)$
8. $g(x) = \frac{\cos x}{\sin^2 x} = \frac{1}{\sin x} \cdot \frac{\cos x}{\sin x} = \csc x \cot x \Rightarrow g'(x) = \csc x(-\csc^2 x) + (-\csc x \cot x) \cot x = -\csc^3 x - \csc x \cot^2 x = -\csc x(\csc^2 x + \cot^2 x)$
9. $y = xe^{-x} \sec x \Rightarrow \frac{dy}{dx} = \frac{d}{dx}(x)e^{-x} \sec x + x \frac{d}{dx}(e^{-x}) \sec x + xe^{-x} \frac{d}{dx}(\sec x) = e^{-x} \sec x - xe^{-x} \sec x + xe^{-x} \sec x \tan x = e^{-x} \sec x(1 - x + x \tan x)$

10. $y = (\sin x + \cos x)\sec x \Rightarrow \frac{dy}{dx} = (\sin x + \cos x) \frac{d}{dx}(\sec x) + \sec x \frac{d}{dx}(\sin x + \cos x)$
 $= (\sin x + \cos x)(\sec x \tan x) + (\sec x)(\cos x - \sin x) = \frac{(\sin x + \cos x)\sin x}{\cos^2 x} + \frac{\cos x - \sin x}{\cos x}$
 $= \frac{\sin^2 x + \cos x \sin x + \cos^2 x - \cos x \sin x}{\cos^2 x} = \frac{1}{\cos^2 x} = \sec^2 x$
 (Note also that $y = \sin x \sec x + \cos x \sec x = \tan x + 1 \Rightarrow \frac{dy}{dx} = \sec^2 x$.)
11. $y = \frac{\cot x}{1 + \cot x} \Rightarrow \frac{dy}{dx} = \frac{(1 + \cot x) \frac{d}{dx}(\cot x) - (\cot x) \frac{d}{dx}(1 + \cot x)}{(1 + \cot x)^2} = \frac{(1 + \cot x)(-\csc^2 x) - (\cot x)(-\csc^2 x)}{(1 + \cot x)^2}$
 $= \frac{-\csc^2 x - \csc^2 x \cot x + \csc^2 x \cot x}{(1 + \cot x)^2} = \frac{-\csc^2 x}{(1 + \cot x)^2}$
12. $y = \frac{\cos x}{1 + \sin x} \Rightarrow \frac{dy}{dx} = \frac{(1 + \sin x) \frac{d}{dx}(\cos x) - (\cos x) \frac{d}{dx}(1 + \sin x)}{(1 + \sin x)^2} = \frac{(1 + \sin x)(-\sin x) - (\cos x)(\cos x)}{(1 + \sin x)^2} = \frac{-\sin x - \sin^2 x - \cos^2 x}{(1 + \sin x)^2}$
 $= \frac{-\sin x - 1}{(1 + \sin x)^2} = \frac{-(1 + \sin x)}{(1 + \sin x)^2} = \frac{-1}{1 + \sin x}$
13. $y = \frac{4}{\cos x} + \frac{1}{\tan x} = 4 \sec x + \cot x \Rightarrow \frac{dy}{dx} = 4 \sec x \tan x - \csc^2 x$
14. $y = \frac{\cos x}{x} + \frac{x}{\cos x} \Rightarrow \frac{dy}{dx} = \frac{x(-\sin x) - (\cos x)(1)}{x^2} + \frac{(\cos x)(1) - x(-\sin x)}{\cos^2 x} = \frac{-x \sin x - \cos x}{x^2} + \frac{\cos x + x \sin x}{\cos^2 x}$
15. $y = (\sec x + \tan x)(\sec x - \tan x) \Rightarrow \frac{dy}{dx} = (\sec x + \tan x) \frac{d}{dx}(\sec x - \tan x) + (\sec x - \tan x) \frac{d}{dx}(\sec x + \tan x)$
 $= (\sec x + \tan x)(\sec x \tan x - \sec^2 x) + (\sec x - \tan x)(\sec x \tan x + \sec^2 x)$
 $= (\sec^2 x \tan x + \sec x \tan^2 x - \sec^3 x - \sec^2 x \tan x) + (\sec^2 x \tan x - \sec x \tan^2 x + \sec^3 x + \tan x \sec^2 x) = 0$
 (Note also that $y = \sec^2 x - \tan^2 x = (\tan^2 x + 1) - \tan^2 x = 1 \Rightarrow \frac{dy}{dx} = 0$.)
16. $y = x^2 \cos x - 2x \sin x - 2 \cos x \Rightarrow \frac{dy}{dx} = (x^2(-\sin x) + (\cos x)(2x)) - (2x \cos x + (\sin x)(2)) - 2(-\sin x)$
 $= -x^2 \sin x + 2x \cos x - 2x \cos x - 2 \sin x + 2 \sin x = -x^2 \sin x$
17. $f(x) = x^3 \sin x \cos x \Rightarrow f'(x) = x^3 \sin x(-\sin x) + x^3 \cos x(\cos x) + 3x^2 \sin x \cos x$
 $= -x^3 \sin^2 x + x^3 \cos^2 x + 3x^2 \sin x \cos x$
18. $g(x) = (2 - x) \tan^2 x \Rightarrow g'(x) = (2 - x)(2 \tan x \sec^2 x) + (-1) \tan^2 x = 2(2 - x) \tan x \sec^2 x - \tan^2 x$
 $= 2(2 - x) \tan x(\sec^2 x - \tan x)$
19. $s = \tan t - e^{-t} \Rightarrow \frac{ds}{dt} = \sec^2 t + e^{-t}$
20. $s = t^2 - \sec t + 5e^t \Rightarrow \frac{ds}{dt} = 2t - \sec t \tan t + 5e^t$
21. $s = \frac{1 + \csc t}{1 - \csc t} \Rightarrow \frac{ds}{dt} = \frac{(1 - \csc t)(-\csc t \cot t) - (1 + \csc t)(\csc t \cot t)}{(1 - \csc t)^2} = \frac{-\csc t \cot t + \csc^2 t \cot t - \csc t \cot t - \csc^2 t \cot t}{(1 - \csc t)^2} = \frac{-2 \csc t \cot t}{(1 - \csc t)^2}$
22. $s = \frac{\sin t}{1 - \cos t} \Rightarrow \frac{ds}{dt} = \frac{(1 - \cos t)(\cos t) - (\sin t)(\sin t)}{(1 - \cos t)^2} = \frac{\cos t - \cos^2 t - \sin^2 t}{(1 - \cos t)^2} = \frac{\cos t - 1}{(1 - \cos t)^2} = -\frac{1}{1 - \cos t} = \frac{1}{\cos t - 1}$
23. $r = 4 - \theta^2 \sin \theta \Rightarrow \frac{dr}{d\theta} = -(\theta^2 \frac{d}{d\theta}(\sin \theta) + (\sin \theta)(2\theta)) = -(\theta^2 \cos \theta + 2\theta \sin \theta) = -\theta(\theta \cos \theta + 2 \sin \theta)$
24. $r = \theta \sin \theta + \cos \theta \Rightarrow \frac{dr}{d\theta} = (\theta \cos \theta + (\sin \theta)(1)) - \sin \theta = \theta \cos \theta$

$$25. r = \sec \theta \csc \theta \Rightarrow \frac{dr}{d\theta} = (\sec \theta)(-\csc \theta \cot \theta) + (\csc \theta)(\sec \theta \tan \theta) = \left(\frac{-1}{\cos \theta}\right)\left(\frac{1}{\sin \theta}\right)\left(\frac{\cos \theta}{\sin \theta}\right) + \left(\frac{1}{\sin \theta}\right)\left(\frac{1}{\cos \theta}\right)\left(\frac{\sin \theta}{\cos \theta}\right) \\ = \frac{-1}{\sin^2 \theta} + \frac{1}{\cos^2 \theta} = \sec^2 \theta - \csc^2 \theta$$

$$26. r = (1 + \sec \theta) \sin \theta \Rightarrow \frac{dr}{d\theta} = (1 + \sec \theta) \cos \theta + (\sin \theta)(\sec \theta \tan \theta) = (\cos \theta + 1) + \tan^2 \theta = \cos \theta + \sec^2 \theta$$

$$27. p = 5 + \frac{1}{\cot q} = 5 + \tan q \Rightarrow \frac{dp}{dq} = \sec^2 q$$

$$28. p = (1 + \csc q) \cos q \Rightarrow \frac{dp}{dq} = (1 + \csc q)(-\sin q) + (\cos q)(-\csc q \cot q) = (-\sin q - 1) - \cot^2 q = -\sin q - \csc^2 q$$

$$29. p = \frac{\sin q + \cos q}{\cos q} \Rightarrow \frac{dp}{dq} = \frac{(\cos q)(\cos q - \sin q) - (\sin q + \cos q)(-\sin q)}{\cos^2 q} = \frac{\cos^2 q - \cos q \sin q + \sin^2 q + \cos q \sin q}{\cos^2 q} = \frac{1}{\cos^2 q} = \sec^2 q$$

$$30. p = \frac{\tan q}{1 + \tan q} \Rightarrow \frac{dp}{dq} = \frac{(1 + \tan q)(\sec^2 q) - (\tan q)(\sec^2 q)}{(1 + \tan q)^2} = \frac{\sec^2 q + \tan q \sec^2 q - \tan q \sec^2 q}{(1 + \tan q)^2} = \frac{\sec^2 q}{(1 + \tan q)^2}$$

$$31. p = \frac{q \sin q}{q^2 - 1} \Rightarrow \frac{dp}{dq} = \frac{(q^2 - 1)(q \cos q + \sin q(1)) - (q \sin q)(2q)}{(q^2 - 1)^2} = \frac{q^3 \cos q + q^2 \sin q - q \cos q - \sin q - 2q^2 \sin q}{(q^2 - 1)^2} \\ = \frac{q^3 \cos q - q^2 \sin q - q \cos q - \sin q}{(q^2 - 1)^2}$$

$$32. p = \frac{3q + \tan q}{q \sec q} \Rightarrow \frac{dp}{dq} = \frac{(q \sec q)(3 + \sec^2 q) - (3q + \tan q)(q \sec q \tan q + \sec q(1))}{(q \sec q)^2} \\ = \frac{3q \sec q + q \sec^3 q - (3q^2 \sec q \tan q + 3q \sec q + q \sec q \tan^2 q + \sec q \tan q)}{(q \sec q)^2} \\ = \frac{q \sec^3 q - 3q^2 \sec q \tan q - q \sec q \tan^2 q - \sec q \tan q}{(q \sec q)^2}$$

$$33. (a) y = \csc x \Rightarrow y' = -\csc x \cot x \Rightarrow y'' = -((\csc x)(-\csc^2 x) + (\cot x)(-\csc x \cot x)) = \csc^3 x + \csc x \cot^2 x \\ = (\csc x)(\csc^2 x + \cot^2 x) = (\csc x)(\csc^2 x + \csc^2 x - 1) = 2 \csc^3 x - \csc x$$

$$(b) y = \sec x \Rightarrow y' = \sec x \tan x \Rightarrow y'' = (\sec x)(\sec^2 x) + (\tan x)(\sec x \tan x) = \sec^3 x + \sec x \tan^2 x \\ = (\sec x)(\sec^2 x + \tan^2 x) = (\sec x)(\sec^2 x + \sec^2 x - 1) = 2 \sec^3 x - \sec x$$

$$34. (a) y = -2 \sin x \Rightarrow y' = -2 \cos x \Rightarrow y'' = -2(-\sin x) = 2 \sin x \Rightarrow y''' = 2 \cos x \Rightarrow y^{(4)} = -2 \sin x$$

$$(b) y = 9 \cos x \Rightarrow y' = -9 \sin x \Rightarrow y'' = -9 \cos x \Rightarrow y''' = -9(-\sin x) = 9 \sin x \Rightarrow y^{(4)} = 9 \cos x$$

$$35. y = \sin x \Rightarrow y' = \cos x \Rightarrow \text{slope of tangent at } x = -\pi \text{ is } y'(-\pi) = \cos(-\pi) = -1; \text{ slope of tangent at } x = 0 \text{ is } y'(0) = \cos(0) = 1; \text{ and slope of tangent at } x = \frac{3\pi}{2} \text{ is } y'(\frac{3\pi}{2}) = \cos \frac{3\pi}{2} = 0. \text{ The tangent at } (-\pi, 0) \text{ is } y - 0 = -1(x + \pi), \text{ or } y = -x - \pi; \text{ the tangent at } (0, 0) \text{ is } y - 0 = 1(x - 0), \text{ or } y = x; \text{ and the tangent at } (\frac{3\pi}{2}, -1) \text{ is } y = -1.$$

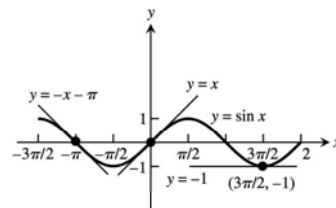

36. $y = \tan x \Rightarrow y' = \sec^2 x \Rightarrow$ slope of tangent at $x = -\frac{\pi}{3}$ is $\sec^2\left(-\frac{\pi}{3}\right) = 4$; slope of tangent at $x = 0$ is $\sec^2(0) = 1$; and slope of tangent at $x = \frac{\pi}{3}$ is $\sec^2\left(\frac{\pi}{3}\right) = 4$. The tangent at $\left(-\frac{\pi}{3}, \tan\left(-\frac{\pi}{3}\right)\right) = \left(-\frac{\pi}{3}, -\sqrt{3}\right)$ is $y + \sqrt{3} = 4\left(x + \frac{\pi}{3}\right)$; the tangent at $(0, 0)$ is $y = x$; and the tangent at $\left(\frac{\pi}{3}, \tan\left(\frac{\pi}{3}\right)\right) = \left(\frac{\pi}{3}, \sqrt{3}\right)$ is $y - \sqrt{3} = 4\left(x - \frac{\pi}{3}\right)$.

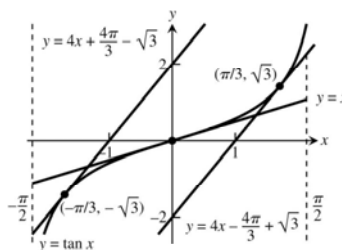

37. $y = \sec x \Rightarrow y' = \sec x \tan x \Rightarrow$ slope of tangent at $x = -\frac{\pi}{3}$ is $\sec\left(-\frac{\pi}{3}\right) \tan\left(-\frac{\pi}{3}\right) = -2\sqrt{3}$; slope of tangent at $x = \frac{\pi}{4}$ is $\sec\left(\frac{\pi}{4}\right) \tan\left(\frac{\pi}{4}\right) = \sqrt{2}$. The tangent at the point $\left(-\frac{\pi}{3}, \sec\left(-\frac{\pi}{3}\right)\right) = \left(-\frac{\pi}{3}, 2\right)$ is $y - 2 = -2\sqrt{3}\left(x + \frac{\pi}{3}\right)$; the tangent at the point $\left(\frac{\pi}{4}, \sec\left(\frac{\pi}{4}\right)\right) = \left(\frac{\pi}{4}, \sqrt{2}\right)$ is $y - \sqrt{2} = \sqrt{2}\left(x - \frac{\pi}{4}\right)$.

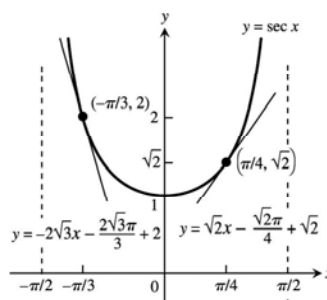

38. $y = 1 + \cos x \Rightarrow y' = -\sin x \Rightarrow$ slope of tangent at $x = -\frac{\pi}{3}$ is $-\sin\left(-\frac{\pi}{3}\right) = \frac{\sqrt{3}}{2}$; slope of tangent at $x = \frac{3\pi}{2}$ is $-\sin\left(\frac{3\pi}{2}\right) = 1$. The tangent at the point $\left(-\frac{\pi}{3}, 1 + \cos\left(-\frac{\pi}{3}\right)\right) = \left(-\frac{\pi}{3}, \frac{3}{2}\right)$ is $y - \frac{3}{2} = \frac{\sqrt{3}}{2}\left(x + \frac{\pi}{3}\right)$; the tangent at the point $\left(\frac{3\pi}{2}, 1 + \cos\left(\frac{3\pi}{2}\right)\right) = \left(\frac{3\pi}{2}, 1\right)$ is $y - 1 = x - \frac{3\pi}{2}$.

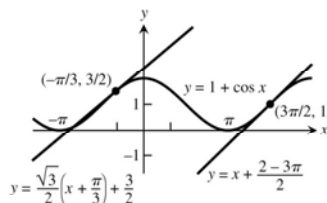

39. Yes, $y = x + \sin x \Rightarrow y' = 1 + \cos x$; horizontal tangent occurs where $1 + \cos x = 0 \Rightarrow \cos x = -1 \Rightarrow x = \pi$
40. No, $y = 2x + \sin x \Rightarrow y' = 2 + \cos x$; horizontal tangent occurs where $2 + \cos x = 0 \Rightarrow \cos x = -2$. But there are no x -values for which $\cos x = -2$.
41. No, $y = x \cot x \Rightarrow y' = 1 + \csc^2 x$; horizontal tangent occurs where $1 + \csc^2 x = 0 \Rightarrow \csc^2 x = -1$. But there are no x -values for which $\csc^2 x = -1$.
42. Yes, $y = x + 2 \cos x \Rightarrow y' = 1 - 2 \sin x$; horizontal tangent occurs where $1 - 2 \sin x = 0 \Rightarrow 1 = 2 \sin x \Rightarrow \frac{1}{2} = \sin x \Rightarrow x = \frac{\pi}{6}$ or $x = \frac{5\pi}{6}$

43. We want all points on the curve where the tangent line has slope 2. Thus, $y = \tan x \Rightarrow y' = \sec^2 x$ so that $y' = 2 \Rightarrow \sec^2 x = 2 \Rightarrow \sec x = \pm \sqrt{2} \Rightarrow x = \pm \frac{\pi}{4}$. Then the tangent line at $\left(\frac{\pi}{4}, 1\right)$ has equation $y - 1 = 2\left(x - \frac{\pi}{4}\right)$; the tangent line at $\left(-\frac{\pi}{4}, -1\right)$ has equation $y + 1 = 2\left(x + \frac{\pi}{4}\right)$.

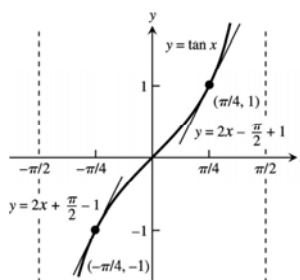

44. We want all points on the curve $y = \cot x$ where the tangent line has slope -1 . Thus $y = \cot x \Rightarrow y' = -\csc^2 x$ so that $y' = -1 \Rightarrow -\csc^2 x = -1 \Rightarrow \csc^2 x = 1 \Rightarrow \csc x = \pm 1 \Rightarrow x = \frac{\pi}{2}$. The tangent line at $(\frac{\pi}{2}, 0)$ is $y = -x + \frac{\pi}{2}$.

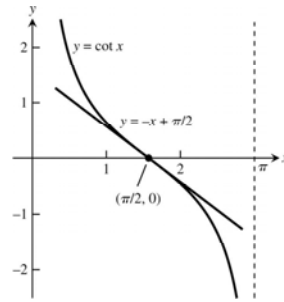

45. $y = 4 + \cot x - 2 \csc x \Rightarrow y' = -\csc^2 x + 2 \csc x \cot x = -\left(\frac{1}{\sin x}\right)\left(\frac{1-2\cos x}{\sin x}\right)$
 (a) When $x = \frac{\pi}{2}$, then $y' = -1$; the tangent line is $y = -x + \frac{\pi}{2} + 2$.
 (b) To find the location of the horizontal tangent set $y' = 0 \Rightarrow 1 - 2 \cos x = 0 \Rightarrow x = \frac{\pi}{3}$ radians. When $x = \frac{\pi}{3}$, then $y = 4 - \sqrt{3}$ is the horizontal tangent.
46. $y = 1 + \sqrt{2} \csc x + \cot x \Rightarrow y' = -\sqrt{2} \csc x \cot x - \csc^2 x = -\left(\frac{1}{\sin x}\right)\left(\frac{\sqrt{2} \cos x + 1}{\sin x}\right)$
 (a) If $x = \frac{\pi}{4}$, then $y' = -4$; the tangent line is $y = -4x + \pi + 4$.
 (b) To find the location of the horizontal tangent set $y' = 0 \Rightarrow \sqrt{2} \cos x + 1 = 0 \Rightarrow x = \frac{3\pi}{4}$ radians. When $x = \frac{3\pi}{4}$, then $y = 2$ is the horizontal tangent.
47. $\lim_{x \rightarrow 2} \sin\left(\frac{1}{x} - \frac{1}{2}\right) = \sin\left(\frac{1}{2} - \frac{1}{2}\right) = \sin 0 = 0$
48. $\lim_{x \rightarrow -\frac{\pi}{6}} \sqrt{1 + \cos(\pi \csc x)} = \sqrt{1 + \cos(\pi \csc(-\frac{\pi}{6}))} = \sqrt{1 + \cos(\pi \cdot (-2))} = \sqrt{2}$
49. $\lim_{\theta \rightarrow \frac{\pi}{6}} \frac{\sin \theta - \frac{1}{2}}{\theta - \frac{\pi}{6}} = \frac{d}{d\theta}(\sin \theta) \Big|_{\theta = \frac{\pi}{6}} = \cos \theta \Big|_{\theta = \frac{\pi}{6}} = \cos\left(\frac{\pi}{6}\right) = \frac{\sqrt{3}}{2}$
50. $\lim_{\theta \rightarrow \frac{\pi}{4}} \frac{\tan \theta - 1}{\theta - \frac{\pi}{4}} = \frac{d}{d\theta}(\tan \theta) \Big|_{\theta = \frac{\pi}{4}} = \sec^2 \theta \Big|_{\theta = \frac{\pi}{4}} = \sec^2\left(\frac{\pi}{4}\right) = 2$
51. $\lim_{x \rightarrow 0} \sec\left[e^x + \pi \tan\left(\frac{\pi}{4 \sec x}\right) - 1\right] = \sec\left[1 + \pi \tan\left(\frac{\pi}{4 \sec 0}\right) - 1\right] = \sec\left[\pi \tan\left(\frac{\pi}{4}\right)\right] = \sec(\pi) = -1$
52. $\lim_{x \rightarrow 0} \sin\left(\frac{\pi + \tan x}{\tan x - 2 \sec x}\right) = \sin\left(\frac{\pi + \tan 0}{\tan 0 - 2 \sec 0}\right) = \sin\left(-\frac{\pi}{2}\right) = -1$
53. $\lim_{t \rightarrow 0} \tan\left(1 - \frac{\sin t}{t}\right) = \tan\left(1 - \lim_{t \rightarrow 0} \frac{\sin t}{t}\right) = \tan(1 - 1) = 0$
54. $\lim_{\theta \rightarrow 0} \cos\left(\frac{\pi \theta}{\sin \theta}\right) = \cos\left(\pi \lim_{\theta \rightarrow 0} \frac{\theta}{\sin \theta}\right) = \cos\left(\pi \cdot \frac{1}{\lim_{\theta \rightarrow 0} \frac{\sin \theta}{\theta}}\right) = \cos\left(\pi \cdot \frac{1}{1}\right) = -1$

55. $s = 2 - 2 \sin t \Rightarrow v = \frac{ds}{dt} = -2 \cos t \Rightarrow a = \frac{dv}{dt} = 2 \sin t \Rightarrow j = \frac{da}{dt} = 2 \cos t$. Therefore, velocity $= v\left(\frac{\pi}{4}\right) = -\sqrt{2}$ m/sec; speed $= \left|v\left(\frac{\pi}{4}\right)\right| = \sqrt{2}$ m/sec; acceleration $= a\left(\frac{\pi}{4}\right) = \sqrt{2}$ m/sec²; jerk $= j\left(\frac{\pi}{4}\right) = \sqrt{2}$ m/sec³.

56. $s = \sin t + \cos t \Rightarrow v = \frac{ds}{dt} = \cos t - \sin t \Rightarrow a = \frac{dv}{dt} = -\sin t - \cos t \Rightarrow j = \frac{da}{dt} = -\cos t + \sin t$. Therefore velocity $= v\left(\frac{\pi}{4}\right) = 0$ m/sec; speed $= \left|v\left(\frac{\pi}{4}\right)\right| = 0$ m/sec; acceleration $= a\left(\frac{\pi}{4}\right) = -\sqrt{2}$ m/sec²; jerk $= j\left(\frac{\pi}{4}\right) = 0$ m/sec³.

57. $\lim_{x \rightarrow 0} f(x) = \lim_{x \rightarrow 0} \frac{\sin^2 3x}{x^2} = \lim_{x \rightarrow 0} 9 \left(\frac{\sin 3x}{3x}\right) \left(\frac{\sin 3x}{3x}\right) = 9$ so that f is continuous at $x = 0 \Rightarrow \lim_{x \rightarrow 0} f(x) = f(0) \Rightarrow 9 = c$.

58. $\lim_{x \rightarrow 0^-} g(x) = \lim_{x \rightarrow 0^-} (x + b) = b$ and $\lim_{x \rightarrow 0^+} g(x) = \lim_{x \rightarrow 0^+} \cos x = 1$ so that g is continuous at $x = 0 \Rightarrow \lim_{x \rightarrow 0^-} g(x) = \lim_{x \rightarrow 0^+} g(x) \Rightarrow b = 1$. Now g is not differentiable at $x = 0$: At $x = 0$, the left-hand derivative is $\frac{d}{dx}(x + b)|_{x=0} = 1$, but the right-hand derivative is $\frac{d}{dx}(\cos x)|_{x=0} = -\sin 0 = 0$. The left- and right-hand derivatives can never agree at $x = 0$, so g is not differentiable at $x = 0$ for any value of b (including $b = 1$).

59. $\frac{d^{999}}{dx^{999}}(\cos x) = \sin x$ because $\frac{d^4}{dx^4}(\cos x) = \cos x \Rightarrow$ the derivative of $\cos x$ any number of times that is a multiple of 4 is $\cos x$. Thus, dividing 999 by 4 gives $999 = 249 \cdot 4 + 3 \Rightarrow \frac{d^{999}}{dx^{999}}(\cos x) = \frac{d^3}{dx^3} \left[\frac{d^{249 \cdot 4}}{dx^{249 \cdot 4}}(\cos x) \right] = \frac{d^3}{dx^3}(\cos x) = \sin x$.

60. (a) $y = \sec x = \frac{1}{\cos x} \Rightarrow \frac{dy}{dx} = \frac{(\cos x)(0) - (1)(-\sin x)}{(\cos x)^2} = \frac{\sin x}{\cos^2 x} = \left(\frac{1}{\cos x}\right) \left(\frac{\sin x}{\cos x}\right) = \sec x \tan x \Rightarrow \frac{d}{dx}(\sec x) = \sec x \tan x$

(b) $y = \csc x = \frac{1}{\sin x} \Rightarrow \frac{dy}{dx} = \frac{(\sin x)(0) - (1)(\cos x)}{(\sin x)^2} = \frac{-\cos x}{\sin^2 x} = \left(\frac{-1}{\sin x}\right) \left(\frac{\cos x}{\sin x}\right) = -\csc x \cot x \Rightarrow \frac{d}{dx}(\csc x) = -\csc x \cot x$

(c) $y = \cot x = \frac{\cos x}{\sin x} \Rightarrow \frac{dy}{dx} = \frac{(\sin x)(-\sin x) - (\cos x)(\cos x)}{(\sin x)^2} = \frac{-\sin^2 x - \cos^2 x}{\sin^2 x} = \frac{-1}{\sin^2 x} = -\csc^2 x \Rightarrow \frac{d}{dx}(\cot x) = -\csc^2 x$

61. (a) $t = 0 \rightarrow x = 10 \cos(0) = 10$ cm; $t = \frac{\pi}{3} \rightarrow x = 10 \cos\left(\frac{\pi}{3}\right) = 5$ cm; $t = \frac{3\pi}{4} \rightarrow x = 10 \cos\left(\frac{3\pi}{4}\right) = -5\sqrt{2}$ cm

(b) $t = 0 \rightarrow v = -10 \sin(0) = 0$ cm/sec; $t = \frac{\pi}{3} \rightarrow v = -10 \sin\left(\frac{\pi}{3}\right) = -5\sqrt{3}$ cm/sec; $t = \frac{3\pi}{4} \rightarrow v = -10 \sin\left(\frac{3\pi}{4}\right) = -5\sqrt{2}$ cm/sec

62. (a) $t = 0 \rightarrow x = 3 \cos(0) + 4 \sin(0) = 3$ ft; $t = \frac{\pi}{2} \rightarrow x = 3 \cos\left(\frac{\pi}{2}\right) + 4 \sin\left(\frac{\pi}{2}\right) = 4$ ft;
 $t = \pi \rightarrow x = 3 \cos(\pi) + 4 \sin(\pi) = -3$ ft

(b) $t = 0 \rightarrow v = -3 \sin(0) + 4 \cos(0) = 4$ ft/sec; $t = \frac{\pi}{2} \rightarrow v = -3 \sin\left(\frac{\pi}{2}\right) + 4 \cos\left(\frac{\pi}{2}\right) = -3$ ft/sec;
 $t = \pi \rightarrow v = -3 \sin(\pi) + 4 \cos(\pi) = -4$ ft/sec

63.

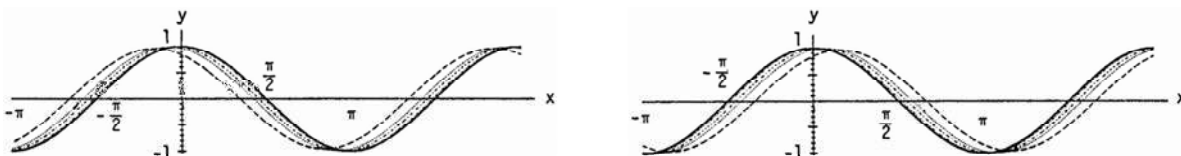

As h takes on the values of 1, 0.5, 0.3 and 0.1 the corresponding dashed curves of $y = \frac{\sin(x+h) - \sin x}{h}$ get closer and closer to the black curve $y = \cos x$ because $\frac{d}{dx}(\sin x) = \lim_{h \rightarrow 0} \frac{\sin(x+h) - \sin x}{h} = \cos x$. The same is true as h takes on the values of $-1, -0.5, -0.3$ and -0.1 .

64.

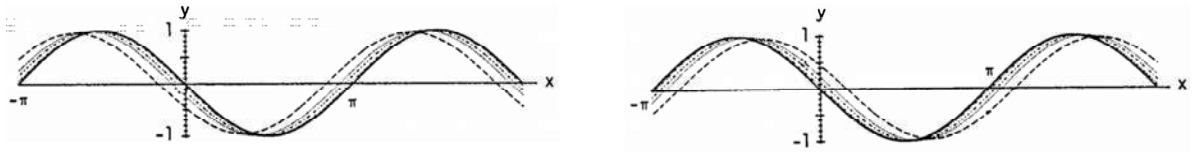

As h takes on the values of 1, 0.5, 0.3, and 0.1 the corresponding dashed curves of $y = \frac{\cos(x+h) - \cos x}{h}$ get closer and closer to the black curve $y = -\sin x$ because $\frac{d}{dx}(\cos x) = \lim_{h \rightarrow 0} \frac{\cos(x+h) - \cos x}{h} = -\sin x$. The same is true as h takes on the values of $-1, -0.5, -0.3,$ and -0.1 .

65. (a)

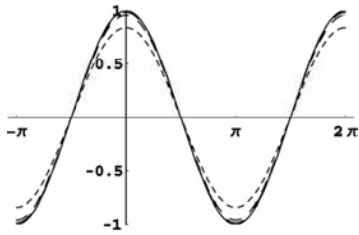

The dashed curves of $y = \frac{\sin(x+h) - \sin(x-h)}{2h}$ are closer to the black curve $y = \cos x$ than the corresponding dashed curves in Exercise 63 illustrating that the centered difference quotient is a better approximation of the derivative of this function.

(b)

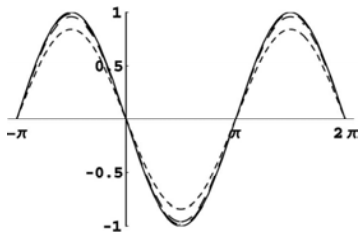

The dashed curves of $y = \frac{\cos(x+h) - \cos(x-h)}{2h}$ are closer to the black curve $y = -\sin x$ than the corresponding dashed curves in Exercise 64 illustrating that the centered difference quotient is a better approximation of the derivative of this function.

66. $\lim_{h \rightarrow 0} \frac{|0+h| - |0-h|}{2h} = \lim_{x \rightarrow 0} \frac{|h| - |-h|}{2h} = \lim_{h \rightarrow 0} 0 = 0 \Rightarrow$ the limits of the centered difference quotient exists even though the derivative of $f(x) = |x|$ does not exist at $x = 0$.

67. $y = \tan x \Rightarrow y' = \sec^2 x$, so the smallest value $y' = \sec^2 x$ takes on is $y' = 1$ when $x = 0$; y' has no maximum value since $\sec^2 x$ has no largest value on $(-\frac{\pi}{2}, \frac{\pi}{2})$; y' is never negative since $\sec^2 x \geq 1$.

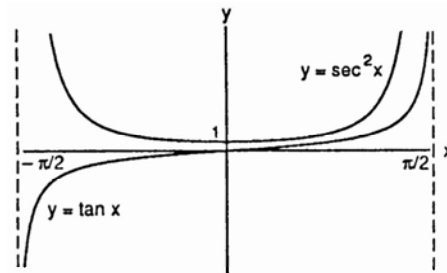

68. $y = \cot x \Rightarrow y' = -\csc^2 x$ so y' has no smallest value since $-\csc^2 x$ has no minimum value on $(0, \pi)$; the largest value of y' is -1 , when $x = \frac{\pi}{2}$; the slope is never positive since the largest value $y' = -\csc^2 x$ takes on is -1 .

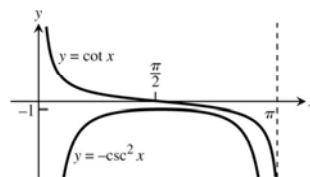

69. $y = \frac{\sin x}{x}$ appears to cross the y -axis at $y = 1$, since $\lim_{x \rightarrow 0} \frac{\sin x}{x} = 1$; $y = \frac{\sin 2x}{x}$ appears to cross the y -axis at $y = 2$, since $\lim_{x \rightarrow 0} \frac{\sin 2x}{x} = 2$; $y = \frac{\sin 4x}{x}$ appears to cross the y -axis at $y = 4$, since $\lim_{x \rightarrow 0} \frac{\sin 4x}{x} = 4$.

However, none of these graphs actually cross the y -axis since $x = 0$ is not in the domain of the functions. Also, $\lim_{x \rightarrow 0} \frac{\sin 5x}{x} = 5$, $\lim_{x \rightarrow 0} \frac{\sin(-3x)}{x} = -3$, and $\lim_{x \rightarrow 0} \frac{\sin kx}{x} = k \Rightarrow$ the graphs of $y = \frac{\sin 5x}{x}$, $y = \frac{\sin(-3x)}{x}$, and $y = \frac{\sin kx}{x}$ approach 5, -3, and k , respectively, as $x \rightarrow 0$. However, the graphs do not actually cross the y -axis.

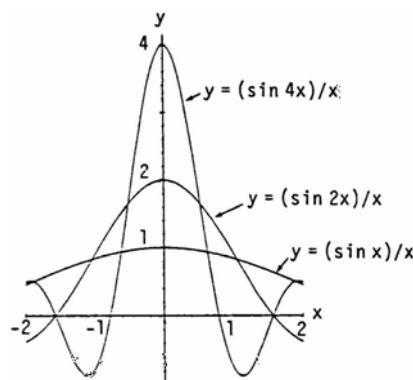

70. (a)

h	$\frac{\sin h}{h}$	$\left(\frac{\sin h}{h}\right)\left(\frac{180}{\pi}\right)$
1	.017452406	.99994923
0.01	.017453292	1
0.001	.017453292	1
0.0001	.017453292	1

$$\lim_{h \rightarrow 0} \frac{\sin h^\circ}{h} = \lim_{x \rightarrow 0} \frac{\sin\left(h \cdot \frac{\pi}{180}\right)}{h} = \lim_{h \rightarrow 0} \frac{\frac{\pi}{180} \sin\left(h \cdot \frac{\pi}{180}\right)}{\frac{\pi}{180} h} = \lim_{\theta \rightarrow 0} \frac{\frac{\pi}{180} \sin \theta}{\theta} = \frac{\pi}{180} \quad \left(\theta = h \cdot \frac{\pi}{180}\right)$$

(converting to radians)

(b)

h	$\frac{\cos h - 1}{h}$
1	-0.0001523
0.01	-0.0000015
0.001	-0.0000001
0.0001	0

$$\lim_{h \rightarrow 0} \frac{\cos h - 1}{h} = 0, \text{ whether } h \text{ is measured in degrees or radians.}$$

(c) In degrees, $\frac{d}{dx}(\sin x) = \lim_{h \rightarrow 0} \frac{\sin(x+h) - \sin x}{h} = \lim_{h \rightarrow 0} \frac{(\sin x \cos h + \cos x \sin h) - \sin x}{h}$
 $= \lim_{h \rightarrow 0} \left(\sin x \cdot \frac{\cos h - 1}{h} \right) + \lim_{h \rightarrow 0} \left(\cos x \cdot \frac{\sin h}{h} \right) = (\sin x) \cdot \lim_{h \rightarrow 0} \left(\frac{\cos h - 1}{h} \right) + (\cos x) \cdot \lim_{h \rightarrow 0} \left(\frac{\sin h}{h} \right)$
 $= (\sin x)(0) + (\cos x) \left(\frac{\pi}{180} \right) = \frac{\pi}{180} \cos x$

(d) In degrees, $\frac{d}{dx}(\cos x) = \lim_{h \rightarrow 0} \frac{\cos(x+h) - \cos x}{h} = \lim_{h \rightarrow 0} \frac{(\cos x \cos h - \sin x \sin h) - \cos x}{h}$
 $= \lim_{h \rightarrow 0} \frac{(\cos x)(\cos h - 1) - \sin x \sin h}{h} = \lim_{h \rightarrow 0} \left(\cos x \cdot \frac{\cos h - 1}{h} \right) - \lim_{h \rightarrow 0} \left(\sin x \cdot \frac{\sin h}{h} \right)$
 $= (\cos x) \lim_{h \rightarrow 0} \left(\frac{\cos h - 1}{h} \right) - (\sin x) \lim_{h \rightarrow 0} \left(\frac{\sin h}{h} \right) = (\cos x)(0) - (\sin x) \left(\frac{\pi}{180} \right) = -\frac{\pi}{180} \sin x$

(e) $\frac{d^2}{dx^2}(\sin x) = \frac{d}{dx} \left(\frac{\pi}{180} \cos x \right) = -\left(\frac{\pi}{180} \right)^2 \sin x$; $\frac{d^3}{dx^3}(\sin x) = \frac{d}{dx} \left(-\left(\frac{\pi}{180} \right)^2 \sin x \right) = -\left(\frac{\pi}{180} \right)^3 \cos x$;
 $\frac{d^2}{dx^2}(\cos x) = \frac{d}{dx} \left(-\frac{\pi}{180} \sin x \right) = -\left(\frac{\pi}{180} \right)^2 \cos x$; $\frac{d^3}{dx^3}(\cos x) = \frac{d}{dx} \left(-\left(\frac{\pi}{180} \right)^2 \cos x \right) = \left(\frac{\pi}{180} \right)^3 \sin x$

3.6 THE CHAIN RULE

1. $f(u) = 6u - 9 \Rightarrow f'(u) = 6 \Rightarrow f'(g(x)) = 6; g(x) = \frac{1}{2}x^4 \Rightarrow g'(x) = 2x^3;$
therefore $\frac{dy}{dx} = f'(g(x))g'(x) = 6 \cdot 2x^3 = 12x^3$
2. $f(u) = 2u^3 \Rightarrow f'(u) = 6u^2 \Rightarrow f'(g(x)) = 6(8x-1)^2; g(x) = 8x-1 \Rightarrow g'(x) = 8;$
therefore $\frac{dy}{dx} = f'(g(x))g'(x) = 6(8x-1)^2 \cdot 8 = 48(8x-1)^2$
3. $f(u) = \sin u \Rightarrow f'(u) = \cos u \Rightarrow f'(g(x)) = \cos(3x+1); g(x) = 3x+1 \Rightarrow g'(x) = 3;$
therefore $\frac{dy}{dx} = f'(g(x))g'(x) = (\cos(3x+1))(3) = 3 \cos(3x+1)$
4. $f(u) = \cos u \Rightarrow f'(u) = -\sin u \Rightarrow f'(g(x)) = -\sin(e^{-x}); g(x) = e^{-x} \Rightarrow g'(x) = -e^{-x};$ therefore,
 $\frac{dy}{dx} = f'(g(x))g'(x) = -\sin(e^{-x})(-e^{-x}) = e^{-x} \sin(e^{-x})$
5. $f(u) = \sqrt{u} \Rightarrow f'(u) = \frac{1}{2\sqrt{u}} \Rightarrow f'(g(x)) = \frac{1}{2\sqrt{\sin x}}; g(x) = \sin x \Rightarrow g'(x) = \cos x;$ therefore,
 $\frac{dy}{dx} = f'(g(x))g'(x) = \frac{\cos x}{2\sqrt{\sin x}}$
6. $f(u) = \sin u \Rightarrow f'(u) = \cos u \Rightarrow f'(g(x)) = \cos(x - \cos x); g(x) = x - \cos x \Rightarrow g'(x) = 1 + \sin x;$
therefore $\frac{dy}{dx} = f'(g(x))g'(x) = (\cos(x - \cos x))(1 + \sin x)$
7. $f(u) = \tan u \Rightarrow f'(u) = \sec^2 u \Rightarrow f'(g(x)) = \sec^2(\pi x^2); g(x) = \pi x^2 \Rightarrow g'(x) = 2\pi x;$
therefore $\frac{dy}{dx} = f'(g(x))g'(x) = \sec^2(\pi x^2)(2\pi x) = 2\pi x \sec^2(\pi x^2)$
8. $f(u) = -\sec u \Rightarrow f'(u) = -\sec u \tan u \Rightarrow f'(g(x)) = -\sec\left(\frac{1}{x} + 7x\right) \tan\left(\frac{1}{x} + 7x\right); g(x) = \frac{1}{x} + 7x \Rightarrow$
 $g'(x) = -\frac{1}{x^2} + 7;$ therefore, $\frac{dy}{dx} = f'(g(x))g'(x) = \left(\frac{1}{x^2} - 7\right) \sec\left(\frac{1}{x} + 7x\right) \tan\left(\frac{1}{x} + 7x\right)$
9. With $u = (2x+1), y = u^5: \frac{dy}{dx} = \frac{dy}{du} \frac{du}{dx} = 5u^4 \cdot 2 = 10(2x+1)^4$
10. With $u = (4-3x), y = u^9: \frac{dy}{dx} = \frac{dy}{du} \frac{du}{dx} = 9u^8 \cdot (-3) = -27(4-3x)^8$
11. With $u = \left(1 - \frac{x}{7}\right), y = u^{-7}: \frac{dy}{dx} = \frac{dy}{du} \frac{du}{dx} = -7u^{-8} \cdot \left(-\frac{1}{7}\right) = \left(1 - \frac{x}{7}\right)^{-8}$
12. With $u = \frac{\sqrt{x}}{2} - 1, y = u^{-10}: \frac{dy}{dx} = \frac{dy}{du} \frac{du}{dx} = -10u^{-11} \cdot \left(\frac{1}{4\sqrt{x}}\right) = -\frac{1}{4\sqrt{x}} \left(\frac{\sqrt{x}}{2} - 1\right)^{-11}$
13. With $u = \left(\frac{x^2}{8} + x - \frac{1}{x}\right), y = u^4: \frac{dy}{dx} = \frac{dy}{du} \frac{du}{dx} = 4u^3 \cdot \left(\frac{x}{4} + 1 + \frac{1}{x^2}\right) = 4\left(\frac{x^2}{8} + x - \frac{1}{x}\right)^3 \left(\frac{x}{4} + 1 + \frac{1}{x^2}\right)$
14. With $u = 3x^2 - 4x + 6, y = u^{1/2}: \frac{dy}{dx} = \frac{dy}{du} \frac{du}{dx} = \frac{1}{2}u^{-1/2} \cdot (6x-4) = \frac{3x-2}{\sqrt{3x^2-4x+6}}$

15. With $u = \tan x$, $y = \sec u$: $\frac{dy}{dx} = \frac{dy}{du} \frac{du}{dx} = (\sec u \tan u)(\sec^2 x) = (\sec(\tan x) \tan(\tan x)) \sec^2 x$
16. With $u = \pi - \frac{1}{x}$, $y = \cot u$: $\frac{dy}{dx} = \frac{dy}{du} \frac{du}{dx} = (-\csc^2 u) \left(\frac{1}{x^2} \right) = -\frac{1}{x^2} \csc^2 \left(\pi - \frac{1}{x} \right)$
17. With $u = \tan x$, $y = u^3$: $\frac{dy}{dx} = \frac{dy}{du} \frac{du}{dx} = 3u^2 \sec^2 x = 3 \tan^2 x \sec^2 x$
18. With $u = \cos x$, $y = 5u^{-4}$: $\frac{dy}{dx} = \frac{dy}{du} \frac{du}{dx} = (-20u^{-5})(-\sin x) = 20(\cos^{-5} x)(\sin x)$
19. With $u = -5x$, $y = e^u$: $\frac{dy}{dx} = \frac{dy}{du} \frac{du}{dx} = e^u (-5) = -5e^{-5x}$
20. With $u = \frac{2x}{3}$, $y = e^u$: $\frac{dy}{dx} = \frac{dy}{du} \frac{du}{dx} = e^u \left(\frac{2}{3} \right) = \frac{2}{3} e^{2x/3}$
21. With $u = 5 - 7x$, $y = e^u$: $\frac{dy}{dx} = \frac{dy}{du} \frac{du}{dx} = e^u (-7) = -7e^{5-7x}$
22. With $u = 4\sqrt{x} + x^2$, $y = e^u$: $\frac{dy}{dx} = \frac{dy}{du} \frac{du}{dx} = e^u \left(4 \cdot \frac{1}{2} x^{-1/2} + 2x \right) = \left(\frac{2}{\sqrt{x}} + 2x \right) e^{(4\sqrt{x} + x^2)}$
23. $p = \sqrt{3-t} = (3-t)^{1/2} \Rightarrow \frac{dp}{dt} = \frac{1}{2}(3-t)^{-1/2} \cdot \frac{d}{dt}(3-t) = -\frac{1}{2}(3-t)^{-1/2} = \frac{-1}{2\sqrt{3-t}}$
24. $q = \sqrt[3]{2r-r^2} = (2r-r^2)^{1/3} \Rightarrow \frac{dq}{dr} = \frac{1}{3}(2r-r^2)^{-2/3} \cdot \frac{d}{dr}(2r-r^2) = \frac{1}{3}(2r-r^2)^{-2/3}(2-2r) = \frac{2-2r}{3(2r-r^2)^{2/3}}$
25. $s = \frac{4}{3\pi} \sin 3t + \frac{4}{5\pi} \cos 5t \Rightarrow \frac{ds}{dt} = \frac{4}{3\pi} \cos 3t \cdot \frac{d}{dt}(3t) + \frac{4}{5\pi} (-\sin 5t) \cdot \frac{d}{dt}(5t) = \frac{4}{\pi} \cos 3t - \frac{4}{\pi} \sin 5t = \frac{4}{\pi} (\cos 3t - \sin 5t)$
26. $s = \sin\left(\frac{3\pi t}{2}\right) + \cos\left(\frac{3\pi t}{2}\right) \Rightarrow \frac{ds}{dt} = \cos\left(\frac{3\pi t}{2}\right) \cdot \frac{d}{dt}\left(\frac{3\pi t}{2}\right) - \sin\left(\frac{3\pi t}{2}\right) \cdot \frac{d}{dt}\left(\frac{3\pi t}{2}\right) = \frac{3\pi}{2} \cos\left(\frac{3\pi t}{2}\right) - \frac{3\pi}{2} \sin\left(\frac{3\pi t}{2}\right) = \frac{3\pi}{2} \left(\cos\frac{3\pi t}{2} - \sin\frac{3\pi t}{2} \right)$
27. $r = (\csc \theta + \cot \theta)^{-1} \Rightarrow \frac{dr}{d\theta} = -(\csc \theta + \cot \theta)^{-2} \frac{d}{d\theta}(\csc \theta + \cot \theta) = \frac{\csc \theta \cot \theta + \csc^2 \theta}{(\csc \theta + \cot \theta)^2} = \frac{\csc \theta (\cot \theta + \csc \theta)}{(\csc \theta + \cot \theta)^2} = \frac{\csc \theta}{\csc \theta + \cot \theta}$
28. $r = 6(\sec \theta - \tan \theta)^{3/2} \Rightarrow \frac{dr}{d\theta} = 6 \cdot \frac{3}{2} (\sec \theta - \tan \theta)^{1/2} \frac{d}{d\theta}(\sec \theta - \tan \theta) = 9\sqrt{\sec \theta - \tan \theta} (\sec \theta \tan \theta - \sec^2 \theta)$
29. $y = x^2 \sin^4 x + x \cos^{-2} x \Rightarrow \frac{dy}{dx} = x^2 \frac{d}{dx}(\sin^4 x) + \sin^4 x \cdot \frac{d}{dx}(x^2) + x \frac{d}{dx}(\cos^{-2} x) + \cos^{-2} x \cdot \frac{d}{dx}(x)$
 $= x^2 (4 \sin^3 x \frac{d}{dx}(\sin x)) + 2x \sin^4 x + x(-2 \cos^{-3} x \cdot \frac{d}{dx}(\cos x)) + \cos^{-2} x$
 $= x^2 (4 \sin^3 x \cos x) + 2x \sin^4 x + x(-2 \cos^{-3} x)(-\sin x) + \cos^{-2} x$
 $= 4x^2 \sin^3 x \cos x + 2x \sin^4 x + 2x \sin x \cos^{-3} x + \cos^{-2} x$
30. $y = \frac{1}{x} \sin^{-5} x - \frac{x}{3} \cos^3 x \Rightarrow y' = \frac{1}{x} \frac{d}{dx}(\sin^{-5} x) + \sin^{-5} x \cdot \frac{d}{dx}\left(\frac{1}{x}\right) - \frac{x}{3} \frac{d}{dx}(\cos^3 x) - \cos^3 x \cdot \frac{d}{dx}\left(\frac{x}{3}\right)$
 $= \frac{1}{x} (-5 \sin^{-6} x \cos x) + (\sin^{-5} x) \left(-\frac{1}{x^2}\right) - \frac{x}{3} ((3 \cos^2 x)(-\sin x)) - (\cos^3 x) \left(\frac{1}{3}\right)$
 $= -\frac{5}{x} \sin^{-6} x \cos x - \frac{1}{x^2} \sin^{-5} x + x \cos^2 x \sin x - \frac{1}{3} \cos^3 x$

$$31. \quad y = \frac{1}{18}(3x-2)^6 + \left(4 - \frac{1}{2x^2}\right)^{-1} \Rightarrow \frac{dy}{dx} = \frac{6}{18}(3x-2)^5 \cdot \frac{d}{dx}(3x-2) + (-1)\left(4 - \frac{1}{2x^2}\right)^{-2} \cdot \frac{d}{dx}\left(4 - \frac{1}{2x^2}\right)$$

$$= \frac{6}{18}(3x-2)^5 \cdot 3 + (-1)\left(4 - \frac{1}{2x^2}\right)^{-2} \left(\frac{1}{x^3}\right) = (3x-2)^5 - \frac{1}{x^3\left(4 - \frac{1}{2x^2}\right)^2}$$

$$32. \quad y = (5-2x)^{-3} + \frac{1}{8}\left(\frac{2}{x}+1\right)^4 \Rightarrow \frac{dy}{dx} = -3(5-2x)^{-4}(-2) + \frac{4}{8}\left(\frac{2}{x}+1\right)^3\left(-\frac{2}{x^2}\right)$$

$$= 6(5-2x)^{-4} - \left(\frac{1}{x^2}\right)\left(\frac{2}{x}+1\right)^3 = \frac{6}{(5-2x)^4} - \frac{\left(\frac{2}{x}+1\right)^3}{x^2}$$

$$33. \quad y = (4x+3)^4(x+1)^{-3} \Rightarrow \frac{dy}{dx} = (4x+3)^4(-3)(x+1)^{-4} \cdot \frac{d}{dx}(x+1) + (x+1)^{-3}(4)(4x+3)^3 \cdot \frac{d}{dx}(4x+3)$$

$$= (4x+3)^4(-3)(x+1)^{-4}(1) + (x+1)^{-3}(4)(4x+3)^3(4) = -3(4x+3)^4(x+1)^{-4} + 16(4x+3)^3(x+1)^{-3}$$

$$= \frac{(4x+3)^3}{(x+1)^4}[-3(4x+3) + 16(x+1)] = \frac{(4x+3)^3(4x+7)}{(x+1)^4}$$

$$34. \quad y = (2x-5)^{-1}(x^2-5x)^6 \Rightarrow \frac{dy}{dx} = (2x-5)^{-1}(6)(x^2-5x)^5(2x-5) + (x^2-5x)^6(-1)(2x-5)^{-2}(2)$$

$$= 6(x^2-5x)^5 - \frac{2(x^2-5x)^6}{(2x-5)^2}$$

$$35. \quad y = xe^{-x} + e^{x^3} \Rightarrow y' = x \cdot e^{-x}(-1) + (1) \cdot e^{-x} + 3x^2e^{x^3} = (1-x)e^{-x} + 3x^2e^{x^3}$$

$$36. \quad y = (1+2x)e^{-2x} \Rightarrow y' = (1+2x) \cdot e^{-2x}(-2) + (2) \cdot e^{-2x} = -4xe^{-2x}$$

$$37. \quad y = (x^2-2x+2)e^{5x/2} \Rightarrow y' = (x^2-2x+2) \cdot e^{5x/2}\left(\frac{5}{2}\right) + (2x-2) \cdot e^{5x/2} = \left(\frac{5}{2}x^2 - 3x + 3\right)e^{5x/2}$$

$$38. \quad y = (9x^2-6x+2)e^{x^3} \Rightarrow y' = (9x^2-6x+2) \cdot e^{x^3}(3x^2) + (18x-6) \cdot e^{x^3} = (27x^4 - 18x^3 + 6x^2 + 18x - 6)e^{x^3}$$

$$39. \quad h(x) = x \tan(2\sqrt{x}) + 7 \Rightarrow h'(x) = x \frac{d}{dx}(\tan(2x^{1/2})) + \tan(2x^{1/2}) \cdot \frac{d}{dx}(x) + 0$$

$$= x \sec^2(2x^{1/2}) \cdot \frac{d}{dx}(2x^{1/2}) + \tan(2x^{1/2}) = x \sec^2(2\sqrt{x}) \cdot \frac{1}{\sqrt{x}} + \tan(2\sqrt{x}) = \sqrt{x} \sec^2(2\sqrt{x}) + \tan(2\sqrt{x})$$

$$40. \quad k(x) = x^2 \sec\left(\frac{1}{x}\right) \Rightarrow k'(x) = x^2 \frac{d}{dx}\left(\sec\frac{1}{x}\right) + \sec\left(\frac{1}{x}\right) \cdot \frac{d}{dx}(x^2) = x^2 \sec\left(\frac{1}{x}\right) \tan\left(\frac{1}{x}\right) \cdot \frac{d}{dx}\left(\frac{1}{x}\right) + 2x \sec\left(\frac{1}{x}\right)$$

$$= x^2 \sec\left(\frac{1}{x}\right) \tan\left(\frac{1}{x}\right) \cdot \left(-\frac{1}{x^2}\right) + 2x \sec\left(\frac{1}{x}\right) = 2x \sec\left(\frac{1}{x}\right) - \sec\left(\frac{1}{x}\right) \tan\left(\frac{1}{x}\right)$$

$$41. \quad f(x) = \sqrt{7+x \sec x} \Rightarrow f'(x) = \frac{1}{2}(7+x \sec x)^{-1/2}(x \cdot (\sec x \tan x) + (\sec x) \cdot 1) = \frac{x \sec x \tan x + \sec x}{2\sqrt{7+x \sec x}}$$

$$42. \quad g(x) = \frac{\tan 3x}{(x+7)^4} \Rightarrow g'(x) = \frac{(x+7)^4(\sec^2 3x) - (\tan 3x)4(x+7)^3 \cdot 1}{[(x+7)^4]^2} = \frac{(x+7)^3(3(x+7)\sec^2 3x - 4 \tan 3x)}{(x+7)^8} = \frac{(3(x+7)\sec^2 3x - 4 \tan 3x)}{(x+7)^5}$$

$$43. \quad f(\theta) = \left(\frac{\sin \theta}{1+\cos \theta}\right)^2 \Rightarrow f'(\theta) = 2\left(\frac{\sin \theta}{1+\cos \theta}\right) \cdot \frac{d}{d\theta}\left(\frac{\sin \theta}{1+\cos \theta}\right) = \frac{2 \sin \theta}{1+\cos \theta} \cdot \frac{(1+\cos \theta)(\cos \theta) - (\sin \theta)(-\sin \theta)}{(1+\cos \theta)^2}$$

$$= \frac{(2 \sin \theta)(\cos \theta + \cos^2 \theta + \sin^2 \theta)}{(1+\cos \theta)^3} = \frac{(2 \sin \theta)(\cos \theta + 1)}{(1+\cos \theta)^3} = \frac{2 \sin \theta}{(1+\cos \theta)^2}$$

$$44. \quad g(t) = \left(\frac{1+\sin 3t}{3-2t}\right)^{-1} = \frac{3-2t}{1+\sin 3t} \Rightarrow g'(t) = \frac{(1+\sin 3t)(-2) - (3-2t)(3 \cos 3t)}{(1+\sin 3t)^2} = \frac{-2-2 \sin 3t-9 \cos 3t+6t \cos 3t}{(1+\sin 3t)}$$

$$45. \quad r = \sin(\theta^2) \cos(2\theta) \Rightarrow \frac{dr}{d\theta} = \sin(\theta^2)(-\sin 2\theta) \frac{d}{d\theta}(2\theta) + \cos(2\theta) (\cos(\theta^2)) \cdot \frac{d}{d\theta}(\theta^2) \\ = \sin(\theta^2)(-\sin 2\theta)(2) + (\cos 2\theta)(\cos(\theta^2))(2\theta) = -2 \sin(\theta^2) \sin(2\theta) + 2\theta \cos(2\theta) \cos(\theta^2)$$

$$46. \quad r = (\sec \sqrt{\theta}) \tan\left(\frac{1}{\theta}\right) \Rightarrow \frac{dr}{d\theta} = (\sec \sqrt{\theta}) \left(\sec^2 \frac{1}{\theta}\right) \left(-\frac{1}{\theta^2}\right) + \tan\left(\frac{1}{\theta}\right) (\sec \sqrt{\theta} \tan \sqrt{\theta}) \left(\frac{1}{2\sqrt{\theta}}\right) \\ = -\frac{1}{\theta^2} \sec \sqrt{\theta} \sec^2\left(\frac{1}{\theta}\right) + \frac{1}{2\sqrt{\theta}} \tan\left(\frac{1}{\theta}\right) \sec \sqrt{\theta} \tan \sqrt{\theta} = (\sec \sqrt{\theta}) \left[\frac{\tan \sqrt{\theta} \tan\left(\frac{1}{\theta}\right)}{2\sqrt{\theta}} - \frac{\sec^2\left(\frac{1}{\theta}\right)}{\theta^2} \right]$$

$$47. \quad q = \sin\left(\frac{t}{\sqrt{t+1}}\right) \Rightarrow \frac{dq}{dt} = \cos\left(\frac{t}{\sqrt{t+1}}\right) \cdot \frac{d}{dt}\left(\frac{t}{\sqrt{t+1}}\right) = \cos\left(\frac{t}{\sqrt{t+1}}\right) \cdot \frac{\sqrt{t+1}(1)-t \cdot \frac{d}{dt}(\sqrt{t+1})}{(\sqrt{t+1})^2} = \cos\left(\frac{t}{\sqrt{t+1}}\right) \cdot \frac{\sqrt{t+1}-\frac{t}{2\sqrt{t+1}}}{t+1} \\ = \cos\left(\frac{t}{\sqrt{t+1}}\right) \left(\frac{2(t+1)-t}{2(t+1)^{3/2}}\right) = \left(\frac{t+2}{2(t+1)^{3/2}}\right) \cos\left(\frac{t}{\sqrt{t+1}}\right)$$

$$48. \quad q = \cot\left(\frac{\sin t}{t}\right) \Rightarrow \frac{dq}{dt} = -\csc^2\left(\frac{\sin t}{t}\right) \cdot \frac{d}{dt}\left(\frac{\sin t}{t}\right) = \left(-\csc^2\left(\frac{\sin t}{t}\right)\right) \left(\frac{t \cos t - \sin t}{t^2}\right)$$

$$49. \quad y = \cos\left(e^{-\theta^2}\right) \Rightarrow \frac{dy}{d\theta} = -\sin\left(e^{-\theta^2}\right) \frac{d}{d\theta}\left(e^{-\theta^2}\right) = \left(-\sin\left(e^{-\theta^2}\right)\right) \left(e^{-\theta^2}\right) \frac{d}{d\theta}(-\theta^2) = 2\theta e^{-\theta^2} \sin\left(e^{-\theta^2}\right)$$

$$50. \quad y = \theta^3 e^{-2\theta} \cos 5\theta \Rightarrow \frac{dy}{d\theta} = (3\theta^2)(e^{-2\theta} \cos 5\theta) + (\theta^3 \cos 5\theta) e^{-2\theta} \frac{d}{d\theta}(-2\theta) - 5(\sin 5\theta)(\theta^3 e^{-2\theta}) \\ = \theta^2 e^{-2\theta} (3 \cos 5\theta - 2\theta \cos 5\theta - 5\theta \sin 5\theta)$$

$$51. \quad y = \sin^2(\pi t - 2) \Rightarrow \frac{dy}{dt} = 2 \sin(\pi t - 2) \cdot \frac{d}{dt} \sin(\pi t - 2) = 2 \sin(\pi t - 2) \cdot \cos(\pi t - 2) \cdot \frac{d}{dt}(\pi t - 2) \\ = 2\pi \sin(\pi t - 2) \cos(\pi t - 2)$$

$$52. \quad y = \sec^2 \pi t \Rightarrow \frac{dy}{dt} = (2 \sec \pi t) \cdot \frac{d}{dt}(\sec \pi t) = (2 \sec \pi t)(\sec \pi t \tan \pi t) \cdot \frac{d}{dt}(\pi t) = 2\pi \sec^2 \pi t \tan \pi t$$

$$53. \quad y = (1 + \cos 2t)^{-4} \Rightarrow \frac{dy}{dt} = -4(1 + \cos 2t)^{-5} \cdot \frac{d}{dt}(1 + \cos 2t) = -4(1 + \cos 2t)^{-5} (-\sin 2t) \cdot \frac{d}{dt}(2t) = \frac{8 \sin 2t}{(1 + \cos 2t)^5}$$

$$54. \quad y = \left(1 + \cot\left(\frac{t}{2}\right)\right)^{-2} \Rightarrow \frac{dy}{dt} = -2\left(1 + \cot\left(\frac{t}{2}\right)\right)^{-3} \cdot \frac{d}{dt}\left(1 + \cot\left(\frac{t}{2}\right)\right) = -2\left(1 + \cot\left(\frac{t}{2}\right)\right)^{-3} \cdot \left(-\csc^2\left(\frac{t}{2}\right)\right) \cdot \frac{d}{dt}\left(\frac{t}{2}\right) = \frac{\csc^2\left(\frac{t}{2}\right)}{\left(1 + \cot\left(\frac{t}{2}\right)\right)^3}$$

$$55. \quad y = (t \tan t)^{10} \Rightarrow \frac{dy}{dt} = 10(t \tan t)^9 \left(t \cdot \sec^2 t + 1 \cdot \tan t\right) = 10t^9 \tan^9 t (t \sec^2 t + \tan t) \\ = 10t^{10} \tan^9 t \sec^2 t + 10t^9 \tan^{10} t$$

$$56. \quad y = (t^{-3/4} \sin t)^{4/3} = t^{-1} (\sin t)^{4/3} \Rightarrow \frac{dy}{dt} = t^{-1} \left(\frac{4}{3}\right) (\sin t)^{1/3} \cos t - t^{-2} (\sin t)^{4/3} = \frac{4(\sin t)^{1/3} \cos t}{3t} - \frac{(\sin t)^{4/3}}{t^2} \\ = \frac{(\sin t)^{1/3} (4t \cos t - 3 \cos t)}{3t^2}$$

$$57. \quad y = e^{\cos^2(\pi t - 1)} \Rightarrow \frac{dy}{dt} = e^{\cos^2(\pi t - 1)} \cdot 2 \cos(\pi t - 1) \cdot (-\sin(\pi t - 1)) \cdot \pi = -2\pi \sin(\pi t - 1) \cos(\pi t - 1) e^{\cos^2(\pi t - 1)}$$

$$58. y = (e^{\sin(t/2)})^3 \Rightarrow \frac{dy}{dt} = 3(e^{\sin(t/2)})^2 \cdot e^{\sin(t/2)} \cdot \cos\left(\frac{t}{2}\right) \cdot \frac{1}{2} = \frac{3}{2} \cos\left(\frac{t}{2}\right) e^{3\sin(t/2)}$$

$$59. y = \left(\frac{t^2}{t^3-4t}\right)^3 \Rightarrow \frac{dy}{dt} = 3\left(\frac{t^2}{t^3-4t}\right)^2 \cdot \frac{(t^3-4t)(2t) - t^2(3t^2-4)}{(t^3-4t)^2} = \frac{3t^4}{(t^3-4t)^2} \cdot \frac{2t^4-8t^2-3t^4+4t^2}{(t^3-4t)^2} = \frac{3t^4(-t^4-4t^2)}{t^4(t^2-4t)^4} = \frac{-3t^2(t^2+4)}{(t^2-4)^4}$$

$$60. y = \left(\frac{3t-4}{5t+2}\right)^{-5} \Rightarrow \frac{dy}{dt} = -5\left(\frac{3t-4}{5t+2}\right)^{-6} \cdot \frac{(5t+2)3 - (3t-4)5}{(5t+2)^2} = -5\left(\frac{3t-4}{5t+2}\right)^6 \cdot \frac{15t+6-15t+20}{(5t+2)^2} = -5\left(\frac{3t-4}{5t+2}\right)^6 \cdot \frac{26}{(5t+2)^2} = \frac{-130(3t-4)^6}{(5t+2)^8}$$

$$61. y = \sin(\cos(2t-5)) \Rightarrow \frac{dy}{dt} = \cos(\cos(2t-5)) \cdot \frac{d}{dt} \cos(2t-5) = \cos(\cos(2t-5)) \cdot (-\sin(2t-5)) \cdot \frac{d}{dt}(2t-5) = -2\cos(\cos(2t-5))\sin(2t-5)$$

$$62. y = \cos\left(5\sin\left(\frac{t}{3}\right)\right) \Rightarrow \frac{dy}{dt} = -\sin\left(5\sin\left(\frac{t}{3}\right)\right) \cdot \frac{d}{dt}\left(5\sin\left(\frac{t}{3}\right)\right) = -\sin\left(5\sin\left(\frac{t}{3}\right)\right) \left(5\cos\left(\frac{t}{3}\right)\right) \cdot \frac{d}{dt}\left(\frac{t}{3}\right) = -\frac{5}{3} \sin\left(5\sin\left(\frac{t}{3}\right)\right) \cos\left(\frac{t}{3}\right)$$

$$63. y = \left[1 + \tan^4\left(\frac{t}{12}\right)\right]^3 \Rightarrow \frac{dy}{dt} = 3\left[1 + \tan^4\left(\frac{t}{12}\right)\right]^2 \cdot \frac{d}{dt}\left[1 + \tan^4\left(\frac{t}{12}\right)\right] = 3\left[1 + \tan^4\left(\frac{t}{12}\right)\right]^2 \left[4\tan^3\left(\frac{t}{12}\right) \cdot \frac{d}{dt}\tan\left(\frac{t}{12}\right)\right] = 12\left[1 + \tan^4\left(\frac{t}{12}\right)\right]^2 \left[\tan^3\left(\frac{t}{12}\right)\sec^2\left(\frac{t}{12}\right) \cdot \frac{1}{12}\right] = \left[1 + \tan^4\left(\frac{t}{12}\right)\right]^2 \left[\tan^3\left(\frac{t}{12}\right)\sec^2\left(\frac{t}{12}\right)\right]$$

$$64. y = \frac{1}{6}\left[1 + \cos^2(7t)\right]^3 \Rightarrow \frac{dy}{dt} = \frac{3}{6}\left[1 + \cos^2(7t)\right]^2 \cdot 2\cos(7t)(-\sin(7t))(7) = -7\left[1 + \cos^2(7t)\right]^2 (\cos(7t)\sin(7t))$$

$$65. y = (1 + \cos(t^2))^{1/2} \Rightarrow \frac{dy}{dt} = \frac{1}{2}(1 + \cos(t^2))^{-1/2} \cdot \frac{d}{dt}(1 + \cos(t^2)) = \frac{1}{2}(1 + \cos(t^2))^{-1/2} (-\sin(t^2) \cdot \frac{d}{dt}(t^2)) = -\frac{1}{2}(1 + \cos(t^2))^{-1/2} (\sin(t^2) \cdot 2t) = -\frac{t\sin(t^2)}{\sqrt{1 + \cos(t^2)}}$$

$$66. y = 4\sin(\sqrt{1+\sqrt{t}}) \Rightarrow \frac{dy}{dt} = 4\cos(\sqrt{1+\sqrt{t}}) \cdot \frac{d}{dt}(\sqrt{1+\sqrt{t}}) = 4\cos(\sqrt{1+\sqrt{t}}) \cdot \frac{1}{2\sqrt{1+\sqrt{t}}} \cdot \frac{d}{dt}(1+\sqrt{t}) = \frac{2\cos(\sqrt{1+\sqrt{t}})}{\sqrt{1+\sqrt{t}} \cdot 2\sqrt{t}} = \frac{\cos(\sqrt{1+\sqrt{t}})}{\sqrt{t+\sqrt{t}}}$$

$$67. y = \tan^2(\sin^3 t) \Rightarrow \frac{dy}{dt} = 2\tan(\sin^3 t) \cdot \sec^2(\sin^3 t) \cdot (3\sin^2 t \cdot (\cos t)) = 6\tan(\sin^3 t)\sec^2(\sin^3 t)\sin^2 t \cos t$$

$$68. y = \cos^4(\sec^2 3t) \Rightarrow \frac{dy}{dt} = 4\cos^3(\sec^2 3t) (-\sin(\sec^2 3t)) \cdot 2(\sec 3t)(\sec 3t \tan 3t) \cdot 3 = -24\cos^3(\sec^2 3t)\sin(\sec^2 3t)\sec^2 3t \tan 3t$$

$$69. y = 3t(2t^2 - 5)^4 \Rightarrow \frac{dy}{dt} = 3t \cdot 4(2t^2 - 5)^3(4t) + 3 \cdot (2t^2 - 5)^4 = 3(2t^2 - 5)^3 [16t^2 + 2t^2 - 5] = 3(2t^2 - 5)^3 (18t^2 - 5)$$

$$70. y = \sqrt{3t + \sqrt{2 + \sqrt{1-t}}} \Rightarrow \frac{dy}{dt} = \frac{1}{2}\left(3t + \sqrt{2 + \sqrt{1-t}}\right)^{-1/2} \left(3 + \frac{1}{2}\left(2 + \sqrt{1-t}\right)^{-1/2} \frac{1}{2}(1-t)^{-1/2}(-1)\right) = \frac{1}{2\sqrt{3t + \sqrt{2 + \sqrt{1-t}}}} \left(3 + \frac{1}{2\sqrt{2 + \sqrt{1-t}}} \cdot \frac{-1}{2\sqrt{1-t}}\right) = \frac{1}{2\sqrt{3t + \sqrt{2 + \sqrt{1-t}}}} \left(\frac{12\sqrt{1-t}\sqrt{2 + \sqrt{1-t}} - 1}{4\sqrt{1-t}\sqrt{2 + \sqrt{1-t}}}\right)$$

$$71. \quad y = \left(1 + \frac{1}{x}\right)^3 \Rightarrow y' = 3\left(1 + \frac{1}{x}\right)^2 \left(-\frac{1}{x^2}\right) = -\frac{3}{x^2} \left(1 + \frac{1}{x}\right)^2 \Rightarrow y'' = \left(-\frac{3}{x^2}\right) \cdot \frac{d}{dx} \left(1 + \frac{1}{x}\right)^2 - \left(1 + \frac{1}{x}\right)^2 \cdot \frac{d}{dx} \left(-\frac{3}{x^2}\right) \\ = \left(-\frac{3}{x^2}\right) \left(2\left(1 + \frac{1}{x}\right) \left(-\frac{1}{x^2}\right)\right) + \left(\frac{6}{x^3}\right) \left(1 + \frac{1}{x}\right)^2 = \frac{6}{x^4} \left(1 + \frac{1}{x}\right) + \frac{6}{x^3} \left(1 + \frac{1}{x}\right)^2 = \frac{6}{x^3} \left(1 + \frac{1}{x}\right) \left(\frac{1}{x} + 1 + \frac{1}{x}\right) = \frac{6}{x^3} \left(1 + \frac{1}{x}\right) \left(1 + \frac{2}{x}\right)$$

$$72. \quad y = (1 - \sqrt{x})^{-1} \Rightarrow y' = -(1 - \sqrt{x})^{-2} \left(-\frac{1}{2} x^{-1/2}\right) = \frac{1}{2} (1 - \sqrt{x})^{-2} x^{-1/2} \\ \Rightarrow y'' = \frac{1}{2} \left[(1 - \sqrt{x})^{-2} \left(-\frac{1}{2} x^{-3/2}\right) + x^{-1/2} (-2) (1 - \sqrt{x})^{-3} \left(-\frac{1}{2} x^{-1/2}\right) \right] \\ = \frac{1}{2} \left[-\frac{1}{2} x^{-3/2} (1 - \sqrt{x})^{-2} + x^{-1} (1 - \sqrt{x})^{-3} \right] = \frac{1}{2} x^{-1} (1 - \sqrt{x})^{-3} \left[-\frac{1}{2} x^{-1/2} (1 - \sqrt{x}) + 1 \right] \\ = \frac{1}{2x} (1 - \sqrt{x})^{-3} \left(-\frac{1}{2\sqrt{x}} + \frac{1}{2} + 1 \right) = \frac{1}{2x} (1 - \sqrt{x})^{-3} \left(\frac{3}{2} - \frac{1}{2\sqrt{x}} \right)$$

$$73. \quad y = \frac{1}{9} \cot(3x - 1) \Rightarrow y' = -\frac{1}{9} \csc^2(3x - 1)(3) = -\frac{1}{3} \csc^2(3x - 1) \Rightarrow y'' = \left(-\frac{2}{3}\right) (\csc(3x - 1) \cdot \frac{d}{dx} \csc(3x - 1)) \\ = -\frac{2}{3} \csc(3x - 1) (-\csc(3x - 1) \cot(3x - 1) \cdot \frac{d}{dx} (3x - 1)) = 2 \csc^2(3x - 1) \cot(3x - 1)$$

$$74. \quad y = 9 \tan\left(\frac{x}{3}\right) \Rightarrow y' = 9 \left(\sec^2\left(\frac{x}{3}\right)\right) \left(\frac{1}{3}\right) = 3 \sec^2\left(\frac{x}{3}\right) \Rightarrow y'' = 3 \cdot 2 \sec\left(\frac{x}{3}\right) \left(\sec\left(\frac{x}{3}\right) \tan\left(\frac{x}{3}\right)\right) \left(\frac{1}{3}\right) = 2 \sec^2\left(\frac{x}{3}\right) \tan\left(\frac{x}{3}\right)$$

$$75. \quad y = x(2x + 1)^4 \Rightarrow y' = x \cdot 4(2x + 1)^3(2) + 1 \cdot (2x + 1)^4 = (2x + 1)^3(8x + 2(2x + 1)) = (2x + 1)^3(10x + 1) \\ \Rightarrow y'' = (2x + 1)^3(10) + 3(2x + 1)^2(2)(10x + 1) = 2(2x + 1)^2(5(2x + 1) + 3(10x + 1)) = 2(2x + 1)^2(40x + 8) \\ = 16(2x + 1)^2(5x + 1)$$

$$76. \quad y = x^2(x^3 - 1)^5 \Rightarrow y' = x^2 \cdot 5(x^3 - 1)^4(3x^2) + 2x(x^3 - 1)^5 = x(x^3 - 1)^4[15x^3 + 2(x^3 - 1)] = (x^3 - 1)^4(17x^4 - 2x) \\ \Rightarrow y'' = (x^3 - 1)^4(68x^3 - 2) + 4(x^3 - 1)^3(3x^2)(17x^4 - 2x) = 2(x^3 - 1)^3[(x^3 - 1)(34x^3 - 1) + 6x^2(17x^4 - 2x)] \\ = 2(x^3 - 1)^3(136x^6 - 47x^3 + 1)$$

$$77. \quad y = e^{x^2} + 5x \Rightarrow y' = 2xe^{x^2} + 5 \Rightarrow y'' = 2x \cdot e^{x^2}(2x) + 2e^{x^2} = (4x^2 + 2)e^{x^2}$$

$$78. \quad y = \sin(x^2 e^x) \Rightarrow y' = \cos(x^2 e^x) \cdot (x^2 e^x + 2xe^x) = (x^2 + 2x)e^x \cos(x^2 e^x) \\ \Rightarrow \text{(Use triple product rule: } D(uvw) = uvw' + uv'w + u'vw \text{ from Exercise 75 part a in Section 3.3)} \\ y'' = (x^2 + 2x)e^x (-\sin(x^2 e^x) \cdot (x^2 e^x + 2xe^x)) + (x^2 + 2x)e^x \cos(x^2 e^x) + (2x + 2)e^x \cos(x^2 e^x) \\ = (x^2 + 4x + 2)e^x \cos(x^2 e^x) - xe^{2x}(x^3 + 4x^2 + 4x)\sin(x^2 e^x)$$

$$79. \quad g(x) = \sqrt{x} \Rightarrow g'(x) = \frac{1}{2\sqrt{x}} \Rightarrow g(1) = 1 \text{ and } g'(1) = \frac{1}{2}; f(u) = u^5 + 1 \Rightarrow f'(u) = 5u^4 \Rightarrow f'(g(1)) = f'(1) = 5; \\ \text{therefore, } (f \circ g)'(1) = f'(g(1)) \cdot g'(1) = 5 \cdot \frac{1}{2} = \frac{5}{2}$$

$$80. \quad g(x) = (1 - x)^{-1} \Rightarrow g'(x) = -(1 - x)^{-2}(-1) = \frac{1}{(1 - x)^2} \Rightarrow g(-1) = \frac{1}{2} \text{ and } g'(-1) = \frac{1}{4}; f(u) = 1 - \frac{1}{u} \Rightarrow f'(u) = \frac{1}{u^2} \\ \Rightarrow f'(g(-1)) = f'\left(\frac{1}{2}\right) = 4; \text{ therefore, } (f \circ g)'(-1) = f'(g(-1))g'(-1) = 4 \cdot \frac{1}{4} = 1$$

$$81. \quad g(x) = 5\sqrt{x} \Rightarrow g'(x) = \frac{5}{2\sqrt{x}} \Rightarrow g(1) = 5 \text{ and } g'(1) = \frac{5}{2}; f(u) = \cot\left(\frac{\pi u}{10}\right) \Rightarrow f'(u) = -\csc^2\left(\frac{\pi u}{10}\right) \left(\frac{\pi}{10}\right) = -\frac{\pi}{10} \csc^2\left(\frac{\pi u}{10}\right) \\ \Rightarrow f'(g(1)) = f'(5) = -\frac{\pi}{10} \csc^2\left(\frac{\pi}{2}\right) = -\frac{\pi}{10}; \text{ therefore, } (f \circ g)'(1) = f'(g(1))g'(1) = -\frac{\pi}{10} \cdot \frac{5}{2} = -\frac{\pi}{4}$$

82. $g(x) = \pi x \Rightarrow g'(x) = \pi \Rightarrow g\left(\frac{1}{4}\right) = \frac{\pi}{4}$ and $g'\left(\frac{1}{4}\right) = \pi$; $f(u) = u + \sec^2 u \Rightarrow f'(u) = 1 + 2 \sec u \cdot \sec u \tan u = 1 + 2 \sec^2 u \tan u \Rightarrow f'\left(g\left(\frac{1}{4}\right)\right) = f'\left(\frac{\pi}{4}\right) = 1 + 2 \sec^2 \frac{\pi}{4} \tan \frac{\pi}{4} = 5$; therefore, $(f \circ g)'\left(\frac{1}{4}\right) = f'\left(g\left(\frac{1}{4}\right)\right)g'\left(\frac{1}{4}\right) = 5\pi$

83. $g(x) = 10x^2 + x + 1 \Rightarrow g'(x) = 20x + 1 \Rightarrow g(0) = 1$ and $g'(0) = 1$; $f(u) = \frac{2u}{u^2 + 1} \Rightarrow f'(u) = \frac{(u^2 + 1)(2) - (2u)(2u)}{(u^2 + 1)^2} = \frac{-2u^2 + 2}{(u^2 + 1)^2} \Rightarrow f'(g(0)) = f'(1) = 0$; therefore, $(f \circ g)'(0) = f'(g(0))g'(0) = 0 \cdot 1 = 0$

84. $g(x) = \frac{1}{x^2} - 1 \Rightarrow g'(x) = -\frac{2}{x^3} \Rightarrow g(-1) = 0$ and $g'(-1) = 2$; $f(u) = \left(\frac{u-1}{u+1}\right)^2 \Rightarrow f'(u) = 2\left(\frac{u-1}{u+1}\right) \frac{d}{du}\left(\frac{u-1}{u+1}\right) = 2\left(\frac{u-1}{u+1}\right) \cdot \frac{(u+1)(1) - (u-1)(1)}{(u+1)^2} = \frac{2(u-1)(2)}{(u+1)^3} = \frac{4(u-1)}{(u+1)^3} \Rightarrow f'(g(-1)) = f'(0) = -4$; therefore, $(f \circ g)'(-1) = f'(g(-1))g'(-1) = (-4)(2) = -8$

85. $y = f(g(x))$, $f'(3) = -1$, $g'(2) = 5$, $g(2) = 3 \Rightarrow y' = f'(g(x))g'(x) \Rightarrow y'|_{x=2} = f'(g(2))g'(2) = f'(3) \cdot 5 = (-1) \cdot 5 = -5$

86. $r = \sin(f(t))$, $f(0) = \frac{\pi}{3}$, $f'(0) = 4 \Rightarrow \frac{dr}{dt} = \cos(f(t)) \cdot f'(t) \Rightarrow \frac{dr}{dt}\Big|_{t=0} = \cos(f(0)) \cdot f'(0) = \cos\left(\frac{\pi}{3}\right) \cdot 4 = \left(\frac{1}{2}\right) \cdot 4 = 2$

87. (a) $y = 2f(x) \Rightarrow \frac{dy}{dx} = 2f'(x) \Rightarrow \frac{dy}{dx}\Big|_{x=2} = 2f'(2) = 2\left(\frac{1}{3}\right) = \frac{2}{3}$

(b) $y = f(x) + g(x) \Rightarrow \frac{dy}{dx} = f'(x) + g'(x) \Rightarrow \frac{dy}{dx}\Big|_{x=3} = f'(3) + g'(3) = 2\pi + 5$

(c) $y = f(x) \cdot g(x) \Rightarrow \frac{dy}{dx} = f(x)g'(x) + g(x)f'(x) \Rightarrow \frac{dy}{dx}\Big|_{x=3} = f(3)g'(3) + g(3)f'(3) = 3 \cdot 5 + (-4)(2\pi) = 15 - 8\pi$

(d) $y = \frac{f(x)}{g(x)} \Rightarrow \frac{dy}{dx} = \frac{g(x)f'(x) - f(x)g'(x)}{[g(x)]^2} \Rightarrow \frac{dy}{dx}\Big|_{x=2} = \frac{g(2)f'(2) - f(2)g'(2)}{[g(2)]^2} = \frac{(2)\left(\frac{1}{3}\right) - (8)(-3)}{2^2} = \frac{37}{6}$

(e) $y = f(g(x)) \Rightarrow \frac{dy}{dx} = f'(g(x))g'(x) \Rightarrow \frac{dy}{dx}\Big|_{x=2} = f'(g(2))g'(2) = f'(2)(-3) = \frac{1}{3}(-3) = -1$

(f) $y = (f(x))^{1/2} \Rightarrow \frac{dy}{dx} = \frac{1}{2}(f(x))^{-1/2} \cdot f'(x) = \frac{f'(x)}{2\sqrt{f(x)}} \Rightarrow \frac{dy}{dx}\Big|_{x=2} = \frac{f'(2)}{2\sqrt{f(2)}} = \frac{\left(\frac{1}{3}\right)}{2\sqrt{8}} = \frac{1}{6\sqrt{8}} = \frac{1}{12\sqrt{2}} = \frac{\sqrt{2}}{24}$

(g) $y = (g(x))^{-2} \Rightarrow \frac{dy}{dx} = -2(g(x))^{-3} \cdot g'(x) \Rightarrow \frac{dy}{dx}\Big|_{x=3} = -2(g(3))^{-3} g'(3) = -2(-4)^{-3} \cdot 5 = \frac{5}{32}$

(h) $y = ((f(x))^2 + (g(x))^2)^{1/2} \Rightarrow \frac{dy}{dx} = \frac{1}{2}((f(x))^2 + (g(x))^2)^{-1/2} (2f(x) \cdot f'(x) + 2g(x) \cdot g'(x)) \Rightarrow \frac{dy}{dx}\Big|_{x=2} = \frac{1}{2}((f(2))^2 + (g(2))^2)^{-1/2} (2f(2)f'(2) + 2g(2)g'(2)) = \frac{1}{2}(8^2 + 2^2)^{-1/2} (2 \cdot 8 \cdot \frac{1}{3} + 2 \cdot 2 \cdot (-3)) = -\frac{5}{3\sqrt{17}}$

88. (a) $y = 5f(x) - g(x) \Rightarrow \frac{dy}{dx} = 5f'(x) - g'(x) \Rightarrow \frac{dy}{dx}\Big|_{x=1} = 5f'(1) - g'(1) = 5\left(-\frac{1}{3}\right) - \left(-\frac{8}{3}\right) = 1$

(b) $y = f(x)(g(x))^3 \Rightarrow \frac{dy}{dx} = f(x)(3(g(x))^2 g'(x)) + (g(x))^3 f'(x) \Rightarrow \frac{dy}{dx}\Big|_{x=0} = 3f(0)(g(0))^2 g'(0) + (g(0))^3 f'(0) = 3(1)(1)^2 \left(\frac{1}{3}\right) + (1)^3 (5) = 6$

(c) $y = \frac{f(x)}{g(x)+1} \Rightarrow \frac{dy}{dx} = \frac{(g(x)+1)f'(x) - f(x)g'(x)}{(g(x)+1)^2} \Rightarrow \frac{dy}{dx}\Big|_{x=1} = \frac{(g(1)+1)f'(1) - f(1)g'(1)}{(g(1)+1)^2} = \frac{(-4+1)\left(-\frac{1}{3}\right) - (3)\left(-\frac{8}{3}\right)}{(-4+1)^2} = 1$

(d) $y = f(g(x)) \Rightarrow \frac{dy}{dx} = f'(g(x))g'(x) \Rightarrow \frac{dy}{dx}\Big|_{x=0} = f'(g(0))g'(0) = f'(1)\left(\frac{1}{3}\right) = \left(-\frac{1}{3}\right)\left(\frac{1}{3}\right) = -\frac{1}{9}$

(e) $y = g(f(x)) \Rightarrow \frac{dy}{dx} = g'(f(x))f'(x) \Rightarrow \frac{dy}{dx}\Big|_{x=0} = g'(f(0))f'(0) = g'(1)(5) = \left(-\frac{8}{3}\right)(5) = -\frac{40}{3}$

$$(f) \quad y = (x^{11} + f(x))^{-2} \Rightarrow \frac{dy}{dx} = -2(x^{11} + f(x))^{-3} (11x^{10} + f'(x)) \Rightarrow \left. \frac{dy}{dx} \right|_{x=1} = -2(1 + f(1))^{-3} (11 + f'(1)) \\ = -2(1 + 3)^{-3} \left(11 - \frac{1}{3}\right) = \left(-\frac{2}{4^3}\right) \left(\frac{32}{3}\right) = -\frac{1}{3}$$

$$(g) \quad y = f(x + g(x)) \Rightarrow \frac{dy}{dx} = f'(x + g(x))(1 + g'(x)) \Rightarrow \left. \frac{dy}{dx} \right|_{x=0} = f'(0 + g(0))(1 + g'(0)) = f'(1) \left(1 + \frac{1}{3}\right) \\ = \left(-\frac{1}{3}\right) \left(\frac{4}{3}\right) = -\frac{4}{9}$$

$$89. \quad \frac{ds}{dt} = \frac{ds}{d\theta} \cdot \frac{d\theta}{dt}; \quad s = \cos \theta \Rightarrow \frac{ds}{d\theta} = -\sin \theta \Rightarrow \left. \frac{ds}{d\theta} \right|_{\theta=\frac{3\pi}{2}} = -\sin\left(\frac{3\pi}{2}\right) = 1 \text{ so that } \frac{ds}{dt} = \frac{ds}{d\theta} \cdot \frac{d\theta}{dt} = 1 \cdot 5 = 5$$

$$90. \quad \frac{dy}{dt} = \frac{dy}{dx} \cdot \frac{dx}{dt}; \quad y = x^2 + 7x - 5 \Rightarrow \frac{dy}{dx} = 2x + 7 \Rightarrow \left. \frac{dy}{dx} \right|_{x=1} = 9 \text{ so that } \frac{dy}{dt} = \frac{dy}{dx} \cdot \frac{dx}{dt} = 9 \cdot \frac{1}{3} = 3$$

91. With $y = x$, we should get $\frac{dy}{dx} = 1$ for both (a) and (b):

$$(a) \quad y = \frac{u}{5} + 7 \Rightarrow \frac{dy}{du} = \frac{1}{5}; \quad u = 5x - 35 \Rightarrow \frac{du}{dx} = 5; \text{ therefore, } \frac{dy}{dx} = \frac{dy}{du} \cdot \frac{du}{dx} = \frac{1}{5} \cdot 5 = 1, \text{ as expected}$$

$$(b) \quad y = 1 + \frac{1}{u} \Rightarrow \frac{dy}{du} = -\frac{1}{u^2}; \quad u = (x-1)^{-1} \Rightarrow \frac{du}{dx} = -(x-1)^{-2} (1) = \frac{-1}{(x-1)^2}; \text{ therefore } \frac{dy}{dx} = \frac{dy}{du} \cdot \frac{du}{dx} = \frac{-1}{u^2} \cdot \frac{-1}{(x-1)^2} \\ = \frac{-1}{(x-1)^2} \cdot \frac{-1}{(x-1)^2} = (x-1)^2 \cdot \frac{1}{(x-1)^2} = 1, \text{ again as expected}$$

92. With $y = x^{3/2}$, we should get $\frac{dy}{dx} = \frac{3}{2}x^{1/2}$ for both (a) and (b):

$$(a) \quad y = u^3 \Rightarrow \frac{dy}{du} = 3u^2; \quad u = \sqrt{x} \Rightarrow \frac{du}{dx} = \frac{1}{2\sqrt{x}}; \text{ therefore, } \frac{dy}{dx} = \frac{dy}{du} \cdot \frac{du}{dx} = 3u^2 \cdot \frac{1}{2\sqrt{x}} = 3(\sqrt{x})^2 \cdot \frac{1}{2\sqrt{x}} = \frac{3}{2}\sqrt{x}, \\ \text{as expected.}$$

$$(b) \quad y = \sqrt{u} \Rightarrow \frac{dy}{du} = \frac{1}{2\sqrt{u}}; \quad u = x^3 \Rightarrow \frac{du}{dx} = 3x^2; \text{ therefore, } \frac{dy}{dx} = \frac{dy}{du} \cdot \frac{du}{dx} = \frac{1}{2\sqrt{u}} \cdot 3x^2 = \frac{1}{2\sqrt{x^3}} \cdot 3x^2 = \frac{3}{2}x^{1/2}, \\ \text{again as expected.}$$

$$93. \quad y = \left(\frac{x-1}{x+1}\right)^2 \text{ and } x = 0 \Rightarrow y = \left(\frac{0-1}{0+1}\right)^2 = (-1)^2 = 1. \quad y' = 2\left(\frac{x-1}{x+1}\right) \cdot \frac{(x+1) \cdot 1 - (x-1) \cdot 1}{(x+1)^2} = 2\left(\frac{x-1}{x+1}\right) \cdot \frac{2}{(x+1)^2} = \frac{4(x-1)}{(x+1)^3} \\ y' \Big|_{x=0} = \frac{4(0-1)}{(0+1)^3} = \frac{-4}{1^3} = -4 \Rightarrow y - 1 = -4(x - 0) \Rightarrow y = -4x + 1$$

$$94. \quad y = \sqrt{x^2 - x + 7} \text{ and } x = 2 \Rightarrow y = \sqrt{(2)^2 - (2) + 7} = \sqrt{9} = 3. \quad y' = \frac{1}{2}(x^2 - x + 7)^{-1/2} (2x - 1) = \frac{2x - 1}{2\sqrt{x^2 - x + 7}} \\ y' \Big|_{x=2} = \frac{2(2) - 1}{2\sqrt{(2)^2 - (2) + 7}} = \frac{3}{6} = \frac{1}{2} \Rightarrow y - 3 = \frac{1}{2}(x - 2) \Rightarrow y = \frac{1}{2}x + 2$$

$$95. \quad y = 2 \tan\left(\frac{\pi x}{4}\right) \Rightarrow \frac{dy}{dx} = \left(2 \sec^2 \frac{\pi x}{4}\right) \left(\frac{\pi}{4}\right) = \frac{\pi}{2} \sec^2 \frac{\pi x}{4}$$

$$(a) \quad \left. \frac{dy}{dx} \right|_{x=1} = \frac{\pi}{2} \sec^2\left(\frac{\pi}{4}\right) = \pi \Rightarrow \text{slope of tangent is } \pi; \text{ thus, } y(1) = 2 \tan\left(\frac{\pi}{4}\right) = 2 \text{ and } y'(1) = \pi \Rightarrow \text{tangent line is} \\ \text{given by } y - 2 = \pi(x - 1) \Rightarrow y = \pi x + 2 - \pi$$

$$(b) \quad y' = \frac{\pi}{2} \sec^2\left(\frac{\pi x}{4}\right) \text{ and the smallest value the secant function can have in } -2 < x < 2 \text{ is } 1 \Rightarrow \text{the minimum} \\ \text{value of } y' \text{ is } \frac{\pi}{2} \text{ and that occurs when } \frac{\pi}{2} = \frac{\pi}{2} \sec^2\left(\frac{\pi x}{4}\right) \Rightarrow 1 = \sec^2\left(\frac{\pi x}{4}\right) \Rightarrow \pm 1 = \sec\left(\frac{\pi x}{4}\right) \Rightarrow x = 0.$$

$$96. \quad (a) \quad y = \sin 2x \Rightarrow y' = 2 \cos 2x \Rightarrow y'(0) = 2 \cos(0) = 2 \Rightarrow \text{tangent to } y = \sin 2x \text{ at the origin is } y = 2x; \\ y = -\sin\left(\frac{x}{2}\right) \Rightarrow y' = -\frac{1}{2} \cos\left(\frac{x}{2}\right) \Rightarrow y'(0) = -\frac{1}{2} \cos 0 = -\frac{1}{2} \Rightarrow \text{tangent to } y = -\sin\left(\frac{x}{2}\right) \text{ at the origin is} \\ y = -\frac{1}{2}x. \text{ The tangents are perpendicular to each other at the origin since the product of their slopes is } -1.$$

- (b) $y = \sin(mx) \Rightarrow y' = m \cos(mx) \Rightarrow y'(0) = m \cos 0 = m$; $y = -\sin\left(\frac{x}{m}\right) \Rightarrow y' = -\frac{1}{m} \cos\left(\frac{x}{m}\right) \Rightarrow y'(0) = -\frac{1}{m} \cos(0) = -\frac{1}{m}$. Since $m \cdot \left(-\frac{1}{m}\right) = -1$, the tangent lines are perpendicular at the origin.
- (c) $y = \sin(mx) \Rightarrow y' = m \cos(mx)$. The largest value $\cos(mx)$ can attain is 1 at $x = 0 \Rightarrow$ the largest value y' can attain is $|m|$ because $|y'| = |m \cos(mx)| = |m| |\cos mx| \leq |m| \cdot 1 = |m|$. Also, $y = -\sin\left(\frac{x}{m}\right) \Rightarrow y' = -\frac{1}{m} \cos\left(\frac{x}{m}\right) \Rightarrow |y'| = \left|-\frac{1}{m} \cos\left(\frac{x}{m}\right)\right| \leq \left|\frac{1}{m}\right| \left|\cos\left(\frac{x}{m}\right)\right| \leq \frac{1}{|m|} \Rightarrow$ the largest value y' can attain is $\left|\frac{1}{m}\right|$.
- (d) $y = \sin(mx) \Rightarrow y' = m \cos(mx) \Rightarrow y'(0) = m \Rightarrow$ slope of curve at the origin is m . Also, $\sin(mx)$ completes m periods on $[0, 2\pi]$. Therefore the slope of the curve $y = \sin(mx)$ at the origin is the same as the number of periods it completes on $[0, 2\pi]$. In particular, for large m , we can think of “compressing” the graph of $y = \sin x$ horizontally which gives more periods completed on $[0, 2\pi]$, but also increases the slope of the graph at the origin.
97. $s = A \cos(2\pi bt) \Rightarrow v = \frac{ds}{dt} = -A \sin(2\pi bt)(2\pi b) = -2\pi b A \sin(2\pi bt)$. If we replace b with $2b$ to double the frequency, the velocity formula gives $v = -4\pi b A \sin(4\pi bt) \Rightarrow$ doubling the frequency causes the velocity to double. Also $v = -2\pi b A \sin(2\pi bt) \Rightarrow a = \frac{dv}{dt} = -4\pi^2 b^2 A \cos(2\pi bt)$. If we replace b with $2b$ in the acceleration formula, we get $a = -16\pi^2 b^2 A \cos(4\pi bt) \Rightarrow$ doubling the frequency causes the acceleration to quadruple. Finally, $a = -4\pi^2 b^2 A \cos(2\pi bt) \Rightarrow j = \frac{da}{dt} = 8\pi^3 b^3 A \sin(2\pi bt)$. If we replace b with $2b$ in the jerk formula, we get $j = 64\pi^3 b^3 A \sin(4\pi bt) \Rightarrow$ doubling the frequency multiplies the jerk by a factor of 8.
98. (a) $y = 37 \sin\left[\frac{2\pi}{365}(x-101)\right] + 25 \Rightarrow y' = 37 \cos\left[\frac{2\pi}{365}(x-101)\right] \left(\frac{2\pi}{365}\right) = \frac{74\pi}{365} \cos\left[\frac{2\pi}{365}(x-101)\right]$. The temperature is increasing the fastest when y' is as large as possible. The largest value of $\cos\left[\frac{2\pi}{365}(x-101)\right]$ is 1 and occurs when $\frac{2\pi}{365}(x-101) = 0 \Rightarrow x = 101 \Rightarrow$ on day 101 of the year (\sim April 11), the temperature is increasing the fastest.
- (b) $y'(101) = \frac{74\pi}{365} \cos\left[\frac{2\pi}{365}(101-101)\right] = \frac{74\pi}{365} \cos(0) = \frac{74\pi}{365} \approx 0.64^\circ \text{ F/day}$
99. $s = (1+4t)^{1/2} \Rightarrow v = \frac{ds}{dt} = \frac{1}{2}(1+4t)^{-1/2}(4) = 2(1+4t)^{-1/2} \Rightarrow v(6) = 2(1+4 \cdot 6)^{-1/2} = \frac{2}{5} \text{ m/sec}$; $v = 2(1+4t)^{-1/2} \Rightarrow a = \frac{dv}{dt} = -\frac{1}{2} \cdot 2(1+4t)^{-3/2}(4) = -4(1+4t)^{-3/2} \Rightarrow a(6) = -4(1+4 \cdot 6)^{-3/2} = -\frac{4}{125} \text{ m/sec}^2$
100. We need to show $a = \frac{dv}{dt}$ is constant: $a = \frac{dv}{dt} = \frac{dv}{ds} \cdot \frac{ds}{dt}$ and $\frac{dv}{ds} = \frac{d}{ds}(k\sqrt{s}) = \frac{k}{2\sqrt{s}} \Rightarrow a = \frac{dv}{ds} \cdot \frac{ds}{dt} = \frac{dv}{ds} \cdot v = \frac{k}{2\sqrt{s}} \cdot k\sqrt{s} = \frac{k^2}{2}$ which is a constant.
101. v proportional to $\frac{1}{\sqrt{s}} \Rightarrow v = \frac{k}{\sqrt{s}}$ for some constant $k \Rightarrow \frac{dv}{ds} = -\frac{k}{2s^{3/2}}$. Thus, $a = \frac{dv}{dt} = \frac{dv}{ds} \cdot \frac{ds}{dt} = \frac{dv}{ds} \cdot v = -\frac{k}{2s^{3/2}} \cdot \frac{k}{\sqrt{s}} = -\frac{k^2}{2} \left(\frac{1}{s^2}\right) \Rightarrow$ acceleration is a constant times $\frac{1}{s^2}$ so a is inversely proportional to s^2 .
102. Let $\frac{dx}{dt} = f(x)$. Then, $a = \frac{dv}{dt} = \frac{dv}{dx} \cdot \frac{dx}{dt} = \frac{dv}{dx} \cdot f(x) = \frac{d}{dx}\left(\frac{dx}{dt}\right) \cdot f(x) = \frac{d}{dx}(f(x)) \cdot f(x) = f'(x)f(x)$, as required.
103. $T = 2\pi\sqrt{\frac{L}{g}} \Rightarrow \frac{dT}{dL} = 2\pi \cdot \frac{1}{2\sqrt{\frac{L}{g}}} \cdot \frac{1}{g} = \frac{\pi}{g\sqrt{\frac{L}{g}}} = \frac{\pi}{\sqrt{gL}}$. Therefore, $\frac{dT}{du} = \frac{dT}{dL} \cdot \frac{dL}{du} = \frac{\pi}{\sqrt{gL}} \cdot kL = \frac{\pi k\sqrt{L}}{\sqrt{g}} = \frac{1}{2} \cdot 2\pi k\sqrt{\frac{L}{g}} = \frac{kT}{2}$, as required.
104. No. The chain rule says that when g is differentiable at 0 and f is differentiable at $g(0)$, then $f \circ g$ is differentiable at 0. But the chain rule says nothing about what happens when g is not differentiable at 0 so there is no contradiction.

105. As $h \rightarrow 0$, the graph of $y = \frac{\sin 2(x+h) - \sin 2x}{h}$ approaches the graph of $y = 2 \cos 2x$ because $\lim_{h \rightarrow 0} \frac{\sin 2(x+h) - \sin 2x}{h} = \frac{d}{dx}(\sin 2x) = 2 \cos 2x$.

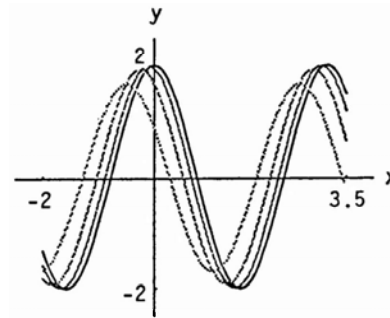

106. As $h \rightarrow 0$, the graph of $y = \frac{\cos[(x+h)^2] - \cos(x^2)}{h}$ approaches the graph of $y = -2x \sin(x^2)$ because $\lim_{h \rightarrow 0} \frac{\cos[(x+h)^2] - \cos(x^2)}{h} = \frac{d}{dx}[\cos(x^2)] = -2x \sin(x^2)$.

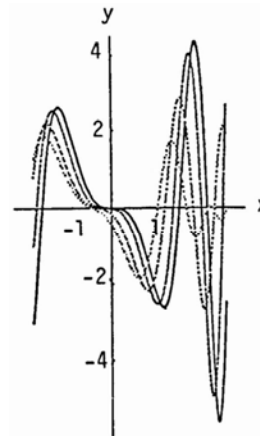

107. From the power rule, with $y = x^{1/4}$, we get $\frac{dy}{dx} = \frac{1}{4}x^{-3/4}$. From the chain rule, $y = \sqrt{\sqrt{x}}$
 $\Rightarrow \frac{dy}{dx} = \frac{1}{2\sqrt{x\sqrt{x}}} \cdot \frac{d}{dx}(\sqrt{x}) = \frac{1}{2\sqrt{x\sqrt{x}}} \cdot \frac{1}{2\sqrt{x}} = \frac{1}{4}x^{-3/4}$, in agreement.

108. From the power rule, with $y = x^{3/4}$, we get $\frac{dy}{dx} = \frac{3}{4}x^{-1/4}$. From the chain rule, $y = \sqrt{x\sqrt{x}}$
 $\Rightarrow \frac{dy}{dx} = \frac{1}{2\sqrt{x\sqrt{x}}} \cdot \frac{d}{dx}(x\sqrt{x})$
 $\Rightarrow \frac{dy}{dx} = \frac{1}{2\sqrt{x\sqrt{x}}} \cdot \left(x \cdot \frac{1}{2\sqrt{x}} + \sqrt{x}\right) = \frac{1}{2\sqrt{x\sqrt{x}}} \cdot \left(\frac{3}{2}\sqrt{x}\right) = \frac{3\sqrt{x}}{4\sqrt{x\sqrt{x}}} = \frac{3\sqrt{x}}{4\sqrt{x}\sqrt{\sqrt{x}}} = \frac{3}{4}x^{-1/4}$, in agreement.

109. (a)

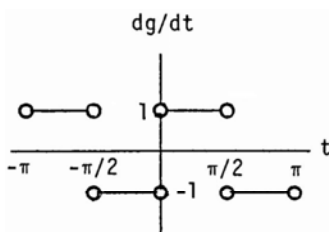

- (b) $\frac{df}{dt} = 1.27324 \sin 2t + 0.42444 \sin 6t + 0.2546 \sin 10t + 0.18186 \sin 14t$

- (c) The curve of $y = \frac{df}{dt}$ approximates $y = \frac{dg}{dt}$ the best when t is not $-\pi, -\frac{\pi}{2}, 0, \frac{\pi}{2},$ nor π .

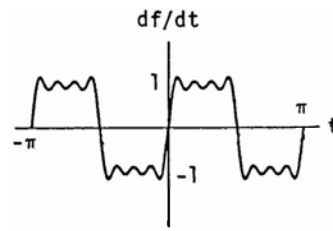

110. (a)

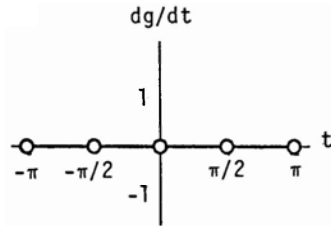

- (b) $\frac{dh}{dt} = 2.5464 \cos(2t) + 2.5464 \cos(6t) + 2.5465 \cos(10t) + 2.54646 \cos(14t) + 2.54646 \cos(18t)$
 (c)

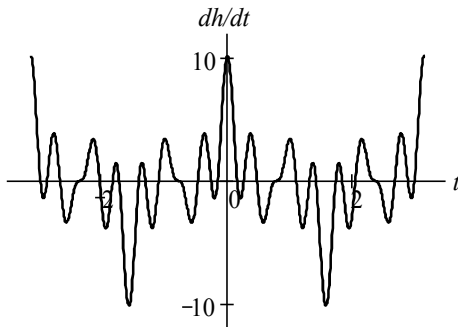

3.7 IMPLICIT DIFFERENTIATION

1. $x^2y + xy^2 = 6 :$

Step 1: $\left(x^2 \frac{dy}{dx} + y \cdot 2x\right) + \left(x \cdot 2y \frac{dy}{dx} + y^2 \cdot 1\right) = 0$

Step 2: $x^2 \frac{dy}{dx} + 2xy \frac{dy}{dx} = -2xy - y^2$

Step 3: $\frac{dy}{dx}(x^2 + 2xy) = -2xy - y^2$

Step 4: $\frac{dy}{dx} = \frac{-2xy - y^2}{x^2 + 2xy}$

2. $x^3 + y^3 = 18xy \Rightarrow 3x^2 + 3y^2 \frac{dy}{dx} = 18y + 18x \frac{dy}{dx} \Rightarrow (3y^2 - 18x) \frac{dy}{dx} = 18y - 3x^2 \Rightarrow \frac{dy}{dx} = \frac{6y - x^2}{y^2 - 6x}$

3. $2xy + y^2 = x + y :$

Step 1: $\left(2x \frac{dy}{dx} + 2y\right) + 2y \frac{dy}{dx} = 1 + \frac{dy}{dx}$

Step 2: $2x \frac{dy}{dx} + 2y \frac{dy}{dx} - \frac{dy}{dx} = 1 - 2y$

Step 3: $\frac{dy}{dx}(2x + 2y - 1) = 1 - 2y$

Step 4: $\frac{dy}{dx} = \frac{1 - 2y}{2x + 2y - 1}$

4. $x^3 - xy + y^3 = 1 \Rightarrow 3x^2 - y - x \frac{dy}{dx} + 3y^2 \frac{dy}{dx} = 0 \Rightarrow (3y^2 - x) \frac{dy}{dx} = y - 3x^2 \Rightarrow \frac{dy}{dx} = \frac{y - 3x^2}{3y^2 - x}$
5. $x^2(x - y)^2 = x^2 - y^2$:
 Step 1: $x^2 \left[2(x - y) \left(1 - \frac{dy}{dx} \right) \right] + (x - y)^2 (2x) = 2x - 2y \frac{dy}{dx}$
 Step 2: $-2x^2(x - y) \frac{dy}{dx} + 2y \frac{dy}{dx} = 2x - 2x^2(x - y) - 2x(x - y)^2$
 Step 3: $\frac{dy}{dx} \left[-2x^2(x - y) + 2y \right] = 2x \left[1 - x(x - y) - (x - y)^2 \right]$
 Step 4: $\frac{dy}{dx} = \frac{2x \left[1 - x(x - y) - (x - y)^2 \right]}{-2x^2(x - y) + 2y} = \frac{x \left[1 - x(x - y) - (x - y)^2 \right]}{y - x^2(x - y)} = \frac{x(1 - x^2 + xy - x^2 + 2xy - y^2)}{x^2y - x^3 + y} = \frac{x - 2x^3 + 3x^2y - xy^2}{x^2y - x^3 + y}$
6. $(3xy + 7)^2 = 6y \Rightarrow 2(3xy + 7) \cdot \left(3x \frac{dy}{dx} + 3y \right) = 6 \frac{dy}{dx} \Rightarrow 2(3xy + 7)(3x) \frac{dy}{dx} - 6 \frac{dy}{dx} = -6y(3xy + 7)$
 $\Rightarrow \frac{dy}{dx} [6x(3xy + 7) - 6] = -6y(3xy + 7) \Rightarrow \frac{dy}{dx} = -\frac{y(3xy + 7)}{x(3xy + 7) - 1} = \frac{3xy^2 + 7y}{1 - 3x^2y - 7x}$
7. $y^2 = \frac{x-1}{x+1} \Rightarrow 2y \frac{dy}{dx} = \frac{(x+1) - (x-1)}{(x+1)^2} = \frac{2}{(x+1)^2} \Rightarrow \frac{dy}{dx} = \frac{1}{y(x+1)^2}$
8. $x^3 = \frac{2x-y}{x+3y} \Rightarrow x^4 + 3x^3y = 2x - y \Rightarrow 4x^3 + 9x^2y + 3x^3y' = 2 - y' \Rightarrow (3x^3 + 1)y' = 2 - 4x^3 - 9x^2y$
 $\Rightarrow y' = \frac{2 - 4x^3 - 9x^2y}{3x^3 + 1}$
9. $x = \tan y \Rightarrow 1 = (\sec^2 y) \frac{dy}{dx} \Rightarrow \frac{dy}{dx} = \frac{1}{\sec^2 y} = \cos^2 y$
10. $xy = \cot(xy) \Rightarrow x \frac{dy}{dx} + y = -\csc^2(xy) \left(x \frac{dy}{dx} + y \right) \Rightarrow x \frac{dy}{dx} + x \csc^2(xy) \frac{dy}{dx} = -y \csc^2(xy) - y$
 $\Rightarrow \frac{dy}{dx} \left[x + x \csc^2(xy) \right] = -y \left[\csc^2(xy) + 1 \right] \Rightarrow \frac{dy}{dx} = \frac{-y \left[\csc^2(xy) + 1 \right]}{x \left[1 + \csc^2(xy) \right]} = -\frac{y}{x}$
11. $x + \tan(xy) = 0 \Rightarrow 1 + \left[\sec^2(xy) \right] \left(y + x \frac{dy}{dx} \right) = 0 \Rightarrow x \sec^2(xy) \frac{dy}{dx} = -1 - y \sec^2(xy) \Rightarrow \frac{dy}{dx} = \frac{-1 - y \sec^2(xy)}{x \sec^2(xy)}$
 $= \frac{-1}{x \sec^2(xy)} - \frac{y}{x} = \frac{-\cos^2(xy)}{x} - \frac{y}{x} = \frac{-\cos^2(xy) - y}{x}$
12. $x^4 + \sin y = x^3y^2 \Rightarrow 4x^3 + (\cos y) \frac{dy}{dx} = 3x^2y^2 + x^3 \cdot 2y \frac{dy}{dx} \Rightarrow (\cos y - 2x^3y) \frac{dy}{dx} = 3x^2y^2 - 4x^3 \Rightarrow \frac{dy}{dx} = \frac{3x^2y^2 - 4x^3}{\cos y - 2x^3y}$
13. $y \sin\left(\frac{1}{y}\right) = 1 - xy \Rightarrow y \left[\cos\left(\frac{1}{y}\right) \cdot \left(-1\right) \frac{1}{y^2} \cdot \frac{dy}{dx} \right] + \sin\left(\frac{1}{y}\right) \cdot \frac{dy}{dx} = -x \frac{dy}{dx} - y \Rightarrow \frac{dy}{dx} \left[-\frac{1}{y} \cos\left(\frac{1}{y}\right) + \sin\left(\frac{1}{y}\right) + x \right] = -y$
 $\Rightarrow \frac{dy}{dx} = \frac{-y}{-\frac{1}{y} \cos\left(\frac{1}{y}\right) + \sin\left(\frac{1}{y}\right) + x} = \frac{-y^2}{y \sin\left(\frac{1}{y}\right) - \cos\left(\frac{1}{y}\right) + xy}$
14. $x \cos(2x + 3y) = y \sin x \Rightarrow -x \sin(2x + 3y)(2 + 3y') + \cos(2x + 3y) = y \cos x + y' \sin x$
 $\Rightarrow -2x \sin(2x + 3y) - 3xy' \sin(2x + 3y) + \cos(2x + 3y) = y \cos x + y' \sin x$
 $\Rightarrow \cos(2x + 3y) - 2x \sin(2x + 3y) - y \cos x = (\sin x + 3x \sin(2x + 3y))y'$
 $\Rightarrow y' = \frac{\cos(2x + 3y) - 2x \sin(2x + 3y) - y \cos x}{\sin x + 3x \sin(2x + 3y)}$

$$15. e^{2x} = \sin(x+3y) \Rightarrow 2e^{2x} = (1+3y') \cos(x+3y) \Rightarrow 1+3y' = \frac{2e^{2x}}{\cos(x+3y)} \Rightarrow 3y' = \frac{2e^{2x}}{\cos(x+3y)} - 1$$

$$\Rightarrow y' = \frac{2e^{2x} - \cos(x+3y)}{3\cos(x+3y)}$$

$$16. e^{x^2y} = 2x+2y \Rightarrow e^{x^2y}(x^2y'+2xy) = 2+2y' \Rightarrow x^2e^{x^2y}y' + 2xye^{x^2y} = 2+2y' \Rightarrow x^2e^{x^2y}y' - 2y' = 2 - 2xye^{x^2y}$$

$$\Rightarrow y' = \frac{2-2xye^{x^2y}}{x^2e^{x^2y}-2}$$

$$17. \theta^{1/2} + r^{1/2} = 1 \Rightarrow \frac{1}{2}\theta^{-1/2} + \frac{1}{2}r^{-1/2} \cdot \frac{dr}{d\theta} = 0 \Rightarrow \frac{dr}{d\theta} \left[\frac{1}{2\sqrt{r}} \right] = \frac{-1}{2\sqrt{\theta}} \Rightarrow \frac{dr}{d\theta} = -\frac{2\sqrt{r}}{2\sqrt{\theta}} = -\frac{\sqrt{r}}{\sqrt{\theta}}$$

$$18. r - 2\sqrt{\theta} = \frac{2}{3}\theta^{2/3} + \frac{4}{3}\theta^{3/4} \Rightarrow \frac{dr}{d\theta} - \theta^{-1/2} = \theta^{-1/3} + \theta^{-1/4} \Rightarrow \frac{dr}{d\theta} = \theta^{-1/2} + \theta^{-1/3} + \theta^{-1/4}$$

$$19. \sin(r\theta) = \frac{1}{2} \Rightarrow [\cos(r\theta)] \left(r + \theta \frac{dr}{d\theta} \right) = 0 \Rightarrow \frac{dr}{d\theta} [\theta \cos(r\theta)] = -r \cos(r\theta) \Rightarrow \frac{dr}{d\theta} = \frac{-r \cos(r\theta)}{\theta \cos(r\theta)} = -\frac{r}{\theta}, \cos(r\theta) \neq 0$$

$$20. \cos r + \cot \theta = e^{r\theta} \Rightarrow (-\sin r) - \csc^2 \theta = e^{r\theta} \left(r + \theta \frac{dr}{d\theta} \right) \Rightarrow (-\sin r) \frac{dr}{d\theta} - \csc^2 \theta = re^{r\theta} + \theta e^{r\theta} \frac{dr}{d\theta}$$

$$\Rightarrow -\sin r \frac{dr}{d\theta} - \theta e^{r\theta} \frac{dr}{d\theta} = re^{r\theta} + \csc^2 \theta \Rightarrow \frac{dr}{d\theta} = -\frac{re^{r\theta} + \csc^2 \theta}{\theta e^{r\theta} + \sin r}$$

$$21. x^2 + y^2 = 1 \Rightarrow 2x + 2yy' = 0 \Rightarrow 2yy' = -2x \Rightarrow \frac{dy}{dx} = y' = -\frac{x}{y}; \text{ now to find } \frac{d^2y}{dx^2}, \frac{d}{dx}(y') = \frac{d}{dx}\left(-\frac{x}{y}\right)$$

$$\Rightarrow y'' = \frac{y(-1) - xy'}{y^2} = \frac{-y + x\left(-\frac{x}{y}\right)}{y^2} \text{ since } y' = -\frac{x}{y} \Rightarrow \frac{d^2y}{dx^2} = y'' = \frac{-y^2 - x^2}{y^3} = \frac{-y^2 - (1-y^2)}{y^3} = \frac{-1}{y^3}$$

$$22. x^{2/3} + y^{2/3} = 1 \Rightarrow \frac{2}{3}x^{-1/3} + \frac{2}{3}y^{-1/3} \frac{dy}{dx} = 0 \Rightarrow \frac{dy}{dx} \left[\frac{2}{3}y^{-1/3} \right] = -\frac{2}{3}x^{-1/3} \Rightarrow y' = \frac{dy}{dx} = -\frac{x^{-1/3}}{y^{-1/3}} = -\left(\frac{y}{x}\right)^{1/3};$$

$$\text{Differentiating again, } y'' = \frac{x^{1/3} \cdot (-\frac{1}{3}y^{-2/3})y' + y^{1/3} \left(\frac{1}{3}x^{-2/3}\right)}{x^{2/3}} = \frac{x^{1/3} \cdot (-\frac{1}{3}y^{-2/3}) \left(-\frac{y^{1/3}}{x^{1/3}}\right) + y^{1/3} \left(\frac{1}{3}x^{-2/3}\right)}{x^{2/3}}$$

$$\Rightarrow \frac{d^2y}{dx^2} = \frac{1}{3}x^{-2/3}y^{-1/3} + \frac{1}{3}y^{1/3}x^{-4/3} = \frac{y^{1/3}}{3x^{4/3}} + \frac{1}{3y^{1/3}x^{2/3}}$$

$$23. y^2 = e^{x^2} + 2x \Rightarrow 2yy' = 2x + 2 = 2xe^{x^2} + 2 \Rightarrow \frac{dy}{dx} = \frac{xe^{x^2} + 1}{y} \Rightarrow \frac{d^2y}{dx^2} = \frac{y(2x^2e^{x^2} + e^{x^2}) - (xe^{x^2} + 1)y'}{y^2}$$

$$= \frac{y(2x^2e^{x^2}) - (xe^{x^2} + 1) \cdot \frac{xe^{x^2} + 1}{y}}{y^2} = \frac{(2x^2y^2 + y^2 - 2x)e^{x^2} - x^2e^{2x^2} - 1}{y^3}$$

$$24. y^2 - 2x = 1 - 2y \Rightarrow 2y \cdot y' - 2 = -2y' \Rightarrow y'(2y + 2) = 2 \Rightarrow y' = \frac{1}{y+1} = (y+1)^{-1}; \text{ then } y'' = -(y+1)^{-2} \cdot y'$$

$$= -(y+1)^{-2}(y+1)^{-1} \Rightarrow \frac{d^2y}{dx^2} = y'' = \frac{-1}{(y+1)^3}$$

$$25. 2\sqrt{y} = x - y \Rightarrow y^{-1/2}y' = 1 - y' \Rightarrow y'(y^{-1/2} + 1) = 1 \Rightarrow \frac{dy}{dx} = y' = \frac{1}{y^{-1/2} + 1} = \frac{\sqrt{y}}{\sqrt{y} + 1}; \text{ we can differentiate the}$$

$$\text{equation } y'(y^{-1/2} + 1) = 1 \text{ again to find } y'': y' \left(-\frac{1}{2}y^{-3/2}y'\right) + (y^{-1/2} + 1)y'' = 0 \Rightarrow (y^{-1/2} + 1)y'' = \frac{1}{2}[y']^2 y^{-3/2}$$

$$\Rightarrow \frac{d^2y}{dx^2} = y'' = \frac{\frac{1}{2} \left(\frac{1}{y^{-1/2} + 1}\right)^2 y^{-3/2}}{(y^{-1/2} + 1)} = \frac{1}{2y^{3/2}(y^{-1/2} + 1)^3} = \frac{1}{2(1 + \sqrt{y})^3}$$

26. $xy + y^2 = 1 \Rightarrow xy' + y + 2yy' = 0 \Rightarrow xy' + 2yy' = -y \Rightarrow y'(x + 2y) = -y \Rightarrow y' = \frac{-y}{(x+2y)}$;
 $\frac{d^2y}{dx^2} = y'' = \frac{-(x+2y)y' + y(1+2y')}{(x+2y)^2} = \frac{-(x+2y)\left[\frac{-y}{(x+2y)}\right] + y\left[1+2\left(\frac{-y}{(x+2y)}\right)\right]}{(x+2y)^2} = \frac{\frac{1}{(x+2y)}[y(x+2y) + y(x+2y) - 2y^2]}{(x+2y)^2} = \frac{2y(x+2y) - 2y^2}{(x+2y)^3}$
 $= \frac{2y^2 + 2xy}{(x+2y)^3} = \frac{2y(x+y)}{(x+2y)^3}$
27. $x^3 + y^3 = 16 \Rightarrow 3x^2 + 3y^2y' = 0 \Rightarrow 3y^2y' = -3x^2 \Rightarrow y' = -\frac{x^2}{y^2}$; we differentiate $y^2y' = -x^2$ to find y'' :
 $y^2y'' + y[2y \cdot y'] = -2x \Rightarrow y^2y'' = -2x - 2y[y']^2 \Rightarrow y'' = \frac{-2x - 2y\left(\frac{-x^2}{y^2}\right)^2}{y^2} = \frac{-2x - \frac{2x^4}{y^3}}{y^2} = \frac{-2xy^3 - 2x^4}{y^5}$
 $\Rightarrow \left.\frac{d^2y}{dx^2}\right|_{(2,2)} = \frac{-33-32}{32} = -2$
28. $xy + y^2 = 1 \Rightarrow xy' + y + 2yy' = 0 \Rightarrow y'(x + 2y) = -y \Rightarrow y' = \frac{-y}{(x+2y)} \Rightarrow y'' = \frac{(x+2y)(-y') - (-y)(1+2y')}{(x+2y)^2}$; since
 $y'\big|_{(0,-1)} = -\frac{1}{2}$ we obtain $y''\big|_{(0,-1)} = \frac{(-2)\left(\frac{1}{2}\right) - (-1)(0)}{4} = -\frac{1}{4}$
29. $y^2 + x^2 = y^4 - 2x$ at $(-2, 1)$ and $(-2, -1) \Rightarrow 2y\frac{dy}{dx} + 2x = 4y^3\frac{dy}{dx} - 2 \Rightarrow 2y\frac{dy}{dx} - 4y^3\frac{dy}{dx} = -2 - 2x$
 $\Rightarrow \frac{dy}{dx}(2y - 4y^3) = -2 - 2x \Rightarrow \frac{dy}{dx} = \frac{-x+1}{2y^3-y} \Rightarrow \left.\frac{dy}{dx}\right|_{(-2,1)} = -1$ and $\left.\frac{dy}{dx}\right|_{(-2,-1)} = 1$
30. $(x^2 + y^2)^2 = (x - y)^2$ at $(1, 0)$ and $(1, -1) \Rightarrow 2(x^2 + y^2)\left(2x + 2y\frac{dy}{dx}\right) = 2(x - y)\left(1 - \frac{dy}{dx}\right)$
 $\Rightarrow \frac{dy}{dx}[2y(x^2 + y^2) + (x - y)] = -2x(x^2 + y^2) + (x - y) \Rightarrow \frac{dy}{dx} = \frac{-2x(x^2 + y^2) + (x - y)}{2y(x^2 + y^2) + (x - y)} \Rightarrow \left.\frac{dy}{dx}\right|_{(1,0)} = -1$
and $\left.\frac{dy}{dx}\right|_{(1,-1)} = 1$
31. $x^2 + xy - y^2 = 1 \Rightarrow 2x + y + xy' - 2yy' = 0 \Rightarrow (x - 2y)y' = -2x - y \Rightarrow y' = \frac{2x+y}{2y-x}$;
(a) the slope of the tangent line $m = y'\big|_{(2,3)} = \frac{7}{4} \Rightarrow$ the tangent line is $y - 3 = \frac{7}{4}(x - 2) \Rightarrow y = \frac{7}{4}x - \frac{1}{2}$
(b) the normal line is $y - 3 = -\frac{4}{7}(x - 2) \Rightarrow y = -\frac{4}{7}x + \frac{29}{7}$
32. $x^2 + y^2 = 25 \Rightarrow 2x + 2yy' = 0 \Rightarrow y' = -\frac{x}{y}$;
(a) the slope of the tangent line $m = y'\big|_{(3,-4)} = -\frac{x}{y}\big|_{(3,-4)} = \frac{3}{4} \Rightarrow$
the tangent line is $y + 4 = \frac{3}{4}(x - 3) \Rightarrow y = \frac{3}{4}x - \frac{25}{4}$
(b) the normal line is $y + 4 = -\frac{4}{3}(x - 3) \Rightarrow y = -\frac{4}{3}x$
33. $x^2y^2 = 9 \Rightarrow 2xy^2 + 2x^2yy' = 0 \Rightarrow x^2yy' = -xy^2 \Rightarrow y' = -\frac{y}{x}$;
(a) the slope of the tangent line $m = y'\big|_{(-1,3)} = -\frac{y}{x}\big|_{(-1,3)} = 3 \Rightarrow$ the tangent line is $y - 3 = 3(x + 1) \Rightarrow y = 3x + 6$
(b) the normal line is $y - 3 = -\frac{1}{3}(x + 1) \Rightarrow y = -\frac{1}{3}x + \frac{8}{3}$

34. $y^2 - 2x - 4y - 1 = 0 \Rightarrow 2yy' - 2 - 4y' = 0 \Rightarrow 2(y-2)y' = 2 \Rightarrow y' = \frac{1}{y-2}$;
 (a) the slope of the tangent line $m = y'|_{(-2, 1)} = -1 \Rightarrow$ the tangent line is $y - 1 = -1(x + 2) \Rightarrow y = -x - 1$
 (b) the normal line is $y - 1 = 1(x + 2) \Rightarrow y = x + 3$
35. $6x^2 + 3xy + 2y^2 + 17y - 6 = 0 \Rightarrow 12x + 3y + 3xy' + 4yy' + 17y' = 0 \Rightarrow y'(3x + 4y + 17) = -12x - 3y$
 $\Rightarrow y' = \frac{-12x - 3y}{3x + 4y + 17}$;
 (a) the slope of the tangent line $m = y'|_{(-1, 0)} = \frac{-12x - 3y}{3x + 4y + 17}|_{(-1, 0)} = \frac{6}{7} \Rightarrow$ the tangent line is $y - 0 = \frac{6}{7}(x + 1)$
 $\Rightarrow y = \frac{6}{7}x + \frac{6}{7}$
 (b) the normal line is $y - 0 = -\frac{7}{6}(x + 1) \Rightarrow y = -\frac{7}{6}x - \frac{7}{6}$
36. $x^2 - \sqrt{3}xy + 2y^2 = 5 \Rightarrow 2x - \sqrt{3}xy' - \sqrt{3}y + 4yy' = 0 \Rightarrow y'(4y - \sqrt{3}x) = \sqrt{3}y - 2x \Rightarrow y' = \frac{\sqrt{3}y - 2x}{4y - \sqrt{3}x}$;
 (a) the slope of the tangent line $m = y'|_{(\sqrt{3}, 2)} = \frac{\sqrt{3}y - 2x}{4y - \sqrt{3}x}|_{(\sqrt{3}, 2)} = 0 \Rightarrow$ the tangent line is $y = 2$
 (b) the normal line is $x = \sqrt{3}$
37. $2xy + \pi \sin y = 2\pi \Rightarrow 2xy' + 2y + \pi(\cos y)y' = 0 \Rightarrow y'(2x + \pi \cos y) = -2y \Rightarrow y' = \frac{-2y}{2x + \pi \cos y}$;
 (a) the slope of the tangent line $m = y'|_{(1, \frac{\pi}{2})} = \frac{-2y}{2x + \pi \cos y}|_{(1, \frac{\pi}{2})} = -\frac{\pi}{2} \Rightarrow$ the tangent line is $y - \frac{\pi}{2} = -\frac{\pi}{2}(x - 1)$
 $\Rightarrow y = -\frac{\pi}{2}x + \pi$
 (b) the normal line is $y - \frac{\pi}{2} = \frac{2}{\pi}(x - 1) \Rightarrow y = \frac{2}{\pi}x - \frac{2}{\pi} + \frac{\pi}{2}$
38. $x \sin 2y = y \cos 2x \Rightarrow x(\cos 2y)2y' + \sin 2y = -2y \sin 2x + y' \cos 2x \Rightarrow y'(2x \cos 2y - \cos 2x)$
 $= -\sin 2y - 2y \sin 2x \Rightarrow y' = \frac{\sin 2y + 2y \sin 2x}{\cos 2x - 2x \cos 2y}$;
 (a) the slope of the tangent line $m = y'|_{(\frac{\pi}{4}, \frac{\pi}{2})} = \frac{\sin 2y + 2y \sin 2x}{\cos 2x - 2x \cos 2y}|_{(\frac{\pi}{4}, \frac{\pi}{2})} = \frac{\pi}{2} = 2 \Rightarrow$ the tangent line is
 $y - \frac{\pi}{2} = 2(x - \frac{\pi}{4}) \Rightarrow y = 2x$
 (b) the normal line is $y - \frac{\pi}{2} = -\frac{1}{2}(x - \frac{\pi}{4}) \Rightarrow y = -\frac{1}{2}x + \frac{5\pi}{8}$
39. $y = 2 \sin(\pi x - y) \Rightarrow y' = 2[\cos(\pi x - y)] \cdot (\pi - y') \Rightarrow y'[1 + 2 \cos(\pi x - y)] = 2\pi \cos(\pi x - y) \Rightarrow y' = \frac{2\pi \cos(\pi x - y)}{1 + 2 \cos(\pi x - y)}$;
 (a) the slope of the tangent line $m = y'|_{(1, 0)} = \frac{2\pi \cos(\pi x - y)}{1 + 2 \cos(\pi x - y)}|_{(1, 0)} = 2\pi \Rightarrow$ the tangent line is $y - 0 = 2\pi(x - 1)$
 $\Rightarrow y = 2\pi x - 2\pi$
 (b) the normal line is $y - 0 = -\frac{1}{2\pi}(x - 1) \Rightarrow y = -\frac{x}{2\pi} + \frac{1}{2\pi}$
40. $x^2 \cos^2 y - \sin y = 0 \Rightarrow x^2(2 \cos y)(-\sin y)y' + 2x \cos^2 y - y' \cos y = 0 \Rightarrow y'[-2x^2 \cos y \sin y - \cos y]$
 $= -2x \cos^2 y \Rightarrow y' = \frac{2x \cos^2 y}{2x^2 \cos y \sin y + \cos y}$;
 (a) the slope of the tangent line $m = y'|_{(0, \pi)} = \frac{2x \cos^2 y}{2x^2 \cos y \sin y + \cos y}|_{(0, \pi)} = 0 \Rightarrow$ the tangent line is $y = \pi$
 (b) the normal line is $x = 0$

41. Solving $x^2 + xy + y^2 = 7$ and $y = 0 \Rightarrow x^2 = 7 \Rightarrow x = \pm\sqrt{7} \Rightarrow (-\sqrt{7}, 0)$ and $(\sqrt{7}, 0)$ are the points where the curve crosses the x -axis. Now $x^2 + xy + y^2 = 7 \Rightarrow 2x + y + xy' + 2yy' = 0 \Rightarrow (x + 2y)y' = -2x - y \Rightarrow y' = -\frac{2x+y}{x+2y}$
 $\Rightarrow m = -\frac{2x+y}{x+2y} \Rightarrow$ the slope at $(-\sqrt{7}, 0)$ is $m = -\frac{-2\sqrt{7}}{-\sqrt{7}} = -2$ and the slope at $(\sqrt{7}, 0)$ is $m = -\frac{2\sqrt{7}}{\sqrt{7}} = -2$. Since the slope is -2 in each case, the corresponding tangents must be parallel.
42. $xy + 2x - y = 0 \Rightarrow x \frac{dy}{dx} + y + 2 - \frac{dy}{dx} = 0 \Rightarrow \frac{dy}{dx} = \frac{y+2}{1-x}$; the slope of the line $2x + y = 0$ is -2 . In order to be parallel, the normal lines must also have slope of -2 . Since a normal is perpendicular to a tangent, the slope of the tangent is $\frac{1}{2}$. Therefore, $\frac{y+2}{1-x} = \frac{1}{2} \Rightarrow 2y + 4 = 1 - x \Rightarrow x = -3 - 2y$. Substituting in the original equation, $y(-3 - 2y) + 2(-3 - 2y) - y = 0 \Rightarrow y^2 + 4y + 3 = 0 \Rightarrow y = -3$ or $y = -1$. If $y = -3$, then $x = 3$ and $y + 3 = -2(x - 3) \Rightarrow y = -2x + 3$. If $y = -1$, then $x = -1$ and $y + 1 = -2(x + 1) \Rightarrow y = -2x - 3$.
43. $y^4 = y^2 - x^2 \Rightarrow 4y^3y' = 2yy' - 2x \Rightarrow 2(2y^3 - y)y' = -2x \Rightarrow y' = \frac{-x}{y-2y^3}$; the slope of the tangent line at $(\frac{\sqrt{3}}{4}, \frac{\sqrt{3}}{2})$ is $\frac{-x}{y-2y^3} \Big|_{(\frac{\sqrt{3}}{4}, \frac{\sqrt{3}}{2})} = \frac{-\frac{\sqrt{3}}{4}}{\frac{\sqrt{3}}{2} - \frac{6\sqrt{3}}{8}} = \frac{-\frac{\sqrt{3}}{4}}{\frac{1}{2} - \frac{3}{4}} = \frac{-\frac{\sqrt{3}}{4}}{-\frac{1}{4}} = -1$; the slope of the tangent line at $(\frac{\sqrt{3}}{4}, \frac{1}{2})$ is $\frac{-x}{y-2y^3} \Big|_{(\frac{\sqrt{3}}{4}, \frac{1}{2})} = \frac{-\frac{\sqrt{3}}{4}}{\frac{1}{2} - \frac{2}{8}} = \frac{-\frac{\sqrt{3}}{4}}{\frac{1}{4}} = -\sqrt{3}$
44. $y^2(2-x) = x^3 \Rightarrow 2yy'(2-x) + y^2(-1) = 3x^2 \Rightarrow y' = \frac{y^2+3x^2}{2y(2-x)}$; the slope of the tangent line is $m = \frac{y^2+3x^2}{2y(2-x)} \Big|_{(1,1)} = \frac{4}{2} = 2 \Rightarrow$ the tangent line is $y - 1 = 2(x - 1) \Rightarrow y = 2x - 1$; the normal line is $y - 1 = -\frac{1}{2}(x - 1) \Rightarrow y = -\frac{1}{2}x + \frac{3}{2}$
45. $y^4 - 4y^2 = x^4 - 9x^2 \Rightarrow 4y^3y' - 8yy' = 4x^3 - 18x \Rightarrow y'(4y^3 - 8y) = 4x^3 - 18x \Rightarrow y' = \frac{4x^3 - 18x}{4y^3 - 8y} = \frac{2x^3 - 9x}{2y^3 - 4y}$
 $= \frac{x(2x^2 - 9)}{y(2y^2 - 4)} = m$; $(-3, 2): m = \frac{(-3)(18 - 9)}{2(8 - 4)} = -\frac{27}{8}$; $(-3, -2): m = \frac{27}{8}$; $(3, 2): m = \frac{27}{8}$; $(3, -2): m = -\frac{27}{8}$
46. $x^3 + y^3 - 9xy = 0 \Rightarrow 3x^2 + 3y^2y' - 9xy' - 9y = 0 \Rightarrow y'(3y^2 - 9x) = 9y - 3x^2 \Rightarrow y' = \frac{9y - 3x^2}{3y^2 - 9x} = \frac{3y - x^2}{y^2 - 3x}$
 (a) $y'|_{(4,2)} = \frac{5}{4}$ and $y'|_{(2,4)} = \frac{4}{5}$;
 (b) $y' = 0 \Rightarrow \frac{3y - x^2}{y^2 - 3x} = 0 \Rightarrow 3y - x^2 = 0 \Rightarrow y = \frac{x^2}{3} \Rightarrow x^3 + \left(\frac{x^2}{3}\right)^3 - 9x\left(\frac{x^2}{3}\right) = 0 \Rightarrow x^6 - 54x^3 = 0$
 $\Rightarrow x^3(x^3 - 54) = 0 \Rightarrow x = 0$ or $x = \sqrt[3]{54} = 3\sqrt[3]{2} \Rightarrow$ there is a horizontal tangent at $x = 3\sqrt[3]{2}$. To find the corresponding y -value, we will use part (c).
 (c) $\frac{dx}{dy} = 0 \Rightarrow \frac{y^2 - 3x}{3y - x^2} = 0 \Rightarrow y^2 - 3x = 0 \Rightarrow y = \pm\sqrt{3x}$; $y = \sqrt{3x} \Rightarrow x^3 + (\sqrt{3x})^3 - 9x\sqrt{3x} = 0 \Rightarrow x^3 - 6\sqrt{3}x^{3/2} = 0$
 $\Rightarrow x^{3/2}(x^{3/2} - 6\sqrt{3}) = 0 \Rightarrow$ or $x^{3/2} = 0$ or $x^{3/2} = 6\sqrt{3} \Rightarrow x = 0$ or $x = \sqrt[3]{108} = 3\sqrt[3]{4}$. Since the equation $x^3 + y^3 - 9xy = 0$ is symmetric in x and y , the graph is symmetric about the line $y = x$. That is, if (a, b) is a point on the folium, then so is (b, a) . Moreover, if $y'|_{(a,b)} = m$, then $y'|_{(b,a)} = \frac{1}{m}$. Thus, if the folium has a horizontal tangent at (a, b) , it has a vertical tangent at (b, a) so one might expect that with a horizontal tangent at $x = \sqrt[3]{54}$ and a vertical tangent at $x = 3\sqrt[3]{4}$, the points of tangency are $(\sqrt[3]{54}, 3\sqrt[3]{4})$ and $(3\sqrt[3]{4}, \sqrt[3]{54})$, respectively. One can check that these points do satisfy the equation $x^3 + y^3 - 9xy = 0$.

47. $x^2 + 2xy - 3y^2 = 0 \Rightarrow 2x + 2xy' + 2y - 6yy' = 0 \Rightarrow y'(2x - 6y) = -2x - 2y \Rightarrow y' = \frac{x+y}{3y-x} \Rightarrow$ the slope of the tangent line $m = y' \Big|_{(1,1)} = \frac{x+y}{3y-x} \Big|_{(1,1)} = 1 \Rightarrow$ the equation of the normal line at $(1, 1)$ is $y - 1 = -1(x - 1) \Rightarrow y = -x + 2$. To find where the normal line intersects the curve we substitute into its equation:
 $x^2 + 2x(2 - x) - 3(2 - x)^2 = 0 \Rightarrow x^2 + 4x - 2x^2 - 3(4 - 4x + x^2) = 0 \Rightarrow -4x^2 + 16x - 12 = 0 \Rightarrow x^2 - 4x + 3 = 0$
 $\Rightarrow (x - 3)(x - 1) = 0 \Rightarrow x = 3$ and $y = -x + 2 = -1$. Therefore, the normal to the curve at $(1, 1)$ intersects the curve at the point $(3, -1)$. Note that it also intersects the curve at $(1, 1)$.
48. Let p and q be integers with $q > 0$ and suppose that $y = \sqrt[q]{x^p} = x^{p/q}$. Then $y^q = x^p$. Since p and q are integers and assuming y is a differentiable function of x , $\frac{d}{dx}(y^q) = \frac{d}{dx}(x^p) \Rightarrow qy^{q-1} \frac{dy}{dx} = px^{p-1} \Rightarrow \frac{dy}{dx} = \frac{px^{p-1}}{qy^{q-1}} = \frac{p}{q} \cdot \frac{x^{p-1}}{y^{q-1}} = \frac{p}{q} \cdot \frac{x^{p-1}}{(x^{p/q})^{q-1}} = \frac{p}{q} \cdot \frac{x^{p-1}}{x^{p-p/q}} = \frac{p}{q} \cdot x^{p-1-(p-p/q)} = \frac{p}{q} \cdot x^{(p/q)-1}$
49. $y^2 = x \Rightarrow \frac{dy}{dx} = \frac{1}{2y}$. If a normal is drawn from $(a, 0)$ to (x_1, y_1) on the curve its slope satisfies $\frac{y_1 - 0}{x_1 - a} = -2y_1$
 $\Rightarrow y_1 = -2y_1(x_1 - a)$ or $a = x_1 + \frac{1}{2}$. Since $x_1 \geq 0$ on the curve, we must have that $a \geq \frac{1}{2}$. By symmetry, the two points on the parabola are $(x_1, \sqrt{x_1})$ and $(x_1, -\sqrt{x_1})$. For the normal to be perpendicular, $\left(\frac{\sqrt{x_1}}{x_1 - a}\right)\left(\frac{\sqrt{x_1}}{a - x_1}\right) = -1$
 $\Rightarrow \frac{x_1}{(a - x_1)^2} = 1 \Rightarrow x_1 = (a - x_1)^2 \Rightarrow x_1 = \left(x_1 + \frac{1}{2} - x_1\right)^2 \Rightarrow x_1 = \frac{1}{4}$ and $y_1 = \pm \frac{1}{2}$. Therefore, $\left(\frac{1}{4}, \pm \frac{1}{2}\right)$ and $a = \frac{3}{4}$.
50. $2x^2 + 3y^2 = 5 \Rightarrow 4x + 6yy' = 0 \Rightarrow y' = -\frac{2x}{3y} \Rightarrow y' \Big|_{(1,1)} = -\frac{2x}{3y} \Big|_{(1,1)} = -\frac{2}{3}$ and $y' \Big|_{(1,-1)} = -\frac{2x}{3y} \Big|_{(1,-1)} = -\frac{2}{3}$; also,
 $y^2 = x^3 \Rightarrow 2yy' = 3x^2 \Rightarrow y' = \frac{3x^2}{2y} \Rightarrow y' \Big|_{(1,1)} = \frac{3x^2}{2y} \Big|_{(1,1)} = \frac{3}{2}$ and $y' \Big|_{(1,-1)} = \frac{3x^2}{2y} \Big|_{(1,-1)} = -\frac{3}{2}$. Therefore the tangents to the curves are perpendicular at $(1, 1)$ and $(1, -1)$ (i.e., the curves are orthogonal at these two points of intersection).
51. (a) $x^2 + y^2 = 4, x^2 = 3y^2 \Rightarrow (3y^2) + y^2 = 4 \Rightarrow y^2 = 1 \Rightarrow y = \pm 1$. If $y = 1 \Rightarrow x^2 + (1)^2 = 4 \Rightarrow x^2 = 3 \Rightarrow x = \pm\sqrt{3}$.
 If $y = -1 \Rightarrow x^2 + (-1)^2 = 4 \Rightarrow x^2 = 3 \Rightarrow x = \pm\sqrt{3}$.
 $x^2 + y^2 = 4 \Rightarrow 2x + 2y \frac{dy}{dx} = 0 \Rightarrow m_1 = \frac{dy}{dx} = -\frac{x}{y}$ and $x^2 = 3y^2 \Rightarrow 2x = 6y \frac{dy}{dx} \Rightarrow m_2 = \frac{dy}{dx} = \frac{x}{3y}$
 At $(\sqrt{3}, 1)$: $m_1 = \frac{dy}{dx} = -\frac{\sqrt{3}}{1} = -\sqrt{3}$ and $m_2 = \frac{dy}{dx} = \frac{\sqrt{3}}{3(1)} = \frac{\sqrt{3}}{3} \Rightarrow m_1 \cdot m_2 = (-\sqrt{3})\left(\frac{\sqrt{3}}{3}\right) = -1$
 At $(-\sqrt{3}, -1)$: $m_1 = \frac{dy}{dx} = -\frac{-\sqrt{3}}{(-1)} = \sqrt{3}$ and $m_2 = \frac{dy}{dx} = \frac{\sqrt{3}}{3(-1)} = -\frac{\sqrt{3}}{3} \Rightarrow m_1 \cdot m_2 = (\sqrt{3})\left(-\frac{\sqrt{3}}{3}\right) = -1$
 At $(\sqrt{3}, -1)$: $m_1 = \frac{dy}{dx} = -\frac{(\sqrt{3})}{-1} = \sqrt{3}$ and $m_2 = \frac{dy}{dx} = \frac{-\sqrt{3}}{3(1)} = -\frac{\sqrt{3}}{3} \Rightarrow m_1 \cdot m_2 = (\sqrt{3})\left(-\frac{\sqrt{3}}{3}\right) = -1$
 At $(-\sqrt{3}, 1)$: $m_1 = \frac{dy}{dx} = -\frac{(-\sqrt{3})}{(1)} = -\sqrt{3}$ and $m_2 = \frac{dy}{dx} = \frac{(\sqrt{3})}{3(-1)} = -\frac{\sqrt{3}}{3} \Rightarrow m_1 \cdot m_2 = (-\sqrt{3})\left(-\frac{\sqrt{3}}{3}\right) = -1$
- (b) $x = 1 - y^2, x = \frac{1}{3}y^2 \Rightarrow \left(\frac{1}{3}y^2\right) = 1 - y^2 \Rightarrow y^2 = \frac{3}{4} \Rightarrow y = \pm\frac{\sqrt{3}}{2}$. If $y = \frac{\sqrt{3}}{2} \Rightarrow x = 1 - \left(\frac{\sqrt{3}}{2}\right)^2 = \frac{1}{4}$.
 If $y = -\frac{\sqrt{3}}{2} \Rightarrow x = 1 - \left(-\frac{\sqrt{3}}{2}\right)^2 = \frac{1}{4}$. $x = 1 - y^2 \Rightarrow 1 = -2y \frac{dy}{dx} \Rightarrow m_1 = \frac{dy}{dx} = -\frac{1}{2y}$ and $x = \frac{1}{3}y^2$
 $\Rightarrow 1 = \frac{2}{3}y \frac{dy}{dx} \Rightarrow m_2 = \frac{dy}{dx} = \frac{3}{2y}$
 At $\left(\frac{1}{4}, \frac{\sqrt{3}}{2}\right)$: $m_1 = \frac{dy}{dx} = -\frac{1}{2(\sqrt{3}/2)} = -\frac{1}{\sqrt{3}}$ and $m_2 = \frac{dy}{dx} = \frac{3}{2(\sqrt{3}/2)} = \frac{3}{\sqrt{3}} \Rightarrow m_1 \cdot m_2 = \left(-\frac{1}{\sqrt{3}}\right)\left(\frac{3}{\sqrt{3}}\right) = -1$
 At $\left(\frac{1}{4}, -\frac{\sqrt{3}}{2}\right)$: $m_1 = \frac{dy}{dx} = -\frac{1}{2(-\sqrt{3}/2)} = \frac{1}{\sqrt{3}}$ and $m_2 = \frac{dy}{dx} = \frac{3}{2(-\sqrt{3}/2)} = -\frac{3}{\sqrt{3}} \Rightarrow m_1 \cdot m_2 = \left(\frac{1}{\sqrt{3}}\right)\left(-\frac{3}{\sqrt{3}}\right) = -1$

52. $y = -\frac{1}{3}x + b$, $y^2 = x^3 \Rightarrow \frac{dy}{dx} = -\frac{1}{3}$ and $2y \frac{dy}{dx} = 3x^2 \Rightarrow \frac{dy}{dx} = \frac{3x^2}{2y} \Rightarrow \left(-\frac{1}{3}\right)\left(\frac{3x^2}{2y}\right) = -1 \Rightarrow \frac{x^2}{2} = y \Rightarrow \left(\frac{x^2}{2}\right)^2 = x^3$
 $\Rightarrow \frac{x^4}{4} = x^3 \Rightarrow x^4 - 4x^3 = 0 \Rightarrow x^3(x-4) = 0 \Rightarrow x = 0$ or $x = 4$. If $x = 0 \Rightarrow y = \frac{(0)^2}{2} = 0$ and $\left(-\frac{1}{3}\right)\left(\frac{3x^2}{2y}\right) = -1$ is
indeterminate at $(0, 0)$. If $x = 4 \Rightarrow y = \frac{(4)^2}{2} = 8$. At $(4, 8)$, $y = -\frac{1}{3}x + b \Rightarrow 8 = -\frac{1}{3}(4) + b \Rightarrow b = \frac{28}{3}$.

53. $xy^3 + x^2y = 6 \Rightarrow x\left(3y^2 \frac{dy}{dx}\right) + y^3 + x^2 \frac{dy}{dx} + 2xy = 0 \Rightarrow \frac{dy}{dx}(3xy^2 + x^2) = -y^3 - 2xy \Rightarrow \frac{dy}{dx} = \frac{-y^3 - 2xy}{3xy^2 + x^2} = -\frac{y^3 + 2xy}{3xy^2 + x^2}$;
also, $xy^3 + x^2y = 6 \Rightarrow x(3y^2) + y^3 \frac{dx}{dy} + x^2 + y(2x \frac{dx}{dy}) = 0 \Rightarrow \frac{dx}{dy}(y^3 + 2xy) = -3xy^2 - x^2 \Rightarrow \frac{dx}{dy} = -\frac{3xy^2 + x^2}{y^3 + 2xy}$;
thus $\frac{dx}{dy}$ appears to equal $\frac{1}{\frac{dy}{dx}}$. The two different treatments view the graphs as functions symmetric across the
line $y = x$, so their slopes are reciprocals of one another at the corresponding points (a, b) and (b, a) .

54. $x^3 + y^2 = \sin^2 y \Rightarrow 3x^2 + 2y \frac{dy}{dx} = (2 \sin y)(\cos y) \frac{dy}{dx} \Rightarrow \frac{dy}{dx}(2y - 2 \sin y \cos y) = -3x^2 \Rightarrow \frac{dy}{dx} = \frac{-3x^2}{2y - 2 \sin y \cos y}$
 $= \frac{3x^2}{2 \sin y \cos y - 2y}$; also, $x^3 + y^2 = \sin^2 y \Rightarrow 3x^2 \frac{dx}{dy} + 2y = 2 \sin y \cos y \Rightarrow \frac{dx}{dy} = \frac{2 \sin y \cos y - 2y}{3x^2}$; thus $\frac{dx}{dy}$ appears to
equal $\frac{1}{\frac{dy}{dx}}$. The two different treatments view the graphs as functions symmetric across the line $y = x$ so their
slopes are reciprocals of one another at the corresponding points (a, b) and (b, a) .

55. $y = \sin^{-1} x \Rightarrow x = \sin y \Rightarrow \frac{d}{dx}(x) = \frac{d}{dx} \sin y \Rightarrow 1 = \cos y \frac{dy}{dx} = \frac{dy}{dx} = \frac{1}{\cos y}$. Since $\sin^2 y + \cos^2 y = 1$,
 $\cos y = \sqrt{1 - \sin^2 y} = \sqrt{1 - x^2}$. Therefore, $\frac{dy}{dx} = \frac{d}{dx} \sin^{-1} x = \frac{1}{\sqrt{1-x^2}}$.

56. (a) $\frac{d}{dx}(\sin^{-1} x)^2 = 2 \sin^{-1} x \frac{d}{dx} \sin^{-1} x = \frac{2 \sin^{-1} x}{\sqrt{1-x^2}}$

(b) $\frac{d}{dx} \sin^{-1}\left(\frac{1}{x}\right) = \frac{1}{\sqrt{1-\left(\frac{1}{x}\right)^2}} \frac{d}{dx}\left(\frac{1}{x}\right) = \frac{1}{\sqrt{1-\frac{1}{x^2}}}\left(-\frac{1}{x^2}\right) = -\frac{1}{x^2 \sqrt{1-\frac{1}{x^2}}}$ or $-\frac{1}{|x|\sqrt{x^2-1}}$

57-64. Example CAS commands:

Maple:

```
q1 := x^3-x*y+y^3 = 7;
pt := [x=2, y=1];
p1 := implicitplot( q1, x=-3..3, y=-3..3 );
p1;
eval( q1, pt );
q2 := implicitdiff( q1, y, x );
m := eval( q2, pt );
tan_line := y = 1 + m*(x-2);
p2 := implicitplot( tan_line, x=-5..5, y=-5..5, color=green );
p3 := pointplot( eval([x, y], pt), color=blue);
display( [p1,p2,p3], "Section 3.7 #57(c)" );
```

Mathematica: (functions and x_0 may vary):

Note use of double equal sign (logic statement) in definition of eqn and tanline.

```
<<Graphics`ImplicitPlot`
Clear[x, y]
{x0, y0}={1, π/4};
eqn=x + Tan[y/x]==2;
ImplicitPlot[eqn,{x, x0-3, x0+3},{y, y0-3, y0+3}]
eqn/.{x → x0, y → y0}
eqn/.{y → y[x]}
D[%, x]
Solve[%, y[x]]
slope=y'[x]/.First[%]
m=slope/.{x → x0, y[x] → y0}
tanline=y==y0 + m (x - x0)
ImplicitPlot[{eqn, tanline},{x, x0-3, x0+3},{y, y0-3, y0+3}]
```

3.8 DERIVATIVES OF INVERSE FUNCTIONS AND LOGARITHMS

1. (a) $y = 2x + 3 \Rightarrow 2x = y - 3$
 $\Rightarrow x = \frac{y}{2} - \frac{3}{2} \Rightarrow f^{-1}(x) = \frac{x}{2} - \frac{3}{2}$

(c) $\left. \frac{df}{dx} \right|_{x=-1} = 2, \left. \frac{df^{-1}}{dx} \right|_{x=1} = \frac{1}{2}$

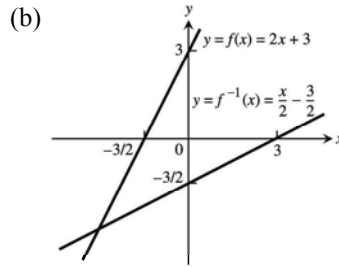

2. (a) $y = \frac{1}{5}x + 7 \Rightarrow \frac{1}{5}x = y - 7$
 $\Rightarrow x = 5y - 35 \Rightarrow f^{-1}(x) = 5x - 35$

(c) $\left. \frac{df}{dx} \right|_{x=-1} = \frac{1}{5}, \left. \frac{df^{-1}}{dx} \right|_{x=34/5} = 5$

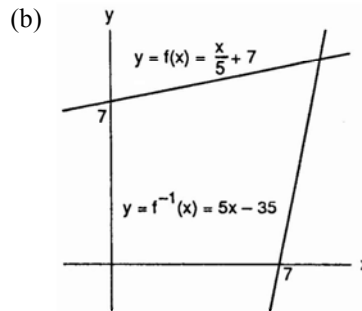

3. (a) $y = 5 - 4x \Rightarrow 4x = 5 - y$
 $\Rightarrow x = \frac{5}{4} - \frac{y}{4} \Rightarrow f^{-1}(x) = \frac{5}{4} - \frac{x}{4}$

(c) $\left. \frac{df}{dx} \right|_{x=1/2} = -4, \left. \frac{df^{-1}}{dx} \right|_{x=3} = -\frac{1}{4}$

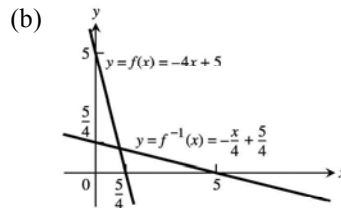

4. (a) $y = 2x^2 \Rightarrow x^2 = \frac{1}{2}y$
 $\Rightarrow x = \frac{1}{\sqrt{2}}\sqrt{y} \Rightarrow f^{-1}(x) = \sqrt{\frac{x}{2}}$

(c) $\left. \frac{df}{dx} \right|_{x=5} = 4x \Big|_{x=5} = 20,$
 $\left. \frac{df^{-1}}{dx} \right|_{x=50} = \frac{1}{2\sqrt{2}}x^{-1/2} \Big|_{x=50} = \frac{1}{20}$

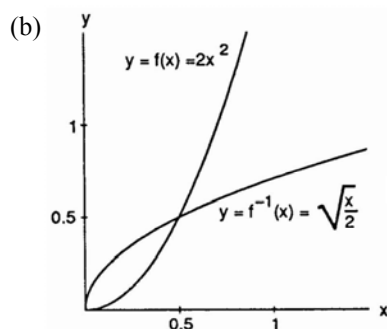

5. (a) $f(g(x)) = (\sqrt[3]{x})^3 = x, g(f(x)) = \sqrt[3]{x^3} = x$

(c) $f'(x) = 3x^2 \Rightarrow f'(1) = 3, f'(-1) = 3;$
 $g'(x) = \frac{1}{3}x^{-2/3} \Rightarrow g'(1) = \frac{1}{3}, g'(-1) = \frac{1}{3}$

(d) The line $y = 0$ is tangent to $f(x) = x^3$ at $(0, 0)$; the line $x = 0$ is tangent to $g(x) = \sqrt[3]{x}$ at $(0, 0)$.

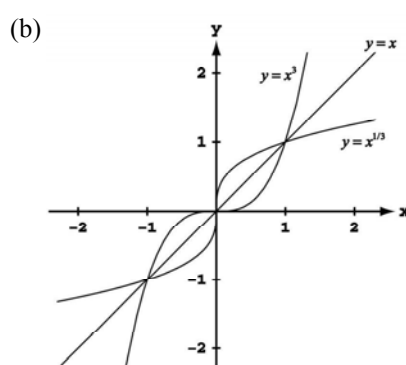

6. (a) $h(k(x)) = \frac{1}{4}((4x)^{1/3})^3 = x,$

$$k(h(x)) = \left(4 \cdot \frac{x^3}{4}\right)^{1/3} = x$$

(c) $h'(x) = \frac{3x^2}{4} \Rightarrow h'(2) = 3, h'(-2) = 3;$
 $k'(x) = \frac{4}{3}(4x)^{-2/3} \Rightarrow k'(2) = \frac{1}{3}, k'(-2) = \frac{1}{3}$

(d) The line $y = 0$ is tangent to $h(x) = \frac{x^3}{4}$ at $(0, 0)$; the line $x = 0$ is tangent to $k(x) = (4x)^{1/3}$ at $(0, 0)$.

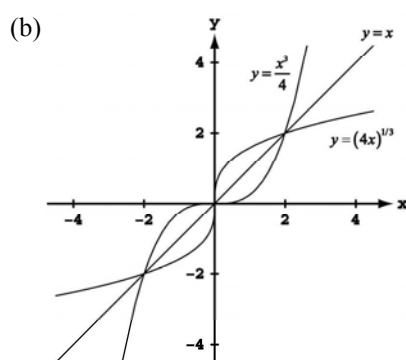

7. $\frac{df}{dx} = 3x^2 - 6x \Rightarrow \left. \frac{df^{-1}}{dx} \right|_{x=f(3)} = \frac{1}{\left. \frac{df}{dx} \right|_{x=3}} = \frac{1}{9}$

8. $\frac{df}{dx} = 2x - 4 \Rightarrow \left. \frac{df^{-1}}{dx} \right|_{x=f(5)} = \frac{1}{\left. \frac{df}{dx} \right|_{x=5}} = \frac{1}{6}$

9. $\left. \frac{df^{-1}}{dx} \right|_{x=4} = \frac{1}{\left. \frac{df}{dx} \right|_{x=f(2)}} = \frac{1}{\left. \frac{df}{dx} \right|_{x=2}} = \frac{1}{\left(\frac{1}{3}\right)} = 3$

10. $\left. \frac{dg^{-1}}{dx} \right|_{x=0} = \frac{1}{\left. \frac{dg}{dx} \right|_{x=f(0)}} = \frac{1}{\left. \frac{dg}{dx} \right|_{x=0}} = \frac{1}{2}$

11. $y = \ln 3x + x \Rightarrow y' = \left(\frac{1}{3x}\right)(3) + 1 = \frac{1}{x} + 1$

12. $y = \frac{1}{\ln 3x} \Rightarrow y' = -\frac{1}{(\ln 3x)^2} \left(\frac{1}{3x}\right)(3) = -\frac{1}{x(\ln 3x)^2}$

13. $y = \ln(t^2) \Rightarrow \frac{dy}{dt} = \left(\frac{1}{t^2}\right)(2t) = \frac{2}{t}$
14. $y = \ln(t^{3/2}) + \sqrt{t} \Rightarrow \frac{dy}{dt} = \left(\frac{1}{t^{3/2}}\right)\left(\frac{3}{2}t^{1/2}\right) + \frac{1}{2\sqrt{t}} = \frac{3}{2t} + \frac{1}{2\sqrt{t}}$
15. $y = \ln \frac{3}{x} = \ln 3x^{-1} \Rightarrow \frac{dy}{dx} = \left(\frac{1}{3x^{-1}}\right)(-3x^{-2}) = -\frac{1}{x}$
16. $y = \ln(\sin x) \Rightarrow \frac{dy}{dx} = \frac{1}{\sin x} \cdot \frac{d}{dx}(\sin x) = \frac{\cos x}{\sin x} = \cot x$
17. $y = \ln(\theta+1) - e^\theta \Rightarrow \frac{dy}{d\theta} = \left(\frac{1}{\theta+1}\right)(1) - e^\theta = \frac{1}{\theta+1} - e^\theta$
18. $y = (\cos \theta) \ln(2\theta+2) \Rightarrow \frac{dy}{d\theta} = (-\sin \theta) \ln(2\theta+2) + (\cos \theta) \left(\frac{1}{2\theta+2}\right)(2) = (-\sin \theta) \ln(2\theta+2) + (\cos \theta) \left(\frac{1}{\theta+1}\right)$
19. $y = \ln x^3 \Rightarrow \frac{dy}{dx} = \left(\frac{1}{x^3}\right)(3x^2) = \frac{3}{x}$
20. $y = (\ln x)^3 \Rightarrow \frac{dy}{dx} = 3(\ln x)^2 \cdot \frac{d}{dx}(\ln x) = \frac{3(\ln x)^2}{x}$
21. $y = t(\ln t)^2 \Rightarrow \frac{dy}{dt} = (\ln t)^2 = 2t(\ln t) \cdot \frac{d}{dt}(\ln t) = (\ln t)^2 + \frac{2t \ln t}{t} = (\ln t)^2 + 2 \ln t$
22. $y = t \ln \sqrt{t} \Rightarrow \frac{dy}{dt} = (1)(\ln \sqrt{t}) + t \left(\frac{1}{\sqrt{t}}\right) \frac{d}{dt} \sqrt{t} = \ln \sqrt{t} + t \left(\frac{1}{\sqrt{t}}\right) \left(\frac{1}{2\sqrt{t}}\right) = \ln \sqrt{t} + \frac{1}{2}$
23. $y = \frac{x^4}{4} \ln x - \frac{x^4}{16} \Rightarrow \frac{dy}{dx} = x^3 \ln x + \frac{x^4}{4} \cdot \frac{1}{x} - \frac{4x^3}{16} = x^3 \ln x$
24. $y = (x^2 \ln x)^4 \Rightarrow \frac{dy}{dx} = 4(x^2 \ln x)^3 \left(x^2 \cdot \frac{1}{x} + 2x \ln x\right) = 4x^6 (\ln x)^3 (x + 2x \ln x) = 4x^7 (\ln x)^3 + 8x^7 (\ln x)^4$
25. $y = \frac{\ln t}{t} \Rightarrow \frac{dy}{dt} = \frac{t \left(\frac{1}{t}\right) - (\ln t)(1)}{t^2} = \frac{1 - \ln t}{t^2}$
26. $y = \frac{t}{\sqrt{\ln t}} \Rightarrow \frac{dy}{dt} = \frac{(1)\sqrt{\ln t} - t \left(\frac{1}{2\sqrt{\ln t}}\right) \left(\frac{1}{t}\right)}{(\sqrt{\ln t})^2} = \frac{\sqrt{\ln t} - \frac{1}{2\sqrt{\ln t}}}{\ln t} = \frac{2\ln t - 1}{2(\ln t)^{3/2}}$
27. $y = \frac{\ln x}{1 + \ln x} \Rightarrow y' = \frac{(1 + \ln x) \left(\frac{1}{x}\right) - (\ln x) \left(\frac{1}{x}\right)}{(1 + \ln x)^2} = \frac{\frac{1}{x} + \frac{\ln x}{x} - \frac{\ln x}{x}}{(1 + \ln x)^2} = \frac{1}{x(1 + \ln x)^2}$
28. $y = \frac{x \ln x}{1 + \ln x} \Rightarrow y' = \frac{(1 + \ln x) \left(\ln x + x \cdot \frac{1}{x}\right) - (x \ln x) \left(\frac{1}{x}\right)}{(1 + \ln x)^2} = \frac{(1 + \ln x)^2 - \ln x}{(1 + \ln x)^2} = 1 - \frac{\ln x}{(1 + \ln x)^2}$
29. $y = \ln(\ln x) \Rightarrow y' = \left(\frac{1}{\ln x}\right) \left(\frac{1}{x}\right) = \frac{1}{x \ln x}$
30. $y = \ln(\ln(\ln x)) \Rightarrow y' = \frac{1}{\ln(\ln x)} \cdot \frac{d}{dx}(\ln(\ln x)) = \frac{1}{\ln(\ln x)} \cdot \frac{1}{\ln x} \cdot \frac{d}{dx}(\ln x) = \frac{1}{x(\ln x) \ln(\ln x)}$
31. $y = \theta[\sin(\ln \theta) + \cos(\ln \theta)] \Rightarrow \frac{dy}{d\theta} = [\sin(\ln \theta) + \cos(\ln \theta)] + \theta \left[\cos(\ln \theta) \cdot \frac{1}{\theta} - \sin(\ln \theta) \cdot \frac{1}{\theta}\right]$
 $= \sin(\ln \theta) + \cos(\ln \theta) + \cos(\ln \theta) - \sin(\ln \theta) = 2 \cos(\ln \theta)$

32. $y = \ln(\sec \theta + \tan \theta) \Rightarrow \frac{dy}{d\theta} = \frac{\sec \theta \tan \theta + \sec^2 \theta}{\sec \theta + \tan \theta} = \frac{\sec \theta (\tan \theta + \sec \theta)}{\tan \theta + \sec \theta} = \sec \theta$
33. $y = \ln \frac{1}{x\sqrt{x+1}} = -\ln x - \frac{1}{2} \ln(x+1) \Rightarrow y' = -\frac{1}{x} - \frac{1}{2} \left(\frac{1}{x+1} \right) = -\frac{2(x+1)+x}{2x(x+1)} = -\frac{3x+2}{2x(x+1)}$
34. $y = \frac{1}{2} \ln \frac{1+x}{1-x} = \frac{1}{2} [\ln(1+x) - \ln(1-x)] \Rightarrow y' = \frac{1}{2} \left[\frac{1}{1+x} - \left(\frac{1}{1-x} \right) (-1) \right] = \frac{1}{2} \left[\frac{1-x+1+x}{(1+x)(1-x)} \right] = \frac{1}{1-x^2}$
35. $y = \frac{1+\ln t}{1-\ln t} \Rightarrow \frac{dy}{dt} = \frac{(1-\ln t) \left(\frac{1}{t} \right) - (1+\ln t) \left(\frac{-1}{t} \right)}{(1-\ln t)^2} = \frac{\frac{1-\ln t+1+\ln t}{t}}{(1-\ln t)^2} = \frac{2}{t(1-\ln t)^2}$
36. $y = \sqrt{\ln \sqrt{t}} = (\ln t^{1/2})^{1/2}$
 $\Rightarrow \frac{dy}{dt} = \frac{1}{2} (\ln t^{1/2})^{-1/2} \cdot \frac{d}{dt} (\ln t^{1/2}) = \frac{1}{2} (\ln t^{1/2})^{-1/2} \cdot \frac{1}{t^{1/2}} \cdot \frac{d}{dt} (t^{1/2}) = \frac{1}{2} (\ln t^{1/2})^{-1/2} \cdot \frac{1}{t^{1/2}} \cdot \frac{1}{2} t^{-1/2} = \frac{1}{4t\sqrt{\ln \sqrt{t}}}$
37. $y = \ln(\sec(\ln \theta)) \Rightarrow \frac{dy}{d\theta} = \frac{1}{\sec(\ln \theta)} \cdot \frac{d}{d\theta} (\sec(\ln \theta)) = \frac{\sec(\ln \theta) \tan(\ln \theta)}{\sec(\ln \theta)} \cdot \frac{d}{d\theta} (\ln \theta) = \frac{\tan(\ln \theta)}{\theta}$
38. $y = \ln \frac{\sqrt{\sin \theta \cos \theta}}{1+2 \ln \theta} = \frac{1}{2} (\ln \sin \theta + \ln \cos \theta) - \ln(1+2 \ln \theta)$
 $\Rightarrow \frac{dy}{d\theta} = \frac{1}{2} \left(\frac{\cos \theta}{\sin \theta} - \frac{\sin \theta}{\cos \theta} \right) - \frac{\frac{2}{\theta}}{1+2 \ln \theta} = \frac{1}{2} \left[\cos \theta - \tan \theta - \frac{4}{\theta(1+2 \ln \theta)} \right]$
39. $y = \ln \left(\frac{(x^2+1)^5}{\sqrt{1-x}} \right) = 5 \ln(x^2+1) - \frac{1}{2} \ln(1-x) \Rightarrow y' = \frac{5 \cdot 2x}{x^2+1} - \frac{1}{2} \left(\frac{1}{1-x} \right) (-1) = \frac{10x}{x^2+1} + \frac{1}{2(1-x)}$
40. $y = \ln \sqrt{\frac{(x+1)^5}{(x+2)^{20}}} = \frac{1}{2} [5 \ln(x+1) - 20 \ln(x+2)] \Rightarrow y' = \frac{1}{2} \left(\frac{5}{x+1} - \frac{20}{x+2} \right) = \frac{5}{2} \left[\frac{(x+2)-4(x+1)}{(x+1)(x+2)} \right] = -\frac{5}{2} \left[\frac{3x+2}{(x+1)(x+2)} \right]$
41. $y = \sqrt{x(x+1)} = (x(x+1))^{1/2} \Rightarrow \ln y = \frac{1}{2} \ln(x(x+1)) \Rightarrow 2 \ln y = \ln(x) + \ln(x+1) \Rightarrow \frac{2y'}{y} = \frac{1}{x} + \frac{1}{x+1}$
 $\Rightarrow y' = \left(\frac{1}{2} \right) \sqrt{x(x+1)} \left(\frac{1}{x} + \frac{1}{x+1} \right) = \frac{\sqrt{x(x+1)}(2x+1)}{2x(x+1)} = \frac{2x+1}{2\sqrt{x(x+1)}}$
42. $y = \sqrt{(x^2+1)(x-1)^2} \Rightarrow \ln y = \frac{1}{2} [\ln(x^2+1) + 2 \ln(x-1)] \Rightarrow \frac{y'}{y} = \frac{1}{2} \left(\frac{2x}{x^2+1} + \frac{2}{x-1} \right)$
 $\Rightarrow y' = \sqrt{(x^2+1)(x-1)^2} \left(\frac{x}{x^2+1} + \frac{1}{x-1} \right) = \sqrt{(x^2+1)(x-1)^2} \left[\frac{x^2-x+x^2+1}{(x^2+1)(x-1)} \right] = \frac{(2x^2-x+1)|x-1|}{\sqrt{x^2+1}(x-1)}$
43. $y = \sqrt{\frac{t}{t+1}} = \left(\frac{t}{t+1} \right)^{1/2} \Rightarrow \ln y = \frac{1}{2} [\ln t - \ln(t+1)] \Rightarrow \frac{1}{y} \frac{dy}{dt} = \frac{1}{2} \left(\frac{1}{t} - \frac{1}{t+1} \right)$
 $\Rightarrow \frac{dy}{dt} = \frac{1}{2} \sqrt{\frac{t}{t+1}} \left(\frac{1}{t} - \frac{1}{t+1} \right) = \frac{1}{2} \sqrt{\frac{t}{t+1}} \left[\frac{1}{t(t+1)} \right] = \frac{1}{2\sqrt{t}(t+1)^{3/2}}$

44. $y = \sqrt{\frac{1}{t(t+1)}} = [t(t+1)]^{-1/2} \Rightarrow \ln y = \frac{1}{2}[\ln t + \ln(t+1)] \Rightarrow \frac{1}{y} \frac{dy}{dt} = -\frac{1}{2}\left(\frac{1}{t} + \frac{1}{t+1}\right)$
 $\Rightarrow \frac{dy}{dt} = -\frac{1}{2} \sqrt{\frac{1}{t(t+1)}} \left[\frac{2t+1}{t(t+1)} \right] = -\frac{2t+1}{2(t^2+t)^{3/2}}$
45. $y = \sqrt{\theta+3}(\sin \theta) = (\theta+3)^{1/2} \sin \theta \Rightarrow \ln y = \frac{1}{2} \ln(\theta+3) + \ln(\sin \theta) \Rightarrow \frac{1}{y} \frac{dy}{d\theta} = \frac{1}{2(\theta+3)} + \frac{\cos \theta}{\sin \theta}$
 $\Rightarrow \frac{dy}{d\theta} = \sqrt{\theta+3}(\sin \theta) \left[\frac{1}{2(\theta+3)} + \cot \theta \right]$
46. $y = (\tan \theta)\sqrt{2\theta+1} = (\tan \theta)(2\theta+1)^{1/2} \Rightarrow \ln y = \ln(\tan \theta) + \frac{1}{2} \ln(2\theta+1) \Rightarrow \frac{1}{y} \frac{dy}{d\theta} = \frac{\sec^2 \theta}{\tan \theta} + \left(\frac{1}{2}\right)\left(\frac{2}{2\theta+1}\right)$
 $\Rightarrow \frac{dy}{d\theta} = (\tan \theta)\sqrt{2\theta+1} \left(\frac{\sec^2 \theta}{\tan \theta} + \frac{1}{2\theta+1} \right) = (\sec^2 \theta)\sqrt{2\theta+1} + \frac{\tan \theta}{\sqrt{2\theta+1}}$
47. $y = t(t+1)(t+2) \Rightarrow \ln y = \ln t + \ln(t+1) + \ln(t+2) \Rightarrow \frac{1}{y} \frac{dy}{dt} = \frac{1}{t} + \frac{1}{t+1} + \frac{1}{t+2}$
 $\Rightarrow \frac{dy}{dt} = t(t+1)(t+2) \left(\frac{1}{t} + \frac{1}{t+1} + \frac{1}{t+2} \right) = t(t+1)(t+2) \left[\frac{(t+1)(t+2)+t(t+2)+t(t+1)}{t(t+1)(t+2)} \right] = 3t^2 + 6t + 2$
48. $y = \frac{1}{t(t+1)(t+2)} \Rightarrow \ln y = \ln 1 - \ln t - \ln(t+1) - \ln(t+2) \Rightarrow \frac{1}{y} \frac{dy}{dt} = -\frac{1}{t} - \frac{1}{t+1} - \frac{1}{t+2}$
 $\Rightarrow \frac{dy}{dt} = \frac{1}{t(t+1)(t+2)} \left[-\frac{1}{t} - \frac{1}{t+1} - \frac{1}{t+2} \right] = \frac{-1}{t(t+1)(t+2)} \left[\frac{(t+1)(t+2)+t(t+2)+t(t+1)}{t(t+1)(t+2)} \right] = -\frac{3t^2+6t+2}{(t^3+3t^2+2t)^2}$
49. $y = \frac{\theta+5}{\theta \cos \theta} \Rightarrow \ln y = \ln(\theta+5) - \ln \theta - \ln(\cos \theta) \Rightarrow \frac{1}{y} \frac{dy}{d\theta} = \frac{1}{\theta+5} - \frac{1}{\theta} + \frac{\sin \theta}{\cos \theta} \Rightarrow \frac{dy}{d\theta} = \left(\frac{\theta+5}{\theta \cos \theta} \right) \left(\frac{1}{\theta+5} - \frac{1}{\theta} + \tan \theta \right)$
50. $y = \frac{\theta \sin \theta}{\sqrt{\sec \theta}} \Rightarrow \ln y = \ln \theta + \ln(\sin \theta) - \frac{1}{2} \ln(\sec \theta) \Rightarrow \frac{1}{y} \frac{dy}{d\theta} = \left[\frac{1}{\theta} + \frac{\cos \theta}{\sin \theta} - \frac{(\sec \theta)(\tan \theta)}{2 \sec \theta} \right]$
 $\Rightarrow \frac{dy}{d\theta} = \frac{\theta \sin \theta}{\sqrt{\sec \theta}} \left(\frac{1}{\theta} + \cot \theta - \frac{1}{2} \tan \theta \right)$
51. $y = \frac{x\sqrt{x^2+1}}{(x+1)^{2/3}} \Rightarrow \ln y = \ln x + \frac{1}{2} \ln(x^2+1) - \frac{2}{3} \ln(x+1) \Rightarrow \frac{y'}{y} = \frac{1}{x} + \frac{x}{x+1} - \frac{2}{3(x+1)} \Rightarrow y' = \frac{x\sqrt{x^2+1}}{(x+1)^{2/3}} \left[\frac{1}{x} + \frac{x}{x^2+1} - \frac{2}{3(x+1)} \right]$
52. $y = \sqrt{\frac{(x+1)^{10}}{(2x+1)^5}} \Rightarrow \ln y = \frac{1}{2} [10 \ln(x+1) - 5 \ln(2x+1)] \Rightarrow \frac{y'}{y} = \frac{5}{x+1} - \frac{5}{2x+1} \Rightarrow y' = \sqrt{\frac{(x+1)^{10}}{(2x+1)^5}} \left(\frac{5}{x+1} - \frac{5}{2x+1} \right)$
53. $y = 3\sqrt{\frac{x(x-2)}{x^2+1}} \Rightarrow \ln y = \frac{1}{3} [\ln x + \ln(x-2) - \ln(x^2+1)] \Rightarrow \frac{y'}{y} = \frac{1}{3} \left(\frac{1}{x} + \frac{1}{x-2} - \frac{2x}{x^2+1} \right)$
 $\Rightarrow y' = \frac{1}{3} 3\sqrt{\frac{x(x-2)}{x^2+1}} \left(\frac{1}{x} + \frac{1}{x-2} - \frac{2x}{x^2+1} \right)$
54. $y = 3\sqrt{\frac{x(x+2)(x-2)}{(x^2+1)(2x+3)}} \Rightarrow \ln y = \frac{1}{3} [\ln x + \ln(x+1) + \ln(x-2) - \ln(x^2+1) - \ln(2x+3)]$
 $\Rightarrow y' = \frac{1}{3} 3\sqrt{\frac{x(x+1)(x-2)}{(x^2+1)(2x+3)}} \left(\frac{1}{x} + \frac{1}{x+1} + \frac{1}{x-2} - \frac{2x}{x^2+1} - \frac{2}{2x+3} \right)$

$$55. \quad y = \ln(\cos^2 \theta) \Rightarrow \frac{dy}{d\theta} = \frac{1}{\cos^2 \theta} \cdot 2 \cos \theta \cdot (-\sin \theta) = -2 \tan \theta$$

$$56. \quad y = \ln(3\theta e^{-\theta}) = \ln 3 + \ln \theta + \ln e^{-\theta} = \ln 3 + \ln \theta - \theta \Rightarrow \frac{dy}{d\theta} = \frac{1}{\theta} - 1$$

$$57. \quad y = \ln(3te^{-t}) = \ln 3 + \ln t + \ln e^{-t} = \ln 3 + \ln t - t \Rightarrow \frac{dy}{dt} = \frac{1}{t} - 1 = \frac{1-t}{t}$$

$$58. \quad y = \ln(2e^{-t} \sin t) = \ln 2 + \ln e^{-t} + \ln \sin t = \ln 2 - t + \ln \sin t \\ \Rightarrow \frac{dy}{dt} = -1 + \left(\frac{1}{\sin t}\right) \frac{d}{dt}(\sin t) = -1 + \frac{\cos t}{\sin t} = \frac{\cos t - \sin t}{\sin t}$$

$$59. \quad y = \ln \frac{e^\theta}{1+e^\theta} = \ln e^\theta - \ln(1+e^\theta) = \theta - \ln(1+e^\theta) \Rightarrow \frac{dy}{d\theta} = 1 - \left(\frac{1}{1+e^\theta}\right) \frac{d}{d\theta}(1+e^\theta) = 1 - \frac{e^\theta}{1+e^\theta} = \frac{1}{1+e^\theta}$$

$$60. \quad y = \ln \frac{\sqrt{\theta}}{1+\sqrt{\theta}} = \ln \sqrt{\theta} - \ln(1+\sqrt{\theta}) \Rightarrow \frac{dy}{d\theta} = \left(\frac{1}{\sqrt{\theta}}\right) \frac{d}{d\theta}(\sqrt{\theta}) - \left(\frac{1}{1+\sqrt{\theta}}\right) \frac{d}{d\theta}(1+\sqrt{\theta}) \\ = \left(\frac{1}{\sqrt{\theta}}\right) \left(\frac{1}{2\sqrt{\theta}}\right) - \left(\frac{1}{1+\sqrt{\theta}}\right) \left(\frac{1}{2\sqrt{\theta}}\right) = \frac{(1+\sqrt{\theta}) - \sqrt{\theta}}{2\theta(1+\sqrt{\theta})} = \frac{1}{2\theta(1+\sqrt{\theta})} = \frac{1}{2\theta(1+\theta^{1/2})}$$

$$61. \quad y = e^{(\cos t + \ln t)} = e^{\cos t} e^{\ln t} = te^{\cos t} \Rightarrow \frac{dy}{dt} = e^{\cos t} + te^{\cos t} \frac{d}{dt}(\cos t) = (1 - t \sin t)e^{\cos t}$$

$$62. \quad y = e^{\sin t} (\ln t^2 + 1) \Rightarrow \frac{dy}{dt} = e^{\sin t} (\cos t)(\ln t^2 + 1) + \frac{2}{t} e^{\sin t} = e^{\sin t} \left[(\ln t^2 + 1)(\cos t) + \frac{2}{t} \right]$$

$$63. \quad \ln y = e^y \sin x \Rightarrow \left(\frac{1}{y}\right) y' = (y'e^y)(\sin x) + e^y \cos x \Rightarrow y' \left(\frac{1}{y} - e^y \sin x\right) = e^y \cos x \\ \Rightarrow y' \left(\frac{1 - ye^y \sin x}{y}\right) = e^y \cos x \Rightarrow y' = \frac{ye^y \cos x}{1 - ye^y \sin x}$$

$$64. \quad \ln xy = e^{x+y} \Rightarrow \ln x + \ln y = e^{x+y} \Rightarrow \frac{1}{x} + \left(\frac{1}{y}\right) y' = (1 + y')e^{x+y} \Rightarrow y' \left(\frac{1}{y} - e^{x+y}\right) = e^{x+y} - \frac{1}{x} \\ \Rightarrow y' \left(\frac{1 - ye^{x+y}}{y}\right) = \frac{xe^{x+y} - 1}{x} \Rightarrow y' = \frac{y(xe^{x+y} - 1)}{x(1 - ye^{x+y})}$$

$$65. \quad x^y = y^x \Rightarrow \ln x^y = \ln y^x \Rightarrow y \ln x = x \ln y \Rightarrow y \cdot \frac{1}{x} + y' \cdot \ln x = x \cdot \frac{1}{y} \cdot y' + (1) \cdot \ln y \Rightarrow \ln x \cdot y' - \frac{x}{y} \cdot y' = \ln y - \frac{y}{x} \\ \Rightarrow y' = \frac{\ln y - \frac{y}{x}}{\ln x - \frac{x}{y}} = \frac{xy \ln y - y^2}{xy \ln x - x^2} = \frac{y}{x} \left(\frac{x \ln y - y}{y \ln x - x}\right)$$

$$66. \quad \tan y = e^x + \ln x \Rightarrow (\sec^2 y) y' = e^x + \frac{1}{x} \Rightarrow y' = \frac{(xe^x + 1) \cos^2 y}{x}$$

$$67. \quad y = 2^x \Rightarrow y' = 2^x \ln 2$$

$$68. \quad y = 3^{-x} \Rightarrow y' = 3^{-x} (\ln 3)(-1) = -3^{-x} \ln 3$$

$$69. \quad y = 5^{\sqrt{s}} \Rightarrow \frac{dy}{ds} = 5^{\sqrt{s}} (\ln 5) \left(\frac{1}{2} s^{-1/2}\right) = \left(\frac{\ln 5}{2\sqrt{s}}\right) 5^{\sqrt{s}}$$

$$70. y = 2^{s^2} \Rightarrow \frac{dy}{ds} = 2^{s^2} (\ln 2) 2s = (\ln 2^2) (s 2^{s^2}) = (\ln 4) s 2^{s^2}$$

$$71. y = x^\pi \Rightarrow y' = \pi x^{(\pi-1)}$$

$$72. y = t^{1-e} \Rightarrow \frac{dy}{dt} = (1-e)t^{-e}$$

$$73. y = \log_2 5\theta = \frac{\ln 5\theta}{\ln 2} \Rightarrow \frac{dy}{d\theta} = \left(\frac{1}{\ln 2}\right) \left(\frac{1}{5\theta}\right) (5) = \frac{1}{\theta \ln 2}$$

$$74. y = \log_3(1 + \theta \ln 3) = \frac{\ln(1 + \theta \ln 3)}{\ln 3} \Rightarrow \frac{dy}{d\theta} = \left(\frac{1}{\ln 3}\right) \left(\frac{1}{1 + \theta \ln 3}\right) (\ln 3) = \frac{1}{1 + \theta \ln 3}$$

$$75. y = \log_4 x + \log_4 x^2 = \frac{\ln x}{\ln 4} + \frac{\ln x^2}{\ln 4} = \frac{\ln x}{\ln 4} + 2 \frac{\ln x}{\ln 4} = 3 \frac{\ln x}{\ln 4} \Rightarrow y' = \frac{3}{x \ln 4}$$

$$76. y = \log_{25} e^x - \log_5 \sqrt{x} = \frac{x \ln e}{\ln 25} - \frac{\ln x}{2 \ln 5} = \frac{x}{2 \ln 5} - \frac{\ln x}{2 \ln 5} = \left(\frac{1}{2 \ln 5}\right) (x - \ln x) \Rightarrow y' = \left(\frac{1}{2 \ln 5}\right) \left(1 - \frac{1}{x}\right) = \frac{x-1}{2x \ln 5}$$

$$77. y = \log_2 r \cdot \log_4 r = \left(\frac{\ln r}{\ln 2}\right) \left(\frac{\ln r}{\ln 4}\right) = \frac{\ln^2 r}{(\ln 2)(\ln 4)} \Rightarrow \frac{dy}{dr} = \left[\frac{1}{(\ln 2)(\ln 4)}\right] (2 \ln r) \left(\frac{1}{r}\right) = \frac{2 \ln r}{r(\ln 2)(\ln 4)}$$

$$78. y = \log_3 r \cdot \log_9 r = \left(\frac{\ln r}{\ln 3}\right) \left(\frac{\ln r}{\ln 9}\right) = \frac{\ln^2 r}{(\ln 3)(\ln 9)} \Rightarrow \frac{dy}{dr} = \left[\frac{1}{(\ln 3)(\ln 9)}\right] (2 \ln r) \left(\frac{1}{r}\right) = \frac{2 \ln r}{r(\ln 3)(\ln 9)}$$

$$79. y = \log_3 \left(\left(\frac{x+1}{x-1} \right)^{\ln 3} \right) = \frac{\ln \left(\frac{x+1}{x-1} \right)^{\ln 3}}{\ln 3} = \frac{(\ln 3) \ln \left(\frac{x+1}{x-1} \right)}{\ln 3} = \ln \left(\frac{x+1}{x-1} \right) = \ln(x+1) - \ln(x-1)$$

$$\Rightarrow \frac{dy}{dx} = \frac{1}{x+1} - \frac{1}{x-1} = \frac{-2}{(x+1)(x-1)}$$

$$80. y = \log_5 \sqrt{\left(\frac{7x}{3x+2} \right)^{\ln 5}} = \log_5 \left(\frac{7x}{3x+2} \right)^{(\ln 5)/2} = \frac{\ln \left(\frac{7x}{3x+2} \right)^{(\ln 5)/2}}{\ln 5} = \left(\frac{\ln 5}{2} \right) \left[\frac{\ln \left(\frac{7x}{3x+2} \right)}{\ln 5} \right] = \frac{1}{2} \ln \left(\frac{7x}{3x+2} \right)$$

$$= \frac{1}{2} \ln 7x - \frac{1}{2} \ln(3x+2) \Rightarrow \frac{dy}{dx} = \frac{7}{2 \cdot 7x} - \frac{3}{2(3x+2)} = \frac{(3x+2) - 3x}{2x(3x+2)} = \frac{1}{x(3x+2)}$$

$$81. y = \theta \sin(\log_7 \theta) = \theta \sin \left(\frac{\ln \theta}{\ln 7} \right) \Rightarrow \frac{dy}{d\theta} = \sin \left(\frac{\ln \theta}{\ln 7} \right) + \theta \left[\cos \left(\frac{\ln \theta}{\ln 7} \right) \right] \left(\frac{1}{\theta \ln 7} \right) = \sin(\log_7 \theta) + \frac{1}{\ln 7} \cos(\log_7 \theta)$$

$$82. y = \log_7 \left(\frac{\sin \theta \cos \theta}{e^{\theta} 2^{\theta}} \right) = \frac{\ln(\sin \theta) + \ln(\cos \theta) - \ln e^{\theta} - \ln 2^{\theta}}{\ln 7} = \frac{\ln(\sin \theta) + \ln(\cos \theta) - \theta - \theta \ln 2}{\ln 7}$$

$$\Rightarrow \frac{dy}{d\theta} = \frac{\cos \theta}{(\sin \theta)(\ln 7)} - \frac{\sin \theta}{(\cos \theta)(\ln 7)} - \frac{1}{\ln 7} - \frac{\ln 2}{\ln 7} = \left(\frac{1}{\ln 7} \right) (\cot \theta - \tan \theta - 1 - \ln 2)$$

$$83. y = \log_5 e^x = \frac{\ln e^x}{\ln 5} = \frac{x}{\ln 5} \Rightarrow y' = \frac{1}{\ln 5}$$

$$84. y = \log_2 \left(\frac{x^2 e^2}{2\sqrt{x+1}} \right) = \frac{\ln x^2 + \ln e^2 - \ln 2 - \ln \sqrt{x+1}}{\ln 2} = \frac{2 \ln x + 2 - \ln 2 - \frac{1}{2} \ln(x+1)}{\ln 2}$$

$$\Rightarrow y' = \frac{2}{x \ln 2} - \frac{1}{2(\ln 2)(x+1)} = \frac{4(x+1) - x}{2x(x+1)(\ln 2)} = \frac{3x+4}{2x(x+1)\ln 2}$$

85. $y = 3^{\log_2 t} = 3^{(\ln t)/(\ln 2)} \Rightarrow \frac{dy}{dt} = \left[3^{(\ln t)/(\ln 2)} (\ln 3) \right] \left(\frac{1}{t \ln 2} \right) = \frac{1}{t} (\log_2 3) 3^{\log_2 t}$
86. $y = 3 \log_8 (\log_2 t) = \frac{3 \ln (\log_2 t)}{\ln 8} = \frac{3 \ln \left(\frac{\ln t}{\ln 2} \right)}{\ln 8} \Rightarrow \frac{dy}{dt} = \left(\frac{3}{\ln 8} \right) \left[\frac{1}{(\ln t)/(\ln 2)} \right] \left(\frac{1}{t \ln 2} \right) = \frac{3}{t (\ln t) (\ln 8)} = \frac{1}{t (\ln t) (\ln 2)}$
87. $y = \log_2 (8t^{\ln 2}) = \frac{\ln 8 + \ln (t^{\ln 2})}{\ln 2} = \frac{3 \ln 2 + (\ln 2)(\ln t)}{\ln 2} = 3 + \ln t \Rightarrow \frac{dy}{dt} = \frac{1}{t}$
88. $y = t \log_3 \left(e^{(\sin t)(\ln 3)} \right) = \frac{t \ln \left((e^{\ln 3})^{\sin t} \right)}{\ln 3} = \frac{t \ln (3^{\sin t})}{\ln 3} = \frac{t (\sin t) (\ln 3)}{\ln 3} = t \sin t \Rightarrow \frac{dy}{dt} = \sin t + t \cos t$
89. $y = (x+1)^x \Rightarrow \ln y = \ln (x+1)^x = x \ln (x+1) \Rightarrow \frac{y'}{y} = x \cdot \frac{1}{(x+1)} + \ln (x+1) \Rightarrow y' = (x+1)^x \left[\frac{x}{x+1} + \ln (x+1) \right]$
90. $y = x^{(x+1)} \Rightarrow \ln y = \ln x^{(x+1)} = (x+1) \ln x \Rightarrow \frac{y'}{y} = (x+1) \left(\frac{1}{x} \right) + \ln x = \ln x + 1 + \frac{1}{x} \Rightarrow y' = x^{(x+1)} \left(1 + \frac{1}{x} + \ln x \right)$
91. $y = (\sqrt{t})^t = (t^{1/2})^t = t^{t/2} \Rightarrow \ln y = \ln t^{t/2} = \left(\frac{t}{2} \right) \ln t \Rightarrow \frac{1}{y} \frac{dy}{dt} = \left(\frac{1}{2} \right) (\ln t) + \left(\frac{t}{2} \right) \left(\frac{1}{t} \right) = \frac{\ln t}{2} + \frac{1}{2} \Rightarrow \frac{dy}{dt} = (\sqrt{t})^t \left(\frac{\ln t}{2} + \frac{1}{2} \right)$
92. $y = t^{\sqrt{t}} = t^{(t^{1/2})} \Rightarrow \ln y = \ln t^{(t^{1/2})} = (t^{1/2})(\ln t) \Rightarrow \frac{1}{y} \frac{dy}{dt} = \left(\frac{1}{2} t^{-1/2} \right) (\ln t) + t^{1/2} \left(\frac{1}{t} \right) = \frac{\ln t + 2}{2\sqrt{t}} \Rightarrow \frac{dy}{dt} = \left(\frac{\ln t + 2}{2\sqrt{t}} \right) t^{\sqrt{t}}$
93. $y = (\sin x)^x \Rightarrow \ln y = \ln (\sin x)^x = x \ln (\sin x) \Rightarrow \frac{y'}{y} = x \left(\frac{\cos x}{\sin x} \right) + \ln (\sin x) \Rightarrow y' = (\sin x)^x [\ln (\sin x) + x \cot x]$
94. $y = x^{\sin x} \Rightarrow \ln y = \ln x^{\sin x} = (\sin x)(\ln x) \Rightarrow \frac{y'}{y} = (\sin x) \left(\frac{1}{x} \right) + (\cos x)(\ln x) = \frac{\sin x + x(\ln x)(\cos x)}{x}$
 $\Rightarrow y' = x^{\sin x} \left[\frac{\sin x + x(\ln x)(\cos x)}{x} \right]$
95. $y = x^{\ln x}, x > 0 \Rightarrow \ln y = (\ln x)^2 \Rightarrow \frac{y'}{y} = 2(\ln x) \left(\frac{1}{x} \right) \Rightarrow y' = (x^{\ln x}) \left(\frac{\ln x^2}{x} \right)$
96. $y = (\ln x)^{\ln x} \Rightarrow \ln y = (\ln x) \ln (\ln x) \Rightarrow \frac{y'}{y} = (\ln x) \left(\frac{1}{\ln x} \right) \frac{d}{dx} (\ln x) + \left(\frac{1}{x} \right) \ln (\ln x) = \frac{\ln (\ln x)}{x} + \frac{1}{x}$
 $\Rightarrow y' = (\ln x)^{\ln x} \left(\frac{\ln (\ln x) + 1}{x} \right)$
97. $(g \circ f)(x) = x \Rightarrow g(f(x)) = x \Rightarrow g'(f(x))f'(x) = 1$
98. $\lim_{n \rightarrow \infty} \left(1 + \frac{x}{n} \right)^n = \lim_{n \rightarrow \infty} \left[\left(1 + \frac{1}{(n/x)} \right)^{(n/x)} \right]^x = e^x$ for any $x > 0$.
99. The derivative of x^n at $x = 0$ is given by $\lim_{h \rightarrow 0} \frac{(0+h)^n}{h} = \lim_{h \rightarrow 0} h^{n-1}$. For $n \geq 2$, $n-1 \geq 1$, so $\lim_{h \rightarrow 0} h^{n-1} = 0$.

100. Suppose $n = 1$. Then $\frac{d}{dx} \ln x = \frac{1}{x} = (-1)^0 \cdot \frac{0!}{x^1}$ and so the base case is established. Now if the statement holds for $n = k$ we have that, for $n = k + 1$, the following holds:

$$\frac{d^n}{dx^n} (\ln x) = \frac{d^{k+1}}{dx^{k+1}} (\ln x) = \frac{d}{dx} \left(\frac{d^k}{dx^k} (\ln x) \right) = \frac{d}{dx} \left((-1)^{k-1} \frac{(k-1)!}{x^k} \right) = (-1)^{k-1} (k-1)! \cdot (-k) x^{-k-1} = \frac{(-1)^k k!}{x^{k+1}} = \frac{(-1)^{n-1} (n-1)!}{x^n}$$

Thus by mathematical induction the result is established for all $n \geq 1$.

101–108. Example CAS commands:

Maple:

```
with(plots);#101
f := x -> sqrt(3*x-2);
domain := 2/3 .. 4;
x0 := 3;
Df := D(f); # (a)
plot([f(x),Df(x)], x=domain, color=[red,blue], linestyle=[1,3], legend=["y=f(x)","y=f'(x)"],
      title="#101(a) (Section 3.8)");
q1 := solve(y=f(x), x); # (b)
g := unapply(q1, y);
m1 := Df(x0); # (c)
t1 := f(x0)+m1*(x-x0);
y=t1;
m2 := 1/Df(x0); # (d)
t2 := g(f(x0)) + m2*(x-f(x0));
y=t2;
domaing := map(f,domain); # (e)
p1 := plot([f(x),x], x=domain, color=[pink,green], linestyle=[1,9], thickness=[3,0]);
p2 := plot(g(x), x=domaing, color=cyan, linestyle=3, thickness=4);
p3 := plot(t1, x=x0-1..f(x0)+1, color=red, linestyle=4, thickness=0);
p4 := plot(t2, x=f(x0)-1..f(x0)+1, color=blue, linestyle=7, thickness=1);
p5 := plot([x0,f(x0)], [f(x0),x0], color=green);
display([p1,p2,p3,p4,p5], scaling=constrained, title="#101(e) (Section 3.8)");
```

Mathematica: (assigned function and values for a, b, and x0 may vary)

If a function requires the odd root of a negative number, begin by loading the RealOnly package that allows Mathematica to do this.

```
<<Miscellaneous`RealOnly`
Clear[x, y]
{a,b} = {-2, 1}; x0 = 1/2;
f[x_] = (3x + 2) / (2x - 11)
Plot[{f[x], f[x]}, {x, a, b}]
solx = Solve[y == f[x], x]
g[y_] = x /. solx[[1]]
y0=f[x0]
ftan[x_] = y0+f[x0] (x-x0)
gtan[y_] = x0 + 1/f[x0] (y-y0)
Plot[{f[x], ftan[x], g[x], gtan[x], Identity[x]}, {x, a, b},
Epilog -> Line[{{x0, y0}, {y0, x0}}, PlotRange -> {{a, b}, {a,b}}, AspectRatio -> Automatic]
```

109–110. Example CAS commands:

Maple:

```
with( plots );
eq := cos(y) = x^(1/5);
domain := 0 .. 1;
x0 := 1/2;
f := unapply( solve( eq, y ), x );          # (a)
Df := D(f);
plot( [f(x),Df(x)], x=domain, color=[red,blue], linestyle=[1,3], legend=["y=f(x)",y=f'(x)],
      title="#110(a) (Section 3.8)" );

q1 := solve( eq, x );                      # (b)
g := unapply( q1, y );
m1 := Df(x0);                              # (c)
t1 := f(x0)+m1*(x-x0);
y=t1;
m2 := 1/Df(x0);                            # (d)
t2 := g(f(x0)) + m2*(x-f(x0));
y=t2;
domaing := map(f,domain);                  # (e)
p1 := plot( [f(x),x], x=domain, color=[pink,green], linestyle=[1,9], thickness=[3,0] );
p2 := plot( g(x), x=domaing, color=cyan, linestyle=3, thickness=4 );
p3 := plot( t1, x=x0-1..x0+1, color=red, linestyle=4, thickness=0 );
p4 := plot( t2, x=f(x0)-1..f(x0)+1, color=blue, linestyle=7, thickness=1 );
p5 := plot( [ [x0,f(x0)], [f(x0),x0] ], color=green );
display( [p1,p2,p3,p4,p5], scaling=constrained, title="#110(e) (Section 3.8)" );
```

Mathematica: (Assigned function and values for a, b, and x0 may vary)

For problems 109 and 110, the code is just slightly altered. At times, different “parts” of solutions need to be used as in the definitions of f[x] and g[y]

```
Clear[x, y]
{a,b} = {0, 1}; x0 = 1/2 ;
eqn = Cos[y] == x1/5
soly = Solve[eqn, y]
f[x_] = y /. soly[[2]]
Plot[{f[x], f[x]}, {x, a, b}]
solx = Solve[eqn, x]
g[y_] = x /. solx[[1]]
y0 = f[x0]
ftan[x_] = y0+f[x0] (x-x0)
gtan[y_] = x0 + 1/f[x0] (y-y0)
Plot[{f[x], ftan[x], g[x], gtan[x], Identity[x]}, {x, a, b},
Epilog → Line[{x0, y0}, {y0, x0}], PlotRange → {{a, b}, {a, b}}, AspectRatio → Automatic]
```

3.9 INVERSE TRIGONOMETRIC FUNCTIONS

1. (a) $\frac{\pi}{4}$ (b) $-\frac{\pi}{3}$ (c) $\frac{\pi}{6}$ 2. (a) $-\frac{\pi}{4}$ (b) $\frac{\pi}{3}$ (c) $-\frac{\pi}{6}$
3. (a) $-\frac{\pi}{6}$ (b) $\frac{\pi}{4}$ (c) $-\frac{\pi}{3}$ 4. (a) $\frac{\pi}{6}$ (b) $-\frac{\pi}{4}$ (c) $\frac{\pi}{3}$
5. (a) $\frac{\pi}{3}$ (b) $\frac{3\pi}{4}$ (c) $\frac{\pi}{6}$ 6. (a) $\frac{\pi}{4}$ (b) $-\frac{\pi}{3}$ (c) $\frac{\pi}{6}$
7. (a) $\frac{3\pi}{4}$ (b) $\frac{\pi}{6}$ (c) $\frac{2\pi}{3}$ 8. (a) $\frac{3\pi}{4}$ (b) $\frac{\pi}{6}$ (c) $\frac{2\pi}{3}$
9. $\sin\left(\cos^{-1}\frac{\sqrt{2}}{2}\right) = \sin\left(\frac{\pi}{4}\right) = \frac{1}{\sqrt{2}}$ 10. $\sec\left(\cos^{-1}\frac{1}{2}\right) = \sec\left(\frac{\pi}{3}\right) = 2$
11. $\tan\left(\sin^{-1}\left(-\frac{1}{2}\right)\right) = \tan\left(-\frac{\pi}{6}\right) = -\frac{1}{\sqrt{3}}$ 12. $\cot\left(\sin^{-1}\left(-\frac{\sqrt{3}}{2}\right)\right) = \cot\left(-\frac{\pi}{3}\right) = -\frac{1}{\sqrt{3}}$
13. $\lim_{x \rightarrow 1^-} \sin^{-1} x = \frac{\pi}{2}$ 14. $\lim_{x \rightarrow -1^+} \cos^{-1} x = \pi$
15. $\lim_{x \rightarrow \infty} \tan^{-1} x = \frac{\pi}{2}$ 16. $\lim_{x \rightarrow -\infty} \tan^{-1} x = -\frac{\pi}{2}$
17. $\lim_{x \rightarrow \infty} \sec^{-1} x = \frac{\pi}{2}$ 18. $\lim_{x \rightarrow -\infty} \sec^{-1} x = \lim_{x \rightarrow -\infty} \cos^{-1}\left(\frac{1}{x}\right) = \frac{\pi}{2}$
19. $\lim_{x \rightarrow \infty} \csc^{-1} x = \lim_{x \rightarrow \infty} \sin^{-1}\left(\frac{1}{x}\right) = 0$ 20. $\lim_{x \rightarrow -\infty} \csc^{-1} x = \lim_{x \rightarrow -\infty} \sin^{-1}\left(\frac{1}{x}\right) = 0$
21. $y = \cos^{-1}(x^2) \Rightarrow \frac{dy}{dx} = -\frac{2x}{\sqrt{1-(x^2)^2}} = \frac{-2x}{\sqrt{1-x^4}}$ 22. $y = \cos^{-1}\left(\frac{1}{x}\right) = \sec^{-1} x \Rightarrow \frac{dy}{dx} = \frac{1}{|x|\sqrt{x^2-1}}$
23. $y = \sin^{-1} \sqrt{2t} \Rightarrow \frac{dy}{dt} = \frac{\sqrt{2}}{\sqrt{1-(\sqrt{2t})^2}} = \frac{\sqrt{2}}{\sqrt{1-2t}}$ 24. $y = \sin^{-1}(1-t) \Rightarrow \frac{dy}{dt} = \frac{-1}{\sqrt{1-(1-t)^2}} = \frac{-1}{\sqrt{2t-t^2}}$
25. $y = \sec^{-1}(2s+1) \Rightarrow \frac{dy}{ds} = \frac{2}{|2s+1|\sqrt{(2s+1)^2-1}} = \frac{2}{|2s+1|\sqrt{4s^2+4s}} = \frac{1}{|2s+1|\sqrt{s^2+s}}$
26. $y = \sec^{-1} 5s \Rightarrow \frac{dy}{ds} = \frac{5}{|5s|\sqrt{(5s)^2-1}} = \frac{1}{|s|\sqrt{25s^2-1}}$
27. $y = \csc^{-1}(x^2+1) \Rightarrow \frac{dy}{dx} = -\frac{2x}{|x^2+1|\sqrt{(x^2+1)^2-1}} = \frac{-2x}{(x^2+1)\sqrt{x^4+2x^2}}$

$$28. y = \csc^{-1}\left(\frac{x}{2}\right) \Rightarrow \frac{dy}{dx} = -\frac{\left(\frac{1}{2}\right)}{\left|\frac{x}{2}\right|\sqrt{\left(\frac{x}{2}\right)^2 - 1}} = \frac{-1}{|x|\sqrt{\frac{x^2-4}{4}}} = \frac{-2}{|x|\sqrt{x^2-4}}$$

$$29. y = \sec^{-1}\left(\frac{1}{t}\right) = \cos^{-1} t \Rightarrow \frac{dy}{dt} = \frac{-1}{\sqrt{1-t^2}}$$

$$30. y = \sin^{-1}\left(\frac{3}{t^2}\right) = \csc^{-1}\left(\frac{t^2}{3}\right) \Rightarrow \frac{dy}{dt} = -\frac{\left(\frac{2t}{3}\right)}{\left|\frac{t^2}{3}\right|\sqrt{\left(\frac{t^2}{3}\right)^2 - 1}} = \frac{-2t}{t^2\sqrt{\frac{t^4-9}{9}}} = \frac{-6}{t\sqrt{t^4-9}}$$

$$31. y = \cot^{-1}\sqrt{t} = \cot^{-1} t^{1/2} \Rightarrow \frac{dy}{dt} = -\frac{\left(\frac{1}{2}\right)t^{-1/2}}{1+(t^{1/2})^2} = \frac{-1}{2\sqrt{t}(1+t)}$$

$$32. y = \cot^{-1}\sqrt{t-1} = \cot^{-1}(t-1)^{1/2} \Rightarrow \frac{dy}{dt} = -\frac{\left(\frac{1}{2}\right)(t-1)^{-1/2}}{1+[(t-1)^{1/2}]^2} = \frac{-1}{2\sqrt{t-1}(1+t-1)} = \frac{-1}{2t\sqrt{t-1}}$$

$$33. y = \ln(\tan^{-1} x) \Rightarrow \frac{dy}{dx} = \frac{\left(\frac{1}{1+x^2}\right)}{\tan^{-1} x} = \frac{1}{(\tan^{-1} x)(1+x^2)}$$

$$34. y = \tan^{-1}(\ln x) \Rightarrow \frac{dy}{dx} = \frac{\left(\frac{1}{x}\right)}{1+(\ln x)^2} = \frac{1}{x[1+(\ln x)^2]}$$

$$35. y = \csc^{-1}(e^t) \Rightarrow \frac{dy}{dt} = -\frac{e^t}{|e^t|\sqrt{(e^t)^2-1}} = \frac{-1}{\sqrt{e^{2t}-1}}$$

$$36. y = \cos^{-1}(e^{-t}) \Rightarrow \frac{dy}{dt} = -\frac{-e^{-t}}{\sqrt{1-(e^{-t})^2}} = \frac{e^{-t}}{\sqrt{1-e^{-2t}}}$$

$$37. y = s\sqrt{1-s^2} + \cos^{-1} s = s(1-s^2)^{1/2} + \cos^{-1} s \Rightarrow \frac{dy}{ds} = (1-s^2)^{1/2} + s\left(\frac{1}{2}\right)(1-s^2)^{-1/2}(-2s) - \frac{1}{\sqrt{1-s^2}}$$

$$= \sqrt{1-s^2} - \frac{s^2}{\sqrt{1-s^2}} - \frac{1}{\sqrt{1-s^2}} = \sqrt{1-s^2} - \frac{s^2+1}{\sqrt{1-s^2}} = \frac{1-s^2-s^2-1}{\sqrt{1-s^2}} = \frac{-2s^2}{\sqrt{1-s^2}}$$

$$38. y = \sqrt{s^2-1} - \sec^{-1} s = (s^2-1)^{1/2} - \sec^{-1} s \Rightarrow \frac{dy}{dx} = \left(\frac{1}{2}\right)(s^2-1)^{-1/2}(2s) - \frac{1}{|s|\sqrt{s^2-1}} = \frac{s}{\sqrt{s^2-1}} - \frac{1}{|s|\sqrt{s^2-1}} = \frac{s|s|-1}{|s|\sqrt{s^2-1}}$$

$$39. y = \tan^{-1}\sqrt{x^2-1} + \csc^{-1} x = \tan^{-1}(x^2-1)^{1/2} + \csc^{-1} x$$

$$\Rightarrow \frac{dy}{dx} = \frac{\left(\frac{1}{2}\right)(x^2-1)^{-1/2}(2x)}{1+[(x^2-1)^{1/2}]^2} - \frac{1}{|x|\sqrt{x^2-1}} = \frac{1}{x\sqrt{x^2-1}} - \frac{1}{|x|\sqrt{x^2-1}} = 0, \text{ for } x > 1$$

$$40. y = \cot^{-1}\left(\frac{1}{x}\right) - \tan^{-1} x = \frac{\pi}{2} - \tan^{-1}(x^{-1}) - \tan^{-1} x \Rightarrow \frac{dy}{dx} = 0 - \frac{-x^{-2}}{1+(x^{-1})^2} - \frac{1}{1+x^2} = \frac{1}{x^2+1} - \frac{1}{1+x^2} = 0$$

41. $y = x \sin^{-1} x + \sqrt{1-x^2} = x \sin^{-1} x + (1-x^2)^{1/2}$

$$\Rightarrow \frac{dy}{dx} = \sin^{-1} x + x \left(\frac{1}{\sqrt{1-x^2}} \right) + \left(\frac{1}{2} \right) (1-x^2)^{-1/2} (-2x) = \sin^{-1} x + \frac{x}{\sqrt{1-x^2}} - \frac{x}{\sqrt{1-x^2}} = \sin^{-1} x$$

42. $y = \ln(x^2 + 4) - x \tan^{-1} \left(\frac{x}{2} \right) \Rightarrow \frac{dy}{dx} = \frac{2x}{x^2+4} - \tan^{-1} \left(\frac{x}{2} \right) - x \left[\frac{\left(\frac{1}{2} \right)}{1+\left(\frac{x}{2} \right)^2} \right] = \frac{2x}{x^2+4} - \tan^{-1} \left(\frac{x}{2} \right) - \frac{2x}{4+x^2} = -\tan^{-1} \left(\frac{x}{2} \right)$

43. The angle α is the large angle between the wall and the right end of the blackboard minus the small angle between the left end of the blackboard and the wall $\Rightarrow \alpha = \cot^{-1} \left(\frac{x}{15} \right) - \cot^{-1} \left(\frac{x}{3} \right)$.

44. $65^\circ + (90^\circ - \beta) + (90^\circ - \alpha) = 180^\circ \Rightarrow \alpha = 65^\circ - \beta = 65^\circ - \tan^{-1} \left(\frac{21}{50} \right) \approx 65^\circ - 22.78^\circ \approx 42.22^\circ$

45. Take each square as a unit square. From the diagram we have the following: the smallest angle α has a tangent of 1 $\Rightarrow \alpha = \tan^{-1} 1$; the middle angle β has a tangent of 2 $\Rightarrow \beta = \tan^{-1} 2$; and the largest angle γ has a tangent of 3 $\Rightarrow \gamma = \tan^{-1} 3$. The sum of these three angles is $\pi \Rightarrow \alpha + \beta + \gamma = \pi \Rightarrow \tan^{-1} 1 + \tan^{-1} 2 + \tan^{-1} 3 = \pi$.

46. (a) From the symmetry of the diagram, we see that $\pi - \sec^{-1} x$ is the vertical distance from the graph of $y = \sec^{-1} x$ to the line $y = \pi$ and this distance is the same as the height of $y = \sec^{-1} x$ above the x -axis at $-x$; i.e., $\pi - \sec^{-1} x = \sec^{-1}(-x)$.

(b) $\cos^{-1}(-x) = \pi - \cos^{-1} x$, where $-1 \leq x \leq 1 \Rightarrow \cos^{-1} \left(-\frac{1}{x} \right) = \pi - \cos^{-1} \left(\frac{1}{x} \right)$, where $x \geq 1$ or $x \leq -1$
 $\Rightarrow \sec^{-1}(-x) = \pi - \sec^{-1} x$

47. (a) Defined; there is an angle whose tangent is 2.
 (b) Not defined; there is no angle whose cosine is 2.

48. (a) Not defined; there is no angle whose cosecant is $\frac{1}{2}$.
 (b) Defined; there is an angle whose cosecant is 2.

49. (a) Not defined; there is no angle whose secant is 0.
 (b) Not defined; there is no angle whose sine is $\sqrt{2}$.

50. (a) Defined; there is an angle whose cotangent is $-\frac{1}{2}$.
 (b) Not defined; there is no angle whose cosine is -5 .

51. $\csc^{-1} u = \frac{\pi}{2} - \sec^{-1} u \Rightarrow \frac{d}{dx} (\csc^{-1} u) = \frac{d}{dx} \left(\frac{\pi}{2} - \sec^{-1} u \right) = 0 - \frac{\frac{du}{dx}}{|u|\sqrt{|u|^2-1}} = -\frac{\frac{du}{dx}}{|u|\sqrt{|u|^2-1}}, |u| > 1$

52. $y = \tan^{-1} x \Rightarrow \tan y = x \Rightarrow \frac{d}{dx} (\tan y) = \frac{d}{dx} (x)$
 $\Rightarrow (\sec^2 y) \frac{dy}{dx} = 1$
 $\Rightarrow \frac{dy}{dx} = \frac{1}{\sec^2 y} = \frac{1}{(\sqrt{1+x^2})^2} = \frac{1}{1+x^2}$, as indicated by the

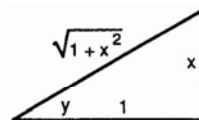

triangle.

$$53. f(x) = \sec x \Rightarrow f'(x) = \sec x \tan x \Rightarrow \left. \frac{df^{-1}}{dx} \right|_{x=b} = \frac{1}{\left. \frac{df}{dx} \right|_{x=f^{-1}(b)}} = \frac{1}{\sec(\sec^{-1} b) \tan(\sec^{-1} b)} = \frac{1}{b(\pm\sqrt{b^2-1})}$$

Since the slope of $\sec^{-1} x$ is always positive, we choose the right sign by writing $\frac{d}{dx} \sec^{-1} x = \frac{1}{|x|\sqrt{x^2-1}}$.

$$54. \cot^{-1} u = \frac{\pi}{2} - \tan^{-1} u \Rightarrow \frac{d}{dx}(\cot^{-1} u) = \frac{d}{dx}\left(\frac{\pi}{2} - \tan^{-1} u\right) = 0 - \frac{\frac{du}{dx}}{1+u^2} = -\frac{\frac{du}{dx}}{1+u^2}$$

55. The functions f and g have the same derivative (for $x \geq 0$), namely $\frac{1}{\sqrt{x(x+1)}}$. The functions therefore differ by a constant. To identify the constant we can set x equal to 0 in the equation $f(x) = g(x) + C$, obtaining $\sin^{-1}(-1) = 2 \tan^{-1}(0) + C \Rightarrow -\frac{\pi}{2} = 0 + C \Rightarrow C = -\frac{\pi}{2}$. For $x \geq 0$, we have $\sin^{-1}\left(\frac{x-1}{x+1}\right) = 2 \tan^{-1} \sqrt{x} - \frac{\pi}{2}$.

56. The functions f and g have the same derivative for $x > 0$, namely $\frac{-1}{1+x^2}$. The functions therefore differ by a constant for $x > 0$. To identify the constant we can set x equal to 1 in the equation $f(x) = g(x) + C$, obtaining $\sin^{-1}\left(\frac{1}{\sqrt{2}}\right) = \tan^{-1} 1 + C \Rightarrow \frac{\pi}{4} = \frac{\pi}{4} + C \Rightarrow C = 0$. For $x > 0$, we have $\sin^{-1} \frac{1}{\sqrt{x^2+1}} = \tan^{-1} \frac{1}{x}$.

$$57. (a) \sec^{-1} 1.5 = \cos^{-1} \frac{1}{1.5} \approx 0.84107 \qquad (b) \csc^{-1}(-1.5) = \sin^{-1}\left(-\frac{1}{1.5}\right) \approx -0.72973$$

$$(c) \cot^{-1} 2 = \frac{\pi}{2} - \tan^{-1} 2 \approx 0.46365$$

$$58. (a) \sec^{-1}(-3) = \cos^{-1}\left(-\frac{1}{3}\right) \approx 1.91063 \qquad (b) \csc^{-1} 1.7 = \sin^{-1}\left(\frac{1}{1.7}\right) \approx 0.62887$$

$$(c) \cot^{-1}(-2) = \frac{\pi}{2} - \tan^{-1}(-2) \approx 2.67795$$

59. (a) Domain: all real numbers except those having the form $\frac{\pi}{2} + k\pi$ where k is an integer. Range: $-\frac{\pi}{2} < y < \frac{\pi}{2}$

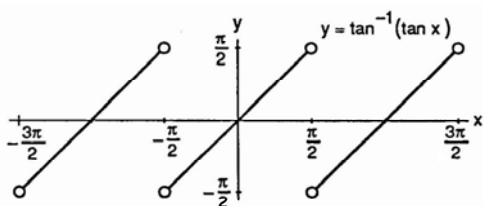

(b) Domain: $-\infty < x < \infty$; Range: $-\infty < y < \infty$

The graph of $y = \tan^{-1}(\tan x)$ is periodic, the graph of $y = \tan(\tan^{-1} x) = x$ for $-\infty \leq x < \infty$.

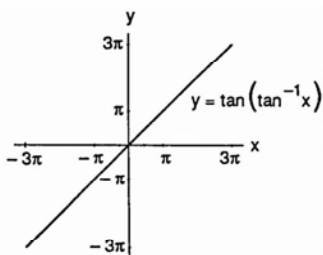

60. (a) Domain: $-\infty < x < \infty$; Range: $-\frac{\pi}{2} \leq y \leq \frac{\pi}{2}$

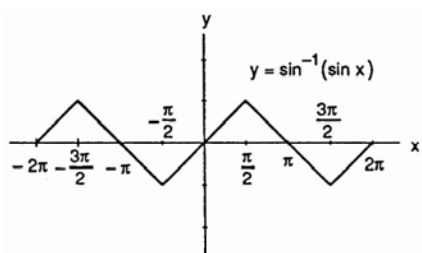

- (b) Domain: $-1 \leq x \leq 1$; Range: $-1 \leq y \leq 1$

The graph of $y = \sin^{-1}(\sin x)$ is periodic; the graph of $y = \sin(\sin^{-1} x) = x$ for $-1 \leq x \leq 1$.

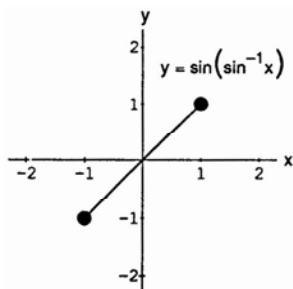

61. (a) Domain: $-\infty < x < \infty$; Range: $0 \leq y \leq \pi$

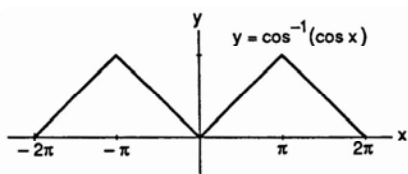

- (b) Domain: $-1 \leq x \leq 1$; Range: $-1 \leq y \leq 1$

The graph of $y = \cos^{-1}(\cos x)$ is periodic; the graph of $y = \cos(\cos^{-1} x) = x$ for $-1 \leq x \leq 1$.

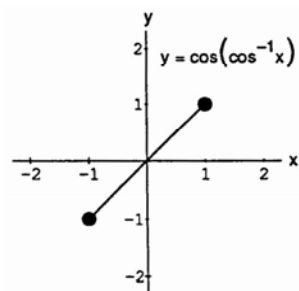

62. Since the domain of $\sec^{-1} x$ is $(-\infty, -1] \cup [1, \infty)$, we have $\sec(\sec^{-1} x) = x$ for $|x| \geq 1$. The graph of $y = \sec(\sec^{-1} x)$ is the line $y = x$ with the open line segment from $(-1, -1)$ to $(1, 1)$ removed.

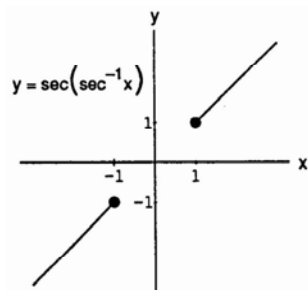

63. The graphs are identical for $y = 2 \sin(2 \tan^{-1} x)$
- $$= 4[\sin(\tan^{-1} x)][\cos(\tan^{-1} x)]$$
- $$= 4\left(\frac{x}{\sqrt{x^2+1}}\right)\left(\frac{1}{\sqrt{x^2+1}}\right)$$
- $$= \frac{4x}{x^2+1} \text{ from the triangle}$$

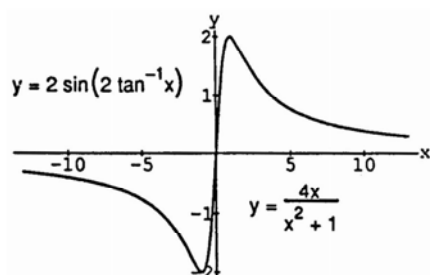
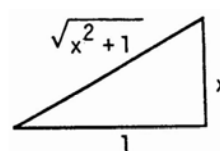

64. The graphs are identical for $y = \cos(2 \sec^{-1} x)$
- $$= \cos^2(\sec^{-1} x) - \sin^2(\sec^{-1} x)$$
- $$= \frac{1}{x^2} - \frac{x^2-1}{x^2}$$
- $$= \frac{2-x^2}{x^2} \text{ from the triangle}$$

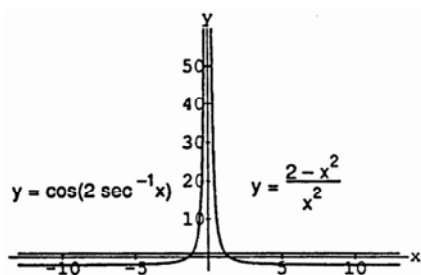
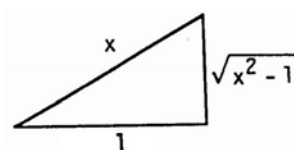

65. The values of f increase over the interval $[-1, 1]$ because $f' > 0$, and the graph of f steepens as the values of f' increase towards the ends of the interval. The graph of f is concave down to the left of the origin where $f'' < 0$, and concave up to the right of the origin where $f'' > 0$. There is an inflection point at $x = 0$ where $f'' = 0$ and f' has a local minimum value.

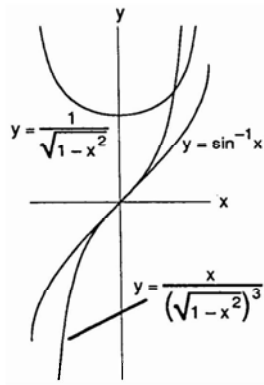

66. The values of f increase throughout the interval $(-\infty, \infty)$ because $f' > 0$, and they increase most rapidly near the origin where the values of f' are relatively large. The graph of f is concave up to the left of the origin where $f'' > 0$, and concave down to the right of the origin where $f'' < 0$. There is an inflection point at $x = 0$ where $f'' = 0$ and f' has a local maximum value.

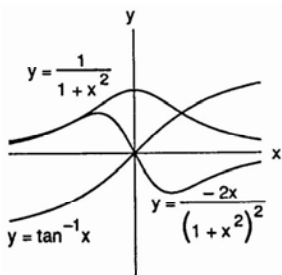

3.10 RELATED RATES

1. $A = \pi r^2 \Rightarrow \frac{dA}{dt} = 2\pi r \frac{dr}{dt}$
2. $S = 4\pi r^2 \Rightarrow \frac{dS}{dt} = 8\pi r \frac{dr}{dt}$
3. $y = 5x, \frac{dx}{dt} = 2 \Rightarrow \frac{dy}{dt} = 5 \frac{dx}{dt} \Rightarrow \frac{dy}{dt} = 5(2) = 10$
4. $2x + 3y = 12, \frac{dy}{dt} = -2 \Rightarrow 2 \frac{dx}{dt} + 3 \frac{dy}{dt} = 0 \Rightarrow 2 \frac{dx}{dt} + 3(-2) = 0 \Rightarrow \frac{dx}{dt} = 3$

5. $y = x^2$, $\frac{dx}{dt} = 3 \Rightarrow \frac{dy}{dt} = 2x \frac{dx}{dt}$; when $x = -1 \Rightarrow \frac{dy}{dt} = 2(-1)(3) = -6$
6. $x = y^3 - y$, $\frac{dy}{dt} = 5 \Rightarrow \frac{dx}{dt} = 3y^2 \frac{dy}{dt} - \frac{dy}{dt}$; when $y = 2 \Rightarrow \frac{dx}{dt} = 3(2)^2(5) - (5) = 55$
7. $x^2 + y^2 = 25$, $\frac{dx}{dt} = -2 \Rightarrow 2x \frac{dx}{dt} + 2y \frac{dy}{dt} = 0$; when $x = 3$ and $y = -4 \Rightarrow 2(3)(-2) + 2(-4) \frac{dy}{dt} = 0 \Rightarrow \frac{dy}{dt} = -\frac{3}{2}$
8. $x^2 y^3 = \frac{4}{27}$, $\frac{dy}{dt} = \frac{1}{2} \Rightarrow 3x^2 y^2 \frac{dy}{dt} + 2xy^3 \frac{dx}{dt} = 0$; when $x = 2 \Rightarrow (2)^2 y^3 = \frac{4}{27} \Rightarrow y = \frac{1}{3}$.
Thus $3(2)^2 \left(\frac{1}{3}\right)^2 \left(\frac{1}{2}\right) + 2(2)\left(\frac{1}{3}\right)^3 \frac{dx}{dt} = 0 \Rightarrow \frac{dx}{dt} = -\frac{9}{2}$
9. $L = \sqrt{x^2 + y^2}$, $\frac{dx}{dt} = -1$, $\frac{dy}{dt} = 3 \Rightarrow \frac{dL}{dt} = \frac{1}{2\sqrt{x^2 + y^2}} \left(2x \frac{dx}{dt} + 2y \frac{dy}{dt} \right) = \frac{x \frac{dx}{dt} + y \frac{dy}{dt}}{\sqrt{x^2 + y^2}}$; when $x = 5$ and $y = 12$
 $\Rightarrow \frac{dL}{dt} = \frac{(5)(-1) + (12)(3)}{\sqrt{(5)^2 + (12)^2}} = \frac{31}{13}$
10. $r + s^2 + v^3 = 12$, $\frac{dr}{dt} = 4$, $\frac{ds}{dt} = -3 \Rightarrow \frac{dr}{dt} + 2s \frac{ds}{dt} + 3v^2 \frac{dv}{dt} = 0$; when $r = 3$ and $s = 1 \Rightarrow (3) + (1)^2 + v^3 = 12 \Rightarrow v = 2$
 $\Rightarrow 4 + 2(1)(-3) + 3(2)^2 \frac{dv}{dt} = 0 \Rightarrow \frac{dv}{dt} = \frac{1}{6}$
11. (a) $S = 6x^2$, $\frac{dx}{dt} = -5 \frac{m}{\min} \Rightarrow \frac{dS}{dt} = 12x \frac{dx}{dt}$; when $x = 3 \Rightarrow \frac{dS}{dt} = 12(3)(-5) = -180 \frac{m^2}{\min}$
(b) $V = x^3$, $\frac{dx}{dt} = -5 \frac{m}{\min} \Rightarrow \frac{dV}{dt} = 3x^2 \frac{dx}{dt}$; when $x = 3 \Rightarrow \frac{dV}{dt} = 3(3)^2(-5) = -135 \frac{m^3}{\min}$
12. $S = 6x^2$, $\frac{dS}{dt} = 72 \frac{\text{in}^2}{\text{sec}} \Rightarrow \frac{dS}{dt} = 12x \frac{dx}{dt} \Rightarrow 72 = 12(3) \frac{dx}{dt} \Rightarrow \frac{dx}{dt} = 2 \frac{\text{in}}{\text{sec}}$; $V = x^3 \Rightarrow \frac{dV}{dt} = 3x^2 \frac{dx}{dt}$; when $x = 3$
 $\Rightarrow \frac{dV}{dt} = 3(3)^2(2) = 54 \frac{\text{in}^3}{\text{sec}}$
13. (a) $V = \pi r^2 h \Rightarrow \frac{dV}{dt} = \pi r^2 \frac{dh}{dt}$ (b) $V = \pi r^2 h \Rightarrow \frac{dV}{dt} = 2\pi r h \frac{dr}{dt}$
(c) $V = \pi r^2 h \Rightarrow \frac{dV}{dt} = \pi r^2 \frac{dh}{dt} + 2\pi r h \frac{dr}{dt}$
14. (a) $V = \frac{1}{3} \pi r^2 h \Rightarrow \frac{dV}{dt} = \frac{1}{3} \pi r^2 \frac{dh}{dt}$ (b) $V = \frac{1}{3} \pi r^2 h \Rightarrow \frac{dV}{dt} = \frac{2}{3} \pi r h \frac{dr}{dt}$
(c) $\frac{dV}{dt} = \frac{1}{3} \pi r^2 \frac{dh}{dt} + \frac{2}{3} \pi r h \frac{dr}{dt}$
15. (a) $\frac{dV}{dt} = 1$ volt/sec (b) $\frac{dI}{dt} = -\frac{1}{3}$ amp/sec
(c) $\frac{dV}{dt} = R \left(\frac{dI}{dt} \right) + I \left(\frac{dR}{dt} \right) \Rightarrow \frac{dR}{dt} = \frac{1}{I} \left(\frac{dV}{dt} - R \frac{dI}{dt} \right) \Rightarrow \frac{dR}{dt} = \frac{1}{I} \left(\frac{dV}{dt} - \frac{V}{I} \frac{dI}{dt} \right)$
(d) $\frac{dR}{dt} = \frac{1}{2} \left[1 - \frac{12}{2} \left(-\frac{1}{3} \right) \right] = \left(\frac{1}{2} \right) (3) = \frac{3}{2}$ ohms/sec, R is increasing
16. (a) $P = RI^2 \Rightarrow \frac{dP}{dt} = I^2 \frac{dR}{dt} + 2RI \frac{dI}{dt}$
(b) $P = RI^2 \Rightarrow 0 = \frac{dP}{dt} = I^2 \frac{dR}{dt} + 2RI \frac{dI}{dt} \Rightarrow \frac{dR}{dt} = -\frac{2RI}{I^2} \frac{dI}{dt} = -\frac{2\left(\frac{P}{I}\right)}{I^2} \frac{dI}{dt} = -\frac{2P}{I^3} \frac{dI}{dt}$
17. (a) $s = \sqrt{x^2 + y^2} = (x^2 + y^2)^{1/2} \Rightarrow \frac{ds}{dt} = \frac{x}{\sqrt{x^2 + y^2}} \frac{dx}{dt}$
(b) $s = \sqrt{x^2 + y^2} = (x^2 + y^2)^{1/2} \Rightarrow \frac{ds}{dt} = \frac{x}{\sqrt{x^2 + y^2}} \frac{dx}{dt} + \frac{y}{\sqrt{x^2 + y^2}} \frac{dy}{dt}$
(c) $s = \sqrt{x^2 + y^2} \Rightarrow s^2 = x^2 + y^2 \Rightarrow 2s \frac{ds}{dt} = 2x \frac{dx}{dt} + 2y \frac{dy}{dt} \Rightarrow 2s \cdot 0 = 2x \frac{dx}{dt} + 2y \frac{dy}{dt} \Rightarrow \frac{dx}{dt} = -\frac{y}{x} \frac{dy}{dt}$

18. (a) $s = \sqrt{x^2 + y^2 + z^2} \Rightarrow s^2 = x^2 + y^2 + z^2 \Rightarrow 2s \frac{ds}{dt} = 2x \frac{dx}{dt} + 2y \frac{dy}{dt} + 2z \frac{dz}{dt}$
 $\Rightarrow \frac{ds}{dt} = \frac{x}{\sqrt{x^2 + y^2 + z^2}} \frac{dx}{dt} + \frac{y}{\sqrt{x^2 + y^2 + z^2}} \frac{dy}{dt} + \frac{z}{\sqrt{x^2 + y^2 + z^2}} \frac{dz}{dt}$
- (b) From part (a) with $\frac{dx}{dt} = 0 \Rightarrow \frac{ds}{dt} = \frac{y}{\sqrt{x^2 + y^2 + z^2}} \frac{dy}{dt} + \frac{z}{\sqrt{x^2 + y^2 + z^2}} \frac{dz}{dt}$
- (c) From part (a) with $\frac{ds}{dt} = 0 \Rightarrow 0 = 2x \frac{dx}{dt} + 2y \frac{dy}{dt} + 2z \frac{dz}{dt} \Rightarrow \frac{dx}{dt} + \frac{y}{x} \frac{dy}{dt} + \frac{z}{x} \frac{dz}{dt} = 0$
19. (a) $A = \frac{1}{2} ab \sin \theta \Rightarrow \frac{dA}{dt} = \frac{1}{2} ab \cos \theta \frac{d\theta}{dt}$ (b) $A = \frac{1}{2} ab \sin \theta \Rightarrow \frac{dA}{dt} = \frac{1}{2} ab \cos \theta \frac{d\theta}{dt} + \frac{1}{2} b \sin \theta \frac{da}{dt}$
- (c) $A = \frac{1}{2} ab \sin \theta \Rightarrow \frac{dA}{dt} = \frac{1}{2} ab \cos \theta \frac{d\theta}{dt} + \frac{1}{2} b \sin \theta \frac{da}{dt} + \frac{1}{2} a \sin \theta \frac{db}{dt}$
20. Given $A = \pi r^2$, $\frac{dr}{dt} = 0.01$ cm/sec, and $r = 50$ cm. Since $\frac{dA}{dt} = 2\pi r \frac{dr}{dt}$, then $\frac{dA}{dt} \Big|_{r=50} = 2\pi(50) \left(\frac{1}{100} \right) = \pi$ cm²/min.
21. Given $\frac{d\ell}{dt} = -2$ cm/sec, $\frac{dw}{dt} = 2$ cm/sec, $\ell = 12$ cm and $w = 5$ cm.
- (a) $A = \ell w \Rightarrow \frac{dA}{dt} = \ell \frac{dw}{dt} + w \frac{d\ell}{dt} \Rightarrow \frac{dA}{dt} = 12(2) + 5(-2) = 14$ cm²/sec, increasing
- (b) $P = 2\ell + 2w \Rightarrow \frac{dP}{dt} = 2 \frac{d\ell}{dt} + 2 \frac{dw}{dt} = 2(-2) + 2(2) = 0$ cm/sec, constant
- (c) $D = \sqrt{w^2 + \ell^2} = (w^2 + \ell^2)^{1/2} \Rightarrow \frac{dD}{dt} = \frac{1}{2} (w^2 + \ell^2)^{-1/2} \left(2w \frac{dw}{dt} + 2\ell \frac{d\ell}{dt} \right) \Rightarrow \frac{dD}{dt} = \frac{w \frac{dw}{dt} + \ell \frac{d\ell}{dt}}{\sqrt{w^2 + \ell^2}} = \frac{(5)(2) + (12)(-2)}{\sqrt{25 + 144}}$
 $= -\frac{14}{13}$ cm/sec, decreasing
22. (a) $V = xyz \Rightarrow \frac{dV}{dt} = yz \frac{dx}{dt} + xz \frac{dy}{dt} + xy \frac{dz}{dt} \Rightarrow \frac{dV}{dt} \Big|_{(4, 3, 2)} = (3)(2)(1) + (4)(2)(-2) + (4)(3)(1) = 2$ m³/sec
- (b) $S = 2xy + 2xz + 2yz \Rightarrow \frac{dS}{dt} = (2y + 2z) \frac{dx}{dt} + (2x + 2z) \frac{dy}{dt} + (2x + 2y) \frac{dz}{dt}$
 $\Rightarrow \frac{dS}{dt} \Big|_{(4, 3, 2)} = (10)(1) + (12)(-2) + (14)(1) = 0$ m²/sec
- (c) $\ell = \sqrt{x^2 + y^2 + z^2} = (x^2 + y^2 + z^2)^{1/2} \Rightarrow \frac{d\ell}{dt} = \frac{x}{\sqrt{x^2 + y^2 + z^2}} \frac{dx}{dt} + \frac{y}{\sqrt{x^2 + y^2 + z^2}} \frac{dy}{dt} + \frac{z}{\sqrt{x^2 + y^2 + z^2}} \frac{dz}{dt}$
 $\Rightarrow \frac{d\ell}{dt} \Big|_{(4, 3, 2)} = \left(\frac{4}{\sqrt{29}} \right) (1) + \left(\frac{3}{\sqrt{29}} \right) (-2) + \left(\frac{2}{\sqrt{29}} \right) (1) = 0$ m/sec
23. Given: $\frac{dx}{dt} = 5$ ft/sec, the ladder is 13 ft long, and $x = 12$, $y = 5$ at the instant of time
- (a) Since $x^2 + y^2 = 169 \Rightarrow \frac{dy}{dt} = -\frac{x}{y} \frac{dx}{dt} = -\left(\frac{12}{5} \right) (5) = -12$ ft/sec, the ladder is sliding down the wall
- (b) The area of the triangle formed by the ladder and walls is $A = \frac{1}{2} xy \Rightarrow \frac{dA}{dt} = \left(\frac{1}{2} \right) \left(x \frac{dy}{dt} + y \frac{dx}{dt} \right)$. The area is changing at $\frac{1}{2} [12(-12) + 5(5)] = -\frac{119}{2} = -59.5$ ft²/sec.
- (c) $\cos \theta = \frac{x}{13} \Rightarrow -\sin \theta \frac{d\theta}{dt} = \frac{1}{13} \cdot \frac{dx}{dt} \Rightarrow \frac{d\theta}{dt} = -\frac{1}{13 \sin \theta} \cdot \frac{dx}{dt} = -\left(\frac{1}{5} \right) (5) = -1$ rad/sec
24. $s^2 = y^2 + x^2 \Rightarrow 2s \frac{ds}{dt} = 2x \frac{dx}{dt} + 2y \frac{dy}{dt} \Rightarrow \frac{ds}{dt} = \frac{1}{s} \left(x \frac{dx}{dt} + y \frac{dy}{dt} \right) \Rightarrow \frac{ds}{dt} = \frac{1}{\sqrt{169}} [5(-442) + 12(-481)] = -614$ knots
25. Let s represent the distance between the girl and the kite and x represents the horizontal distance between the girl and kite $\Rightarrow s^2 = (300)^2 + x^2 \Rightarrow \frac{ds}{dt} = \frac{x}{s} \frac{dx}{dt} = \frac{400(25)}{500} = 20$ ft/sec.
26. When the diameter is 3.8 in., the radius is 1.9 in. and $\frac{dr}{dt} = \frac{1}{3000}$ in/min. Also $V = 6\pi r^2 \Rightarrow \frac{dV}{dt} = 12\pi r \frac{dr}{dt}$
 $\Rightarrow \frac{dV}{dt} = 12\pi(1.9) \left(\frac{1}{3000} \right) = 0.0076\pi$. The volume is changing at about 0.0239 in³/min.

27. $V = \frac{1}{3}\pi r^2 h$, $h = \frac{3}{8}(2r) = \frac{3r}{4} \Rightarrow r = \frac{4h}{3} \Rightarrow V = \frac{1}{3}\pi \left(\frac{4h}{3}\right)^2 h = \frac{16\pi h^3}{27} \Rightarrow \frac{dV}{dt} = \frac{16\pi h^2}{9} \frac{dh}{dt}$
- (a) $\left. \frac{dh}{dt} \right|_{h=4} = \left(\frac{9}{16\pi 4^2}\right)(10) = \frac{90}{256\pi} \approx 0.1119 \text{ m/sec} = 11.19 \text{ cm/sec}$
- (b) $r = \frac{4h}{3} \Rightarrow \frac{dr}{dt} = \frac{4}{3} \frac{dh}{dt} = \frac{4}{3} \left(\frac{90}{256\pi}\right) = \frac{15}{32\pi} \approx 0.1492 \text{ m/sec} = 14.92 \text{ cm/sec}$
28. (a) $V = \frac{1}{3}\pi r^2 h$ and $r = \frac{15h}{2} \Rightarrow V = \frac{1}{3}\pi \left(\frac{15h}{2}\right)^2 h = \frac{75\pi h^3}{4} \Rightarrow \frac{dV}{dt} = \frac{225\pi h^2}{4} \frac{dh}{dt} \Rightarrow \left. \frac{dh}{dt} \right|_{h=5} = \frac{4(-50)}{225\pi(5)^2} = \frac{-8}{225\pi} \approx -0.0113 \text{ m/min} = -1.13 \text{ cm/min}$
- (b) $r = \frac{15h}{2} \Rightarrow \frac{dr}{dt} = \frac{15}{2} \frac{dh}{dt} \Rightarrow \left. \frac{dr}{dt} \right|_{h=5} = \left(\frac{15}{2}\right) \left(\frac{-8}{225\pi}\right) = \frac{-4}{15\pi} \approx -0.0849 \text{ m/sec} = -8.49 \text{ cm/sec}$
29. (a) $V = \frac{\pi}{3} y^2 (3R - y) \Rightarrow \frac{dV}{dt} = \frac{\pi}{3} [2y(3R - y) + y^2(-1)] \frac{dy}{dt} \Rightarrow \frac{dy}{dt} = \left[\frac{\pi}{3} (6Ry - 3y^2)\right]^{-1} \frac{dV}{dt} \Rightarrow$ at $R = 13$ and $y = 8$
we have $\frac{dy}{dt} = \frac{1}{144\pi}(-6) = \frac{-1}{24\pi} \text{ m/min}$
- (b) The hemisphere is one the circle $r^2 + (13 - y)^2 = 169 \Rightarrow r = \sqrt{26y - y^2} \text{ m}$
- (c) $r = (26y - y^2)^{1/2} \Rightarrow \frac{dr}{dt} = \frac{1}{2} (26y - y^2)^{-1/2} (26 - 2y) \frac{dy}{dt} \Rightarrow \frac{dr}{dt} = \frac{13 - y}{\sqrt{26y - y^2}} \frac{dy}{dt}$
 $\Rightarrow \left. \frac{dr}{dt} \right|_{y=8} = \frac{13 - 8}{\sqrt{26 \cdot 8 - 64}} \left(\frac{-1}{24\pi}\right) = \frac{-5}{288\pi} \text{ m/min}$
30. If $V = \frac{4}{3}\pi r^3$, $S = 4\pi r^2$, and $\frac{dV}{dt} = kS = 4k\pi r^2$, then $\frac{dV}{dt} = 4\pi r^2 \frac{dr}{dt} \Rightarrow 4k\pi r^2 = 4\pi r^2 \frac{dr}{dt} \Rightarrow \frac{dr}{dt} = k$, a constant.
Therefore, the radius is increasing at a constant rate.
31. If $V = \frac{4}{3}\pi r^3$, $r = 5$, and $\frac{dV}{dt} = 100\pi \text{ ft}^3/\text{min}$, then $\frac{dV}{dt} = 4\pi r^2 \frac{dr}{dt} \Rightarrow \frac{dr}{dt} = 1 \text{ ft/min}$. Then $S = 4\pi r^2$
 $\Rightarrow \frac{dS}{dt} = 8\pi r \frac{dr}{dt} = 8\pi(5)(1) = 40\pi \text{ ft}^2/\text{min}$, the rate at which the surface area is increasing.
32. Let s represent the length of the rope and x the horizontal distance of the boat from the dock.
- (a) We have $s^2 = x^2 + 36 \Rightarrow \frac{dx}{dt} = \frac{s}{x} \frac{ds}{dt} = \frac{s}{\sqrt{s^2 - 36}} \frac{ds}{dt}$. Therefore, the boat is approaching the dock at
 $\left. \frac{dx}{dt} \right|_{s=10} = \frac{10}{\sqrt{10^2 - 36}}(-2) = -2.5 \text{ ft/sec}$.
- (b) $\cos \theta = \frac{6}{r} \Rightarrow -\sin \theta \frac{d\theta}{dt} = -\frac{6}{r^2} \frac{dr}{dt} \Rightarrow \frac{d\theta}{dt} = \frac{6}{r^2 \sin \theta} \frac{dr}{dt}$. Thus, $r = 10$, $x = 8$, and $\sin \theta = \frac{8}{10}$
 $\Rightarrow \frac{d\theta}{dt} = \frac{6}{10^2 \left(\frac{8}{10}\right)}(-2) = -\frac{3}{20} \text{ rad/sec}$
33. Let s represent the distance between the bicycle and balloon, h the height of the balloon and x the horizontal distance between the balloon and the bicycle. The relationship between the variables is $s^2 = h^2 + x^2$
 $\Rightarrow \frac{ds}{dt} = \frac{1}{s} \left(h \frac{dh}{dt} + x \frac{dx}{dt}\right) \Rightarrow \frac{ds}{dt} = \frac{1}{85} [68(1) + 51(17)] = 11 \text{ ft/sec}$.
34. (a) Let h be the height of the coffee in the pot. Since the radius of the pot is 3, the volume of the coffee is
 $V = 9\pi h \Rightarrow \frac{dV}{dt} = 9\pi \frac{dh}{dt} \Rightarrow$ the rate the coffee is rising is $\frac{dh}{dt} = \frac{1}{9\pi} \frac{dV}{dt} = \frac{10}{9\pi} \text{ in/min}$.
- (b) Let h the height of the coffee in the pot. From the figure, the radius of the filter $r = \frac{h}{2} \Rightarrow V = \frac{1}{3}\pi r^2 h = \frac{\pi h^3}{12}$,
the volume of the filter. The rate the coffee is falling is $\frac{dh}{dt} = \frac{4}{\pi h^2} \frac{dV}{dt} = \frac{4}{25\pi}(-10) = -\frac{8}{5\pi} \text{ in/min}$.

35. $y = QD^{-1} \Rightarrow \frac{dy}{dt} = D^{-1} \frac{dQ}{dt} - QD^{-2} \frac{dD}{dt} = \frac{1}{41}(0) - \frac{233}{(41)^2}(-2) = \frac{466}{1681} \text{ L/min} \Rightarrow$ increasing about 0.2772 L/min

36. Let $P(x, y)$ represent a point on the curve $y = x^2$ and θ the angle of inclination of a line containing P and the origin. Consequently, $\tan \theta = \frac{y}{x} \Rightarrow \tan \theta = \frac{x^2}{x} = x \Rightarrow \sec^2 \theta \frac{d\theta}{dt} = \frac{dx}{dt} \Rightarrow \frac{d\theta}{dt} = \cos^2 \theta \frac{dx}{dt}$. Since $\frac{dx}{dt} = 10$ m/sec and $\cos^2 \theta|_{x=3} = \frac{x^2}{y^2+x^2} = \frac{3^2}{9^2+3^2} = \frac{1}{10}$, we have $\frac{d\theta}{dt}|_{x=3} = 1$ rad/sec.

37. The distance from the origin is $s = \sqrt{x^2 + y^2}$ and we wish to find $\frac{ds}{dt}|_{(5,12)} = \frac{1}{2}(x^2 + y^2)^{-1/2} \left(2x \frac{dx}{dt} + 2y \frac{dy}{dt} \right) \Big|_{(5,12)} = \frac{(5)(-1) + (12)(-5)}{\sqrt{25+144}} = -5 \text{ m/sec}$

38. Let $s =$ distance of the car from the foot of perpendicular in the textbook diagram $\Rightarrow \tan \theta = \frac{s}{132}$
 $\Rightarrow \sec^2 \theta \frac{d\theta}{dt} = \frac{1}{132} \frac{ds}{dt} \Rightarrow \frac{d\theta}{dt} = \frac{\cos^2 \theta}{132} \frac{ds}{dt}$; $\frac{ds}{dt} = -264$ and $\theta = 0 \Rightarrow \frac{d\theta}{dt} = -2$ rad/sec. A half second later the car has traveled 132 ft right of the perpendicular $\Rightarrow |\theta| = \frac{\pi}{4}$, $\cos^2 \theta = \frac{1}{2}$, and $\frac{ds}{dt} = 264$ (since s increases)
 $\Rightarrow \frac{d\theta}{dt} = \left(\frac{1}{2}\right) \frac{1}{132} (264) = 1$ rad/sec.

39. Let $s = 16t^2$ represent the distance the ball has fallen, h the distance between the ball and the ground, and l the distance between the shadow and the point directly beneath the ball. Accordingly, $s + h = 50$ and since the triangle LOQ and triangle PRQ are similar we have $l = \frac{30h}{50-h} \Rightarrow h = 50 - 16t^2$
 and $l = \frac{30(50-16t^2)}{50-(50-16t^2)} = \frac{1500}{16t^2} - 30 \Rightarrow \frac{dl}{dt} = -\frac{1500}{8t^3}$
 $\Rightarrow \frac{dl}{dt} \Big|_{t=\frac{1}{2}} = -1500$ ft/sec.

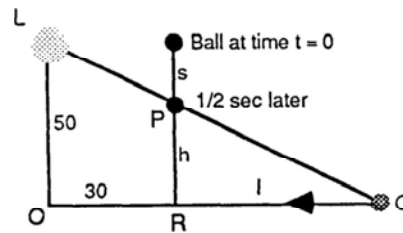

40. When x represents the length of the shadow, then $\tan \theta = \frac{80}{x} \Rightarrow \sec^2 \theta \frac{d\theta}{dt} = -\frac{80}{x^2} \frac{dx}{dt} \Rightarrow \frac{dx}{dt} = \frac{-x^2 \sec^2 \theta}{80} \frac{d\theta}{dt}$.
 We are given that $\frac{d\theta}{dt} = 0.27^\circ = \frac{3\pi}{2000}$ rad/min. At $x = 60$, $\cos \theta = \frac{3}{5} \Rightarrow \left| \frac{dx}{dt} \right| = \left| \frac{-x^2 \sec^2 \theta}{80} \frac{d\theta}{dt} \right| \Big|_{\left(\frac{d\theta}{dt} = \frac{3\pi}{2000} \text{ and } \sec \theta = \frac{5}{3} \right)}$
 $= \frac{3\pi}{16}$ ft/min ≈ 0.589 ft/min ≈ 7.1 in./min.

41. The volume of the ice is $V = \frac{4}{3} \pi r^3 - \frac{4}{3} \pi 4^3 \Rightarrow \frac{dV}{dt} = 4\pi r^2 \frac{dr}{dt} \Rightarrow \frac{dr}{dt} \Big|_{r=6} = \frac{-5}{72\pi}$ in./min when $\frac{dV}{dt} = -10$ in³/min, the thickness of the ice is decreasing at $\frac{5}{72\pi}$ in/min. The surface area is $S = 4\pi r^2 \Rightarrow \frac{dS}{dt} = 8\pi r \frac{dr}{dt} \Rightarrow \frac{dS}{dt} \Big|_{r=6} = 48\pi \left(\frac{-5}{72\pi} \right) = -\frac{10}{3}$ in²/min, the outer surface area of the ice is decreasing at $\frac{10}{3}$ in²/min.

42. Let s represent the horizontal distance between the car and plane while r is the line-of-sight distance between the car and plane $\Rightarrow 9 + s^2 = r^2 \Rightarrow \frac{ds}{dt} = \frac{r}{\sqrt{r^2-9}} \frac{dr}{dt} \Rightarrow \frac{ds}{dt} \Big|_{r=5} = \frac{5}{\sqrt{16}} (-160) = -200$ mph \Rightarrow speed of plane + speed of car = 200 mph \Rightarrow the speed of the car is 80 mph.

43. Let x represent distance of the player from second base and s the distance to third base. Then $\frac{dx}{dt} = -16$ ft/sec
- (a) $s^2 = x^2 + 8100 \Rightarrow 2s \frac{ds}{dt} = 2x \frac{dx}{dt} \Rightarrow \frac{ds}{dt} = \frac{x}{s} \frac{dx}{dt}$. When the player is 30 ft from first base, $x = 60 \Rightarrow s = 30\sqrt{13}$ and $\frac{ds}{dt} = \frac{60}{30\sqrt{13}}(-16) = \frac{-32}{\sqrt{13}} \approx -8.875$ ft/sec
- (b) $\sin \theta_1 = \frac{90}{s} \Rightarrow \cos \theta_1 \frac{d\theta_1}{dt} = -\frac{90}{s^2} \cdot \frac{ds}{dt} \Rightarrow \frac{d\theta_1}{dt} = -\frac{90}{s^2 \cos \theta_1} \cdot \frac{ds}{dt} = -\frac{90}{s \cdot k} \cdot \frac{ds}{dt}$. Therefore, $x = 60$ and $s = 30\sqrt{13} \Rightarrow \frac{d\theta_1}{dt} = -\frac{90}{(30\sqrt{13})(60)} \cdot \left(\frac{-32}{\sqrt{13}}\right) = \frac{8}{65}$ rad/sec; $\cos \theta_2 = \frac{90}{s} \Rightarrow -\sin \theta_2 \frac{d\theta_2}{dt} = -\frac{90}{s^2} \cdot \frac{ds}{dt} \Rightarrow \frac{d\theta_2}{dt} = \frac{90}{s^2 \sin \theta_2} \cdot \frac{ds}{dt} = \frac{90}{s \cdot k} \cdot \frac{ds}{dt}$. Therefore, $x = 60$ and $s = 30\sqrt{13} \Rightarrow \frac{d\theta_2}{dt} = \frac{90}{(30\sqrt{13})(60)} \cdot \left(\frac{-32}{\sqrt{13}}\right) = -\frac{8}{65}$ rad/sec.
- (c) $\frac{d\theta_1}{dt} = -\frac{90}{s^2 \cos \theta_1} \cdot \frac{ds}{dt} = -\frac{90}{\left(\frac{x}{s}\right)^2 \cdot \left(\frac{dx}{dt}\right)} \cdot \left(\frac{dx}{dt}\right) = \left(-\frac{90}{s^2}\right) \left(\frac{dx}{dt}\right) = \left(-\frac{90}{x^2 + 8100}\right) \frac{dx}{dt} \Rightarrow \lim_{x \rightarrow 0} \frac{d\theta_1}{dt}$
 $= \lim_{x \rightarrow 0} \left(-\frac{90}{x^2 + 8100}\right) (-15) = \frac{1}{6}$ rad/sec; $\frac{d\theta_2}{dt} = \frac{90}{s^2 \sin \theta_2} \cdot \frac{ds}{dt} = \left(\frac{90}{\left(\frac{x}{s}\right)^2 \cdot \left(\frac{dx}{dt}\right)}\right) \cdot \left(\frac{dx}{dt}\right) = \left(\frac{90}{s^2}\right) \left(\frac{dx}{dt}\right)$
 $= \left(\frac{90}{x^2 + 8100}\right) \frac{dx}{dt} \Rightarrow \lim_{x \rightarrow 0} \frac{d\theta_2}{dt} = -\frac{1}{6}$ rad/sec
44. Let a represent the distance between point O and ship A , b the distance between point O and ship B , and D the distance between the ships. By the Law of Cosines, $D^2 = a^2 + b^2 - 2ab \cos 120^\circ \Rightarrow \frac{dD}{dt} = \frac{1}{2D} \left[2a \frac{da}{dt} + 2b \frac{db}{dt} + \frac{1}{2D} \left[2a \frac{da}{dt} + 2b \frac{db}{dt} + a \frac{db}{dt} + b \frac{da}{dt} \right] \right]$. When $a = 5$, $\frac{da}{dt} = 14$, $b = 3$, and $\frac{db}{dt} = 21$, then $\frac{dD}{dt} = \frac{413}{2D}$ where $D = 7$. The ships are moving $\frac{dD}{dt} = 29.5$ knots apart.
45. The hour hand moves clockwise from 4 at $30^\circ/\text{hr} = 0.5^\circ/\text{min}$. The minute hand, starting at 12, chases the hour hand at $360^\circ/\text{hr} = 6^\circ/\text{min}$. Thus, the angle between them is decreasing and is changing at $0.5^\circ/\text{min} - 6^\circ/\text{min} = -5.5^\circ/\text{min}$.
46. The volume of the slick in cubic feet is $V = \left(\frac{3}{4}\right)\pi\left(\frac{a}{2}\right)\left(\frac{b}{2}\right)$, where a is the length of the major axis and b is the length of the minor axis. $\frac{dV}{dt} = \frac{3\pi}{4} \left(\frac{a}{2} \frac{d}{dt} \left(\frac{b}{2} \right) + \frac{b}{2} \frac{d}{dt} \left(\frac{a}{2} \right) \right) = \frac{3\pi}{16} (a \frac{db}{dt} + b \frac{da}{dt})$. Convert all measurements to feet and substitute: $\frac{dV}{dt} = \frac{3\pi}{16} (2(5280)(10) + \frac{3}{4}(5280)(30)) = \frac{3\pi}{16} (224,400) \approx 132,183$ ft³/hr

3.11 LINEARIZATION AND DIFFERENTIALS

1. $f(x) = x^3 - 2x + 3 \Rightarrow f'(x) = 3x^2 - 2 \Rightarrow L(x) = f'(2)(x-2) + f(2) = 10(x-2) + 7 \Rightarrow L(x) = 10x - 13$ at $x = 2$
2. $f(x) = \sqrt{x^2 + 9} = (x^2 + 9)^{1/2} \Rightarrow f'(x) = \left(\frac{1}{2}\right)(x^2 + 9)^{-1/2}(2x) = \frac{x}{\sqrt{x^2 + 9}} \Rightarrow L(x) = f'(-4)(x+4) + f(-4)$
 $= -\frac{4}{5}(x+4) + 5 \Rightarrow L(x) = -\frac{4}{5}x + \frac{9}{5}$ at $x = -4$
3. $f(x) = x + \frac{1}{x} \Rightarrow f'(x) = 1 - x^{-2} \Rightarrow L(x) = f(1) + f'(1)(x-1) = 2 + 0(x-1) = 2$
4. $f(x) = x^{1/3} \Rightarrow f'(x) = \frac{1}{3x^{2/3}} \Rightarrow L(x) = f'(-8)(x - (-8)) + f(-8) = \frac{1}{12}(x+8) - 2 \Rightarrow L(x) = \frac{1}{12}x - \frac{4}{3}$
5. $f(x) = \tan x \Rightarrow f'(x) = \sec^2 x \Rightarrow L(x) = f(\pi) + f'(\pi)(x - \pi) = 0 + 1(x - \pi) = x - \pi$
6. (a) $f(x) = \sin x \Rightarrow f'(x) = \cos x \Rightarrow L(x) = f(0) + f'(0)(x-0) = x \Rightarrow L(x) = x$
 (b) $f(x) = \cos x \Rightarrow f'(x) = -\sin x \Rightarrow L(x) = f(0) + f'(0)(x-0) = 1 \Rightarrow L(x) = 1$
 (c) $f(x) = \tan x \Rightarrow f'(x) = \sec^2 x \Rightarrow L(x) = f(0) + f'(0)(x-0) = x \Rightarrow L(x) = x$
 (d) $f(x) = e^x \Rightarrow f'(x) = e^x \Rightarrow L(x) = f(0) + f'(0)(x-0) = 1 + x \Rightarrow L(x) = 1 + x$
 (e) $f(x) = \ln(1+x) \Rightarrow f'(x) = \frac{1}{1+x} \Rightarrow L(x) = f(0) + f'(0)(x-0) = x \Rightarrow L(x) = x$
7. $f(x) = x^2 + 2x \Rightarrow f'(x) = 2x + 2 \Rightarrow L(x) = f'(0)(x-0) + f(0) = 2(x-0) + 0 \Rightarrow L(x) = 2x$ at $x = 0$
8. $f(x) = x^{-1} \Rightarrow f'(x) = -x^{-2} \Rightarrow L(x) = f'(1)(x-1) + f(1) = (-1)(x-1) + 1 \Rightarrow L(x) = -x + 2$ at $x = 1$
9. $f(x) = 2x^2 + 4x - 3 \Rightarrow f'(x) = 4x + 4 \Rightarrow L(x) = f'(-1)(x+1) + f(-1) = 0(x+1) + (-5) \Rightarrow L(x) = -5$ at $x = -1$
10. $f(x) = 1 + x \Rightarrow f'(x) = 1 \Rightarrow L(x) = f'(8)(x-8) + f(8) = 1(x-8) + 9 \Rightarrow L(x) = x + 1$ at $x = 8$
11. $f(x) = \sqrt[3]{x} = x^{1/3} \Rightarrow f'(x) = \left(\frac{1}{3}\right)x^{-2/3} \Rightarrow L(x) = f'(8)(x-8) + f(8) = \frac{1}{12}(x-8) + 2 \Rightarrow L(x) = \frac{1}{12}x + \frac{4}{3}$ at $x = 8$
12. $f(x) = \frac{x}{x+1} \Rightarrow f'(x) = \frac{(1)(x+1) - (1)(x)}{(x+1)^2} = \frac{1}{(x+1)^2} \Rightarrow L(x) = f'(1)(x-1) + f(1) = \frac{1}{4}(x-1) + \frac{1}{2} \Rightarrow L(x) = \frac{1}{4}x + \frac{1}{4}$
 at $x = 1$
13. $f(x) = e^{-x} \Rightarrow f'(x) = -e^{-x} \Rightarrow L(x) = f(0) + f'(0)(x-0) = -x + 1$ at $x = 0$.
14. $f(x) = \sin^{-1} x \Rightarrow f'(x) = \frac{1}{\sqrt{1-x^2}} \Rightarrow L(x) = f(0) + f'(0)(x-0) = x$ at $x = 0$.
15. $f'(x) = k(1+x)^{k-1}$. We have $f(0) = 1$ and $f'(0) = k$. $L(x) = f(0) + f'(0)(x-0) = 1 + k(x-0) = 1 + kx$
16. (a) $f(x) = (1-x)^6 = [1+(-x)]^6 \approx 1 + 6(-x) = 1 - 6x$
 (b) $f(x) = \frac{2}{1-x} = 2[1+(-x)]^{-1} \approx 2[1+(-1)(-x)] = 2 + 2x$
 (c) $f(x) = (1+x)^{-1/2} \approx 1 + \left(-\frac{1}{2}\right)x = 1 - \frac{x}{2}$
 (d) $f(x) = \sqrt{2+x^2} = \sqrt{2}\left(1 + \frac{x^2}{2}\right)^{1/2} \approx \sqrt{2}\left(1 + \frac{1}{2}\frac{x^2}{2}\right) = \sqrt{2}\left(1 + \frac{x^2}{4}\right)$
 (e) $f(x) = (4+3x)^{1/3} = 4^{1/3}\left(1 + \frac{3x}{4}\right)^{1/3} \approx 4^{1/3}\left(1 + \frac{1}{3}\frac{3x}{4}\right) = 4^{1/3}\left(1 + \frac{x}{4}\right)$
 (f) $f(x) = \left(1 - \frac{x}{2+x}\right)^{2/3} = \left[1 + \left(-\frac{x}{2+x}\right)\right]^{2/3} \approx 1 + \frac{2}{3}\left(-\frac{x}{2+x}\right) = 1 - \frac{2x}{6+3x}$

17. (a) $(1.0002)^{50} = (1 + 0.0002)^{50} \approx 1 + 50(0.0002) = 1 + .01 = 1.01$
 (b) $\sqrt[3]{1.009} = (1 + 0.009)^{1/3} \approx 1 + \left(\frac{1}{3}\right)(0.009) = 1 + 0.003 = 1.003$
18. $f(x) = \sqrt{x+1} + \sin x = (x+1)^{1/2} + \sin x \Rightarrow f'(x) = \left(\frac{1}{2}\right)(x+1)^{-1/2} + \cos x \Rightarrow L_f(x) = f'(0)(x-0) + f(0)$
 $= \frac{3}{2}(x-0) + 1 \Rightarrow L_f(x) = \frac{3}{2}x + 1$, the linearization of $f(x)$; $g(x) = \sqrt{x+1} = (x+1)^{1/2} \Rightarrow g'(x) = \left(\frac{1}{2}\right)(x+1)^{-1/2}$
 $\Rightarrow L_g(x) = g'(0)(x-0) + g(0) = \frac{1}{2}(x-0) + 1 \Rightarrow L_g(x) = \frac{1}{2}x + 1$, the linearization of $g(x)$; $h(x) = \sin x$
 $\Rightarrow h'(x) = \cos x \Rightarrow L_h(x) = h'(0)(x-0) + h(0) = (1)(x-0) + 0 \Rightarrow L_h(x) = x$, the linearization of $h(x)$.
 $L_f(x) = L_g(x) + L_h(x)$ implies that the linearization of a sum is equal to the sum of the linearizations.
19. $y = x^3 - 3\sqrt{x} = x^3 - 3x^{1/2} \Rightarrow dy = \left(3x^2 - \frac{3}{2}x^{-1/2}\right) dx \Rightarrow dy = \left(3x^2 - \frac{3}{2\sqrt{x}}\right) dx$
20. $y = x\sqrt{1-x^2} = x(1-x^2)^{1/2} \Rightarrow dy = \left[(1)(1-x^2)^{1/2} + (x)\left(\frac{1}{2}\right)(1-x^2)^{-1/2}(-2x)\right] dx$
 $= (1-x^2)^{-1/2} \left[(1-x^2) - x^2\right] dx = \frac{(1-2x^2)}{\sqrt{1-x^2}} dx$
21. $y = \frac{2x}{1+x^2} \Rightarrow dy = \left(\frac{(2)(1+x^2) - (2x)(2x)}{(1+x^2)^2}\right) dx = \frac{2-2x^2}{(1+x^2)^2} dx$
22. $y = \frac{2\sqrt{x}}{3(1+\sqrt{x})} = \frac{2x^{1/2}}{3(1+x^{1/2})} \Rightarrow dy = \left(\frac{x^{-1/2}(3(1+x^{1/2})) - 2x^{1/2}(\frac{3}{2}x^{-1/2})}{9(1+x^{1/2})^2}\right) dx = \frac{3x^{-1/2} + 3 - 3}{9(1+x^{1/2})^2} dx \Rightarrow dy = \frac{1}{3\sqrt{x}(1+\sqrt{x})^2} dx$
23. $2y^{3/2} + xy - x = 0 \Rightarrow 3y^{1/2} dy + y dx + x dy - dx = 0 \Rightarrow (3y^{1/2} + x) dy = (1-y) dx \Rightarrow dy = \frac{1-y}{3\sqrt{y+x}} dx$
24. $xy^2 - 4x^{3/2} - y = 0 \Rightarrow y^2 dx + 2xy dy - 6x^{1/2} dx - dy = 0 \Rightarrow (2xy - 1) dy = (6x^{1/2} - y^2) dx \Rightarrow dy = \frac{6\sqrt{x} - y^2}{2xy - 1} dx$
25. $y = \sin(5\sqrt{x}) = \sin(5x^{1/2}) \Rightarrow dy = (\cos(5x^{1/2})) \left(\frac{5}{2}x^{-1/2}\right) dx \Rightarrow dy = \frac{5\cos(5\sqrt{x})}{2\sqrt{x}} dx$
26. $y = \cos(x^2) \Rightarrow dy = [-\sin(x^2)](2x) dx = -2x \sin(x^2) dx$
27. $y = 4 \tan\left(\frac{x^3}{3}\right) \Rightarrow dy = 4 \left(\sec^2\left(\frac{x^3}{3}\right)\right)(x^2) dx \Rightarrow dy = 4x^2 \sec^2\left(\frac{x^3}{3}\right) dx$
28. $y = \sec(x^2 - 1) \Rightarrow dy = [\sec(x^2 - 1) \tan(x^2 - 1)](2x) dx = 2x[\sec(x^2 - 1) \tan(x^2 - 1)] dx$
29. $y = 3 \csc(1 - 2\sqrt{x}) = 3 \csc(1 - 2x^{1/2}) \Rightarrow dy = 3(-\csc(1 - 2x^{1/2})) \cot(1 - 2x^{1/2}) (-x^{-1/2}) dx$
 $\Rightarrow dy = \frac{3}{\sqrt{x}} \csc(1 - 2\sqrt{x}) \cot(1 - 2\sqrt{x}) dx$
30. $y = 2 \cot\left(\frac{1}{\sqrt{x}}\right) = 2 \cot(x^{-1/2}) \Rightarrow dy = -2 \csc^2(x^{-1/2}) \left(-\frac{1}{2}\right)(x^{-3/2}) dx \Rightarrow dy = \frac{1}{\sqrt{x^3}} \csc^2\left(\frac{1}{\sqrt{x}}\right) dx$
31. $y = e^{\sqrt{x}} \Rightarrow dy = \frac{e^{\sqrt{x}}}{2\sqrt{x}} dx$

$$32. y = xe^{-x} \Rightarrow dy = (-xe^{-x} + e^{-x})dx = (1-x)e^{-x}dx$$

$$33. y = \ln(1+x^2) \Rightarrow dy = \frac{2x}{1+x^2}dx$$

$$34. y = \ln\left(\frac{x+1}{\sqrt{x-1}}\right) = \ln(x+1) - \frac{1}{2}\ln(x-1) \Rightarrow dy = \left(\frac{1}{x+1} - \frac{1}{2} \cdot \frac{1}{x-1}\right)dx = \frac{x-3}{2(x^2-1)}dx$$

$$35. y = \tan^{-1}\left(e^{x^2}\right) \Rightarrow dy = \frac{1}{1+(e^{x^2})^2} \cdot e^{x^2} \cdot 2x dx = \frac{2xe^{x^2}}{1+e^{2x^2}}dx$$

$$36. y = \cot^{-1}\left(\frac{1}{x^2}\right) + \cos^{-1}(2x) \text{ Note: } \frac{d}{d\theta} \cot^{-1} \theta = \frac{-1d\theta}{1+\theta^2}, \text{ so that } \frac{d}{dx} \left(\cot^{-1}\left(\frac{1}{x^2}\right) \right) = \frac{-1\left(-\frac{2}{x^3}\right)}{1+\frac{1}{x^4}} = \frac{-1\left(-\frac{2}{x^3}\right)}{\frac{x^4+1}{x^4}} = \frac{2x}{x^4+1}$$

$$\text{Note: } \frac{d}{d\theta} \cos^{-1} \theta = \frac{-1}{\sqrt{1-\theta^2}} d\theta, \text{ so that } \frac{d}{dx} (\cos^{-1}(2x)) = \frac{-1 \cdot 2}{\sqrt{1-4x^2}} = \frac{-2}{\sqrt{1-4x^2}}. \text{ Thus } dy = \left(\frac{2x}{x^4+1} - \frac{2}{\sqrt{1-4x^2}} \right) dx$$

$$37. y = \sec^{-1}(e^{-x}) \Rightarrow dy = \frac{1}{e^{-x}\sqrt{(e^{-x})^2-1}} \cdot (-e^{-x})dx = \frac{-1}{\sqrt{\left(\frac{1}{e^x}\right)^2-1}} dx = \frac{-e^x}{\sqrt{1-e^{2x}}} dx$$

$$38. y = e^{\tan^{-1}\sqrt{x^2+1}} \Rightarrow dy = e^{\tan^{-1}\sqrt{x^2+1}} \cdot \frac{1}{1+(\sqrt{x^2+1})^2} \cdot \frac{1}{2}(x^2+1)^{-1/2} \cdot 2x dx = \frac{xe^{\tan^{-1}\sqrt{x^2+1}}}{(x^2+2)\sqrt{x^2+1}} dx$$

$$39. f(x) = x^2 + 2x, x_0 = 1, dx = 0.1 \Rightarrow f'(x) = 2x + 2$$

$$(a) \Delta f = f(x_0 + dx) - f(x_0) = f(1.1) - f(1) = 3.41 - 3 = 0.41$$

$$(b) df = f'(x_0)dx = [2(1) + 2](0.1) = 0.4$$

$$(c) |\Delta f - df| = |0.41 - 0.4| = 0.01$$

$$40. f(x) = 2x^2 + 4x - 3, x_0 = -1, dx = 0.1 \Rightarrow f'(x) = 4x + 4$$

$$(a) \Delta f = f(x_0 + dx) - f(x_0) = f(-.9) - f(-1) = .02$$

$$(b) df = f'(x_0)dx = [4(-1) + 4](.1) = 0$$

$$(c) |\Delta f - df| = |.02 - 0| = .02$$

$$41. f(x) = x^3 - x, x_0 = 1, dx = 0.1 \Rightarrow f'(x) = 3x^2 - 1$$

$$(a) \Delta f = f(x_0 + dx) - f(x_0) = f(1.1) - f(1) = .231$$

$$(b) df = f'(x_0)dx = [3(1)^2 - 1](.1) = .2$$

$$(c) |\Delta f - df| = |.231 - .2| = .031$$

$$42. f(x) = x^4, x_0 = 1, dx = 0.1 \Rightarrow f'(x) = 4x^3$$

$$(a) \Delta f = f(x_0 + dx) - f(x_0) = f(1.1) - f(1) = .4641$$

$$(b) df = f'(x_0)dx = 4(1)^3(.1) = .4$$

$$(c) |\Delta f - df| = |.4641 - .4| = .0641$$

43. $f(x) = x^{-1}$, $x_0 = 0.5$, $dx = 0.1 \Rightarrow f'(x) = -x^{-2}$
 (a) $\Delta f = f(x_0 + dx) - f(x_0) = f(.6) - f(.5) = -\frac{1}{3}$
 (b) $df = f'(x_0)dx = (-4)\left(\frac{1}{10}\right) = -\frac{2}{5}$
 (c) $|\Delta f - df| = \left|-\frac{1}{3} + \frac{2}{5}\right| = \frac{1}{15}$
44. $f(x) = x^3 - 2x + 3$, $x_0 = 2$, $dx = 0.1 \Rightarrow f'(x) = 3x^2 - 2$
 (a) $\Delta f = f(x_0 + dx) - f(x_0) = f(2.1) - f(2) = 1.061$
 (b) $df = f'(x_0)dx = (10)(0.10) = 1$
 (c) $|\Delta f - df| = |1.061 - 1| = .061$
45. $V = \frac{4}{3}\pi r^3 \Rightarrow dV = 4\pi r_0^2 dr$
46. $V = x^3 \Rightarrow dV = 3x_0^2 dx$
47. $S = 6x^2 \Rightarrow dS = 12x_0 dx$
48. $S = \pi r \sqrt{r^2 + h^2} = \pi r(r^2 + h^2)^{1/2}$, h constant $\Rightarrow \frac{dS}{dr} = \pi(r^2 + h^2)^{1/2} + \pi r \cdot r(r^2 + h^2)^{-1/2} \Rightarrow \frac{dS}{dr} = \frac{\pi(r^2 + h^2) + \pi r^2}{\sqrt{r^2 + h^2}}$
 $\Rightarrow dS = \frac{\pi(2r_0^2 + h^2)}{\sqrt{r_0^2 + h^2}} dr$, h constant
49. $V = \pi r^2 h$, height constant $\Rightarrow dV = 2\pi r_0 h dr$
50. $S = 2\pi r h \Rightarrow dS = 2\pi r dh$
51. Given $r = 2$ m, $dr = .02$ m
 (a) $A = \pi r^2 \Rightarrow dA = 2\pi r dr = 2\pi(2)(.02) = .08\pi$ m²
 (b) $\left(\frac{.08\pi}{4\pi}\right)(100\%) = 2\%$
52. $C = 2\pi r$ and $dC = 2$ in. $\Rightarrow dC = 2\pi dr \Rightarrow dr = \frac{1}{\pi} \Rightarrow$ the diameter grew about $\frac{2}{\pi}$ in.; $A = \pi r^2$
 $\Rightarrow dA = 2\pi r dr = 2\pi(5)\left(\frac{1}{\pi}\right) = 10$ in.²
53. The volume of a cylinder is $V = \pi r^2 h$. When h is held fixed, we have $\frac{dV}{dr} = 2\pi r h$, and so $dV = 2\pi r h dr$. For $h = 30$ in., $r = 6$ in., and $dr = 0.5$ in., the volume of the material in the shell is approximately $dV = 2\pi r h dr = 2\pi(6)(30)(0.5) = 180\pi \approx 565.5$ in.³.
54. Let $\theta =$ angle of elevation and $h =$ height of building. Then $h = 30 \tan \theta$, so $dh = 30 \sec^2 \theta d\theta$. We want $|dh| < 0.04h$, which gives: $|30 \sec^2 \theta d\theta| < 0.04|30 \tan \theta| \Rightarrow \frac{1}{\cos^2 \theta} |d\theta| < \frac{0.04 \sin \theta}{\cos \theta} \Rightarrow |d\theta| < 0.04 \sin \theta \cos \theta$
 $\Rightarrow |d\theta| < 0.04 \sin \frac{5\pi}{12} \cos \frac{5\pi}{12} = 0.01$ radian. The angle should be measured with an error of less than 0.01 radian (or approximately 0.57 degrees), which is a percentage error of approximately 0.76%.
55. The percentage error in the radius is $\frac{\left(\frac{dr}{dt}\right)}{r} \times 100 \leq 2\%$.
 (a) Since $C = 2\pi r \Rightarrow \frac{dC}{dt} = 2\pi \frac{dr}{dt}$. The percentage error in calculating the circle's circumference is $\frac{\left(\frac{dC}{dt}\right)}{C} \times 100$
 $= \frac{\left(2\pi \frac{dr}{dt}\right)}{2\pi r} \times 100 = \frac{\left(\frac{dr}{dt}\right)}{r} \times 100 \leq 2\%$.

(b) Since $A = \pi r^2 \Rightarrow \frac{dA}{dt} = 2\pi r \frac{dr}{dt}$. The percentage error in calculating the circle's area is given by $\frac{(\frac{dA}{dt})}{A} \times 100 = \frac{(2\pi r \frac{dr}{dt})}{\pi r^2} \times 100 = 2 \frac{(\frac{dr}{dt})}{r} \times 100 \leq 2(2\%) = 4\%$.

56. The percentage error in the edge of the cube is $\frac{(\frac{dx}{dt})}{x} \times 100 \leq 0.5\%$.

(a) Since $S = 6x^2 \Rightarrow \frac{dS}{dt} = 12x \frac{dx}{dt}$. The percentage error in the cube's surface area is $\frac{(\frac{dS}{dt})}{S} \times 100 = \frac{(12x \frac{dx}{dt})}{6x^2} \times 100 = 2 \frac{(\frac{dx}{dt})}{x} \times 100 \leq 2(0.5\%) = 1\%$

(b) Since $V = x^3 \Rightarrow \frac{dV}{dt} = 3x^2 \frac{dx}{dt}$. The percentage error in the cube's volume is $\frac{(\frac{dV}{dt})}{V} \times 100 = \frac{(3x^2 \frac{dx}{dt})}{x^3} \times 100 = 3 \frac{(\frac{dx}{dt})}{x} \times 100 \leq 3(0.5\%) = 1.5\%$

57. $V = \pi h^3 \Rightarrow dV = 3\pi h^2 dh$; recall that $\Delta V \approx dV$. Then $|\Delta V| \leq (1\%)(V) = \frac{(1)(\pi h^3)}{100} \Rightarrow |dV| \leq \frac{(1)(\pi h^3)}{100} \Rightarrow |3\pi h^2 dh| \leq \frac{(1)(\pi h^3)}{100} \Rightarrow |dh| \leq \frac{1}{300} h = \left(\frac{1}{3}\right)\% h$. Therefore the greatest tolerated error in the measurement of h is $\frac{1}{3}\%$.

58. (a) Let D_i represent the interior diameter. Then $V = \pi r^2 h = \pi \left(\frac{D_i}{2}\right)^2 h = \frac{\pi D_i^2 h}{4}$ and $h = 10 \Rightarrow V = \frac{5\pi D_i^2}{2} \Rightarrow dV = 5\pi D_i dD_i$. Recall that $\Delta V \approx dV$. We want $|\Delta V| \leq (1\%)(V) \Rightarrow |dV| \leq \left(\frac{1}{100}\right) \left(\frac{5\pi D_i^2}{2}\right) = \frac{\pi D_i^2}{40} \Rightarrow 5\pi D_i dD_i \leq \frac{\pi D_i^2}{40} \Rightarrow \frac{dD_i}{D_i} \leq \frac{1}{200}$. The inside diameter must be measured to within 0.5%.

(b) Let D_e represent the exterior diameter, h the height and S the area of the painted surface. $S = \pi D_e h \Rightarrow dS = \pi h dD_e \Rightarrow \frac{dS}{S} = \frac{dD_e}{D_e}$. Thus for small changes in exterior diameter, the approximate percentage change in the exterior diameter is equal to the approximate percentage change in the area painted, and to estimate the amount of paint required to within 5%, the tank's exterior diameter must be measured to within 5%.

59. Given $D = 100$ cm, $dD = 1$ cm, $V = \frac{4}{3}\pi \left(\frac{D}{2}\right)^3 = \frac{\pi D^3}{6} \Rightarrow dV = \frac{\pi}{2} D^2 dD = \frac{\pi}{2} (100)^2 (1) = \frac{10^4 \pi}{2}$. Then $\frac{dV}{V} (100\%) = \left[\frac{10^4 \pi}{2}\right] \left(\frac{10^2 \pi}{6}\right) = \left[\frac{10^6 \pi}{6}\right] \pi = 3\% \frac{10^4 \pi}{6}$

60. $V = \frac{4}{3}\pi r^3 = \frac{4}{3}\pi \left(\frac{D}{2}\right)^3 = \frac{\pi D^3}{6} \Rightarrow dV = \frac{\pi D^2}{2} dD$; recall that $\Delta V \approx dV$. Then $|\Delta V| \leq (3\%)V = \left(\frac{3}{100}\right) \left(\frac{\pi D^3}{6}\right) = \frac{\pi D^3}{200} \Rightarrow |dV| \leq \frac{\pi D^3}{200} \Rightarrow \left|\frac{\pi D^2}{2} dD\right| \leq \frac{\pi D^3}{200} \Rightarrow |dD| \leq \frac{D}{100} = (1\%)D \Rightarrow$ the allowable percentage error in measuring the diameter is 1%.

61. $W = a + \frac{b}{g} = a + bg^{-1} \Rightarrow dW = -bg^{-2} dg = -\frac{b dg}{g^2} \Rightarrow \frac{dW_{\text{moon}}}{dW_{\text{earth}}} = \frac{\left(-\frac{b dg}{(5.2)^2}\right)}{\left(-\frac{b dg}{(32)^2}\right)} = \left(\frac{32}{5.2}\right)^2 = 37.87$, so a change of gravity on the moon has about 38 times the effect that a change of the same magnitude has on Earth.

62. $C'(t) = \frac{4-8t^3}{(1+t^3)^2} + 0.06e^{-0.06t}$, where t is measured in hours. When the time changes from 20 min to 30 min, t in hours changes from $\frac{1}{3}$ to $\frac{1}{2}$, so the differential estimate for the change in C is $C'(\frac{1}{3}) \cdot (\frac{1}{2} - \frac{1}{3}) = \frac{1}{6} C'(\frac{1}{3}) \approx 0.584$ mg/mL.

63. The relative change in V is estimated by $\frac{dV/dr}{V} \Delta r = \frac{4kr^3}{kr^4} \Delta r = \frac{4\Delta r}{r}$. If the radius increases by 10%, r changes to $1.1r$ and $\Delta r = 0.1r$. The approximate relative increase in V is thus $\frac{4(0.1r)}{r} = 0.4$ or 40%.

64. (a) $T = 2\pi \left(\frac{L}{g}\right)^{1/2} \Rightarrow dT = 2\pi\sqrt{L} \left(-\frac{1}{2}g^{-3/2}\right) dg = -\pi\sqrt{L}g^{-3/2} dg$
 (b) If g increases, then $dg > 0 \Rightarrow dT < 0$. The period T decreases and the clock ticks more frequently. Both the pendulum speed and clock speed increase.
 (c) $0.001 = -\pi\sqrt{100}(980^{-3/2}) dg \Rightarrow dg \approx -0.977$ cm/sec² \Rightarrow the new $g \approx 979$ cm/sec²

65. (a) i. $Q(a) = f(a)$ implies that $b_0 = f(a)$.
 ii. Since $Q'(x) = b_1 + 2b_2(x-a)$, $Q'(a) = f'(a)$ implies that $b_1 = f'(a)$.
 iii. Since $Q''(x) = 2b_2$, $Q''(a) = f''(a)$ implies that $b_2 = \frac{f''(a)}{2}$.

In summary, $b_0 = f(a)$, $b_1 = f'(a)$, and $b_2 = \frac{f''(a)}{2}$.

(b) $f(x) = (1-x)^{-1}$; $f'(x) = -1(1-x)^{-2}(-1) = (1-x)^{-2}$; $f''(x) = -2(1-x)^{-3}(-1) = 2(1-x)^{-3}$ Since $f(0) = 1$, $f'(0) = 1$, and $f''(0) = 2$, the coefficients are $b_0 = 1$, $b_1 = 1$, $b_2 = \frac{2}{2} = 1$. The quadratic approximation is $Q(x) = 1 + x + x^2$.

(c) As one zooms in, the two graphs quickly become indistinguishable. They appear to be identical.

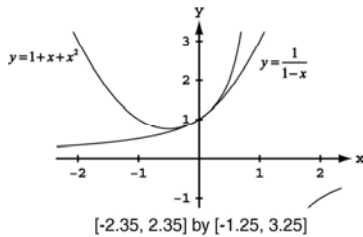

(d) $g(x) = x^{-1}$; $g'(x) = -1x^{-2}$; $g''(x) = 2x^{-3}$
 Since $g(1) = 1$, $g'(1) = -1$, and $g''(1) = 2$, the coefficients are $b_0 = 1$, $b_1 = -1$, $b_2 = \frac{2}{2} = 1$. The quadratic approximation is $Q(x) = 1 - (x-1) + (x-1)^2$.

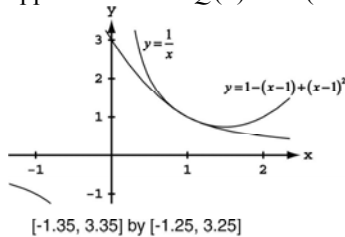

As one zooms in, the two graphs quickly become indistinguishable. They appear to be identical.

(e) $h(x) = (1+x)^{1/2}$; $h'(x) = \frac{1}{2}(1+x)^{-1/2}$; $h''(x) = -\frac{1}{4}(1+x)^{-3/2}$
 Since $h(0) = 1$, $h'(0) = \frac{1}{2}$, and $h''(0) = -\frac{1}{4}$, the coefficients are $b_0 = 1$, $b_1 = \frac{1}{2}$, $b_2 = \frac{-\frac{1}{4}}{2} = -\frac{1}{8}$. The quadratic approximation is $Q(x) = 1 + \frac{x}{2} - \frac{x^2}{8}$.

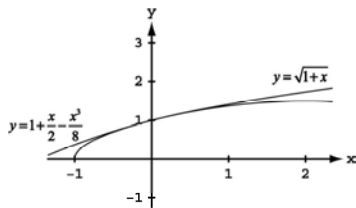

As one zooms in, the two graphs quickly become indistinguishable. They appear to be identical.

(f) The linearization of any differentiable function $u(x)$ at $x = a$ is $L(x) = u(a) + u'(a)(x - a) = b_0 + b_1(x - a)$, where b_0 and b_1 are the coefficients of the constant and linear terms of the quadratic approximation. Thus, the linearization for $f(x)$ at $x = 0$ is $1 + x$; the linearization for $g(x)$ at $x = 1$ is $1 - (x - 1)$ or $2 - x$; and the linearization for $h(x)$ at $x = 0$ is $1 + \frac{x}{2}$.

66. $E(x) = f(x) - g(x) \Rightarrow E(x) = f(x) - m(x - a) - c$. Then $E(a) = 0 \Rightarrow f(a) - m(a - a) - c = 0 \Rightarrow c = f(a)$. Next we calculate m : $\lim_{x \rightarrow a} \frac{E(x)}{x - a} = 0 \Rightarrow \lim_{x \rightarrow a} \frac{f(x) - m(x - a) - c}{x - a} = 0 \Rightarrow \lim_{x \rightarrow a} \left[\frac{f(x) - f(a)}{x - a} - m \right] = 0$ (since $c = f(a)$) $\Rightarrow f'(a) - m = 0 \Rightarrow m = f'(a)$. Therefore, $g(x) = m(x - a) + c = f'(a)(x - a) + f(a)$ is the linear approximation, as claimed.

67. (a) $f(x) = 2^x \Rightarrow f'(x) = 2^x \ln 2$; $L(x) = (2^0 \ln 2)x + 2^0 = x \ln 2 + 1 \approx 0.69x + 1$

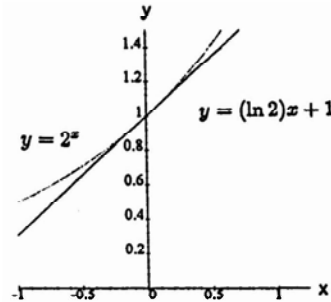
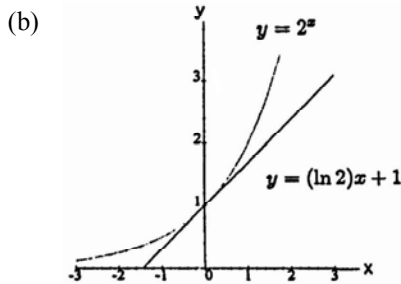

68. (a) $f(x) = \log_3 x \Rightarrow f'(x) = \frac{1}{x \ln 3}$, and $f(3) = \frac{\ln 3}{\ln 3} \Rightarrow L(x) = \frac{1}{3 \ln 3}(x - 3) + \frac{\ln 3}{\ln 3} = \frac{x}{3 \ln 3} - \frac{1}{\ln 3} + 1$

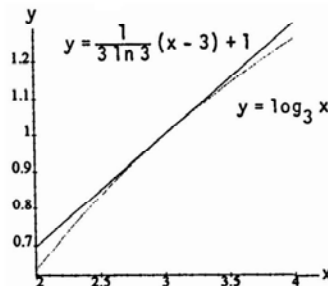
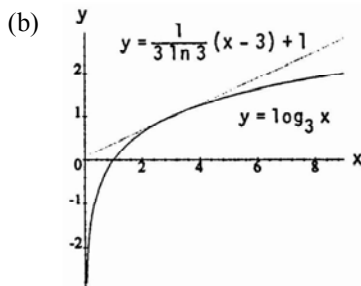

69–74. Example CAS commands:

Maple:

```
with(plots):
a := 1: f := x -> x^3 + x^2 - 2*x;
plot(f(x), x = -1..2);
diff(f(x), x);
fp := unapply ("", x);
L := x -> f(a) + fp(a)*(x - a);
plot({f(x), L(x)}, x = -1..2);
err := x -> abs(f(x) - L(x));
```

```
plot(err(x), x=-1..2, title = #absolute error function#);
err(-1);
```

Mathematica: (function, x1, x2, and a may vary):

```
Clear[f, x]
{x1, x2} = {-1, 2}; a = 1;
f[x_]:=x^3 + x^2 - 2x
Plot[f[x], {x, x1, x2}]
lin[x_]=f[a] + f'[a](x - a)
Plot[{f[x], lin[x]}, {x, x1, x2}]
err[x_]=Abs[f[x] - lin[x]]
Plot[err[x], {x, x1, x2}]
err/N
```

After reviewing the error function, plot the error function and epsilon for differing values of epsilon (eps) and delta (del)

```
eps = 0.5; del = 0.4
Plot[{err[x], eps}, {x, a - del, a + del}]
```

CHAPTER 3 PRACTICE EXERCISES

- $y = x^5 - 0.125x^2 + 0.25x \Rightarrow \frac{dy}{dx} = 5x^4 - 0.25x + 0.25$
- $y = 3 - 0.7x^3 + 0.3x^7 \Rightarrow \frac{dy}{dx} = -2.1x^2 + 2.1x^6$
- $y = x^3 - 3(x^2 + \pi^2) \Rightarrow \frac{dy}{dx} = 3x^2 - 3(2x + 0) = 3x^2 - 6x = 3x(x - 2)$
- $y = x^7 + \sqrt{7}x - \frac{1}{\pi+1} \Rightarrow \frac{dy}{dx} = 7x^6 + \sqrt{7}$
- $y = (x+1)^2(x^2+2x) \Rightarrow \frac{dy}{dx} = (x+1)^2(2x+2) + (x^2+2x)(2(x+1)) = 2(x+1)[(x+1)^2 + x(x+2)] = 2(x+1)(2x^2 + 4x + 1)$
- $y = (2x-5)(4-x)^{-1} \Rightarrow \frac{dy}{dx} = (2x-5)(-1)(4-x)^{-2}(-1) + (4-x)^{-1}(2) = (4-x)^{-2}[(2x-5) + 2(4-x)] = 3(4-x)^{-2}$
- $y = (\theta^2 + \sec \theta + 1)^3 \Rightarrow \frac{dy}{d\theta} = 3(\theta^2 + \sec \theta + 1)^2(2\theta + \sec \theta \tan \theta)$
- $y = \left(-1 - \frac{\csc \theta}{2} - \frac{\theta^2}{4}\right)^2 \Rightarrow \frac{dy}{d\theta} = 2\left(-1 - \frac{\csc \theta}{2} - \frac{\theta^2}{4}\right)\left(\frac{\csc \theta \cot \theta}{2} - \frac{\theta}{2}\right) = \left(-1 - \frac{\csc \theta}{2} - \frac{\theta^2}{4}\right)(\csc \theta \cot \theta - \theta)$
- $s = \frac{\sqrt{t}}{1+\sqrt{t}} \Rightarrow \frac{ds}{dt} = \frac{(1+\sqrt{t})\frac{1}{2\sqrt{t}} - \sqrt{t}\left(\frac{1}{2\sqrt{t}}\right)}{(1+\sqrt{t})^2} = \frac{(1+\sqrt{t}) - \sqrt{t}}{2\sqrt{t}(1+\sqrt{t})^2} = \frac{1}{2\sqrt{t}(1+\sqrt{t})^2}$
- $s = \frac{1}{\sqrt{t}-1} \Rightarrow \frac{ds}{dt} = \frac{(\sqrt{t}-1)(0) - 1\left(\frac{1}{2\sqrt{t}}\right)}{(\sqrt{t}-1)^2} = \frac{-1}{2\sqrt{t}(\sqrt{t}-1)^2}$
- $y = 2 \tan^2 x - \sec^2 x \Rightarrow \frac{dy}{dx} = (4 \tan x)(\sec^2 x) - (2 \sec x)(\sec x \tan x) = 2 \sec^2 x \tan x$

$$12. y = \frac{1}{\sin^2 x} - \frac{2}{\sin x} = \csc^2 x - 2 \csc x \Rightarrow \frac{dy}{dx} = (2 \csc x)(-\csc x \cot x) - 2(-\csc x \cot x) = (2 \csc x \cot x)(1 - \csc x)$$

$$13. s = \cos^4(1-2t) \Rightarrow \frac{ds}{dt} = 4 \cos^3(1-2t)(-\sin(1-2t))(-2) = 8 \cos^3(1-2t) \sin(1-2t)$$

$$14. s = \cot^3\left(\frac{2}{t}\right) \Rightarrow \frac{ds}{dt} = 3 \cot^2\left(\frac{2}{t}\right) \left(-\csc^2\left(\frac{2}{t}\right)\right) \left(\frac{-2}{t^2}\right) = \frac{6}{t^2} \cot^2\left(\frac{2}{t}\right) \csc^2\left(\frac{2}{t}\right)$$

$$15. s = (\sec t + \tan t)^5 \Rightarrow \frac{ds}{dt} = 5(\sec t + \tan t)^4 (\sec t \tan t + \sec^2 t) = 5(\sec t)(\sec t + \tan t)^5$$

$$16. s = \csc^5(1-t+3t^2) \Rightarrow \frac{ds}{dt} = 5 \csc^4(1-t+3t^2) (-\csc(1-t+3t^2) \cot(1-t+3t^2)) (-1+6t) \\ = -5(6t-1) \csc^5(1-t+3t^2) \cot(1-t+3t^2)$$

$$17. r = \sqrt{2\theta \sin \theta} = (2\theta \sin \theta)^{1/2} \Rightarrow \frac{dr}{d\theta} = \frac{1}{2}(2\theta \sin \theta)^{-1/2} (2\theta \cos \theta + 2 \sin \theta) = \frac{\theta \cos \theta + \sin \theta}{\sqrt{2\theta \sin \theta}}$$

$$18. r = 2\theta \sqrt{\cos \theta} = 2\theta (\cos \theta)^{1/2} \Rightarrow \frac{dr}{d\theta} = 2\theta \left(\frac{1}{2}\right) (\cos \theta)^{-1/2} (-\sin \theta) + 2(\cos \theta)^{1/2} = \frac{-\theta \sin \theta}{\sqrt{\cos \theta}} + 2\sqrt{\cos \theta} = \frac{2 \cos \theta - \theta \sin \theta}{\sqrt{\cos \theta}}$$

$$19. r = \sin \sqrt{2\theta} = \sin(2\theta)^{1/2} \Rightarrow \frac{dr}{d\theta} = \cos(2\theta)^{1/2} \left(\frac{1}{2}(2\theta)^{-1/2}(2)\right) = \frac{\cos \sqrt{2\theta}}{\sqrt{2\theta}}$$

$$20. r = \sin(\theta + \sqrt{\theta+1}) \Rightarrow \frac{dr}{d\theta} = \cos(\theta + \sqrt{\theta+1}) \left(1 + \frac{1}{2\sqrt{\theta+1}}\right) = \frac{2\sqrt{\theta+1} + 1}{2\sqrt{\theta+1}} \cos(\theta + \sqrt{\theta+1})$$

$$21. y = \frac{1}{2} x^2 \csc \frac{2}{x} \Rightarrow \frac{dy}{dx} = \frac{1}{2} x^2 \left(-\csc \frac{2}{x} \cot \frac{2}{x}\right) \left(\frac{-2}{x^2}\right) + \left(\csc \frac{2}{x}\right) \left(\frac{1}{2} \cdot 2x\right) = \csc \frac{2}{x} \cot \frac{2}{x} + x \csc \frac{2}{x}$$

$$22. y = 2\sqrt{x} \sin \sqrt{x} \Rightarrow \frac{dy}{dx} = 2\sqrt{x} \left(\cos \sqrt{x}\right) \left(\frac{1}{2\sqrt{x}}\right) + \left(\sin \sqrt{x}\right) \left(\frac{2}{2\sqrt{x}}\right) = \cos \sqrt{x} + \frac{\sin \sqrt{x}}{\sqrt{x}}$$

$$23. y = x^{-1/2} \sec(2x)^2 \Rightarrow \frac{dy}{dx} = x^{-1/2} \sec(2x)^2 \tan(2x)^2 (2(2x) \cdot 2) + \sec(2x)^2 \left(-\frac{1}{2} x^{-3/2}\right) \\ = 8x^{1/2} \sec(2x)^2 \tan(2x)^2 - \frac{1}{2} x^{-3/2} \sec(2x)^2 = \frac{1}{2} x^{1/2} \sec(2x)^2 \left[16 \tan(2x)^2 - x^{-2}\right] \\ \text{or } \frac{1}{2x^{3/2}} \sec(2x)^2 (16x^2 \tan(2x)^2 - 1)$$

$$24. y = \sqrt{x} \csc(x+1)^3 = x^{1/2} \csc(x+1)^3 \Rightarrow \frac{dy}{dx} = x^{1/2} (-\csc(x+1)^3 \cot(x+1)^3) (3(x+1)^2) + \csc(x+1)^3 \left(\frac{1}{2} x^{-1/2}\right) \\ = -3\sqrt{x}(x+1)^2 \csc(x+1)^3 \cot(x+1)^3 + \frac{\csc(x+1)^3}{2\sqrt{x}} = \frac{1}{2}\sqrt{x} \csc(x+1)^3 \left[\frac{1}{x} - 6(x+1)^2 \cot(x+1)^3\right] \text{ or } \frac{1}{2\sqrt{x}} \csc(x+1)^3 \\ \text{or } \frac{1}{2\sqrt{x}} \csc(x+1)^3 (1 - 6x(x+1)^2 \cot(x+1)^3)$$

$$25. y = 5 \cot x^2 \Rightarrow \frac{dy}{dx} = 5(-\csc^2 x^2)(2x) = -10x \csc^2(x^2)$$

$$26. y = x^2 \cot 5x \Rightarrow \frac{dy}{dx} = x^2 (-\csc^2 5x)(5) + (\cot 5x)(2x) = -5x^2 \csc^2 5x + 2x \cot 5x$$

$$27. y = x^2 \sin^2(2x^2) \Rightarrow \frac{dy}{dx} = x^2 (2 \sin(2x^2)) (\cos(2x^2)) (4x) + \sin^2(2x^2) (2x) \\ = 8x^3 \sin(2x^2) \cos(2x^2) + 2x \sin^2(2x^2)$$

$$28. y = x^{-2} \sin^2(x^3) \Rightarrow \frac{dy}{dx} = x^{-2} (2 \sin(x^3)) (\cos(x^3))(3x^2) + \sin^2(x^3)(-2x^{-3}) = 6 \sin(x^3) \cos(x^3) - 2x^{-3} \sin^2(x^3)$$

$$29. s = \left(\frac{4t}{t+1}\right)^{-2} \Rightarrow \frac{ds}{dt} = -2\left(\frac{4t}{t+1}\right)^{-3} \left(\frac{(t+1)(4) - (4t)(1)}{(t+1)^2}\right) = -2\left(\frac{4t}{t+1}\right)^{-3} \frac{4}{(t+1)^2} = -\frac{(t+1)}{8t^3}$$

$$30. s = \frac{-1}{15(15t-1)^3} = -\frac{1}{15}(15t-1)^{-3} \Rightarrow \frac{ds}{dt} = -\frac{1}{15}(-3)(15t-1)^{-4}(15) = \frac{3}{(15t-1)^4}$$

$$31. y = \left(\frac{\sqrt{x}}{x+1}\right)^2 \Rightarrow \frac{dy}{dx} = 2\left(\frac{\sqrt{x}}{x+1}\right) \cdot \frac{(x+1)\left(\frac{1}{2\sqrt{x}}\right) - (\sqrt{x})(1)}{(x+1)^2} = \frac{(x+1)-2x}{(x+1)^3} = \frac{1-x}{(x+1)^3}$$

$$32. y = \left(\frac{2\sqrt{x}}{2\sqrt{x}+1}\right)^2 \Rightarrow \frac{dy}{dx} = 2\left(\frac{2\sqrt{x}}{2\sqrt{x}+1}\right) \left(\frac{(2\sqrt{x}+1)\left(\frac{1}{\sqrt{x}}\right) - (2\sqrt{x})\left(\frac{1}{\sqrt{x}}\right)}{(2\sqrt{x}+1)^2}\right) = \frac{4\sqrt{x}\left(\frac{1}{\sqrt{x}}\right)}{(2\sqrt{x}+1)^3} = \frac{4}{(2\sqrt{x}+1)^3}$$

$$33. y = \sqrt{\frac{x^2+x}{x^2}} = \left(1 + \frac{1}{x}\right)^{1/2} \Rightarrow \frac{dy}{dx} = \frac{1}{2}\left(1 + \frac{1}{x}\right)^{-1/2} \left(-\frac{1}{x^2}\right) = -\frac{1}{2x^2\sqrt{1+\frac{1}{x}}}$$

$$34. y = 4x\sqrt{x+\sqrt{x}} = 4x(x+x^{1/2})^{1/2} \Rightarrow \frac{dy}{dx} = 4x\left(\frac{1}{2}\right)(x+x^{1/2})^{-1/2} \left(1 + \frac{1}{2}x^{-1/2}\right) + (x+x^{1/2})^{1/2}(4) \\ = (x+\sqrt{x})^{-1/2} \left[2x\left(1 + \frac{1}{2\sqrt{x}}\right) + 4(x+\sqrt{x})\right] = (x+\sqrt{x})^{-1/2} (2x+\sqrt{x}+4x+4\sqrt{x}) = \frac{6x+5\sqrt{x}}{\sqrt{x+\sqrt{x}}}$$

$$35. r = \left(\frac{\sin \theta}{\cos \theta - 1}\right)^2 \Rightarrow \frac{dr}{d\theta} = 2\left(\frac{\sin \theta}{\cos \theta - 1}\right) \left[\frac{(\cos \theta - 1)(\cos \theta) - (\sin \theta)(-\sin \theta)}{(\cos \theta - 1)^2}\right] = 2\left(\frac{\sin \theta}{\cos \theta - 1}\right) \left(\frac{\cos^2 \theta - \cos \theta + \sin^2 \theta}{(\cos \theta - 1)^2}\right) \\ = \frac{2(\sin \theta)(1 - \cos \theta)}{(\cos \theta - 1)^3} = \frac{-2 \sin \theta}{(\cos \theta - 1)^2}$$

$$36. r = \left(\frac{\sin \theta + 1}{1 - \cos \theta}\right)^2 \Rightarrow \frac{dr}{d\theta} = 2\left(\frac{\sin \theta + 1}{1 - \cos \theta}\right) \left[\frac{(1 - \cos \theta)(\cos \theta) - (\sin \theta + 1)(\sin \theta)}{(1 - \cos \theta)^2}\right] = \frac{2(\sin \theta + 1)}{(1 - \cos \theta)^3} (\cos \theta - \cos^2 \theta - \sin^2 \theta - \sin \theta) \\ = \frac{2(\sin \theta + 1)(\cos \theta - \sin \theta - 1)}{(1 - \cos \theta)^3}$$

$$37. y = (2x+1)\sqrt{2x+1} = (2x+1)^{3/2} \Rightarrow \frac{dy}{dx} = \frac{3}{2}(2x+1)^{1/2}(2) = 3\sqrt{2x+1}$$

$$38. y = 20(3x-4)^{1/4}(3x-4)^{-1/5} = 20(3x-4)^{1/20} \Rightarrow \frac{dy}{dx} = 20\left(\frac{1}{20}\right)(3x-4)^{-19/20}(3) = \frac{3}{(3x-4)^{19/20}}$$

$$39. y = 3(5x^2 + \sin 2x)^{-3/2} \Rightarrow \frac{dy}{dx} = 3\left(-\frac{3}{2}\right)(5x^2 + \sin 2x)^{-5/2} [10x + (\cos 2x)(2)] = \frac{-9(5x + \cos 2x)}{(5x^2 + \sin 2x)^{5/2}}$$

$$40. y = (3 + \cos^3 3x)^{-1/3} \Rightarrow \frac{dy}{dx} = -\frac{1}{3}(3 + \cos^3 3x)^{-4/3} (3 \cos^2 3x)(-\sin 3x)(3) = \frac{3 \cos^2 3x \sin 3x}{(3 + \cos^3 3x)^{4/3}}$$

$$41. y = 10e^{-x/5} \Rightarrow \frac{dy}{dx} = (10)\left(-\frac{1}{5}\right)e^{-x/5} = -2e^{-x/5}$$

$$42. y = \sqrt{2}e^{\sqrt{2}x} \Rightarrow \frac{dy}{dx} = (\sqrt{2})(\sqrt{2})e^{\sqrt{2}x} = 2e^{\sqrt{2}x}$$

$$43. y = \frac{1}{4}xe^{4x} - \frac{1}{16}e^{4x} \Rightarrow \frac{dy}{dx} = \frac{1}{4}[x(4e^{4x}) + e^{4x}(1)] - \frac{1}{16}(4e^{4x}) = xe^{4x} + \frac{1}{4}e^{4x} - \frac{1}{4}e^{4x} = xe^{4x}$$

$$44. y = x^2e^{-2/x} = x^2e^{-2x^{-1}} \Rightarrow \frac{dy}{dx} = x^2[(2x^{-2})e^{-2x^{-1}}] + e^{-2x^{-1}}(2x) = (2+2x)e^{-2x^{-1}} = 23^{-2/x}(1+x)$$

$$45. y = \ln(\sin^2 \theta) \Rightarrow \frac{dy}{d\theta} = \frac{2(\sin \theta)(\cos \theta)}{\sin^2 \theta} = \frac{2\cos \theta}{\sin \theta} = 2 \cot \theta$$

$$46. y = \ln(\sec^2 \theta) \Rightarrow \frac{dy}{d\theta} = \frac{2(\sec \theta)(\sec \theta \tan \theta)}{\sec^2 \theta} = 2 \tan \theta$$

$$47. y = \log_2\left(\frac{x^2}{2}\right) = \frac{\ln\left(\frac{x^2}{2}\right)}{\ln 2} \Rightarrow \frac{dy}{dx} = \frac{1}{\ln 2} \left(\frac{x}{\left(\frac{x^2}{2}\right)} \right) = \frac{2}{(\ln 2)x}$$

$$48. y = \log_5(3x-7) = \frac{\ln(3x-7)}{\ln 5} \Rightarrow \frac{dy}{dx} = \left(\frac{1}{\ln 5}\right)\left(\frac{3}{3x-7}\right) = \frac{3}{(\ln 5)(3x-7)}$$

$$49. y = 8^{-t} \Rightarrow \frac{dy}{dt} = 8^{-t}(\ln 8)(-1) = -8^{-t}(\ln 8) \quad 50. y = 9^{2t} \Rightarrow \frac{dy}{dt} = 9^{2t}(\ln 9)(2) = 9^{2t}(2 \ln 9)$$

$$51. y = 5x^{3.6} \Rightarrow \frac{dy}{dx} = 5(3.6)x^{2.6} = 18x^{2.6}$$

$$52. y = \sqrt{2}x^{-\sqrt{2}} \Rightarrow \frac{dy}{dx} = (\sqrt{2})(-\sqrt{2})x^{(-\sqrt{2}-1)} = -2x^{(-\sqrt{2}-1)}$$

$$53. y = (x+2)^{x+2} \Rightarrow \ln y = \ln(x+2)^{x+2} = (x+2)\ln(x+2) \Rightarrow \frac{y'}{y} = (x+2)\left(\frac{1}{x+2}\right) + (1)\ln(x+2) \\ \Rightarrow \frac{dy}{dx} = (x+2)^{x+2}[\ln(x+2) + 1]$$

$$54. y = 2(\ln x)^{x/2} \Rightarrow \ln y = \ln[2(\ln x)^{x/2}] = \ln(2) + \left(\frac{x}{2}\right)\ln(\ln x) \Rightarrow \frac{y'}{y} = 0 + \left(\frac{x}{2}\right)\left[\frac{\left(\frac{1}{x}\right)}{\ln x}\right] + (\ln(\ln x))\left(\frac{1}{2}\right) \\ \Rightarrow y' = \left[\frac{1}{2\ln x} + \left(\frac{1}{2}\right)\ln(\ln x)\right]2(\ln x)^{x/2} = (\ln x)^{x/2}\left[\ln(\ln x) + \frac{1}{\ln x}\right]$$

$$55. y = \sin^{-1}\sqrt{1-u^2} = \sin^{-1}(1-u^2)^{1/2} \\ \Rightarrow \frac{dy}{du} = \frac{\frac{1}{2}(1-u^2)^{-1/2}(-2u)}{\sqrt{1-[(1-u^2)^{-1/2}]^2}} = \frac{-u}{\sqrt{1-u^2}\sqrt{1-(1-u^2)}} = \frac{-u}{|u|\sqrt{1-u^2}} = \frac{-u}{u\sqrt{1-u^2}} = \frac{-1}{\sqrt{1-u^2}}, \quad 0 < u < 1$$

$$56. y = \sin^{-1}\left(\frac{1}{\sqrt{v}}\right) = \sin^{-1}v^{-1/2} \Rightarrow \frac{dy}{dv} = \frac{-\frac{1}{2}v^{-3/2}}{\sqrt{1-(v^{-1/2})^2}} = \frac{-1}{2v^{3/2}\sqrt{1-v^{-1}}} = \frac{-1}{2v^{3/2}\sqrt{\frac{v-1}{v}}} = \frac{-\sqrt{v}}{2v^{3/2}\sqrt{v+1}} = \frac{-1}{2\sqrt{-1}}$$

$$57. y = \ln(\cos^{-1}x) \Rightarrow y' = \frac{\left(\frac{-1}{\sqrt{1-x^2}}\right)}{\cos^{-1}x} = \frac{-1}{\sqrt{1-x^2}\cos^{-1}x}$$

58. $y = z \cos^{-1} z - \sqrt{1-z^2} = z \cos^{-1} z - (1-z^2)^{1/2}$
 $\Rightarrow \frac{dy}{dz} = \cos^{-1} z - \frac{z}{\sqrt{1-z^2}} - \left(\frac{1}{2}\right)(1-z^2)^{-1/2}(-2z) = \cos^{-1} z - \frac{z}{\sqrt{1-z^2}} + \frac{z}{\sqrt{1-z^2}} = \cos^{-1} z$
59. $y = t \tan^{-1} t - \left(\frac{1}{2}\right) \ln t \Rightarrow \frac{dy}{dt} = \tan^{-1} t + t \left(\frac{1}{1+t^2}\right) - \left(\frac{1}{2}\right)\left(\frac{1}{t}\right) = \tan^{-1} t + \frac{t}{1+t^2} - \frac{1}{2t}$
60. $y = (1+t^2) \cot^{-1} 2t \Rightarrow \frac{dy}{dt} = 2t \cot^{-1} 2t + (1+t^2) \left(\frac{-2}{1+4t^2}\right)$
61. $y = z \sec^{-1} z - \sqrt{z^2-1} = z \sec^{-1} z - (z^2-1)^{1/2}$
 $\Rightarrow \frac{dy}{dz} = z \left(\frac{1}{|z|\sqrt{z^2-1}}\right) + (\sec^{-1} z)(1) - \frac{1}{2}(z^2-1)^{-1/2}(2z) = \frac{z}{|z|\sqrt{z^2-1}} - \frac{z}{\sqrt{z^2-1}} + \sec^{-1} z = \frac{1-z}{\sqrt{z^2-1}} + \sec^{-1} z, z > 1$
62. $y = 2\sqrt{x-1} \sec^{-1} \sqrt{x} = 2(x-1)^{1/2} \sec^{-1}(x^{1/2})$
 $\Rightarrow \frac{dy}{dx} = 2 \left[\left(\frac{1}{2}\right)(x-1)^{-1/2} \sec^{-1}(x^{1/2}) + (x-1)^{1/2} \left(\frac{\left(\frac{1}{2}\right)x^{-1/2}}{\sqrt{x}\sqrt{x-1}}\right) \right] = 2 \left(\frac{\sec^{-1} \sqrt{x}}{2\sqrt{x-1}} + \frac{1}{2} \right) = \frac{\sec^{-1} \sqrt{x}}{\sqrt{x-1}} + 1$
63. $y = \csc^{-1}(\sec \theta) \Rightarrow \frac{dy}{d\theta} = \frac{-\sec \theta \tan \theta}{|\sec \theta| \sqrt{\sec^2 \theta - 1}} = -\frac{\tan \theta}{|\tan \theta|} = -1, 0 < \theta < \frac{\pi}{2}$
64. $y = (1+x^2)e^{\tan^{-1} x} \Rightarrow y' = 2xe^{\tan^{-1} x} + (1+x^2) \left(\frac{e^{\tan^{-1} x}}{1+x^2}\right) = 2xe^{\tan^{-1} x} + e^{\tan^{-1} x}$
65. $xy + 2x + 3y = 1 \Rightarrow (xy' + y) + 2 + 3y' = 0 \Rightarrow xy' + 3y' = -2 - y \Rightarrow y'(x+3) = -2 - y \Rightarrow y' = -\frac{y+2}{x+3}$
66. $x^2 + xy + y^2 - 5x = 2 \Rightarrow 2x + \left(x \frac{dy}{dx} + y\right) + 2y \frac{dy}{dx} - 5 = 0 \Rightarrow x \frac{dy}{dx} + 2y \frac{dy}{dx} = 5 - 2x - y \Rightarrow \frac{dy}{dx}(x+2y) = 5 - 2x - y$
 $\Rightarrow \frac{dy}{dx} = \frac{5-2x-y}{x+2y}$
67. $x^3 + 4xy - 3y^{4/3} = 2x \Rightarrow 3x^2 + \left(4x \frac{dy}{dx} + 4y\right) - 4y^{1/3} \frac{dy}{dx} = 2 \Rightarrow 4x \frac{dy}{dx} - 4y^{1/3} \frac{dy}{dx} = 2 - 3x^2 - 4y$
 $\Rightarrow \frac{dy}{dx}(4x - 4y^{1/3}) = 2 - 3x^2 - 4y \Rightarrow \frac{dy}{dx} = \frac{2-3x^2-4y}{4x-4y^{1/3}}$
68. $5x^{4/5} + 10y^{6/5} = 15 \Rightarrow 4x^{-1/5} + 12y^{1/5} \frac{dy}{dx} = 0 \Rightarrow 12y^{1/5} \frac{dy}{dx} = -4x^{-1/5} \Rightarrow \frac{dy}{dx} = -\frac{1}{3}x^{-1/5}y^{-1/5} = -\frac{1}{3(xy)^{1/5}}$
69. $(xy)^{1/2} = 1 \Rightarrow \frac{1}{2}(xy)^{-1/2} \left(x \frac{dy}{dx} + y\right) = 0 \Rightarrow x^{1/2}y^{-1/2} \frac{dy}{dx} = -x^{-1/2}y^{1/2} \Rightarrow \frac{dy}{dx} = -x^{-1}y \Rightarrow \frac{dy}{dx} = -\frac{y}{x}$
70. $x^2y^2 = 1 \Rightarrow x^2 \left(2y \frac{dy}{dx}\right) + y^2(2x) = 0 \Rightarrow 2x^2y \frac{dy}{dx} = -2xy^2 \Rightarrow \frac{dy}{dx} = -\frac{y}{x}$
71. $y^2 = \frac{x}{x+1} \Rightarrow 2y \frac{dy}{dx} = \frac{(x+1)(1)-(x)(1)}{(x+1)^2} \Rightarrow \frac{dy}{dx} = \frac{1}{2y(x+1)^2}$

$$72. y^2 = \left(\frac{1+x}{1-x}\right)^{1/2} \Rightarrow y^4 = \frac{1+x}{1-x} \Rightarrow 4y^3 \frac{dy}{dx} = \frac{(1-x)(1)-(1+x)(-1)}{(1-x)^2} \Rightarrow \frac{dy}{dx} = \frac{1}{2y^3(1-x)^2}$$

$$73. e^{x+2y} = 1 \Rightarrow e^{x+2y} \left(1 + 2\frac{dy}{dx}\right) = 0 \Rightarrow \frac{dy}{dx} = -\frac{1}{2}$$

$$74. y^2 = 2e^{-1/x} \Rightarrow 2y \frac{dy}{dx} = 2e^{-1/x} \frac{d}{dx}(-x^{-1}) = \frac{2e^{-1/x}}{x^2} \Rightarrow \frac{dy}{dx} = \frac{e^{-1/x}}{yx^2}$$

$$75. \ln\left(\frac{x}{y}\right) = 1 \Rightarrow \frac{1}{x/y} \frac{d}{dx}\left(\frac{x}{y}\right) = 0 \Rightarrow \frac{y(1-x)\frac{dy}{dx}}{y^2} = 0 \Rightarrow \frac{dy}{dx} = \frac{y}{x}$$

$$76. x \sin^{-1} y = 1 + x^2 \Rightarrow y = \sin(x^{-1} + x) \\ \Rightarrow \frac{dy}{dx} = \cos(x^{-1} + x) \frac{d}{dx}(x^{-1} + x) = (1 - x^{-2}) \cos(x^{-1} + x) = \left(\frac{x^2-1}{x}\right) \cos\left(\frac{x^2+1}{x}\right)$$

$$77. ye^{\tan^{-1} x} = 2 \Rightarrow y = 2e^{-\tan^{-1} x} \Rightarrow \frac{dy}{dx} = 2e^{-\tan^{-1} x} \frac{d}{dx}(-\tan^{-1} x) = -2e^{-\tan^{-1} x} \left(\frac{1}{1+x^2}\right) = -\frac{2e^{-\tan^{-1} x}}{1+x^2}$$

$$78. x^y = \sqrt{2} \Rightarrow \ln(x^y) = \ln(2^{1/2}) \Rightarrow y \ln x = \frac{\ln 2}{2} \Rightarrow \frac{d}{dx}(y \ln x) = 0 \Rightarrow y\left(\frac{1}{x}\right) + \ln x \frac{dy}{dx} = 0 \Rightarrow \frac{dy}{dx} = -\frac{y}{x \ln x}$$

$$79. p^3 + 4pq - 3q^2 = 2 \Rightarrow 3p^2 \frac{dp}{dq} + 4\left(p + q \frac{dp}{dq}\right) - 6q = 0 \Rightarrow 3p^2 \frac{dp}{dq} + 4q \frac{dp}{dq} = 6q - 4p \Rightarrow \frac{dp}{dq}(3p^2 + 4q) = 6q - 4p \\ \Rightarrow \frac{dp}{dq} = \frac{6q-4p}{3p^2+4q}$$

$$80. q = (5p^2 + 2p)^{-3/2} \Rightarrow 1 = -\frac{3}{2}(5p^2 + 2p)^{-5/2} \left(10p \frac{dp}{dq} + 2 \frac{dp}{dq}\right) \Rightarrow -\frac{2}{3}(5p^2 + 2p)^{5/2} = \frac{dp}{dq}(10p + 2) \\ \Rightarrow \frac{dp}{dq} = -\frac{(5p^2 + 2p)^{5/2}}{3(5p + 1)}$$

$$81. r \cos 2s + \sin^2 s = \pi \Rightarrow r(-\sin 2s)(2) + (\cos 2s) \left(\frac{dr}{ds}\right) + 2 \sin s \cos s = 0 \Rightarrow \frac{dr}{ds}(\cos 2s) = 2r \sin 2s - 2 \sin s \cos s \\ \Rightarrow \frac{dr}{ds} = \frac{2r \sin 2s - \sin 2s}{\cos 2s} = \frac{(2r-1)(\sin 2s)}{\cos 2s} = (2r-1)(\tan 2s)$$

$$82. 2rs - r - s + s^2 = -3 \Rightarrow 2\left(r + s \frac{dr}{ds}\right) - \frac{dr}{ds} - 1 + 2s = 0 \Rightarrow \frac{dr}{ds}(2s-1) = 1-2s-2r \Rightarrow \frac{dr}{ds} = \frac{1-2s-2r}{2s-1}$$

$$83. (a) x^3 + y^3 = 1 \Rightarrow 3x^2 + 3y^2 \frac{dy}{dx} = 0 \Rightarrow \frac{dy}{dx} = -\frac{x^2}{y^2} \Rightarrow \frac{d^2y}{dx^2} = \frac{y^2(-2x) - (-x^2)\left(2y\frac{dy}{dx}\right)}{y^4}$$

$$\Rightarrow \frac{d^2y}{dx^2} = \frac{-2xy^2 + (2yx^2)\left(-\frac{x^2}{y^2}\right)}{y^4} = \frac{-2xy^2 - \frac{2x^4}{y}}{y^4} = \frac{-2xy^3 - 2x^4}{y^5}$$

$$(b) y^2 = 1 - \frac{2}{x} \Rightarrow 2y \frac{dy}{dx} = \frac{2}{x^2} \Rightarrow \frac{dy}{dx} = \frac{1}{yx^2} \Rightarrow \frac{dy}{dx} = (yx^2)^{-1} \Rightarrow \frac{d^2y}{dx^2} = -(yx^2)^{-2} \left[y(2x) + x^2 \frac{dy}{dx} \right]$$

$$\Rightarrow \frac{d^2y}{dx^2} = \frac{-2xy - x^2\left(\frac{1}{yx^2}\right)}{y^2x^4} = \frac{-2xy^2 - 1}{y^3x^4}$$

84. (a) $x^2 - y^2 = 1 \Rightarrow 2x - 2y \frac{dy}{dx} = 0 \Rightarrow -2y \frac{dy}{dx} = -2x \Rightarrow \frac{dy}{dx} = \frac{x}{y}$
 (b) $\frac{dy}{dx} = \frac{x}{y} \Rightarrow \frac{d^2y}{dx^2} = \frac{y(1) - x \frac{dy}{dx}}{y^2} = \frac{y - x(\frac{x}{y})}{y^2} = \frac{y^2 - x^2}{y^3} = \frac{-1}{y^3}$ (since $y^2 - x^2 = -1$)
85. (a) Let $h(x) = 6f(x) - g(x) \Rightarrow h'(x) = 6f'(x) - g'(x) \Rightarrow h'(1) = 6f'(1) - g'(1) = 6(\frac{1}{2}) - (-4) = 7$
 (b) Let $h(x) = f(x)g^2(x) \Rightarrow h'(x) = f(x)(2g(x))g'(x) + g^2(x)f'(x) \Rightarrow h'(0) = 2f(0)g(0)g'(0) + g^2(0)f'(0) = 2(1)(1)(\frac{1}{2}) + (1)^2(-3) = -2$
 (c) Let $h(x) = \frac{f(x)}{g(x)+1} \Rightarrow h'(x) = \frac{(g(x)+1)f'(x) - f(x)g'(x)}{(g(x)+1)^2} \Rightarrow h'(1) = \frac{(g(1)+1)f'(1) - f(1)g'(1)}{(g(1)+1)^2} = \frac{(5+1)(\frac{1}{2}) - 3(-4)}{(5+1)^2} = \frac{5}{12}$
 (d) Let $h(x) = f(g(x)) \Rightarrow h'(x) = f'(g(x))g'(x) \Rightarrow h'(0) = f'(g(0))g'(0) = f'(1)(\frac{1}{2}) = (\frac{1}{2})(\frac{1}{2}) = \frac{1}{4}$
 (e) Let $h(x) = g(f(x)) \Rightarrow h'(x) = g'(f(x))f'(x) \Rightarrow h'(0) = g'(f(0))f'(0) = g'(1)f'(0) = (-4)(-3) = 12$
 (f) Let $h(x) = (x + f(x))^{3/2} \Rightarrow h'(x) = \frac{3}{2}(x + f(x))^{1/2}(1 + f'(x)) \Rightarrow h'(1) = \frac{3}{2}(1 + f(1))^{1/2}(1 + f'(1)) = \frac{3}{2}(1+3)^{1/2}(1 + \frac{1}{2}) = \frac{9}{2}$
 (g) Let $h(x) = f(x + g(x)) \Rightarrow h'(x) = f'(x + g(x))(1 + g'(x)) \Rightarrow h'(0) = f'(g(0))(1 + g'(0)) = f'(1)(1 + \frac{1}{2}) = (\frac{1}{2})(\frac{3}{2}) = \frac{3}{4}$
86. (a) Let $h(x) = \sqrt{x}f(x) \Rightarrow h'(x) = \sqrt{x}f'(x) + f(x) \cdot \frac{1}{2\sqrt{x}} \Rightarrow h'(1) = \sqrt{1}f'(1) + f(1) \cdot \frac{1}{2\sqrt{1}} = \frac{1}{5} + (-3)(\frac{1}{2}) = -\frac{13}{10}$
 (b) Let $h(x) = (f(x))^{1/2} \Rightarrow h'(x) = \frac{1}{2}(f(x))^{-1/2}f'(x) \Rightarrow h'(0) = \frac{1}{2}(f(0))^{-1/2}f'(0) = \frac{1}{2}(9)^{-1/2}(-2) = -\frac{1}{3}$
 (c) Let $h(x) = f(\sqrt{x}) \Rightarrow h'(x) = f'(\sqrt{x}) \cdot \frac{1}{2\sqrt{x}} \Rightarrow h'(1) = f'(\sqrt{1}) \cdot \frac{1}{2\sqrt{1}} = \frac{1}{5} \cdot \frac{1}{2} = \frac{1}{10}$
 (d) Let $h(x) = f(1 - 5 \tan x) \Rightarrow h'(x) = f'(1 - 5 \tan x)(-5 \sec^2 x) \Rightarrow h'(0) = f'(1 - 5 \tan 0)(-5 \sec^2 0) = f'(1)(-5) = \frac{1}{5}(-5) = -1$
 (e) Let $h(x) = \frac{f(x)}{2 + \cos x} \Rightarrow h'(x) = \frac{(2 + \cos x)f'(x) - f(x)(-\sin x)}{(2 + \cos x)^2} \Rightarrow h'(0) = \frac{(2+1)f'(0) - f(0)(0)}{(2+1)^2} = \frac{3(-2)}{9} = -\frac{2}{3}$
 (f) Let $h(x) = 10 \sin(\frac{\pi x}{2})f^2(x) \Rightarrow h'(x) = 10 \sin(\frac{\pi x}{2})(2f(x)f'(x)) + f^2(x)(10 \cos(\frac{\pi x}{2}))(\frac{\pi}{2}) \Rightarrow h'(1) = 10 \sin(\frac{\pi}{2})(2f(1)f'(1)) + f^2(1)(10 \cos(\frac{\pi}{2}))(\frac{\pi}{2}) = 20(-3)(\frac{1}{5}) + 0 = -12$
87. $x = t^2 + \pi \Rightarrow \frac{dx}{dt} = 2t$; $y = 3 \sin 2x \Rightarrow \frac{dy}{dx} = 3(\cos 2x)(2) = 6 \cos 2x = 6 \cos(2t^2 + 2\pi) = 6 \cos(2t^2)$;
 thus, $\frac{dy}{dx} = \frac{dy}{dx} \cdot \frac{dx}{dt} = 6 \cos(2t^2) \cdot 2t \Rightarrow \frac{dy}{dt} \Big|_{t=0} = 6 \cos(0) \cdot 0 = 0$
88. $t = (u^2 + 2u)^{1/3} \Rightarrow \frac{dt}{du} = \frac{1}{3}(u^2 + 2u)^{-2/3}(2u + 2) = \frac{2}{3}(u^2 + 2u)^{-2/3}(u + 1)$; $s = t^2 + 5t \Rightarrow \frac{ds}{dt} = 2t + 5 = 2(u^2 + 2u)^{1/3} + 5$; thus $\frac{ds}{du} = \frac{ds}{dt} \cdot \frac{dt}{du} = [2(u^2 + 2u)^{1/3} + 5](\frac{2}{3})(u^2 + 2u)^{-2/3}(u + 1) \Rightarrow \frac{ds}{du} \Big|_{u=2} = [2(2^2 + 2(2))^{1/3} + 5](\frac{2}{3})(2^2 + 2(2))^{-2/3}(2 + 1) = 2(2 \cdot 8^{1/3} + 5)(8^{-2/3}) = 2(2 \cdot 2 + 5)(\frac{1}{4}) = \frac{9}{2}$
89. $\frac{dw}{ds} = \frac{dw}{dr} \cdot \frac{dr}{ds} = \left[\cos(e^{\sqrt{r}}) \left(e^{\sqrt{r}} \cdot \frac{1}{2\sqrt{r}} \right) \right] \left[3 \cos\left(s + \frac{\pi}{6}\right) \right]$; at $x = 0$, $r = 3 \sin \frac{\pi}{6} = \frac{3}{2}$
 $\Rightarrow \frac{dw}{ds} = \cos\left(e^{\sqrt{3/2}}\right) \left(e^{\sqrt{3/2}} \cdot \frac{1}{2\sqrt{3/2}} \right) \left(3 \cos \frac{\pi}{6} \right) = \frac{3\sqrt{3}e^{\sqrt{3/2}}}{4\sqrt{3/2}} \cos\left(e^{\sqrt{3/2}}\right) = \frac{3\sqrt{2}e^{\sqrt{3/2}}}{4} \cos\left(e^{\sqrt{3/2}}\right)$

$$90. \theta^2 t + \theta = 1 \Rightarrow (\theta^2 + t(2\theta \frac{d\theta}{dt})) + \frac{d\theta}{dt} = 0 \Rightarrow \frac{d\theta}{dt}(2\theta t + 1) = -\theta^2 \Rightarrow \frac{d\theta}{dt} = \frac{-\theta^2}{2\theta t + 1}; r = (\theta^2 + 7)^{1/3}$$

$$\Rightarrow \frac{dr}{d\theta} = \frac{1}{3}(\theta^2 + 7)^{-2/3}(2\theta) = \frac{2}{3}\theta(\theta^2 + 7)^{-2/3}; \text{ now } t = 0 \text{ and } \theta^2 t + \theta = 1 \Rightarrow \theta = 1 \text{ so that } \left. \frac{d\theta}{dt} \right|_{t=0, \theta=1} = \frac{-1}{1} = -1$$

$$\text{and } \left. \frac{dr}{d\theta} \right|_{\theta=1} = \frac{2}{3}(1+7)^{-2/3} = \frac{1}{6} \Rightarrow \left. \frac{dr}{dt} \right|_{t=0} = \left. \frac{dr}{d\theta} \right|_{\theta=1} \cdot \left. \frac{d\theta}{dt} \right|_{t=0} = \left(\frac{1}{6}\right)(-1) = -\frac{1}{6}$$

$$91. y^3 + y = 2 \cos x \Rightarrow 3y^2 \frac{dy}{dx} + \frac{dy}{dx} = -2 \sin x \Rightarrow \frac{dy}{dx}(3y^2 + 1) = -2 \sin x \Rightarrow \frac{dy}{dx} = \frac{-2 \sin x}{3y^2 + 1} \Rightarrow \left. \frac{dy}{dx} \right|_{(0,1)} = \frac{-2 \sin(0)}{3+1} = 0;$$

$$\frac{d^2 y}{dx^2} = \frac{(3y^2 + 1)(-2 \cos x) - (-2 \sin x)(6y \frac{dy}{dx})}{(3y^2 + 1)^2} \Rightarrow \left. \frac{d^2 y}{dx^2} \right|_{(0,1)} = \frac{(3+1)(-2 \cos 0) - (-2 \sin 0)(6 \cdot 0)}{(3+1)^2} = -\frac{1}{2}$$

$$92. x^{1/3} + y^{1/3} = 4 \Rightarrow \frac{1}{3}x^{-2/3} + \frac{1}{3}y^{-2/3} \frac{dy}{dx} = 0 \Rightarrow \frac{dy}{dx} = -\frac{y^{2/3}}{x^{2/3}} \Rightarrow \left. \frac{dy}{dx} \right|_{(8,8)} = -1; \frac{dy}{dx} = \frac{-y^{2/3}}{x^{2/3}}$$

$$\Rightarrow \left. \frac{d^2 y}{dx^2} \right|_{(8,8)} = \frac{(x^{2/3})\left(-\frac{2}{3}y^{-1/3} \frac{dy}{dx}\right) - (-y^{2/3})\left(\frac{2}{3}x^{-1/3}\right)}{(x^{2/3})^2} \Rightarrow \left. \frac{d^2 y}{dx^2} \right|_{(8,8)} = \frac{(8^{2/3})\left[-\frac{2}{3} \cdot 8^{-1/3} \cdot (-1)\right] + (8^{2/3})\left(\frac{2}{3} \cdot 8^{-1/3}\right)}{8^{4/3}} = \frac{\frac{1}{3} + \frac{1}{3}}{\frac{2}{3}} = \frac{\frac{2}{3}}{\frac{2}{3}} = 1$$

$$93. f(t) = \frac{1}{2t+1} \text{ and } f(t+h) = \frac{1}{2(t+h)+1} \Rightarrow \frac{f(t+h)-f(t)}{h} = \frac{\frac{1}{2(t+h)+1} - \frac{1}{2t+1}}{h} = \frac{2t+1 - (2t+2h+1)}{(2t+2h+1)(2t+1)h} = \frac{-2h}{(2t+2h+1)(2t+1)h}$$

$$= \frac{-2}{(2t+2h+1)(2t+1)} \Rightarrow f'(t) = \lim_{h \rightarrow 0} \frac{f(t+h)-f(t)}{h} = \lim_{h \rightarrow 0} \frac{-2}{(2t+2h+1)(2t+1)} = \frac{-2}{(2t+1)^2}$$

$$94. g(x) = 2x^2 + 1 \text{ and } g(x+h) = 2(x+h)^2 + 1 = 2x^2 + 4xh + 2h^2 + 1 \Rightarrow \frac{g(x+h)-g(x)}{h} = \frac{(2x^2 + 4xh + 2h^2 + 1) - (2x^2 + 1)}{h}$$

$$= \frac{4xh + 2h^2}{h} = 4x + 2h \Rightarrow g'(x) = \lim_{h \rightarrow 0} \frac{g(x+h)-g(x)}{h} = \lim_{h \rightarrow 0} (4x + 2h) = 4x$$

95. (a)

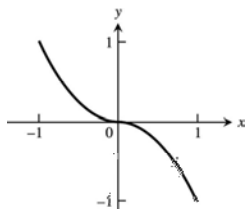

$$f(x) = \begin{cases} x^2, & -1 \leq x < 0 \\ -x^2, & 0 \leq x \leq 1 \end{cases}$$

(b) $\lim_{x \rightarrow 0^-} f(x) = \lim_{x \rightarrow 0^-} x^2 = 0$ and $\lim_{x \rightarrow 0^+} f(x) = \lim_{x \rightarrow 0^+} -x^2 = 0 \Rightarrow \lim_{x \rightarrow 0} f(x) = 0$. Since $\lim_{x \rightarrow 0} f(x) = 0 = f(0)$ it follows that f is continuous at $x = 0$.

(c) $\lim_{x \rightarrow 0^-} f'(x) = \lim_{x \rightarrow 0^-} (2x) = 0$ and $\lim_{x \rightarrow 0^+} f'(x) = \lim_{x \rightarrow 0^+} (-2x) = 0 \Rightarrow \lim_{x \rightarrow 0} f'(x) = 0$. Since this limit exists, it follows that f is differentiable at $x = 0$.

96. (a)

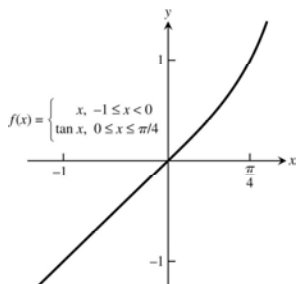

$$f(x) = \begin{cases} x, & -1 \leq x < 0 \\ \tan x, & 0 \leq x \leq \pi/4 \end{cases}$$

- (b) $\lim_{x \rightarrow 0^-} f(x) = \lim_{x \rightarrow 0^-} x = 0$ and $\lim_{x \rightarrow 0^+} f(x) = \lim_{x \rightarrow 0^+} \tan x = 0 \Rightarrow \lim_{x \rightarrow 0} f(x) = 0$. Since $\lim_{x \rightarrow 0} f(x) = 0 = f(0)$, it follows that f is continuous at $x = 0$.
- (c) $\lim_{x \rightarrow 0^-} f'(x) = \lim_{x \rightarrow 0^-} 1 = 1$ and $\lim_{x \rightarrow 0^+} f'(x) = \lim_{x \rightarrow 0^+} \sec^2 x = 1 \Rightarrow \lim_{x \rightarrow 0} f'(x) = 1$. Since this limit exists it follows that f is differentiable at $x = 0$.

97. (a)

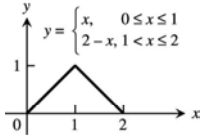

- (b) $\lim_{x \rightarrow 1^-} f(x) = \lim_{x \rightarrow 1^-} x = 1$ and $\lim_{x \rightarrow 1^+} f(x) = \lim_{x \rightarrow 1^+} (2 - x) = 1 \Rightarrow \lim_{x \rightarrow 1} f(x) = 1$. Since $\lim_{x \rightarrow 1} f(x) = 1 = f(1)$, it follows that f is continuous at $x = 1$.
- (c) $\lim_{x \rightarrow 1^-} f'(x) = \lim_{x \rightarrow 1^-} 1 = 1$ and $\lim_{x \rightarrow 1^+} f'(x) = \lim_{x \rightarrow 1^+} -1 = -1 \Rightarrow \lim_{x \rightarrow 1^-} f'(x) \neq \lim_{x \rightarrow 1^+} f'(x)$, so $\lim_{x \rightarrow 1} f'(x)$ does not exist $\Rightarrow f$ is not differentiable at $x = 1$.
98. (a) $\lim_{x \rightarrow 0^-} f(x) = \lim_{x \rightarrow 0^-} \sin 2x = 0$ and $\lim_{x \rightarrow 0^+} f(x) = \lim_{x \rightarrow 0^+} mx = 0 \Rightarrow \lim_{x \rightarrow 0} f(x) = 0$, independent of m ; since $f(0) = 0 = \lim_{x \rightarrow 0} f(x)$ it follows that f is continuous at $x = 0$ for all values of m .
- (b) $\lim_{x \rightarrow 0^-} f'(x) = \lim_{x \rightarrow 0^-} (\sin 2x)' = \lim_{x \rightarrow 0^-} 2 \cos 2x = 2$ and $\lim_{x \rightarrow 0^+} f'(x) = \lim_{x \rightarrow 0^+} (mx)' = \lim_{x \rightarrow 0^+} m = m \Rightarrow f$ is differentiable at $x = 0$ provided that $\lim_{x \rightarrow 0^-} f'(x) = \lim_{x \rightarrow 0^+} f'(x) \Rightarrow m = 2$.

99. $y = \frac{x}{2} + \frac{1}{2x-4} = \frac{1}{2}x + (2x-4)^{-1} \Rightarrow \frac{dy}{dx} = \frac{1}{2} - 2(2x-4)^{-2}$; the slope of the tangent is $-\frac{3}{2} \Rightarrow -\frac{3}{2} = \frac{1}{2} - 2(2x-4)^{-2} \Rightarrow -2 = -2(2x-4)^{-2} \Rightarrow 1 = \frac{1}{(2x-4)^2} \Rightarrow (2x-4)^2 = 1 \Rightarrow 4x^2 - 16x + 16 = 1 \Rightarrow 4x^2 - 16x + 15 = 0 \Rightarrow (2x-5)(2x-3) = 0 \Rightarrow x = \frac{5}{2}$ or $x = \frac{3}{2} \Rightarrow (\frac{5}{2}, \frac{5}{9})$ and $(\frac{3}{2}, -\frac{1}{4})$ are points on the curve where the slope is $-\frac{3}{2}$.

100. $y = x - e^{-x}$; $\frac{dy}{dx} = 1 + e^{-x} = 2 \Rightarrow e^{-x} = 1 \Rightarrow x = 0 \Rightarrow y = 0 - e^0 = -1$. Therefore, the curve has a tangent with a slope of 2 at the point $(0, -1)$.

101. $y = 2x^3 - 3x^2 - 12x + 20 \Rightarrow \frac{dy}{dx} = 6x^2 - 6x - 12$; the tangent is parallel to the x -axis when $\frac{dy}{dx} = 0 \Rightarrow 6x^2 - 6x - 12 = 0 \Rightarrow x^2 - x - 2 = 0 \Rightarrow (x-2)(x+1) = 0 \Rightarrow x = 2$ or $x = -1 \Rightarrow (2, 0)$ and $(-1, 27)$ are points on the curve where the tangent is parallel to the x -axis.

102. $y = x^3 \Rightarrow \frac{dy}{dx} = 3x^2 \Rightarrow \frac{dy}{dx} \Big|_{(-2, -8)} = 12$; an equation of the tangent line at $(-2, -8)$ is $y + 8 = 12(x + 2) \Rightarrow y = 12x + 16$; x -intercept: $0 = 12x + 16 \Rightarrow x = -\frac{4}{3} \Rightarrow (-\frac{4}{3}, 0)$; y -intercept: $y = 12(0) + 16 = 16 \Rightarrow (0, 16)$

103. $y = 2x^3 - 3x^2 - 12x + 20 \Rightarrow \frac{dy}{dx} = 6x^2 - 6x - 12$

- (a) The tangent is perpendicular to the line $y = 1 - \frac{x}{24}$ when $\frac{dy}{dx} = -\left(\frac{1}{-\frac{1}{24}}\right) = 24$; $6x^2 - 6x - 12 = 24 \Rightarrow x^2 - x - 2 = 4 \Rightarrow x^2 - x - 6 = 0 \Rightarrow (x-3)(x+2) = 0 \Rightarrow x = -2$ or $x = 3 \Rightarrow (-2, 16)$ and $(3, 11)$ are points where the tangent is perpendicular to $y = 1 - \frac{x}{24}$.
- (b) The tangent is parallel to the line $y = \sqrt{2} - 12x$ when $\frac{dy}{dx} = -12 \Rightarrow 6x^2 - 6x - 12 = -12 \Rightarrow x^2 - x = 0 \Rightarrow x(x-1) = 0 \Rightarrow x = 0$ or $x = 1 \Rightarrow (0, 20)$ and $(1, 7)$ are points where the tangent is parallel to $y = \sqrt{2} - 12x$.

104. $y = \frac{\pi \sin x}{x} \Rightarrow \frac{dy}{dx} = \frac{x(\pi \cos x) - (\pi \sin x)(1)}{x^2} \Rightarrow m_1 = \frac{dy}{dx}\bigg|_{x=\pi} = \frac{-\pi^2}{\pi^2} = -1$ and $m_2 = \frac{dy}{dx}\bigg|_{x=-\pi} = \frac{\pi^2}{\pi^2} = 1$. Since $m_1 = -\frac{1}{m_2}$

the tangents intersect at right angles.

105. $y = \tan x, -\frac{\pi}{2} < x < \frac{\pi}{2} \Rightarrow \frac{dy}{dx} = \sec^2 x$; now the slope of $y = -\frac{x}{2}$ is $-\frac{1}{2} \Rightarrow$ the normal line is parallel to $y = -\frac{x}{2}$ when $\frac{dy}{dx} = 2$. Thus, $\sec^2 x = 2 \Rightarrow \frac{1}{\cos^2 x} = 2 \Rightarrow \cos^2 x = \frac{1}{2} \Rightarrow \cos x = \frac{\pm 1}{\sqrt{2}} \Rightarrow x = -\frac{\pi}{4}$ and $x = \frac{\pi}{4}$ for $-\frac{\pi}{2} < x < \frac{\pi}{2} \Rightarrow (-\frac{\pi}{4}, -1)$ and $(\frac{\pi}{4}, 1)$ are points where the normal is parallel to $y = -\frac{x}{2}$.

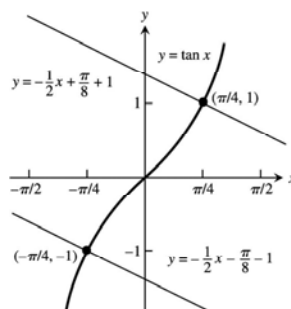

106. $y = 1 + \cos x \Rightarrow \frac{dy}{dx} = -\sin x \Rightarrow \frac{dy}{dx}\bigg|_{(\frac{\pi}{2}, 1)} = -1$
 \Rightarrow the tangent at $(\frac{\pi}{2}, 1)$ is the line $y - 1 = -(x - \frac{\pi}{2})$
 $\Rightarrow y = -x + \frac{\pi}{2} + 1$; the normal at $(\frac{\pi}{2}, 1)$ is $y - 1 = (1)(x - \frac{\pi}{2}) \Rightarrow y = x - \frac{\pi}{2} + 1$

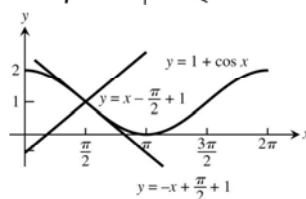

107. $y = x^2 + C \Rightarrow \frac{dy}{dx} = 2x$ and $y = x \Rightarrow \frac{dy}{dx} = 1$; the parabola is tangent to $y = x$ when $2x = 1 \Rightarrow x = \frac{1}{2} \Rightarrow y = \frac{1}{2}$; thus, $\frac{1}{2} = (\frac{1}{2})^2 + C \Rightarrow C = \frac{1}{4}$

108. $y = x^3 \Rightarrow \frac{dy}{dx} = 3x^2 \Rightarrow \frac{dy}{dx}\bigg|_{x=a} = 3a^2 \Rightarrow$ the tangent line at (a, a^3) is $y - a^3 = 3a^2(x - a)$. The tangent line intersects $y = x^3$ when $x^3 - a^3 = 3a^2(x - a) \Rightarrow (x - a)(x^2 + xa + a^2) = 3a^2(x - a) \Rightarrow (x - a)(x^2 + xa - 2a^2) = 0 \Rightarrow (x - a)^2(x + 2a) = 0 \Rightarrow x = a$ or $x = -2a$. Now $\frac{dy}{dx}\bigg|_{x=-2a} = 3(-2a)^2 = 12a^2 = 4(3a^2)$, so the slope at $x = -2a$ is 4 times as large as the slope at (a, a^3) where $x = a$.

109. The line through $(0, 3)$ and $(5, -2)$ has slope $m = \frac{3 - (-2)}{0 - 5} = -1 \Rightarrow$ the line through $(0, 3)$ and $(5, -2)$ is $y = -x + 3$; $y = \frac{c}{x+1} \Rightarrow \frac{dy}{dx} = \frac{-c}{(x+1)^2}$, so the curve is tangent to $y = -x + 3 \Rightarrow \frac{dy}{dx} = -1 = \frac{-c}{(x+1)^2} \Rightarrow (x+1)^2 = c, x \neq -1$. Moreover, $y = \frac{c}{x+1}$ intersects $y = -x + 3 \Rightarrow \frac{c}{x+1} = -x + 3, x \neq -1 \Rightarrow c = (x+1)(-x+3), x \neq -1$. Thus $c = c \Rightarrow (x+1)^2 = (x+1)(-x+3) \Rightarrow (x+1)[x+1 - (-x+3)] = 0, x \neq -1 \Rightarrow (x+1)(2x-2) = 0 \Rightarrow x = 1$ (since $x \neq -1$) $\Rightarrow c = 4$.

110. Let $(b, \pm\sqrt{a^2 - b^2})$ be a point on the circle $x^2 + y^2 = a^2$. Then $x^2 + y^2 = a^2 \Rightarrow 2x + 2y \frac{dy}{dx} = 0 \Rightarrow \frac{dy}{dx} = -\frac{x}{y} \Rightarrow \frac{dy}{dx}\bigg|_{x=a} = \frac{-b}{\pm\sqrt{a^2 - b^2}} \Rightarrow$ normal line through $(b, \pm\sqrt{a^2 - b^2})$ has slope $\frac{\pm\sqrt{a^2 - b^2}}{b} \Rightarrow$ normal line is $y - (\pm\sqrt{a^2 - b^2}) = \frac{\pm\sqrt{a^2 - b^2}}{b}(x - b) \Rightarrow y \mp \sqrt{a^2 - b^2} = \frac{\pm\sqrt{a^2 - b^2}}{b}x \mp \sqrt{a^2 - b^2} \Rightarrow y = \pm \frac{\sqrt{a^2 - b^2}}{b}x$ which passes through the origin.

111. $x^2 + 2y^2 = 9 \Rightarrow 2x + 4y \frac{dy}{dx} = 0 \Rightarrow \frac{dy}{dx} = -\frac{x}{2y} \Rightarrow \frac{dy}{dx}\bigg|_{(1, 2)} = -\frac{1}{4} \Rightarrow$ the tangent line is $y - 2 = -\frac{1}{4}(x - 1) = -\frac{1}{4}x + \frac{9}{4}$ and the normal line is $y = 2 + 4(x - 1) = 4x - 2$.

112. $e^x + y^2 = 2 \Rightarrow \frac{d}{dx}(e^x + y^2) = \frac{d}{dx}(2) \Rightarrow e^x + 2y \frac{dy}{dx} = 0 \Rightarrow \frac{dy}{dx} = -\frac{e^x}{2y} \Rightarrow m_{\tan} = \frac{dy}{dx}\Big|_{(0,1)} = -\frac{e^0}{2(1)} = -\frac{1}{2};$

$m_{\perp} = -\frac{1}{m_{\tan}} = 2; \text{ tangent line: } y - 1 = -\frac{1}{2}(x - 0) \Rightarrow y = 1 - \frac{x}{2}; \text{ normal line: } y - 1 = 2(x - 0) \Rightarrow y = 2x + 1$

113. $xy + 2x - 5y = 2 \Rightarrow \left(x \frac{dy}{dx} + y\right) + 2 - 5 \frac{dy}{dx} = 0 \Rightarrow \frac{dy}{dx}(x - 5) = -y - 2 \Rightarrow \frac{dy}{dx} = \frac{-y - 2}{x - 5} \Rightarrow \frac{dy}{dx}\Big|_{(3,2)} = 2 \Rightarrow \text{the tangent line is } y = 2 + 2(x - 3) = 2x - 4 \text{ and the normal line is } y = 2 + \frac{-1}{2}(x - 3) = -\frac{1}{2}x + \frac{7}{2}.$

114. $(y - x)^2 = 2x + 4 \Rightarrow 2(y - x)\left(\frac{dy}{dx} - 1\right) = 2 \Rightarrow (y - x) \frac{dy}{dx} = 1 + (y - x) \Rightarrow \frac{dy}{dx} = \frac{1 + y - x}{y - x} \Rightarrow \frac{dy}{dx}\Big|_{(6,2)} = \frac{3}{4} \Rightarrow \text{the tangent line is } y = 2 + \frac{3}{4}(x - 6) = \frac{3}{4}x - \frac{5}{2} \text{ and the normal line is } y = 2 - \frac{4}{3}(x - 6) = -\frac{4}{3}x + 10.$

115. $x + \sqrt{xy} = 6 \Rightarrow 1 + \frac{1}{2\sqrt{xy}}\left(x \frac{dy}{dx} + y\right) = 0 \Rightarrow x \frac{dy}{dx} + y = -2\sqrt{xy} \Rightarrow \frac{dy}{dx} = \frac{-2\sqrt{xy} - y}{x} \Rightarrow \frac{dy}{dx}\Big|_{(4,1)} = \frac{-5}{4} \Rightarrow \text{the tangent line is } y = 1 - \frac{5}{4}(x - 4) = -\frac{5}{4}x + 6 \text{ and the normal line is } y = 1 + \frac{4}{5}(x - 4) = \frac{4}{5}x - \frac{11}{5}.$

116. $x^{3/2} + 2y^{3/2} = 17 \Rightarrow \frac{3}{2}x^{1/2} + 3y^{1/2} \cdot \frac{dy}{dx} = 0 \Rightarrow \frac{dy}{dx} = \frac{-x^{1/2}}{2y^{1/2}} \Rightarrow \frac{dy}{dx}\Big|_{(1,4)} = -\frac{1}{4} \Rightarrow \text{the tangent line is } y = 4 - \frac{1}{4}(x - 1) = -\frac{1}{4}x + \frac{17}{4} \text{ and the normal line is } y = 4 + 4(x - 1) = 4x.$

117. $x^3y^3 + y^2 = x + y \Rightarrow \left[x^3\left(3y^2 \frac{dy}{dx}\right) + y^3(3x^2)\right] + 2y \frac{dy}{dx} = 1 + \frac{dy}{dx} \Rightarrow 3x^3y^2 \frac{dy}{dx} + 2y \frac{dy}{dx} - \frac{dy}{dx} = 1 - 3x^2y^3$
 $\Rightarrow \frac{dy}{dx}(3x^3y^2 + 2y - 1) = 1 - 3x^2y^3 \Rightarrow \frac{dy}{dx} = \frac{1 - 3x^2y^3}{3x^3y^2 + 2y - 1} \Rightarrow \frac{dy}{dx}\Big|_{(1,1)} = -\frac{2}{4}, \text{ but } \frac{dy}{dx}\Big|_{(1,-1)} \text{ is undefined. Therefore, the curve has slope } -\frac{1}{2} \text{ at } (1, 1) \text{ but the slope is undefined at } (1, -1).$

118. $y = \sin(x - \sin x) \Rightarrow \frac{dy}{dx} = [\cos(x - \sin x)](1 - \cos x); y = 0 \Rightarrow \sin(x - \sin x) = 0 \Rightarrow x - \sin x = k\pi, k = -2, -1, 0, 1, 2$
 (for our interval) $\Rightarrow \cos(x - \sin x) = \cos(k\pi) = \pm 1$. Therefore, $\frac{dy}{dx} = 0$ and $y = 0$ when $1 - \cos x = 0$ and $x = k\pi$.
 For $-2\pi \leq x \leq 2\pi$, these equations hold when $k = -2, 0, \text{ and } 2$ (since $\cos(-\pi) = \cos \pi = -1$.) Thus the curve has horizontal tangents at the x -axis for the x -values $-2\pi, 0, \text{ and } 2\pi$ (which are even integer multiples of π) \Rightarrow the curve has an infinite number of horizontal tangents.

119. $B = \text{graph of } f, A = \text{graph of } f'$. Curve B cannot be the derivative of A because A has only negative slopes while some of B 's values are positive.

120. $A = \text{graph of } f, B = \text{graph of } f'$. Curve A cannot be the derivative of B because B has only negative slopes while A has positive values for $x > 0$.

121.

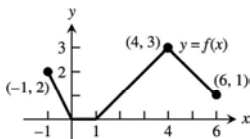

122.

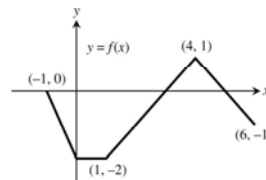

123. (a) 0, 0

(b) largest 1700, smallest about 1400

124. rabbits/day and foxes/day

$$125. \lim_{x \rightarrow 0} \frac{\sin x}{2x^2 - x} = \lim_{x \rightarrow 0} \left[\left(\frac{\sin x}{x} \right) \cdot \frac{1}{(2x-1)} \right] = (1) \left(\frac{1}{-1} \right) = -1$$

$$126. \lim_{x \rightarrow 0} \frac{3x - \tan 7x}{2x} = \lim_{x \rightarrow 0} \left(\frac{3x}{2x} - \frac{\sin 7x}{2x \cos 7x} \right) = \frac{3}{2} - \lim_{x \rightarrow 0} \left(\frac{1}{\cos 7x} \cdot \frac{\sin 7x}{7x} \cdot \frac{1}{\left(\frac{2}{7}\right)} \right) = \frac{3}{2} - \left(1 \cdot 1 \cdot \frac{7}{2} \right) = -2$$

$$127. \lim_{r \rightarrow 0} \frac{\sin r}{\tan 2r} = \lim_{r \rightarrow 0} \left(\frac{\sin r}{r} \cdot \frac{2r}{\tan 2r} \cdot \frac{1}{2} \right) = \left(\frac{1}{2} \right) (1) \lim_{r \rightarrow 0} \frac{\cos 2r}{\left(\frac{\sin 2r}{2r} \right)} = \left(\frac{1}{2} \right) (1) \left(\frac{1}{1} \right) = \frac{1}{2}$$

$$128. \lim_{\theta \rightarrow 0} \frac{\sin(\sin \theta)}{\theta} = \lim_{\theta \rightarrow 0} \left(\frac{\sin(\sin \theta)}{\sin \theta} \right) \left(\frac{\sin \theta}{\theta} \right) = \lim_{\theta \rightarrow 0} \frac{\sin(\sin \theta)}{\sin \theta}. \text{ Let } x = \sin \theta. \text{ Then } x \rightarrow 0 \text{ as } \theta \rightarrow 0 \\ \Rightarrow \lim_{\theta \rightarrow 0} \frac{\sin(\sin \theta)}{\sin \theta} = \lim_{x \rightarrow 0} \frac{\sin x}{x} = 1$$

$$129. \lim_{\theta \rightarrow \left(\frac{\pi}{2}\right)^-} \frac{4 \tan^2 \theta + \tan \theta + 1}{\tan^2 \theta + 5} = \lim_{\theta \rightarrow \left(\frac{\pi}{2}\right)^-} \frac{\left(4 + \frac{1}{\tan \theta} + \frac{1}{\tan^2 \theta} \right)}{\left(1 + \frac{5}{\tan^2 \theta} \right)} = \frac{(4+0+0)}{(1+0)} = 4$$

$$130. \lim_{\theta \rightarrow 0^+} \frac{1 - 2 \cot^2 \theta}{5 \cot^2 \theta - 7 \cot \theta - 8} = \lim_{\theta \rightarrow 0^+} \frac{\left(\frac{1}{\cot^2 \theta} - 2 \right)}{\left(5 \frac{1}{\cot \theta} - \frac{8}{\cot^2 \theta} \right)} = \frac{(0-2)}{(5-0-0)} = -\frac{2}{5}$$

$$131. \lim_{x \rightarrow 0} \frac{x \sin x}{2 - 2 \cos x} = \lim_{x \rightarrow 0} \frac{x \sin x}{2(1 - \cos x)} = \lim_{x \rightarrow 0} \frac{x \sin x}{2 \left(2 \sin^2 \left(\frac{x}{2} \right) \right)} = \lim_{x \rightarrow 0} \left[\frac{\left(\frac{x}{2} \right)}{\sin \left(\frac{x}{2} \right)} \cdot \frac{\left(\frac{x}{2} \right)}{\sin \left(\frac{x}{2} \right)} \cdot \frac{\sin x}{x} \right] = (1)(1)(1) = 1$$

$$132. \lim_{\theta \rightarrow 0} \frac{1 - \cos \theta}{\theta^2} = \lim_{\theta \rightarrow 0} \frac{2 \sin^2 \left(\frac{\theta}{2} \right)}{\theta^2} = \lim_{\theta \rightarrow 0} \left[\frac{\sin \left(\frac{\theta}{2} \right)}{\left(\frac{\theta}{2} \right)} \cdot \frac{\sin \left(\frac{\theta}{2} \right)}{\left(\frac{\theta}{2} \right)} \cdot \frac{1}{2} \right] = (1)(1) \left(\frac{1}{2} \right) = \frac{1}{2}$$

$$133. \lim_{x \rightarrow 0} \frac{\tan x}{x} = \lim_{x \rightarrow 0} \left(\frac{1}{\cos x} \cdot \frac{\sin x}{x} \right) = 1; \text{ let } \theta = \tan x \Rightarrow \theta \rightarrow 0 \text{ as } x \rightarrow 0 \Rightarrow \lim_{x \rightarrow 0} g(x) = \lim_{x \rightarrow 0} \frac{\tan(\tan x)}{\tan x} = \lim_{\theta \rightarrow 0} \frac{\tan \theta}{\theta} = 1. \\ \text{Therefore, to make } g \text{ continuous at the origin, define } g(0) = 1.$$

$$134. \lim_{x \rightarrow 0} f(x) = \lim_{x \rightarrow 0} \frac{\tan(\tan x)}{\sin(\sin x)} = \lim_{x \rightarrow 0} \left[\frac{\tan(\tan x)}{\tan x} \cdot \frac{\sin x}{\sin(\sin x)} \cdot \frac{1}{\cos x} \right] = 1 \cdot \lim_{x \rightarrow 0} \frac{\sin x}{\sin(\sin x)} \text{ (using the result of \# 103); let } \\ \theta = \sin x \Rightarrow \theta \rightarrow 0 \text{ as } x \rightarrow 0 \Rightarrow \lim_{x \rightarrow 0} \frac{\sin x}{\sin(\sin x)} = \lim_{\theta \rightarrow 0} \frac{\theta}{\sin \theta} = 1. \text{ Therefore, to make } f \text{ continuous at the origin,} \\ \text{define } f(0) = 1.$$

$$135. y = \frac{2(x^2+1)}{\sqrt{\cos 2x}} \Rightarrow \ln y = \ln \left(\frac{2(x^2+1)}{\sqrt{\cos 2x}} \right) = \ln(2) + \ln(x^2+1) - \frac{1}{2} \ln(\cos 2x) \Rightarrow \frac{y'}{y} = 0 + \frac{2x}{x^2+1} - \left(\frac{1}{2} \right) \frac{(-2 \sin 2x)}{\cos 2x} \\ \Rightarrow y' = \left(\frac{2x}{x^2+1} + \tan 2x \right) y = \frac{2(x^2+1)}{\sqrt{\cos 2x}} \left(\frac{2x}{x^2+1} + \tan 2x \right)$$

$$136. y = 10 \sqrt[3]{\frac{3x+4}{2x-4}} \Rightarrow \ln y = \ln 10 \sqrt[3]{\frac{3x+4}{2x-4}} = \frac{1}{10} [\ln(3x+4) - \ln(2x-4)] \Rightarrow \frac{y'}{y} = \frac{1}{10} \left(\frac{3}{3x+4} - \frac{2}{2x-4} \right) \\ \Rightarrow y' = \frac{1}{10} \left(\frac{3}{3x+4} - \frac{1}{x-2} \right) y = 10 \sqrt[3]{\frac{3x+4}{2x-4}} \left(\frac{1}{10} \right) \left(\frac{3}{3x+4} - \frac{1}{x-2} \right)$$

137. $y = \left[\frac{(t+1)(t-1)}{(t-2)(t+3)} \right]^5 \Rightarrow \ln y = 5[\ln(t+1) + \ln(t-1) - \ln(t-2) - \ln(t+3)]$
 $\Rightarrow \left(\frac{1}{y}\right)\left(\frac{dy}{dt}\right) = 5\left(\frac{1}{t+1} + \frac{1}{t-1} + \frac{1}{t-2} - \frac{1}{t+3}\right) \Rightarrow \frac{dy}{dt} = 5\left[\frac{(t+1)(t-1)}{(t-2)(t+3)}\right]^5 \left(\frac{1}{t+1} + \frac{1}{t-1} - \frac{1}{t-2} - \frac{1}{t+3}\right)$
138. $y = \frac{2u2^u}{\sqrt{u^2+1}} \Rightarrow \ln y = \ln 2 + \ln u + u \ln 2 - \frac{1}{2} \ln(u^2 + 1) \Rightarrow \left(\frac{1}{y}\right)\left(\frac{dy}{du}\right) = \frac{1}{u} + \ln 2 - \frac{u}{2} \left(\frac{2}{u^2+1}\right)$
 $\Rightarrow \frac{dy}{du} = \frac{2u2^u}{\sqrt{u^2+1}} \left(\frac{1}{u} + \ln 2 - \frac{u}{u^2+1}\right)$
139. $y = (\sin \theta)^{\sqrt{\theta}} \Rightarrow \ln y = \sqrt{\theta} \ln(\sin \theta) \Rightarrow \left(\frac{1}{y}\right)\left(\frac{dy}{d\theta}\right) = \sqrt{\theta} \left(\frac{\cos \theta}{\sin \theta}\right) + \frac{1}{2} \theta^{-1/2} \ln(\sin \theta)$
 $\Rightarrow \frac{dy}{d\theta} = (\sin \theta)^{\sqrt{\theta}} \left(\sqrt{\theta} \cot \theta + \frac{\ln(\sin \theta)}{2\sqrt{\theta}}\right)$
140. $y = (\ln x)^{1/\ln x} \Rightarrow \ln y = \left(\frac{1}{\ln x}\right) \ln(\ln x) \Rightarrow \frac{y'}{y} = \left(\frac{1}{\ln x}\right) \left(\frac{1}{\ln x}\right) \left(\frac{1}{x}\right) + \ln(\ln x) \left[\frac{-1}{(\ln x)^2}\right] \left(\frac{1}{x}\right) \Rightarrow y' = (\ln x)^x \left[\frac{1 - \ln(\ln x)}{x(\ln x)^2}\right]$
141. (a) $S = 2\pi r^2 + 2\pi rh$ and h constant $\Rightarrow \frac{dS}{dt} = 4\pi r \frac{dr}{dt} + 2\pi h \frac{dr}{dt} = (4\pi r + 2\pi h) \frac{dr}{dt}$
 (b) $S = 2\pi r^2 + 2\pi rh$ and r constant $\Rightarrow \frac{dS}{dt} = +2\pi r \frac{dh}{dt}$
 (c) $S = 2\pi r^2 + 2\pi rh \Rightarrow \frac{dS}{dt} = 4\pi r \frac{dr}{dt} + 2\pi \left(r \frac{dh}{dt} + h \frac{dr}{dt}\right) = (4\pi r + 2\pi h) \frac{dr}{dt} + 2\pi r \frac{dh}{dt}$
 (d) S constant $\Rightarrow \frac{dS}{dt} = 0 \Rightarrow 0 = (4\pi r + 2\pi h) \frac{dr}{dt} + 2\pi r \frac{dh}{dt} \Rightarrow (2r + h) \frac{dr}{dt} = -r \frac{dh}{dt} \Rightarrow \frac{dr}{dt} = \frac{-r}{2r+h} \frac{dh}{dt}$
142. $S = \pi r \sqrt{r^2 + h^2} \Rightarrow \frac{dS}{dt} = \pi r \cdot \frac{(r \frac{dr}{dt} + h \frac{dh}{dt})}{\sqrt{r^2 + h^2}} + \pi \sqrt{r^2 + h^2} \frac{dr}{dt}$;
 (a) h constant $\Rightarrow \frac{dh}{dt} = 0 \Rightarrow \frac{dS}{dt} = \frac{\pi r^2 \frac{dr}{dt}}{\sqrt{r^2 + h^2}} + \pi \sqrt{r^2 + h^2} \frac{dr}{dt} = \left[\pi \sqrt{r^2 + h^2} + \frac{\pi r^2}{\sqrt{r^2 + h^2}}\right] \frac{dr}{dt}$
 (b) r constant $\Rightarrow \frac{dr}{dt} = 0 \Rightarrow \frac{dS}{dt} = \frac{\pi r h}{\sqrt{r^2 + h^2}} \frac{dh}{dt}$
 (c) In general, $\frac{dS}{dt} = \left[\pi \sqrt{r^2 + h^2} + \frac{\pi r^2}{\sqrt{r^2 + h^2}}\right] \frac{dr}{dt} + \frac{\pi r h}{\sqrt{r^2 + h^2}} \frac{dh}{dt}$
143. $A = \pi r^2 \Rightarrow \frac{dA}{dt} = 2\pi r \frac{dr}{dt}$; so $r = 10$ and $\frac{dr}{dt} = -\frac{2}{\pi}$ m/sec $\Rightarrow \frac{dA}{dt} = (2\pi)(10)\left(-\frac{2}{\pi}\right) = -40$ m²/sec
144. $V = s^3 \Rightarrow \frac{dV}{dt} = 3s^2 \cdot \frac{ds}{dt} \Rightarrow \frac{ds}{dt} = \frac{1}{3s^2} \frac{dV}{dt}$; so $s = 20$ and $\frac{dV}{dt} = 1200$ cm³/min $\Rightarrow \frac{ds}{dt} = \frac{1}{30(20)^2} (1200) = 1$ cm/min
145. $\frac{dR_1}{dt} = -1$ ohm/sec, $\frac{dR_2}{dt} = 0.5$ ohm/sec; and $\frac{1}{R} = \frac{1}{R_1} + \frac{1}{R_2} \Rightarrow \frac{-1}{R^2} \frac{dR}{dt} = \frac{-1}{R_1^2} \frac{dR_1}{dt} - \frac{1}{R_2^2} \frac{dR_2}{dt}$. Also, $R_1 = 75$ ohms and $R_2 = 50$ ohms $\Rightarrow \frac{1}{R} = \frac{1}{75} + \frac{1}{50} \Rightarrow R = 30$ ohms. Therefore, from the derivative equation,
 $\frac{-1}{(30)^2} \frac{dR}{dt} = \frac{-1}{(75)^2} (-1) - \frac{1}{(50)^2} (0.5) = \left(\frac{1}{5625} - \frac{1}{5000}\right) \Rightarrow \frac{dR}{dt} = (-900) \left(\frac{5000 - 5625}{5625 \cdot 5000}\right) = \frac{9(625)}{50(5625)} = \frac{1}{50} = 0.02$ ohm/sec.
146. $\frac{dR}{dt} = 3$ ohms/sec and $\frac{dX}{dt} = -2$ ohms/sec; $Z = \sqrt{R^2 + X^2} \Rightarrow \frac{dZ}{dt} = \frac{R \frac{dR}{dt} + X \frac{dX}{dt}}{\sqrt{R^2 + X^2}}$ so that $R = 10$ ohms and $X = 20$ ohms $\Rightarrow \frac{dZ}{dt} = \frac{(10)(3) + (20)(-2)}{\sqrt{10^2 + 20^2}} = \frac{-1}{\sqrt{5}} \approx -0.45$ ohm/sec.

147. Given $\frac{dx}{dt} = 10$ m/sec and $\frac{dy}{dt} = 5$ m/sec, let D be the distance from the origin $\Rightarrow D^2 = x^2 + y^2$
 $\Rightarrow 2D \frac{dD}{dt} = 2x \frac{dx}{dt} + 2y \frac{dy}{dt} \Rightarrow D \frac{dD}{dt} = x \frac{dx}{dt} + y \frac{dy}{dt}$. When $(x, y) = (3, -4)$, $D = \sqrt{3^2 + (-4)^2} = 5$ and
 $5 \frac{dD}{dt} = (3)(10) + (-4)(5) \Rightarrow \frac{dD}{dt} = \frac{10}{5} = 2$. Therefore, the particle is moving away from the origin at 2 m/sec
 (because the distance D is increasing).

148. Let D be the distance from the origin. We are given that $\frac{dD}{dt} = 11$ units/sec. Then $D^2 = x^2 + y^2 = x^2 + (x^{3/2})^2$
 $= x^2 + x^3 \Rightarrow 2D \frac{dD}{dt} = 2x \frac{dx}{dt} + 3x^2 \frac{dx}{dt} = x(2 + 3x) \frac{dx}{dt}$; $x = 3 \Rightarrow D = \sqrt{3^2 + 3^3} = 6$ and substitution in the derivative
 equation gives $(2)(6)(11) = (3)(2 + 9) \frac{dx}{dt} \Rightarrow \frac{dx}{dt} = 4$ units/sec.

149. (a) From the diagram we have $\frac{10}{h} = \frac{4}{r} \Rightarrow r = \frac{2}{5} h$.

(b) $V = \frac{1}{3} \pi r^2 h = \frac{1}{3} \pi \left(\frac{2}{5} h\right)^2 h = \frac{4\pi h^3}{75} \Rightarrow \frac{dV}{dt} = \frac{4\pi h^2}{25} \frac{dh}{dt}$, so $\frac{dV}{dt} = -5$ and $h = 6 \Rightarrow \frac{dh}{dt} = -\frac{125}{144\pi}$ ft/min.

150. From the sketch in the text, $s = r\theta \Rightarrow \frac{ds}{dt} = r \frac{d\theta}{dt} + \theta \frac{dr}{dt}$. Also $r = 1.2$ is constant $\Rightarrow \frac{dr}{dt} = 0 \Rightarrow \frac{ds}{dt} = r \frac{d\theta}{dt} = (1.2) \frac{d\theta}{dt}$.
 Therefore, $\frac{ds}{dt} = 6$ ft/sec and $r = 1.2$ ft $\Rightarrow \frac{d\theta}{dt} = 5$ rad/sec

151. (a) From the sketch in the text, $\frac{d\theta}{dt} = -0.6$ rad/sec and $x = \tan \theta$. Also $x = \tan \theta \Rightarrow \frac{dx}{dt} = \sec^2 \theta \frac{d\theta}{dt}$; at point A ,
 $x = 0 \Rightarrow \theta = 0 \Rightarrow \frac{dx}{dt} = (\sec^2 0)(-0.6) = -0.6$. Therefore the speed of the light is $0.6 = \frac{3}{5}$ km/sec when it
 reaches point A .

(b) $\frac{(3/5) \text{ rad}}{\text{sec}} \cdot \frac{1 \text{ rev}}{2\pi \text{ rad}} \cdot \frac{60 \text{ sec}}{\text{min}} = \frac{18}{\pi}$ revs/min

152. From the figure, $\frac{a}{r} = \frac{b}{BC} \Rightarrow \frac{a}{r} = \frac{b}{\sqrt{b^2 - r^2}}$. We are given
 that r is constant. Differentiation gives,

$\frac{1}{r} \cdot \frac{da}{dt} = \frac{(\sqrt{b^2 - r^2}) \left(\frac{db}{dt}\right) - (b) \left(\frac{b}{\sqrt{b^2 - r^2}}\right) \left(\frac{db}{dt}\right)}{b^2 - r^2}$. Then, $b = 2r$ and

$$\frac{db}{dt} = -0.3r \Rightarrow \frac{da}{dt} = r \left[\frac{\sqrt{(2r)^2 - r^2} (-0.3r) - (2r) \left(\frac{2r(-0.3r)}{\sqrt{(2r)^2 - r^2}}\right)}{(2r)^2 - r^2} \right]$$

$= \frac{\sqrt{3r^2} (-0.3r) + \frac{4r^2(0.3r)}{\sqrt{3r^2}}}{3r} = \frac{(3r^2)(-0.3r) + (4r^2)(0.3r)}{3\sqrt{3r^2}} = \frac{0.3r}{3\sqrt{3}} = \frac{r}{10\sqrt{3}}$ m/sec. Since $\frac{da}{dt}$ is positive, the distance OA is
 increasing when $OB = 2r$, and B is moving toward O at the rate of $0.3r$ m/sec.

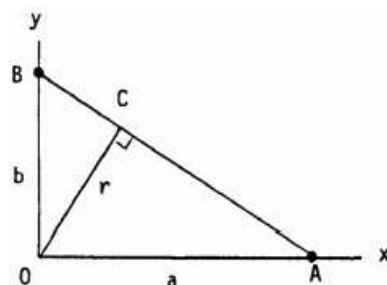

153. (a) If $f(x) = \tan x$ and $x = -\frac{\pi}{4}$, then $f'(x) = \sec^2 x$,
 $f\left(-\frac{\pi}{4}\right) = -1$ and $f'\left(-\frac{\pi}{4}\right) = 2$. The linearization of
 $f(x)$ is $L(x) = 2\left(x + \frac{\pi}{4}\right) + (-1) = 2x + \frac{\pi-2}{2}$.

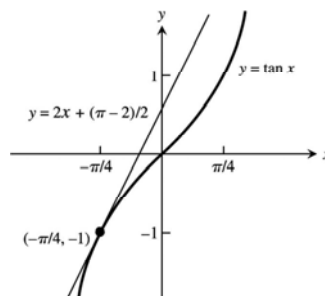

- (b) if $f(x) = \sec x$ and $x = -\frac{\pi}{4}$, then $f'(x) = \sec x \tan x$,
 $f\left(-\frac{\pi}{4}\right) = \sqrt{2}$ and $f'\left(-\frac{\pi}{4}\right) = -\sqrt{2}$. The linearization of
 $f(x)$ is $L(x) = -\sqrt{2}\left(x + \frac{\pi}{4}\right) + \sqrt{2} = -\sqrt{2}x + \frac{\sqrt{2}(4-\pi)}{4}$.

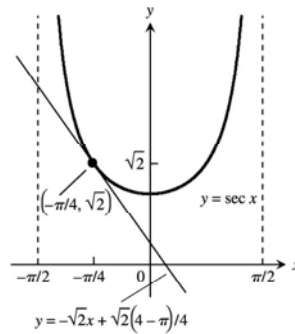

154. $f(x) = \frac{1}{1+\tan x} \Rightarrow f'(x) = \frac{-\sec^2 x}{(1+\tan x)^2}$. The linearization at $x = 0$ is $L(x) = f'(0)(x-0) + f(0) = 1-x$.
155. $f(x) = \sqrt{x+1} + \sin x - 0.5 = (x+1)^{1/2} + \sin x - 0.5 \Rightarrow f'(x) = \left(\frac{1}{2}\right)(x+1)^{-1/2} + \cos x$
 $\Rightarrow L(x) = f'(0)(x-0) + f(0) = 1.5(x-0) + 0.5 \Rightarrow L(x) = 1.5x + 0.5$, the linearization of $f(x)$.
156. $f(x) = \frac{2}{1-x} + \sqrt{1+x} - 3.1 = 2(1-x)^{-1} + (x+1)^{1/2} - 3.1 \Rightarrow f'(x) = -2(1-x)^{-2}(-1) + \left(\frac{1}{2}\right)(x+1)^{-1/2}$
 $= \frac{2}{(1-x)^2} + \frac{1}{2\sqrt{1+x}} \Rightarrow L(x) = f'(0)(x-0) + f(0) = 2.5x - 0.1$, the linearization of $f(x)$.
157. $S = \pi r \sqrt{r^2 + h^2}$, r constant $\Rightarrow dS = \pi r \cdot \frac{1}{2}(r^2 + h^2)^{-1/2} 2h dh = \frac{\pi r h}{\sqrt{r^2 + h^2}} dh$. Height changes from
 h_0 to $h_0 + dh \Rightarrow dS = \frac{\pi r h_0 (dh)}{\sqrt{r^2 + h_0^2}}$
158. (a) $S = 6r^2 \Rightarrow dS = 12r dr$. We want $|dS| \leq (2\%) S \Rightarrow |12r dr| \leq \frac{12r^2}{100} \Rightarrow |dr| \leq \frac{r}{100}$. The measurement of the
edge r must have an error less than 1%.
- (b) When $V = r^3$, then $dV = 3r^2 dr$. The accuracy of the volume is $\left(\frac{dV}{V}\right)(100\%) = \left(\frac{3r^2 dr}{r^3}\right)(100\%)$
 $= \left(\frac{3}{r}\right)(dr)(100\%) = \left(\frac{3}{r}\right)\left(\frac{r}{100}\right)(100\%) = 3\%$
159. $C = 2\pi r \Rightarrow r = \frac{C}{2\pi}$, $S = 4\pi r^2 = \frac{C^2}{\pi}$, and $V = \frac{4}{3}\pi r^3 = \frac{C^3}{6\pi^2}$. It also follows that $dr = \frac{1}{2\pi} dC$, $dS = \frac{2C}{\pi} dC$ and
 $dV = \frac{C^2}{2\pi^2} dC$. Recall that $C = 10$ cm and $dC = 0.4$ cm.
- (a) $dr = \frac{0.4}{2\pi} = \frac{0.2}{\pi}$ cm $\Rightarrow \left(\frac{dr}{r}\right)(100\%) = \left(\frac{0.2}{\pi}\right)\left(\frac{2\pi}{10}\right)(100\%) = (0.4)(100\%) = 4\%$
- (b) $dS = \frac{20}{\pi}(0.4) = \frac{8}{\pi}$ cm $\Rightarrow \left(\frac{dS}{S}\right)(100\%) = \left(\frac{8}{\pi}\right)\left(\frac{\pi}{100}\right)(100\%) = 8\%$
- (c) $dV = \frac{10^2}{2\pi^2}(0.4) = \frac{20}{\pi^2}$ cm $\Rightarrow \left(\frac{dV}{V}\right)(100\%) = \left(\frac{20}{\pi^2}\right)\left(\frac{6\pi^2}{1000}\right)(100\%) = 12\%$
160. Similar triangles yield $\frac{35}{h} = \frac{15}{6} \Rightarrow h = 14$ ft. The same triangles imply that $\frac{20+a}{h} = \frac{a}{6} \Rightarrow h = 120a^{-1} + 6$
 $\Rightarrow dh = -120a^{-2} da = -\frac{120}{a^2} da = \left(-\frac{120}{a^2}\right)\left(\pm\frac{1}{12}\right) = \left(-\frac{120}{15^2}\right)\left(\pm\frac{1}{12}\right) = \pm\frac{2}{45} \approx \pm 0.0444$ ft $= \pm 0.53$ inches.

CHAPTER 3 ADDITIONAL AND ADVANCED EXERCISES

1. (a) $\sin 2\theta = 2 \sin \theta \cos \theta \Rightarrow \frac{d}{d\theta}(\sin 2\theta) = \frac{d}{d\theta}(2 \sin \theta \cos \theta) \Rightarrow 2 \cos 2\theta = 2[(\sin \theta)(-\sin \theta) + (\cos \theta)(\cos \theta)]$
 $\Rightarrow \cos 2\theta = \cos^2 \theta - \sin^2 \theta$
- (b) $\cos 2\theta = \cos^2 \theta - \sin^2 \theta \Rightarrow \frac{d}{d\theta}(\cos 2\theta) = \frac{d}{d\theta}(\cos^2 \theta - \sin^2 \theta)$
 $\Rightarrow -2 \sin 2\theta = (2 \cos \theta)(-\sin \theta) - (2 \sin \theta)(\cos \theta)$
 $\Rightarrow \sin 2\theta = \cos \theta \sin \theta + \sin \theta \cos \theta \Rightarrow \sin 2\theta = 2 \sin \theta \cos \theta$
2. The derivative of $\sin(x+a) = \sin x \cos a + \cos x \sin a$ with respect to x is $\cos(x+a) = \cos x \cos a - \sin x \sin a$, which is also an identity. This principle does not apply to the equation $x^2 - 2x - 8 = 0$, since $x^2 - 2x - 8 = 0$ is not an identity: it holds for 2 values of x (-2 and 4), but not for all x .
3. (a) $f(x) = \cos x \Rightarrow f'(x) = -\sin x \Rightarrow f''(x) = -\cos x$, and $g(x) = a + bx + cx^2 \Rightarrow g'(x) = b + 2cx \Rightarrow g''(x) = 2c$; also, $f(0) = g(0) \Rightarrow \cos(0) = a \Rightarrow a = 1$; $f'(0) = g'(0) \Rightarrow -\sin(0) = b \Rightarrow b = 0$; $f''(0) = g''(0) \Rightarrow -\cos(0) = 2c \Rightarrow c = -\frac{1}{2}$. Therefore, $g(x) = 1 - \frac{1}{2}x^2$.
- (b) $f(x) = \sin(x+a) \Rightarrow f'(x) = \cos(x+a)$, and $g(x) = b \sin x + c \cos x \Rightarrow g'(x) = b \cos x - c \sin x$; also $f(0) = g(0) \Rightarrow \sin(a) = b \sin(0) + c \cos(0) \Rightarrow c = \sin a$; $f'(0) = g'(0) \Rightarrow \cos(a) = b \cos(0) - c \sin(0) \Rightarrow b = \cos a$. Therefore, $g(x) = \sin x \cos a + \cos x \sin a$.
- (c) When $f(x) = \cos x$, $f'''(x) = \sin x$ and $f^{(4)}(x) = \cos x$; when $g(x) = 1 - \frac{1}{2}x^2$, $g'''(x) = 0$ and $g^{(4)}(x) = 0$. Thus $f'''(0) = 0 = g'''(0)$ so the third derivatives agree at $x = 0$. However, the fourth derivatives do not agree since $f^{(4)}(0) = 1$ but $g^{(4)}(0) = 0$. In case (b), when $f(x) = \sin(x+a)$ and $g(x) = \sin x \cos a + \cos x \sin a$, notice that $f(x) = g(x)$ for all x , not just $x = 0$. Since this is an identity, we have $f^{(n)}(x) = g^{(n)}(x)$ for any x and any positive integer n .
4. (a) $y = \sin x \Rightarrow y' = \cos x \Rightarrow y'' = -\sin x \Rightarrow y'' + y = -\sin x + \sin x = 0$; $y = \cos x \Rightarrow y' = -\sin x \Rightarrow y'' = -\cos x \Rightarrow y'' + y = -\cos x + \cos x = 0$; $y = a \cos x + b \sin x \Rightarrow y' = -a \sin x + b \cos x \Rightarrow y'' = -a \cos x - b \sin x \Rightarrow y'' + y = (-a \cos x - b \sin x) + (a \cos x + b \sin x) = 0$
- (b) $y = \sin(2x) \Rightarrow y' = 2 \cos(2x) \Rightarrow y'' = -4 \sin(2x) \Rightarrow y'' + 4y = -4 \sin(2x) + 4 \sin(2x) = 0$. Similarly, $y = \cos(2x)$ and $y = a \cos(2x) + b \sin(2x)$ satisfy the differential equation $y'' + 4y = 0$. In general, $y = \cos(mx)$, $y = \sin(mx)$ and $y = a \cos(mx) + b \sin(mx)$ satisfy the differential equation $y'' + m^2 y = 0$.
5. If the circle $(x-h)^2 + (y-k)^2 = a^2$ and $y = x^2 + 1$ are tangent at $(1, 2)$, then the slope of this tangent is $m = 2x|_{(1,2)} = 2$ and the tangent line is $y = 2x$. The line containing (h, k) and $(1, 2)$ is perpendicular to $y = 2x \Rightarrow \frac{k-2}{h-1} = -\frac{1}{2} \Rightarrow h = 5 - 2k \Rightarrow$ the location of the center is $(5 - 2k, k)$. Also, $(x-h)^2 + (y-k)^2 = a^2 \Rightarrow x-h + (y-k)y' = 0 \Rightarrow 1 + (y')^2 + (y-k)y'' = 0 \Rightarrow y'' = \frac{1+(y')^2}{k-y}$. At the point $(1, 2)$ we know $y' = 2$ from the tangent line and that $y'' = 2$ from the parabola. Since the second derivatives are equal at $(1, 2)$ we obtain $2 = \frac{1+(2)^2}{k-2} \Rightarrow k = \frac{9}{2}$. Then $h = 5 - 2k = -4 \Rightarrow$ the circle is $(x+4)^2 + (y-\frac{9}{2})^2 = a^2$. Since $(1, 2)$ lies on the circle we have that $a = \frac{5\sqrt{5}}{2}$.
6. The total revenue is the number of people times the price of the fare: $r(x) = xp = x\left(3 - \frac{x}{40}\right)^2$, where $0 \leq x \leq 60$. The marginal revenue is $\frac{dr}{dx} = \left(3 - \frac{x}{40}\right)^2 + 2x\left(3 - \frac{x}{40}\right)\left(-\frac{1}{40}\right) \Rightarrow \frac{dr}{dx} = \left(3 - \frac{x}{40}\right)\left[\left(3 - \frac{x}{40}\right) - \frac{2x}{40}\right] = 3\left(3 - \frac{x}{40}\right)\left(1 - \frac{x}{40}\right)$. Then $\frac{dr}{dx} = 0 \Rightarrow x = 40$ (since $x = 120$ does not belong to the domain). When 40 people are on the bus the marginal revenue is zero and the fare is $p(40) = \left(3 - \frac{x}{40}\right)^2 \Big|_{(x=40)} = \4.00 .

7. (a) $y = uv \Rightarrow \frac{dy}{dt} = \frac{du}{dt}v + u\frac{dv}{dt} = (0.04u)v + u(0.05v) = 0.09uv = 0.09y \Rightarrow$ the rate of growth of the total production is 9% per year.
 (b) If $\frac{du}{dt} = -0.02u$ and $\frac{dv}{dt} = 0.03v$, then $\frac{dy}{dt} = (-0.02u)v + (0.03v)u = 0.01uv = 0.01y$, increasing at 1% per year.

8. When $x^2 + y^2 = 225$, then $y' = -\frac{x}{y}$. The tangent line to the balloon at $(12, -9)$ is $y + 9 = \frac{4}{3}(x - 12)$
 $\Rightarrow y = \frac{4}{3}x - 25$. The top of the gondola is $15 + 8 = 23$ ft below the center of the balloon. The intersection of $y = -23$ and $y = \frac{4}{3}x - 25$ is at the far right edge of the gondola $\Rightarrow -23 = \frac{4}{3}x - 25 \Rightarrow x = \frac{3}{2}$. Thus the gondola is $2x = 3$ ft wide.

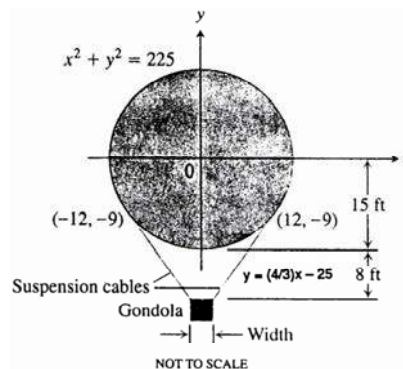

9. Answers will vary. Here is one possibility.

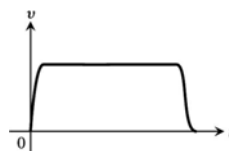

10. $s(t) = 10 \cos\left(t + \frac{\pi}{4}\right) \Rightarrow v(t) = \frac{ds}{dt} = -10 \sin\left(t + \frac{\pi}{4}\right) \Rightarrow a(t) = \frac{dv}{dt} = \frac{d^2s}{dt^2} = -10 \cos\left(t + \frac{\pi}{4}\right)$
 (a) $s(0) = 10 \cos\left(\frac{\pi}{4}\right) = \frac{10}{\sqrt{2}}$
 (b) Left: -10 , Right: 10
 (c) Solving $10 \cos\left(t + \frac{\pi}{4}\right) = -10 \Rightarrow \cos\left(t + \frac{\pi}{4}\right) = -1 \Rightarrow t = \frac{3\pi}{4}$ when the particle is farthest to the left. Solving $10 \cos\left(t + \frac{\pi}{4}\right) = 10 \Rightarrow \cos\left(t + \frac{\pi}{4}\right) = 1 \Rightarrow t = -\frac{\pi}{4}$, but $t \geq 0 \Rightarrow t = 2\pi + \frac{-\pi}{4} = \frac{7\pi}{4}$ when the particle is farthest to the right. Thus, $v\left(\frac{3\pi}{4}\right) = 0$, $v\left(\frac{7\pi}{4}\right) = 0$, $a\left(\frac{3\pi}{4}\right) = 10$, and $a\left(\frac{7\pi}{4}\right) = -10$.
 (d) Solving $10 \cos\left(t + \frac{\pi}{4}\right) = 0 \Rightarrow t = \frac{\pi}{4} \Rightarrow v\left(\frac{\pi}{4}\right) = -10$, $\left|v\left(\frac{\pi}{4}\right)\right| = 10$ and $a\left(\frac{\pi}{4}\right) = 0$.
11. (a) $s(t) = 64t - 16t^2 \Rightarrow v(t) = \frac{ds}{dt} = 64 - 32t = 32(2 - t)$. The maximum height is reached when $v(t) = 0 \Rightarrow t = 2$ sec. The velocity when it leaves the hand is $v(0) = 64$ ft/sec.
 (b) $s(t) = 64t - 2.6t^2 \Rightarrow v(t) = \frac{ds}{dt} = 64 - 5.2t$. The maximum height is reached when $v(t) = 0 \Rightarrow t \approx 12.31$ sec. The maximum height is about $s(12.31) = 393.85$ ft.
12. $s_1 = 3t^3 - 12t^2 + 18t + 5$ and $s_2 = -t^3 + 9t^2 - 12t \Rightarrow v_1 = 9t^2 - 24t + 18$ and $v_2 = -3t^2 + 18t - 12$; $v_1 = v_2 \Rightarrow 9t^2 - 24t + 18 = -3t^2 + 18t - 12 \Rightarrow 2t^2 - 7t + 5 = 0 \Rightarrow (t - 1)(2t - 5) = 0 \Rightarrow t = 1$ sec and $t = 2.5$ sec.
13. $m(v^2 - v_0^2) = k(x_0^2 - x^2) \Rightarrow m\left(2v\frac{dv}{dt}\right) = k\left(-2x\frac{dx}{dt}\right) \Rightarrow m\frac{dv}{dt} = k\left(-\frac{2x}{2v}\right)\frac{dx}{dt} \Rightarrow m\frac{dv}{dt} = -kx\left(\frac{1}{v}\right)\frac{dx}{dt}$. Then substituting $\frac{dx}{dt} = v \Rightarrow m\frac{dv}{dt} = -kx$, as claimed.
14. (a) $x = At^2 + Bt + C$ on $[t_1, t_2] \Rightarrow v = \frac{dx}{dt} = 2At + B \Rightarrow v\left(\frac{t_1+t_2}{2}\right) = 2A\left(\frac{t_1+t_2}{2}\right) + B = A(t_1 + t_2) + B$ is the instantaneous velocity at the midpoint. The average velocity over the time interval is $v_{av} = \frac{\Delta x}{\Delta t} = \frac{(At_2^2 + Bt_2 + C) - (At_1^2 + Bt_1 + C)}{t_2 - t_1} = \frac{(t_2 - t_1)[A(t_2 + t_1) + B]}{t_2 - t_1} = A(t_2 + t_1) + B$.

- (b) On the graph of the parabola $x = At^2 + Bt + C$, the slope of the curve at the midpoint of the interval $[t_1, t_2]$ is the same as the average slope of the curve over the interval.
15. (a) To be continuous at $x = \pi$ requires that $\lim_{x \rightarrow \pi^-} \sin x = \lim_{x \rightarrow \pi^+} (mx + b) \Rightarrow 0 = m\pi + b \Rightarrow m = -\frac{b}{\pi}$;
- (b) If $y' = \begin{cases} \cos x, & x < \pi \\ m, & x \geq \pi \end{cases}$ is differentiable at $x = \pi$, then $\lim_{x \rightarrow \pi^-} \cos x = m \Rightarrow m = -1$ and $b = \pi$.
16. $f(x)$ is continuous at 0 because $\lim_{x \rightarrow 0} \frac{1 - \cos x}{x} = 0 = f(0)$. $f'(0) = \lim_{x \rightarrow 0} \frac{f(x) - f(0)}{x - 0} = \lim_{x \rightarrow 0} \frac{1 - \cos x - 0}{x}$
 $= \lim_{x \rightarrow 0} \left(\frac{1 - \cos x}{x^2} \right) \left(\frac{1 + \cos x}{1 + \cos x} \right) = \lim_{x \rightarrow 0} \left(\frac{\sin x}{x} \right)^2 \left(\frac{1}{1 + \cos x} \right) = \frac{1}{2}$. Therefore $f'(0)$ exists with value $\frac{1}{2}$.
17. (a) For all a, b and for all $x \neq 2$, f is differentiable at x . Next, f differentiable at $x = 2 \Rightarrow f$ continuous at $x = 2 \Rightarrow \lim_{x \rightarrow 2^-} f(x) = f(2) \Rightarrow 2a = 4a - 2b + 3 \Rightarrow 2a - 2b + 3 = 0$. Also, f differentiable at $x \neq 2$
 $\Rightarrow f'(x) = \begin{cases} a, & x < 2 \\ 2ax - b, & x > 2 \end{cases}$. In order that $f'(2)$ exist we must have $a = 2a(2) - b \Rightarrow a = 4a - b \Rightarrow 3a = b$.
Then $2a - 2b + 3 = 0$ and $3a = b \Rightarrow a = \frac{3}{4}$ and $b = \frac{9}{4}$.
- (b) For $x < 2$, the graph of f is a straight line having a slope of $\frac{3}{4}$ and passing through the origin; for $x \geq 2$, the graph of f is a parabola. At $x = 2$, the value of the y -coordinate on the parabola is $\frac{3}{2}$ which matches the y -coordinate of the point on the straight line at $x = 2$. In addition, the slope of the parabola at the match up point is $\frac{3}{4}$ which is equal to the slope of the straight line. Therefore, since the graph is differentiable at the match up point, the graph is smooth there.
18. (a) For any a, b and for any $x \neq -1$, g is differentiable at x . Next, g differentiable at $x = -1 \Rightarrow g$ continuous at $x = -1 \Rightarrow \lim_{x \rightarrow -1^+} g(x) = g(-1) \Rightarrow -a - 1 + 2b = -a + b \Rightarrow b = 1$. Also, g differentiable at $x \neq -1$
 $\Rightarrow g'(x) = \begin{cases} a, & x < -1 \\ 3ax^2 + 1, & x > -1 \end{cases}$. In order that $g'(-1)$ exist we must have $a = 3a(-1)^2 + 1 \Rightarrow a = 3a + 1 \Rightarrow a = -\frac{1}{2}$.
- (b) For $x \leq -1$, the graph of g is a straight line having a slope of $-\frac{1}{2}$ and a y -intercept of 1. For $x > -1$, the graph of g is a cubic. At $x = -1$, the value of the y -coordinate on the cubic is $\frac{3}{2}$ which matches the y -coordinate of the point on the straight line at $x = -1$. In addition, the slope of the cubic at the match up point is $-\frac{1}{2}$ which is equal to the slope of the straight line. Therefore, since the graph is differentiable at the match up point, the graph is smooth there.
19. f odd $\Rightarrow f(-x) = -f(x) \Rightarrow \frac{d}{dx}(f(-x)) = \frac{d}{dx}(-f(x)) \Rightarrow f'(-x)(-1) = -f'(x) \Rightarrow f'(-x) = f'(x) \Rightarrow f'$ is even.
20. f even $\Rightarrow f(-x) = f(x) \Rightarrow \frac{d}{dx}(f(-x)) = \frac{d}{dx}(f(x)) \Rightarrow f'(-x)(-1) = f'(x) \Rightarrow f'(-x) = -f'(x) \Rightarrow f'$ is odd.
21. Let $h(x) = (fg)(x) = f(x)g(x) \Rightarrow h'(x) = \lim_{x \rightarrow x_0} \frac{h(x) - h(x_0)}{x - x_0} = \lim_{x \rightarrow x_0} \frac{f(x)g(x) - f(x_0)g(x_0)}{x - x_0} =$
 $\lim_{x \rightarrow x_0} \frac{f(x)g(x) - f(x)g(x_0) + f(x)g(x_0) - f(x_0)g(x_0)}{x - x_0} = \lim_{x \rightarrow x_0} \left[f(x) \left[\frac{g(x) - g(x_0)}{x - x_0} \right] \right] + \lim_{x \rightarrow x_0} \left[g(x_0) \left[\frac{f(x) - f(x_0)}{x - x_0} \right] \right]$
 $= f(x_0) \lim_{x \rightarrow x_0} \left[\frac{g(x) - g(x_0)}{x - x_0} \right] + g(x_0) f'(x_0) = 0 \cdot \lim_{x \rightarrow x_0} \left[\frac{g(x) - g(x_0)}{x - x_0} \right] + g(x_0) f'(x_0) = g(x_0) f'(x_0)$, if g is continuous at x_0 . Therefore $(fg)(x)$ is differentiable at x_0 if $f(x_0) = 0$, and $(fg)'(x_0) = g(x_0) f'(x_0)$.

22. From Exercise 21 we have that fg is differentiable at 0 if f is differentiable at 0, $f(0) = 0$ and g is continuous at 0.
- (a) If $f(x) = \sin x$ and $g(x) = |x|$, then $|x| \sin x$ is differentiable because $f'(0) = \cos(0) = 1$, $f(0) = \sin(0) = 0$ and $g(x) = |x|$ is continuous at $x = 0$.
- (b) If $f(x) = \sin x$ and $g(x) = x^{2/3}$, then $x^{2/3} \sin x$ is differentiable because $f'(0) = \cos(0) = 1$, $f(0) = \sin(0) = 0$ and $g(x) = x^{2/3}$ is continuous at $x = 0$.
- (c) If $f(x) = 1 - \cos x$ and $g(x) = \sqrt[3]{x}$, then $\sqrt[3]{x}(1 - \cos x)$ is differentiable because $f'(0) = \sin(0) = 0$, $f(0) = 1 - \cos(0) = 0$ and $g(x) = x^{1/3}$ is continuous at $x = 0$.
- (d) If $f(x) = x$ and $g(x) = x \sin\left(\frac{1}{x}\right)$, then $x^2 \sin\left(\frac{1}{x}\right)$ is differentiable because $f'(0) = 1$, $f(0) = 0$ and

$$\lim_{x \rightarrow 0} x \sin\left(\frac{1}{x}\right) = \lim_{x \rightarrow 0} \frac{\sin\left(\frac{1}{x}\right)}{\frac{1}{x}} = \lim_{x \rightarrow \infty} \frac{\sin t}{t} = 0 \text{ (so } g \text{ is continuous at } x = 0 \text{)}.$$

23. If $f(x) = x$ and $g(x) = x \sin\left(\frac{1}{x}\right)$, then $x^2 \sin\left(\frac{1}{x}\right)$ is differentiable at $x = 0$ because $f'(0) = 1$, $f(0) = 0$ and

$$\lim_{x \rightarrow 0} x \sin\left(\frac{1}{x}\right) = \lim_{x \rightarrow 0} \frac{\sin\left(\frac{1}{x}\right)}{\frac{1}{x}} = \lim_{t \rightarrow \infty} \frac{\sin t}{t} = 0 \text{ (so } g \text{ is continuous at } x = 0 \text{)}. \text{ In fact, from Exercise 21,}$$

$$h'(0) = g(0)f'(0) = 0. \text{ However, for } x \neq 0, h'(x) = \left[x^2 \cos\left(\frac{1}{x}\right)\right] \left(-\frac{1}{x^2}\right) + 2x \sin\left(\frac{1}{x}\right). \text{ But}$$

$$\lim_{x \rightarrow 0} h'(x) = \lim_{x \rightarrow 0} \left[-\cos\left(\frac{1}{x}\right) + 2x \sin\left(\frac{1}{x}\right)\right] \text{ does not exist because } \cos\left(\frac{1}{x}\right) \text{ has no limit as } x \rightarrow 0. \text{ Therefore, the derivative is not continuous at } x = 0 \text{ because it has no limit there.}$$

24. From the given conditions we have $f(x+h) = f(x)f(h)$, $f(h) - 1 = hg(h)$ and $\lim_{h \rightarrow 0} g(h) = 1$. Therefore,

$$f'(x) = \lim_{h \rightarrow 0} \frac{f(x+h) - f(x)}{h} = \lim_{h \rightarrow 0} \frac{f(x)f(h) - f(x)}{h} = \lim_{h \rightarrow 0} f(x) \left[\frac{f(h) - 1}{h} \right] = f(x) \left[\lim_{h \rightarrow 0} g(h) \right] = f(x) \cdot 1 = f(x) \\ \Rightarrow f'(x) = f(x) \text{ and } f'(x) \text{ exists at every value of } x.$$

25. Step 1: The formula holds for $n = 2$ (a single product) since $y = u_1 u_2 \Rightarrow \frac{dy}{dx} = \frac{du_1}{dx} u_2 + u_1 \frac{du_2}{dx}$.

Step 2: Assume the formula holds for $n = k$:

$$y = u_1 u_2 \cdots u_k \Rightarrow \frac{dy}{dx} = \frac{du_1}{dx} u_2 u_3 \cdots u_k + u_1 \frac{du_2}{dx} u_3 \cdots u_k + \cdots + u_1 u_2 \cdots u_{k-1} \frac{du_k}{dx}.$$

$$\text{If } y = u_1 u_2 \cdots u_k u_{k+1} = (u_1 u_2 \cdots u_k) u_{k+1}, \text{ then } \frac{dy}{dx} = \frac{d(u_1 u_2 \cdots u_k)}{dx} u_{k+1} + u_1 u_2 \cdots u_k \frac{du_{k+1}}{dx}$$

$$= \left(\frac{du_1}{dx} u_2 u_3 \cdots u_k + u_1 \frac{du_2}{dx} u_3 \cdots u_k + \cdots + u_1 u_2 \cdots u_{k-1} \frac{du_k}{dx} \right) u_{k+1} + u_1 u_2 \cdots u_k \frac{du_{k+1}}{dx}$$

$$= \frac{du_1}{dx} u_2 u_3 \cdots u_{k+1} + u_1 \frac{du_2}{dx} u_3 \cdots u_{k+1} + \cdots + u_1 u_2 \cdots u_{k-1} \frac{du_k}{dx} u_{k+1} + u_1 u_2 \cdots u_k \frac{du_{k+1}}{dx}.$$

Thus the original formula holds for $n = (k + 1)$ whenever it holds for $n = k$.

26. Recall $\binom{m}{k} = \frac{m!}{k!(m-k)!}$. Then $\binom{m}{1} = \frac{m!}{1!(m-1)!} = m$ and $\binom{m}{k} + \binom{m}{k+1} = \frac{m!}{k!(m-k)!} + \frac{m!}{(k+1)!(m-k-1)!} = \frac{m!(k+1)+m!(m-k)}{(k+1)!(m-k)!}$
 $= \frac{m!(m+1)}{(k+1)!(m-k)!} = \frac{(m+1)!}{(k+1)!(m-k-1)!} = \binom{m+1}{k+1}$. Now, we prove Leibniz's rule by mathematical induction.

Step 1: If $n = 1$, then $\frac{d(uv)}{dx} = u \frac{dv}{dx} + v \frac{du}{dx}$. Assume that the statement is true for $n = k$, that is:

$$\frac{d^k(uv)}{dx^k} = \frac{d^k u}{dx^k} v + k \frac{d^{k-1} u}{dx^{k-1}} \frac{dv}{dx} + \binom{k}{2} \frac{d^{k-2} u}{dx^{k-2}} \frac{d^2 v}{dx^2} + \cdots + \binom{k}{k-1} \frac{du}{dx} \frac{d^{k-1} v}{dx^{k-1}} + u \frac{d^k v}{dx^k}.$$

Step 2: If $n = k + 1$, then $\frac{d^{k+1}(uv)}{dx^{k+1}} = \frac{d}{dx} \left(\frac{d^k(uv)}{dx^k} \right) = \left[\frac{d^{k+1} u}{dx^{k+1}} v + \frac{d^k u}{dx^k} \frac{dv}{dx} \right] + \left[k \frac{d^k u}{dx^k} \frac{dv}{dx} + k \frac{d^{k+1} u}{dx^{k+1}} \frac{d^2 v}{dx^2} \right]$

$$+ \left[\binom{k}{2} \frac{d^{k-1} u}{dx^{k-1}} \frac{d^2 v}{dx^2} + \binom{k}{2} \frac{d^{k-2} u}{dx^{k-2}} \frac{d^3 v}{dx^3} \right] + \cdots + \left[\binom{k}{k-1} \frac{d^2 u}{dx^2} \frac{d^{k-1} v}{dx^{k-1}} + \binom{k}{k-1} \frac{du}{dx} \frac{d^k v}{dx^k} \right]$$

$$+ \left[\frac{du}{dx} \frac{d^k v}{dx^k} + u \frac{d^{k+1} v}{dx^{k+1}} \right] = \frac{d^{k+1} u}{dx^{k+1}} v + (k+1) \frac{d^k u}{dx^k} \frac{dv}{dx} + \left[\binom{k}{1} + \binom{k}{2} \right] \frac{d^{k-1} u}{dx^{k-1}} \frac{d^2 v}{dx^2} + \cdots$$

$$\begin{aligned}
& + \left[\binom{k}{k-1} + \binom{k}{k} \right] \frac{du}{dx} \frac{d^k v}{dx^k} + u \frac{d^{k+1} v}{dx^{k+1}} = \frac{d^{k+1} u}{dx^{k+1}} v + (k+1) \frac{d^k u}{dx^k} \frac{dv}{dx} + \binom{k+1}{2} \frac{d^{k-1} u}{dx^{k-1}} \frac{d^2 v}{dx^2} + \dots \\
& + \binom{k+1}{k} \frac{du}{dx} \frac{d^k v}{dx^k} + u \frac{d^{k+1} v}{dx^{k+1}}.
\end{aligned}$$

Therefore the formula (c) holds for $n = (k+1)$ whenever it holds for $n = k$.

27. (a) $T^2 = \frac{4\pi^2 L}{g} \Rightarrow L = \frac{T^2 g}{4\pi^2} \Rightarrow L = \frac{(1 \text{ sec}^2)(32.2 \text{ ft/sec}^2)}{4\pi^2} \Rightarrow L \approx 0.8156 \text{ ft}$
- (b) $T^2 = \frac{4\pi^2 L}{g} \Rightarrow T = \frac{2\pi}{\sqrt{g}} \sqrt{L}$; $dT = \frac{2\pi}{\sqrt{g}} \cdot \frac{1}{2\sqrt{L}} dL = \frac{\pi}{\sqrt{Lg}} dL$; $dT = \frac{\pi}{\sqrt{(0.8156 \text{ ft})(32.2 \text{ ft/sec}^2)}} (0.01 \text{ ft}) \approx 0.00613 \text{ sec}$.
- (c) Since there are 86,400 sec in a day, we have we have $(0.00613 \text{ sec})(86,400 \text{ sec/day}) \approx 529.6 \text{ sec/day}$, or 8.83 min/day; the clock will lose about 8.83 min/day.
28. $v = s^3 \Rightarrow \frac{dv}{dt} = 3s^2 \frac{ds}{dt} = -k(6s^2) \Rightarrow \frac{ds}{dt} = -2k$. If s_0 = the initial length of the cube's side, then $s_1 = s_0 - 2k$
 $\Rightarrow 2k = s_0 - s_1$. Let t = the time it will take the ice cube to melt. Now, $t = \frac{s_0}{2k} = \frac{s_0}{s_0 - s_1} = \frac{(v_0)^{1/3}}{(v_0)^{1/3} - (\frac{3}{4}v_0)^{1/3}}$
 $= \frac{1}{1 - (\frac{3}{4})^{1/3}} \approx 11 \text{ hr}$.

CHAPTER 4 APPLICATIONS OF DERIVATIVES

4.1 EXTREME VALUES OF FUNCTIONS

1. An absolute minimum at $x = c_2$, an absolute maximum at $x = b$. Theorem 1 guarantees the existence of such extreme values because h is continuous on $[a, b]$.
2. An absolute minimum at $x = b$, an absolute maximum at $x = c$. Theorem 1 guarantees the existence of such extreme values because f is continuous on $[a, b]$.
3. No absolute minimum. An absolute maximum at $x = c$. Since the function's domain is an open interval, the function does not satisfy the hypotheses of Theorem 1 and need not have absolute extreme values.
4. No absolute extrema. The function is neither continuous nor defined on a closed interval, so it need not fulfill the conclusions of Theorem 1.
5. An absolute minimum at $x = a$ and an absolute maximum at $x = c$. Note that $y = g(x)$ is not continuous but still has extrema. When the hypothesis of Theorem 1 is satisfied then extrema are guaranteed, but when the hypothesis is not satisfied, absolute extrema may or may not occur.
6. Absolute minimum at $x = c$ and an absolute maximum at $x = a$. Note that $y = g(x)$ is not continuous but still has absolute extrema. When the hypothesis of Theorem 1 is satisfied then extrema are guaranteed, but when the hypothesis is not satisfied, absolute extrema may or may not occur.
7. Local minimum at $(-1, 0)$, local maximum at $(1, 0)$.
8. Minima at $(-2, 0)$ and $(2, 0)$, maximum at $(0, 2)$.
9. Maximum at $(0, 5)$. Note that there is no minimum since the endpoint $(2, 0)$ is excluded from the graph.
10. Local maximum at $(-3, 0)$, local minimum at $(2, 0)$, maximum at $(1, 2)$, minimum at $(0, -1)$.
11. Graph (c), since this is the only graph that has positive slope at c .
12. Graph (b), since this is the only graph that represents a differentiable function at a and b and has negative slope at c .
13. Graph (d), since this is the only graph representing a function that is differentiable at b but not at a .
14. Graph (a), since this is the only graph that represents a function that is not differentiable at a or b .
15. f has an absolute min at $x = 0$ but does not have an absolute max. Since the interval on which f is defined, $-1 < x < 2$, is an open interval, we do not meet the conditions of Theorem 1.

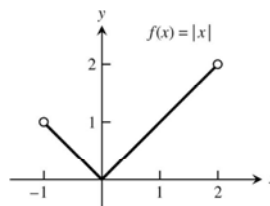

16. f has an absolute max at $x = 0$ but does not have an absolute min. Since the interval on which f is defined, $-1 < x < 1$, is an open interval, we do not meet the conditions of Theorem 1.

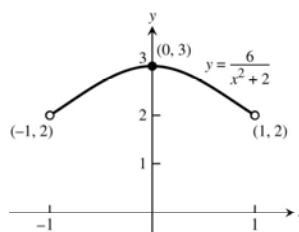

17. f has an absolute max at $x = 2$ but does not have an absolute min. Since the function is not continuous at $x = 1$, we do not meet the conditions of Theorem 1.

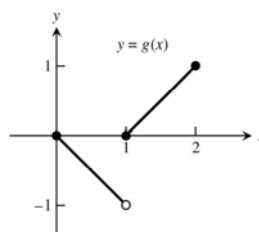

18. f has an absolute max at $x = 4$ but does not have an absolute min. Since the function is not continuous at $x = 0$, we do not meet the conditions of Theorem 1.

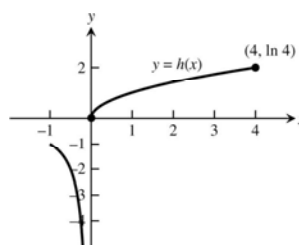

19. f has an absolute max at $x = \frac{\pi}{2}$ and an absolute min at $x = \frac{3\pi}{2}$. Since the interval on which f is defined, $0 < x < 2\pi$, is an open interval we do not meet the conditions of Theorem 1.

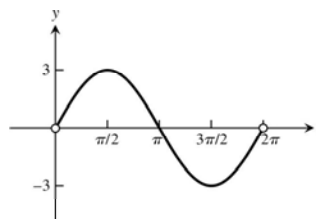

20. f has an absolute max at $x = 0$ and an absolute min at $x = \frac{\pi}{2}$ and $x = -1$ but does not have an absolute maximum. Since f is defined on a union of half-open intervals, we do not meet the conditions of Theorem 1.

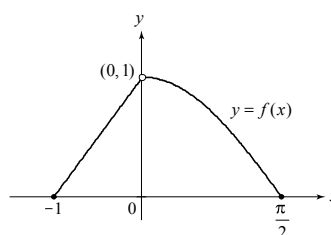

21. $f(x) = \frac{2}{3}x - 5 \Rightarrow f'(x) = \frac{2}{3} \Rightarrow$ no critical points;
 $f(-2) = -\frac{19}{3}$, $f(3) = -3 \Rightarrow$ the absolute maximum is -3 at $x = 3$ and the absolute minimum is $-\frac{19}{3}$ at $x = -2$

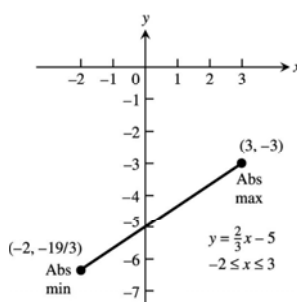

22. $f(x) = -x - 4 \Rightarrow f'(x) = -1 \Rightarrow$ no critical points;
 $f(-4) = 0, f(1) = -5 \Rightarrow$ the absolute maximum is 0
 at $x = -4$ and the absolute minimum is -5 at $x = 1$

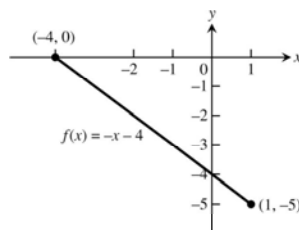

23. $f(x) = x^2 - 1 \Rightarrow f'(x) = 2x \Rightarrow$ a critical point at
 $x = 0; f(-1) = 0, f(0) = -1, f(2) = 3 \Rightarrow$ the absolute
 maximum is 3 at $x = 2$ and the absolute minimum is
 -1 at $x = 0$

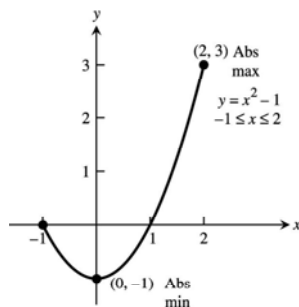

24. $f(x) = 4 - x^3 \Rightarrow f'(x) = -3x^2 \Rightarrow$ a critical point at
 $x = 0; f(-2) = 12, f(0) = 4, f(1) = 3 \Rightarrow$ the absolute
 maximum is 12 at $x = -2$ and the absolute
 minimum is 3 at $x = 1$

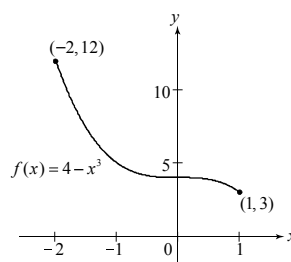

25. $F(x) = -\frac{1}{x^2} = -x^{-2} \Rightarrow F'(x) = 2x^{-3} = \frac{2}{x^3}$, however
 $x = 0$ is not a critical point since 0 is not in the domain;
 $F(0.5) = -4, F(2) = -0.25 \Rightarrow$ the absolute maximum
 is -0.25 at $x = 2$ and the absolute minimum is -4 at
 $x = 0.5$

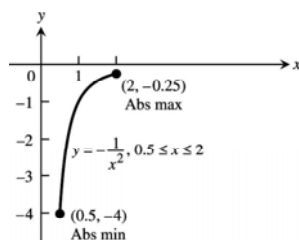

26. $F(x) = -\frac{1}{x} = -x^{-1} \Rightarrow F'(x) = x^{-2} = \frac{1}{x^2}$, however
 $x = 0$ is not a critical point since 0 is not in the
 domain; $F(-2) = \frac{1}{2}, F(-1) = 1 \Rightarrow$ the absolute
 maximum is 1 at $x = -1$ and the absolute minimum
 is $\frac{1}{2}$ at $x = -2$

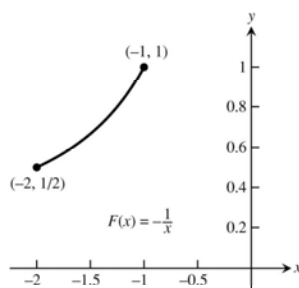

27. $h(x) = \sqrt[3]{x} = x^{1/3} \Rightarrow h'(x) = \frac{1}{3}x^{-2/3} \Rightarrow$ a critical point at $x = 0$; $h(-1) = -1$, $h(0) = 0$, $h(8) = 2 \Rightarrow$ the absolute maximum is 2 at $x = 8$ and the absolute minimum is -1 at $x = -1$

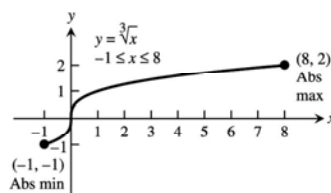

28. $h(x) = -3x^{2/3} \Rightarrow h'(x) = -2x^{-1/3} \Rightarrow$ a critical point at $x = 0$; $h(-1) = -3$, $h(0) = 0$, $h(1) = -3 \Rightarrow$ the absolute maximum is 0 at $x = 0$ and the absolute minimum is -3 at $x = 1$ and $x = -1$

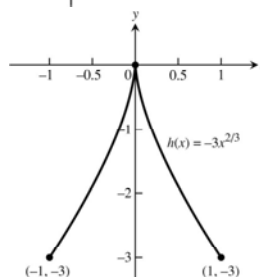

29. $g(x) = \sqrt{4-x^2} = (4-x^2)^{1/2}$
 $\Rightarrow g'(x) = \frac{1}{2}(4-x^2)^{-1/2}(-2x) = \frac{-x}{\sqrt{4-x^2}} \Rightarrow$ critical points at $x = -2$ and $x = 0$, but not at $x = 2$ because 2 is not in the domain;
 $g(-2) = 0$, $g(0) = 2$, $g(1) = \sqrt{3} \Rightarrow$ the absolute maximum is 2 at $x = 0$ and the absolute minimum is 0 at $x = -2$

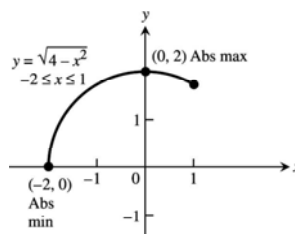

30. $g(x) = -\sqrt{5-x^2} = -(5-x^2)^{1/2}$
 $\Rightarrow g'(x) = -\left(\frac{1}{2}\right)(5-x^2)^{-1/2}(-2x) = \frac{x}{\sqrt{5-x^2}}$
 \Rightarrow critical points at $x = -\sqrt{5}$ and $x = 0$, but not at $x = \sqrt{5}$ because $\sqrt{5}$ is not in the domain;
 $f(-\sqrt{5}) = 0$, $f(0) = -\sqrt{5}$
 \Rightarrow the absolute maximum is 0 at $x = -\sqrt{5}$ and the absolute minimum is $-\sqrt{5}$ at $x = 0$

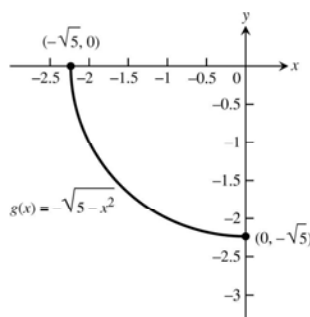

31. $f(\theta) = \sin \theta \Rightarrow f'(\theta) = \cos \theta \Rightarrow \theta = \frac{\pi}{2}$ is a critical point, but $\theta = \frac{-\pi}{2}$ is not a critical point because $\frac{-\pi}{2}$ is not interior to the domain; $f\left(\frac{-\pi}{2}\right) = -1$, $f\left(\frac{\pi}{2}\right) = 1$, $f\left(\frac{5\pi}{6}\right) = \frac{1}{2} \Rightarrow$ the absolute maximum is 1 at $\theta = \frac{\pi}{2}$ and the absolute minimum is -1 at $\theta = \frac{-\pi}{2}$

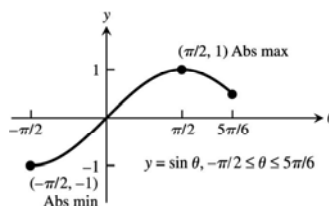

32. $f(\theta) = \tan \theta \Rightarrow f'(\theta) = \sec^2 \theta \Rightarrow f$ has no critical points in $\left(\frac{-\pi}{3}, \frac{\pi}{4}\right)$. The extreme values therefore occur at the endpoints: $f\left(\frac{-\pi}{3}\right) = -\sqrt{3}$ and $f\left(\frac{\pi}{4}\right) = 1$
 \Rightarrow the absolute maximum is 1 at $\theta = \frac{\pi}{4}$ and the absolute minimum is $-\sqrt{3}$ at $\theta = \frac{-\pi}{3}$

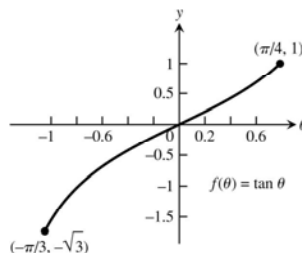

33. $g(x) = \csc x \Rightarrow g'(x) = -(\csc x)(\cot x) \Rightarrow$ a critical point at $x = \frac{\pi}{2}; g(\frac{\pi}{3}) = \frac{2}{\sqrt{3}}, g(\frac{\pi}{2}) = 1, g(\frac{2\pi}{3}) = \frac{2}{\sqrt{3}} \Rightarrow$ the absolute maximum is $\frac{2}{\sqrt{3}}$ at $x = \frac{\pi}{3}$ and $x = \frac{2\pi}{3}$, and the absolute minimum is 1 at $x = \frac{\pi}{2}$

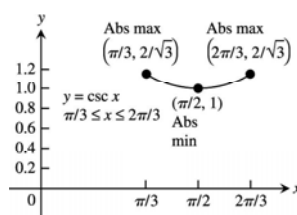

34. $g(x) = \sec x \Rightarrow g'(x) = (\sec x)(\tan x) \Rightarrow$ a critical point at $x = 0; g(-\frac{\pi}{3}) = 2, g(0) = 1, g(\frac{\pi}{6}) = \frac{2}{\sqrt{3}} \Rightarrow$ the absolute maximum is 2 at $x = -\frac{\pi}{3}$ and the absolute minimum is 1 at $x = 0$

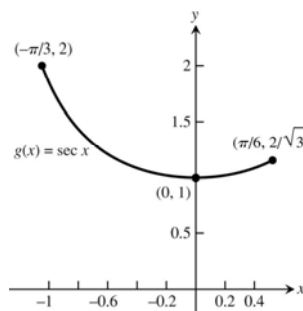

35. $f(t) = 2 - |t| = 2 - \sqrt{t^2} = 2 - (t^2)^{1/2} \Rightarrow f'(t) = -\frac{1}{2}(t^2)^{-1/2}(2t) = -\frac{t}{\sqrt{t^2}} = -\frac{t}{|t|} \Rightarrow$ a critical point at $t = 0; f(-1) = 1, f(0) = 2, f(3) = -1 \Rightarrow$ the absolute maximum is 2 at $t = 0$ and the absolute minimum is -1 at $t = 3$

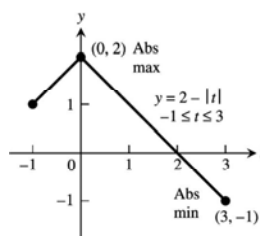

36. $f(t) = |t - 5| = \sqrt{(t - 5)^2} = ((t - 5)^2)^{1/2} \Rightarrow f'(t) = \frac{1}{2}((t - 5)^2)^{-1/2}(2(t - 5)) = \frac{t - 5}{\sqrt{(t - 5)^2}} = \frac{t - 5}{|t - 5|} \Rightarrow$ a critical point at $t = 5; f(4) = 1, f(5) = 0, f(7) = 2 \Rightarrow$ the absolute maximum is 2 at $t = 7$ and the absolute minimum is 0 at $t = 5$

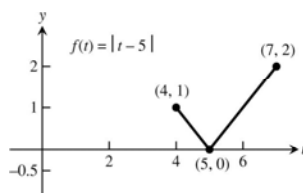

37. $g(x) = xe^{-x} \Rightarrow g'(x) = e^{-x} - xe^{-x} \Rightarrow$ a critical point at $x = 1; g(-1) = -e$, and $g(1) = \frac{1}{e} \Rightarrow$ the absolute maximum is $\frac{1}{e}$ at $x = 1$ and the absolute minimum is $-e$ at $x = -1$

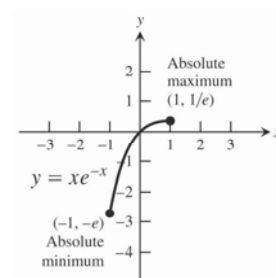

38. The first derivative $h'(x) = \frac{1}{x+1}$ has no zeros, so we need only consider the endpoints, $h(0) = \ln 1; h(3) = \ln 4$
Maximum value is $\ln 4$ at $x = 3$;
Minimum value is $\ln 1$ at $x = 0$.

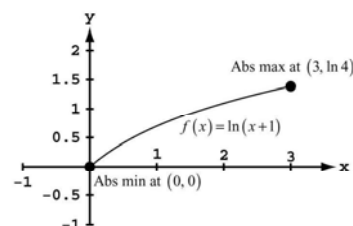

39. The first derivative $f'(x) = -\frac{1}{x^2} + \frac{1}{x}$ has a zero at $x = 1$.

Critical point value: $f(1) = 1 + \ln 1 = 1$

Endpoint values: $f(0.5) = 2 + \ln 0.5 \approx 1.307$;

$$f(4) = \frac{1}{4} + \ln 4 \approx 1.636;$$

Absolute maximum value is $\frac{1}{4} + \ln 4$ at $x = 4$;

Absolute Minimum value is 1 at $x = 1$;

Local maximum at $(\frac{1}{2}, 2 - \ln 2)$

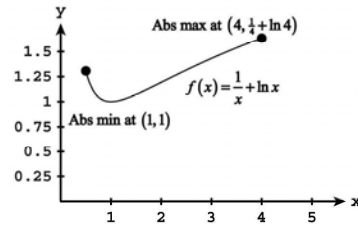

40. $g(x) = e^{-x^2} \Rightarrow g'(x) = -2xe^{-x^2} \Rightarrow$ a critical point at

$$x = 0; g(-2) = e^{-4}, g(0) = 1, \text{ and } g(1) = e^{-1}$$

\Rightarrow the absolute maximum is 1 at $x = 0$ and the

absolute minimum is e^{-4} at $x = -2$

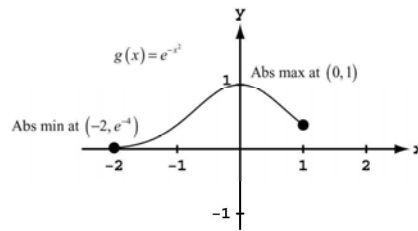

41. $f(x) = x^{4/3} \Rightarrow f'(x) = \frac{4}{3}x^{1/3} \Rightarrow$ a critical point at $x = 0$; $f(-1) = 1, f(0) = 0, f(8) = 16 \Rightarrow$ the absolute maximum is 16 at $x = 8$ and the absolute minimum is 0 at $x = 0$

42. $f(x) = x^{5/3} \Rightarrow f'(x) = \frac{5}{3}x^{2/3} \Rightarrow$ a critical point at $x = 0$; $f(-1) = -1, f(0) = 0, f(8) = 32 \Rightarrow$ the absolute maximum is 32 at $x = 8$ and the absolute minimum is -1 at $x = -1$

43. $g(\theta) = \theta^{3/5} \Rightarrow g'(\theta) = \frac{3}{5}\theta^{-2/5} \Rightarrow$ a critical point at $\theta = 0$; $g(-32) = -8, g(0) = 0, g(1) = 1 \Rightarrow$ the absolute maximum is 1 at $\theta = 1$ and the absolute minimum is -8 at $\theta = -32$

44. $h(\theta) = 3\theta^{2/3} \Rightarrow h'(\theta) = 2\theta^{-1/3} \Rightarrow$ a critical point at $\theta = 0$; $h(-27) = 27, h(0) = 0, h(8) = 12 \Rightarrow$ the absolute maximum is 27 at $\theta = -27$ and the absolute minimum is 0 at $\theta = 0$

45. $y = x^2 - 6x + 7 \Rightarrow y' = 2x - 6 \Rightarrow 2x - 6 = 0 \Rightarrow x = 3$. The critical point is $x = 3$.

46. $f(x) = 6x^2 - x^3 \Rightarrow f'(x) = 12x - 3x^2 \Rightarrow 12x - 3x^2 = 0 \Rightarrow 3x(4 - x) = 0 \Rightarrow x = 0$ or $x = 4$. The critical points are $x = 0$ and $x = 4$.

47. $f(x) = x(4 - x)^3 \Rightarrow f'(x) = x[3(4 - x)^2(-1)] + (4 - x)^3 = (4 - x)^2[-3x + (4 - x)] = (4 - x)^2(4 - 4x) = 4(4 - x)^2(1 - x) \Rightarrow 4(4 - x)^2(1 - x) = 0 \Rightarrow x = 1$ or $x = 4$. The critical points are $x = 1$ and $x = 4$.

48. $g(x) = (x - 1)^2(x - 3)^2 \Rightarrow g'(x) = (x - 1)^2 \cdot 2(x - 3)(1) + 2(x - 1)(1) \cdot (x - 3)^2 = 2(x - 3)(x - 1)[(x - 1) + (x - 3)] = 4(x - 3)(x - 1)(x - 2) \Rightarrow 4(x - 3)(x - 1)(x - 2) = 0 \Rightarrow x = 3$ or $x = 1$ or $x = 2$. The critical points are $x = 1, x = 2,$ and $x = 3$.

49. $y = x^2 + \frac{2}{x} \Rightarrow y' = 2x - \frac{2}{x^2} = \frac{2x^3 - 2}{x^2} \Rightarrow \frac{2x^3 - 2}{x^2} = 0 \Rightarrow 2x^3 - 2 = 0 \Rightarrow x = 1; \frac{2x^3 - 2}{x^2} = \text{undefined} \Rightarrow x^2 = 0 \Rightarrow x = 0$. The domain of the function is $(-\infty, 0) \cup (0, \infty)$, thus $x = 0$ is not the domain, so the only critical point is $x = 1$.

50. $f(x) = \frac{x^2}{x-2} \Rightarrow f'(x) = \frac{(x-2)2x-x^2(1)}{(x-2)^2} = \frac{x^2-4x}{(x-2)^2} \Rightarrow \frac{x^2-4x}{(x-2)^2} = 0 \Rightarrow x^2 - 4x = 0 \Rightarrow x = 0$ or $x = 4$; $\frac{x^2-4x}{(x-2)^2}$ is undefined $\Rightarrow (x-2)^2 = 0 \Rightarrow x = 2$. The domain of the function is $(-\infty, 2) \cup (2, \infty)$, thus $x = 2$ is not the domain, so the only critical points are $x = 0$ and $x = 4$

51. $y = x^2 - 32\sqrt{x} \Rightarrow y' = 2x - \frac{16}{\sqrt{x}} = \frac{2x^{3/2}-16}{\sqrt{x}} \Rightarrow \frac{2x^{3/2}-16}{\sqrt{x}} = 0 \Rightarrow 2x^{3/2} - 16 = 0 \Rightarrow x = 4$; $\frac{2x^{3/2}-16}{\sqrt{x}}$ is undefined $\Rightarrow \sqrt{x} = 0 \Rightarrow x = 0$. The critical points are $x = 4$ and $x = 0$.

52. $g(x) = \sqrt{2x-x^2} \Rightarrow g'(x) = \frac{1-x}{\sqrt{2x-x^2}} \Rightarrow \frac{1-x}{\sqrt{2x-x^2}} = 0 \Rightarrow 1-x = 0 \Rightarrow x = 1$; $\frac{1-x}{\sqrt{2x-x^2}}$ is undefined $\Rightarrow \sqrt{2x-x^2} = 0 \Rightarrow 2x-x^2 = 0 \Rightarrow x = 0$ or $x = 2$. The critical points are $x = 0$, $x = 1$, and $x = 2$.

53. Minimum value is 1 at $x = 2$.

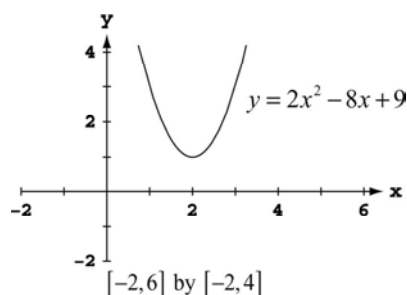

54. To find the exact values, note that $y' = 3x^2 - 2$, which is zero when $x = \pm\sqrt{\frac{2}{3}}$. Local maximum at $(-\sqrt{\frac{2}{3}}, 4 + \frac{4\sqrt{6}}{9}) \approx (-0.816, 5.089)$; local minimum at $(\sqrt{\frac{2}{3}}, 4 - \frac{4\sqrt{6}}{9}) \approx (0.816, 2.911)$

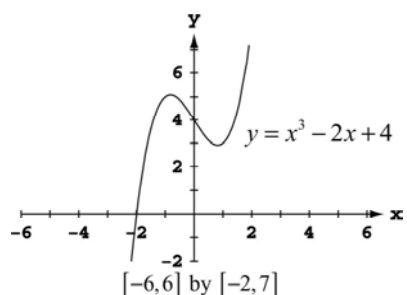

55. To find the exact values, note that $y' = 3x^2 + 2x - 8 = (3x-4)(x+2)$, which is zero when $x = -2$ or $x = \frac{4}{3}$. Local maximum at $(-2, 17)$; local minimum at $(\frac{4}{3}, -\frac{41}{27})$

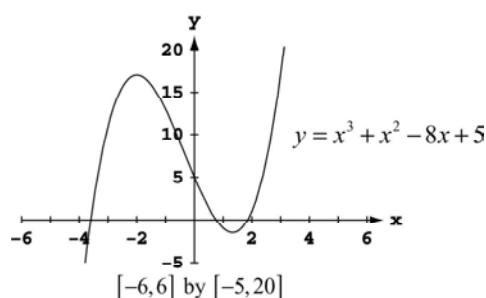

56. Note that $y' = 5x^2(x-5)(x-3)$, which is zero at $x = 0$, $x = 3$, and $x = 5$. Local maximum at $(3, 108)$; local minimum at $(5, 0)$; $(0, 0)$ is neither a maximum nor a minimum.

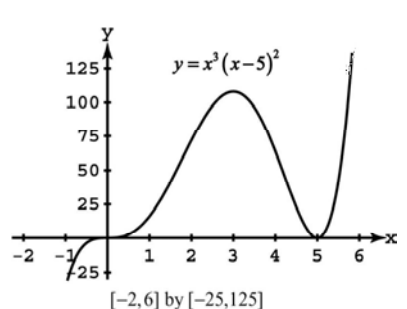

57. Minimum value is 0 when $x = -1$ or $x = 1$.

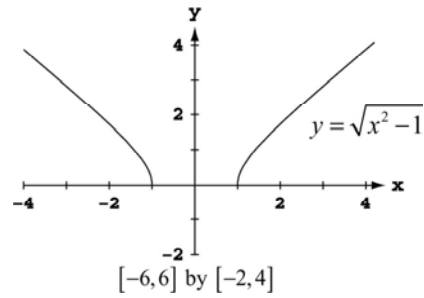

58. Note that $y' = \frac{\sqrt{x}-2}{\sqrt{x}}$, which is zero at $x = 4$ and is undefined when $x = 0$. Local maximum at $(0, 0)$; absolute minimum at $(4, -4)$

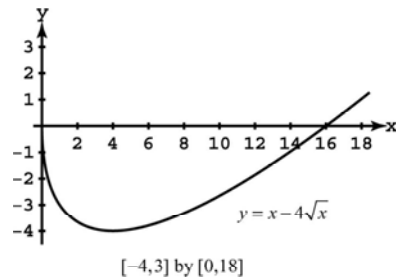

59. The actual graph of the function has asymptotes at $x = \pm 1$, so there are no extrema near these values. (This is an example of grapher failure.) There is a local minimum at $(0, 1)$.

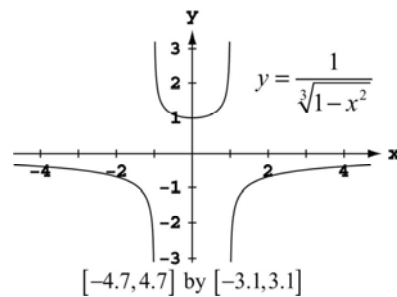

60. Maximum value is 2 at $x = 1$;
minimum value is 0 at $x = -1$ and $x = 3$.

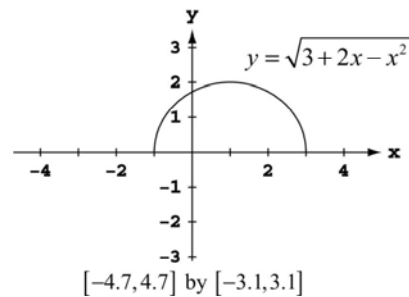

61. Maximum value is $\frac{1}{2}$ at $x = 1$;
minimum value is $-\frac{1}{2}$ at $x = -1$.

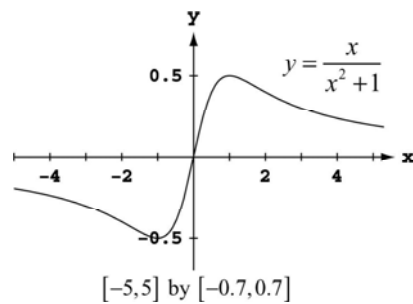

62. Maximum value is $\frac{1}{2}$ at $x = 0$;
minimum value is $-\frac{1}{2}$ at $x = -2$.

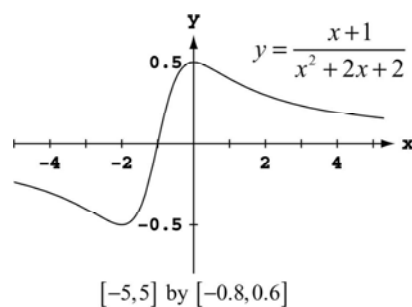

63. $y = e^x + e^{-x} \Rightarrow y' = e^x - e^{-x} = e^x - \frac{1}{e^x} = \frac{e^{2x} - 1}{e^x}$,
which is 0 at $x = 0$; an absolute minimum value is 2 at $x = 0$.

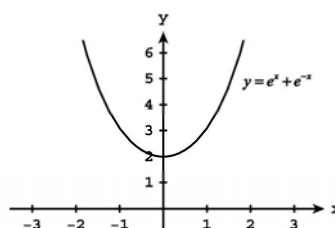

64. $y = e^x - e^{-x} \Rightarrow y' = e^x - (-e^{-x}) = e^x + \frac{1}{e^x} = \frac{e^{2x} + 1}{e^x}$,
which is never zero; there are no extreme values.

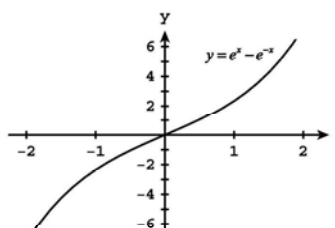

65. $y = x \ln x \Rightarrow y' = x \cdot \frac{1}{x} + (1) \cdot \ln x = 1 + \ln x$, which is
zero at $x = e^{-1}$; an absolute minimum value is $-\frac{1}{e}$ at
 $x = \frac{1}{e}$

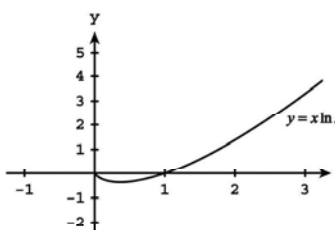

66. $y = x^2 \ln x \Rightarrow y' = x^2 \cdot \frac{1}{x} + 2x \cdot \ln x = x(1 + 2 \ln x)$,
which is zero at $x = e^{-1/2}$; an absolute minimum
value is $-\frac{1}{2e}$ at $x = \frac{1}{\sqrt{e}}$

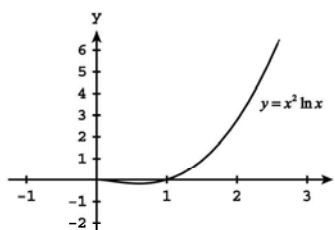

67. $y = \cos^{-1}(x^2) \Rightarrow y' = \frac{-1}{\sqrt{1-(x^2)^2}} \cdot (2x) = \frac{-2x}{\sqrt{1-x^4}}$, which is zero at $x = 0$; an absolute maximum value is $\frac{\pi}{2}$ at $x = 0$; an absolute minimum value is 0 at $x = 1$ and $x = -1$.

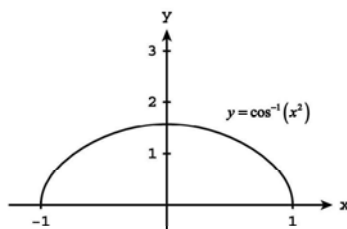

68. $y = \sin^{-1}(e^x) \Rightarrow y' = \frac{1}{\sqrt{1-(e^x)^2}} \cdot (e^x) = \frac{e^x}{\sqrt{1-e^{2x}}}$, which is never zero; an absolute maximum value is $\frac{\pi}{2}$ at $x = 0$.

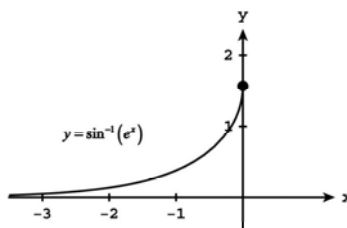

69. $y' = x^{2/3}(1) + \frac{2}{3}x^{-1/3}(x+2) = \frac{5x+4}{3\sqrt[3]{x}}$

crit.pt.	derivative	extremum	value
$x = -\frac{4}{5}$	0	local max	$\frac{12}{25}10^{1/3} = 1.034$
$x = 0$	undefined	local min	0

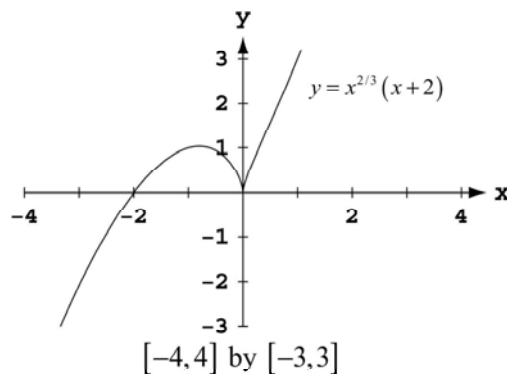

70. $y' = x^{2/3}(2x) + \frac{2}{3}x^{-1/3}(x^2 - 4) = \frac{8x^2 - 8}{3\sqrt[3]{x}}$

crit.pt.	derivative	extremum	value
$x = -1$	0	minimum	-3
$x = 0$	undefined	local max	0
$x = 1$	0	minimum	3

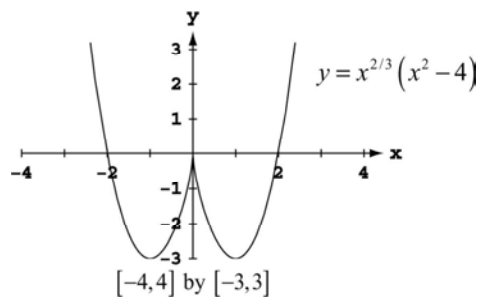

71. $y' = x \frac{1}{2\sqrt{4-x^2}}(-2x) + (1)\sqrt{4-x^2} = \frac{-x^2 + (4-x^2)}{\sqrt{4-x^2}} = \frac{4-2x^2}{\sqrt{4-x^2}}$

crit.pt.	derivative	extremum	value
$x = -2$	undefined	local max	0
$x = -\sqrt{2}$	0	minimum	-2
$x = \sqrt{2}$	0	maximum	2
$x = 2$	undefined	local min	0

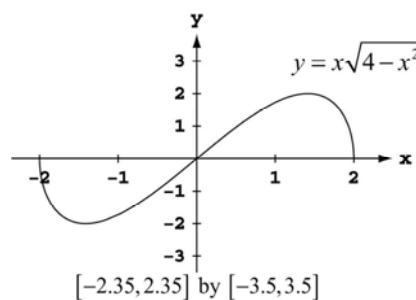

$$72. \quad y' = x^2 \frac{1}{2\sqrt{3-x}} (-1) + 2x\sqrt{3-x} = \frac{-x^2 + (4x)(3-x)}{2\sqrt{3-x}}$$

$$= \frac{-5x^2 + 12x}{2\sqrt{3-x}}$$

crit.pt.	derivative	extremum	value
$x = 0$	0	minimum	0
$x = \frac{12}{5}$	0	local max	$\frac{144}{125} 15^{1/2} \approx 4.462$
$x = 3$	undefined	minimum	0

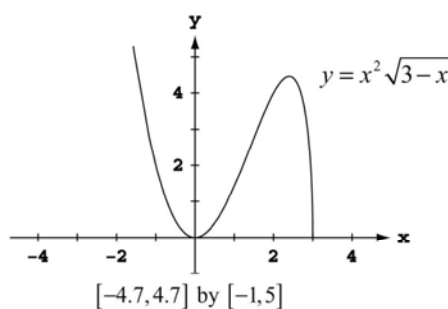

$$73. \quad y' = \begin{cases} -2, & x < 1 \\ 1, & x > 1 \end{cases}$$

crit.pt.	derivative	extremum	value
$x = 1$	undefined	minimum	2

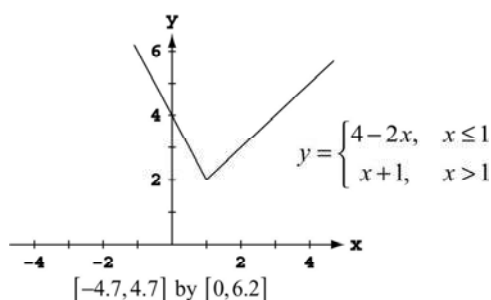

$$74. \quad y' = \begin{cases} -1, & x < 0 \\ 2-2x, & x > 0 \end{cases}$$

crit.pt.	derivative	extremum	value
$x = 0$	undefined	local min	3
$x = 1$	0	local mix	4

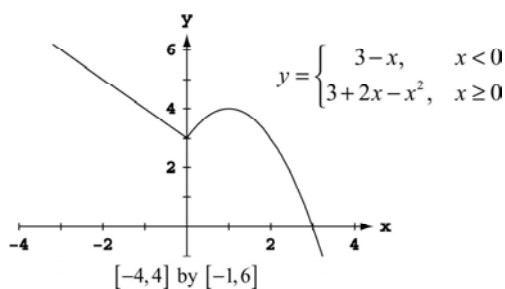

$$75. \quad y' = \begin{cases} -2x-2, & x < 1 \\ -2x+6, & x > 1 \end{cases}$$

crit.pt.	derivative	extremum	value
$x = -1$	0	maximum	5
$x = 1$	undefined	local min	1
$x = 3$	0	maximum	5

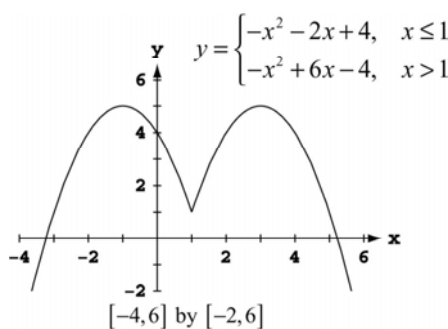

76. We begin by determining whether $f'(x)$ is defined at $x = 1$, where $f(x) = \begin{cases} -\frac{1}{4}x^2 - \frac{1}{2}x + \frac{15}{4}, & x \leq 1 \\ x^3 - 6x^2 + 8x, & x > 1 \end{cases}$

Clearly, $f'(x) = -\frac{1}{2}x - \frac{1}{2}$ if $x < 1$, and $\lim_{h \rightarrow 0^-} f'(1+h) = -1$. Also, $f'(x) = 3x^2 - 12x + 8$ if $x > 1$, and

$\lim_{h \rightarrow 0^+} f'(1+h) = -1$. Since f is continuous at $x = 1$, we have that $f'(1) = -1$.

$$\text{Thus, } f'(x) = \begin{cases} -\frac{1}{2}x - \frac{1}{2}, & x \leq 1 \\ 3x^2 - 12x + 8, & x > 1 \end{cases}$$

Note that $-\frac{1}{2}x - \frac{1}{2} = 0$ when $x = -1$, and $3x^2 - 12x + 8 = 0$ when $x = \frac{12 \pm \sqrt{12^2 - 4(3)(8)}}{2(3)} = \frac{12 \pm \sqrt{48}}{6} = 2 \pm \frac{2\sqrt{3}}{3}$.

But $2 - \frac{2\sqrt{3}}{3} \approx 0.845 < 1$, so the critical points occur at $x = -1$ and $x = 2 + \frac{2\sqrt{3}}{3} \approx 3.155$.

crit.pt.	derivative	extremum	value
$x = -1$	0	local max	4
$x \approx 3.155$	0	local min	≈ -3.079

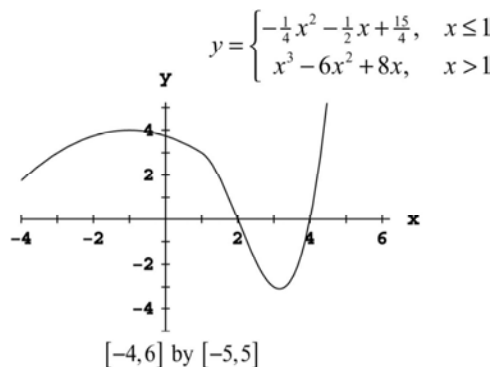

77. (a) No, since $f'(x) = \frac{2}{3}(x-2)^{-1/3}$, which is undefined at $x = 2$.
 (b) The derivative is defined and nonzero for all $x \neq 2$. Also, $f(2) = 0$ and $f(x) > 0$ for all $x \neq 2$.
 (c) No, $f(x)$ need not have a global maximum because its domain is all real numbers. Any restriction of f to a closed interval of the form $[a, b]$ would have both a maximum value and minimum value on the interval.
 (d) The answers are the same as (a) and (b) with 2 replaced by a .

78. Note that $f(x) = \begin{cases} -x^3 + 9x, & x \leq -3 \text{ or } 0 \leq x < 3 \\ x^3 - 9x, & -3 < x < 0 \text{ or } x \geq 3 \end{cases}$. Therefore, $f'(x) = \begin{cases} -3x^2 + 9, & x < -3 \text{ or } 0 < x < 3 \\ 3x^2 - 9, & -3 < x < 0 \text{ or } x > 3 \end{cases}$.
- (a) No, since the left- and right-hand derivatives at $x = 0$, are -9 and 9 , respectively.
 (b) No, since the left- and right-hand derivatives at $x = 3$, are -18 and 18 , respectively.
 (c) No, since the left- and right-hand derivatives at $x = -3$, are 18 and -18 , respectively.
 (d) The critical points occur when $f'(x) = 0$ (at $x = \pm\sqrt{3}$) and when $f'(x)$ is undefined (at $x = 0$ and $x = \pm 3$).
 The minimum value is 0 at $x = -3$, at $x = 0$, and at $x = 3$; local maxima occur at $(-\sqrt{3}, 6\sqrt{3})$ and $(\sqrt{3}, 6\sqrt{3})$.

79. Yes, since $f(x) = |x| = \sqrt{x^2} = (x^2)^{1/2} \Rightarrow f'(x) = \frac{1}{2}(x^2)^{-1/2}(2x) = \frac{x}{(x^2)^{1/2}} = \frac{x}{|x|}$ is not defined at $x = 0$. Thus it is not required that f' be zero at a local extreme point since f' may be undefined there.
80. If $f(c)$ is a local maximum value of f , then $f(x) \leq f(c)$ for all x in some open interval (a, b) containing c . Since f is even, $f(-x) = f(x) \leq f(c) = f(-c)$ for all $-x$ in the open interval $(-b, -a)$ containing $-c$. That is, f assumes a local maximum at the point $-c$. This is also clear from the graph of f because the graph of an even function is symmetric about the y -axis.
81. If $g(c)$ is a local minimum value of g , then $g(x) \geq g(c)$ for all x in some open interval (a, b) containing c . Since g is odd, $g(-x) = -g(x) \leq -g(c) = g(-c)$ for all $-x$ in the open interval $(-b, -a)$ containing $-c$. That is, g assumes a local maximum at the point $-c$. This is also clear from the graph of g because the graph of an odd function is symmetric about the origin.
82. If there are no boundary points or critical points the function will have no extreme values in its domain. Such functions do indeed exist, for example $f(x) = x$ for $-\infty < x < \infty$. (Any other linear function $f(x) = mx + b$ with $m \neq 0$ will do as well.)

83. (a) $V(x) = 160x - 52x^2 + 4x^3$
 $V'(x) = 160 - 104x + 12x^2 = 4(x-2)(3x-20)$
 The only critical point in the interval $(0, 5)$ is at $x = 2$. The maximum value of $V(x)$ is 144 at $x = 2$.
 (b) The largest possible volume of the box is 144 cubic units, and it occurs when $x = 2$ units.

84. (a) $f'(x) = 3ax^2 + 2bx + c$ is a quadratic, so it can have 0, 1, or 2 zeros, which would be the critical points of f .
 The function $f(x) = x^3 - 3x$ has two critical points at $x = -1$ and $x = 1$. The function $f(x) = x^3 - 1$ has one critical point at $x = 0$. The function $f(x) = x^3 + x$ has no critical points.

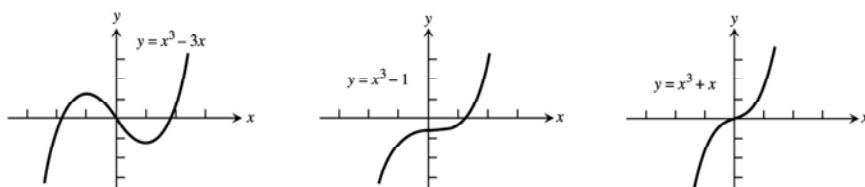

- (b) The function can have either two local extreme values or no extreme values. (If there is only one critical point, the cubic function has no extreme values.)

85. $s = -\frac{1}{2}gt^2 + v_0t + s_0 \Rightarrow \frac{ds}{dt} = -gt + v_0 = 0 \Rightarrow t = \frac{v_0}{g}$. Now $s(t) = s_0 \Leftrightarrow t\left(-\frac{gt}{2} + v_0\right) = 0 \Leftrightarrow t = 0$ or $t = \frac{2v_0}{g}$.
 Thus $s\left(\frac{v_0}{g}\right) = -\frac{1}{2}g\left(\frac{v_0}{g}\right)^2 + v_0\left(\frac{v_0}{g}\right) + s_0 = \frac{v_0^2}{2g} + s_0 > s_0$ is the maximum height over the interval $0 \leq t \leq \frac{2v_0}{g}$.

86. $\frac{dl}{dt} = -2\sin t + 2\cos t$, solving $\frac{dl}{dt} = 0 \Rightarrow \tan t = 1 \Rightarrow t = \frac{\pi}{4} + n\pi$ where n is a nonnegative integer (in this exercise t is never negative) \Rightarrow the peak current is $2\sqrt{2}$ amps.

87. Maximum value is 11 at $x = 5$; minimum value is 5 on the interval $[-3, 2]$; local maximum at $(-5, 9)$

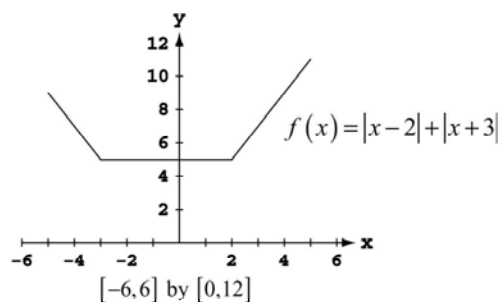

88. Maximum value is 4 on the interval $[5, 7]$; minimum value is -4 on the interval $[-2, 1]$.

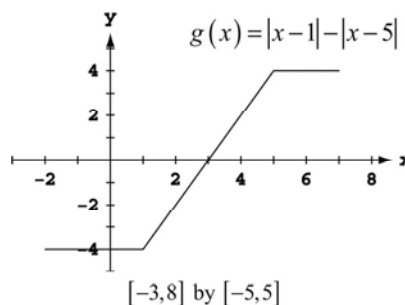

89. Maximum value is 5 on the interval $[3, \infty)$;
 minimum value is -5 on the interval $(-\infty, -2]$.

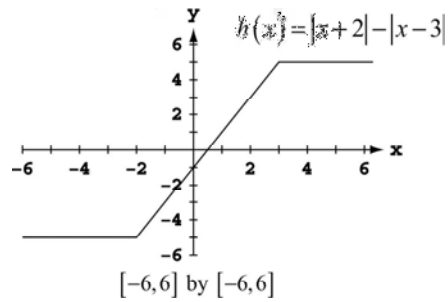

90. Minimum value is 4 on the interval $[-1, 3]$

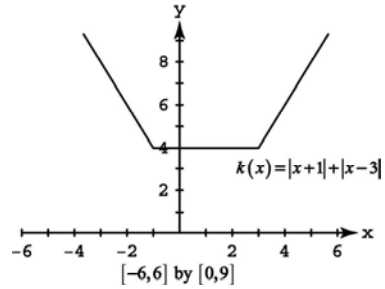

91-98. Example CAS commands:

Maple:

```
with(student):
f := x -> x^4 - 8*x^2 + 4*x + 2;
domain := x = -20/25..64/25;
plot( f(x), domain, color=black, title="Section 4.1 #91(a)");
Df := D(f);
plot( Df(x), domain, color=black, title="Section 4.1 #91(b)");
StatPt := fsolve( Df(x)=0, domain );
SingPt := NULL;
EndPt := op(rhs(domain));
Pts := evalf([EndPt, StatPt, SingPt]);
Values := [seq( f(x), x=Pts )];
```

Maximum value is 2.7608 and occurs at $x=2.56$ (right endpoint).

Minimum value is -6.2680 and occurs at $x=1.86081$ (singular point).

Mathematica: (functions may vary) (see Section 2.5 re. RealsOnly):

```
<<Miscellaneous `RealOnly`
Clear[f,x]
a = -1; b = 10/3;
f[x_] = 2 + 2x - 3 x^(2/3)
f'[x]
Plot[{f[x], f'[x]}, {x, a, b}]
NSolve[f'[x]==0, x]
{f[a], f[0], f[x]/.%, f[b]}/N
```

In more complicated expressions, NSolve may not yield results. In this case, an approximate solution (say 1.1 here) is observed from the graph and the following command is used:

```
FindRoot[f'[x]==0, {x, 1.1}]
```

4.2 THE MEAN VALUE THEOREM

- When $f(x) = x^2 + 2x - 1$ for $0 \leq x \leq 1$, then $\frac{f(1)-f(0)}{1-0} = f'(c) \Rightarrow 3 = 2c + 2 \Rightarrow c = \frac{1}{2}$.
- When $f(x) = x^{2/3}$ for $0 \leq x \leq 1$, then $\frac{f(1)-f(0)}{1-0} = f'(c) \Rightarrow 1 = \left(\frac{2}{3}\right)c^{-1/3} \Rightarrow c = \frac{8}{27}$.
- When $f(x) = x + \frac{1}{x}$ for $\frac{1}{2} \leq x \leq 2$, then $\frac{f(2)-f(1/2)}{2-1/2} = f'(c) \Rightarrow 0 = 1 - \frac{1}{c^2} \Rightarrow c = 1$.
- When $f(x) = \sqrt{x-1}$ for $1 \leq x \leq 3$, then $\frac{f(3)-f(1)}{3-1} = f'(c) \Rightarrow \frac{\sqrt{2}}{2} = \frac{1}{2\sqrt{c-1}} \Rightarrow c = \frac{3}{2}$.
- When $f(x) = \sin^{-1}(x)$ for $-1 \leq x \leq 1$, then $f'(c) = \frac{f(1)-f(-1)}{1-(-1)} \Rightarrow \frac{1}{\sqrt{1-c^2}} = \frac{\frac{\pi}{2} - (-\frac{\pi}{2})}{2} \Rightarrow \sqrt{1-c^2} = \frac{2}{\pi} \Rightarrow 1-c^2 = \frac{4}{\pi^2} \Rightarrow c^2 = 1 - \frac{4}{\pi^2} \Rightarrow c = \pm\sqrt{1 - \frac{4}{\pi^2}} \approx \pm 0.771$
- When $f(x) = \ln(x-1)$ for $2 \leq x \leq 4$, then $f'(c) = \frac{f(4)-f(2)}{4-2} \Rightarrow \frac{1}{c-1} = \frac{\ln 3 - \ln 1}{2} \Rightarrow c-1 = \frac{2}{\ln 3} \Rightarrow c = 1 + \frac{2}{\ln 3} \approx 2.820$
- When $f(x) = x^3 - x^2$ for $-1 \leq x \leq 2$, then $\frac{f(2)-f(-1)}{2-(-1)} = f'(c) \Rightarrow 2 = 3c^2 - 2c \Rightarrow c = \frac{1 \pm \sqrt{7}}{3}$.
 $\frac{1+\sqrt{7}}{3} \approx 1.22$ and $\frac{1-\sqrt{7}}{3} \approx -0.549$ are both in the interval $-1 \leq x \leq 2$.
- When $g(x) = \begin{cases} x^3 & -2 \leq x \leq 0 \\ x^2 & 0 < x \leq 2 \end{cases}$, then $\frac{g(2)-g(-2)}{2-(-2)} = g'(c) \Rightarrow 3 = g'(c)$. If $-2 \leq x < 0$, then $g'(x) = 3x^2 \Rightarrow 3 = g'(c) \Rightarrow 3c^2 = 3 \Rightarrow c = \pm 1$. Only $c = -1$ is in the interval. If $0 < x \leq 2$, then $g'(x) = 2x \Rightarrow 3 = g'(c) \Rightarrow 2c = 3 \Rightarrow c = \frac{3}{2}$.
- Does not; $f(x)$ is not differentiable at $x = 0$ in $(-1, 8)$.
- Does; $f(x)$ is continuous for every point of $[0, 1]$ and differentiable for every point in $(0, 1)$.
- Does; $f(x)$ is continuous for every point of $[0, 1]$ and differentiable for every point in $(0, 1)$.
- Does not; $f(x)$ is not continuous at $x = 0$ because $\lim_{x \rightarrow 0^-} f(x) = 1 \neq 0 = f(0)$.
- Does not; f is not differentiable at $x = -1$ in $(-2, 0)$.
- Does; $f(x)$ is continuous for every point of $[0, 3]$ and differentiable for every point in $(0, 3)$.
- Since $f(x)$ is not continuous on $0 \leq x \leq 1$, Rolle's Theorem does not apply: $\lim_{x \rightarrow 1^-} f(x) = \lim_{x \rightarrow 1^-} x = 1 \neq 0 = f(1)$.
- Since $f(x)$ must be continuous at $x = 0$ and $x = 1$ we have $\lim_{x \rightarrow 0^+} f(x) = a = f(0) \Rightarrow a = 3$ and $\lim_{x \rightarrow 1^-} f(x) = \lim_{x \rightarrow 1^+} f(x) \Rightarrow -1 + 3 + a = m + b \Rightarrow 5 = m + b$. Since $f(x)$ must also be differentiable at $x = 1$ we have $\lim_{x \rightarrow 1^-} f'(x) = \lim_{x \rightarrow 1^+} f'(x) \Rightarrow -2x + 3|_{x=1} = m|_{x=1} \Rightarrow 1 = m$. Therefore, $a = 3$, $m = 1$ and $b = 4$.

17. (a)

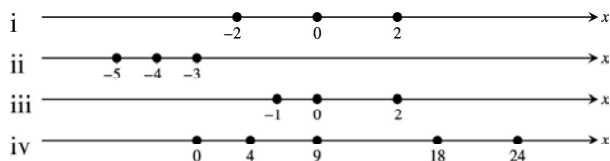

(b) Let r_1 and r_2 be zeros of the polynomial $P(x) = x^n + a_{n-1}x^{n-1} + \dots + a_1x + a_0$, then $P(r_1) = P(r_2) = 0$. Since polynomials are everywhere continuous and differentiable, by Rolle's Theorem $P'(r) = 0$ for some r between r_1 and r_2 , where $P'(x) = nx^{n-1} + (n-1)a_{n-1}x^{n-2} + \dots + a_1$.

18. With f both differentiable and continuous on $[a, b]$ and $f(r_1) = f(r_2) = f(r_3) = 0$ where r_1, r_2 and r_3 are in $[a, b]$, then by Rolle's Theorem there exists a c_1 between r_1 and r_2 such that $f'(c_1) = 0$ and a c_2 between r_2 and r_3 such that $f'(c_2) = 0$. Since f' is both differentiable and continuous on $[a, b]$, Rolle's Theorem again applies and we have a c_3 between c_1 and c_2 such that $f''(c_3) = 0$. To generalize, if f has $n+1$ zeros in $[a, b]$ and $f^{(n)}$ is continuous on $[a, b]$, then $f^{(n)}$ has at least one zero between a and b .

19. Since f'' exists throughout $[a, b]$ the derivative function f' is continuous there. If f' has more than one zero in $[a, b]$, say $f'(r_1) = f'(r_2) = 0$ for $r_1 \neq r_2$, then by Rolle's Theorem there is a c between r_1 and r_2 such that $f''(c) = 0$, contrary to $f'' > 0$ throughout $[a, b]$. Therefore f' has at most one zero in $[a, b]$. The same argument holds if $f'' < 0$ throughout $[a, b]$.

20. If $f(x)$ is a cubic polynomial with four or more zeros, then by Rolle's Theorem $f'(x)$ has three or more zeros, $f''(x)$ has 2 or more zeros and $f'''(x)$ has at least one zero. This is a contradiction since $f'''(x)$ is a non-zero constant when $f(x)$ is a cubic polynomial.

21. With $f(-2) = 11 > 0$ and $f(-1) = -1 < 0$ we conclude from the Intermediate Value Theorem that $f(x) = x^4 + 3x + 1$ has at least one zero between -2 and -1 . Then $-2 < x < -1 \Rightarrow -8 < x^3 < -1 \Rightarrow -32 < 4x^3 < -4 \Rightarrow -29 < 4x^3 + 3 < -1 \Rightarrow f'(x) < 0$ for $-2 < x < -1 \Rightarrow f(x)$ is decreasing on $[-2, -1] \Rightarrow f(x) = 0$ has exactly one solution in the interval $(-2, -1)$.

22. $f(x) = x^3 + \frac{4}{x^2} + 7 \Rightarrow f'(x) = 3x^2 - \frac{8}{x^3} > 0$ on $(-\infty, 0) \Rightarrow f(x)$ is increasing on $(-\infty, 0)$. Also, $f(x) < 0$ if $x < -2$ and $f(x) > 0$ if $-2 < x < 0 \Rightarrow f(x)$ has exactly one zero in $(-\infty, 0)$.

23. $g(t) = \sqrt{t} + \sqrt{t+1} - 4 \Rightarrow g'(t) = \frac{1}{2\sqrt{t}} - \frac{1}{2\sqrt{t+1}} > 0 \Rightarrow g(t)$ is increasing for t in $(0, \infty)$; $g(3) = \sqrt{3} - 2 < 0$ and $g(15) = \sqrt{15} > 0 \Rightarrow g(t)$ has exactly one zero in $(0, \infty)$.

24. $g(t) = \frac{1}{1-t} + \sqrt{1+t} - 3.1 \Rightarrow g'(t) = \frac{1}{(1-t)^2} + \frac{1}{2\sqrt{1+t}} > 0 \Rightarrow g(t)$ is increasing for t in $(-1, 1)$; $g(-0.99) = -2.5$ and $g(0.99) = 98.3 \Rightarrow g(t)$ has exactly one zero in $(-1, 1)$.

25. $r(\theta) = \theta + \sin^2\left(\frac{\theta}{3}\right) - 8 \Rightarrow r'(\theta) = 1 + \frac{2}{3}\sin\left(\frac{\theta}{3}\right)\cos\left(\frac{\theta}{3}\right) = 1 + \frac{1}{3}\sin\left(\frac{2\theta}{3}\right) > 0$ on $(-\infty, \infty) \Rightarrow r(\theta)$ is increasing on $(-\infty, \infty)$; $r(0) = -8$ and $r(8) = \sin^2\left(\frac{8}{3}\right) > 0 \Rightarrow r(\theta)$ has exactly one zero in $(-\infty, \infty)$.

26. $r(\theta) = 2\theta - \cos^2\theta + \sqrt{2} \Rightarrow r'(\theta) = 2 + 2\sin\theta\cos\theta = 2 + \sin 2\theta > 0$ on $(-\infty, \infty) \Rightarrow r(\theta)$ is increasing on $(-\infty, \infty)$; $r(-2\pi) = -4\pi - \cos(-2\pi) + \sqrt{2} = -4\pi - 1 + \sqrt{2} < 0$ and $r(2\pi) = 4\pi - 1 + \sqrt{2} > 0 \Rightarrow r(\theta)$ has exactly one zero in $(-\infty, \infty)$.

27. $r(\theta) = \sec \theta - \frac{1}{\theta^3} + 5 \Rightarrow r'(\theta) = (\sec \theta)(\tan \theta) + \frac{3}{\theta^4} > 0$ on $(0, \frac{\pi}{2}) \Rightarrow r(\theta)$ is increasing on $(0, \frac{\pi}{2})$; $r(0.1) \approx -994$ and $r(1.57) \approx 1260.5 \Rightarrow r(\theta)$ has exactly one zero in $(0, \frac{\pi}{2})$.
28. $r(\theta) = \tan \theta - \cot \theta - \theta \Rightarrow r'(\theta) = \sec^2 \theta + \csc^2 \theta - 1 = \sec^2 \theta + \cot^2 \theta > 0$ on $(0, \frac{\pi}{2}) \Rightarrow r(\theta)$ is increasing on $(0, \frac{\pi}{2})$; $r(\frac{\pi}{4}) = -\frac{\pi}{4} < 0$ and $r(1.57) \approx 1254.2 \Rightarrow r(\theta)$ has exactly one zero in $(0, \frac{\pi}{2})$.
29. By Corollary 1, $f'(x) = 0$ for all $x \Rightarrow f(x) = C$, where C is a constant. Since $f(-1) = 3$ we have $C = 3 \Rightarrow f(x) = 3$ for all x .
30. $g(x) = 2x + 5 \Rightarrow g'(x) = 2 = f'(x)$ for all x . By Corollary 2, $f(x) = g(x) + C$ for some constant C . Then $f(0) = g(0) + C \Rightarrow 5 = 5 + C \Rightarrow C = 0 \Rightarrow f(x) = g(x) = 2x + 5$ for all x .
31. $g(x) = x^2 \Rightarrow g'(x) = 2x = f'(x)$ for all x . By Corollary 2, $f(x) = g(x) + C$.
- (a) $f(0) = 0 \Rightarrow 0 = g(0) + C = 0 + C \Rightarrow C = 0 \Rightarrow f(x) = x^2 \Rightarrow f(2) = 4$
- (b) $f(1) = 0 \Rightarrow 0 = g(1) + C = 1 + C \Rightarrow C = -1 \Rightarrow f(x) = x^2 - 1 \Rightarrow f(2) = 3$
- (c) $f(-2) = 3 \Rightarrow 3 = g(-2) + C \Rightarrow 3 = 4 + C \Rightarrow C = -1 \Rightarrow f(x) = x^2 - 1 \Rightarrow f(2) = 3$
32. $g(x) = mx \Rightarrow g'(x) = m$, a constant. If $f'(x) = m$, then by Corollary 2, $f(x) = g(x) + b = mx + b$ where b is a constant. Therefore all functions whose derivatives are constant can be graphed as straight lines $y = mx + b$.
33. (a) $y = \frac{x^2}{2} + C$ (b) $y = \frac{x^3}{3} + C$ (c) $y = \frac{x^4}{4} + C$
34. (a) $y = x^2 + C$ (b) $y = x^2 - x + C$ (c) $y = x^3 + x^2 - x + C$
35. (a) $y' = -x^{-2} \Rightarrow y = \frac{1}{x} + C$ (b) $y = x + \frac{1}{x} + C$ (c) $y = 5x - \frac{1}{x} + C$
36. (a) $y' = \frac{1}{2}x^{-1/2} \Rightarrow y = x^{1/2} + C \Rightarrow y = \sqrt{x} + C$ (b) $y = 2\sqrt{x} + C$
(c) $y = 2x^2 - 2\sqrt{x} + C$
37. (a) $y = -\frac{1}{2}\cos 2t + C$ (b) $y = 2\sin \frac{t}{2} + C$
(c) $y = -\frac{1}{2}\cos 2t + 2\sin \frac{t}{2} + C$
38. (a) $y = \tan \theta + C$ (b) $y' = \theta^{1/2} \Rightarrow y = \frac{2}{3}\theta^{3/2} + C$ (c) $y = \frac{2}{3}\theta^{3/2} - \tan \theta + C$
39. $f(x) = x^2 - x + C; 0 = f(0) = 0^2 - 0 + C \Rightarrow C = 0 \Rightarrow f(x) = x^2 - x$
40. $g(x) = -\frac{1}{x} + x^2 + C; 1 = g(-1) = -\frac{1}{-1} + (-1)^2 + C \Rightarrow C = -1 \Rightarrow g(x) = -\frac{1}{x} + x^2 - 1$
41. $f(x) = \frac{e^{2x}}{2} + C; f(0) = \frac{3}{2} \Rightarrow \frac{e^{2(0)}}{2} + C = \frac{3}{2} \Rightarrow C = 1 \Rightarrow f(x) = 1 + \frac{e^{2x}}{2}$
42. $r(t) = \sec t - t + C; 0 = r(0) = \sec(0) - 0 + C \Rightarrow C = -1 \Rightarrow r(t) = \sec t - t - 1$
43. $v = \frac{ds}{dt} = 9.8t + 5 \Rightarrow s = 4.9t^2 + 5t + C$; at $s = 10$ and $t = 0$ we have $C = 10 \Rightarrow s = 4.9t^2 + 5t + 10$

44. $v = \frac{ds}{dt} = 32t - 2 \Rightarrow s = 16t^2 - 2t + C$; at $s = 4$ and $t = \frac{1}{2}$ we have $C = 1 \Rightarrow s = 16t^2 - 2t + 1$
45. $v = \frac{ds}{dt} = \sin(\pi t) \Rightarrow s = -\frac{1}{\pi} \cos(\pi t) + C$; at $s = 0$ and $t = 0$ we have $C = \frac{1}{\pi} \Rightarrow s = \frac{1 - \cos(\pi t)}{\pi}$
46. $v = \frac{ds}{dt} = \frac{2}{\pi} \cos\left(\frac{2t}{\pi}\right) \Rightarrow s = \sin\left(\frac{2t}{\pi}\right) + C$; at $s = 1$ and $t = \pi^2$ we have $C = 1 \Rightarrow s = \sin\left(\frac{2t}{\pi}\right) + 1$
47. $a = \frac{dv}{dt} = e^t \Rightarrow v = e^t + C$; at $v = 20$ and $t = 0$ we have $C = 19 \Rightarrow v = e^t + 19$
 $v = \frac{ds}{dt} = e^t + 19 \Rightarrow s = e^t + 19t + C$; at $s = 5$ and $t = 0$ we have $C = 4 \Rightarrow s = e^t + 19t + 4$
48. $a = 9.8 \Rightarrow v = 9.8t + C_1$; at $v = -3$ and $t = 0$ we have $C_1 = -3 \Rightarrow v = 9.8t - 3 \Rightarrow s = 4.9t^2 - 3t + C_2$; at $s = 0$ and $t = 0$ we have $C_2 = 0 \Rightarrow s = 4.9t^2 - 3t$
49. $a = -4 \sin(2t) \Rightarrow v = 2 \cos(2t) + C_1$; at $v = 2$ and $t = 0$ we have $C_1 = 0 \Rightarrow v = 2 \cos(2t) \Rightarrow s = \sin(2t) + C_2$; at $s = -3$ and $t = 0$ we have $C_2 = -3 \Rightarrow s = \sin(2t) - 3$
50. $a = \frac{9}{\pi^2} \cos\left(\frac{3t}{\pi}\right) \Rightarrow v = \frac{3}{\pi} \sin\left(\frac{3t}{\pi}\right) + C_1$; at $v = 0$ and $t = 0$ we have $C_1 = 0 \Rightarrow v = \frac{3}{\pi} \sin\left(\frac{3t}{\pi}\right) \Rightarrow s = -\cos\left(\frac{3t}{\pi}\right) + C_2$; at $s = -1$ and $t = 0$ we have $C_2 = 0 \Rightarrow s = -\cos\left(\frac{3t}{\pi}\right)$
51. If $T(t)$ is the temperature of the thermometer at time t , then $T(0) = -19^\circ C$ and $T(14) = -100^\circ C$. From the Mean Value Theorem there exists a $0 < t_0 < 14$ such that $\frac{T(14) - T(0)}{14 - 0} = 8.5^\circ C/\text{sec} = T'(t_0)$, the rate at which the temperature was changing at $t = t_0$ as measured by the rising mercury on the thermometer.
52. Because the trucker's average speed was 79.5 mph, by the Mean Value Theorem, the trucker must have been going that speed at least once during the trip.
53. Because its average speed was approximately 7.667 knots, and by the Mean Value Theorem, it must have been going that speed at least once during the trip.
54. The runner's average speed for the marathon was approximately 11.909 mph. Therefore, by the Mean Value Theorem, the runner must have been going that speed at least once during the marathon. Since the initial speed and final speed are both 0 mph and the runner's speed is continuous, by the Intermediate Value Theorem, the runner's speed must have been 11 mph at least twice.
55. Let $d(t)$ represent the distance the automobile traveled in time t . The average speed over $0 \leq t \leq 2$ is $\frac{d(2) - d(0)}{2 - 0}$. The Mean Value Theorem says that for some $0 < t_0 < 2$, $d'(t_0) = \frac{d(2) - d(0)}{2 - 0}$. The value $d'(t_0)$ is the speed of the automobile at time t_0 (which is read on the speedometer).
56. $a(t) = v'(t) = 1.6 \Rightarrow v(t) = 1.6t + C$; at $(0, 0)$ we have $C = 0 \Rightarrow v(t) = 1.6t$. When $t = 30$, then $v(30) = 48$ m/sec.
57. The conclusion of the Mean Value Theorem yields $\frac{\frac{1}{b} - \frac{1}{a}}{b - a} = -\frac{1}{c^2} \Rightarrow c^2 \left(\frac{a - b}{ab}\right) = a - b \Rightarrow c = \sqrt{ab}$.
58. The conclusion of the Mean Value Theorem yields $\frac{b^2 - a^2}{b - a} = 2c \Rightarrow c = \frac{a + b}{2}$.
59. $f'(x) = [\cos x \sin(x + 2) + \sin x \cos(x + 2)] - 2 \sin(x + 1) \cos(x + 1) = \sin(x + x + 2) - \sin 2(x + 1)$
 $= \sin(2x + 2) - \sin(2x + 2) = 0$. Therefore, the function has the constant value $f(0) = -\sin^2 1 \approx -0.7081$

which explains why the graph is a horizontal line.

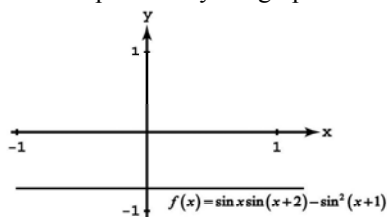

60. (a) $f(x) = (x+2)(x+1)x(x-1)(x-2) = x^5 - 5x^3 + 4x$ is one possibility.
 (b) Graphing $f(x) = x^5 - 5x^3 + 4x$ and $f'(x) = 5x^4 - 15x^2 + 4$ on $[-3, 3]$ by $[-7, 7]$ we see that each x -intercept of $f'(x)$ lies between a pair of x -intercepts of $f(x)$, as expected by Rolle's Theorem.

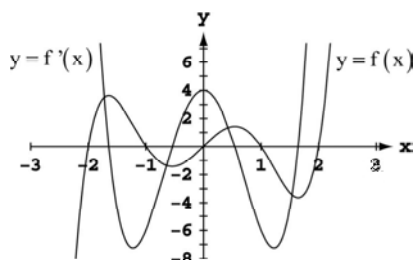

- (c) Yes, since \sin is continuous and differentiable on $(-\infty, \infty)$.

61. $f(x)$ must be zero at least once between a and b by the Intermediate Value Theorem. Now suppose that $f(x)$ is zero twice between a and b . Then by the Mean Value Theorem, $f'(x)$ would have to be zero at least once between the two zeros of $f(x)$, but this can't be true since we are given that $f'(x) \neq 0$ on this interval. Therefore, $f(x)$ is zero once and only once between a and b .

62. Consider the function $k(x) = f(x) - g(x)$. $k(x)$ is continuous and differentiable on $[a, b]$, and since $k(a) = f(a) - g(a)$ and $k(b) = f(b) - g(b)$, by the Mean Value Theorem, there must be a point c in (a, b) where $k'(c) = 0$. But since $k'(c) = f'(c) - g'(c)$, this means that $f'(c) = g'(c)$, and c is a point where the graphs of f and g have tangent lines with the same slope, so these lines are either parallel or are the same line.

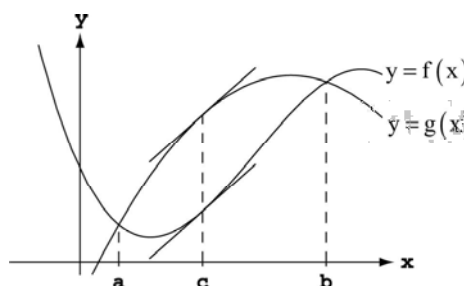

63. $f'(x) \leq 1$ for $1 \leq x \leq 4 \Rightarrow f(x)$ is differentiable on $1 \leq x \leq 4 \Rightarrow f$ is continuous on $1 \leq x \leq 4 \Rightarrow f$ satisfies the conditions of the Mean Value Theorem $\Rightarrow \frac{f(4) - f(1)}{4 - 1} = f'(c)$ for some c in $1 < x < 4 \Rightarrow f'(c) \leq 1 \Rightarrow \frac{f(4) - f(1)}{3} \leq 1 \Rightarrow f(4) - f(1) \leq 3$

64. $0 < f'(x) < \frac{1}{2}$ for all $x \Rightarrow f'(x)$ exists for all x , thus f is differentiable on $(-1, 1) \Rightarrow f$ is continuous on $[-1, 1] \Rightarrow f$ satisfies the conditions of the Mean Value Theorem $\Rightarrow \frac{f(1) - f(-1)}{1 - (-1)} = f'(c)$ for some c in $[-1, 1] \Rightarrow 0 < \frac{f(1) - f(-1)}{2} < \frac{1}{2} \Rightarrow 0 < f(1) - f(-1) < 1$. Since $f(1) - f(-1) < 1 \Rightarrow f(1) < 1 + f(-1) < 2 + f(-1)$, and since $0 < f(1) - f(-1)$ we have $f(-1) < f(1)$. Together we have $f(-1) < f(1) < 2 + f(-1)$.

65. Let $f(t) = \cos t$ and consider the interval $[0, x]$ where x is a real number. f is continuous on $[0, x]$ and f is differentiable on $(0, x)$ since $f'(t) = -\sin t \Rightarrow f$ satisfies the conditions of the Mean Value Theorem
 $\Rightarrow \frac{f(x)-f(0)}{x-0} = f'(c)$ for some c in $[0, x] \Rightarrow \frac{\cos x-1}{x} = -\sin c$. Since $-1 \leq \sin c \leq 1 \Rightarrow -1 \leq -\sin c \leq 1$
 $\Rightarrow -1 \leq \frac{\cos x-1}{x} \leq 1$. If $x > 0$, $-1 \leq \frac{\cos x-1}{x} \leq 1 \Rightarrow -x \leq \cos x-1 \leq x \Rightarrow |\cos x-1| \leq x = |x|$. If $x < 0$, $-1 \leq \frac{\cos x-1}{x} \leq 1$
 $\Rightarrow -x \geq \cos x-1 \geq x \Rightarrow x \leq \cos x-1 \leq -x \Rightarrow -(-x) \leq \cos x-1 \leq -x \Rightarrow |\cos x-1| \leq -x = |x|$. Thus, in both cases, we have $|\cos x-1| \leq |x|$. If $x = 0$, then $|\cos 0-1| = |1-1| = |0| \leq |0|$, thus $|\cos x-1| \leq |x|$ is true for all x .
66. Let $f(x) = \sin x$ for $a \leq x \leq b$. From the Mean Value Theorem there exists a c between a and b such that
 $\frac{\sin b - \sin a}{b - a} = \cos c \Rightarrow -1 \leq \frac{\sin b - \sin a}{b - a} \leq 1 \Rightarrow \frac{\sin b - \sin a}{b - a} \leq 1 \Rightarrow |\sin b - \sin a| \leq |b - a|$.
67. Yes. By Corollary 2 we have $f(x) = g(x) + c$ since $f'(x) = g'(x)$. If the graphs start at the same point $x = a$, then $f(a) = g(a) \Rightarrow c = 0 \Rightarrow f(x) = g(x)$.
68. Assume f is differentiable and $|f(w) - f(x)| \leq |w - x|$ for all values of w and x . Since f is differentiable, $f'(x)$ exists and $f'(x) = \lim_{w \rightarrow x} \frac{f(w) - f(x)}{w - x}$ using the alternative formula for the derivative. Let $g(x) = |x|$, which is continuous for all x . By Theorem 10 from Chapter 2, $|f'(x)| = \left| \lim_{w \rightarrow x} \frac{f(w) - f(x)}{w - x} \right| = \lim_{w \rightarrow x} \left| \frac{f(w) - f(x)}{w - x} \right|$
 $= \lim_{w \rightarrow x} \frac{|f(w) - f(x)|}{|w - x|}$. Since $|f(w) - f(x)| \leq |w - x|$ for all w and $x \Rightarrow \frac{|f(w) - f(x)|}{|w - x|} \leq 1$ as long as $w \neq x$. By Theorem 5 from Chapter 2, $|f'(x)| = \lim_{w \rightarrow x} \frac{|f(w) - f(x)|}{|w - x|} \leq \lim_{w \rightarrow x} 1 = 1 \Rightarrow |f'(x)| \leq 1 \Rightarrow -1 \leq f'(x) \leq 1$.
69. By the Mean Value Theorem we have $\frac{f(b) - f(a)}{b - a} = f'(c)$ for some point c between a and b . Since $b - a > 0$ and $f(b) < f(a)$, we have $f(b) - f(a) < 0 \Rightarrow f'(c) < 0$.
70. The condition is that f' should be continuous over $[a, b]$. The Mean Value Theorem then guarantees the existence of a point c in (a, b) such that $\frac{f(b) - f(a)}{b - a} = f'(c)$. If f' is continuous, then it has a minimum and maximum value on $[a, b]$, and $\min f' \leq f'(c) \leq \max f'$, as required.
71. $f'(x) = (1 + x^4 \cos x)^{-1} \Rightarrow f''(x) = -(1 + x^4 \cos x)^{-2} (4x^3 \cos x - x^4 \sin x)$
 $= -x^3 (1 + x^4 \cos x)^{-2} (4 \cos x - x \sin x) < 0$ for $0 \leq x \leq 0.1 \Rightarrow f'(x)$ is decreasing when $0 \leq x \leq 0.1$
 $\Rightarrow \min f' \approx 0.9999$ and $\max f' = 1$. Now we have $0.9999 \leq \frac{f(0.1) - 1}{0.1} \leq 1 \Rightarrow 0.09999 \leq f(0.1) - 1 \leq 0.1$
 $\Rightarrow 1.09999 \leq f(0.1) \leq 1.1$.
72. $f'(x) = (1 - x^4)^{-1} \Rightarrow f''(x) = -(1 - x^4)^{-2} (-4x^3) = \frac{4x^3}{(1 - x^4)^2} > 0$ for $0 < x \leq 0.1 \Rightarrow f'(x)$ is increasing when
 $0 \leq x \leq 0.1 \Rightarrow \min f' = 1$ and $\max f' = 1.0001$. Now we have $1 \leq \frac{f(0.1) - 2}{0.1} \leq 1.0001$
 $\Rightarrow 0.1 \leq f(0.1) - 2 \leq 0.10001 \Rightarrow 2.1 \leq f(0.1) \leq 2.10001$.
73. (a) Suppose $x < 1$, then by the Mean Value Theorem $\frac{f(x) - f(1)}{x - 1} < 0 \Rightarrow f(x) > f(1)$. Suppose $x > 1$, then by the Mean Value Theorem $\frac{f(x) - f(1)}{x - 1} > 0 \Rightarrow f(x) > f(1)$. Therefore $f(x) \geq 1$ for all x since $f(1) = 1$.
- (b) Yes. From part (a), $\lim_{x \rightarrow 1^-} \frac{f(x) - f(1)}{x - 1} \leq 0$ and $\lim_{x \rightarrow 1^+} \frac{f(x) - f(1)}{x - 1} \geq 0$. Since $f'(1)$ exists, these two one-sided limits are equal and have the value $f'(1) \Rightarrow f'(1) \leq 0$ and $f'(1) \geq 0 \Rightarrow f'(1) = 0$.

74. From the Mean Value Theorem we have $\frac{f(b)-f(a)}{b-a} = f'(c)$ where c is between a and b . But $f'(c) = 2pc + q = 0$ has only one solution $c = -\frac{q}{2p}$. (Note: $p \neq 0$ since f is a quadratic function.)
75. Proof that $\ln\left(\frac{b}{x}\right) = \ln b - \ln x$: Note that $\frac{d}{dx} \ln\left(\frac{b}{x}\right) = \frac{1}{b/x} \cdot \frac{-b}{x^2} = \frac{-1}{x}$ and $\frac{d}{dx} (\ln b - \ln x) = \frac{-1}{x}$; by Corollary 2 of the Mean Value Theorem there is a constant C so that $\ln\left(\frac{b}{x}\right) = \ln b - \ln x + C$; if $x = b$, then $\ln 1 = \ln b - \ln b + C \Rightarrow C = 0 \Rightarrow \ln\left(\frac{b}{x}\right) = \ln b - \ln x$.
76. (a) $\frac{d}{dx} (\tan^{-1} x + \cot^{-1} x) = \frac{1}{1+x^2} + \frac{-1}{1+x^2} = 0 \Rightarrow$ by Corollary 2 of the Mean Value Theorem that $\tan^{-1} x + \cot^{-1} x = C$ for some constant C ; if $x = 1$, then $\tan^{-1} 1 + \cot^{-1} 1 = \frac{\pi}{4} + \frac{\pi}{4} = \frac{\pi}{2} = C \Rightarrow \tan^{-1} x + \cot^{-1} x = \frac{\pi}{2}$.
- (b) $\frac{d}{dx} (\sec^{-1} x + \csc^{-1} x) = \frac{1}{|x|\sqrt{x^2-1}} + \frac{-1}{|x|\sqrt{x^2-1}} = 0 \Rightarrow$ by Corollary 2 of the Mean Value Theorem that $\sec^{-1} x + \csc^{-1} x = C$ for some constant C ; if $x = \sqrt{2}$, then $\sec^{-1} \sqrt{2} + \csc^{-1} \sqrt{2} = \frac{\pi}{4} + \frac{\pi}{4} = \frac{\pi}{2} = C \Rightarrow \sec^{-1} x + \csc^{-1} x = \frac{\pi}{2}$.
77. $e^x e^{-x} = e^{(x-x)} = e^0 = 1 \Rightarrow e^{-x} = \frac{1}{e^x}$ for all x ; $\frac{e^{x_1}}{e^{x_2}} = e^{x_1} \left(\frac{1}{e^{x_2}}\right) = e^{x_1} e^{-x_2} = e^{x_1-x_2}$
78. $y = (e^{x_1})^{x_2} \Rightarrow \ln y = x_2 \ln e^{x_1} = x_2 x_1 = x_1 x_2 \Rightarrow e^{\ln y} = e^{x_1 x_2} \Rightarrow y = e^{x_1 x_2} \Rightarrow (e^{x_1})^{x_2} = e^{x_1 x_2}$. Likewise, $(e^{x_2})^{x_1} = e^{x_2 x_1} = e^{x_1 x_2}$.

4.3 MONOTONIC FUNCTIONS AND THE FIRST DERIVATIVE TEST

- (a) $f'(x) = x(x-1) \Rightarrow$ critical points at 0 and 1

(b) $f' = \underset{0}{+++} | \underset{1}{---} | +++ \Rightarrow$ increasing on $(-\infty, 0)$ and $(1, \infty)$, decreasing on $(0, 1)$

(c) Local maximum at $x = 0$ and a local minimum at $x = 1$
- (a) $f'(x) = (x-1)(x+2) \Rightarrow$ critical points at -2 and 1

(b) $f' = \underset{-2}{+++} | \underset{1}{---} | +++ \Rightarrow$ increasing on $(-\infty, -2)$ and $(1, \infty)$, decreasing on $(-2, 1)$

(c) Local maximum at $x = -2$ and a local minimum at $x = 1$
- (a) $f'(x) = (x-1)^2(x+2) \Rightarrow$ critical points at -2 and 1

(b) $f' = \underset{-2}{---} | \underset{1}{+++} | +++ \Rightarrow$ increasing on $(-2, 1)$ and $(1, \infty)$, decreasing on $(-\infty, -2)$

(c) No local maximum and a local minimum at $x = -2$
- (a) $f'(x) = (x-1)^2(x+2)^2 \Rightarrow$ critical points at -2 and 1

(b) $f' = \underset{-2}{+++} | \underset{1}{+++} | +++ \Rightarrow$ increasing on $(-\infty, -2) \cup (-2, 1) \cup (1, \infty)$, never decreasing

(c) No local extrema

5. (a) $f'(x) = (x-1)e^{-x} \Rightarrow$ critical point at $x = 1$
 (b) $f' = \underset{1}{-----|++++} \Rightarrow$ decreasing on $(-\infty, 1)$, increasing on $(1, \infty)$
 (c) Local (and absolute) minimum at $x = 1$
6. (a) $f'(x) = (x-7)(x+1)(x+5) \Rightarrow$ critical points at $-5, -1$ and 7
 (b) $f' = \underset{-5}{----} | \underset{-1}{+++} | \underset{7}{----} | \underset{7}{+++} \Rightarrow$ increasing on $(-5, -1)$ and $(7, \infty)$, decreasing on $(-\infty, -5)$ and $(-1, 7)$
 (c) Local maximum at $x = -1$, local minima at $x = -5$ and $x = 7$
7. (a) $f'(x) = \frac{x^2(x-1)}{(x+2)} \Rightarrow$ critical points at $x = 0, x = 1$ and $x = -2$
 (b) $f' = \underset{-2}{+++} | \underset{0}{---} | \underset{1}{----} | \underset{1}{+++} \Rightarrow$ increasing on $(-\infty, -2)$ and $(1, \infty)$, decreasing on $(-2, 0)$ and $(0, 1)$
 (c) Local minimum at $x = 1$
8. (a) $f'(x) = \frac{(x-2)(x+4)}{(x+1)(x-3)} \Rightarrow$ critical points at $x = 2, x = -4, x = -1$, and $x = 3$
 (b) $f' = \underset{-4}{+++} | \underset{-4}{---} | \underset{-1}{+++} | \underset{2}{---} | \underset{3}{---} | \underset{3}{+++} \Rightarrow$ increasing on $(-\infty, -4)$, $(-1, 2)$ and $(3, \infty)$, decreasing on $(-4, -1)$ and $(2, 3)$
 (c) Local maximum at $x = -4$ and $x = 2$
9. (a) $f'(x) = 1 - \frac{4}{x^2} = \frac{x^2-4}{x^2} \Rightarrow$ critical points at $x = -2, x = 2$ and $x = 0$.
 (b) $f' = \underset{-2}{+++} | \underset{-2}{---} | \underset{0}{---} | \underset{2}{---} | \underset{2}{+++} \Rightarrow$ increasing on $(-\infty, -2)$ and $(2, \infty)$, decreasing on $(-2, 0)$ and $(0, 2)$
 (c) Local maximum at $x = -2$, local minimum at $x = 2$
10. (a) $f'(x) = 3 - \frac{6}{\sqrt{x}} = \frac{3\sqrt{x}-6}{\sqrt{x}} \Rightarrow$ critical points at $x = 4$ and $x = 0$
 (b) $f' = \underset{0}{---} | \underset{4}{+++} \Rightarrow$ increasing on $(4, \infty)$, decreasing on $(0, 4)$
 (c) Local minimum at $x = 4$
11. (a) $f'(x) = x^{-1/3}(x+2) \Rightarrow$ critical points at $x = -2$ and $x = 0$
 (b) $f' = \underset{-2}{+++} | \underset{-2}{---} | \underset{0}{---} | \underset{0}{+++} \Rightarrow$ increasing on $(-\infty, -2)$ and $(0, \infty)$, decreasing on $(-2, 0)$
 (c) Local maximum at $x = -2$, local minimum at $x = 0$
12. (a) $f'(x) = x^{-1/2}(x-3) \Rightarrow$ critical points at $x = 0$ and $x = 3$
 (b) $f' = \underset{0}{---} | \underset{3}{+++} \Rightarrow$ increasing on $(3, \infty)$, decreasing on $(0, 3)$
 (c) No local maximum and a local minimum at $x = 3$
13. (a) $f'(x) = (\sin x - 1)(2 \cos x + 1), 0 \leq x \leq 2\pi \Rightarrow$ critical points at $x = \frac{\pi}{2}, x = \frac{2\pi}{3}$, and $x = \frac{4\pi}{3}$
 (b) $f' = [\underset{0}{---} | \underset{\frac{\pi}{2}}{---} | \underset{\frac{2\pi}{3}}{+++} | \underset{\frac{4\pi}{3}}{---} | \underset{2\pi}{---}] \Rightarrow$ increasing on $(\frac{2\pi}{3}, \frac{4\pi}{3})$, decreasing on $(0, \frac{\pi}{2})$, $(\frac{\pi}{2}, \frac{2\pi}{3})$ and $(\frac{4\pi}{3}, 2\pi)$
 (c) Local maximum at $x = \frac{4\pi}{3}$ and $x = 0$, local minimum at $x = \frac{2\pi}{3}$ and $x = 2\pi$

14. (a) $f'(x) = (\sin x + \cos x)(\sin x - \cos x)$, $0 \leq x \leq 2\pi \Rightarrow$ critical points at $x = \frac{\pi}{4}$, $x = \frac{3\pi}{4}$, $x = \frac{5\pi}{4}$, and $x = \frac{7\pi}{4}$
 (b) $f' = \left[\begin{array}{cccc|cccc} - & - & - & - & + & + & + & + & - & - & - & - \\ 0 & & \frac{\pi}{4} & & \frac{3\pi}{4} & & \frac{5\pi}{4} & & \frac{7\pi}{4} & & 2\pi & \end{array} \right] \Rightarrow$ increasing on $\left(\frac{\pi}{4}, \frac{3\pi}{4}\right)$ and $\left(\frac{5\pi}{4}, \frac{7\pi}{4}\right)$, decreasing on $\left(0, \frac{\pi}{4}\right)$, $\left(\frac{3\pi}{4}, \frac{5\pi}{4}\right)$ and $\left(\frac{7\pi}{4}, 2\pi\right)$
 (c) Local maximum at $x = 0$, $x = \frac{3\pi}{4}$ and $x = \frac{7\pi}{4}$, local minimum at $x = \frac{\pi}{4}$, $x = \frac{5\pi}{4}$ and $x = 2\pi$
15. (a) Increasing on $(-2, 0)$ and $(2, 4)$, decreasing on $(-4, -2)$ and $(0, 2)$
 (b) Absolute maximum at $(-4, 2)$, local maximum at $(0, 1)$ and $(4, -1)$; Absolute minimum at $(2, -3)$, local minimum at $(-2, 0)$
16. (a) Increasing on $(-4, -3.25)$, $(-1.5, 1)$, and $(2, 4)$, decreasing on $(-3.25, -1.5)$ and $(1, 2)$
 (b) Absolute maximum at $(4, 2)$, local maximum at $(-3.25, 1)$ and $(1, 1)$; Absolute minimum at $(-1.5, -1)$, local minimum at $(-4, 0)$ and $(2, 0)$
17. (a) Increasing on $(-4, -1)$, $(0.5, 2)$, and $(2, 4)$, decreasing on $(-1, 0.5)$
 (b) Absolute maximum at $(4, 3)$, local maximum at $(-1, 2)$ and $(2, 1)$; No absolute minimum, local minimum at $(-4, -1)$ and $(0.5, -1)$
18. (a) Increasing on $(-4, -2.5)$, $(-1, 1)$, and $(3, 4)$, decreasing on $(-2.5, -1)$ and $(1, 3)$
 (b) No absolute maximum, local maximum at $(-2.5, 1)$, $(1, 2)$ and $(4, 2)$; No absolute minimum, local minimum at $(-1, 0)$ and $(3, 1)$
19. (a) $g(t) = -t^2 - 3t + 3 \Rightarrow g'(t) = -2t - 3 \Rightarrow$ a critical point at $t = -\frac{3}{2}$; $g' = \begin{array}{cccc|c} + & + & + & + & - & - & - & - \\ -3/2 & & & & & & & \end{array}$, increasing on $\left(-\infty, -\frac{3}{2}\right)$, decreasing on $\left(-\frac{3}{2}, \infty\right)$
 (b) local maximum value of $g\left(-\frac{3}{2}\right) = \frac{21}{4}$ at $t = -\frac{3}{2}$, absolute maximum is $\frac{21}{4}$ at $t = -\frac{3}{2}$
20. (a) $g(t) = -3t^2 + 9t + 5 \Rightarrow g'(t) = -6t + 9 \Rightarrow$ a critical point at $t = \frac{3}{2}$; $g' = \begin{array}{cccc|c} + & + & + & + & - & - & - & - \\ 3/2 & & & & & & & \end{array}$, increasing on $\left(-\infty, \frac{3}{2}\right)$, decreasing on $\left(\frac{3}{2}, \infty\right)$
 (b) local maximum value of $g\left(\frac{3}{2}\right) = \frac{47}{4}$ at $t = \frac{3}{2}$, absolute maximum is $\frac{47}{4}$ at $t = \frac{3}{2}$
21. (a) $h(x) = -x^3 + 2x^2 \Rightarrow h'(x) = -3x^2 + 4x = x(4 - 3x) \Rightarrow$ critical points at $x = 0, \frac{4}{3} \Rightarrow h' = \begin{array}{cccc|cccc} - & - & - & - & + & + & + & + & - & - & - & - \\ 0 & & & & \frac{4}{3} & & & & & & & \end{array}$, increasing on $\left(0, \frac{4}{3}\right)$, decreasing on $(-\infty, 0)$ and $\left(\frac{4}{3}, \infty\right)$
 (b) local maximum value of $h\left(\frac{4}{3}\right) = \frac{32}{27}$ at $x = \frac{4}{3}$; local minimum value of $h(0) = 0$ at $x = 0$, no absolute extrema
22. (a) $h(x) = 2x^3 - 18x \Rightarrow h'(x) = 6x^2 - 18 = 6(x + \sqrt{3})(x - \sqrt{3}) \Rightarrow$ critical points at $x = \pm\sqrt{3}$
 $\Rightarrow h' = \begin{array}{cccc|cccc} + & + & + & + & - & - & - & - & + & + & + & + \\ -\sqrt{3} & & & & \sqrt{3} & & & & & & & \end{array}$, increasing on $(-\infty, -\sqrt{3})$ and $(\sqrt{3}, \infty)$, decreasing on $(-\sqrt{3}, \sqrt{3})$
 (b) a local maximum is $h(-\sqrt{3}) = 12\sqrt{3}$ at $x = -\sqrt{3}$; local minimum is $h(\sqrt{3}) = -12\sqrt{3}$ at $x = \sqrt{3}$, no absolute extrema
23. (a) $f(\theta) = 3\theta^2 - 4\theta^3 \Rightarrow f'(\theta) = 6\theta - 12\theta^2 = 6\theta(1 - 2\theta) \Rightarrow$ critical points at $\theta = 0, \frac{1}{2}$
 $\Rightarrow f' = \begin{array}{cccc|cccc} - & - & - & - & + & + & + & + & - & - & - & - \\ 0 & & & & 1/2 & & & & & & & \end{array}$, increasing on $\left(0, \frac{1}{2}\right)$, decreasing on $(-\infty, 0)$ and $\left(\frac{1}{2}, \infty\right)$
 (b) a local maximum is $f\left(\frac{1}{2}\right) = \frac{1}{4}$ at $\theta = \frac{1}{2}$, a local minimum is $f(0) = 0$ at $\theta = 0$, no absolute extrema

24. (a) $f(\theta) = 6\theta - \theta^3 \Rightarrow f'(\theta) = 6 - 3\theta^2 = 3(\sqrt{2} - \theta)(\sqrt{2} + \theta) \Rightarrow$ critical points at $\theta = \pm\sqrt{2}$
 $\Rightarrow f' = \text{----} \begin{array}{c} | \\ -\sqrt{2} \end{array} \begin{array}{c} | \\ \sqrt{2} \end{array} \text{----}$, increasing on $(-\sqrt{2}, \sqrt{2})$, decreasing on $(-\infty, -\sqrt{2})$ and $(\sqrt{2}, \infty)$
- (b) a local maximum is $f(\sqrt{2}) = 4\sqrt{2}$ at $\theta = \sqrt{2}$, a local minimum is $f(-\sqrt{2}) = -4\sqrt{2}$ at $\theta = -\sqrt{2}$, no absolute extrema
25. (a) $f(r) = 3r^3 + 16r \Rightarrow f'(r) = 9r^2 + 16 \Rightarrow$ no critical points $\Rightarrow f' = \text{++++}$, increasing on $(-\infty, \infty)$, never decreasing
- (b) no local extrema, no absolute extrema
26. (a) $h(r) = (r + 7)^3 \Rightarrow h'(r) = 3(r + 7)^2 \Rightarrow$ a critical point at $r = -7 \Rightarrow h' = \text{+++} \begin{array}{c} | \\ -7 \end{array} \text{+++}$, increasing on $(-\infty, -7) \cup (-7, \infty)$, never decreasing
- (b) no local extrema, no absolute extrema
27. (a) $f(x) = x^4 - 8x^2 + 16 \Rightarrow f'(x) = 4x^3 - 16x = 4x(x + 2)(x - 2) \Rightarrow$ critical points at $x = 0$ and $x = \pm 2$
 $\Rightarrow f' = \text{----} \begin{array}{c} | \\ -2 \end{array} \begin{array}{c} | \\ 0 \end{array} \begin{array}{c} | \\ 2 \end{array} \text{----}$, increasing on $(-2, 0)$ and $(2, \infty)$, decreasing on $(-\infty, -2)$ and $(0, 2)$
- (b) a local maximum is $f(0) = 16$ at $x = 0$, local minima are $f(\pm 2) = 0$ at $x = \pm 2$, no absolute maximum; absolute minimum is 0 at $x = \pm 2$
28. (a) $g(x) = x^4 - 4x^3 + 4x^2 \Rightarrow g'(x) = 4x^3 - 12x^2 + 8x = 4x(x - 2)(x - 1) \Rightarrow$ critical points at $x = 0, 1, 2$
 $\Rightarrow g' = \text{----} \begin{array}{c} | \\ 0 \end{array} \begin{array}{c} | \\ 1 \end{array} \begin{array}{c} | \\ 2 \end{array} \text{----}$, increasing on $(0, 1)$ and $(2, \infty)$, decreasing on $(-\infty, 0)$ and $(1, 2)$
- (b) a local maximum is $g(1) = 1$ at $x = 1$, local minima are $g(0) = 0$ at $x = 0$ and $g(2) = 0$ at $x = 2$, no absolute maximum; absolute minimum is 0 at $x = 0, 2$
29. (a) $H(t) = \frac{3}{2}t^4 - t^6 \Rightarrow H'(t) = 6t^3 - 6t^5 = 6t^3(1 + t)(1 - t) \Rightarrow$ critical points at $t = 0, \pm 1$
 $\Rightarrow H' = \text{+++} \begin{array}{c} | \\ -1 \end{array} \begin{array}{c} | \\ 0 \end{array} \begin{array}{c} | \\ 1 \end{array} \text{----}$, increasing on $(-\infty, -1)$ and $(0, 1)$, decreasing on $(-1, 0)$ and $(1, \infty)$
- (b) the local maxima are $H(-1) = \frac{1}{2}$ at $t = -1$ and $H(1) = \frac{1}{2}$ at $t = 1$, the local minimum is $H(0) = 0$ at $t = 0$, absolute maximum is $\frac{1}{2}$ at $t = \pm 1$; no absolute minimum
30. (a) $K(t) = 15t^3 - t^5 \Rightarrow K'(t) = 45t^2 - 5t^4 = 5t^2(3 + t)(3 - t) \Rightarrow$ critical points at $t = 0, \pm 3$
 $\Rightarrow K' = \text{----} \begin{array}{c} | \\ -3 \end{array} \begin{array}{c} | \\ 0 \end{array} \begin{array}{c} | \\ 3 \end{array} \text{----}$, increasing on $(-3, 0) \cup (0, 3)$, decreasing on $(-\infty, -3)$ and $(3, \infty)$
- (b) a local maximum is $K(3) = 162$ at $t = 3$, a local minimum is $K(-3) = -162$ at $t = -3$, no absolute extrema
31. (a) $f(x) = x - 6\sqrt{x-1} \Rightarrow f'(x) = 1 - \frac{3}{\sqrt{x-1}} = \frac{\sqrt{x-1}-3}{\sqrt{x-1}} \Rightarrow$ critical points at $x = 1$ and $x = 10 \Rightarrow f' = \text{----} \begin{array}{c} | \\ 1 \end{array} \begin{array}{c} | \\ 10 \end{array} \text{+++}$, increasing on $(10, \infty)$, decreasing on $(1, 10)$
- (b) a local minimum is $f(10) = -8$, a local and absolute maximum is $f(1) = 1$, absolute minimum of -8 at $x = 10$
32. (a) $g(x) = 4\sqrt{x} - x^2 + 3 \Rightarrow g'(x) = \frac{2}{\sqrt{x}} - 2x = \frac{2-2x^{3/2}}{\sqrt{x}} \Rightarrow$ critical points at $x = 1$ and $x = 0 \Rightarrow g' = \text{+++} \begin{array}{c} | \\ 0 \end{array} \begin{array}{c} | \\ 1 \end{array} \text{----}$, increasing on $(0, 1)$, decreasing on $(1, \infty)$
- (b) a local minimum is $f(0) = 3$, a local maximum is $f(1) = 6$, absolute maximum of 6 at $x = 1$

33. (a) $g(x) = x\sqrt{8-x^2} = x(8-x^2)^{1/2} \Rightarrow g'(x) = (8-x^2)^{1/2} + x\left(\frac{1}{2}\right)(8-x^2)^{-1/2}(-2x) = \frac{2(2-x)(2+x)}{\sqrt{(2\sqrt{2}-x)(2\sqrt{2}+x)}}$
 \Rightarrow critical points at $x = \pm 2, \pm 2\sqrt{2} \Rightarrow g' = \left(\begin{array}{cccc} - & - & - & - \\ -2\sqrt{2} & -2 & 2 & 2\sqrt{2} \end{array} \right)$, increasing on $(-2, 2)$, decreasing on $(-2\sqrt{2}, -2)$ and $(2, 2\sqrt{2})$
 (b) local maxima are $g(2) = 4$ at $x = 2$ and $g(-2\sqrt{2}) = 0$ at $x = -2\sqrt{2}$, local minima are $g(-2) = -4$ at $x = -2$ and $g(2\sqrt{2}) = 0$ at $x = 2\sqrt{2}$, absolute maximum is 4 at $x = 2$; absolute minimum is -4 at $x = -2$
34. (a) $g(x) = x^2\sqrt{5-x} = x^2(5-x)^{1/2} \Rightarrow g'(x) = 2x(5-x)^{1/2} + x^2\left(\frac{1}{2}\right)(5-x)^{-1/2}(-1) = \frac{5x(4-x)}{2\sqrt{5-x}} \Rightarrow$ critical points at $x = 0, 4$ and $5 \Rightarrow g' = \left(\begin{array}{ccc} - & - & - \\ 0 & 4 & 5 \end{array} \right)$, increasing on $(0, 4)$, decreasing on $(-\infty, 0)$ and $(4, 5)$
 (b) a local maximum is $g(4) = 16$ at $x = 4$, a local minimum is 0 at $x = 0$ and $x = 5$, no absolute maximum; absolute minimum is 0 at $x = 0, 5$
35. (a) $f(x) = \frac{x^2-3}{x-2} \Rightarrow f'(x) = \frac{2x(x-2)-(x^2-3)(1)}{(x-2)^2} = \frac{(x-3)(x-1)}{(x-2)^2} \Rightarrow$ critical points at $x = 1, 3$
 $\Rightarrow f' = \left(\begin{array}{ccc} + & + & + \\ 1 & 2 & 3 \end{array} \right)$, increasing on $(-\infty, 1)$ and $(3, \infty)$, decreasing on $(1, 2)$ and $(2, 3)$, discontinuous at $x = 2$
 (b) a local maximum is $f(1) = 2$ at $x = 1$, a local minimum is $f(3) = 6$ at $x = 3$, no absolute extrema
36. (a) $f(x) = \frac{x^3}{3x^2+1} \Rightarrow f'(x) = \frac{3x^2(3x^2+1)-x^3(6x)}{(3x^2+1)^2} = \frac{3x^2(x^2+1)}{(3x^2+1)^2} \Rightarrow$ a critical point at $x = 0 \Rightarrow f' = \left(\begin{array}{c} + & + & + \\ 0 \end{array} \right)$, increasing on $(-\infty, 0) \cup (0, \infty)$, and never decreasing
 (b) no local extrema, no absolute extrema
37. (a) $f(x) = x^{1/3}(x+8) = x^{4/3} + 8x^{1/3} \Rightarrow f'(x) = \frac{4}{3}x^{1/3} + \frac{8}{3}x^{-2/3} = \frac{4(x+2)}{3x^{2/3}} \Rightarrow$ critical points at $x = 0, -2$
 $\Rightarrow f' = \left(\begin{array}{ccc} - & - & - \\ -2 & 0 \end{array} \right)$, increasing on $(-2, 0) \cup (0, \infty)$, decreasing on $(-\infty, -2)$
 (b) no local maximum, a local minimum is $f(-2) = -6\sqrt[3]{2} \approx -7.56$ at $x = -2$, no absolute maximum; absolute minimum is $-6\sqrt[3]{2}$ at $x = -2$
38. (a) $g(x) = x^{2/3}(x+5) = x^{5/3} + 5x^{2/3} \Rightarrow g'(x) = \frac{5}{3}x^{2/3} + \frac{10}{3}x^{-1/3} = \frac{5(x+2)}{3\sqrt[3]{x}} \Rightarrow = \frac{5(x+2)}{3\sqrt[3]{x}} \Rightarrow$ critical points at $x = -2$ and $x = 0 \Rightarrow g' = \left(\begin{array}{ccc} + & + & + \\ -2 & 0 \end{array} \right)$, increasing on $(-\infty, -2)$ and $(0, \infty)$, decreasing on $(-2, 0)$
 (b) local maximum is $g(-2) = 3\sqrt[3]{4} \approx 4.762$ at $x = -2$, a local minimum is $g(0) = 0$ at $x = 0$, no absolute extrema
39. (a) $h(x) = x^{1/3}(x^2-4) = x^{7/3} - 4x^{1/3} \Rightarrow h'(x) = \frac{7}{3}x^{4/3} - \frac{4}{3}x^{-2/3} = \frac{(\sqrt{7}x+2)(\sqrt{7}x-2)}{3\sqrt[3]{x^2}} \Rightarrow$ critical points at $x = 0, \frac{\pm 2}{\sqrt{7}} \Rightarrow h' = \left(\begin{array}{ccc} + & + & + \\ -2/\sqrt{7} & 0 & 2/\sqrt{7} \end{array} \right)$, increasing on $(-\infty, \frac{-2}{\sqrt{7}})$ and $(\frac{2}{\sqrt{7}}, \infty)$, decreasing on $(\frac{-2}{\sqrt{7}}, 0)$ and $(0, \frac{2}{\sqrt{7}})$
 (b) local maximum is $h\left(\frac{-2}{\sqrt{7}}\right) = \frac{24\sqrt[3]{2}}{7^{7/6}} \approx 3.12$ at $x = \frac{-2}{\sqrt{7}}$, the local minimum is $h\left(\frac{2}{\sqrt{7}}\right) = -\frac{24\sqrt[3]{2}}{7^{7/6}} \approx -3.12$, no absolute extrema

40. (a) $k(x) = x^{2/3}(x^2 - 4) = x^{8/3} - 4x^{2/3} \Rightarrow k'(x) = \frac{8}{3}x^{5/3} - \frac{8}{3}x^{-1/3} = \frac{8(x+1)(x-1)}{3\sqrt[3]{x}} \Rightarrow$ critical points at $x = 0, \pm 1$
 $\Rightarrow k' = \begin{matrix} - & - & - & | & + & + & + \\ -1 & & 0 & & & & 1 \end{matrix}$ (---|+++), increasing on $(-1, 0)$ and $(1, \infty)$, decreasing on $(-\infty, -1)$ and $(0, 1)$
 (b) local maximum is $k(0) = 0$ at $x = 0$, local minima are $k(\pm 1) = -3$ at $x = \pm 1$, no absolute maximum; absolute minimum is -3 at $x = \pm 1$

41. (a) $f(x) = e^{2x} + e^{-x} \Rightarrow f'(x) = 2e^{2x} - e^{-x} = 0 \Rightarrow e^{3x} = \frac{1}{2} \Rightarrow$ a critical point at $x = \frac{1}{3} \ln\left(\frac{1}{2}\right)$
 $f' = \begin{matrix} - & - & - & - & | & + & + & + & + \\ \frac{1}{3} \ln\left(\frac{1}{2}\right) & & & & & & & & \end{matrix}$, increasing on $\left(\frac{1}{3} \ln\left(\frac{1}{2}\right), \infty\right)$, decreasing on $\left(-\infty, \frac{1}{3} \ln\left(\frac{1}{2}\right)\right)$
 (b) a local minimum is $\frac{3}{2^{2/3}}$ at $x = \frac{1}{3} \ln\left(\frac{1}{2}\right)$; no local maximum; an absolute minimum $\frac{3}{2^{2/3}}$ at $x = \frac{1}{3} \ln\left(\frac{1}{2}\right)$; no absolute maximum

42. (a) $f(x) = e^{\sqrt{x}} \Rightarrow f'(x) = \frac{e^{\sqrt{x}}}{2\sqrt{x}} \Rightarrow$ no critical points $\Rightarrow f' = \begin{matrix} | & + & + & + \\ 0 \end{matrix}$, increasing on $(0, \infty)$
 (b) A local minimum is 1 at $x = 0$, no local maximum; an absolute minimum is 1 at $x = 0$, no absolute maximum

43. (a) $f(x) = x \ln x \Rightarrow f'(x) = 1 + \ln x \Rightarrow$ a critical point at $x = e^{-1} \Rightarrow f' = \begin{matrix} [& - & - & - & | & + & + & + \\ 0 & & & & e^{-1} & & & \end{matrix}$, increasing on (e^{-1}, ∞) , decreasing on $(0, e^{-1})$
 (b) A local minimum is $-e^{-1}$ at $x = e^{-1}$, no local maximum, an absolute minimum is $-e^{-1}$ at $x = e^{-1}$, no absolute maximum

44. (a) $f(x) = x^2 \ln x \Rightarrow f'(x) = x + 2x \ln x = x(1 + 2 \ln x) \Rightarrow$ a critical point at $x = e^{-1/2} \Rightarrow f' = \begin{matrix} [& - & - & - & | & + & + & + \\ 0 & & & & e^{-1/2} & & & \end{matrix}$, increasing on $(e^{-1/2}, \infty)$, decreasing on $(0, e^{-1/2})$
 (b) A local minimum is $-\frac{e^{-1}}{2}$ at $x = e^{-1/2}$, no local maximum; an absolute minimum is $-\frac{e^{-1}}{2}$ at $x = e^{-1/2}$, no absolute maximum

45. (a) $f(x) = 2x - x^2 \Rightarrow f'(x) = 2 - 2x \Rightarrow$ a critical point at $x = 1 \Rightarrow f' = \begin{matrix} + & + & + & | & - & - & - \\ 1 & & & 2 \end{matrix}$ and $f(1) = 1$ and $f(2) = 0$
 a local maximum is 1 at $x = 1$, a local minimum is 0 at $x = 2$.
 (b) There is an absolute maximum of 1 at $x = 1$; no absolute minimum.
 (c)

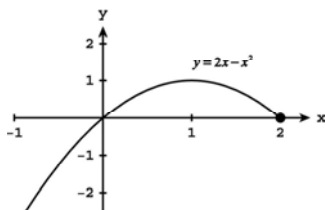

46. (a) $f(x) = (x+1)^2 \Rightarrow f'(x) = 2(x+1) \Rightarrow$ a critical point at $x = -1 \Rightarrow f' = \begin{matrix} - & - & - & | & + & + & + \\ -1 & & & 0 \end{matrix}$ and $f(-1) = 0, f(0) = 1 \Rightarrow$ a local maximum is 1 at $x = 0$, a local minimum is 0 at $x = -1$
 (b) no absolute maximum; absolute minimum is 0 at $x = -1$
 (c)

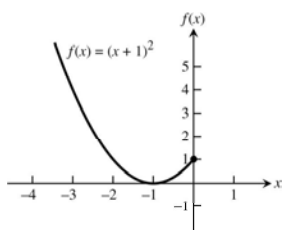

47. (a) $g(x) = x^2 - 4x + 4 \Rightarrow g'(x) = 2x - 4 = 2(x - 2) \Rightarrow$ a critical point at $x = 2 \Rightarrow g' = [\underset{1}{-} \underset{2}{-} \underset{2}{-} \mid \underset{2}{+} \underset{2}{+} \underset{2}{+}]$ and $g(1) = 1, g(2) = 0 \Rightarrow$ a local maximum is 1 at $x = 1$, a local minimum is $g(2) = 0$ at $x = 2$
- (b) no absolute maximum; absolute minimum is 0 at $x = 2$
- (c)

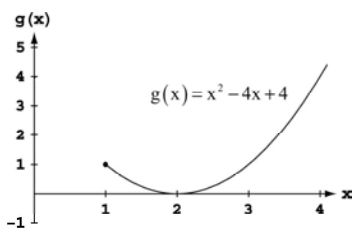

48. (a) $g(x) = -x^2 - 6x - 9 \Rightarrow g'(x) = -2x - 6 = -2(x + 3) \Rightarrow$ a critical point at $x = -3 \Rightarrow g' = [\underset{-4}{+} \underset{-3}{+} \underset{-3}{+} \mid \underset{-3}{-} \underset{-3}{-} \underset{-3}{-}]$ and $g(-4) = -1, g(-3) = 0 \Rightarrow$ a local maximum is 0 at $x = -3$, a local minimum is -1 at $x = -4$
- (b) absolute maximum is 0 at $x = -3$; no absolute minimum
- (c)

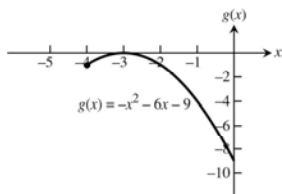

49. (a) $f(t) = 12t - t^3 \Rightarrow f'(t) = 12 - 3t^2 = 3(2 + t)(2 - t) \Rightarrow$ critical points at $t = \pm 2 \Rightarrow f' = [\underset{-3}{-} \underset{-2}{-} \underset{2}{+} \mid \underset{2}{+} \underset{2}{+} \underset{2}{+} \mid \underset{2}{-} \underset{2}{-} \underset{2}{-}]$ and $f(-3) = -9, f(-2) = -16, f(2) = 16 \Rightarrow$ local maxima are -9 at $t = -3$ and 16 at $t = 2$, a local minimum is -16 at $t = -2$
- (b) absolute maximum is 16 at $t = 2$; no absolute minimum
- (c)

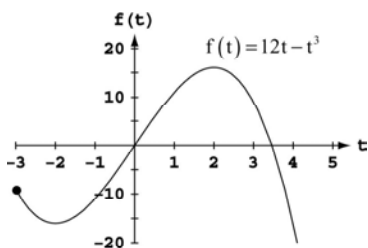

50. (a) $f(t) = t^3 - 3t^2 \Rightarrow f'(t) = 3t^2 - 6t = 3t(t - 2) \Rightarrow$ critical points at $t = 0$ and $t = 2 \Rightarrow f' = \begin{matrix} + & + & + & | & - & - & - & | & + & + & + &] \\ & & & & 0 & & 2 & & & & 3 & \end{matrix}$
 and $f(0) = 0, f(2) = -4, f(3) = 0 \Rightarrow$ a local maximum is 0 at $t = 0$ and $t = 3$, a local minimum is -4 at $t = 2$
 (b) absolute maximum is 0 at $t = 0, 3$; no absolute minimum
 (c)

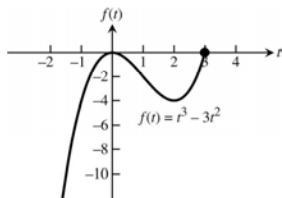

51. (a) $h(x) = \frac{x^3}{3} - 2x^2 + 4x \Rightarrow h'(x) = x^2 - 4x + 4 = (x - 2)^2 \Rightarrow$ a critical point at $x = 2 \Rightarrow h' = \begin{matrix} [& + & + & + & | & + & + & + &] \\ & & & & 0 & & 2 & & \end{matrix}$ and
 $h(0) = 0 \Rightarrow$ no local maximum, a local minimum is 0 at $x = 0$
 (b) no absolute maximum; absolute minimum is 0 at $x = 0$
 (c)

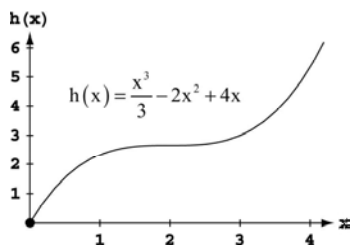

52. (a) $k(x) = x^3 + 3x^2 + 3x + 1 \Rightarrow k'(x) = 3x^2 + 6x + 3 = 3(x + 1)^2 \Rightarrow$ a critical point at $x = -1 \Rightarrow k' = \begin{matrix} + & + & + & | & + & + & + &] \\ & & & & -1 & & 0 & \end{matrix}$
 and $k(-1) = 0, k(0) = 1 \Rightarrow$ a local maximum is 1 at $x = 0$, no local minimum
 (b) absolute maximum is 1 at $x = 0$; no absolute minimum
 (c)

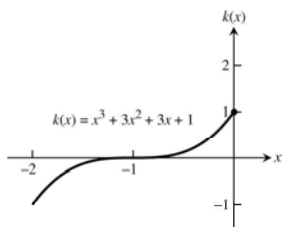

53. (a) $f(x) = \sqrt{25 - x^2} \Rightarrow f'(x) = \frac{-x}{\sqrt{25 - x^2}} \Rightarrow$ critical points at $x = 0, x = -5$, and $x = 5 \Rightarrow f' = \begin{matrix} (& + & + & + & | & - & - & - &) \\ & & & & -5 & & 0 & & 5 \end{matrix}$,
 $f(-5) = 0, f(0) = 5, f(5) = 0 \Rightarrow$ local maximum is 5 at $x = 0$; local minimum of 0 at $x = -5$ and $x = 5$
 (b) absolute maximum is 5 at $x = 0$; absolute minimum of 0 at $x = -5$ and $x = 5$
 (c)

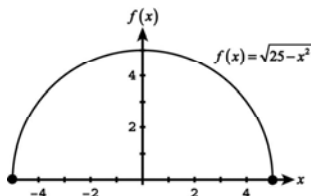

54. (a) $f(x) = \sqrt{x^2 - 2x - 3}, 3 \leq x < \infty \Rightarrow f'(x) = \frac{2x-2}{\sqrt{x^2-2x-3}} \Rightarrow$ only critical point in $3 \leq x < \infty$ is at $x = 3$
 $\Rightarrow f' = [+++]$, $f(3) = 0 \Rightarrow$ local minimum of 0 at $x = 3$, no local maximum

(b) absolute minimum of 0 at $x = 3$, no absolute maximum

(c)

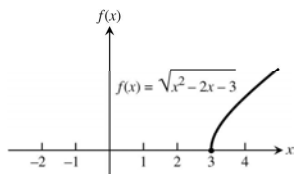

55. (a) $g(x) = \frac{x-2}{x^2-1}, 0 \leq x < 1 \Rightarrow g'(x) = \frac{-x^2+4x-1}{(x^2-1)^2} \Rightarrow$ only critical point in $0 \leq x < 1$ is $x = 2 - \sqrt{3} \approx 0.268$
 $\Rightarrow g' = [--- | +++]$, $g(2 - \sqrt{3}) = \frac{\sqrt{3}}{4\sqrt{3}-6} \approx 1.866 \Rightarrow$ local minimum of $\frac{\sqrt{3}}{4\sqrt{3}-6}$ at $x = 2 - \sqrt{3}$, local maximum at $x = 0$.

(b) absolute minimum of $\frac{\sqrt{3}}{4\sqrt{3}-6}$ at $x = 2 - \sqrt{3}$, no absolute maximum

(c)

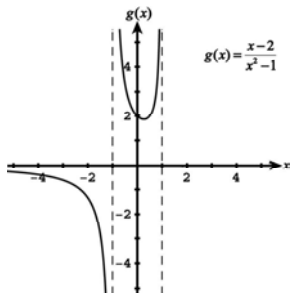

56. (a) $g(x) = \frac{x^2}{4-x^2}, -2 < x \leq 1 \Rightarrow g'(x) = \frac{8x}{(4-x^2)^2} \Rightarrow$ only critical point in $-2 < x \leq 1$ is $x = 0$
 $\Rightarrow g' = [--- | +++]$, $g(0) = 0 \Rightarrow$ local minimum of 0 at $x = 0$, local maximum of $\frac{1}{3}$ at $x = 1$.

(b) absolute minimum of 0 at $x = 0$, no absolute maximum

(c)

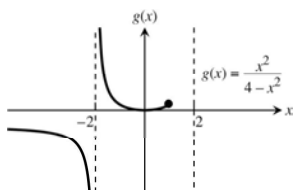

57. (a) $f(x) = \sin 2x, 0 \leq x \leq \pi \Rightarrow f'(x) = 2 \cos 2x, f'(x) = 0 \Rightarrow \cos 2x = 0 \Rightarrow$ critical points are $x = \frac{\pi}{4}$ and $x = \frac{3\pi}{4}$
 $\Rightarrow f' = [+++ | --- | +++]$, $f(0) = 0, f(\frac{\pi}{4}) = 1, f(\frac{3\pi}{4}) = -1, f(\pi) = 0 \Rightarrow$ local maxima are 1 at $x = \frac{\pi}{4}$ and 0 at $x = \pi$, and local minima are -1 at $x = \frac{3\pi}{4}$ and 0 at $x = 0$.

(b) The graph of f rises when $f' > 0$, falls when $f' < 0$, and has local extreme values where $f' = 0$. The function f has a local minimum value at $x = 0$ and $x = \frac{3\pi}{4}$, where the values of f' change from negative to positive. The function f has a local maximum value at $x = \pi$ and $x = \frac{\pi}{4}$, where the values of f' change from positive to negative.

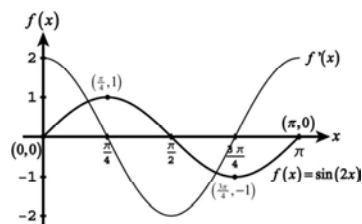

58. (a) $f(x) = \sin x - \cos x, 0 \leq x \leq 2\pi \Rightarrow f'(x) = \cos x + \sin x, f'(x) = 0 \Rightarrow \tan x = -1 \Rightarrow$ critical points are $x = \frac{3\pi}{4}$ and $x = \frac{7\pi}{4} \Rightarrow f' = [\begin{matrix} + & + & + & | & - & - & - & | & + & + & + \end{matrix}]$, $f(0) = -1, f(\frac{3\pi}{4}) = \sqrt{2}, f(\frac{7\pi}{4}) = -\sqrt{2}, f(2\pi) = -1 \Rightarrow$ local maxima are $\sqrt{2}$ at $x = \frac{3\pi}{4}$ and -1 at $x = 2\pi$, and local minima are $-\sqrt{2}$ at $x = \frac{7\pi}{4}$ and -1 at $x = 0$.

- (b) The graph of f rises when $f' > 0$, falls when $f' < 0$, and has local extreme values where $f' = 0$. The function f has a local minimum value at $x = 0$ and $x = \frac{7\pi}{4}$, where the values of f' change from negative to positive. The function f has a local maximum value at $x = 2\pi$ and $x = \frac{3\pi}{4}$, where the values of f' change from positive to negative.

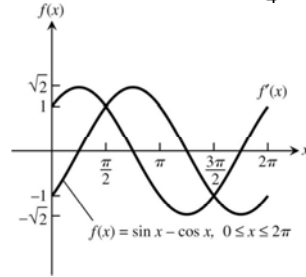

59. (a) $f(x) = \sqrt{3} \cos x + \sin x, 0 \leq x \leq 2\pi \Rightarrow f'(x) = -\sqrt{3} \sin x + \cos x, f'(x) = 0 \Rightarrow \tan x = \frac{1}{\sqrt{3}} \Rightarrow$ critical points \Rightarrow are $x = \frac{\pi}{6}$ and $x = \frac{7\pi}{6} \Rightarrow f' = [\begin{matrix} + & + & + & | & - & - & - & | & + & + & + \end{matrix}]$, $f(0) = \sqrt{3}, f(\frac{\pi}{6}) = 2, f(\frac{7\pi}{6}) = -2, f(2\pi) = \sqrt{3}$ local maxima are 2 at $x = \frac{\pi}{6}$ and $\sqrt{3}$ at $x = 2\pi$, and local minima are -2 at $x = \frac{7\pi}{6}$ and $\sqrt{3}$ at $x = 0$.

- (b) The graph of f rises when $f' > 0$, falls when $f' < 0$, and has local extreme values where $f' = 0$. The function f has a local minimum value at $x = 0$ and $x = \frac{7\pi}{6}$, where the values of f' change from negative to positive. The function f has a local maximum value at $x = 2\pi$ and $x = \frac{\pi}{6}$, where the values of f' change from positive to negative.

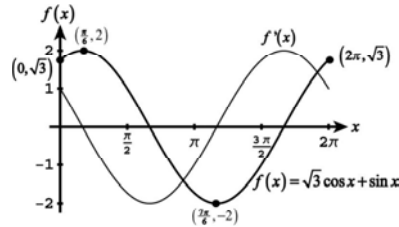

60. (a) $f(x) = -2x + \tan x, -\frac{\pi}{2} < x < \frac{\pi}{2} \Rightarrow f'(x) = -2 + \sec^2 x, f'(x) = 0 \Rightarrow \sec^2 x = 2 \Rightarrow$ critical points are $x = -\frac{\pi}{4}$ and $x = \frac{\pi}{4} \Rightarrow f' = [\begin{matrix} + & + & + & | & - & - & - & | & + & + & + \end{matrix}]$, $f(-\frac{\pi}{4}) = \frac{\pi}{2} - 1, f(\frac{\pi}{4}) = 1 - \frac{\pi}{2} \Rightarrow$ local maximum is $\frac{\pi}{2} - 1$ at $x = -\frac{\pi}{4}$, and local minimum is $1 - \frac{\pi}{2}$ at $x = \frac{\pi}{4}$.

- (b) The graph of f rises when $f' > 0$, falls when $f' < 0$, and has local extreme values where $f' = 0$. The function f has a local minimum value at $x = \frac{\pi}{4}$, where the values of f' change from negative to positive. The function f has a local maximum value at $x = -\frac{\pi}{4}$, where the values of f' change from positive to negative.

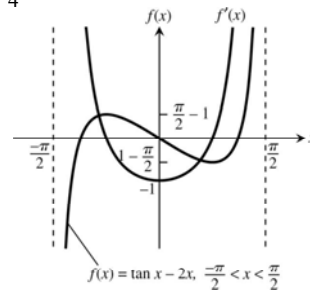

61. (a) $f(x) = \frac{x}{2} - 2 \sin(\frac{x}{2}) \Rightarrow f'(x) = \frac{1}{2} - \cos(\frac{x}{2}), f'(x) = 0 \Rightarrow \cos(\frac{x}{2}) = \frac{1}{2} \Rightarrow$ a critical point at $x = \frac{2\pi}{3} \Rightarrow f' = [\begin{matrix} - & - & - & | & + & + & + \end{matrix}]$ and $f(0) = 0, f(\frac{2\pi}{3}) = \frac{\pi}{3} - \sqrt{3}, f(2\pi) = \pi \Rightarrow$ local maxima are 0 at $x = 0$ and π at $x = 2\pi$, a local minimum is $\frac{\pi}{3} - \sqrt{3}$ at $x = \frac{2\pi}{3}$

- (b) The graph of f rises when $f' > 0$, falls when $f' < 0$, and has a local minimum value at the point where f' changes from negative to positive.

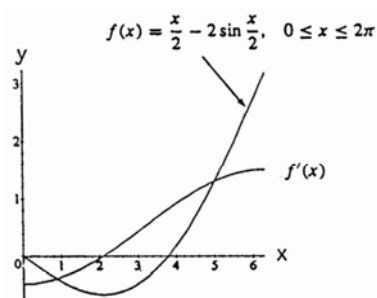

62. (a) $f(x) = -2 \cos x - \cos^2 x \Rightarrow f'(x) = 2 \sin x + 2 \cos x \sin x = 2(\sin x)(1 + \cos x) \Rightarrow$ critical points at $x = -\pi, 0, \pi \Rightarrow f' = [\text{---} | \text{+++}]$ and $f(-\pi) = 1, f(0) = -3, f(\pi) = 1 \Rightarrow$ a local maximum is

- 1 at $x = \pm \pi$, a local minimum is -3 at $x = 0$
 (b) The graph of f rises when $f' > 0$, falls when $f' < 0$, and has local extreme values where $f' = 0$. The function f has a local minimum value at $x = 0$, where the values of f' change from negative to positive.

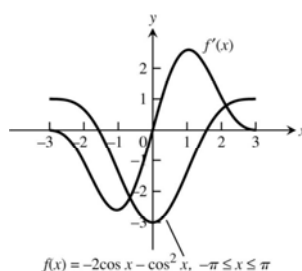

63. (a) $f(x) = \csc^2 x - 2 \cot x \Rightarrow f'(x) = 2(\csc x)(-\csc x)(\cot x) - 2(-\csc^2 x) = -2(\csc^2 x)(\cot x - 1) \Rightarrow$ a critical point at $x = \frac{\pi}{4} \Rightarrow f' = (\text{---} | \text{+++})$ and $f(\frac{\pi}{4}) = 0 \Rightarrow$ no local maximum, a local minimum is 0 at $x = \frac{\pi}{4}$

- (b) The graph of f rises when $f' > 0$, falls when $f' < 0$, and has a local minimum value at the point where $f' = 0$ and the values of f' change from negative to positive. The graph of f steepens as $f'(x) \rightarrow \pm\infty$.

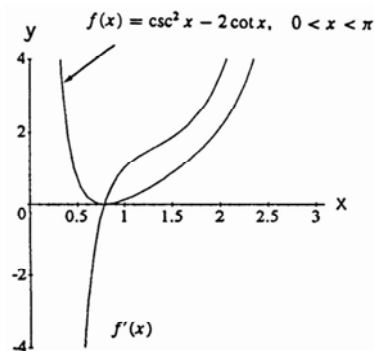

64. (a) $f(x) = \sec^2 x - 2 \tan x \Rightarrow f'(x) = 2(\sec x)(\sec x)(\tan x) - 2 \sec^2 x = (2 \sec^2 x)(\tan x - 1) \Rightarrow$ a critical point at $x = \frac{\pi}{4} \Rightarrow f' = (\text{---} | \text{+++})$ and $f(\frac{\pi}{4}) = 0 \Rightarrow$ no local maximum, a local minimum is 0 at $x = \frac{\pi}{4}$

- (b) The graph of f rises when $f' > 0$, falls when $f' < 0$, and has a local minimum value where $f' = 0$ and the values of f' change from negative to positive.

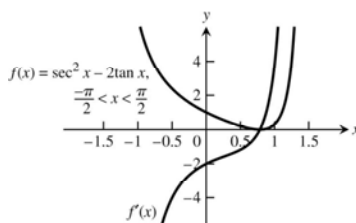

65. $h(\theta) = 3 \cos\left(\frac{\theta}{2}\right) \Rightarrow h'(\theta) = -\frac{3}{2} \sin\left(\frac{\theta}{2}\right) \Rightarrow h' = \left[\begin{matrix} - & - & - \\ 0 & & 2\pi \end{matrix} \right]$, $(0, 3)$ and $(2\pi, -3) \Rightarrow$ a local maximum is 3 at $\theta = 0$, a local minimum is -3 at $\theta = 2\pi$

66. $h(\theta) = 5 \sin\left(\frac{\theta}{2}\right) \Rightarrow h'(\theta) = \frac{5}{2} \cos\left(\frac{\theta}{2}\right) \Rightarrow h' = \left[\begin{matrix} + & + & + \\ 0 & & \pi \end{matrix} \right]$, $(0, 0)$ and $(\pi, 5) \Rightarrow$ a local maximum is 5 at $\theta = \pi$, a local minimum is 0 at $\theta = 0$

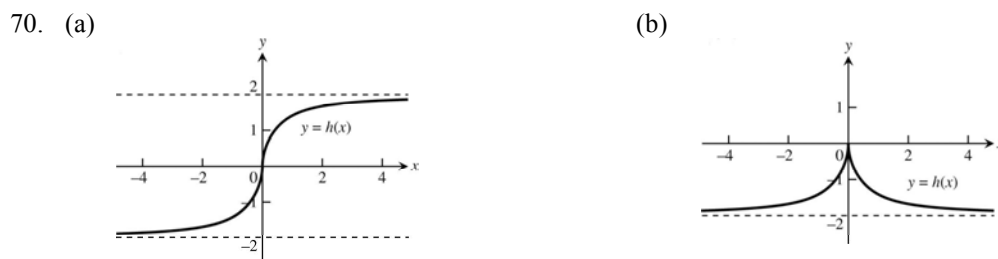
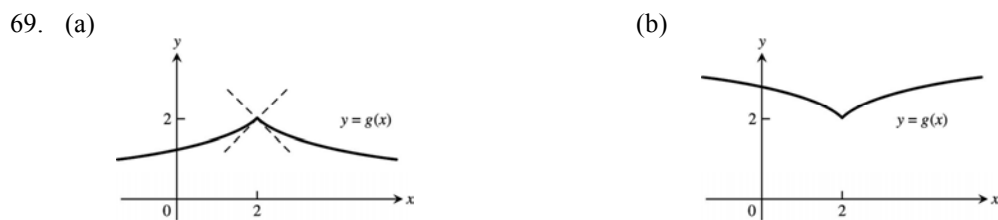
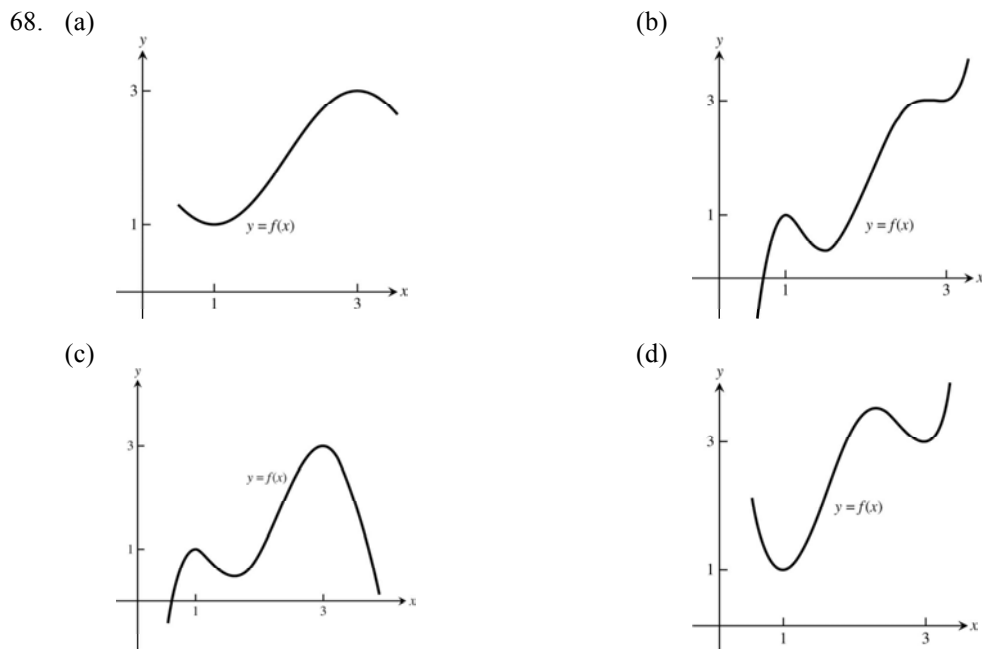
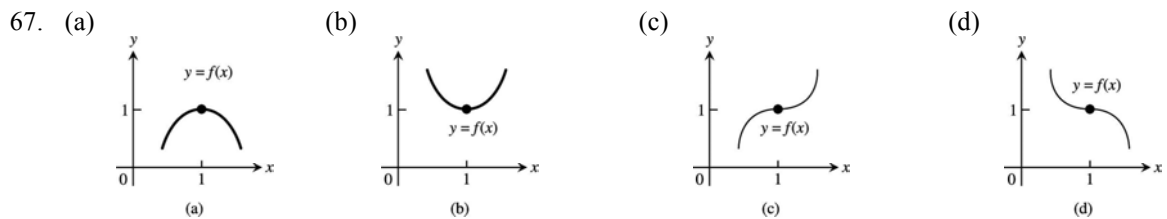

71. The function $f(x) = x \sin\left(\frac{1}{x}\right)$ has an infinite number of local maxima and minima on its domain, which is $(-\infty, 0) \cup (0, \infty)$. The function $\sin x$ has the following properties: a) it is continuous on $(-\infty, \infty)$; b) it is periodic; and c) its range is $[-1, 1]$. Also, for $a > 0$, the function $\frac{1}{x}$ has a range of $(-\infty, -a] \cup [a, \infty)$ on $\left[-\frac{1}{a}, 0\right) \cup \left(0, \frac{1}{a}\right]$. In particular, if $a = 1$, then $\frac{1}{x} \leq -1$ or $\frac{1}{x} \geq 1$ when x is in $[-1, 0) \cup (0, 1]$. This means $\sin\left(\frac{1}{x}\right)$ takes on the values of 1 and -1 infinitely many times on $[-1, 0) \cup (0, 1]$, namely at $\frac{1}{x} = \pm\frac{\pi}{2}, \pm\frac{3\pi}{2}, \pm\frac{5\pi}{2}, \dots \Rightarrow x = \pm\frac{2}{\pi}, \pm\frac{2}{3\pi}, \pm\frac{2}{5\pi}, \dots$. Thus $\sin\left(\frac{1}{x}\right)$ has infinitely many local maxima and minima in $[-1, 0) \cup (0, 1]$. On the interval $(0, 1]$, $-1 \leq \sin\left(\frac{1}{x}\right) \leq 1$ and since $x > 0$ we have $-x \leq x \sin\left(\frac{1}{x}\right) \leq x$. On the interval $[-1, 0)$, $-1 \leq \sin\left(\frac{1}{x}\right) \leq 1$ and since $x < 0$ we have $-x \geq x \sin\left(\frac{1}{x}\right) \geq x$. Thus $f(x)$ is bounded by the lines $y = x$ and $y = -x$. Since $\sin\left(\frac{1}{x}\right)$ oscillates between 1 and -1 infinitely many times on $[-1, 0) \cup (0, 1]$ then f will oscillate between $y = x$ and $y = -x$ infinitely many times. Thus f has infinitely many local maxima and minima. We can see from the graph (and verify later in Chapter 7) that $\lim_{x \rightarrow \infty} x \sin\left(\frac{1}{x}\right) = 1$ and $\lim_{x \rightarrow -\infty} x \sin\left(\frac{1}{x}\right) = 1$. The graph of f does not have any absolute maxima, but it does have two absolute minima.
72. $f(x) = ax^2 + bx + c = a\left(x^2 + \frac{b}{a}x\right) + c = a\left(x^2 + \frac{b}{a}x + \frac{b^2}{4a^2}\right) - \frac{b^2}{4a} + c = a\left(x + \frac{b}{2a}\right)^2 - \frac{b^2 - 4ac}{4a}$, a parabola whose vertex is at $x = -\frac{b}{2a}$. Thus when $a > 0$, f is increasing on $\left(-\frac{b}{2a}, \infty\right)$ and decreasing on $\left(-\infty, \frac{-b}{2a}\right)$; when $a < 0$, f is increasing on $\left(-\infty, \frac{-b}{2a}\right)$ and decreasing on $\left(\frac{-b}{2a}, \infty\right)$. Also note that $f'(x) = 2ax + b = 2a\left(x + \frac{b}{2a}\right) \Rightarrow$ for $a > 0$, $f' = \text{---} \mid \text{+++}$; for $a < 0$, $f' = \text{+++} \mid \text{---}$.
 $\qquad \qquad \qquad -b/2a \qquad \qquad \qquad -b/2a$
73. $f(x) = ax^2 + bx \Rightarrow f'(x) = 2ax + b$, $f(1) = 2 \Rightarrow a + b = 2$, $f'(1) = 0 \Rightarrow 2a + b = 0 \Rightarrow a = -2, b = 4$
 $\Rightarrow f(x) = -2x^2 + 4x$
74. $f(x) = ax^3 + bx^2 + cx + d \Rightarrow f'(x) = 3ax^2 + 2bx + c$, $f(0) = 0 \Rightarrow d = 0$, $f(1) = -1 \Rightarrow a + b + c + d = -1$,
 $f'(0) = 0 \Rightarrow c = 0$, $f'(1) = 0 \Rightarrow 3a + 2b + c = 0 \Rightarrow a = 2, b = -3, c = 0, d = 0 \Rightarrow f(x) = 2x^3 - 3x^2$
75. (a) $f(x) = \ln(\cos x) \Rightarrow f'(x) = -\frac{\sin x}{\cos x} = -\tan x = 0 \Rightarrow x = 0$; $f'(x) > 0$ for $-\frac{\pi}{4} \leq x < 0$ and $f'(x) < 0$ for $0 < x \leq \frac{\pi}{4} \Rightarrow$ there is a relative maximum at $x = 0$ with $f(0) = \ln(\cos 0) = \ln 1 = 0$;
 $f\left(-\frac{\pi}{4}\right) = \ln\left(\cos\left(-\frac{\pi}{4}\right)\right) = \ln\left(\frac{1}{\sqrt{2}}\right) = -\frac{1}{2}\ln 2$ and $f\left(\frac{\pi}{4}\right) = \ln\left(\cos\left(\frac{\pi}{4}\right)\right) = \ln\frac{1}{\sqrt{2}} = -\frac{1}{2}\ln 2$. Therefore, the absolute minimum occurs at $x = \pm\frac{\pi}{4}$ with $f\left(\pm\frac{\pi}{4}\right) = -\frac{1}{2}\ln 2$ and the absolute maximum occurs at $x = 0$ with $f(0) = 0$.
- (b) $f(x) = \cos(\ln x) \Rightarrow f'(x) = \frac{-\sin(\ln x)}{x} = 0 \Rightarrow x = 1$; $f'(x) > 0$ for $\frac{1}{2} \leq x < 1$ and $f'(x) < 0$ for $1 < x \leq 2$
 \Rightarrow there is a relative maximum at $x = 1$ with $f(1) = \cos(\ln 1) = \cos 0 = 1$;
 $f\left(\frac{1}{2}\right) = \cos\left(\ln\left(\frac{1}{2}\right)\right) = \cos(-\ln 2) = \cos(\ln 2)$ and $f(2) = \cos(\ln 2)$. Therefore, the absolute minimum occurs at $x = \frac{1}{2}$ and $x = 2$ with $f\left(\frac{1}{2}\right) = f(2) = \cos(\ln 2)$, and the absolute maximum occurs at $x = 1$ with $f(1) = 1$.
76. (a) $f(x) = x - \ln x \Rightarrow f'(x) = 1 - \frac{1}{x}$; if $x > 1$, then $f'(x) > 0$ which means that $f(x)$ is increasing
- (b) $f(1) = 1 - \ln 1 = 1 \Rightarrow f(x) = x - \ln x > 0$, if $x > 1$ by part (a) $\Rightarrow x > \ln x$ if $x > 1$

77. $f(x) = e^x - 2x \Rightarrow f'(x) = e^x - 2$; $f'(x) = 0 \Rightarrow e^x = 2 \Rightarrow x = \ln 2$; $f(0) = 1$, the absolute maximum; $f(\ln 2) = 2 - 2 \ln 2 \approx 0.613706$, the absolute minimum; $f(1) = e - 2 \approx 0.71828$, a relative or local maximum since f is increasing on the interval $(\ln 2, 1)$.
78. The function $f(x) = 2e^{\sin(x/2)}$ has a maximum whenever $\sin \frac{x}{2} = 1$ and a minimum whenever $\sin \frac{x}{2} = -1$. Therefore the maximums occur at $x = \pi + 2k(2\pi)$ and the minimums occur at $x = 3\pi + 2k(2\pi)$, where k is any integer. The maximum is $2e \approx 5.43656$ and the minimum is $\frac{2}{e} \approx 0.73576$.
79. $f(x) = x^2 \ln \frac{1}{x} \Rightarrow f'(x) = 2x \ln \frac{1}{x} + x^2 \left(\frac{1}{x} \right) (-x^{-2}) = 2x \ln \frac{1}{x} - x = -x(2 \ln x + 1)$; $f'(x) = 0 \Rightarrow x = 0$ or $\ln x = -\frac{1}{2}$. Since $x = 0$ is not in the domain of f , $x = e^{-1/2} = \frac{1}{\sqrt{e}}$. Also, $f'(x) > 0$ for $0 < x < \frac{1}{\sqrt{e}}$ and $f'(x) < 0$ for $x > \frac{1}{\sqrt{e}}$. Therefore, $f\left(\frac{1}{\sqrt{e}}\right) = \frac{1}{e} \ln \sqrt{e} = \frac{1}{e} \ln e^{1/2} = \frac{1}{2e} \ln e = \frac{1}{2e}$ is the absolute maximum value of f assumed at $x = \frac{1}{\sqrt{e}}$.
80. (a) Let $f(x) = e^x - x - 1 \Rightarrow f'(x) = e^x - 1 \Rightarrow$ a critical point at $x = 0 \Rightarrow f' = \text{---} | \text{+++}$, so f is increasing on $(0, \infty)$; since $f(0) = 0$ it follows that $f(x) = e^x - x - 1 \geq 0$ for $x \geq 0 \Rightarrow e^x \geq x + 1$ for $x \geq 0$.
- (b) Let $f(x) = e^x - \frac{1}{2}x^2 - x - 1 \Rightarrow f'(x) = e^x - x - 1 \geq 0$ for $x \geq 0$ by part (a), so f is increasing on $(0, \infty)$; since $f(0) = 0$ it follows that $f(x) = e^x - \frac{1}{2}x^2 - x - 1 \geq 0$ for $x \geq 0 \Rightarrow e^x \geq \frac{1}{2}x^2 + x + 1$ for $x \geq 0$.
81. Let $x_1 \neq x_2$ be two numbers in the domain of an increasing function f . Then, either $x_1 < x_2$ or $x_1 > x_2$ which implies $f(x_1) < f(x_2)$ or $f(x_1) > f(x_2)$, since $f(x)$ is increasing. In either case, $f(x_1) \neq f(x_2)$ and f is one-to-one. Similar arguments hold if f is decreasing.
82. $f(x)$ is increasing since $x_2 > x_1 \Rightarrow \frac{1}{3}x_2 + \frac{5}{6} > \frac{1}{3}x_1 + \frac{5}{6}$; $\frac{df}{dx} = \frac{1}{3} \Rightarrow \frac{df^{-1}}{dx} = \frac{1}{\left(\frac{1}{3}\right)} = 3$
83. $f(x)$ is increasing since $x_2 > x_1 \Rightarrow 27x_2^3 > 27x_1^3$; $y = 27x^3 \Rightarrow x = \frac{1}{3}y^{1/3} \Rightarrow f^{-1}(x) = \frac{1}{3}x^{1/3}$;
 $\frac{df}{dx} = 81x^2 \Rightarrow \frac{df^{-1}}{dx} = \frac{1}{81x^2} \Big|_{\frac{1}{3}x^{1/3}} = \frac{1}{9x^{2/3}} = \frac{1}{9}x^{-2/3}$
84. $f(x)$ is decreasing since $x_2 > x_1 \Rightarrow 1 - 8x_2^3 < 1 - 8x_1^3$; $y = 1 - 8x^3 \Rightarrow x = \frac{1}{2}(1 - y)^{1/3} \Rightarrow f^{-1}(x) = \frac{1}{2}(1 - x)^{1/3}$;
 $\frac{df}{dx} = -24x^2 \Rightarrow \frac{df^{-1}}{dx} = \frac{1}{-24x^2} \Big|_{\frac{1}{2}(1-x)^{1/3}} = \frac{-1}{6(1-x)^{2/3}} = -\frac{1}{6}(1-x)^{-2/3}$
85. $f(x)$ is decreasing since $x_2 > x_1 \Rightarrow (1 - x_2)^3 < (1 - x_1)^3$; $y = (1 - x)^3 \Rightarrow x = 1 - y^{1/3} \Rightarrow f^{-1}(x) = 1 - x^{1/3}$;
 $\frac{df}{dx} = -3(1 - x)^2 \Rightarrow \frac{df^{-1}}{dx} = \frac{1}{-3(1 - x)^2} \Big|_{1 - x^{1/3}} = \frac{-1}{3x^{2/3}} = -\frac{1}{3}x^{-2/3}$

86. $f(x)$ is increasing since $x_2 > x_1 \Rightarrow x_2^{5/3} > x_1^{5/3}$; $y = x^{5/3} \Rightarrow x = y^{3/5} \Rightarrow f^{-1}(x) = x^{3/5}$;

$$\frac{df}{dx} = \frac{5}{3}x^{2/3} \Rightarrow \frac{df^{-1}}{dx} = \frac{1}{\frac{5}{3}x^{2/3}} \Big|_{x^{3/5}} = \frac{3}{5x^{2/5}} = \frac{3}{5}x^{-2/5}$$

4.4 CONCAVITY AND CURVE SKETCHING

- $y = \frac{x^3}{3} - \frac{x^2}{2} - 2x + \frac{1}{3} \Rightarrow y' = x^2 - x - 2 = (x-2)(x+1) \Rightarrow y'' = 2x - 1 = 2(x - \frac{1}{2})$. The graph is rising on $(-\infty, -1)$ and $(2, \infty)$, falling on $(-1, 2)$, concave up on $(\frac{1}{2}, \infty)$ and concave down on $(-\infty, \frac{1}{2})$. Consequently, a local maximum is $\frac{3}{2}$ at $x = -1$, a local minimum is -3 at $x = 2$, and $(\frac{1}{2}, -\frac{3}{4})$ is a point of inflection.
- $y = \frac{x^4}{4} - 2x^2 + 4 \Rightarrow y' = x^3 - 4x = x(x^2 - 4) = x(x+2)(x-2) \Rightarrow y'' = 3x^2 - 4 = (\sqrt{3}x + 2)(\sqrt{3}x - 2)$. The graph is rising on $(-2, 0)$ and $(2, \infty)$, falling on $(-\infty, -2)$ and $(0, 2)$, concave up on $(-\infty, -\frac{2}{\sqrt{3}})$ and $(\frac{2}{\sqrt{3}}, \infty)$ and concave down on $(-\frac{2}{\sqrt{3}}, \frac{2}{\sqrt{3}})$. Consequently, a local maximum is 4 at $x = 0$, local minima are 0 at $x = \pm 2$, and $(-\frac{2}{\sqrt{3}}, \frac{16}{9})$ and $(\frac{2}{\sqrt{3}}, \frac{16}{9})$ are points of inflection.
- $y = \frac{3}{4}(x^2 - 1)^{2/3} \Rightarrow y' = (\frac{3}{4})(\frac{2}{3})(x^2 - 1)^{-1/3}(2x) = x(x^2 - 1)^{-1/3}$, $y' = \text{----} \quad \text{+++} \quad \text{----} \quad \text{+++} \Rightarrow$ the graph is rising on $(-1, 0)$ and $(1, \infty)$, falling on $(-\infty, -1)$ and $(0, 1) \Rightarrow$ a local maximum is $\frac{3}{4}$ at $x = 0$, local minima are 0 at $x = \pm 1$; $y'' = (x^2 - 1)^{-1/3} + (x)(-\frac{1}{3})(x^2 - 1)^{-4/3}(2x) = \frac{x^2 - 3}{3\sqrt[3]{(x^2 - 1)^4}}$, $y'' = \text{+++} \quad \text{----} \quad \text{----} \quad \text{+++} \Rightarrow$ the graph is concave up on $(-\infty, -\sqrt{3})$ and $(\sqrt{3}, \infty)$, concave down on $(-\sqrt{3}, \sqrt{3}) \Rightarrow$ points of inflection at $(\pm\sqrt{3}, \frac{3\sqrt[3]{4}}{4})$
- $y = \frac{9}{14}x^{1/3}(x^2 - 7) \Rightarrow y' = \frac{3}{14}x^{-2/3}(x^2 - 7) + \frac{9}{14}x^{1/3}(2x) = \frac{3}{2}x^{-2/3}(x^2 - 1)$, $y' = \text{+++} \quad \text{----} \quad \text{----} \quad \text{+++} \Rightarrow$ the graph is rising on $(-\infty, -1)$ and $(1, \infty)$, falling on $(-1, 1) \Rightarrow$ a local maximum is $\frac{27}{7}$ at $x = -1$, a local minimum is $-\frac{27}{7}$ at $x = 1$; $y'' = -x^{-5/3}(x^2 - 1) + 3x^{1/3} = 2x^{1/3} + x^{-5/3} = x^{-5/3}(2x^2 + 1)$, $y'' = \text{----} \quad \text{+++} \Rightarrow$ the graph is concave up on $(0, \infty)$, concave down on $(-\infty, 0) \Rightarrow$ a point of inflection at $(0, 0)$.
- $y = x + \sin 2x \Rightarrow y' = 1 + 2 \cos 2x$, $y' = \text{----} \quad \text{+++} \quad \text{----} \quad \text{+++} \Rightarrow$ the graph is rising on $(-\frac{\pi}{3}, \frac{\pi}{3})$, falling on $(-\frac{2\pi}{3}, -\frac{\pi}{3})$ and $(\frac{\pi}{3}, \frac{2\pi}{3}) \Rightarrow$ local maxima are $-\frac{2\pi}{3} + \frac{\sqrt{3}}{2}$ at $x = -\frac{2\pi}{3}$ and $\frac{\pi}{3} + \frac{\sqrt{3}}{2}$ at $x = \frac{\pi}{3}$, local minima are $-\frac{\pi}{3} - \frac{\sqrt{3}}{2}$ at $x = -\frac{\pi}{3}$ and $\frac{2\pi}{3} - \frac{\sqrt{3}}{2}$ at $x = \frac{2\pi}{3}$; $y'' = -4 \sin 2x$, $y'' = \text{----} \quad \text{+++} \quad \text{----} \quad \text{+++} \Rightarrow$ the graph is concave up on $(-\frac{\pi}{2}, 0)$ and $(\frac{\pi}{2}, \frac{2\pi}{3})$, concave down on $(-\frac{2\pi}{3}, -\frac{\pi}{2})$ and $(0, \frac{\pi}{2}) \Rightarrow$ points of inflection at $(-\frac{\pi}{2}, -\frac{\pi}{2})$, $(0, 0)$, and $(\frac{\pi}{2}, \frac{\pi}{2})$

6. $y = \tan x - 4x \Rightarrow y' = \sec^2 x - 4, y' = \left(\begin{array}{cccc} +++ & | & --- & | & +++ \end{array} \right) \Rightarrow$ the graph is rising on $\left(-\frac{\pi}{2}, -\frac{\pi}{3}\right)$ and $\left(\frac{\pi}{3}, \frac{\pi}{2}\right)$, falling on $\left(-\frac{\pi}{3}, \frac{\pi}{3}\right) \Rightarrow$ a local maximum is $-\sqrt{3} + \frac{4\pi}{3}$ at $x = -\frac{\pi}{3}$, a local minimum is $\sqrt{3} - \frac{4\pi}{3}$ at $x = \frac{\pi}{3}$; $y'' = 2(\sec x)(\sec x)(\tan x) = 2(\sec^2 x)(\tan x), y'' = \left(\begin{array}{ccc} --- & | & +++ \end{array} \right) \Rightarrow$ the graph is concave up on $\left(0, \frac{\pi}{2}\right)$, concave down on $\left(-\frac{\pi}{2}, 0\right) \Rightarrow$ a point of inflection at $(0, 0)$

7. If $x \geq 0, \sin|x| = \sin x$ and if $x < 0, \sin|x| = \sin(-x) = -\sin x$. From the sketch the graph is rising on $\left(-\frac{3\pi}{2}, -\frac{\pi}{2}\right), \left(0, \frac{\pi}{2}\right)$ and $\left(\frac{3\pi}{2}, 2\pi\right)$, falling on $\left(-2\pi, -\frac{3\pi}{2}\right), \left(-\frac{\pi}{2}, 0\right)$ and $\left(\frac{\pi}{2}, \frac{3\pi}{2}\right)$; local minima are -1 at $x = \pm\frac{3\pi}{2}$ and 0 at $x = 0$; local maxima are 1 at $x = \pm\frac{\pi}{2}$ and 0 at $x = \pm 2\pi$; concave up on $(-2\pi, -\pi)$ and $(\pi, 2\pi)$, and concave down on $(-\pi, 0)$ and $(0, \pi) \Rightarrow$ points of inflection are $(-\pi, 0)$ and $(\pi, 0)$

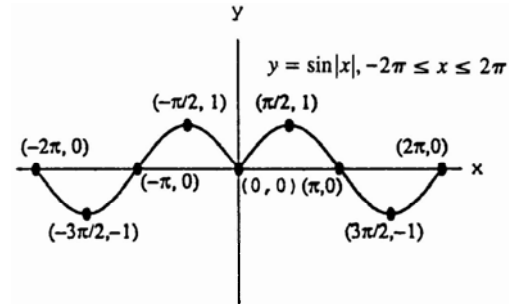

8. $y = 2 \cos x - \sqrt{2}x \Rightarrow y' = -2 \sin x - \sqrt{2}, y' = \left[\begin{array}{cccc} --- & | & +++ & | & --- & | & +++ \end{array} \right] \Rightarrow$ rising on $\left(-\frac{3\pi}{4}, -\frac{\pi}{4}\right)$ and $\left(\frac{5\pi}{4}, \frac{3\pi}{2}\right)$, falling on $\left(-\pi, -\frac{3\pi}{4}\right)$ and $\left(-\frac{\pi}{4}, \frac{5\pi}{4}\right) \Rightarrow$ local maxima are $-2 + \pi\sqrt{2}$ at $x = -\pi$, $\sqrt{2} + \frac{\pi\sqrt{2}}{4}$ at $x = -\frac{\pi}{4}$ and $-\sqrt{2} + \frac{3\pi\sqrt{2}}{4}$ at $x = \frac{3\pi}{2}$, and local minima are $-\sqrt{2} + \frac{3\pi\sqrt{2}}{4}$ at $x = -\frac{3\pi}{4}$ and $-\sqrt{2} - \frac{5\pi\sqrt{2}}{4}$ at $x = \frac{5\pi}{4}$; $y'' = -2 \cos x, y'' = \left[\begin{array}{cccc} +++ & | & --- & | & +++ \end{array} \right] \Rightarrow$ concave up on $\left(-\pi, -\frac{\pi}{2}\right)$ and $\left(\frac{\pi}{2}, \frac{3\pi}{2}\right)$, concave down on $\left(-\frac{\pi}{2}, \frac{\pi}{2}\right) \Rightarrow$ points of inflection at $\left(-\frac{\pi}{2}, \frac{\sqrt{2}\pi}{2}\right)$ and $\left(\frac{\pi}{2}, -\frac{\sqrt{2}\pi}{2}\right)$

9. When $y = x^2 - 4x + 3$, then $y' = 2x - 4 = 2(x - 2)$ and $y'' = 2$. The curve rises on $(2, \infty)$ and falls on $(-\infty, 2)$. At $x = 2$ there is a minimum. Since $y'' > 0$, the curve is concave up for all x .

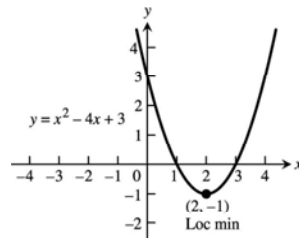

10. When $y = 6 - 2x - x^2$, then $y' = -2 - 2x = -2(1 + x)$ and $y'' = -2$. The curve rises on $(-\infty, -1)$ and falls on $(-1, \infty)$. At $x = -1$ there is a maximum. Since $y'' < 0$, the curve is concave down for all x .

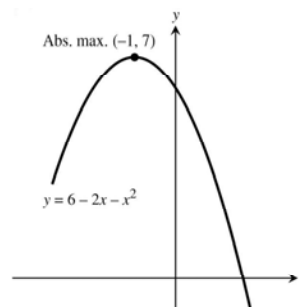

11. When $y = x^3 - 3x + 3$, then $y' = 3x^2 - 3 = 3(x-1)(x+1)$ and $y'' = 6x$. The curve rises on $(-\infty, -1) \cup (1, \infty)$ and falls on $(-1, 1)$. At $x = -1$ there is a local maximum and at $x = 1$ a local minimum. The curve is concave down on $(-\infty, 0)$ and concave up on $(0, \infty)$. There is a point of inflection at $x = 0$.

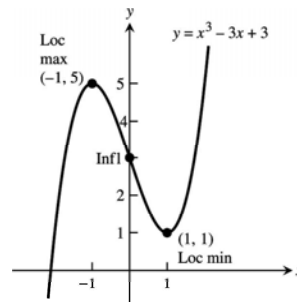

12. When $y = x(6-2x)^2$, then $y' = -4x(6-2x) + (6-2x)^2 = 12(3-x)(1-x)$ and $y'' = -12(3-x) - 12(1-x) = 24(x-2)$. The curve rises on $(-\infty, 1) \cup (3, \infty)$ and falls on $(1, 3)$. The curve is concave down on $(-\infty, 2)$ and concave up on $(2, \infty)$. At $x = 2$ there is a point of inflection.

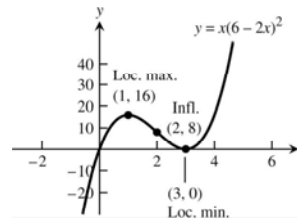

13. When $y = -2x^3 + 6x^2 - 3$, then $y' = -6x^2 + 12x = -6x(x-2)$ and $y'' = -12x + 12 = -12(x-1)$. The curve rises on $(0, 2)$ and falls on $(-\infty, 0)$ and $(2, \infty)$. At $x = 0$ there is a local minimum and at $x = 2$ a local maximum. The curve is concave up on $(-\infty, 1)$ and concave down on $(1, \infty)$. At $x = 1$ there is a point of inflection.

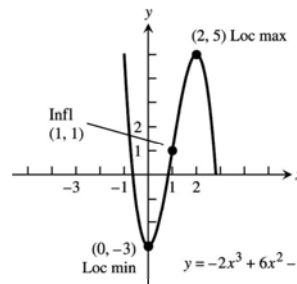

14. When $y = 1 - 9x - 6x^2 - x^3$, then $y' = -9 - 12x - 3x^2 = -3(x+3)(x+1)$ and $y'' = -12 - 6x = -6(x+2)$. The curve rises on $(-3, -1)$ and falls on $(-\infty, -3)$ and $(-1, \infty)$. At $x = -1$ there is a local maximum and at $x = -3$ a local minimum. The curve is concave up on $(-\infty, -2)$ and concave down on $(-2, \infty)$. At $x = -2$ there is a point of inflection.

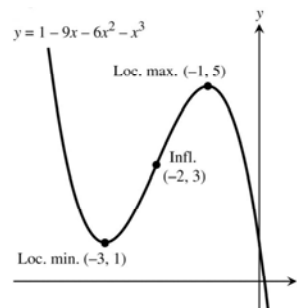

15. When $y = (x-2)^3 + 1$, then $y' = 3(x-2)^2$ and $y'' = 6(x-2)$. The curve never falls and there are no local extrema. The curve is concave down on $(-\infty, 2)$ and concave up on $(2, \infty)$. At $x = 2$ there is a point of inflection.

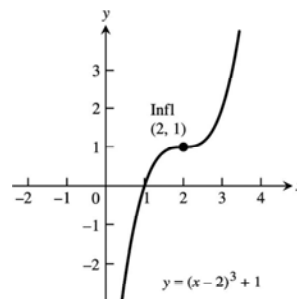

16. When $y = 1 - (x + 1)^3$, then $y' = -3(x + 1)^2$ and $y'' = -6(x + 1)$. The curve never rises and there are no local extrema. The curve is concave up on $(-\infty, -1)$ and concave down on $(-1, \infty)$. At $x = -1$ there is a point of inflection.

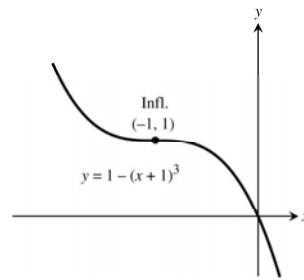

17. When $y = x^4 - 2x^2$, then $y' = 4x^3 - 4x = 4x(x + 1)(x - 1)$ and $y'' = 12x^2 - 4 = 12\left(x + \frac{1}{\sqrt{3}}\right)\left(x - \frac{1}{\sqrt{3}}\right)$. The curve rises on $(-1, 0)$ and $(1, \infty)$ and falls on $(-\infty, -1)$ and $(0, 1)$. At $x = \pm 1$ there are local minima and at $x = 0$ a local maximum. The curve is concave up on $(-\infty, -\frac{1}{\sqrt{3}})$ and $(\frac{1}{\sqrt{3}}, \infty)$ and concave down on $(-\frac{1}{\sqrt{3}}, \frac{1}{\sqrt{3}})$. At $x = \pm\frac{1}{\sqrt{3}}$ there are points of inflection.

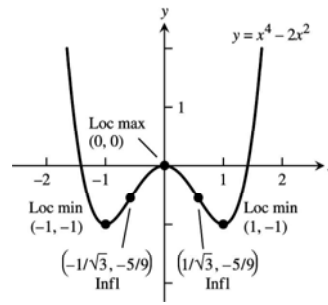

18. When $y = -x^4 + 6x^2 - 4$, then $y' = -4x^3 + 12x = -4x(x + \sqrt{3})(x - \sqrt{3})$ and $y'' = -12x^2 + 12 = -12(x + 1)(x - 1)$. The curve rises on $(-\infty, -\sqrt{3})$ and $(0, \sqrt{3})$, and falls on $(-\sqrt{3}, 0)$ and $(\sqrt{3}, \infty)$. At $x = \pm\sqrt{3}$ there are local maxima and at $x = 0$ a local minimum. The curve is concave up on $(-1, 1)$ and concave down on $(-\infty, -1)$ and $(1, \infty)$. At $x = \pm 1$ there are points of inflection.

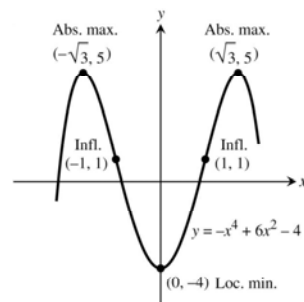

19. When $y = 4x^3 - x^4$, then $y' = 12x^2 - 4x^3 = 4x^2(3 - x)$ and $y'' = 24x - 12x^2 = 12x(2 - x)$. The curve rises on $(-\infty, 3)$ and falls on $(3, \infty)$. At $x = 3$ there is a local maximum, but there is no local minimum. The graph is concave up on $(0, 2)$ and concave down on $(-\infty, 0)$ and $(2, \infty)$. There are inflection points at $x = 0$ and $x = 2$.

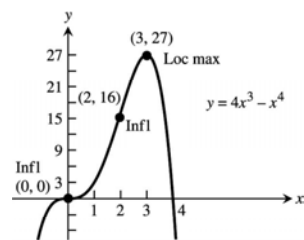

20. When $y = x^4 + 2x^3$, then $y' = 4x^3 + 6x^2 = 2x^2(2x + 3)$ and $y'' = 12x^2 + 12x = 12x(x + 1)$. The curve rises on $(-\frac{3}{2}, \infty)$ and falls on $(-\infty, -\frac{3}{2})$. There is a local minimum at $x = -\frac{3}{2}$, but no local maximum. The curve is concave up on $(-\infty, -1)$ and $(0, \infty)$, and concave down on $(-1, 0)$. At $x = -1$ and $x = 0$ there are points of inflection.

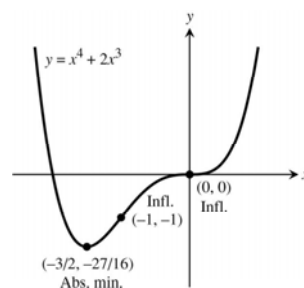

21. When $y = x^5 - 5x^4$, then
 $y' = 5x^4 - 20x^3 = 5x^3(x - 4)$ and $y'' = 20x^3 - 60x^2 = 20x^2(x - 3)$. The curve rises on $(-\infty, 0)$ and $(4, \infty)$, and falls on $(0, 4)$. There is a local maximum at $x = 0$, and a local minimum at $x = 4$. The curve is concave down on $(-\infty, 3)$ and concave up on $(3, \infty)$. At $x = 3$ there is a point of inflection.

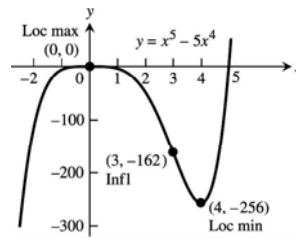

22. When $y = x\left(\frac{x}{2} - 5\right)^4$, then
 $y' = \left(\frac{x}{2} - 5\right)^4 + x(4)\left(\frac{x}{2} - 5\right)^3\left(\frac{1}{2}\right) = \left(\frac{x}{2} - 5\right)^3\left(\frac{5x}{2} - 5\right)$,
 and $y'' = 3\left(\frac{x}{2} - 5\right)^2\left(\frac{1}{2}\right)\left(\frac{5x}{2} - 5\right) + \left(\frac{x}{2} - 5\right)^3\left(\frac{5}{2}\right) = 5\left(\frac{x}{2} - 5\right)^2(x - 4)$. The curve is rising on $(-\infty, 2)$ and $(10, \infty)$, and falling on $(2, 10)$. There is a local maximum at $x = 2$ and a local minimum at $x = 10$. The curve is concave down on $(-\infty, 4)$ and concave up on $(4, \infty)$. At $x = 4$ there is a point of inflection.

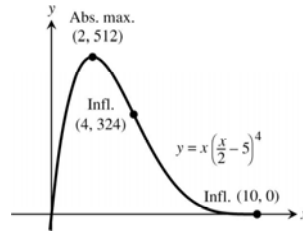

23. When $y = x + \sin x$, then $y' = 1 + \cos x$ and $y'' = -\sin x$. The curve rises on $(0, 2\pi)$. At $x = 0$ there is a local and absolute minimum and at $x = 2\pi$ there is a local and absolute maximum. The curve is concave down on $(0, \pi)$ and concave up on $(\pi, 2\pi)$. At $x = \pi$ there is a point of inflection.

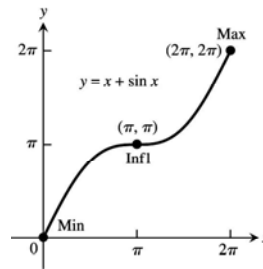

24. When $y = x - \sin x$, then $y' = 1 - \cos x$ and $y'' = \sin x$. The curve rises on $(0, 2\pi)$. At $x = 0$ there is a local and absolute minimum and at $x = 2\pi$ there is a local and absolute maximum. The curve is concave up on $(0, \pi)$ and concave down on $(\pi, 2\pi)$. At $x = \pi$ there is a point of inflection.

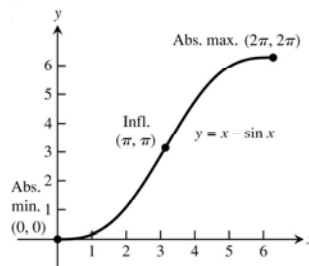

25. When $y = \sqrt{3}x - 2\cos x$, then $y' = \sqrt{3} + 2\sin x$ and $y'' = 2\cos x$. The curve is increasing on $\left(0, \frac{4\pi}{3}\right)$ and $\left(\frac{5\pi}{3}, 2\pi\right)$, and decreasing on $\left(\frac{4\pi}{3}, \frac{5\pi}{3}\right)$. At $x = 0$ there is a local and absolute minimum, at $x = \frac{4\pi}{3}$ there is a local maximum, at $x = \frac{5\pi}{3}$ there is a local minimum, and at $x = 2\pi$ there is a local and absolute maximum. The curve is concave up on $\left(0, \frac{\pi}{2}\right)$ and $\left(\frac{3\pi}{2}, 2\pi\right)$, and is concave down on $\left(\frac{\pi}{2}, \frac{3\pi}{2}\right)$. At $x = \frac{\pi}{2}$ and $x = \frac{3\pi}{2}$ there are points of inflection.

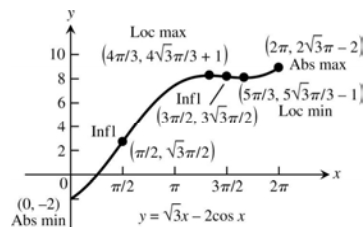

26. When $y = \frac{4}{3}x - \tan x$, then $y' = \frac{4}{3} - \sec^2 x$ and $y'' = -2\sec^2 x \tan x$. The curve is increasing on $(-\frac{\pi}{6}, \frac{\pi}{6})$, and decreasing on $(-\frac{\pi}{2}, -\frac{\pi}{6})$ and $(\frac{\pi}{6}, \frac{\pi}{2})$. At $x = -\frac{\pi}{6}$ there is a local minimum, at $x = \frac{\pi}{6}$ there is a local maximum, there are no absolute maxima or absolute minima. The curve is concave up on $(-\frac{\pi}{2}, 0)$, and is concave down on $(0, \frac{\pi}{2})$. At $x = 0$ there is a point of inflection.

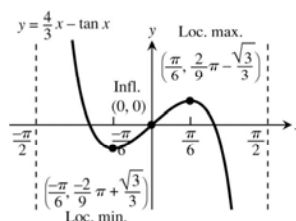

27. When $y = \sin x \cos x$, then $y' = -\sin^2 x + \cos^2 x = \cos 2x$ and $y'' = -2\sin 2x$. The curve is increasing on $(0, \frac{\pi}{4})$ and $(\frac{3\pi}{4}, \pi)$, and decreasing on $(\frac{\pi}{4}, \frac{3\pi}{4})$. At $x = 0$ there is a local minimum, at $x = \frac{\pi}{4}$ there is a local and absolute maximum, at $x = \frac{3\pi}{4}$ there is a local and absolute minimum, and at $x = \pi$ there is a local maximum. The curve is concave down on $(0, \frac{\pi}{2})$, and is concave up on $(\frac{\pi}{2}, \pi)$. At $x = \frac{\pi}{2}$ there is a point of inflection.

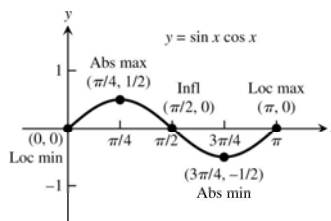

28. When $y = \cos x + \sqrt{3} \sin x$, then $y' = -\sin x + \sqrt{3} \cos x$ and $y'' = -\cos x - \sqrt{3} \sin x$. The curve is increasing on $(0, \frac{\pi}{3})$ and $(\frac{4\pi}{3}, 2\pi)$, and decreasing on $(\frac{\pi}{3}, \frac{4\pi}{3})$. At $x = 0$ there is a local minimum, at $x = \frac{\pi}{3}$ there is a local and absolute maximum, at $x = \frac{4\pi}{3}$ there is a local and absolute minimum, and at $x = 2\pi$ there is a local maximum. The curve is concave down on $(0, \frac{5\pi}{6})$ and $(\frac{11\pi}{6}, 2\pi)$, and is concave up on $(\frac{5\pi}{6}, \frac{11\pi}{6})$. At $x = \frac{5\pi}{6}$ and $x = \frac{11\pi}{6}$ there are points of inflection.

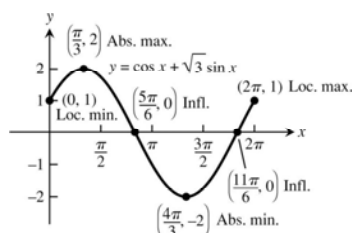

29. When $y = x^{1/5}$, then $y' = \frac{1}{5}x^{-4/5}$ and $y'' = -\frac{4}{25}x^{-9/5}$. The curve rises on $(-\infty, \infty)$ and there are no extrema. The curve is concave up on $(-\infty, 0)$ and concave down on $(0, \infty)$. At $x = 0$ there is a point of inflection.

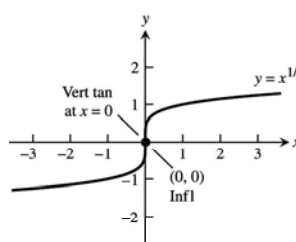

30. When $y = x^{2/5}$, then $y' = \frac{2}{5}x^{-3/5}$ and $y'' = -\frac{6}{25}x^{-8/5}$. The curve is rising on $(0, \infty)$ and falling on $(-\infty, 0)$. At $x = 0$ there is a local and absolute minimum. There is no local or absolute maximum. The curve is concave down on $(-\infty, 0)$ and $(0, \infty)$. There are no points of inflection, but a cusp exists at $x = 0$.

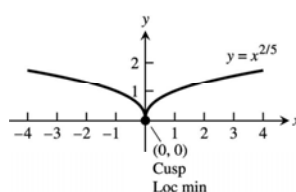

31. When $y = \frac{x}{\sqrt{x^2+1}}$, then $y' = \frac{1}{(x^2+1)^{3/2}}$ and $y'' = \frac{-3x}{(x^2+1)^{5/2}}$. The curve is increasing on $(-\infty, \infty)$.

There are no local or absolute extrema. The curve is concave up on $(-\infty, 0)$ and concave down on $(0, \infty)$. At $x = 0$ there is a point of inflection.

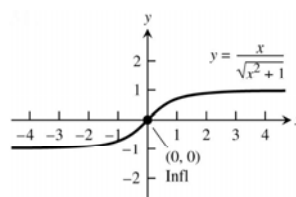

32. When $y = \frac{\sqrt{1-x^2}}{2x+1}$, then $y' = \frac{-(x+2)}{(2x+1)^2 \sqrt{1-x^2}}$ and $y'' = \frac{-4x^3 - 12x^2 + 7}{(2x+1)^3 (1-x^2)^{3/2}}$. The curve is decreasing on $(-1, -\frac{1}{2})$ and $(-\frac{1}{2}, 1)$. There are no absolute extrema, there is a local maximum at $x = -1$ and a local minimum at $x = 1$. The curve is concave up on $(-1, -0.92)$ and $(-\frac{1}{2}, 0.69)$, and concave down on $(-0.92, -\frac{1}{2})$ and $(0.69, 1)$. At $x \approx -0.92$ and $x \approx 0.69$ there are points of inflection.

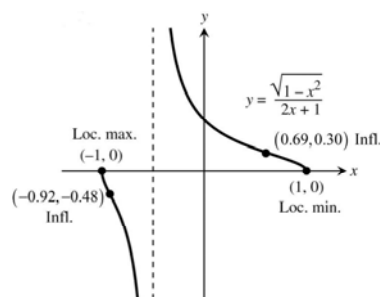

33. When $y = 2x - 3x^{2/3}$, then $y' = 2 - 2x^{-1/3}$ and $y'' = \frac{2}{3}x^{-4/3}$. The curve is rising on $(-\infty, 0)$ and $(1, \infty)$, and falling on $(0, 1)$. There is a local maximum at $x = 0$ and a local minimum at $x = 1$. The curve is concave up on $(-\infty, 0)$ and $(0, \infty)$. There are no points of inflection, but a cusp exists at $x = 0$.

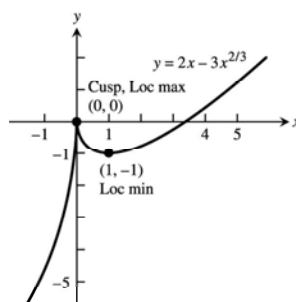

34. When $y = 5x^{2/5} - 2x$, then $y' = 2x^{-3/5} - 2 = 2(x^{-3/5} - 1)$ and $y'' = -\frac{6}{5}x^{-8/5}$. The curve is rising on $(0, 1)$ and falling on $(-\infty, 0)$ and $(1, \infty)$. There is a local minimum at $x = 0$ and a local maximum at $x = 1$. The curve is concave down on $(-\infty, 0)$ and $(0, \infty)$. There are no points of inflection, but a cusp exists at $x = 0$.

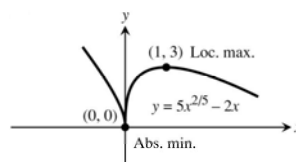

35. When $y = x^{2/3}(\frac{5}{2} - x) = \frac{5}{2}x^{2/3} - x^{5/3}$, then $y' = \frac{5}{3}x^{-1/3} - \frac{5}{3}x^{2/3} = \frac{5}{3}x^{-1/3}(1-x)$ and $y'' = -\frac{5}{9}x^{-4/3} - \frac{10}{9}x^{-1/3} = -\frac{5}{9}x^{-4/3}(1+2x)$. The curve is rising on $(0, 1)$ and falling on $(-\infty, 0)$ and $(1, \infty)$. There is a local minimum at $x = 0$ and a local maximum at $x = 1$. The curve is concave up on $(-\infty, -\frac{1}{2})$ and concave down on $(-\frac{1}{2}, 0)$ and $(0, \infty)$. There is a point of inflection at $x = -\frac{1}{2}$ and a cusp at $x = 0$.

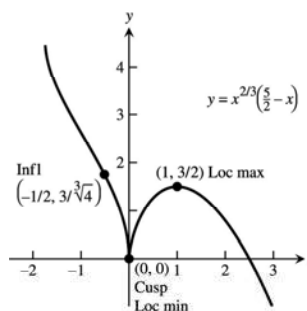

36. When $y = x^{2/3}(x-5) = x^{5/3} - 5x^{2/3}$, then $y' = \frac{5}{3}x^{2/3} - \frac{10}{3}x^{-1/3} = \frac{5}{3}x^{-1/3}(x-2)$ and $y'' = \frac{10}{9}x^{-4/3} + \frac{10}{9}x^{-4/3} = \frac{20}{9}x^{-4/3}(x+1)$. The curve is rising on $(-\infty, 0)$ and $(2, \infty)$, and falling on $(0, 2)$. There is a local minimum at $x = 2$ and a local maximum at $x = 0$. The curve is concave up on $(-1, 0)$ and $(0, \infty)$, and concave down on $(-\infty, -1)$. There is a point of inflection at $x = -1$ and a cusp at $x = 0$.

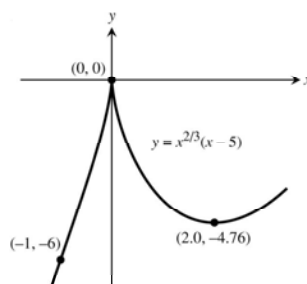

37. When $y = x\sqrt{8-x^2} = x(8-x^2)^{1/2}$, then $y' = (8-x^2)^{1/2} + (x)\left(\frac{1}{2}\right)(8-x^2)^{-1/2}(-2x) = (8-x^2)^{-1/2}(8-2x^2) = \frac{2(2-x)(2+x)}{\sqrt{(2\sqrt{2}+x)(2\sqrt{2}-x)}}$ and $y'' = \left(-\frac{1}{2}\right)(8-x^2)^{-3/2}(-2x)(8-2x^2) + (8-x^2)^{-1/2}(-4x) = \frac{2x(x^2-12)}{\sqrt{(8-x^2)^3}}$. The curve is rising on $(-2, 2)$, and falling on $(-2\sqrt{2}, -2)$ and $(2, 2\sqrt{2})$. There are local minima at $x = -2$ and $x = 2\sqrt{2}$, and local maxima at $x = -2\sqrt{2}$ and $x = 2$. The curve is concave up on $(-2\sqrt{2}, 0)$ and concave down on $(0, 2\sqrt{2})$. There is a point of inflection at $x = 0$.

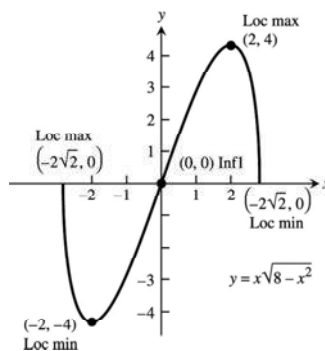

38. When $y = (2-x^2)^{3/2}$, then $y' = \left(\frac{3}{2}\right)(2-x^2)^{1/2}(-2x) = -3x\sqrt{2-x^2} = -3x\sqrt{(\sqrt{2}-x)(\sqrt{2}+x)}$ and $y'' = (-3)(2-x^2)^{1/2} + (-3x)\left(\frac{1}{2}\right)(2-x^2)^{-1/2}(-2x) = \frac{-6(1-x)(1+x)}{\sqrt{(\sqrt{2}-x)(\sqrt{2}+x)}}$. The curve is rising on $(-\sqrt{2}, 0)$ and falling on $(0, \sqrt{2})$. There is a local maximum at $x = 0$, and local minima at $x = \pm\sqrt{2}$. The curve is concave down on $(-1, 1)$ and concave up on $(-\sqrt{2}, -1)$ and $(1, \sqrt{2})$. There are points of inflection at $x = \pm 1$.

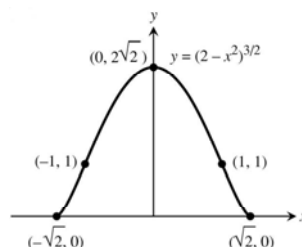

39. When $y = \sqrt{16-x^2}$, then $y' = \frac{-x}{\sqrt{16-x^2}}$ and $y'' = \frac{-16}{(16-x^2)^{3/2}}$. The curve is rising on $(-4, 0)$ and falling on $(0, 4)$. There is a local and absolute maximum at $x = 0$ and local and absolute minima at $x = -4$ and $x = 4$. The curve is concave down on $(-4, 4)$. There are no points of inflection.

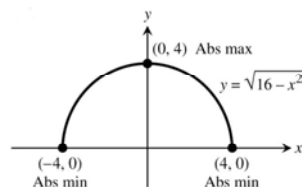

40. When $y = x^2 + \frac{2}{x}$, then $y' = 2x - \frac{2}{x^2} = \frac{2x^3 - 2}{x^2}$ and $y'' = 2 + \frac{4}{x^3} = \frac{2x^3 + 4}{x^3}$. The curve is falling on $(-\infty, 0)$ and $(0, 1)$, and rising on $(1, \infty)$. There is a local minimum at $x = 1$. There are no absolute maxima or absolute minima. The curve is concave up on $(-\infty, -\sqrt[3]{2})$ and $(0, \infty)$, and concave down on $(-\sqrt[3]{2}, 0)$. There is a point of inflection at $x = -\sqrt[3]{2}$.

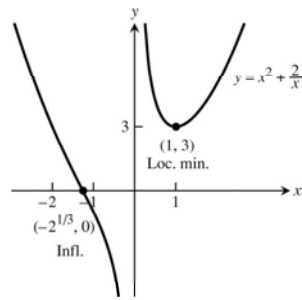

41. When $y = \frac{x^2 - 3}{x - 2}$, then $y' = \frac{2x(x-2) - (x^2 - 3)(1)}{(x-2)^2} = \frac{(x-3)(x-1)}{(x-2)^2}$ and $y'' = \frac{(2x-4)(x-2)^2 - (x^2 - 4x + 3)2(x-2)}{(x-2)^4} = \frac{2}{(x-2)^3}$. The curve is rising on $(-\infty, 1)$ and $(3, \infty)$, and falling on $(1, 2)$ and $(2, 3)$. There is a local maximum at $x = 1$ and a local minimum at $x = 3$. The curve is concave down on $(-\infty, 2)$ and concave up on $(2, \infty)$. There are no points of inflection because $x = 2$ is not in the domain.

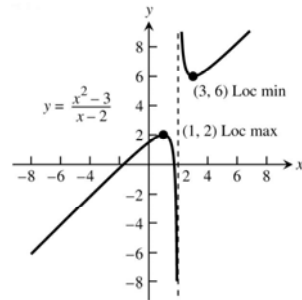

42. When $y = \sqrt[3]{x^3 + 1}$, then $y' = \frac{x^2}{(x^3 + 1)^{2/3}}$ and $y'' = \frac{2x}{(x^3 + 1)^{5/3}}$. The curve is rising on $(-\infty, -1)$, $(-1, 0)$, and $(0, \infty)$. There are no local or absolute extrema. The curve is concave up on $(-\infty, -1)$ and $(0, \infty)$, and concave down on $(-1, 0)$. There are points of inflection at $x = -1$ and $x = 0$.

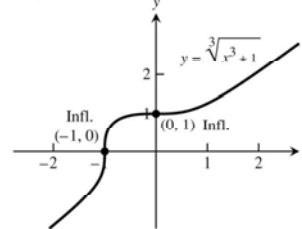

43. When $y = \frac{8x}{x^2 + 4}$, then $y' = \frac{-8(x^2 - 4)}{(x^2 + 4)^2}$ and $y'' = \frac{16x(x^2 - 12)}{(x^2 + 4)^3}$. The curve is falling on $(-\infty, -2)$ and $(2, \infty)$, and is rising on $(-2, 2)$. There is a local and absolute minimum at $x = -2$, and a local and absolute maximum at $x = 2$. The curve is concave down on $(-\infty, -2\sqrt{3})$ and $(0, 2\sqrt{3})$, and concave up on $(-2\sqrt{3}, 0)$ and $(2\sqrt{3}, \infty)$. There are points of inflection at $x = -2\sqrt{3}$, $x = 0$, and $x = 2\sqrt{3}$. $y = 0$ is a horizontal asymptote.

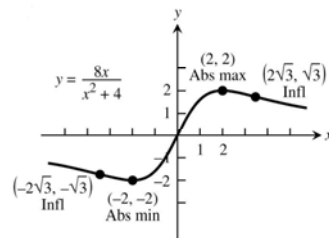

44. When $y = \frac{5}{x^4 + 5}$, then $y' = \frac{-20x^3}{(x^4 + 5)^2}$ and $y'' = \frac{100x^2(x^4 - 3)}{(x^4 + 5)^3}$. The curve is rising on $(-\infty, 0)$, and is falling on $(0, \infty)$. There is a local and absolute maximum at $x = 0$, and there is no local or absolute minimum. The curve is concave up on $(-\infty, -\sqrt[4]{3})$ and $(\sqrt[4]{3}, \infty)$, and concave down on $(-\sqrt[4]{3}, 0)$ and $(0, \sqrt[4]{3})$. There are points of inflection at $x = -\sqrt[4]{3}$ and $x = \sqrt[4]{3}$. There is a horizontal asymptote of $y = 0$.

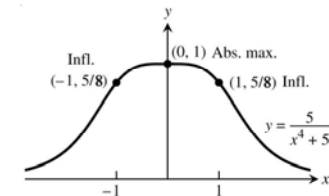

45. When $y = |x^2 - 1| = \begin{cases} x^2 - 1, & |x| \geq 1 \\ 1 - x^2, & |x| < 1 \end{cases}$, then $y' = \begin{cases} 2x, & |x| > 1 \\ -2x, & |x| < 1 \end{cases}$ and $y'' = \begin{cases} 2, & |x| > 1 \\ -2, & |x| < 1 \end{cases}$. The curve rises on $(-1, 0)$ and $(1, \infty)$ and falls on $(-\infty, -1)$ and $(0, 1)$. There is a local maximum at $x = 0$ and local minima at $x = \pm 1$. The curve is concave up on $(-\infty, -1)$ and $(1, \infty)$, and concave down on $(-1, 1)$. There are no points of inflection because y is not differentiable at $x = \pm 1$ (so there is no tangent line at those points).

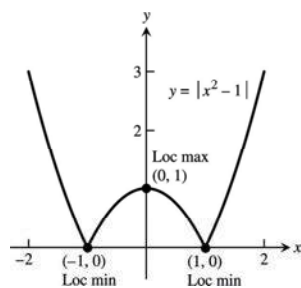

46. When $y = |x^2 - 2x| = \begin{cases} x^2 - 2x, & x < 0 \\ 2x - x^2, & 0 \leq x \leq 2 \\ x^2 - 2x, & x > 2 \end{cases}$ then $y' = \begin{cases} 2x - 2, & x < 0 \\ 2 - 2x, & 0 < x < 2 \\ 2x - 2, & x > 2 \end{cases}$ and $y'' = \begin{cases} 2, & x < 0 \\ -2, & 0 < x < 2 \\ 2, & x > 2 \end{cases}$.

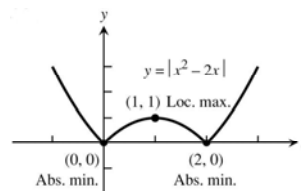

The curve is rising on $(0, 1)$ and $(2, \infty)$, and falling on $(-\infty, 0)$ and $(1, 2)$. There is a local maximum at $x = 1$ and local minima at $x = 0$ and $x = 2$. The curve is concave up on $(-\infty, 0)$ and $(2, \infty)$, and concave down on $(0, 2)$. There are no points of inflection because y is not differentiable at $x = 0$ and $x = 2$ (so there is no tangent at those points).

47. When $y = \sqrt{|x|} = \begin{cases} \sqrt{x}, & x \geq 0 \\ \sqrt{-x}, & x < 0 \end{cases}$, then $y' = \begin{cases} \frac{1}{2\sqrt{x}}, & x > 0 \\ \frac{-1}{2\sqrt{-x}}, & x < 0 \end{cases}$ and $y'' = \begin{cases} \frac{-x^{-3/2}}{4}, & x > 0 \\ \frac{-(-x)^{-3/2}}{4}, & x < 0 \end{cases}$.

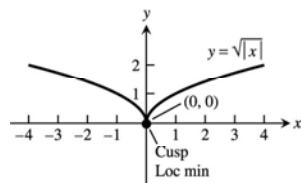

Since $\lim_{x \rightarrow 0^-} y' = -\infty$ and $\lim_{x \rightarrow 0^+} y' = \infty$ there is a cusp at $x = 0$. There is a local minimum at $x = 0$, but no local maximum. The curve is concave down on $(-\infty, 0)$ and $(0, \infty)$. There are no points of inflection.

48. When $y = \sqrt{|x - 4|} = \begin{cases} \sqrt{x - 4}, & x \geq 4 \\ \sqrt{4 - x}, & x < 4 \end{cases}$, then $y' = \begin{cases} \frac{1}{2\sqrt{x - 4}}, & x > 4 \\ \frac{-1}{2\sqrt{4 - x}}, & x < 4 \end{cases}$ and $y'' = \begin{cases} \frac{-(x - 4)^{-3/2}}{4}, & x > 4 \\ \frac{-(4 - x)^{-3/2}}{4}, & x < 4 \end{cases}$.

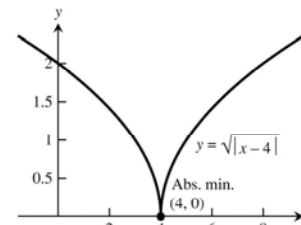

Since $\lim_{x \rightarrow 4^-} y' = -\infty$ and $\lim_{x \rightarrow 4^+} y' = \infty$ there is a cusp at $x = 4$. There is a local minimum at $x = 4$, but no local maximum. The curve is concave down on $(-\infty, 4)$ and $(4, \infty)$. There are no points of inflection.

49. When $y = xe^{1/x}$, then $y' = -\frac{xe^{1/x}}{x^2} + e^{1/x} = e^{1/x} \left(1 - \frac{1}{x}\right)$

and $y'' = e^{1/x} \left(\frac{1}{x^2}\right) + \left(1 - \frac{1}{x}\right) \left(-\frac{e^{1/x}}{x^2}\right) = \frac{e^{1/x}}{x^2} \left(\frac{1}{x}\right) = \frac{e^{1/x}}{x^3}$.

The curve is rising on $(1, \infty)$ and $(-\infty, 0)$ and falling on $(0, 1)$. The curve is concave down on $(-\infty, 0)$ and concave up on $(0, \infty)$. There is a local minimum of e at $x = 1$, but there are no inflection points.

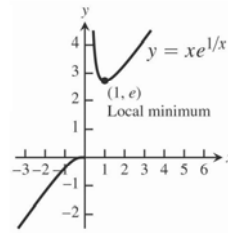

50. $y = \frac{e^x}{x} \Rightarrow y' = \frac{xe^x - e^x}{x^2} = \frac{(x-1)e^x}{x^2}$

$\Rightarrow y' = \begin{matrix} - & - & - & | & - & - & - & | & + & + & + \\ 0 & & & & 1 & & & & & & \end{matrix} \Rightarrow$ the graph is rising on

$(1, \infty)$, falling on $(-\infty, 0)$ and $(0, 1)$; a local minimum is e

at $x = 1$; $y'' = \frac{x^2(xe^x + e^x - e^x) - (xe^x - e^x)(2x)}{x^4} = \frac{(x^2 - 2x + 2)e^x}{x^3}$

$\Rightarrow y'' = \begin{matrix} - & - & - & | & + & + & + \\ 0 & & & & & & \end{matrix} \Rightarrow$ the graph is concave up on

$(0, \infty)$, concave down on $(-\infty, 0)$, but has no inflection points.

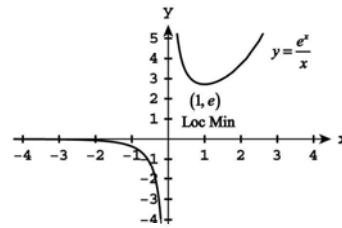

51. $y = \ln(3-x^2) \Rightarrow y' = \frac{-2x}{3-x^2} = \frac{2x}{x^2-3}$

$\Rightarrow y' = \begin{pmatrix} + & + & + & | & - & - & - \\ -\sqrt{3} & & & & 0 & & \sqrt{3} \end{pmatrix} \Rightarrow$ the graph is rising on

$(-\sqrt{3}, 0)$, falling on $(0, \sqrt{3})$; a local minimum is $\ln 3$ at

$x = 0$; $y'' = \frac{(x^2-3)(2) - (2x)(2x)}{(x^2-3)^2} = \frac{-2(x^2+3)}{(x^2-3)^2}$

$\Rightarrow y'' = \begin{pmatrix} - & - & - & \\ -\sqrt{3} & & & \sqrt{3} \end{pmatrix} \Rightarrow$ the graph is concave down on

$(-\sqrt{3}, \sqrt{3})$.

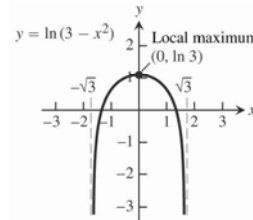

52. $y = x(\ln x)^2$

$\Rightarrow y' = x \cdot 2 \ln x \cdot \left(\frac{1}{x}\right) + (1) \cdot (\ln x)^2 = \ln x(2 + \ln x)$

$\Rightarrow y' = \begin{matrix} + & + & + & | & - & - & - & | & + & + & + \\ 0 & & & & e^{-2} & & 1 & & & & \end{matrix} \Rightarrow$ the graph is rising on

$(0, e^{-2})$ and $(1, \infty)$, falling on $(e^{-2}, 1)$; a local maximum is $4e^{-2}$ at $x = e^{-2}$ and a local minimum is 0 at $x = 1$; $y'' = \ln x \cdot \left(\frac{1}{x}\right) + \left(\frac{1}{x}\right)(2 + \ln x) = \frac{2(1+\ln x)}{x}$

$\Rightarrow y'' = \begin{matrix} - & - & - & | & + & + & + \\ 0 & & & & e^{-1} & & \end{matrix} \Rightarrow$ the graph is concave up on

(e^{-1}, ∞) , concave down on $(0, e^{-1}) \Rightarrow$ point of inflection at (e^{-1}, e^{-1}) .

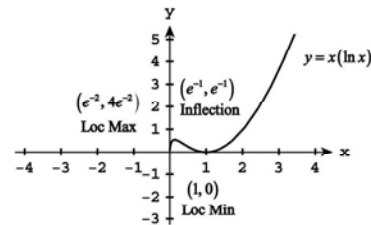

53. $y = e^x - 2e^{-x} - 3x$

$\Rightarrow y' = e^x + 2e^{-x} - 3 = \frac{(e^x)^2 - 3e^x + 2}{e^x} = \frac{(e^x - 2)(e^x - 1)}{e^x}$

$\Rightarrow y' = \begin{matrix} + & + & + \\ | & - & - & - \\ 0 & & \ln 2 \end{matrix} \Rightarrow$ the graph is increasing

on $(-\infty, 0)$ and $(\ln 2, \infty)$, decreasing on $(0, \ln 2)$; a local maximum is -1 at $x = 0$ and a local minimum is

$1 - 3 \ln 2$ at $x = \ln 2$; $y'' = e^x - 2e^{-x} = \frac{(e^x)^2 - 2}{e^x}$

$\Rightarrow y'' = \begin{matrix} - & - & - & - \\ | & + & + & + \\ \frac{1}{2} \ln 2 \end{matrix} \Rightarrow$ the graph is concave up on

$(\frac{1}{2} \ln 2, \infty)$, concave down on $(-\infty, \frac{1}{2} \ln 2) \Rightarrow$ point of inflection at $(\frac{1}{2} \ln 2, -\frac{3}{2} \ln 2)$.

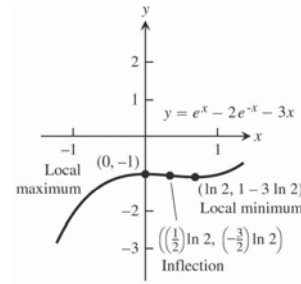

54. $y = xe^{-x} \Rightarrow y' = e^{-x} - xe^{-x} = (1-x)e^{-x}$

$\Rightarrow y' = \begin{matrix} + & + & + \\ | & - & - & - \\ 1 \end{matrix} \Rightarrow$ the graph is increasing on $(-\infty, 1)$

and decreasing on $(1, \infty)$; a local maximum is e^{-1} at

$x = 1$; $y'' = (x-1)e^{-x} + (-1)e^{-x} = (x-2)e^{-x}$

$\Rightarrow y'' = \begin{matrix} - & - & - \\ | & + & + & + \\ 2 \end{matrix} \Rightarrow$ the graph is concave up on

$(2, \infty)$, concave down on $(-\infty, 2) \Rightarrow$ point of inflection at $(2, 2e^{-2})$.

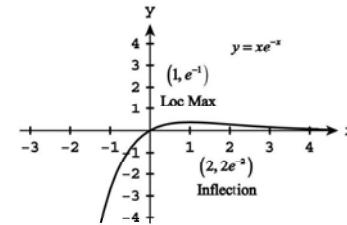

55. $y = \ln(\cos x) \Rightarrow y' = \frac{-\sin x}{\cos x} = -\tan x$

$\Rightarrow y' = \dots \begin{matrix}) & \text{none} & (& + & + & + \\ | & - & - & - & - \\ -\frac{7\pi}{2} & -\frac{5\pi}{2} & -2\pi & -\frac{3\pi}{2} & -\frac{\pi}{2} & 0 & \frac{\pi}{2} & \frac{3\pi}{2} & 2\pi & \frac{5\pi}{2} & \frac{7\pi}{2} \end{matrix}$

\Rightarrow the graph is increasing on $\dots, (-\frac{5\pi}{2}, -2\pi), (-\frac{\pi}{2}, 0), (\frac{3\pi}{2}, 2\pi), \dots$, decreasing on $(-2\pi, -\frac{3\pi}{2}), (0, \frac{\pi}{2}), (2\pi, \frac{5\pi}{2});$

local maxima are 0 at $x = 0, \pm 2\pi, \pm 4\pi, \dots$; $y'' = -\sec^2 x \cdot \frac{-1}{\cos^2 x} \Rightarrow$

the graph is concave down on $(-\frac{5\pi}{2}, -\frac{3\pi}{2}),$

$(-\frac{\pi}{2}, \frac{\pi}{2}), (\frac{3\pi}{2}, \frac{5\pi}{2}), \dots$

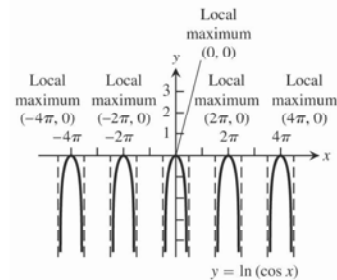

56. $y = \frac{\ln x}{\sqrt{x}} \Rightarrow y' = \frac{\sqrt{x}(\frac{1}{x}) - \ln x \cdot \frac{1}{2\sqrt{x}}}{(\sqrt{x})^2} = \frac{2 - \ln x}{2x^{3/2}} \Rightarrow y' = \begin{matrix} + & + & + \\ | & - & - & - \\ 0 & & e^2 \end{matrix}$

\Rightarrow the graph is increasing on $(0, e^2)$, decreasing on (e^2, ∞) ; a local maximum is $\frac{2}{e}$ at $x = e^2$;

$y'' = \frac{2x^{3/2}(-\frac{1}{x}) - (2 - \ln x) \cdot 2 \cdot \frac{1}{2} x^{1/2}}{(2x^{3/2})^2} = \frac{3 \ln x - 8}{4x^{5/2}}$

$\Rightarrow y'' = \begin{matrix} - & - & - \\ | & + & + & + \\ 0 & & e^{8/3} \end{matrix} \Rightarrow$ the graph is concave up on $(e^{8/3}, \infty)$,

concave down on $(0, e^{8/3}) \Rightarrow$ point of inflection is $(e^{8/3}, \frac{8}{3e^{4/3}})$.

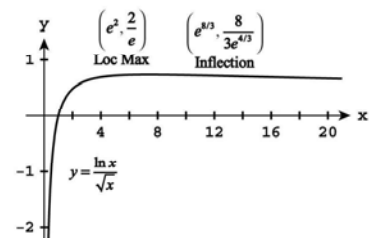

57. $y = \frac{1}{1+e^{-x}} = \frac{e^x}{e^x+1} \Rightarrow y' = \frac{(e^x+1)e^x - e^x \cdot e^x}{(e^x+1)^2} = \frac{e^x}{(e^x+1)^2}$
 $\Rightarrow y' = + + + \Rightarrow$ the graph is increasing on $(-\infty, \infty)$;
 $y'' = \frac{(e^x+1)^2 \cdot e^x - e^x \cdot 2(e^x+1)e^x}{(e^x+1)^4} = \frac{e^x(1-e^x)}{(e^x+1)^3}$
 $\Rightarrow y'' = + + + | - - - \Rightarrow$ the graph is concave up on $(-\infty, 0)$, concave down on $(0, \infty) \Rightarrow$ point of inflection is $(0, \frac{1}{2})$.

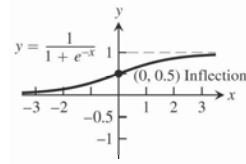

58. $y = \frac{e^x}{1+e^x} \Rightarrow y' = \frac{(e^x+1)e^x - e^x \cdot e^x}{(1+e^x)^2} = \frac{e^x}{(1+e^x)^2}$
 $\Rightarrow y' = + + + \Rightarrow$ the graph is increasing on $(-\infty, \infty)$;
 $y'' = \frac{(e^x+1)^2 \cdot e^x - e^x \cdot 2(e^x+1)e^x}{(1+e^x)^4} = \frac{e^x(1-e^x)}{(1+e^x)^3}$
 $\Rightarrow y'' = + + + | - - - \Rightarrow$ the graph is concave up on $(-\infty, 0)$, concave down on $(0, \infty) \Rightarrow$ point of inflection is $(0, \frac{1}{2})$.

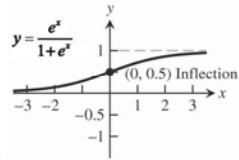

59. $y' = 2 + x - x^2 = (1+x)(2-x), y' = - - - | + + + | - - -$
 \Rightarrow rising on $(-1, 2)$, falling on $(-\infty, -1)$ and $(2, \infty)$
 \Rightarrow there is a local maximum at $x = 2$ and a local minimum at $x = -1$; $y'' = 1 - 2x, y'' = + + + | - - -$
 \Rightarrow concave up on $(-\infty, \frac{1}{2})$, concave down on $(\frac{1}{2}, \infty)$
 \Rightarrow a point of inflection at $x = \frac{1}{2}$

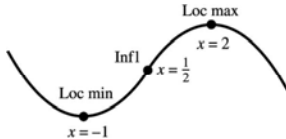

60. $y' = x^2 - x - 6 = (x-3)(x+2), y' = + + + | - - - | + + +$
 \Rightarrow rising on $(-\infty, -2)$ and $(3, \infty)$, falling on $(-2, 3)$
 \Rightarrow there is a local maximum at $x = -2$ and a local minimum at $x = 3$; $y'' = 2x - 1, y'' = - - - | + + +$
 \Rightarrow concave up on $(\frac{1}{2}, \infty)$, concave down on $(-\infty, \frac{1}{2})$
 \Rightarrow a point of inflection at $x = \frac{1}{2}$

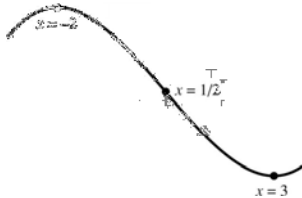

61. $y' = x(x-3)^2, y' = - - - | + + + | + + + \Rightarrow$ rising on $(0, \infty)$, falling on $(-\infty, 0) \Rightarrow$ no local maximum, but there is a local minimum at $x = 0$; $y'' = (x-3)^2 + x(2)(x-3) = 3(x-3)(x-1), y'' = + + + | - - - | + + + \Rightarrow$ concave up on $(-\infty, 1)$ and $(3, \infty)$, concave down on $(1, 3) \Rightarrow$ points of inflection at $x = 1$ and $x = 3$

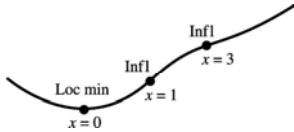

62. $y' = x^2(2-x), y' = + + + | + + + | - - - \Rightarrow$ rising on $(-\infty, 2)$, falling on $(2, \infty) \Rightarrow$ there is a local maximum at $x = 2$, but no local minimum; $y'' = 2x(2-x) + x^2(-1) = x(4-3x), y'' = - - - | + + + | - - - \Rightarrow$ concave up on $(0, \frac{4}{3})$, concave down on $(-\infty, 0)$ and $(\frac{4}{3}, \infty) \Rightarrow$ points of inflection at $x = 0$ and $x = \frac{4}{3}$

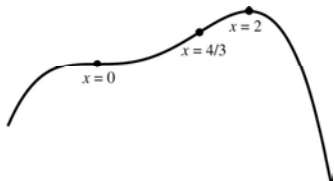

63. $y' = x(x^2 - 12) = x(x - 2\sqrt{3})(x + 2\sqrt{3})$,
 $y' = \text{---} \mid \text{+++} \mid \text{---} \mid \text{+++} \Rightarrow$ rising on $(-2\sqrt{3}, 0)$ and $(2\sqrt{3}, \infty)$, falling on $(-\infty, -2\sqrt{3})$ and $(0, 2\sqrt{3}) \Rightarrow$ a local maximum at $x = 0$, local minima at $x = \pm 2\sqrt{3}$; $y'' = 1(x^2 - 12) + x(2x) = 3(x - 2)(x + 2)$,
 $y'' = \text{+++} \mid \text{---} \mid \text{+++} \Rightarrow$ concave up on $(-\infty, -2)$ and $(2, \infty)$, concave down on $(-2, 2) \Rightarrow$ points of inflection at $x = \pm 2$

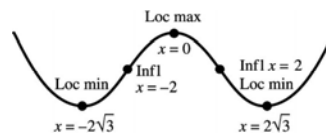

64. $y' = (x - 1)^2(2x + 3)$, $y' = \text{---} \mid \text{+++} \mid \text{+++} \Rightarrow$ rising on $(-\frac{3}{2}, \infty)$, falling on $(-\infty, -\frac{3}{2}) \Rightarrow$ no local maximum, a local minimum at $x = -\frac{3}{2}$;
 $y'' = 2(x - 1)(2x + 3) + (x - 1)^2(2) = 2(x - 1)(3x + 2)$,
 $y'' = \text{+++} \mid \text{---} \mid \text{+++} \Rightarrow$ concave up on $(-\infty, -\frac{2}{3})$ and $(1, \infty)$, concave down on $(-\frac{2}{3}, 1) \Rightarrow$ points of inflection at $x = -\frac{2}{3}$ and $x = 1$

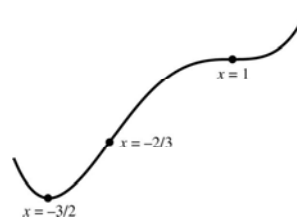

65. $y' = (8x - 5x^2)(4 - x)^2 = x(8 - 5x)(4 - x)^2$,
 $y' = \text{---} \mid \text{+++} \mid \text{---} \mid \text{---} \Rightarrow$ rising on $(0, \frac{8}{5})$, falling on $(-\infty, 0)$ and $(\frac{8}{5}, \infty) \Rightarrow$ a local maximum at $x = \frac{8}{5}$, a local minimum at $x = 0$;
 $y'' = (8 - 10x)(4 - x)^2 + (8x - 5x^2)(2)(4 - x)(-1) = 4(4 - x)(5x^2 - 16x + 8)$, $y'' = \text{+++} \mid \text{---} \mid \text{+++} \mid \text{---} \Rightarrow$
 $\frac{8-2\sqrt{6}}{5} \quad \frac{8+2\sqrt{6}}{5} \quad 4$
 concave up on $(-\infty, \frac{8-2\sqrt{6}}{5})$ and $(\frac{8+2\sqrt{6}}{5}, 4)$, concave down on $(\frac{8-2\sqrt{6}}{5}, \frac{8+2\sqrt{6}}{5})$ and $(4, \infty) \Rightarrow$ points of inflection at $x = \frac{8 \pm 2\sqrt{6}}{5}$ and $x = 4$

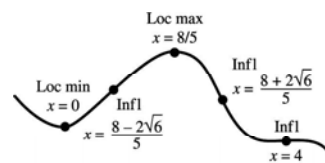

66. $y' = (x^2 - 2x)(x - 5)^2 = x(x - 2)(x - 5)^2$,
 $y' = \text{+++} \mid \text{---} \mid \text{+++} \mid \text{+++} \Rightarrow$ rising on $(-\infty, 0)$ and $(2, \infty)$, falling on $(0, 2) \Rightarrow$ a local maximum at $x = 0$, a local minimum at $x = 2$;
 $y'' = (2x - 2)(x - 5)^2 + 2(x^2 - 2x)(x - 5) = 2(x - 5)(2x^2 - 8x + 5)$, $y'' = \text{---} \mid \text{+++} \mid \text{---} \mid \text{+++} \Rightarrow$
 $\frac{4-\sqrt{6}}{2} \quad \frac{4+\sqrt{6}}{2} \quad 5$
 concave up on $(\frac{4-\sqrt{6}}{2}, \frac{4+\sqrt{6}}{2})$ and $(5, \infty)$, concave down on $(-\infty, \frac{4-\sqrt{6}}{2})$ and $(\frac{4+\sqrt{6}}{2}, 5) \Rightarrow$ points of inflection at $x = \frac{4 \pm \sqrt{6}}{2}$ and $x = 5$

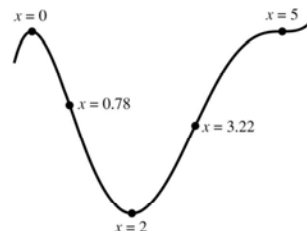

67. $y' = \sec^2 x, y' = (\begin{smallmatrix} + & + & + \\ -\pi/2 & & \pi/2 \end{smallmatrix}) \Rightarrow$ rising on $(-\frac{\pi}{2}, \frac{\pi}{2})$, never falling
 \Rightarrow no local extrema;
 $y'' = 2(\sec x)(\sec x)(\tan x) = 2(\sec^2 x)(\tan x),$
 $y'' = (\begin{smallmatrix} - & - & - & | & + & + & + \\ -\pi/2 & & 0 & & \pi/2 \end{smallmatrix}) \Rightarrow$ concave up on $(0, \frac{\pi}{2})$, concave down
 on $(-\frac{\pi}{2}, 0)$, 0 is a point of inflection.

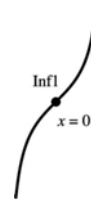

68. $y' = \tan x, y' = (\begin{smallmatrix} - & - & - & | & + & + & + \\ -\pi/2 & & 0 & & \pi/2 \end{smallmatrix}) \Rightarrow$ rising on $(0, \frac{\pi}{2})$, falling on
 $(-\frac{\pi}{2}, 0) \Rightarrow$ no local maximum, a local minimum at
 $x=0; y'' = \sec^2 x, y'' = (\begin{smallmatrix} + & + & + \\ -\pi/2 & & \pi/2 \end{smallmatrix})$
 \Rightarrow concave up on $(-\frac{\pi}{2}, \frac{\pi}{2}) \Rightarrow$ no points of inflection

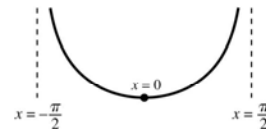

69. $y' = \cot \frac{\theta}{2}, y' = (\begin{smallmatrix} + & + & + & | & - & - & - \\ 0 & \pi & 2\pi \end{smallmatrix}) \Rightarrow$ rising on $(0, \pi)$, falling on
 $(\pi, 2\pi) \Rightarrow$ a local maximum at $\theta = \pi$, no
 local minimum; $y'' = -\frac{1}{2} \csc^2 \frac{\theta}{2}, y'' = (\begin{smallmatrix} - & - & - & - \\ 0 & \pi & 2\pi \end{smallmatrix}) \Rightarrow$ never concave
 up, concave down on $(0, 2\pi) \Rightarrow$ no points of inflection

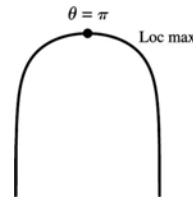

70. $y' = \csc^2 \frac{\theta}{2}, y' = (\begin{smallmatrix} + & + & + \\ 0 & 2\pi \end{smallmatrix}) \Rightarrow$ rising on $(0, 2\pi)$, never falling \Rightarrow
 no local extrema;
 $y'' = 2(\csc \frac{\theta}{2})(-\csc \frac{\theta}{2})(\cot \frac{\theta}{2})(\frac{1}{2})$
 $= -(\csc^2 \frac{\theta}{2})(\cot \frac{\theta}{2}), y'' = (\begin{smallmatrix} - & - & - & | & + & + & + \\ 0 & \pi & 2\pi \end{smallmatrix})$
 \Rightarrow concave up on $(\pi, 2\pi)$, concave down on $(0, \pi)$
 \Rightarrow a point of inflection at $\theta = \pi$

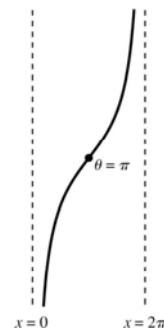

71. $y' = \tan^2 \theta - 1 = (\tan \theta - 1)(\tan \theta + 1),$
 $y' = (\begin{smallmatrix} + & + & + & | & - & - & - & | & + & + & + \\ -\pi/2 & & -\pi/4 & & \pi/4 & & \pi/2 \end{smallmatrix}) \Rightarrow$ rising on $(-\frac{\pi}{2}, -\frac{\pi}{4})$ and
 $(\frac{\pi}{4}, \frac{\pi}{2})$, falling on $(-\frac{\pi}{4}, \frac{\pi}{4}) \Rightarrow$ a local maximum at $\theta = -\frac{\pi}{4}$, a
 local minimum at $\theta = \frac{\pi}{4}; y'' = 2 \tan \theta \sec^2 \theta,$
 $y'' = (\begin{smallmatrix} - & - & - & | & + & + & + \\ -\pi/2 & & 0 & & \pi/2 \end{smallmatrix}) \Rightarrow$ concave up on $(0, \frac{\pi}{2})$, concave down
 on $(-\frac{\pi}{2}, 0) \Rightarrow$ a point of inflection at $\theta = 0$

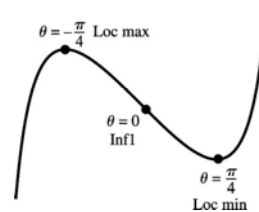

72. $y' = 1 - \cot^2 \theta = (1 - \cot \theta)(1 + \cot \theta)$,
 $y' = (--- | +++ | ---) \Rightarrow$ rising on $(\frac{\pi}{4}, \frac{3\pi}{4})$, falling on
 $(0, \frac{\pi}{4})$ and $(\frac{3\pi}{4}, \pi) \Rightarrow$ a local maximum
 at $\theta = \frac{3\pi}{4}$, a local minimum at $\theta = \frac{\pi}{4}$;
 $y'' = -2(\cot \theta)(-\csc^2 \theta)$, $y'' = (+++ | ---)$
 \Rightarrow concave up on $(0, \frac{\pi}{2})$, concave down on $(\frac{\pi}{2}, \pi)$
 \Rightarrow a point of inflection at $\theta = \frac{\pi}{2}$

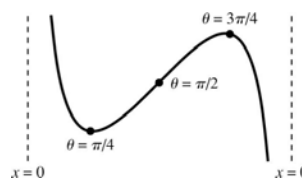

73. $y' = \cos t$, $y' = [+++ | --- | +++]$ \Rightarrow rising on $(0, \frac{\pi}{2})$ and
 $(\frac{3\pi}{2}, 2\pi)$, falling on $(\frac{\pi}{2}, \frac{3\pi}{2}) \Rightarrow$ local maxima at $t = \frac{\pi}{2}$ and $t = 2\pi$,
 local minima at $t = 0$ and $t = \frac{3\pi}{2}$; $y'' = -\sin t$, $y'' = [--- | +++]$
 \Rightarrow concave up on $(\pi, 2\pi)$, concave down on $(0, \pi) \Rightarrow$ a point of
 inflection at $t = \pi$

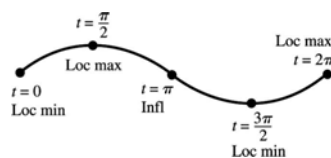

74. $y' = \sin t$, $y' = [+++ | ---]$ \Rightarrow rising on $(0, \pi)$, falling on
 $(\pi, 2\pi) \Rightarrow$ a local maximum at $t = \pi$,
 local minima at $t = 0$ and $t = 2\pi$; $y'' = \cos t$,
 $y'' = [+++ | --- | +++]$ \Rightarrow concave up on $(0, \frac{\pi}{2})$ and
 $(\frac{3\pi}{2}, 2\pi)$, concave down on $(\frac{\pi}{2}, \frac{3\pi}{2})$
 \Rightarrow points of inflection at $t = \frac{\pi}{2}$ and $t = \frac{3\pi}{2}$



75. $y' = (x+1)^{-2/3}$, $y' = +++$ \Rightarrow rising on $(-\infty, \infty)$, never
 falling \Rightarrow no local extrema; $y'' = -\frac{2}{3}(x+1)^{-5/3}$, $y'' = +++$ \Rightarrow concave up on $(-\infty, -1)$, concave down on $(-1, \infty) \Rightarrow$ a point of
 inflection and vertical tangent at $x = -1$

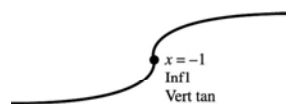

76. $y' = (x-2)^{-1/3}$, $y' = ---$ \Rightarrow rising on $(2, \infty)$, falling on
 $(-\infty, 2) \Rightarrow$ no local maximum, but a local minimum at
 $x = 2$; $y'' = -\frac{1}{3}(x-2)^{-4/3}$, $y'' = ---$ \Rightarrow concave down on
 $(-\infty, 2)$ and $(2, \infty) \Rightarrow$ no points of inflection, but there is a cusp at
 $x = 2$

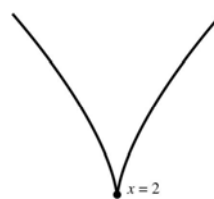

77. $y' = x^{-2/3}(x-1)$, $y' = \text{---} | \text{---} | \text{+++} \Rightarrow$ rising on $(1, \infty)$, falling on $(-\infty, 1) \Rightarrow$ no local maximum, but a local minimum at $x = 1$; $y'' = \frac{1}{3}x^{-2/3} + \frac{2}{3}x^{-5/3} = \frac{1}{3}x^{-5/3}(x+2)$, $y'' = \text{+++} | \text{---} | \text{+++} \Rightarrow$ concave up on $(-\infty, -2)$ and $(0, \infty)$, concave down on $(-2, 0) \Rightarrow$ points of inflection at $x = -2$ and $x = 0$, and a vertical tangent at $x = 0$

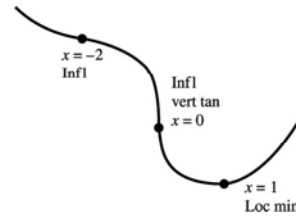

78. $y' = x^{-4/5}(x+1)$, $y' = \text{---} | \text{+++} | \text{+++} \Rightarrow$ rising on $(-1, 0)$ and $(0, \infty)$, falling on $(-\infty, -1) \Rightarrow$ no local maximum, but a local minimum at $x = -1$; $y'' = \frac{1}{5}x^{-4/5} - \frac{4}{5}x^{-9/5} = \frac{1}{5}x^{-9/5}(x-4)$, $y'' = \text{+++} | \text{---} | \text{+++} \Rightarrow$ concave up on $(-\infty, 0)$ and $(4, \infty)$, concave down on $(0, 4) \Rightarrow$ points of inflection at $x = 0$ and $x = 4$, and a vertical tangent at $x = 0$

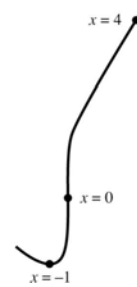

79. $y' = \begin{cases} -2x, & x \leq 0 \\ 2x, & x > 0 \end{cases}$, $y' = \text{+++} | \text{+++} \Rightarrow$ rising on $(-\infty, \infty) \Rightarrow$ no local extrema; $y'' = \begin{cases} -2, & x < 0 \\ 2, & x > 0 \end{cases}$, $y'' = \text{---} | \text{+++} \Rightarrow$ concave up on $(0, \infty)$, concave down on $(-\infty, 0) \Rightarrow$ a point of inflection at $x = 0$

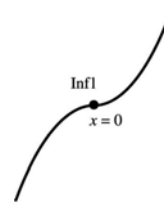

80. $y'' = \begin{cases} -x^2, & x \leq 0 \\ x^2, & x > 0 \end{cases}$, $y' = \text{---} | \text{+++} \Rightarrow$ rising on $(0, \infty)$, falling on $(-\infty, 0) \Rightarrow$ no local maximum, but a local minimum at $x = 0$; $y'' = \begin{cases} -2x, & x \leq 0 \\ 2x, & x > 0 \end{cases}$, $y'' = \text{+++} | \text{+++} \Rightarrow$ concave up on $(-\infty, \infty) \Rightarrow$ no point of inflection



81. The graph of $y = f''(x) \Rightarrow$ the graph of $y = f(x)$ is concave up on $(0, \infty)$, concave down on $(-\infty, 0) \Rightarrow$ a point of inflection at $x = 0$; the graph of $y = f'(x) \Rightarrow y' = \text{+++} | \text{---} | \text{+++} \Rightarrow$ the graph $y = f(x)$ has both a local maximum and a local minimum

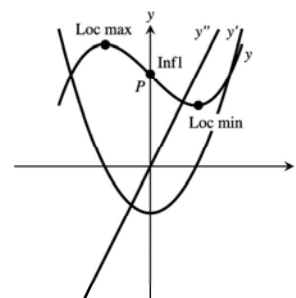

82. The graph of $y = f''(x) \Rightarrow y'' = +++ | --- \Rightarrow$ the graph of $y = f(x)$ has a point of inflection, the graph of $y = f'(x) \Rightarrow y' = --- | +++ | --- \Rightarrow$ the graph of $y = f(x)$ has both a local maximum and a local minimum

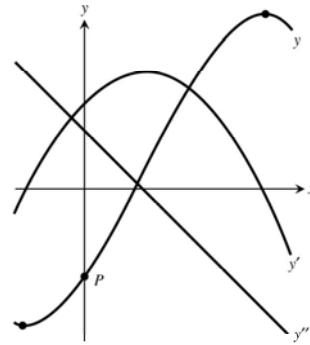

83. The graph of $y = f''(x) \Rightarrow y'' = --- | +++ | --- \Rightarrow$ the graph of $y = f(x)$ has two points of inflection, the graph of $y = f'(x) \Rightarrow y' = --- | +++ \Rightarrow$ the graph of $y = f(x)$ has a local minimum

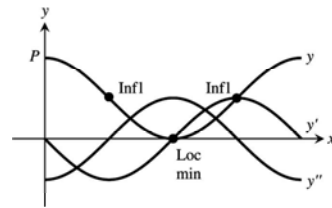

84. The graph of $y = f''(x) \Rightarrow y'' = +++ | --- \Rightarrow$ the graph of $y = f(x)$ has a point of inflection; the graph of $y = f'(x) \Rightarrow y' = --- | +++ | --- \Rightarrow$ the graph of $y = f(x)$ has both a local maximum and a local minimum

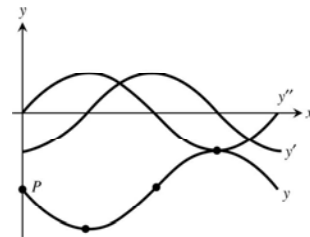

85. $y = \frac{2x^2+x-1}{x^2-1}$

Since -1 and 1 are roots of the denominator, the domain is $(-\infty, -1) \cup (-1, 1) \cup (1, \infty)$.

$$y' = -\frac{1}{(x-1)^2}; \quad y'' = \frac{2}{(x-1)^3} \quad (x \neq -1)$$

There are no critical points. The function is decreasing on its domain. There are no inflection points. The function is concave down on $(-\infty, -1) \cup (-1, 1)$ and concave up on $(1, \infty)$. The numerator and denominator share a factor of $x+1$. Dividing out this common factor gives $y = \frac{2x-1}{x-1}$ ($x \neq 1$), which shows that $x = 1$ is a vertical asymptote. Now dividing numerator and denominator by x gives $y = \frac{2-(1/x)}{1-(1/x)}$, which shows that $y = 2$ is a horizontal asymptote. The graph will have a hole at $x = -1$,

$$y = \frac{2(-1)-1}{1-(-1)} = \frac{3}{2}. \text{ The } x\text{-intercept is } \frac{1}{2}.$$

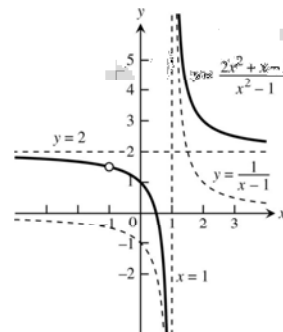

$$86. \quad y = \frac{x^2 - 49}{x^2 + 5x - 14}$$

Since -7 and 2 are roots of the denominator, the domain is $(-\infty, -7) \cup (-7, 2) \cup (2, \infty)$.

$$y' = -\frac{5}{(x-2)^2}; \quad y'' = \frac{-10}{(x-1)^3} \quad (x \neq -7)$$

There are no critical points. The function is increasing on its domain. There are no inflection points. The function is concave up on $(-\infty, -7) \cup (-7, 2)$ and concave down on $(2, \infty)$. The numerator and denominator share a factor of $x + 7$. Dividing out this common factor gives $y = \frac{x-7}{x-2}$ ($x \neq -7$), which shows that $x = 1$ is a vertical asymptote. Now dividing numerator and denominator by x gives $y = \frac{1-(7/x)}{1-(2/x)}$, which shows that $y = 1$ is a horizontal asymptote. The graph will have a hole at $x = -7$, $y = \frac{(-1)-7}{(-7)-2} = \frac{14}{9}$. The x -intercept is $\frac{7}{2}$.

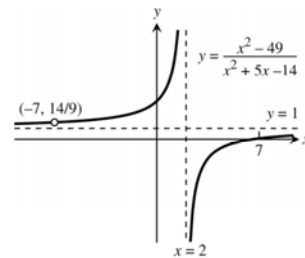

$$87. \quad y = \frac{x^4 + 1}{x^2}$$

Since 0 is a root of the denominator, the domain is $(-\infty, 0) \cup (0, \infty)$.

$$y' = \frac{2x^4 - 2}{x^3}; \quad y'' = 2 + \frac{6}{x^4}$$

There are critical points at $x = \pm 1$. The function is increasing on $(-1, 0) \cup (1, \infty)$ and decreasing on $(-\infty, -1) \cup (0, 1)$. There are no inflection points. The function is concave up on its domain. The y -axis is a vertical asymptote. Dividing numerator and denominator by x^2 gives $y = \frac{x^2 + 1/x^2}{1}$, which shows that there are no horizontal asymptotes. For large $|x|$, the graph is close to the graph of $y = x^2$.

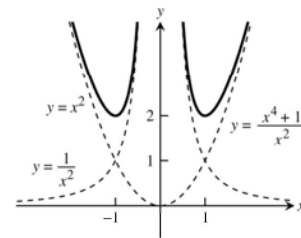

$$88. \quad y = \frac{x^2 + 4}{2x}$$

Since 0 is a root of the denominator, the domain is $(-\infty, 0) \cup (0, \infty)$.

$$y' = \frac{x^2 - 4}{2x^2}; \quad y'' = \frac{4}{x^3}$$

There are no critical points at $x = \pm 2$. The function is increasing on $(-\infty, -2) \cup (2, \infty)$ and decreasing on $(-2, 0) \cup (0, 2)$. There are no inflection points. The function is concave down on $(-\infty, 0)$ and concave up on $(0, \infty)$. The y -axis is a vertical asymptote.

Dividing numerator and denominator by x gives $y = \frac{x+4/x}{2}$, which shows that the line $y = \frac{x}{2}$ is an asymptote.

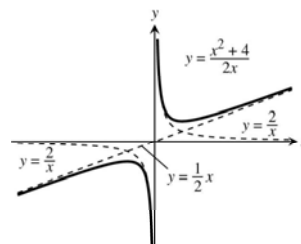

89. $y = \frac{1}{x^2-1}$

Since 1 and -1 are roots of the denominator, the domain is $(-\infty, -1) \cup (-1, 1) \cup (1, \infty)$.

$y' = -\frac{2x}{(x^2-1)^2}; y'' = \frac{6x^2+2}{(x^2-1)^3}$

There is a critical point at $x = 0$, where the function has a local maximum. The function is increasing on $(-\infty, -1) \cup (-1, 0)$ and decreasing on $(0, 1) \cup (1, \infty)$. The function is concave up on $(-\infty, -1) \cup (1, \infty)$ and concave down on $(-1, 1)$. The lines $x = 1$ and $x = -1$ are vertical asymptotes. The x -axis is a horizontal asymptote.

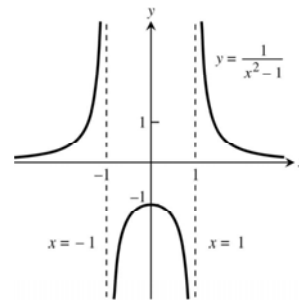

90. $y = \frac{x^2}{x^2-1}$

Since 1 and -1 are roots of the denominator, the domain is $(-\infty, -1) \cup (-1, 1) \cup (1, \infty)$.

$y' = -\frac{2x}{(x^2-1)^2}; y'' = \frac{6x^2+2}{(x^2-1)^3}$

There is a critical point at $x = 0$, where the function has a local maximum. The function is increasing on $(-\infty, -1) \cup (-1, 0)$ and decreasing on $(0, 1) \cup (1, \infty)$. There are no inflection points. The function is concave up on $(-\infty, -1) \cup (1, \infty)$ and concave down on $(-1, 1)$. The lines $x = 1$ and $x = -1$ are vertical asymptotes.

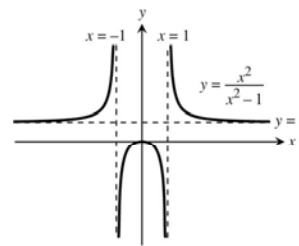

Dividing numerator and denominator by x^2 gives $y = \frac{1}{1-(1/x^2)}$

which shows that the line $y = 1$ is a horizontal asymptote. The x -intercept is 0 and the y -intercept is 0.

91. $y = -\frac{x^2-2}{x^2-1}$

Since 1 and -1 are roots of the denominator, the domain is $(-\infty, -1) \cup (-1, 1) \cup (1, \infty)$.

$y' = -\frac{2x}{(x^2-1)^2}; y'' = \frac{6x^2+2}{(x^2-1)^3}$

There is a critical point at $x = 0$, where the function has a local maximum. The function is increasing on $(-\infty, -1) \cup (-1, 0)$ and decreasing on $(0, 1) \cup (1, \infty)$. There are no inflection points. The function is concave up on $(-\infty, -1) \cup (1, \infty)$ and concave down on $(-1, 1)$. The lines $x = 1$ and $x = -1$ are vertical asymptotes.

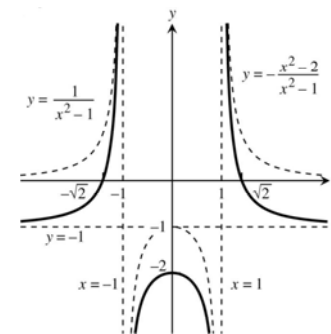

Dividing numerator and denominator by x^2 gives $y = -\frac{1-(2/x^2)}{1-(1/x^2)}$

which shows that the line $y = -1$ is a horizontal asymptote. The x -intercepts are $\pm\sqrt{2}$ and the y -intercept is -2 .

92. $y = \frac{x^2-4}{x^2-2}$

Since $\sqrt{2}$ and $-\sqrt{2}$ are roots of the denominator, the domain is $(-\infty, -\sqrt{2}) \cup (-\sqrt{2}, \sqrt{2}) \cup (\sqrt{2}, \infty)$.

$$y' = \frac{4x}{(x^2-2)^2}; \quad y'' = \frac{4(3x^2+2)}{(x^2-2)^3}$$

There is a critical point at $x = 0$, where the function has a local minimum. The function is increasing on $(0, \sqrt{2}) \cup (\sqrt{2}, \infty)$ and decreasing on $(-\infty, -\sqrt{2}) \cup (-\sqrt{2}, 0)$. There are no inflection points. The function is concave up on $(-\sqrt{2}, \sqrt{2})$ and concave down on $(-\infty, -\sqrt{2}) \cup (\sqrt{2}, \infty)$. The lines $x = \sqrt{2}$ and $x = -\sqrt{2}$ are vertical asymptotes. Dividing numerator and denominator by x^2 gives $y = \frac{1-(4/x^2)}{1-(2/x^2)}$ which shows that the line $y = 1$ is a horizontal asymptote. The x -intercepts are $\pm\sqrt{2}$ and the y -intercept is 2.

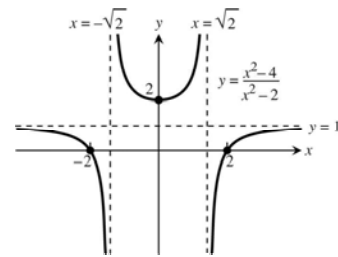

93. $y = \frac{x^2}{x+1}$

Since -1 is a root of the denominator, the domain is $(-\infty, -1) \cup (-1, \infty)$.

$$y' = \frac{x^2+2x}{(x+1)^2}; \quad y'' = \frac{2}{(x+1)^3}$$

There is a critical point at $x = 0$, where the function has a local minimum, and a critical point at $x = 2$ where the function has a local maximum. The function is increasing on $(-\infty, -2) \cup (0, \infty)$ and decreasing on $(-2, -1) \cup (-1, 0)$. There are no inflection points. The function is concave up on $(-1, \infty)$ and concave down on $(-\infty, -1)$. The line $x = -1$ is a vertical asymptote. Dividing numerator by denominator gives $y = x - 1 + \frac{1}{x+1}$, which shows that the line $y = x - 1$ is an oblique asymptote. (See Section 2.6.) The x -intercept is 0 and the y -intercept is 0.

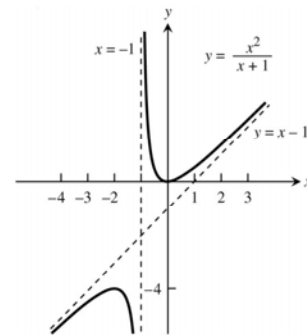

94. $y = -\frac{x^2-4}{x-1}$

Since -1 is a root of the denominator, the domain is $(-\infty, -1) \cup (-1, \infty)$.

$$y' = \frac{x^2+2x+4}{(x+1)^2}; \quad y'' = \frac{6}{(x+1)^3}$$

There are no critical points. The function is decreasing on its domain. There are no inflection points. The function is concave up on $(-1, \infty)$ and concave down on $(-\infty, -1)$. The line $x = -1$ is a vertical asymptote. Dividing numerator by denominator gives $y = 1 - x + \frac{3}{x+1}$, which shows that the line $y = 1 - x$ is an oblique asymptote. (See Section 2.6.) The x -intercepts are ± 2 and the y -intercept is 4.

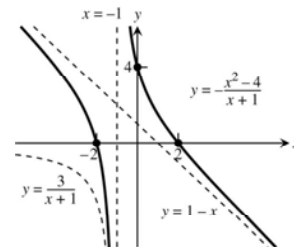

95. $y = \frac{x^2 - x + 1}{x - 1}$

Since 1 is a root of the denominator, the domain is $(-\infty, 1) \cup (1, \infty)$.

$$y' = \frac{x^2 - 2x}{(x-1)^2}; \quad y'' = \frac{2}{(x-1)^3}$$

There is a critical point at $x = 0$, where the function has a local maximum, and a critical point at $x = 2$ where the function has a local minimum. The function is increasing on $(-\infty, 0) \cup (2, \infty)$ and decreasing on $(0, 1) \cup (1, 2)$. There are no inflection points. The function is concave up on $(1, \infty)$ and concave down on $(-\infty, 1)$. The line $x = 1$ is a vertical asymptote. Dividing numerator by denominator gives $y = x + \frac{1}{x-1}$ which shows that the line $y = x$ is an oblique asymptote. (See Section 2.6.) The y -intercept is -1 .

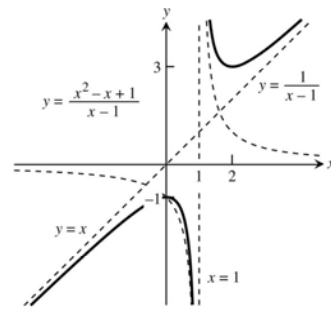

96. $y = -\frac{x^2 - x + 1}{x - 1}$

Since 1 is a root of the denominator, the domain is $(-\infty, 1) \cup (1, \infty)$.

$$y' = \frac{2x - x^2}{(x-1)^2}; \quad y'' = \frac{2}{(x-1)^3}$$

There is a critical point at $x = 0$, where the function has a local minimum, and a critical point at $x = 2$ where the function has a local maximum. The function is increasing on $(0, 1) \cup (1, 2)$ and decreasing on $(-\infty, 0) \cup (2, \infty)$. There are no inflection points. The function is concave up on $(-\infty, 1)$ and concave down on $(1, \infty)$. The line $x = 1$ is a vertical asymptote. Dividing numerator by denominator gives $y = -x - \frac{1}{x-1}$ which shows that the line $y = -x$ is an oblique asymptote. (See Section 2.6.) The y -intercept is 1.

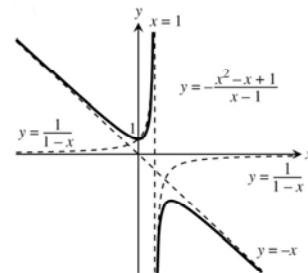

97. $y = \frac{x^3 - 3x^2 + 3x - 1}{x^2 + x - 2} = \frac{(x-1)^3}{(x-1)(x+2)}$

Since 1 and -2 are roots of the denominator, the domain is $(-\infty, -2) \cup (-2, 1) \cup (1, \infty)$.

$$y' = \frac{(x-1)(x+5)}{(x+2)^2}, \quad x \neq 1; \quad y'' = \frac{18}{(x+2)^3}, \quad x \neq 1$$

Since 1 is not in the domain, the only critical point is at $x = -5$, where the function has a local maximum. The function is increasing on $(-\infty, -5) \cup (1, \infty)$ and decreasing on $(-5, -2) \cup (-2, 1)$. There are no inflection points. The function is concave up on $(-2, 1) \cup (1, \infty)$ and concave down on $(-\infty, -2)$.

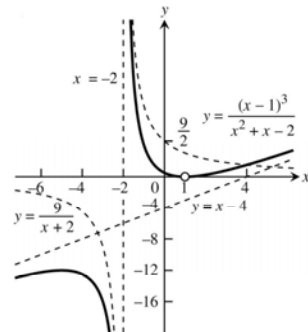

The line $x = -2$ is a vertical asymptote. Dividing numerator by the denominator gives $y = x - 4 + \frac{9}{x+2}$ which shows that the line $y = x - 4$ is an oblique asymptote. (See Section 2.6.) The y -intercept is $\frac{1}{2}$. The graph has a hole at the point $(1, 0)$.

$$98. \quad y = \frac{x^3 + x - 2}{x - x^2} = \frac{(x-1)(x^2 + x + 2)}{(x-1)(-x)}$$

Since 1 and 0 are roots of the denominator, the domain is $(-\infty, 0) \cup (0, 1) \cup (1, \infty)$.

$$y' = -\frac{x^2 - 2}{x^2}, \quad x \neq 1; \quad y'' = -\frac{4}{x^2}, \quad x \neq 1$$

There is a critical point at $x = -\sqrt{2}$ where the function has a local minimum, and a critical point at $x = \sqrt{2}$ where the function has a local maximum. The function is increasing on $(-\sqrt{2}, 0) \cup (0, \sqrt{2})$ and decreasing on $(-\infty, -\sqrt{2}) \cup (\sqrt{2}, \infty)$. There are no inflection points. The function is concave up on $(-\infty, 0)$ and concave down on $(0, 1) \cup (1, \infty)$. The y -axis is a vertical asymptote. Dividing numerator by denominator gives $y = -x - 1 - \frac{2}{x}$ which shows that the line $y = -x - 1$ is an oblique asymptote. (See Section 2.6.) The graph has a hole at the point $(1, -4)$.

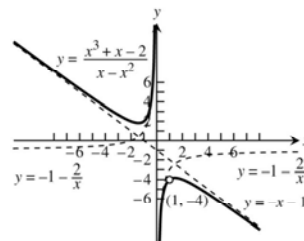

$$99. \quad y = \frac{x}{x^2 - 1}$$

Since 1 and -1 are roots of the denominator, the domain is $(-\infty, -1) \cup (-1, 1) \cup (1, \infty)$.

$$y' = -\frac{x^2 + 1}{(x^2 - 1)^2}; \quad y'' = \frac{2x^3 + 6x}{(x^2 - 1)^3}$$

There are no critical points. The function is decreasing on its domain. There is an inflection point at $x = 0$. The function is concave up on $(-1, 0) \cup (1, \infty)$ and concave down on $(-\infty, -1) \cup (0, 1)$. The lines $x = 1$ and $x = -1$ are vertical asymptotes. Dividing numerator and denominator by x^2 gives $y = \frac{1/x}{1 - (1/x^2)}$ which show that the x -axis is a horizontal asymptote. The x -intercept is 0 and the y -intercept is 0.

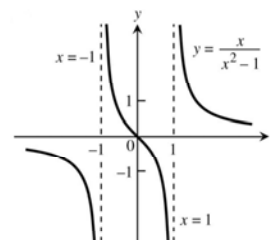

$$100. \quad y = \frac{x-1}{x^2(x-2)}$$

Since 0 and 2 are roots of the denominator, the domain is $(-\infty, 0) \cup (0, 2) \cup (2, \infty)$.

$$y' = -\frac{2x^2 + 5x + 4}{x^3(x-2)^2}; \quad y'' = \frac{6x^3 - 24x^2 + 40x - 24}{x^4(x-2)^3}$$

There are no critical points. The function is increasing on $(-\infty, 0)$ and decreasing on $(0, 2) \cup (2, \infty)$. There is an inflection point at

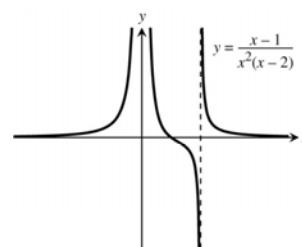

approximately $x = 1.223$. The function is concave up on $(-\infty, 0) \cup (0, 1.223) \cup (2, \infty)$ and concave down on $(1.223, 2)$. The lines $x = 0$ (the y -axis) and $x = 2$ are vertical asymptotes.

Dividing numerator and denominator by x^3 gives

$y = \frac{(1/x^2) - (1/x^3)}{1 - (2/x)}$ which shows that the x -axis is a horizontal asymptote. The x -intercept is 1.

101. $y = \frac{8}{x^2 + 4}$

The domain is $(-\infty, \infty)$.

$y' = -\frac{16x}{(x^2 + 4)^2}$; $y'' = \frac{16(3x^2 - 4)}{(x^2 + 4)^3}$

There is a critical point at $x = 0$, where the function has a local maximum. The function is increasing on $(-\infty, 0)$ and decreasing on $(0, \infty)$. There are inflection points at $x = -2/\sqrt{3}$ and at $x = 2/\sqrt{3}$. The function is concave up on $(-\infty, -2/\sqrt{3}) \cup (2/\sqrt{3}, \infty)$ and concave down on $(-2/\sqrt{3}, 2/\sqrt{3})$. Dividing numerator and denominator by x^2 gives $y = \frac{8/x^2}{1 + (4/x^2)}$ which shows that the x -axis is a horizontal asymptote. The y -intercept is 2.

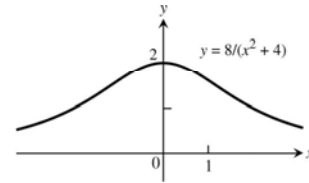

102. $y = \frac{4x}{x^2 + 4}$

The domain is $(-\infty, \infty)$.

$y' = -\frac{4(x^2 - 4)}{(x^2 + 4)^2}$; $y'' = \frac{8x(x^2 - 12)}{(x^2 + 4)^3}$

There is a critical point at $x = -2$, where the function has a local minimum, and at $x = 2$, where the function has a local maximum. The function is increasing on $(-2, 2)$ and decreasing on $(-\infty, -2) \cup (2, \infty)$. There are inflection points at $x = -2\sqrt{3}$, $x = 0$, and $x = 2\sqrt{3}$. The function is concave up on $(-2\sqrt{3}, 0) \cup (2\sqrt{3}, \infty)$ and concave down on $(-\infty, -2\sqrt{3}) \cup (0, 2\sqrt{3})$. Dividing numerator and denominator by x^2 gives $y = \frac{4/x}{1 + (4/x^2)}$ which shows that the x -axis is a horizontal asymptote. The x -intercept is 0 and the y -intercept is 0.

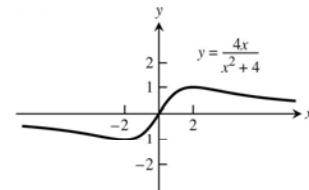

103.

Point	y'	y''
P	-	+
Q	+	0
R	+	-
S	0	-
T	-	-

104.

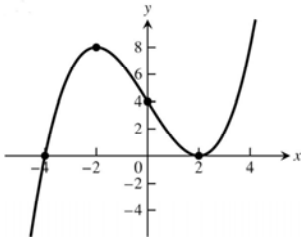

105.

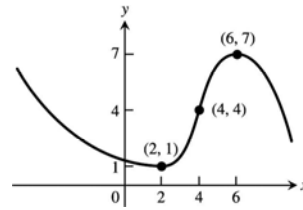

106.

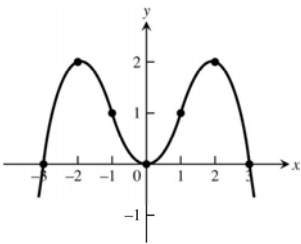

107. Graphs printed in color can shift during a press run, so your values may differ somewhat from those given here.

- The body is moving away from the origin when $|\text{displacement}|$ is increasing as t increases, $0 < t < 2$ and $6 < t < 9.5$; the body is moving toward the origin when $|\text{displacement}|$ is decreasing as t increases, $2 < t < 6$ and $9.5 < t < 15$.
- The velocity will be zero when the slope of the tangent line for $y = s(t)$ is horizontal. The velocity is zero when t is approximately 2, 6, or 9.5 sec.
- The acceleration will be zero at those values of t where the curve $y = s(t)$ has points of inflection. The acceleration is zero when t is approximately 4, 7.5, or 12.5.
- The acceleration is positive when the concavity is up, $4 < t < 7.5$ and $12.5 < t < 15$; the acceleration is negative when the concavity is down, $0 < t < 4$ and $7.5 < t < 12.5$.

108. (a) The body is moving away from the origin when $|\text{displacement}|$ is increasing as t increases, $1.5 < t < 4$, $10 < t < 12$ and $13.5 < t < 16$; the body is moving toward the origin when $|\text{displacement}|$ is decreasing as t increases, $0 < t < 1.5$, $4 < t < 10$ and $12 < t < 13.5$.
- (b) The velocity will be zero when the slope of the tangent line for $y = s(t)$ is horizontal. The velocity is zero when t is approximately 0, 4, 12 or 16 sec.
- (c) The acceleration will be zero at those values of t where the curve $y = s(t)$ has points of inflection. The acceleration is zero when t is approximately 1.5, 6, 8, 10.5, or 13.5 sec.
- (d) The acceleration is positive when the concavity is up, $0 < t < 1.5$, $6 < t < 8$ and $10 < t < 13.5$, the acceleration is negative when the concavity is down, $1.5 < t < 6$, $8 < t < 10$ and $13.5 < t < 16$.

109. The marginal cost is $\frac{dc}{dx}$ which changes from decreasing to increasing when its derivative $\frac{d^2c}{dx^2}$ is zero. This is a point of inflection of the cost curve and occurs when the production level x is approximately 60 thousand units.

110. The marginal revenue is $\frac{dy}{dx}$ and it is increasing when its derivative $\frac{d^2y}{dx^2}$ is positive \Rightarrow the curve is concave up $\Rightarrow 0 < t < 2$ and $5 < t < 9$; marginal revenue is decreasing when $\frac{d^2y}{dx^2} < 0 \Rightarrow$ the curve is concave down $\Rightarrow 2 < t < 5$ and $9 < t < 12$.

111. When $y' = (x-1)^2(x-2)$, then $y'' = 2(x-1)(x-2) + (x-1)^2$. The curve falls on $(-\infty, 2)$ and rises on $(2, \infty)$. At $x = 2$ there is a local minimum. There is no local maximum. The curve is concave upward on $(-\infty, 1)$ and $(\frac{5}{3}, \infty)$, and concave downward on $(1, \frac{5}{3})$. At $x = 1$ or $x = \frac{5}{3}$ there are inflection points.

112. When $y' = (x-1)^2(x-2)(x-4)$, then $y'' = 2(x-1)(x-2)(x-4) + (x-1)^2(x-4) + (x-1)^2(x-2)$
 $= (x-1)[2(x^2 - 6x + 8) + (x^2 - 5x + 4) + (x^2 - 3x + 2)] = 2(x-1)(2x^2 - 10x + 11)$. The curve rises on $(-\infty, 2)$ and $(4, \infty)$ and falls on $(2, 4)$. At $x = 2$ there is a local maximum and at $x = 4$ a local minimum. The curve is concave downward on $(-\infty, 1)$ and $(\frac{5-\sqrt{3}}{2}, \frac{5+\sqrt{3}}{2})$ and concave upward on $(1, \frac{5-\sqrt{3}}{2})$ and $(\frac{5+\sqrt{3}}{2}, \infty)$. At $x = 1, \frac{5-\sqrt{3}}{2}$ and $\frac{5+\sqrt{3}}{2}$ there are inflection points.

113. The graph must be concave down for $x > 0$ because $f''(x) = -\frac{1}{x^2} < 0$.

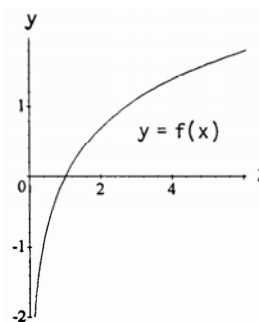

114. The second derivative, being continuous and never zero, cannot change sign. Therefore the graph will always be concave up or concave down so it will have no inflection points and no cusps or corners.

115. The curve will have a point of inflection at $x = 1$ if 1 is a solution of $y'' = 0$; $y = x^3 + bx^2 + cx + d$
 $\Rightarrow y' = 3x^2 + 2bx + c \Rightarrow y'' = 6x + 2b$ and $6(1) + 2b = 0 \Rightarrow b = -3$.

116. (a) $f(x) = ax^2 + bx + c = a(x^2 + \frac{b}{a}x) + c = a(x^2 + \frac{b}{a}x + \frac{b^2}{4a^2}) - \frac{b^2}{4a} + c = a(x + \frac{b}{2a})^2 - \frac{b^2 - 4ac}{4a}$ a parabola whose vertex is at $x = -\frac{b}{2a} \Rightarrow$ the coordinates of the vertex are $(-\frac{b}{2a}, -\frac{b^2 - 4ac}{4a})$

(b) The second derivative, $f''(x) = 2a$, describes concavity \Rightarrow when $a > 0$ the parabola is concave up and when $a < 0$ the parabola is concave down.

117. A quadratic curve never has an inflection point. If $y = ax^2 + bx + c$ where $a \neq 0$, then $y' = 2ax + b$ and $y'' = 2a$. Since $2a$ is a constant, it is not possible for y'' to change signs.

118. A cubic curve always has exactly one inflection point. If $y = ax^3 + bx^2 + cx + d$ where $a \neq 0$, then $y' = 3ax^2 + 2bx + c$ and $y'' = 6ax + 2b$. Since $-\frac{b}{3a}$ is a solution of $y'' = 0$, we have that y'' changes its sign at $x = -\frac{b}{3a}$ and y' exists everywhere (so there is a tangent at $x = -\frac{b}{3a}$). Thus the curve has an inflection point at $x = -\frac{b}{3a}$. There are no other inflection points because y'' changes sign only at this zero.

119. $y'' = (x+1)(x-2)$, when $y'' = 0 \Rightarrow x = -1$ or $x = 2$; $y'' = \begin{matrix} + & + & + \\ - & 1 & - \\ - & - & + \end{matrix} \Rightarrow$ points of inflection at $x = -1$ and $x = 2$

120. $y'' = x^2(x-2)^3(x+3)$, when $y'' = 0 \Rightarrow x = -3, x = 0$ or $x = 2$; $y'' = \begin{matrix} + & + & + \\ - & 3 & - \\ - & - & + \end{matrix} \Rightarrow$ points of inflection at $x = -3$ and $x = 2$

121. $y = ax^3 + bx^2 + cx \Rightarrow y' = 3ax^2 + 2bx + c$ and $y'' = 6ax + 2b$; local maximum at $x = 3$
 $\Rightarrow 3a(3)^2 + 2b(3) + c = 0 \Rightarrow 27a + 6b + c = 0$; local minimum at $x = -1 \Rightarrow 3a(-1)^2 + 2b(-1) + c = 0$
 $\Rightarrow 3a - 2b + c = 0$; point of inflection at $(1, 11) \Rightarrow a(1)^3 + b(1)^2 + c(1) = 11 \Rightarrow a + b + c = 11$ and
 $6a(1) + 2b = 0 \Rightarrow 6a + 2b = 0$. Solving $27a + 6b + c = 0$, $3a - 2b + c = 0$, $a + b + c = 11$, and $6a + 2b = 0$
 $\Rightarrow a = -1$, $b = 3$, and $c = 9 \Rightarrow y = -x^3 + 3x^2 + 9x$

122. $y = \frac{x^2+a}{bx+c} \Rightarrow y' = \frac{bx^2+2cx-ab}{(bx+c)^2}$; local maximum at $x = 3 \Rightarrow \frac{b(3)^2+2c(3)-ab}{(b(3)+c)^2} = 0 \Rightarrow 9b+6c-ab=0$; local
 minimum at $(-1, -2) \Rightarrow \frac{b(-1)^2+2c(-1)-ab}{(b(-1)+c)^2} = 0 \Rightarrow b-2c-ab=0$ and $\frac{(-1)^2+a}{b(-1)+c} = -2 \Rightarrow -a+2b-2c=1$.
 Solving $9b+6c-ab=0$, $b-2c-ab=0$, and $-a+2b-2c=1 \Rightarrow a=3$, $b=1$, and $c=-1 \Rightarrow y = \frac{x^2+3}{x-1}$.

123. If $y = x^5 - 5x^4 - 240$, then $y' = 5x^3(x-4)$ and
 $y'' = 20x^2(x-3)$. The zeros of y' are extrema, and
 there is a point of inflection at $x = 3$.

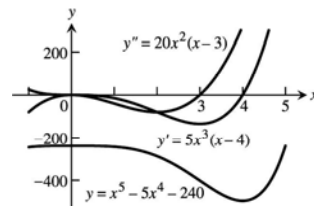

124. If $y = x^3 - 12x^2$ then $y' = 3x(x-8)$ and $y'' = 6(x-4)$.
 The zeros of y' and y'' are extrema, and points of
 inflection, respectively.

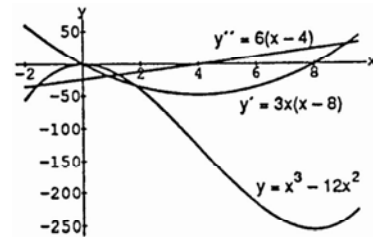

125. If $y = \frac{4}{5}x^5 + 16x^2 - 25$, then $y' = 4x(x^3 + 8)$ and
 $y'' = 16(x^2 + 2)$. The zeros of y' and y'' are extrema,
 and points of inflection, respectively.

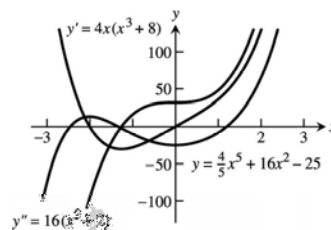

126. If $y = \frac{x^4}{4} - \frac{x^3}{3} - 4x^2 + 12x + 20$, then
 $y' = x^3 - x^2 - 8x + 12 = (x+3)(x-2)^2$. So y has a
 local minimum at $x = -3$ as its only extreme value.
 Also $y'' = 3x^2 - 2x - 8 = (3x+4)(x-2)$ and there
 are inflection points at both zeros, $-\frac{4}{3}$ and 2 , of y'' .

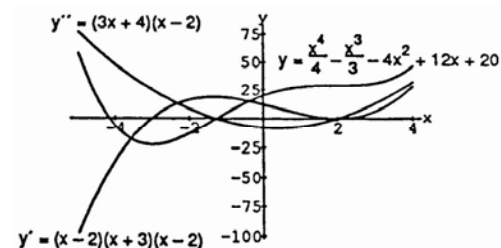

127. The graph of f falls where $f' < 0$, rises where $f' > 0$, and has horizontal tangents where $f' = 0$. It has local minima at points where f' changes from negative to positive and local maxima where f' changes from positive to negative. The graph of f is concave down where $f'' < 0$ and concave up where $f'' > 0$. It has an inflection point each time f'' changes sign, provided a tangent line exists there.

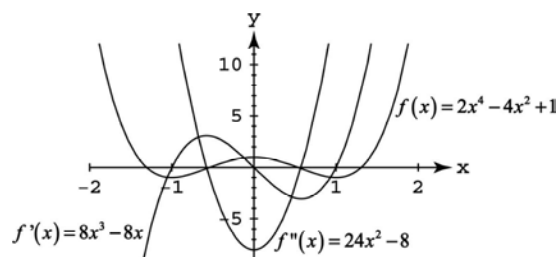

128. The graph f is concave down where $f'' < 0$, and concave up where $f'' > 0$. It has an inflection point each time f'' changes sign, provided a tangent line exists there.

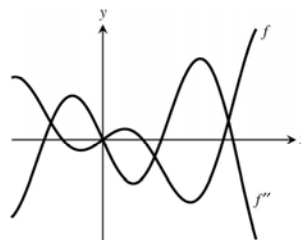

4.5 INDETERMINATE FORMS AND L'HÔPITAL'S RULE

1. l'Hôpital: $\lim_{x \rightarrow 2} \frac{x-2}{x^2-4} = \frac{1}{2x} \Big|_{x=2} = \frac{1}{4}$ or $\lim_{x \rightarrow 2} \frac{x-2}{x^2-4} = \lim_{x \rightarrow 2} \frac{x-2}{(x-2)(x+2)} = \lim_{x \rightarrow 2} \frac{1}{x+2} = \frac{1}{4}$
2. l'Hôpital: $\lim_{x \rightarrow 0} \frac{\sin 5x}{x} = \frac{5 \cos 5x}{1} \Big|_{x=0} = 5$ or $\lim_{x \rightarrow 0} \frac{\sin 5x}{x} = 5 \left[\lim_{5x \rightarrow 0} \frac{\sin 5x}{5x} \right] = 5 \cdot 1 = 5$
3. l'Hôpital: $\lim_{x \rightarrow \infty} \frac{5x^2-3x}{7x^2+1} = \lim_{x \rightarrow \infty} \frac{10x-3}{14x} = \lim_{x \rightarrow \infty} \frac{10}{14} = \frac{5}{7}$ or $\lim_{x \rightarrow \infty} \frac{5x^2-3x}{7x^2+1} = \lim_{x \rightarrow \infty} \frac{5-\frac{3}{x}}{7+\frac{1}{x^2}} = \frac{5}{7}$
4. l'Hôpital: $\lim_{x \rightarrow 1} \frac{x^3-1}{4x^3-x-3} = \lim_{x \rightarrow 1} \frac{3x^2}{12x^2-1} = \frac{3}{11}$ or $\lim_{x \rightarrow 1} \frac{x^3-1}{4x^3-x-3} = \lim_{x \rightarrow 1} \frac{(x-1)(x^2+x+1)}{(x-1)(4x^2+4x+3)} = \lim_{x \rightarrow 1} \frac{x^2+x+1}{4x^2+4x+3} = \frac{3}{11}$
5. l'Hôpital: $\lim_{x \rightarrow 0} \frac{1-\cos x}{x^2} = \lim_{x \rightarrow 0} \frac{\sin x}{2x} = \lim_{x \rightarrow 0} \frac{\cos x}{2} = \frac{1}{2}$ or $\lim_{x \rightarrow 0} \frac{1-\cos x}{x^2} = \lim_{x \rightarrow 0} \left[\frac{(1-\cos x)}{x^2} \left(\frac{1+\cos x}{1+\cos x} \right) \right]$
 $= \lim_{x \rightarrow 0} \frac{\sin^2 x}{x^2(1+\cos x)} = \lim_{x \rightarrow 0} \left[\left(\frac{\sin x}{x} \right) \left(\frac{\sin x}{x} \right) \left(\frac{1}{1+\cos x} \right) \right] = \frac{1}{2}$
6. l'Hôpital: $\lim_{x \rightarrow \infty} \frac{2x^2+3x}{x^3+x+1} = \lim_{x \rightarrow \infty} \frac{4x+3}{3x^2+1} = \lim_{x \rightarrow \infty} \frac{4}{6x} = 0$ or $\lim_{x \rightarrow \infty} \frac{2x^2+3x}{x^3+x+1} = \lim_{x \rightarrow \infty} \frac{\frac{2}{x} + \frac{3}{x^2}}{1 + \frac{1}{x} + \frac{1}{x^3}} = \frac{0}{1} = 0$
7. $\lim_{x \rightarrow 2} \frac{x-2}{x^2-4} = \lim_{x \rightarrow 2} \frac{1}{2x} = \frac{1}{4}$
8. $\lim_{x \rightarrow -5} \frac{x^2-25}{x+5} = \lim_{x \rightarrow -5} \frac{2x}{1} = -10$
9. $\lim_{t \rightarrow -3} \frac{t^3-4t+15}{t^2-t-12} = \lim_{t \rightarrow -3} \frac{3t^2-4}{2t-1} = \frac{3(-3)^2-4}{2(-3)-1} = -\frac{23}{7}$
10. $\lim_{t \rightarrow -1} \frac{3t^3+3}{4t^3-t+3} = \lim_{t \rightarrow -1} \frac{9t^2}{12t^2-1} = \frac{9}{11}$

$$11. \lim_{x \rightarrow \infty} \frac{5x^3 - 2x}{7x^3 + 3} = \lim_{x \rightarrow \infty} \frac{15x^2 - 2}{21x^2} = \lim_{x \rightarrow \infty} \frac{30x}{42x} = \lim_{x \rightarrow \infty} \frac{30}{42} = \frac{5}{7}$$

$$12. \lim_{x \rightarrow \infty} \frac{x - 8x^2}{12x^2 + 5x} = \lim_{x \rightarrow \infty} \frac{1 - 16x}{24x + 5} = \lim_{x \rightarrow \infty} \frac{-16}{24} = -\frac{2}{3}$$

$$13. \lim_{t \rightarrow 0} \frac{\sin t^2}{t} = \lim_{t \rightarrow 0} \frac{(\cos t^2)(2t)}{1} = 0$$

$$14. \lim_{t \rightarrow 0} \frac{\sin 5t}{2t} = \lim_{t \rightarrow 0} \frac{5 \cos 5t}{2} = \frac{5}{2}$$

$$15. \lim_{x \rightarrow 0} \frac{8x^2}{\cos x - 1} = \lim_{x \rightarrow 0} \frac{16x}{-\sin x} = \lim_{x \rightarrow 0} \frac{16}{-\cos x} = \frac{16}{-1} = -16$$

$$16. \lim_{x \rightarrow 0} \frac{\sin x - x}{x^3} = \lim_{x \rightarrow 0} \frac{\cos x - 1}{3x^2} = \lim_{x \rightarrow 0} \frac{-\sin x}{6x} = \lim_{x \rightarrow 0} \frac{-\cos x}{6} = -\frac{1}{6}$$

$$17. \lim_{\theta \rightarrow \frac{\pi}{2}} \frac{2\theta - \pi}{\cos(2\pi - \theta)} = \lim_{\theta \rightarrow \frac{\pi}{2}} \frac{2}{\sin(2\pi - \theta)} = \frac{2}{\sin(\frac{3\pi}{2})} = -2$$

$$18. \lim_{\theta \rightarrow \frac{\pi}{3}} \frac{3\theta + \pi}{\sin(\theta + \frac{\pi}{3})} = \lim_{\theta \rightarrow \frac{\pi}{3}} \frac{3}{\cos(\theta + \frac{\pi}{3})} = 3$$

$$19. \lim_{\theta \rightarrow \frac{\pi}{2}} \frac{1 - \sin \theta}{1 + \cos 2\theta} = \lim_{\theta \rightarrow \frac{\pi}{2}} \frac{-\cos \theta}{-2 \sin 2\theta} = \lim_{\theta \rightarrow \frac{\pi}{2}} \frac{\sin \theta}{-4 \cos 2\theta} = \frac{1}{(-4)(-1)} = \frac{1}{4}$$

$$20. \lim_{x \rightarrow 1} \frac{x - 1}{\ln x - \sin(\pi x)} = \lim_{x \rightarrow 1} \frac{1}{\frac{1}{x} - \pi \cos(\pi x)} = \frac{1}{1 + \pi}$$

$$21. \lim_{x \rightarrow 0} \frac{x^2}{\ln(\sec x)} = \lim_{x \rightarrow 0} \frac{2x}{\left(\frac{\sec x \tan x}{\sec x}\right)} = \lim_{x \rightarrow 0} \frac{2x}{\tan x} = \lim_{x \rightarrow 0} \frac{2}{\sec^2 x} = \frac{2}{1^2} = 2$$

$$22. \lim_{x \rightarrow \frac{\pi}{2}} \frac{\ln(\csc x)}{\left(x - \left(\frac{\pi}{2}\right)\right)^2} = \lim_{x \rightarrow \frac{\pi}{2}} \frac{\left(\frac{-\csc x \cot x}{\csc x}\right)}{2\left(x - \left(\frac{\pi}{2}\right)\right)} = \lim_{x \rightarrow \frac{\pi}{2}} \frac{-\cot x}{2\left(x - \left(\frac{\pi}{2}\right)\right)} = \lim_{x \rightarrow \frac{\pi}{2}} \frac{\csc^2 x}{2} = \frac{1^2}{2} = \frac{1}{2}$$

$$23. \lim_{t \rightarrow 0} \frac{t(1 - \cos t)}{t - \sin t} = \lim_{t \rightarrow 0} \frac{(1 - \cos t) + t(\sin t)}{1 - \cos t} = \lim_{t \rightarrow 0} \frac{\sin t + (\sin t + t \cos t)}{\sin t} = \lim_{t \rightarrow 0} \frac{\cos t + \cos t + \cos t - t \sin t}{\cos t} = \frac{1 + 1 + 1 - 0}{1} = 3$$

$$24. \lim_{t \rightarrow 0} \frac{t \sin t}{1 - \cos t} = \lim_{t \rightarrow 0} \frac{\sin t + t \cos t}{\sin t} = \lim_{t \rightarrow 0} \frac{\cos t + (\cos t - t \sin t)}{\cos t} = \frac{1 + (1 - 0)}{1} = 2$$

$$25. \lim_{x \rightarrow \left(\frac{\pi}{2}\right)^-} \left(x - \frac{\pi}{2}\right) \sec x = \lim_{x \rightarrow \left(\frac{\pi}{2}\right)^-} \frac{\left(x - \frac{\pi}{2}\right)}{\cos x} = \lim_{x \rightarrow \left(\frac{\pi}{2}\right)^-} \left(\frac{-1}{-\sin x}\right) = \frac{1}{-1} = -1$$

$$26. \lim_{x \rightarrow \left(\frac{\pi}{2}\right)^-} \left(\frac{\pi}{2} - x\right) \tan x = \lim_{x \rightarrow \left(\frac{\pi}{2}\right)^-} \frac{\left(\frac{\pi}{2} - x\right)}{\cot x} = \lim_{x \rightarrow \left(\frac{\pi}{2}\right)^-} \left(\frac{-1}{-\csc^2 x}\right) = \lim_{x \rightarrow \left(\frac{\pi}{2}\right)^-} \sin^2 x = 1$$

$$27. \lim_{\theta \rightarrow 0} \frac{3^{\sin \theta} - 1}{\theta} = \lim_{\theta \rightarrow 0} \frac{3^{\sin \theta} (\ln 3)(\cos \theta)}{1} = \frac{(3^0)(\ln 3)(1)}{1} = \ln 3$$

$$28. \lim_{\theta \rightarrow 0} \frac{\left(\frac{1}{2}\right)^\theta - 1}{\theta} = \lim_{\theta \rightarrow 0} \frac{\left(\ln\left(\frac{1}{2}\right)\right)\left(\frac{1}{2}\right)^\theta}{1} = \ln\left(\frac{1}{2}\right) = \ln 1 - \ln 2 = -\ln 2$$

$$29. \lim_{x \rightarrow 0} \frac{x 2^x}{2^x - 1} = \lim_{x \rightarrow 0} \frac{(1)(2^x) + (x)(\ln 2)(2^x)}{(\ln 2)(2^x)} = \frac{1 \cdot 2^0 + 0}{(\ln 2) \cdot 2^0} = \frac{1}{\ln 2}$$

$$30. \lim_{x \rightarrow 0} \frac{3^x - 1}{2^x - 1} = \lim_{x \rightarrow 0} \frac{3^x \ln 3}{2^x \ln 2} = \frac{3^0 \cdot \ln 3}{2^0 \cdot \ln 2} = \frac{\ln 3}{\ln 2}$$

$$31. \lim_{x \rightarrow \infty} \frac{\ln(x+1)}{\log_2 x} = \lim_{x \rightarrow \infty} \frac{\ln(x+1)}{\left(\frac{\ln x}{\ln 2}\right)} = (\ln 2) \lim_{x \rightarrow \infty} \frac{\left(\frac{1}{x+1}\right)}{\left(\frac{1}{x}\right)} = (\ln 2) \lim_{x \rightarrow \infty} \frac{x}{x+1} = (\ln 2) \lim_{x \rightarrow \infty} \frac{1}{1} = \ln 2$$

$$32. \lim_{x \rightarrow \infty} \frac{\log_2 x}{\log_3(x+3)} = \lim_{x \rightarrow \infty} \frac{\left(\frac{\ln x}{\ln 2}\right)}{\left(\frac{\ln(x+3)}{\ln 3}\right)} = \left(\frac{\ln 3}{\ln 2}\right) \lim_{x \rightarrow \infty} \frac{\ln x}{\ln(x+3)} = \left(\frac{\ln 3}{\ln 2}\right) \lim_{x \rightarrow \infty} \frac{\left(\frac{1}{x}\right)}{\left(\frac{1}{x+3}\right)} = \left(\frac{\ln 3}{\ln 2}\right) \lim_{x \rightarrow \infty} \frac{x+3}{x} = \left(\frac{\ln 3}{\ln 2}\right) \lim_{x \rightarrow \infty} \frac{1}{1} = \frac{\ln 3}{\ln 2}$$

$$33. \lim_{x \rightarrow 0^+} \frac{\ln(x^2 + 2x)}{\ln x} = \lim_{x \rightarrow 0^+} \frac{\left(\frac{2x+2}{x^2+2x}\right)}{\left(\frac{1}{x}\right)} = \lim_{x \rightarrow 0^+} \frac{2x^2+2x}{x^2+2x} = \lim_{x \rightarrow 0^+} \frac{4x+2}{2x+2} = \lim_{x \rightarrow 0^+} \frac{2}{2} = 1$$

$$34. \lim_{x \rightarrow 0^+} \frac{\ln(e^x - 1)}{\ln x} = \lim_{x \rightarrow 0^+} \frac{\left(\frac{e^x}{e^x - 1}\right)}{\left(\frac{1}{x}\right)} = \lim_{x \rightarrow 0^+} \frac{x e^x}{e^x - 1} = \lim_{x \rightarrow 0^+} \frac{e^x + x e^x}{e^x} = \frac{1+0}{1} = 1$$

$$35. \lim_{y \rightarrow 0} \frac{\sqrt{5y+25} - 5}{y} = \lim_{y \rightarrow 0} \frac{(5y+25)^{1/2} - 5}{y} = \lim_{y \rightarrow 0} \frac{\left(\frac{1}{2}\right)(5y+25)^{-1/2}(5)}{1} = \lim_{y \rightarrow 0} \frac{5}{2\sqrt{5y+25}} = \frac{1}{2}$$

$$36. \lim_{y \rightarrow 0} \frac{\sqrt{ay+a^2} - a}{y} = \lim_{y \rightarrow 0} \frac{(ay+a^2)^{1/2} - a}{y} = \lim_{y \rightarrow 0} \frac{\left(\frac{1}{2}\right)(ay+a^2)^{-1/2}(a)}{1} = \lim_{y \rightarrow 0} \frac{a}{2\sqrt{ay+a^2}} = \frac{1}{2}, a > 0$$

$$37. \lim_{x \rightarrow \infty} [\ln 2x - \ln(x+1)] = \lim_{x \rightarrow \infty} \ln\left(\frac{2x}{x+1}\right) = \ln\left(\lim_{x \rightarrow \infty} \frac{2x}{x+1}\right) = \ln\left(\lim_{x \rightarrow \infty} \frac{2}{1}\right) = \ln 2$$

$$38. \lim_{x \rightarrow 0^+} (\ln x - \ln \sin x) = \lim_{x \rightarrow 0^+} \ln\left(\frac{x}{\sin x}\right) = \ln\left(\lim_{x \rightarrow 0^+} \frac{x}{\sin x}\right) = \ln\left(\lim_{x \rightarrow 0^+} \frac{1}{\cos x}\right) = \ln 1 = 0$$

$$39. \lim_{x \rightarrow 0^+} \frac{(\ln x)^2}{\ln(\sin x)} = \lim_{x \rightarrow 0^+} \frac{2(\ln x)\left(\frac{1}{x}\right)}{\frac{\cos x}{\sin x}} = \lim_{x \rightarrow 0^+} \frac{2(\ln x)(\sin x)}{x \cos x} = \lim_{x \rightarrow 0^+} \left[\frac{2(\ln x)}{\cos x} \cdot \frac{\sin x}{x} \right] = -\infty \cdot 1 = -\infty$$

$$40. \lim_{x \rightarrow 0^+} \left(\frac{3x+1}{x} - \frac{1}{\sin x} \right) = \lim_{x \rightarrow 0^+} \left(\frac{(3x+1)(\sin x) - x}{x \sin x} \right) = \lim_{x \rightarrow 0^+} \frac{3 \sin x + (3x+1)(\cos x) - 1}{\sin x + x \cos x} = \lim_{x \rightarrow 0^+} \left(\frac{3 \cos x + 3 \cos x + (3x+1)(-\sin x)}{\cos x + \cos x - x \sin x} \right)$$

$$= \frac{3+3+(1)(0)}{1+1-0} = \frac{6}{2} = 3$$

$$41. \lim_{x \rightarrow 1^+} \left(\frac{1}{x-1} - \frac{1}{\ln x} \right) = \lim_{x \rightarrow 1^+} \left(\frac{\ln x - (x-1)}{(x-1)(\ln x)} \right) = \lim_{x \rightarrow 1^+} \left(\frac{\frac{1}{x} - 1}{(\ln x) + (x-1)\left(\frac{1}{x}\right)} \right) = \lim_{x \rightarrow 1^+} \left(\frac{1-x}{(x \ln x) + x - 1} \right)$$

$$= \lim_{x \rightarrow 1^+} \left(\frac{-1}{(\ln x + 1) + 1} \right) = \frac{-1}{(0+1)+1} = -\frac{1}{2}$$

$$42. \lim_{x \rightarrow 0^+} (\csc x - \cot x + \cos x) = \lim_{x \rightarrow 0^+} \left(\frac{1}{\sin x} - \frac{\cos x}{\sin x} + \cos x \right) = \lim_{x \rightarrow 0^+} \left(\frac{(1-\cos x) + (\sin x)(\cos x)}{\sin x} \right)$$

$$= \lim_{x \rightarrow 0^+} \left(\frac{\sin x + \cos^2 x - \sin^2 x}{\cos x} \right) = \frac{0+1-0}{1} = 1$$

$$43. \lim_{\theta \rightarrow 0} \frac{\cos \theta - 1}{e^\theta - \theta - 1} = \lim_{\theta \rightarrow 0} \frac{-\sin \theta}{e^\theta - 1} = \lim_{\theta \rightarrow 0} \frac{-\cos \theta}{e^\theta} = -1$$

$$44. \lim_{h \rightarrow 0} \frac{e^h - (1+h)}{h^2} = \lim_{h \rightarrow 0} \frac{e^h - 1}{2h} = \lim_{h \rightarrow 0} \frac{e^h}{2} = \frac{1}{2}$$

$$45. \lim_{t \rightarrow \infty} \frac{e^t + t^2}{e^t - 1} = \lim_{t \rightarrow \infty} \frac{e^t + 2t}{e^t} = \lim_{t \rightarrow \infty} \frac{e^t + 2}{e^t} = \lim_{t \rightarrow \infty} \frac{e^t}{e^t} = 1$$

$$46. \lim_{x \rightarrow \infty} x^2 e^{-x} = \lim_{x \rightarrow \infty} \frac{x^2}{e^x} = \lim_{x \rightarrow \infty} \frac{2x}{e^x} = \lim_{x \rightarrow \infty} \frac{2}{e^x} = 0$$

$$47. \lim_{x \rightarrow 0} \frac{x - \sin x}{x \tan x} = \lim_{x \rightarrow 0} \frac{1 - \cos x}{x \sec^2 x + \tan x} = \lim_{x \rightarrow 0} \frac{\sin x}{2x \sec^2 x \tan x + 2 \sec^2 x} = \frac{0}{2} = 0$$

$$48. \lim_{x \rightarrow 0} \frac{(e^x - 1)^2}{x \sin x} = \lim_{x \rightarrow 0} \frac{2(e^x - 1)e^x}{x \cos x + \sin x} = \lim_{x \rightarrow 0} \frac{2e^{2x} - 2e^x}{x \cos x + \sin x} = \lim_{x \rightarrow 0} \frac{4e^{2x} - 2e^x}{-x \sin x + 2 \cos x} = \frac{2}{2} = 1$$

$$49. \lim_{\theta \rightarrow 0} \frac{\theta - \sin \theta \cos \theta}{\tan \theta - \theta} = \lim_{\theta \rightarrow 0} \frac{1 + \sin^2 \theta - \cos^2 \theta}{\sec^2 \theta - 1} = \lim_{\theta \rightarrow 0} \frac{2 \sin^2 \theta}{\tan^2 \theta} = \lim_{\theta \rightarrow 0} 2 \cos^2 \theta = 2$$

$$50. \lim_{x \rightarrow 0} \frac{\sin 3x - 3x + x^2}{\sin x \sin 2x} = \lim_{x \rightarrow 0} \frac{3 \cos 3x - 3 + 2x}{2 \sin x \cos 2x + \cos x \sin 2x} = \lim_{x \rightarrow 0} \frac{3 \cos 3x - 3 + 2x}{\sin x \cos 2x + \sin 3x} = \lim_{x \rightarrow 0} \frac{-9 \sin 3x + 2}{-2 \sin x \sin 2x + \cos x \cos 2x + 3 \cos 3x}$$

$$= \frac{2}{4} = \frac{1}{2}$$

51. The limit leads to the indeterminate form 1^∞ . Let $f(x) = x^{1/(1-x)} \Rightarrow \ln f(x) = \ln \left(x^{1/(1-x)} \right) = \frac{\ln x}{1-x}$. Now

$$\lim_{x \rightarrow 1^+} \ln f(x) = \lim_{x \rightarrow 1^+} \frac{\ln x}{1-x} = \lim_{x \rightarrow 1^+} \frac{\left(\frac{1}{x}\right)}{-1} = -1. \text{ Therefore } \lim_{x \rightarrow 1^+} x^{1/(1-x)} = \lim_{x \rightarrow 1^+} f(x) = \lim_{x \rightarrow 1^+} e^{\ln f(x)} = e^{-1} = \frac{1}{e}$$

52. The limit leads to the indeterminate form 1^∞ . Let $f(x) = x^{1/(x-1)} \Rightarrow \ln f(x) = \ln\left(x^{1/(x-1)}\right) = \frac{\ln x}{x-1}$. Now

$$\lim_{x \rightarrow 1^+} \ln f(x) = \lim_{x \rightarrow 1^+} \frac{\ln x}{x-1} = \lim_{x \rightarrow 1^+} \frac{\left(\frac{1}{x}\right)}{1} = 1. \text{ Therefore } \lim_{x \rightarrow 1^+} x^{1/(x-1)} = \lim_{x \rightarrow 1^+} f(x) = \lim_{x \rightarrow 1^+} e^{\ln f(x)} = e^1 = e$$

53. The limit leads to the indeterminate form ∞^0 . Let $f(x) = (\ln x)^{1/x} \Rightarrow \ln f(x) = \ln(\ln x)^{1/x} = \frac{\ln(\ln x)}{x}$. Now

$$\lim_{x \rightarrow \infty} \ln f(x) = \lim_{x \rightarrow \infty} \frac{\ln(\ln x)}{x} = \lim_{x \rightarrow \infty} \frac{\left(\frac{1}{x \ln x}\right)}{1} = 0. \text{ Therefore } \lim_{x \rightarrow \infty} (\ln x)^{1/x} = \lim_{x \rightarrow \infty} f(x) = \lim_{x \rightarrow \infty} e^{\ln f(x)} = e^0 = 1$$

54. The limit leads to the indeterminate form 1^∞ . Let $f(x) = (\ln x)^{1/(x-e)} \Rightarrow \ln f(x) = \frac{\ln(\ln x)}{x-e} = \lim_{x \rightarrow e^+} \ln f(x)$

$$= \lim_{x \rightarrow e^+} \frac{\ln(\ln x)}{x-e} = \lim_{x \rightarrow e^+} \frac{\left(\frac{1}{x \ln x}\right)}{1} = \frac{1}{e}. \text{ Therefore } (\ln x)^{1/(x-e)} = \lim_{x \rightarrow e^+} f(x) = \lim_{x \rightarrow e^+} e^{\ln f(x)} = e^{1/e}$$

55. The limit leads to the indeterminate form 0^0 . Let $f(x) = x^{-1/\ln x} \Rightarrow \ln f(x) = -\frac{\ln x}{\ln x} = -1$. Therefore

$$\lim_{x \rightarrow 0^+} x^{-1/\ln x} = \lim_{x \rightarrow 0^+} f(x) = \lim_{x \rightarrow 0^+} e^{\ln f(x)} = e^{-1} = \frac{1}{e}$$

56. The limit leads to the indeterminate form ∞^0 . Let $f(x) = x^{1/\ln x} \Rightarrow \ln f(x) = \frac{\ln x}{\ln x} = 1$. Therefore

$$\lim_{x \rightarrow \infty} x^{1/\ln x} = \lim_{x \rightarrow \infty} f(x) = \lim_{x \rightarrow \infty} e^{\ln f(x)} = e^1 = e$$

57. The limit leads to the indeterminate form ∞^0 . Let $f(x) = (1+2x)^{1/(2 \ln x)} \Rightarrow \ln f(x) = \frac{\ln(1+2x)}{2 \ln x}$

$$\Rightarrow \lim_{x \rightarrow \infty} \ln f(x) = \lim_{x \rightarrow \infty} \frac{\ln(1+2x)}{2 \ln x} = \lim_{x \rightarrow \infty} \frac{x}{1+2x} = \lim_{x \rightarrow \infty} \frac{1}{2} = \frac{1}{2}. \text{ Therefore } \lim_{x \rightarrow \infty} (1+2x)^{1/(2 \ln x)} = \lim_{x \rightarrow \infty} f(x) = \lim_{x \rightarrow \infty} e^{\ln f(x)} = e^{1/2}$$

58. The limit leads to the indeterminate form 1^∞ . Let $f(x) = (e^x + x)^{1/x} \Rightarrow \ln f(x) = \frac{\ln(e^x + x)}{x}$

$$\Rightarrow \lim_{x \rightarrow 0} \ln f(x) = \lim_{x \rightarrow 0} \frac{\ln(e^x + x)}{x} = \lim_{x \rightarrow 0} \frac{e^x + 1}{e^x + x} = 2. \text{ Therefore } \lim_{x \rightarrow 0} (e^x + x)^{1/x} = \lim_{x \rightarrow 0} f(x) = \lim_{x \rightarrow 0} e^{\ln f(x)} = e^2$$

59. The limit leads to the indeterminate form 0^0 . Let $f(x) = x^x \Rightarrow \ln f(x) = x \ln x \Rightarrow \ln f(x) = \frac{\ln x}{\left(\frac{1}{x}\right)}$

$$= \lim_{x \rightarrow 0^+} \ln f(x) = \lim_{x \rightarrow 0^+} \frac{\ln x}{\left(\frac{1}{x}\right)} = \lim_{x \rightarrow 0^+} \frac{\left(\frac{1}{x}\right)}{\left(-\frac{1}{x^2}\right)} = \lim_{x \rightarrow 0^+} (-x) = 0. \text{ Therefore } \lim_{x \rightarrow 0^+} x^x = \lim_{x \rightarrow 0^+} f(x) = \lim_{x \rightarrow 0^+} e^{\ln f(x)} = e^0 = 1$$

60. The limit leads to the indeterminate form ∞^0 . Let $f(x) = \left(1 + \frac{1}{x}\right)^x \Rightarrow \ln f(x) = \frac{\ln\left(1 + \frac{1}{x}\right)}{\frac{1}{x}} \Rightarrow \lim_{x \rightarrow 0^+} \ln f(x)$

$$= \lim_{x \rightarrow 0^+} \frac{\left(\frac{-x^{-2}}{1+x^{-1}}\right)}{\left(-\frac{1}{x^2}\right)} = \lim_{x \rightarrow 0^+} \frac{1}{1+x^{-1}} = \lim_{x \rightarrow 0^+} \frac{x}{x+1} = 0. \text{ Therefore } \lim_{x \rightarrow 0^+} \left(1 + \frac{1}{x}\right)^x = \lim_{x \rightarrow 0^+} f(x) = \lim_{x \rightarrow 0^+} e^{\ln f(x)} = e^0 = 1$$

61. The limit leads to the indeterminate form 1^∞ . Let $f(x) = \left(\frac{x+2}{x-1}\right)^x \Rightarrow \ln f(x) = \ln\left(\frac{x+2}{x-1}\right)^x = x \ln\left(\frac{x+2}{x-1}\right)$
 $\Rightarrow \lim_{x \rightarrow \infty} \ln f(x) = \lim_{x \rightarrow \infty} x \ln\left(\frac{x+2}{x-1}\right) = \lim_{x \rightarrow \infty} \left(\frac{\ln\left(\frac{x+2}{x-1}\right)}{\frac{1}{x}}\right) = \lim_{x \rightarrow \infty} \left(\frac{\ln(x+2) - \ln(x-1)}{\frac{1}{x}}\right) = \lim_{x \rightarrow \infty} \left(\frac{\frac{1}{x+2} - \frac{1}{x-1}}{-\frac{1}{x^2}}\right) = \lim_{x \rightarrow \infty} \left(\frac{-3}{\frac{(x+2)(x-1)}{x^2}}\right)$
 $= \lim_{x \rightarrow \infty} \left(\frac{3x^2}{(x+2)(x-1)}\right) = \lim_{x \rightarrow \infty} \left(\frac{6x}{2x+1}\right) = \lim_{x \rightarrow \infty} \left(\frac{6}{2}\right) = 3$. Therefore, $\lim_{x \rightarrow \infty} \left(\frac{x+2}{x-1}\right)^x = \lim_{x \rightarrow \infty} f(x) = \lim_{x \rightarrow \infty} e^{\ln f(x)} = e^3$
62. The limit leads to the indeterminate form ∞^0 . Let $f(x) = \left(\frac{x^2+1}{x+2}\right)^{1/x} \Rightarrow \ln f(x) = \ln\left(\frac{x^2+1}{x+2}\right)^{1/x} = \frac{1}{x} \ln\left(\frac{x^2+1}{x+2}\right)$
 $\Rightarrow \lim_{x \rightarrow \infty} \ln f(x) = \lim_{x \rightarrow \infty} \frac{1}{x} \ln\left(\frac{x^2+1}{x+2}\right) = \lim_{x \rightarrow \infty} \frac{\ln\left(\frac{x^2+1}{x+2}\right)}{x} = \lim_{x \rightarrow \infty} \frac{\ln(x^2+1) - \ln(x+2)}{x} = \lim_{x \rightarrow \infty} \frac{\frac{2x}{x^2+1} - \frac{1}{x+2}}{1} = \lim_{x \rightarrow \infty} \frac{x^2 + 4x - 1}{x^2 + 2x + 2}$
 $= \lim_{x \rightarrow \infty} \frac{x^2 + 4x - 1}{x^2 + 2x + 2} = \lim_{x \rightarrow \infty} \frac{2x + 4}{2x + 2} = \lim_{x \rightarrow \infty} \frac{2}{2} = 1$. Therefore, $\lim_{x \rightarrow \infty} \left(\frac{x^2+1}{x+2}\right)^{1/x} = \lim_{x \rightarrow \infty} f(x) = \lim_{x \rightarrow \infty} e^{\ln f(x)} = e^1 = e$
63. $\lim_{x \rightarrow 0^+} x^2 \ln x = \lim_{x \rightarrow 0^+} \left(\frac{\ln x}{\frac{1}{x^2}}\right) = \lim_{x \rightarrow 0^+} \left(\frac{-\frac{1}{x}}{-\frac{2}{x^3}}\right) = \lim_{x \rightarrow 0^+} \left(-\frac{x^3}{2x}\right) = \lim_{x \rightarrow 0^+} \left(-\frac{3x^2}{2}\right) = 0$
64. $\lim_{x \rightarrow 0^+} x(\ln x)^2 = \lim_{x \rightarrow 0^+} \left(\frac{(\ln x)^2}{\frac{1}{x}}\right) = \lim_{x \rightarrow 0^+} \left(\frac{2(\ln x)\frac{1}{x}}{-\frac{1}{x^2}}\right) = \lim_{x \rightarrow 0^+} \left(\frac{2 \ln x}{-\frac{1}{x}}\right) = \lim_{x \rightarrow 0^+} \left(\frac{\frac{2}{x}}{\frac{1}{x^2}}\right) = \lim_{x \rightarrow 0^+} \left(\frac{2x^2}{x}\right) = \lim_{x \rightarrow 0^+} (2x) = 0$
65. $\lim_{x \rightarrow 0^+} x \tan\left(\frac{\pi}{2} - x\right) = \lim_{x \rightarrow 0^+} \left(\frac{x}{\cot\left(\frac{\pi}{2} - x\right)}\right) = \lim_{x \rightarrow 0^+} \left(\frac{1}{\csc^2\left(\frac{\pi}{2} - x\right)}\right) = \frac{1}{1} = 1$
66. $\lim_{x \rightarrow 0^+} \sin x \cdot \ln x = \lim_{x \rightarrow 0^+} \left(\frac{\ln x}{\csc x}\right) = \lim_{x \rightarrow 0^+} \left(\frac{\frac{1}{x}}{-\csc x \cot x}\right) = \lim_{x \rightarrow 0^+} \left(-\frac{\sin x \tan x}{x}\right) = \lim_{x \rightarrow 0^+} \left(-\frac{\sin x \sec^2 x + \cos x \tan x}{1}\right) = \frac{0}{1} = 0$
67. $\lim_{x \rightarrow \infty} \frac{\sqrt{9x+1}}{\sqrt{x+1}} = \sqrt{\lim_{x \rightarrow \infty} \frac{9x+1}{x+1}} = \sqrt{\lim_{x \rightarrow \infty} \frac{9}{1}} = \sqrt{9} = 3$
68. $\lim_{x \rightarrow 0^+} \frac{\sqrt{x}}{\sqrt{\sin x}} = \sqrt{\lim_{x \rightarrow 0^+} \frac{1}{\frac{\sin x}{x}}} = \sqrt{\frac{1}{1}} = 1$
69. $\lim_{x \rightarrow \left(\frac{\pi}{2}\right)^-} \frac{\sec x}{\tan x} = \lim_{x \rightarrow \left(\frac{\pi}{2}\right)^-} \left(\frac{1}{\cos x}\right) \left(\frac{\cos x}{\sin x}\right) = \lim_{x \rightarrow \left(\frac{\pi}{2}\right)^-} \frac{1}{\sin x} = 1$
70. $\lim_{x \rightarrow 0^+} \frac{\cot x}{\csc x} = \lim_{x \rightarrow 0^+} \left(\frac{\frac{\cos x}{\sin x}}{\frac{1}{\sin x}}\right) = \lim_{x \rightarrow 0^+} \cos x = 1$
71. $\lim_{x \rightarrow \infty} \frac{2^x - 3^x}{3^x + 4^x} = \lim_{x \rightarrow \infty} \frac{\left(\frac{2}{3}\right)^x - 1}{1 + \left(\frac{4}{3}\right)^x} = 0$

72. $\lim_{x \rightarrow -\infty} \frac{2^x + 4^x}{5^x - 2^x} = \lim_{x \rightarrow -\infty} \frac{1 + \left(\frac{4}{2}\right)^x}{\left(\frac{5}{2}\right)^x - 1} = \lim_{x \rightarrow -\infty} \frac{1 + 2^x}{\left(\frac{5}{2}\right)^x - 1} = \frac{1+0}{0-1} = -1$

73. $\lim_{x \rightarrow \infty} \frac{e^{x^2}}{xe^x} = \lim_{x \rightarrow \infty} \frac{e^{x^2-x}}{x} = \lim_{x \rightarrow \infty} \frac{e^{x(x-1)}}{x} = \lim_{x \rightarrow \infty} \frac{e^{x(x-1)}(2x-1)}{1} = \infty$

74. $\lim_{x \rightarrow 0^+} \frac{x}{e^{-1/x}} = \lim_{x \rightarrow 0^+} \frac{e^{1/x}}{\frac{1}{x}} = \lim_{x \rightarrow 0^+} \frac{e^{1/x} \left(\frac{-1}{x^2}\right)}{-\frac{1}{x^2}} = \lim_{x \rightarrow 0^+} e^{1/x} = \infty$

75. Part (b) is correct because part (a) is neither in the $\frac{0}{0}$ nor $\frac{\infty}{\infty}$ form and so l'Hôpital's rule may not be used.

76. Part (b) is correct; the step $\lim_{x \rightarrow 0} \frac{2x-2}{2x-\cos x} = \lim_{x \rightarrow 0} \frac{2}{2+\sin x}$ in part (a) is false because $\lim_{x \rightarrow 0} \frac{2x-2}{2x-\cos x}$ is not an indeterminate quotient form.

77. Part (d) is correct, the other parts are indeterminate forms and cannot be calculated by the incorrect arithmetic

78. (a) We seek c in $(-2, 0)$ so that $\frac{f'(c)}{g'(c)} = \frac{f(0)-f(-2)}{g(0)-g(-2)} = \frac{0+2}{0-4} = -\frac{1}{2}$. Since $f'(c) = 1$ and $g'(c) = 2c$ we have that $\frac{1}{2c} = -\frac{1}{2} \Rightarrow c = -1$.

(b) We seek c in (a, b) so that $\frac{f'(c)}{g'(c)} = \frac{f(b)-f(a)}{g(b)-g(a)} = \frac{b-a}{b^2-a^2} = \frac{1}{b+a}$. Since $f'(c) = 1$ and $g'(c) = 2c$ we have that $\frac{1}{2c} = \frac{1}{b+a} \Rightarrow c = \frac{b+a}{2}$.

(c) We seek c in $(0, 3)$ so that $\frac{f'(c)}{g'(c)} = \frac{f(3)-f(0)}{g(3)-g(0)} = \frac{-3-0}{9-0} = -\frac{1}{3}$. Since $f'(c) = c^2 - 4$ and $g'(c) = 2c$ we have that $\frac{c^2-4}{2c} = -\frac{1}{3} \Rightarrow c = \frac{-1 \pm \sqrt{37}}{3} \Rightarrow c = \frac{-1 + \sqrt{37}}{3}$.

79. If $f(x)$ is to be continuous at $x = 0$, then $\lim_{x \rightarrow 0} f(x) = f(0) \Rightarrow c = f(0) = \lim_{x \rightarrow 0} \frac{9x-3\sin 3x}{5x^3} = \lim_{x \rightarrow 0} \frac{9-9\cos 3x}{15x^2}$
 $= \lim_{x \rightarrow 0} \frac{27\sin 3x}{30x} = \lim_{x \rightarrow 0} \frac{81\cos 3x}{30} = \frac{27}{10}$.

80. $\lim_{x \rightarrow 0} \left(\frac{\tan 2x}{x^3} + \frac{a}{x^2} + \frac{\sin bx}{x} \right) = \lim_{x \rightarrow 0} \left(\frac{\tan 2x + ax + x^2 \sin bx}{x^3} \right) = \lim_{x \rightarrow 0} \left(\frac{2\sec^2 2x + a + bx^2 \cos bx + 2x \sin bx}{3x^2} \right)$ will be in $\frac{0}{0}$ form if $\lim_{x \rightarrow 0} (2\sec^2 2x + a + bx^2 \cos bx + 2x \sin bx) = a + 2 = 0 \Rightarrow a = -2$; $\lim_{x \rightarrow 0} \left(\frac{2\sec^2 2x - 2 + bx^2 \cos bx + 2x \sin bx}{3x^2} \right)$
 $= \lim_{x \rightarrow 0} \left(\frac{8\sec^2 2x \tan 2x - b^2 x^2 \sin bx + 4bx \cos bx + 2 \sin bx}{6x} \right) = \lim_{x \rightarrow 0} \left(\frac{32\sec^2 2x \tan^2 2x + 16 \sec^4 2x - b^3 x^2 \cos bx - 6b^2 x \sin bx + 6b \cos bx}{6} \right)$
 $= \frac{16+6b}{6} = 0 \Rightarrow 16 + 6b = 0 \Rightarrow b = -\frac{8}{3}$

81. (a)

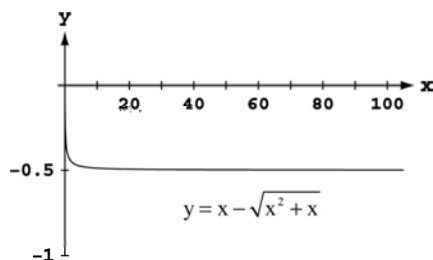

(b) The limit leads to the indeterminate form $\infty - \infty$:

$$\begin{aligned} \lim_{x \rightarrow \infty} \left(x - \sqrt{x^2 + x} \right) &= \lim_{x \rightarrow \infty} \left(x - \sqrt{x^2 + x} \right) \left(\frac{x + \sqrt{x^2 + x}}{x + \sqrt{x^2 + x}} \right) = \lim_{x \rightarrow \infty} \left(\frac{x^2 - (x^2 + x)}{x + \sqrt{x^2 + x}} \right) = \lim_{x \rightarrow \infty} \frac{-x}{x + \sqrt{x^2 + x}} \\ &= \lim_{x \rightarrow \infty} \frac{-1}{1 + \sqrt{1 + \frac{1}{x}}} = \frac{-1}{1 + \sqrt{1 + 0}} = -\frac{1}{2} \end{aligned}$$

82. $\lim_{x \rightarrow \infty} \left(\sqrt{x^2 + 1} - \sqrt{x} \right) = \lim_{x \rightarrow \infty} x \left(\frac{\sqrt{x^2 + 1}}{x} - \frac{\sqrt{x}}{x} \right) = \lim_{x \rightarrow \infty} x \left(\sqrt{\frac{x^2 + 1}{x^2}} - \sqrt{\frac{x}{x^2}} \right) = \lim_{x \rightarrow \infty} x \left(\sqrt{1 + \frac{1}{x^2}} - \sqrt{\frac{1}{x}} \right) = \infty$

83. The graph indicates a limit near -1 . The limit leads to the indeterminate form $\frac{0}{0}$:

$$\begin{aligned} \lim_{x \rightarrow 1} \frac{2x^2 - (3x + 1)\sqrt{x} + 2}{x - 1} &= \lim_{x \rightarrow 1} \frac{2x^2 - 3x^{3/2} - x^{1/2} + 2}{x - 1} = \lim_{x \rightarrow 1} \frac{4x - \frac{9}{2}x^{1/2} - \frac{1}{2}x^{-1/2}}{1} \\ &= \frac{4 - \frac{9}{2} - \frac{1}{2}}{1} = \frac{4 - 5}{1} = -1 \end{aligned}$$

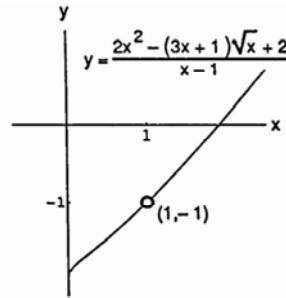

84. (a) The limit leads to the indeterminate form 1^∞ . Let $f(x) = \left(1 + \frac{1}{x}\right)^x \Rightarrow \ln f(x) = x \ln \left(1 + \frac{1}{x}\right) \Rightarrow \lim_{x \rightarrow \infty} \ln f(x)$

$$\begin{aligned} &= \lim_{x \rightarrow \infty} \frac{\ln \left(1 + \frac{1}{x}\right)}{\left(\frac{1}{x}\right)} = \lim_{x \rightarrow \infty} \frac{\ln(1 + x^{-1})}{x^{-1}} = \lim_{x \rightarrow \infty} \frac{\left(\frac{-x^{-2}}{1 + x^{-1}}\right)}{-x^{-2}} = \lim_{x \rightarrow \infty} \frac{1}{1 + \left(\frac{1}{x}\right)} = \frac{1}{1 + 0} = 1 \Rightarrow \lim_{x \rightarrow \infty} \left(1 + \frac{1}{x}\right)^x = \lim_{x \rightarrow \infty} f(x) \\ &= \lim_{x \rightarrow \infty} e^{\ln f(x)} = e^1 = e \end{aligned}$$

(b) $x \quad \left(1 + \frac{1}{x}\right)^x$

10	2.5937424601
100	2.70481382942
1000	2.71692393224
10,000	2.71814592683
100,000	2.71826823717

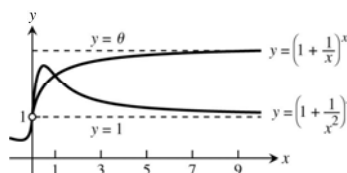
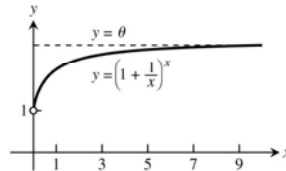

Both functions have limits as x approaches infinity. The function f has a maximum but no minimum while g has no extrema. The limit of $f(x)$ leads to the indeterminate form 1^∞ .

(c) Let $f(x) = \left(1 + \frac{1}{x^2}\right)^x \Rightarrow \ln f(x) = x \ln \left(1 + x^{-2}\right)$

$$\Rightarrow \lim_{x \rightarrow \infty} \ln f(x) = \lim_{x \rightarrow \infty} \frac{\ln(1 + x^{-2})}{x^{-1}} = \lim_{x \rightarrow \infty} \frac{\left(\frac{-2x^{-3}}{1 + x^{-2}}\right)}{-x^{-2}} = \lim_{x \rightarrow \infty} \frac{2x^2}{x^3 + x} = \lim_{x \rightarrow \infty} \frac{4x}{3x^2 + 1} = \lim_{x \rightarrow \infty} \frac{4}{6x} = 0.$$

Therefore $\lim_{x \rightarrow \infty} \left(1 + \frac{1}{x^2}\right)^x = \lim_{x \rightarrow \infty} f(x) = \lim_{x \rightarrow \infty} e^{\ln f(x)} = e^0 = 1$

85. Let $f(k) = \left(1 + \frac{r}{k}\right)^k \Rightarrow \ln f(k) = \frac{\ln(1+rk^{-1})}{k^{-1}} \Rightarrow \lim_{k \rightarrow \infty} \frac{\ln(1+rk^{-1})}{k^{-1}} = \lim_{k \rightarrow \infty} \frac{\left(\frac{-rk^{-2}}{1+rk^{-1}}\right)}{-k^{-2}} = \lim_{k \rightarrow \infty} \frac{r}{1+rk^{-1}} = \lim_{k \rightarrow \infty} \frac{rk}{k+r} = \lim_{k \rightarrow \infty} \frac{r}{1} = r$. Therefore $\lim_{k \rightarrow \infty} \left(1 + \frac{r}{k}\right)^k = \lim_{k \rightarrow \infty} f(k) = \lim_{k \rightarrow \infty} e^{\ln f(k)} = e^r$.

86. (a) $y = x^{1/x} \Rightarrow \ln y = \frac{\ln x}{x} \Rightarrow \frac{y'}{y} = \frac{\left(\frac{1}{x}\right)(x) - \ln x}{x^2} \Rightarrow y' = \left(\frac{1 - \ln x}{x^2}\right)(x^{1/x})$. The sign pattern is $y' = \underset{0}{|+++++} \underset{e}{|-----}$ which indicates a maximum value of $y = e^{1/e}$ when $x = e$

(b) $y = x^{1/x^2} \Rightarrow \ln y = \frac{\ln x}{x^2} \Rightarrow \frac{y'}{y} = \frac{\left(\frac{1}{x}\right)(x^2) - 2x \ln x}{x^4} \Rightarrow y' = \left(\frac{1 - 2 \ln x}{x^3}\right)(x^{1/x^2})$. The sign pattern is $y' = \underset{0}{|+++} \underset{\sqrt{e}}{|-----}$ which indicates a maximum of $y = e^{1/(2e)}$ when $x = \sqrt{e}$

(c) $y = x^{1/x^n} \Rightarrow \ln y = \frac{\ln x}{x^n} = \frac{\left(\frac{1}{x}\right)(x^n) - (\ln x)(nx^{n-1})}{x^{2n}} \Rightarrow y' = \frac{x^{n-1}(1 - n \ln x)}{x^{2n}} \cdot x^{1/x}$. The sign pattern is $y' = \underset{0}{|+++} \underset{\sqrt[n]{e}}{|-----}$ which indicates a maximum of $y = e^{1/(ne)}$ when $x = \sqrt[n]{e}$

(d) $\lim_{x \rightarrow \infty} x^{1/x^n} = \lim_{x \rightarrow \infty} \left(e^{\ln x}\right)^{1/x^n} = \lim_{x \rightarrow \infty} e^{(\ln x)x^{-n}} = \exp\left(\lim_{x \rightarrow \infty} \frac{\ln x}{x^n}\right) = \exp\left(\lim_{x \rightarrow \infty} \left(\frac{1}{nx^n}\right)\right) = e^0 = 1$

87. (a) $y = x \tan\left(\frac{1}{x}\right), \lim_{x \rightarrow \infty} \left(x \tan\left(\frac{1}{x}\right)\right) = \lim_{x \rightarrow \infty} \left(\frac{\tan\left(\frac{1}{x}\right)}{\frac{1}{x}}\right) = \lim_{x \rightarrow \infty} \left(\frac{\sec^2\left(\frac{1}{x}\right)\left(-\frac{1}{x^2}\right)}{\left(-\frac{1}{x^2}\right)}\right) = \lim_{x \rightarrow \infty} \sec^2\left(\frac{1}{x}\right) = 1; \lim_{x \rightarrow -\infty} \left(x \tan\left(\frac{1}{x}\right)\right) = \lim_{x \rightarrow -\infty} \left(\frac{\tan\left(\frac{1}{x}\right)}{\frac{1}{x}}\right) = \lim_{x \rightarrow -\infty} \left(\frac{\sec^2\left(\frac{1}{x}\right)\left(-\frac{1}{x^2}\right)}{\left(-\frac{1}{x^2}\right)}\right) = \lim_{x \rightarrow -\infty} \sec^2\left(\frac{1}{x}\right) = 1 \Rightarrow$ the horizontal asymptote is $y = 1$ as $x \rightarrow \infty$ and as $x \rightarrow -\infty$.

(b) $y = \frac{3x + e^{2x}}{2x + e^{3x}}, \lim_{x \rightarrow \infty} \left(\frac{3x + e^{2x}}{2x + e^{3x}}\right) = \lim_{x \rightarrow \infty} \left(\frac{3 + 2e^{2x}}{2 + 3e^{3x}}\right) = \lim_{x \rightarrow \infty} \left(\frac{4e^{2x}}{9e^{3x}}\right) = \lim_{x \rightarrow \infty} \left(\frac{4}{9e^x}\right) = 0; \lim_{x \rightarrow -\infty} \left(\frac{3x + e^{2x}}{2x + e^{3x}}\right) = \lim_{x \rightarrow -\infty} \left(\frac{3 + e^{2x}}{2 + 3e^{3x}}\right) = \frac{3}{2} \Rightarrow$ the horizontal asymptotes are $y = 0$ as $x \rightarrow \infty$ and $y = \frac{3}{2}$ as $x \rightarrow -\infty$.

88. $f'(0) = \lim_{h \rightarrow 0} \frac{f(0+h) - f(0)}{h} = \lim_{h \rightarrow 0} \frac{e^{-1/h^2} - 0}{h} = \lim_{h \rightarrow 0} \frac{e^{-1/h^2}}{h} = \lim_{h \rightarrow 0} \left(\frac{\frac{1}{h}}{e^{1/h^2}}\right) = \lim_{h \rightarrow 0} \left(\frac{-\frac{1}{h^2}}{e^{1/h^2}\left(\frac{-2}{h^3}\right)}\right) = \lim_{h \rightarrow 0} \left(\frac{h}{2e^{1/h^2}}\right) = \lim_{h \rightarrow 0} \left(\frac{h}{2} e^{-1/h^2}\right) = 0$

89. (a) We should assign the value 1 to $f(x) = (\sin x)^x$ to make it continuous at $x = 0$.

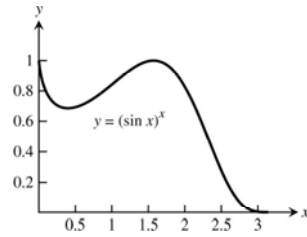

$$(b) \ln f(x) = x \ln(\sin x) = \frac{\ln(\sin x)}{\left(\frac{1}{x}\right)} \Rightarrow \lim_{x \rightarrow 0^+} \ln f(x) = \lim_{x \rightarrow 0^+} \frac{\ln(\sin x)}{\left(\frac{1}{x}\right)} = \lim_{x \rightarrow 0^+} \frac{\left(\frac{1}{\sin x}\right)(\cos x)}{\left(-\frac{1}{x^2}\right)} = \lim_{x \rightarrow 0} \frac{-x^2}{\tan x}$$

$$= \lim_{x \rightarrow 0} \frac{-2x}{\sec^2 x} = 0 \Rightarrow \lim_{x \rightarrow 0} f(x) = e^0 = 1$$

- (c) The maximum value of $f(x)$ is close to 1 near the point $x \approx 1.55$ (see the graph in part (a)).
 (d) The root in question is near 1.57.

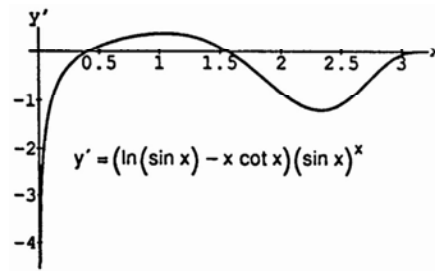

90. (a) When $\sin x < 0$ there are gaps in the sketch. The width of each gap is π .

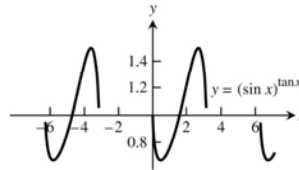

(b) Let $f(x) = (\sin x)^{\tan x}$

$$\Rightarrow \ln f(x) = (\tan x) \ln(\sin x) \Rightarrow \lim_{x \rightarrow \left(\frac{\pi}{2}\right)^-} \ln f(x)$$

$$= \lim_{x \rightarrow \left(\frac{\pi}{2}\right)^-} \frac{\ln(\sin x)}{\cot x} = \lim_{x \rightarrow \left(\frac{\pi}{2}\right)^-} \frac{\left(\frac{1}{\sin x}\right)(\cos x)}{-\csc^2 x}$$

$$= \lim_{x \rightarrow \left(\frac{\pi}{2}\right)^-} \frac{\cos x}{(-\csc x)} = 0 \Rightarrow \lim_{x \rightarrow \left(\frac{\pi}{2}\right)^-} f(x) = e^0 = 1.$$

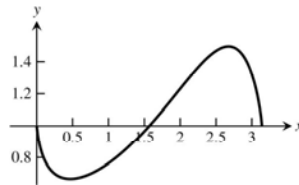

Similarly, $\lim_{x \rightarrow \left(\frac{\pi}{2}\right)^+} f(x) = e^0 = 1$. Therefore,

$$\lim_{x \rightarrow \frac{\pi}{2}} f(x) = 1.$$

- (c) From the graph in part (b) we have a minimum of about 0.665 at $x \approx 0.47$ and the maximum is about 1.491 at $x \approx 2.66$.

4.6 APPLIED OPTIMIZATION

- Let ℓ and w represent the length and width of the rectangle, respectively. With an area of 16 in.^2 , we have that $(\ell)(w) = 16 \Rightarrow w = 16\ell^{-1} \Rightarrow$ the perimeter is $P = 2\ell + 2w = 2\ell + 32\ell^{-1}$ and $P'(\ell) = 2 - \frac{32}{\ell^2} = \frac{2(\ell^2 - 16)}{\ell^2}$. Solving $P'(\ell) = 0 \Rightarrow \frac{2(\ell+4)(\ell-4)}{\ell^2} = 0 \Rightarrow \ell = -4, 4$. Since $\ell > 0$ for the length of a rectangle, ℓ must be 4 and $w = 4 \Rightarrow$ the perimeter is 16 in., a minimum since $P''(\ell) = \frac{16}{\ell^3} > 0$.
- Let x represent the length of the rectangle in meters ($0 < x < 4$). Then the width is $4 - x$ and the area is $A(x) = x(4 - x) = 4x - x^2$. Since $A'(x) = 4 - 2x$, the critical point occurs at $x = 2$. Since, $A'(x) > 0$ for $0 < x < 2$ and $A'(x) < 0$ for $2 < x < 4$, this critical point corresponds to the maximum area. The rectangle with the largest area measures 2 m by $4 - 2 = 2$ m, so it is a square.

Graphical Support:

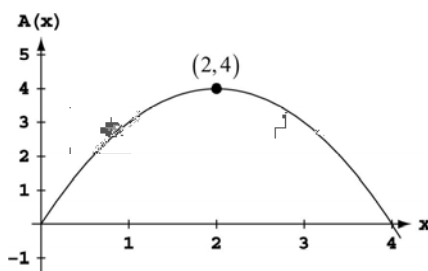

- The line containing point P also contains the points $(0, 1)$ and $(1, 0) \Rightarrow$ the line containing P is $y = 1 - x \Rightarrow$ a general point on that line is $(x, 1 - x)$.
 - The area $A(x) = 2x(1 - x)$, where $0 \leq x \leq 1$.
 - When $A(x) = 2x - 2x^2$, then $A'(x) = 0 \Rightarrow 2 - 4x = 0 \Rightarrow x = \frac{1}{2}$. Since $A(0) = 0$ and $A(1) = 0$, we conclude that $A(\frac{1}{2}) = \frac{1}{2}$ sq units is the largest area. The dimensions are 1 unit by $\frac{1}{2}$ unit.

- The area of the rectangle is $A = 2xy = 2x(12 - x^2)$, where $0 \leq x \leq \sqrt{12}$. Solving $A'(x) = 0 \Rightarrow 24 - 6x^2 = 0 \Rightarrow x = -2$ or 2 . Now -2 is not in the domain, and since $A(0) = 0$ and $A(\sqrt{12}) = 0$, we conclude that $A(2) = 32$ square units is the maximum area. The dimensions are 4 units by 8 units.

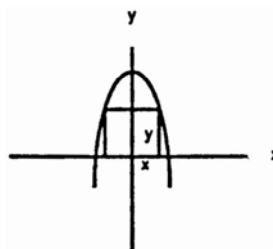

- The volume of the box is $V(x) = x(15 - 2x)(8 - 2x) = 120x - 46x^2 + 4x^3$, where $0 \leq x \leq 4$. Solving $V'(x) = 0 \Rightarrow 120 - 92x + 12x^2 = 4(6 - x)(5 - 3x) = 0 \Rightarrow x = \frac{5}{3}$ or 6 , but 6 is not in the domain. Since $V(0) = V(4) = 0$, $V(\frac{5}{3}) = \frac{2450}{27} \approx 91 \text{ in}^3$ must be the maximum volume of the box with dimensions $\frac{14}{3} \times \frac{35}{3} \times \frac{5}{3}$ inches.

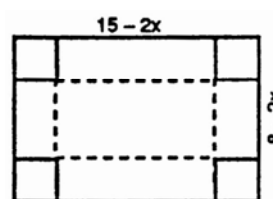

6. The area of the triangle is $A = \frac{1}{2}ba = \frac{b}{2}\sqrt{400-b^2}$, where $0 \leq b \leq 20$. Then $\frac{dA}{db} = \frac{1}{2}\sqrt{400-b^2} - \frac{b^2}{2\sqrt{400-b^2}} = \frac{200-b^2}{\sqrt{400-b^2}} = 0 \Rightarrow$ the interior critical point is $b = 10\sqrt{2}$.

When $b = 0$ or 20 , the area is zero $\Rightarrow A(10\sqrt{2})$ is the maximum area. When $a^2 + b^2 = 400$ and $b = 10\sqrt{2}$, the value of a is also $10\sqrt{2} \Rightarrow$ the maximum area occurs when $a = b$.

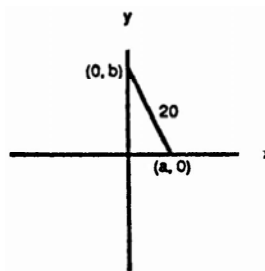

7. The area is $A(x) = x(800 - 2x)$, where $0 \leq x \leq 400$. Solving $A'(x) = 800 - 4x = 0 \Rightarrow x = 200$. With $A(0) = A(400) = 0$, the maximum area is $A(200) = 80,000 \text{ m}^2$. The dimensions are 200 m by 400 m.

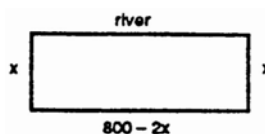

8. The area is $2xy = 216 \Rightarrow y = \frac{108}{x}$. The amount of fence needed is $P = 4x + 3y = 4x + 324x^{-1}$, where $0 < x$; $\frac{dP}{dx} = 4 - \frac{324}{x^2} = 0 \Rightarrow x^2 - 81 = 0 \Rightarrow$ the critical points are 0 and ± 9 , but 0 and -9 are not in the domain. Then $P''(9) > 0 \Rightarrow$ at $x = 9$ there is a minimum \Rightarrow the dimensions of the outer rectangle are 18 m by 12 m \Rightarrow 72 meters of fence will be needed.

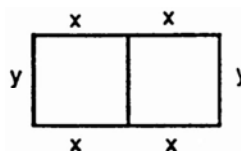

9. (a) We minimize the weight $= tS$ where S is the surface area, and t is the thickness of the steel walls of the tank. The surface area is $S = x^2 + 4xy$ where x is the length of a side of the square base of the tank, and y is its depth. The volume of the tank must be $500 \text{ ft}^3 \Rightarrow y = \frac{500}{x^2}$. Therefore, the weight of the tank is $w(x) = t\left(x^2 + \frac{2000}{x}\right)$. Treating the thickness as a constant gives $w'(x) = t\left(2x - \frac{2000}{x^2}\right)$. The critical value is at $x = 10$. Since $w''(10) = t\left(2 + \frac{4000}{10^3}\right) > 0$, there is a minimum at $x = 10$. Therefore, the optimum dimensions of the tank are 10 ft on the base edges and 5 ft deep.
- (b) Minimizing the surface area of the tank minimizes its weight for a given wall thickness. The thickness of the steel walls would likely be determined by other considerations such as structural requirements.
10. (a) The volume of the tank being 1125 ft^3 , we have that $yx^2 = 1125 \Rightarrow y = \frac{1125}{x^2}$. The cost of building the tank is $c(x) = 5x^2 + 30x\left(\frac{1125}{x^2}\right)$, where $0 < x$. Then $c'(x) = 10x - \frac{33750}{x^2} = 0 \Rightarrow$ the critical points are 0 and 15, but 0 is not in the domain. Thus, $c''(15) > 0 \Rightarrow$ at $x = 15$ we have a minimum. The values of $x = 15$ ft and $y = 5$ ft will minimize the cost.
- (b) The cost function $c = 5(x^2 + 4xy) + 10xy$, can be separated into two items: (1) the cost of the materials and labor to fabricate the tank, and (2) the cost for the excavation. Since the area of the sides and bottom of the tanks is $(x^2 + 4xy)$, it can be deduced that the unit cost to fabricate the tanks is $\$5/\text{ft}^2$. Normally, excavation costs are per unit volume of excavated material. Consequently, the total excavation cost can be taken as $10xy = \left(\frac{10}{x}\right)(x^2 y)$. This suggests that the unit cost of excavation is $\frac{\$10/\text{ft}^2}{x}$ where x is the length of a side of the square base of the tank in feet. For the least expensive tank, the unit cost for the excavation is

$\frac{\$10/\text{ft}^2}{15 \text{ ft}} = \frac{\$0.67}{\text{ft}^3} = \frac{\$18}{\text{yd}^3}$. The total cost of the least expensive tank is \$3375, which is the sum of \$2625 for fabrication and \$750 for the excavation.

11. The area of the printing is $(y - 4)(x - 8) = 50$.
Consequently, $y = \left(\frac{50}{x-8}\right) + 4$. The area of the paper is

$$A(x) = x\left(\frac{50}{x-8} + 4\right), \text{ where } 8 < x. \text{ Then}$$

$$A'(x) = \left(\frac{50}{x-8} + 4\right) - x\left(\frac{50}{(x-8)^2}\right) = \frac{4(x-8)^2 - 400}{(x-8)^2} = 0$$

\Rightarrow the critical points are -2 and 18 , but -2 is not in the domain. Thus $A''(18) > 0 \Rightarrow$ at $x = 18$ we have a minimum. Therefore the dimensions 18 by 9 inches minimize the amount of paper.

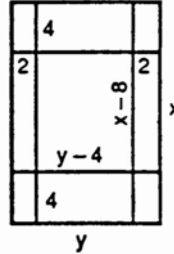

12. The volume of the cone is $V = \frac{1}{3}\pi r^2 h$, where $r = x = \sqrt{9 - y^2}$ and $h = y + 3$ (from the figure in the text). Thus, $V(y) = \frac{\pi}{3}(9 - y^2)(y + 3) = \frac{\pi}{3}(27 + 9y - 32y^2 - y^3) \Rightarrow V'(y) = \frac{\pi}{3}(9 - 6y - 3y^2) = \pi(1 - y)(3 + y)$. The critical points are -3 and 1 , but -3 is not in the domain. Thus $V''(1) = \frac{\pi}{3}(-6 - 6(1)) < 0 \Rightarrow$ at $y = 1$ we have a maximum volume of $V(1) = \frac{\pi}{3}(8)(4) = \frac{32\pi}{3}$ cubic units.

13. The area of the triangle is $A(\theta) = \frac{ab \sin \theta}{2}$, where $0 < \theta < \pi$. Solving $A'(\theta) = 0 \Rightarrow \frac{ab \cos \theta}{2} = 0 \Rightarrow \theta = \frac{\pi}{2}$. Since $A''(\theta) = -\frac{ab \sin \theta}{2} \Rightarrow A''\left(\frac{\pi}{2}\right) < 0$, there is a maximum at $\theta = \frac{\pi}{2}$.

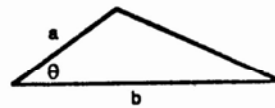

14. A volume $V = \pi r^2 h = 1000 \Rightarrow h = \frac{1000}{\pi r^2}$. The amount of material is the surface area given by the sides and bottom of the can $\Rightarrow S = 2\pi r h + \pi r^2 = \frac{2000}{r} + \pi r^2$, $0 < r$. Then $\frac{dS}{dr} = -\frac{2000}{r^2} + 2\pi r = 0 \Rightarrow \frac{\pi r^3 - 1000}{r^2} = 0$. The critical points are 0 and $\frac{10}{\sqrt[3]{\pi}}$, but 0 is not in the domain. Since $\frac{d^2S}{dr^2} = \frac{4000}{r^3} + 2\pi > 0$, we have a minimum surface area when $r = \frac{10}{\sqrt[3]{\pi}}$ cm and $h = \frac{1000}{\pi r^2} = \frac{10}{\sqrt[3]{\pi}}$ cm. Comparing this result to the result found in Example 2, if we include both ends of the can, then we have a minimum surface area when the can is shorter—specifically, when the height of the can is the same as its diameter.



15. With a volume of 1000 cm^3 and $V = \pi r^2 h$, then $h = \frac{1000}{\pi r^2}$. The amount of aluminum used per can is $A = 8r^2 + 2\pi r h = 8r^2 + \frac{2000}{r}$. Then $A'(r) = 16r - \frac{2000}{r^2} = 0 \Rightarrow \frac{8r^3 - 1000}{r^2} = 0 \Rightarrow$ the critical points are 0 and 5 , but $r = 0$ results in no can. Since $A''(r) = 16 + \frac{4000}{r^3} > 0$ we have a minimum at $r = 5 \Rightarrow h = \frac{40}{\pi}$ and $h:r = 8:\pi$.

16. (a) The base measures $10 - 2x$ in. by $\frac{15-2x}{2}$ in., so the volume formula is $V(x) = \frac{x(10-2x)(15-2x)}{2} = 2x^3 - 25x^2 + 75x$.
- (b) We require $x > 0$, $2x < 10$, and $2x < 15$. Combining these requirements, the domain is the interval $(0, 5)$.

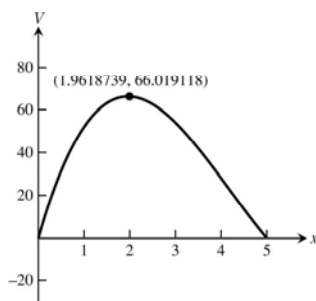

- (c) The maximum volume is approximately 66.02 in.^3 when $x \approx 1.96$ in.
- (d) $V'(x) = 6x^2 - 50x + 75$. The critical point occurs when $V'(x) = 0$, at $x = \frac{50 \pm \sqrt{(-50)^2 - 4(6)(75)}}{2(6)} = \frac{50 \pm \sqrt{700}}{12} = \frac{25 \pm 5\sqrt{7}}{6}$, that is, $x \approx 1.96$ or $x \approx 6.37$. We discard the larger value because it is not in the domain. Since $V''(x) = 12x - 50$, which is negative when $x \approx 1.96$, the critical point corresponds to the maximum volume. The maximum volume occurs when $x = \frac{25 - 5\sqrt{7}}{6} \approx 1.96$, which confirms the result in (c).
17. (a) The “sides” of the suitcase will measure $24 - 2x$ in. by $18 - 2x$ in. and will be $2x$ in. apart, so the volume formula is $V(x) = 2x(24 - 2x)(18 - 2x) = 8x^3 - 168x^2 + 862x$.
- (b) We require $x > 0$, $2x < 18$, and $2x < 12$. Combining these requirements, the domain is the interval $(0, 9)$.

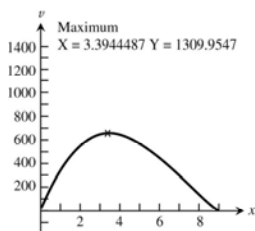

- (c) The maximum volume is approximately 1309.95 in.^3 when $x \approx 3.39$ in.
- (d) $V'(x) = 24x^2 - 336x + 864 = 24(x^2 - 14x + 36)$. The critical point is at $x = \frac{14 \pm \sqrt{(-14)^2 - 4(1)(36)}}{2(1)} = \frac{14 \pm \sqrt{52}}{2} = 7 \pm \sqrt{13}$, that is, $x \approx 3.39$ or $x \approx 10.61$. We discard the larger value because it is not in the domain. Since $V''(x) = 24(2x - 14)$ which is negative when $x \approx 3.39$, the critical point corresponds to the maximum volume. The maximum value occurs at $x = 7 - \sqrt{13} \approx 3.39$, which confirms the results in (c).
- (e) $8x^3 - 168x^2 + 862x = 1120 \Rightarrow 8(x^3 - 21x^2 + 108x - 140) = 0 \Rightarrow 8(x - 2)(x - 5)(x - 14) = 0$. Since 14 is not in the domain, the possible values of x are $x = 2$ in. or $x = 5$ in.
- (f) The dimensions of the resulting box are $2x$ in., $(24 - 2x)$ in., and $(18 - 2x)$. Each of these measurements must be positive, so that gives the domain of $(0, 9)$.
18. If the upper right vertex of the rectangle is located at $(x, 4 \cos 0.5x)$ for $0 < x < \pi$, then the rectangle has width $2x$ and height $4 \cos 0.5x$, so the area is $A(x) = 8x \cos 0.5x$. Solving $A'(x) = 0$ graphically for $0 < x < \pi$, we find that $x \approx 2.214$. Evaluating $2x$ and $4 \cos 0.5x$ for $x \approx 2.214$, the dimensions of the rectangle are approximately 4.43 (width) by 1.79 (height), and the maximum area is approximately 7.923.

19. Let the radius of the cylinder be r cm, $0 < r < 10$. Then the height is $2\sqrt{100 - r^2}$ and the volume is $V(r) = 2\pi r^2 \sqrt{100 - r^2} \text{ cm}^3$. Then, $V'(r) = 2\pi r^2 \left(\frac{1}{2\sqrt{100 - r^2}} \right) (-2r) + \left(2\pi \sqrt{100 - r^2} \right) (2r) = \frac{-2\pi r^3 + 4\pi r(100 - r^2)}{\sqrt{100 - r^2}}$

$= \frac{2\pi r(200-3r^2)}{\sqrt{100-r^2}}$. The critical point for $0 < r < 10$ occurs at $r = \sqrt{\frac{200}{3}} = 10\sqrt{\frac{2}{3}}$. Since $V'(r) > 0$ for $0 < r < 10\sqrt{\frac{2}{3}}$ and $V'(r) < 0$ for $10\sqrt{\frac{2}{3}} < r < 10$, the critical point corresponds to the maximum volume. The dimensions are $r = 10\sqrt{\frac{2}{3}} \approx 8.16$ cm and $h = \frac{20}{\sqrt{3}} \approx 11.55$ cm, and the volume is $\frac{4000\pi}{3\sqrt{3}} \approx 2418.40$ cm³.

20. (a) From the diagram we have $4x + \ell = 108$ and $V = x^2\ell$. The volume of the box is $V(x) = x^2(108 - 4x)$, where $0 \leq x \leq 27$. Then $V'(x) = 216x - 12x^2 = 12x(18 - x) = 0 \Rightarrow$ the critical points are 0 and 18, but $x = 0$ results in no box. Since $V''(x) = 216 - 24x < 0$ at $x = 18$ we have a maximum. The dimensions of the box are $18 \times 18 \times 36$ in.

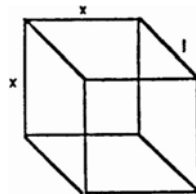

- (b) In terms of length, $V(\ell) = x^2\ell = \left(\frac{108-\ell}{4}\right)^2 \ell$. The graph indicates that the maximum volume occurs near $\ell = 36$, which is consistent with the result of part (a).

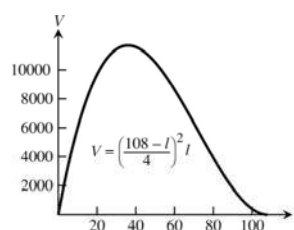

21. (a) From the diagram we have $3h + 2w = 108$ and $V = h^2w \Rightarrow V(h) = h^2\left(54 - \frac{3}{2}h\right) = 54h^2 - \frac{3}{2}h^3$. Then $V'(h) = 108h - \frac{9}{2}h^2 = \frac{9}{2}h(24 - h) = 0 \Rightarrow h = 0$ or $h = 24$, but $h = 0$ results in no box. Since $V''(h) = 108 - 9h < 0$ at $h = 24$, we have a maximum volume at $h = 24$ and $w = 54 - \frac{3}{2}h = 18$.

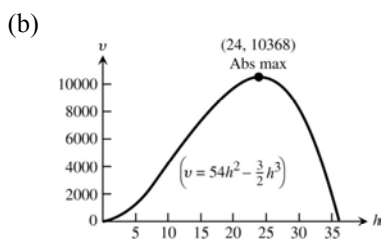
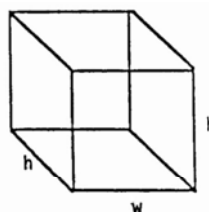

22. From the diagram the perimeter is $P = 2r + 2h + \pi r$, where r is the radius of the semicircle and h is the height of the rectangle. The amount of light transmitted proportional to $A = 2rh + \frac{1}{4}\pi r^2$
 $= r(P - 2r - \pi r) + \frac{1}{4}\pi r^2 = rP - 2r^2 - \frac{3}{4}\pi r^2$. Then $\frac{dA}{dr} = P - 4r - \frac{3}{2}\pi r = 0 \Rightarrow r = \frac{2P}{8+3\pi}$
 $\Rightarrow 2h = P - \frac{4P}{8+3\pi} - \frac{2\pi P}{8+3\pi} = \frac{(4+\pi)P}{8+3\pi}$. Therefore, $\frac{2r}{h} = \frac{8}{4+\pi}$ gives the proportions that admit the most light since $\frac{d^2A}{dr^2} = -4 - \frac{3}{2}\pi < 0$.

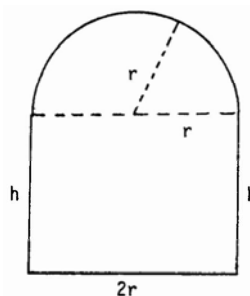

23. The fixed volume is $V = \pi r^2 h + \frac{2}{3} \pi r^3 \Rightarrow h = \frac{V}{\pi r^2} - \frac{2r}{3}$, where h is the height of the cylinder and r is the radius of the hemisphere. To minimize the cost we must minimize surface area of the cylinder added to twice the surface area of the hemisphere. Thus, we minimize $C = 2\pi r h + 4\pi r^2 = 2\pi r \left(\frac{V}{\pi r^2} - \frac{2r}{3} \right) + 4\pi r^2 = \frac{2V}{r} + \frac{8}{3} \pi r^2$.

Then $\frac{dC}{dr} = -\frac{2V}{r^2} + \frac{16}{3} \pi r = 0 \Rightarrow V = \frac{8}{3} \pi r^3 \Rightarrow r = \left(\frac{3V}{8\pi} \right)^{1/3}$. From the volume equation, $h = \frac{V}{\pi r^2} - \frac{2r}{3} = \frac{4V^{1/3}}{\pi^{1/3} \cdot 3^{2/3}} - \frac{2 \cdot 3^{1/3} \cdot V^{1/3}}{3 \cdot 2 \cdot \pi^{1/3}} = \frac{3^{1/3} \cdot 2 \cdot 4^{1/3} V^{1/3} - 2 \cdot 3^{1/3} \cdot V^{1/3}}{3 \cdot 2 \cdot \pi^{1/3}} = \left(\frac{3V}{\pi} \right)^{1/3}$. Since $\frac{d^2C}{dr^2} = \frac{4V}{r^3} + \frac{16}{3} \pi > 0$, these dimensions do minimize the cost.

24. The volume of the trough is maximized when the area of the cross section is maximized. From the diagram the area of the cross section is $A(\theta) = \cos \theta + \sin \theta \cos \theta$, $0 < \theta < \frac{\pi}{2}$. Then $A'(\theta) = -\sin \theta + \cos^2 \theta - \sin^2 \theta = -(2 \sin^2 \theta + \sin \theta - 1) = -(2 \sin \theta - 1)(\sin \theta + 1)$ so $A'(\theta) = 0 \Rightarrow \sin \theta = \frac{1}{2}$ or $\sin \theta = -1 \Rightarrow \theta = \frac{\pi}{6}$ because $\sin \theta \neq -1$ when $0 < \theta < \frac{\pi}{2}$. Also, $A'(\theta) > 0$ for $0 < \theta < \frac{\pi}{6}$ and $A'(\theta) < 0$ for $\frac{\pi}{6} < \theta < \frac{\pi}{2}$. Therefore, at $\theta = \frac{\pi}{6}$ there is a maximum.

25. (a) From the diagram we have: $\overline{AP} = x$, $\overline{RA} = \sqrt{L^2 - x^2}$, $\overline{PB} = 8.5 - x$,
 $\overline{CH} = \overline{DR} = 11 - \overline{RA} = 11 - \sqrt{L^2 - x^2}$, $\overline{QB} = \sqrt{x^2 - (8.5 - x)^2}$,
 $\overline{HQ} = 11 - \overline{CH} - \overline{QB} = 11 - \left[11 - \sqrt{L^2 - x^2} + \sqrt{x^2 - (8.5 - x)^2} \right]$
 $= \sqrt{L^2 - x^2} - \sqrt{x^2 - (8.5 - x)^2}$, $\overline{RQ}^2 = \overline{RH}^2 + \overline{HQ}^2$
 $= (8.5)^2 + \left(\sqrt{L^2 - x^2} - \sqrt{x^2 - (8.5 - x)^2} \right)^2$. It follows that $\overline{RP}^2 = \overline{PQ}^2 + \overline{RQ}^2$
 $\Rightarrow L^2 = x^2 + \left(\sqrt{L^2 - x^2} - \sqrt{x^2 - (8.5 - x)^2} \right)^2 + (8.5)^2$
 $\Rightarrow L^2 = x^2 + L^2 - x^2 - 2\sqrt{L^2 - x^2} \cdot \sqrt{x^2 - (8.5 - x)^2} + 17x - (8.5)^2 + (8.5)^2$
 $\Rightarrow 17^2 x^2 = 4(L^2 - x^2)(17x - (8.5)^2) \Rightarrow L^2 = x^2 + \frac{17^2 x^2}{4[17x - (8.5)^2]}$
 $= \frac{17x^3}{17x - (8.5)^2} = \frac{17x^3}{17x - \left(\frac{17}{2}\right)^2} = \frac{4x^3}{4x - 17} = \frac{2x^3}{2x - 8.5}$.

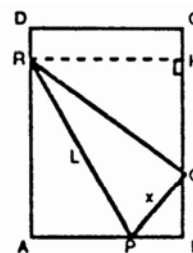

- (b) If $f(x) = \frac{4x^3}{4x-17}$ is minimized, then L^2 is minimized. Now $f'(x) = \frac{4x^2(8x-51)}{(4x-17)^2} \Rightarrow f'(x) < 0$ when $x < \frac{51}{8}$ and $f'(x) > 0$ when $x > \frac{51}{8}$. Thus L^2 is minimized when $x = \frac{51}{8}$.
 (c) When $x > \frac{51}{8}$, then $L \approx 11.0$ in.

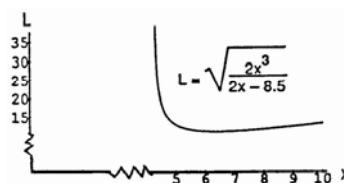

26. (a) From the figure in the text we have $P = 2x + 2y \Rightarrow y = \frac{P}{2} - x$. If $P = 36$, then $y = 18 - x$. When the cylinder is formed, $x = 2\pi r \Rightarrow r = \frac{x}{2\pi}$ and $h = y \Rightarrow h = 18 - x$. The volume of the cylinder is $V = \pi r^2 h \Rightarrow V(x) = \frac{18x^2 - x^3}{4\pi}$. Solving $V'(x) = \frac{3x(12-x)}{4\pi} = 0 \Rightarrow x = 0$ or 12 ; but when $x = 0$ there is no cylinder. Then $V''(x) = \frac{3}{\pi} \left(3 - \frac{x}{2} \right) \Rightarrow V''(12) < 0 \Rightarrow$ there is a maximum at $x = 12$. The values of $x = 12$ cm and $y = 6$ cm give the largest volume.

- (b) In this case $V(x) = \pi x^2(18-x)$. Solving $V'(x) = 3\pi x(12-x) = 0 \Rightarrow x = 0$ or 12 ; but $x = 0$ would result in no cylinder. Then $V''(x) = 6\pi(6-x) \Rightarrow V''(12) < 0 \Rightarrow$ there is a maximum at $x = 12$. The values of $x = 12$ cm and $y = 6$ cm give the largest volume.
27. Note that $h^2 + r^2 = 3$ and so $r = \sqrt{3-h^2}$. Then the volume is given by $V = \frac{\pi}{3}r^2h = \frac{\pi}{3}(3-h^2)h = \pi h - \frac{\pi}{3}h^3$ for $0 < h < \sqrt{3}$, and so $\frac{dV}{dh} = \pi - \pi r^2 = \pi(1-r^2)$. The critical point (for $h > 0$) occurs at $h = 1$. Since $\frac{dV}{dh} > 0$ for $0 < h < 1$, and $\frac{dV}{dh} < 0$ for $1 < h < \sqrt{3}$, the critical point corresponds to the maximum volume. The cone of greatest volume has radius $\sqrt{2}$ m, height 1 m, and volume $\frac{2\pi}{3}$ m³.
28. Let $d = \sqrt{(x-0)^2 + (y-0)^2} = \sqrt{x^2 + y^2}$ and $\frac{x}{a} + \frac{y}{b} = 1 \Rightarrow y = -\frac{b}{a}x + b$. We can minimize d by minimizing $D = \left(\sqrt{x^2 + y^2}\right)^2 = x^2 + \left(-\frac{b}{a}x + b\right)^2 \Rightarrow D' = 2x + 2\left(-\frac{b}{a}x + b\right)\left(-\frac{b}{a}\right) = 2x + \frac{2b^2}{a^2}x - \frac{2b^2}{a}$. $D' = 0 \Rightarrow 2\left(x + \frac{b^2}{a^2}x - \frac{b^2}{a}\right) = 0 \Rightarrow x = \frac{ab^2}{a^2+b^2}$ is the critical point $\Rightarrow y = -\frac{b}{a}\left(\frac{ab^2}{a^2+b^2}\right) + b = \frac{a^2b}{a^2+b^2}$. $D'' = 2 + \frac{2b^2}{a^2} \Rightarrow D''\left(\frac{ab^2}{a^2+b^2}\right) = 2 + \frac{2b^2}{a^2} > 0 \Rightarrow$ the critical point is a local minimum $\Rightarrow \left(\frac{ab^2}{a^2+b^2}, \frac{a^2b}{a^2+b^2}\right)$ is the point on the line $\frac{x}{a} + \frac{y}{b} = 1$ that is closest to the origin.
29. Let $S(x) = x + \frac{1}{x}$, $x > 0 \Rightarrow S'(x) = 1 - \frac{1}{x^2} = \frac{x^2-1}{x^2}$. $S'(x) = 0 \Rightarrow \frac{x^2-1}{x^2} = 0 \Rightarrow x^2 - 1 = 0 \Rightarrow x = \pm 1$. Since $x > 0$, we only consider $x = 1$. $S''(x) = \frac{2}{x^3} \Rightarrow S''(1) = \frac{2}{1^3} > 0 \Rightarrow$ local minimum when $x = 1$.
30. Let $S(x) = \frac{1}{x} + 4x^2$, $x > 0 \Rightarrow S'(x) = -\frac{1}{x^2} + 8x = \frac{8x^3-1}{x^2}$. $S'(x) = 0 \Rightarrow \frac{8x^3-1}{x^2} = 0 \Rightarrow 8x^3 - 1 = 0 \Rightarrow x = \frac{1}{2}$. $S''(x) = \frac{2}{x^3} + 8 \Rightarrow S''\left(\frac{1}{2}\right) = \frac{2}{(1/2)^3} + 8 > 0 \Rightarrow$ local minimum when $x = \frac{1}{2}$.
31. The length of the wire b = perimeter of the triangle + circumference of the circle. Let x = length of a side of the equilateral triangle $\Rightarrow P = 3x$, and let r = radius of the circle $\Rightarrow C = 2\pi r$. Thus $b = 3x + 2\pi r \Rightarrow r = \frac{b-3x}{2\pi}$. The area of the circle is πr^2 and the area of an equilateral triangle whose sides are x is $\frac{1}{2}(x)\left(\frac{\sqrt{3}}{2}x\right) = \frac{\sqrt{3}}{4}x^2$. Thus, the total area is given by $A = \frac{\sqrt{3}}{4}x^2 + \pi r^2 = \frac{\sqrt{3}}{4}x^2 + \pi\left(\frac{b-3x}{2\pi}\right)^2 = \frac{\sqrt{3}}{4}x^2 + \frac{(b-3x)^2}{4\pi}$. $\Rightarrow A' = \frac{\sqrt{3}}{2}x - \frac{3}{2\pi}(b-3x) = \frac{\sqrt{3}}{2}x - \frac{3b}{2\pi} + \frac{9}{2\pi}x$. $A' = 0 \Rightarrow \frac{\sqrt{3}}{2}x - \frac{3b}{2\pi} + \frac{9}{2\pi}x = 0 \Rightarrow x = \frac{3b}{\sqrt{3}\pi+9}$. $A'' = \frac{\sqrt{3}}{2} + \frac{9}{2\pi} > 0 \Rightarrow$ local minimum at the critical point. $P = 3\left(\frac{3b}{\sqrt{3}\pi+9}\right) = \frac{9b}{\sqrt{3}\pi+9}$ m is the length of the triangular segment and $C = 2\pi\left(\frac{b-3x}{2\pi}\right) = b - 3x = b - \frac{9b}{\sqrt{3}\pi+9} = \frac{\sqrt{3}\pi b}{\sqrt{3}\pi+9}$ m is the length of the circular segment.
32. The length of the wire b = perimeter of the triangle + circumference of the circle. Let x = length of a side of the square $\Rightarrow P = 4x$, and let r = radius of the circle $\Rightarrow C = 2\pi r$. Thus $b = 4x + 2\pi r \Rightarrow r = \frac{b-4x}{2\pi}$. The area of the circle is πr^2 and the area of a square whose sides are x is x^2 . Thus, the total area is given by $A = x^2 + \pi r^2 = x^2 + \pi\left(\frac{b-4x}{2\pi}\right)^2 = x^2 + \frac{(b-4x)^2}{4\pi} \Rightarrow A' = 2x - \frac{4}{2\pi}(b-4x) = 2x - \frac{2b}{\pi} + \frac{8}{\pi}x$, $A' = 0 \Rightarrow 2x - \frac{2b}{\pi} + \frac{8}{\pi}x = 0 \Rightarrow x = \frac{b}{4+\pi}$. $A'' = 2 + \frac{8}{\pi} > 0 \Rightarrow$ local minimum at the critical point. $P = 4\left(\frac{b}{4+\pi}\right) = \frac{4b}{4+\pi}$ m is the length of the square segment and $C = 2\pi\left(\frac{b-4x}{2\pi}\right) = b - 4x = b - \frac{4b}{4+\pi} = \frac{b\pi}{4+\pi}$ m is the length of the circular segment.

33. Let $(x, y) = \left(x, \frac{4}{3}x\right)$ be the coordinates of the corner that intersects the line. Then base $= 3 - x$ and height $= y = \frac{4}{3}x$, thus the area of the rectangle is given by $A = (3 - x)\left(\frac{4}{3}x\right) = 4x - \frac{4}{3}x^2$, $0 \leq x \leq 3$. $A' = 4 - \frac{8}{3}x$, $A' = 0 \Rightarrow x = \frac{3}{2}$. $A'' = -\frac{8}{3} \Rightarrow A''\left(\frac{3}{2}\right) < 0 \Rightarrow$ local maximum at the critical point. The base $= 3 - \frac{3}{2} = \frac{3}{2}$ and the height $= \frac{4}{3}\left(\frac{3}{2}\right) = 2$.
34. Let $(x, y) = \left(x, \sqrt{9 - x^2}\right)$ be the coordinates of the corner that intersects the semicircle. Then base $= 2x$ and height $= y = \sqrt{9 - x^2}$, thus the area of the inscribed rectangle is given by $A = (2x)\sqrt{9 - x^2}$, $0 \leq x \leq 3$. Then $A' = 2\sqrt{9 - x^2} + (2x)\frac{-x}{\sqrt{9 - x^2}} = \frac{2(9 - x^2) - 2x^2}{\sqrt{9 - x^2}} = \frac{18 - 4x^2}{\sqrt{9 - x^2}}$, $A' = 0 \Rightarrow 18 - 4x^2 = 0 \Rightarrow x = \pm \frac{3\sqrt{2}}{2}$, only $x = \frac{3\sqrt{2}}{2}$ lies in $0 \leq x \leq 3$. A is continuous on the closed interval $0 \leq x \leq 3 \Rightarrow A$ has an absolute maxima and absolute minima. $A(0) = 0$, $A(3) = 0$, and $A\left(\frac{3\sqrt{2}}{2}\right) = \left(3\sqrt{2}\right)\left(\frac{3\sqrt{2}}{2}\right) = 9 \Rightarrow$ absolute maxima. Base of rectangle is $3\sqrt{2}$ and height is $\frac{3\sqrt{2}}{2}$.
35. (a) $f(x) = x^2 + \frac{a}{x} \Rightarrow f'(x) = x^{-2}(2x^3 - a)$, so that $f'(x) = 0$ when $x = 2$ implies $a = 16$
 (b) $f(x) = x^2 + \frac{a}{x} \Rightarrow f''(x) = 2x^{-3}(x^3 + a)$, so that $f''(x) = 0$ when $x = 1$ implies $a = -1$
36. If $f(x) = x^3 + ax^2 + bx$, then $f'(x) = 3x^2 + 2ax + b$ and $f''(x) = 6x + 2a$.
 (a) A local maximum at $x = -1$ and local minimum at $x = 3 \Rightarrow f'(-1) = 0$ and $f'(3) = 0 \Rightarrow 3 - 2a + b = 0$ and $27 + 6a + b = 0 \Rightarrow a = -3$ and $b = -9$.
 (b) A local minimum at $x = 4$ and a point inflection at $x = 1 \Rightarrow f'(4) = 0$ and $f''(1) = 0 \Rightarrow 48 + 8a + b = 0$ and $6 + 2a = 0 \Rightarrow a = -3$ and $b = -24$.
37. (a) $s(t) = -16t^2 + 96t + 112 \Rightarrow v(t) = s'(t) = -32t + 96$. At $t = 0$, the velocity is $v(0) = 96$ ft/sec.
 (b) The maximum height occurs when $v(t) = 0$, when $t = 3$. The maximum height is $s(3) = 256$ ft and it occurs at $t = 3$ sec.
 (c) Note that $s(t) = -16t^2 + 96t + 112 = -16(t + 1)(t - 7)$, so $s = 0$ at $t = -1$ or $t = 7$. Choosing the positive value of t , the velocity when $s = 0$ is $v(7) = -128$ ft/sec.

38.

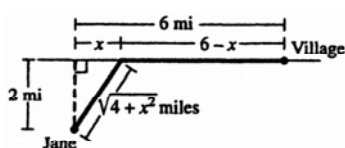

Let x be the distance from the point on the shoreline nearest Jane's boat to the point where she lands her boat. Then she needs to row $\sqrt{4 + x^2}$ mi at 2 mph and walk $6 - x$ mi at 5 mph. The total amount of time to reach the village is $f(x) = \frac{\sqrt{4 + x^2}}{2} + \frac{6 - x}{5}$ hours ($0 \leq x \leq 6$). Then $f'(x) = \frac{1}{2} \frac{1}{\sqrt{4 + x^2}}(2x) - \frac{1}{5} = \frac{x}{2\sqrt{4 + x^2}} - \frac{1}{5}$. Solving $f'(x) = 0$, we have: $\frac{x}{2\sqrt{4 + x^2}} = \frac{1}{5} \Rightarrow 5x = 2\sqrt{4 + x^2} \Rightarrow 25x^2 = 4(4 + x^2) \Rightarrow 21x^2 = 16 \Rightarrow x = \pm \frac{4}{\sqrt{21}}$. We discard the negative value of x because it is not in the domain. Checking the endpoints and critical point, we have $f(0) = 2.2$, $f\left(\frac{4}{\sqrt{21}}\right) \approx 2.12$, and $f(6) \approx 3.16$. Jane should land her boat $\frac{4}{\sqrt{21}} \approx 0.87$ miles down the shoreline from the point nearest her boat.

39. $\frac{8}{x} = \frac{h}{x+27} \Rightarrow h = 8 + \frac{216}{x}$ and $L(x) = \sqrt{h^2 + (x+27)^2}$
 $= \sqrt{\left(8 + \frac{216}{x}\right)^2 + (x+27)^2}$ when $x \geq 0$. Note that $L(x)$
 is minimized when $f(x) = \left(8 + \frac{216}{x}\right)^2 + (x+27)^2$ is
 minimized. If $f'(x) = 0$, then
 $2\left(8 + \frac{216}{x}\right)\left(-\frac{216}{x^2}\right) + 2(x+27) = 0$
 $\Rightarrow (x+27)\left(1 - \frac{1728}{x^3}\right) = 0 \Rightarrow x = -27$ (not acceptable
 since distance is never negative) or $x = 12$. Then
 $L(12) = \sqrt{2197} \approx 46.87$ ft.

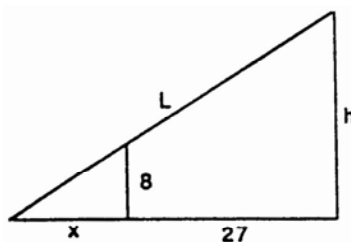

40. (a) $s_1 = s_2 \Rightarrow \sin t = \sin\left(t + \frac{\pi}{3}\right) \Rightarrow \sin t = \sin t \cos \frac{\pi}{3} + \sin \frac{\pi}{3} \cos t \Rightarrow \sin t = \frac{1}{2} \sin t + \frac{\sqrt{3}}{2} \cos t \Rightarrow \tan t = \sqrt{3}$
 $\Rightarrow t = \frac{\pi}{3}$ or $\frac{4\pi}{3}$

(b) The distance between the particles is $s(t) = |s_1 - s_2| = \left| \sin t - \sin\left(t + \frac{\pi}{3}\right) \right| = \frac{1}{2} \left| \sin t - \sqrt{3} \cos t \right|$
 $\Rightarrow s'(t) = \frac{(\sin t - \sqrt{3} \cos t)(\cos t + \sqrt{3} \sin t)}{2|\sin t - \sqrt{3} \cos t|}$ since $\frac{d}{dx} |x| = \frac{x}{|x|} \Rightarrow$ critical times and endpoints are
 $0, \frac{\pi}{3}, \frac{5\pi}{6}, \frac{4\pi}{3}, \frac{11\pi}{6}, 2\pi$; then $s(0) = \frac{\sqrt{3}}{2}, s\left(\frac{\pi}{3}\right) = 0, s\left(\frac{5\pi}{6}\right) = 1, s\left(\frac{4\pi}{3}\right) = 0, s\left(\frac{11\pi}{6}\right) = 1, s(2\pi) = \frac{\sqrt{3}}{2} \Rightarrow$ the
 greatest distance between the particles is 1.

(c) Since $s'(t) = \frac{(\sin t - \sqrt{3} \cos t)(\cos t + \sqrt{3} \sin t)}{2|\sin t - \sqrt{3} \cos t|}$ we can conclude that at $t = \frac{\pi}{3}$ and $\frac{4\pi}{3}, s'(t)$ has cusps and the
 distance between the particles is changing the fastest near these points.

41. $I = \frac{k}{d^2}$, let $x =$ distance the point is from the stronger light source $\Rightarrow 6 - x =$ distance the point is from the other
 light source. The intensity of illumination at the point from the stronger light is $I_1 = \frac{k_1}{x^2}$, and intensity of
 illumination at the point from the weaker light is $I_2 = \frac{k_2}{(6-x)^2}$. Since the intensity of the first light is eight times
 the intensity of the second light $\Rightarrow k_1 = 8k_2 \Rightarrow I_1 = \frac{8k_2}{x^2}$. The total intensity is given by $I = I_1 + I_2 = \frac{8k_2}{x^2} + \frac{k_2}{(6-x)^2}$
 $\Rightarrow I' = -\frac{16k_2}{x^3} + \frac{2k_2}{(6-x)^3} = \frac{-16(6-x)^3 k_2 + 2x^3 k_2}{x^3(6-x)^3}$ and $I' = 0 \Rightarrow \frac{-16(6-x)^3 k_2 + 2x^3 k_2}{x^3(6-x)^3} = 0 \Rightarrow -16(6-x)^3 k_2 + 2x^3 k_2 = 0$
 $\Rightarrow x = 4$ m. $I'' = \frac{48k_2}{x^4} + \frac{6k_2}{(6-x)^4} \Rightarrow I''(4) = \frac{48k_2}{4^4} + \frac{6k_2}{(6-4)^4} > 0 \Rightarrow$ local minimum. The point should be 4 m from the
 stronger light source.

42. $R = \frac{v_0^2}{g} \sin 2\alpha \Rightarrow \frac{dR}{d\alpha} = \frac{2v_0^2}{g} \cos 2\alpha$ and $\frac{dR}{d\alpha} = 0 \Rightarrow \frac{2v_0^2}{g} \cos 2\alpha = 0 \Rightarrow \alpha = \frac{\pi}{4} \cdot \frac{d^2 R}{d\alpha^2} = -\frac{4v_0^2}{g} \sin 2\alpha$
 $\Rightarrow \frac{d^2 R}{d\alpha^2} \Big|_{\alpha=\frac{\pi}{4}} = -\frac{4v_0^2}{g} \sin 2\left(\frac{\pi}{4}\right) = -\frac{4v_0^2}{g} < 0 \Rightarrow$ local maximum. Thus, the firing angle of $\alpha = \frac{\pi}{4} = 45^\circ$
 will maximize the range R .

43. (a) From the diagram we have $d^2 = 4r^2 - w^2$. The strength of the beam is $S = kw d^2 = kw(4r^2 - w^2)$.
 When $r = 6$, then $S = 144kw - kw^3$. Also, $S'(w) = 144k - 3kw^2 = 3k(48 - w^2)$ so $S'(w) = 0 \Rightarrow w = \pm 4\sqrt{3}$;
 $S''(4\sqrt{3}) < 0$ and $-4\sqrt{3}$ is not acceptable. Therefore $S(4\sqrt{3})$ is the maximum strength. The dimensions of
 the strongest beam are $4\sqrt{3}$ by $4\sqrt{6}$ inches.

(b)

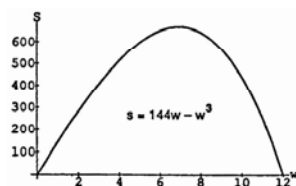

(c)

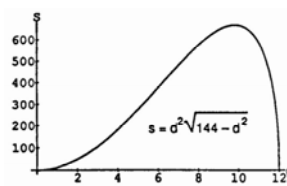

Both graphs indicate the same maximum value and are consistent with each other. Changing k does not change the dimensions that give the strongest beam (i.e., do not change the values of w and d that produce the strongest beam).

44. (a) From the situation we have $w^2 = 144 - d^2$. The stiffness of the beam is $S = kwd^3 = kd^3(144 - d^2)^{1/2}$, where $0 \leq d \leq 12$. Also, $S'(d) = \frac{4kd^2(108 - d^2)}{\sqrt{144 - d^2}} \Rightarrow$ critical points at 0, 12, and $6\sqrt{3}$. Both $d = 0$ and $d = 12$ cause $S = 0$. The maximum occurs at $d = 6\sqrt{3}$. The dimensions are 6 by $6\sqrt{3}$ inches.

(b)

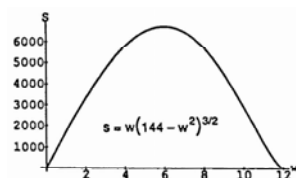

(c)

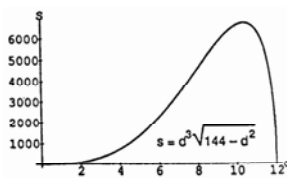

Both graphs indicate the same maximum value and are consistent with each other. The changing of k has no effect.

45. (a) $s = 10 \cos(\pi t) \Rightarrow v = -10\pi \sin(\pi t) \Rightarrow \text{speed} = |10\pi \sin(\pi t)| = 10\pi |\sin(\pi t)| \Rightarrow$ the maximum speed is $10\pi \approx 31.42$ cm/sec since the maximum value of $|\sin(\pi t)|$ is 1; the cart is moving the fastest at $t = 0.5$ sec, 1.5 sec, 2.5 sec and 3.5 sec when $|\sin(\pi t)|$ is 1. At these times the distance is $s = 10 \cos\left(\frac{\pi}{2}\right) = 0$ cm and $a = -10\pi^2 \cos(\pi t) \Rightarrow |a| = 10\pi^2 |\cos(\pi t)| \Rightarrow |a| = 0$ cm/sec²
- (b) $|a| = 10\pi^2 |\cos(\pi t)|$ is greatest at $t = 0.0$ sec, 1.0 sec, 2.0 sec, 3.0 sec, and 4.0 sec, and at these times the magnitude of the cart's position is $|s| = 10$ cm from the rest position and the speed is 0 cm/sec.

46. (a) $2 \sin t = \sin 2t \Rightarrow 2 \sin t - 2 \sin t \cos t = 0 \Rightarrow (2 \sin t)(1 - \cos t) = 0 \Rightarrow t = k\pi$ where k is a positive integer

- (b) The vertical distance between the masses is $s(t) = |s_1 - s_2| = \left((s_1 - s_2)^2\right)^{1/2} = \left((\sin 2t - 2 \sin t)^2\right)^{1/2}$
 $\Rightarrow s'(t) = \left(\frac{1}{2}\right) \left((\sin 2t - 2 \sin t)^2\right)^{-1/2} (2)(\sin 2t - 2 \sin t)(2 \cos 2t - 2 \cos t) = \frac{2(\cos 2t - 2 \cos t)(\sin 2t - 2 \sin t)}{|\sin 2t - 2 \sin t|}$
 $= \frac{4(2 \cos t + 1)(\cos t - 1)(\sin t)(\cos t - 1)}{|\sin 2t - 2 \sin t|} \Rightarrow$ critical times at $0, \frac{2\pi}{3}, \pi, \frac{4\pi}{3}, 2\pi$; then $s(0) = 0$,
 $s\left(\frac{2\pi}{3}\right) = \left|\sin\left(\frac{4\pi}{3}\right) - 2 \sin\left(\frac{2\pi}{3}\right)\right| = \frac{3\sqrt{3}}{2}$, $s(\pi) = 0$, $s\left(\frac{4\pi}{3}\right) = \left|\sin\left(\frac{8\pi}{3}\right) - 2 \sin\left(\frac{4\pi}{3}\right)\right| = \frac{3\sqrt{3}}{2}$, $s(2\pi) = 0$
 \Rightarrow the greatest distance is $\frac{3\sqrt{3}}{2}$ at $t = \frac{2\pi}{3}$ and $\frac{4\pi}{3}$

47. (a) $s = \sqrt{(12 - 12t)^2 + (8t)^2} = \left((12 - 12t)^2 + 64t^2\right)^{1/2}$

- (b) $\frac{ds}{dt} = \frac{1}{2} \left((12 - 12t)^2 + 64t^2\right)^{-1/2} [2(12 - 12t)(-12) + 128t] = \frac{208t - 144}{\sqrt{(12 - 12t)^2 + 64t^2}} \Rightarrow \frac{ds}{dt}\Big|_{t=0} = -12$ knots and
 $\frac{ds}{dt}\Big|_{t=1} = 8$ knots

- (c) The graph indicates that the ships did not see each other because $s(t) > 5$ for all values of t .

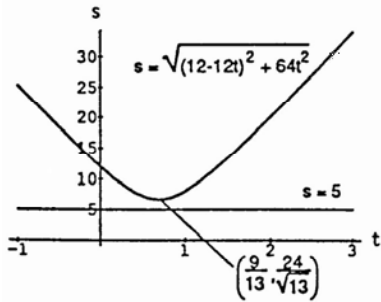

- (d) The graph supports the conclusions in parts (b) and (c).

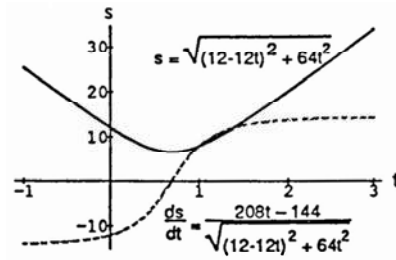

- (e) $\lim_{t \rightarrow \infty} \frac{ds}{dt} = \sqrt{\lim_{t \rightarrow \infty} \frac{(208t-144)^2}{144(1-t)^2 + 64t^2}} = \sqrt{\lim_{t \rightarrow \infty} \frac{(208 - \frac{144}{t})^2}{144(\frac{1}{t}-1)^2 + 64}} = \sqrt{\frac{208^2}{144+64}} = \sqrt{208} = 4\sqrt{13}$ which equals the square root of the sums of the squares of the individual speeds.

48. The distance $OT + TB$ is minimized when \overline{OB} is a straight line. Hence $\angle \alpha = \angle \beta \Rightarrow \theta_1 = \theta_2$.

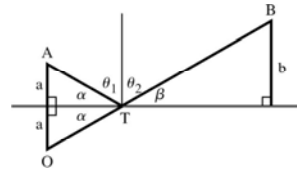

49. If $v = kax - kx^2$, then $v' = ka - 2kx$ and $v'' = -2k$, so $v' = 0 \Rightarrow x = \frac{a}{2}$. At $x = \frac{a}{2}$ there is a maximum since $v''(\frac{a}{2}) = -2k < 0$. The maximum value of v is $\frac{ka^2}{4}$.

50. (a) According to the graph, $y'(0) = 0$.
 (b) According to the graph, $y'(-L) = 0$.
 (c) $y(0) = 0$, so $d = 0$. Now $y'(x) = 3ax^2 + 2bx + c$, so $y'(0) = 0$ implies that $c = 0$. Therefore, $y'(x) = ax^3 + bx^2$ and $y'(x) = 3ax^2 + 2bx$. then $y(-L) = -aL^3 + bL^2 = H$ and $y'(-L) = 3aL^2 + 2bL = 0$, so we have two linear equations in two unknowns a and b . The second equation gives $b = \frac{3aL}{2}$. Substituting into the first equation, we have $-aL^3 + \frac{3aL^3}{2} = H$, or $\frac{aL^3}{2} = H$, so $a = 2\frac{H}{L^3}$. Therefore, $b = 3\frac{H}{L^2}$ and the equation for y is $y(x) = 2\frac{H}{L^3}x^3 + 3\frac{H}{L^2}x^2$, or $y(x) = H\left[2\left(\frac{x}{L}\right)^3 + 3\left(\frac{x}{L}\right)^2\right]$.

51. The profit is $p = nx - nc = n(x - c) = [a(x - c)^{-1} + b(100 - x)](x - c) = a + b(100 - x)(x - c)$
 $= a + (bc + 100b)x - 100bc - bx^2$. Then $p'(x) = bc + 100b - 2bx$ and $p''(x) = -2b$. Solving $p'(x) = 0 \Rightarrow x = \frac{c}{2} + 50$. At $x = \frac{c}{2} + 50$ there is a maximum profit since $p''(x) = -2b < 0$ for all x .

52. Let x represent the number of people over 50. The profit is $p(x) = (50 + x)(200 - 2x) - 32(50 + x) - 6000$
 $= -2x^2 + 68x + 2400$. Then $p'(x) = -4x + 68$ and $p'' = -4$. Solving $p'(x) = 0 \Rightarrow x = 17$. At $x = 17$ there is a maximum since $p''(17) < 0$. It would take 67 people to maximize the profit.

53. (a) $A(q) = kmq^{-1} + cm + \frac{h}{2}q$, where $q > 0 \Rightarrow A'(q) = -kmq^{-2} + \frac{h}{2} = \frac{hq^2 - 2km}{2q^2}$ and $A''(q) = 2kmq^{-3}$. The critical points are $-\sqrt{\frac{2km}{h}}$, 0, and $\sqrt{\frac{2km}{h}}$, but only $\sqrt{\frac{2km}{h}}$ is in the domain. Then $A''\left(\sqrt{\frac{2km}{h}}\right) > 0 \Rightarrow$ at $q = \sqrt{\frac{2km}{h}}$ there is a minimum average weekly cost.
- (b) $A(q) = \frac{(k+bq)m}{q} + cm + \frac{h}{2}q = kmq^{-1} + bm + cm + \frac{h}{2}q$, where $q > 0 \Rightarrow A'(q) = 0$ at $q = \sqrt{\frac{2km}{h}}$ as in (a). Also $A''(q) = 2kmq^{-3} > 0$ so the most economical quantity to order is still $q = \sqrt{\frac{2km}{h}}$ which minimizes the average weekly cost.
54. We start with $c(x)$ = the cost of producing x items, $x > 0$, and $\frac{c(x)}{x}$ = the average cost of producing x items, assumed to be differentiable. If the average cost can be minimized, it will be at a production level at which $\frac{d}{dx}\left(\frac{c(x)}{x}\right) = 0 \Rightarrow \frac{xc'(x) - c(x)}{x^2} = 0$ (by the quotient rule) $\Rightarrow xc'(x) - c(x) = 0$ (multiply both sides by x^2) $\Rightarrow c'(x) = \frac{c(x)}{x}$ where $c'(x)$ is the marginal cost. This concludes the proof. (Note: The theorem does not assure a production level that will give a minimum cost, but rather, it indicates where to look to see if there is one. Find the production levels where the average cost equals the marginal cost, then check to see if any of them give a minimum.)
55. The profit $p(x) = r(x) - c(x) = 6x - (x^3 - 6x^2 + 15x) = -x^3 + 6x^2 - 9x$, where $x \geq 0$. Then $p'(x) = -3x^2 + 12x - 9 = -3(x-3)(x-1)$ and $p''(x) = -6x + 12$. The critical points are 1 and 3. Thus $p''(1) = 6 > 0 \Rightarrow$ at $x = 1$ there is a local minimum, and $p''(3) = -6 < 0 \Rightarrow$ at $x = 3$ there is a local maximum. But $p(3) = 0 \Rightarrow$ the best you can do is break even.
56. The average cost of producing x items is $\bar{c}(x) = \frac{c(x)}{x} = x^2 - 20x + 20,000 \Rightarrow \bar{c}'(x) = 2x - 20 = 0 \Rightarrow x = 10$, the only critical value. The average cost is $\bar{c}(10) = \$19,900$ per item is a minimum cost because $\bar{c}''(10) = 2 > 0$.
57. Let x = the length of a side of the square base of the box and h = the height of the box. $V = x^2h = 48 \Rightarrow h = \frac{48}{x^2}$. The total cost is given by $C = 6 \cdot x^2 + 4(4 \cdot xh) = 6x^2 + 16x\left(\frac{48}{x^2}\right) = 6x^2 + \frac{768}{x}$, $x > 0 \Rightarrow C' = 12x - \frac{768}{x^2} = \frac{12x^3 - 768}{x^2}$. $C' = 0 \Rightarrow \frac{12x^3 - 768}{x^2} = 0 \Rightarrow 12x^3 - 768 = 0 \Rightarrow x = 4$; $C'' = 12 + \frac{1536}{x^3} \Rightarrow C''(4) = 12 + \frac{1536}{4^3} > 0 \Rightarrow$ local minimum. $x = 4 \Rightarrow h = \frac{48}{4^2} = 3$ and $C(4) = 6(4)^2 + \frac{768}{4} = 288 \Rightarrow$ the box is 4 ft \times 4 ft \times 3 ft, with a minimum cost of \$288.
58. Let x = the number of \$10 increases in the charge per room, then price per room = $50 + 10x$, and the number of rooms filled each night = $800 - 40x \Rightarrow$ the total revenue is $R(x) = (50 + 10x)(800 - 40x)$
 $= -400x^2 + 6000x + 40000$, $0 \leq x \leq 20 \Rightarrow R'(x) = -800x + 6000$; $R'(x) = 0 \Rightarrow -800x + 6000 = 0$
 $\Rightarrow x = \frac{15}{2}$; $R''(x) = -800 \Rightarrow R''\left(\frac{15}{2}\right) = -800 < 0 \Rightarrow$ local maximum. The price per room is $50 + 10\left(\frac{15}{2}\right) = \125 .
59. We have $\frac{dR}{dM} = CM - M^2$. Solving $\frac{d^2R}{dM^2} = C - 2M = 0 \Rightarrow M = \frac{C}{2}$. Also, $\frac{d^3R}{dM^3} = -2 < 0 \Rightarrow$ at $M = \frac{C}{2}$ there is a maximum.

60. (a) If $v = cr_0r^2 - cr^3$, then $v' = 2cr_0r - 3cr^2 = cr(2r_0 - 3r)$ and $v'' = 2cr_0 - 6cr = 2c(r_0 - 3r)$. The solution of $v' = 0$ is $r = 0$ or $\frac{2r_0}{3}$, but 0 is not in the domain. Also, $v' > 0$ for $r < \frac{2r_0}{3}$ and $v' < 0$ for $r > \frac{2r_0}{3} \Rightarrow$ at $r = \frac{2r_0}{3}$ there is a maximum.

- (b) The graph confirms the findings in (a).

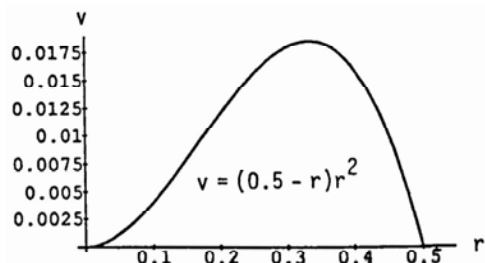

61. If $x > 0$, then $(x-1)^2 \geq 0 \Rightarrow x^2 + 1 \geq 2x \Rightarrow \frac{x^2+1}{x} \geq 2$. In particular if a, b, c and d are positive integers, then $\left(\frac{a^2+1}{a}\right)\left(\frac{b^2+1}{b}\right)\left(\frac{c^2+1}{c}\right)\left(\frac{d^2+1}{d}\right) \geq 16$.

62. (a) $f(x) = \frac{x}{\sqrt{a^2+x^2}} \Rightarrow f'(x) = \frac{(a^2+x^2)^{1/2} - x^2(a^2+x^2)^{-1/2}}{(a^2+x^2)} = \frac{a^2+x^2-x^2}{(a^2+x^2)^{3/2}} = \frac{a^2}{(a^2+x^2)^{3/2}} > 0 \Rightarrow f(x)$ is an increasing function of x

(b) $g(x) = \frac{d-x}{\sqrt{b^2+(d-x)^2}} \Rightarrow g'(x) = \frac{-(b^2+(d-x)^2)^{1/2} + (d-x)^2(b^2+(d-x)^2)^{-1/2}}{b^2+(d-x)^2} = \frac{-(b^2+(d-x)^2) + (d-x)^2}{(b^2+(d-x)^2)^{3/2}}$
 $= \frac{-b^2}{(b^2+(d-x)^2)^{3/2}} < 0 \Rightarrow g(x)$ is a decreasing function of x

- (c) Since $c_1, c_2 > 0$, the derivative $\frac{dt}{dx}$ is an increasing function of x (from part (a)) minus a decreasing function of x (from part (b)): $\frac{dt}{dx} = \frac{1}{c_1} f(x) - \frac{1}{c_2} g(x) \Rightarrow \frac{d^2t}{dx^2} = \frac{1}{c_1} f'(x) - \frac{1}{c_2} g'(x) > 0$ since $f'(x) > 0$ and $g'(x) < 0 \Rightarrow \frac{dt}{dx}$ is an increasing function of x .

63. At $x = c$, the tangents to the curves are parallel. Justification: The vertical distance between the curves is $D(x) = f(x) - g(x)$, so $D'(x) = f'(x) - g'(x)$. The maximum value of D will occur at a point c where $D' = 0$. At such a point, $f'(c) - g'(c) = 0$, or $f'(c) = g'(c)$.

64. (a) $f(x) = 3 + 4 \cos x + \cos 2x$ is a periodic function with period 2π
 (b) No, $f(x) = 3 + 4 \cos x + \cos 2x = 3 + 4 \cos x + (2 \cos^2 x - 1) = 2(1 + 2 \cos x + \cos^2 x) = 2(1 + \cos x)^2 \geq 0 \Rightarrow f(x)$ is never negative.

65. (a) If $y = \cot x - \sqrt{2} \csc x$ where $0 < x < \pi$, then $y' = (\csc x)(\sqrt{2} \cot x - \csc x)$. Solving $y' = 0 \Rightarrow \cos x = \frac{1}{\sqrt{2}} \Rightarrow x = \frac{\pi}{4}$. For $0 < x < \frac{\pi}{4}$ we have $y' > 0$ and $y' < 0$ when $\frac{\pi}{4} < x < \pi$. Therefore, at $x = \frac{\pi}{4}$ there is a maximum value of $y = -1$.

(b)

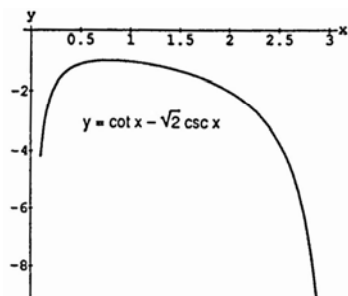

The graph confirms the findings in (a).

66. (a) If $y = \tan x + 3 \cot x$ where $0 < x < \frac{\pi}{2}$, then $y' = \sec^2 x - 3 \csc^2 x$. Solving $y' = 0 \Rightarrow \tan x = \pm\sqrt{3} \Rightarrow x = \pm\frac{\pi}{3}$, but $-\frac{\pi}{3}$ is not in the domain. Also, $y'' = 2 \sec^2 x \tan x + 6 \csc^2 x \cot x > 0$ for all $0 < x < \frac{\pi}{2}$. Therefore at $x = \frac{\pi}{3}$ there is a minimum value of $y = 2\sqrt{3}$.

(b)

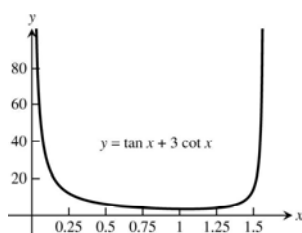

The graph confirms the findings in (a).

67. (a) The square of the distance is $D(x) = \left(x - \frac{3}{2}\right)^2 + (\sqrt{x} + 0)^2 = x^2 - 2x + \frac{9}{4}$, so $D'(x) = 2x - 2$ and the critical point occurs at $x = 1$. Since $D'(x) < 0$ for $x < 1$ and $D'(x) > 0$ for $x > 1$, the critical point corresponds to the minimum distance. The minimum distance is $\sqrt{D(1)} = \frac{\sqrt{5}}{2}$.

(b)

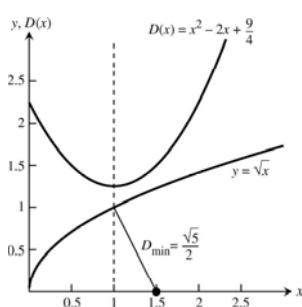

The minimum distance is from the point $\left(\frac{3}{2}, 0\right)$ to the point $(1, 1)$ on the graph of $y = \sqrt{x}$, and this occurs at the value $x = 1$ where $D(x)$, the distance squared, has its minimum value.

68. (a) Calculus Method:

The square of the distance from the point $(1, \sqrt{3})$ to $(x, \sqrt{16-x^2})$ is given by

$$D(x) = (x-1)^2 + (\sqrt{16-x^2} - \sqrt{3})^2 = x^2 - 2x + 1 + 16 - x^2 - 2\sqrt{48-3x^2} + 3 = -2x + 20 - 2\sqrt{48-3x^2}.$$

Then $D'(x) = -2 - \frac{1}{2} \cdot \frac{2}{\sqrt{48-3x^2}}(-6x) = -2 + \frac{6x}{\sqrt{48-3x^2}}$. Solving $D'(x) = 0$ we have:

$6x = 2\sqrt{48-3x^2} \Rightarrow 36x^2 = 4(48-3x^2) \Rightarrow 9x^2 = 48-3x^2 \Rightarrow 12x^2 = 48 \Rightarrow x = \pm 2$ We discard $x = -2$ as an extraneous solution, leaving $x = 2$. Since $D'(x) < 0$ for $-4 < x < 2$ and $D'(x) > 0$ for $2 < x < 4$, the critical point corresponds to the minimum distance. The minimum distance is $\sqrt{D(2)} = 2$.

Geometry Method:

The semicircle is centered at the origin and has radius 4. The distance from the origin to $(1, \sqrt{3})$ is

$\sqrt{1^2 + (\sqrt{3})^2} = 2$. The shortest distance from the point to the semicircle is the distance along the radius containing the point $(1, \sqrt{3})$. That distance is $4 - 2 = 2$.

(b)

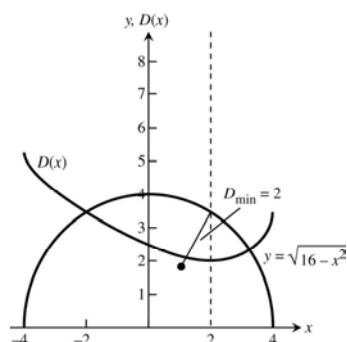

The minimum distance is from the point $(1, \sqrt{3})$ to the point $(2, 2\sqrt{3})$ on the graph of $y = \sqrt{16-x^2}$, and this occurs at the value $x = 2$ where $D(x)$, the distance squared, has its minimum value.

4.7 NEWTON'S METHOD

- $y = x^2 + x - 1 \Rightarrow y' = 2x + 1 \Rightarrow x_{n+1} = x_n - \frac{x_n^2 + x_n - 1}{2x_n + 1}; x_0 = 1 \Rightarrow x_1 = 1 - \frac{1+1-1}{2+1} = \frac{2}{3} \Rightarrow x_2 = \frac{2}{3} - \frac{\frac{4}{9} + \frac{2}{3} - 1}{\frac{4}{3} + 1}$
 $\Rightarrow x_2 = \frac{2}{3} - \frac{4+6-9}{12+9} = \frac{2}{3} - \frac{1}{21} = \frac{13}{21} \approx .61905; x_0 = -1 \Rightarrow x_1 = -1 - \frac{-1-1-1}{-2-1} = -2 \Rightarrow x_2 = -2 - \frac{4-2-1}{-4-1} = -\frac{5}{3} \approx -1.66667$
- $y = x^3 + 3x + 1 \Rightarrow y' = 3x^2 + 3 \Rightarrow x_{n+1} = x_n - \frac{x_n^3 + 3x_n + 1}{3x_n^2 + 3}; x_0 = 0 \Rightarrow x_1 = 0 - \frac{1}{3} = -\frac{1}{3} \Rightarrow x_2 = -\frac{1}{3} - \frac{-\frac{1}{27} - 1 + 1}{\frac{1}{3} + 3}$
 $= -\frac{1}{3} + \frac{1}{90} = -\frac{29}{90} \approx -0.32222$
- $y = x^4 + x - 3 \Rightarrow y' = 4x^3 + 1 \Rightarrow x_{n+1} = x_n - \frac{x_n^4 + x_n - 3}{4x_n^3 + 1}; x_0 = 1 \Rightarrow x_1 = 1 - \frac{1+1-3}{4+1} = \frac{6}{5} \Rightarrow x_2 = \frac{6}{5} - \frac{\frac{1296}{625} + \frac{6}{5} - 3}{\frac{864}{125} + 1}$
 $= \frac{6}{5} - \frac{1296+750-1875}{4320+625} = \frac{6}{5} - \frac{171}{4945} = \frac{5763}{4945} \approx 1.16542; x_0 = -1 \Rightarrow x_1 = -1 - \frac{-1-1-3}{-4-1} = -2 \Rightarrow x_2 = -2 - \frac{16-2-3}{-32-1}$
 $= -2 + \frac{11}{31} = -\frac{51}{31} \approx -1.64516$

4. $y = 2x - x^2 + 1 \Rightarrow y' = 2 - 2x \Rightarrow x_{n+1} = x_n - \frac{2x_n - x_n^2 + 1}{2 - 2x_n}$; $x_0 = 0 \Rightarrow x_1 = 0 - \frac{0 - 0 + 1}{2 - 0} = -\frac{1}{2} \Rightarrow x_2 = -\frac{1}{2} - \frac{-1 - \frac{1}{4} + 1}{2 + 1}$
 $= -\frac{1}{2} + \frac{1}{12} = -\frac{5}{12} \approx -.41667$; $x_0 = 2 \Rightarrow x_1 = 2 - \frac{4 - 4 + 1}{2 - 4} = \frac{5}{2} \Rightarrow x_2 = \frac{5}{2} - \frac{5 - \frac{25}{4} + 1}{2 - 5} = \frac{5}{2} - \frac{20 - 25 + 4}{-12} = \frac{5}{2} - \frac{1}{12}$
 $= \frac{29}{12} \approx 2.41667$

5. $y = x^4 - 2 \Rightarrow y' = 4x^3 \Rightarrow x_{n+1} = x_n - \frac{x_n^4 - 2}{4x_n^3}$; $x_0 = 1 \Rightarrow x_1 = 1 - \frac{1 - 2}{4} = \frac{5}{4} \Rightarrow x_2 = \frac{5}{4} - \frac{\frac{625}{16} - 2}{\frac{125}{16}} = \frac{5}{4} - \frac{625 - 512}{2000}$
 $= \frac{5}{4} - \frac{113}{2000} = \frac{2500 - 113}{2000} = \frac{2387}{2000} \approx 1.1935$

6. From Exercise 5, $x_{n+1} = x_n - \frac{x_n^4 - 2}{4x_n^3}$; $x_0 = -1 \Rightarrow x_1 = -1 - \frac{1 - 2}{-4} = -1 - \frac{1}{4} = -\frac{5}{4} \Rightarrow x_2 = -\frac{5}{4} - \frac{\frac{625}{64} - 2}{-\frac{125}{16}}$
 $= -\frac{5}{4} - \frac{625 - 512}{-2000} = -\frac{5}{4} + \frac{113}{2000} \approx -1.1935$

7. $f(x_0) = 0$ and $f'(x_0) \neq 0 \Rightarrow x_{n+1} = x_n - \frac{f(x_n)}{f'(x_n)}$ gives $x_1 = x_0 \Rightarrow x_2 = x_0 \Rightarrow x_n = x_0$ for all $n \geq 0$. That is all, of the approximations in Newton's method will be the root of $f(x) = 0$.

8. It does matter. If you start too far away from $x = \frac{\pi}{2}$, the calculated values may approach some other root. Starting with $x_0 = -0.5$, for instance, leads to $x = -\frac{\pi}{2}$ as the root, not $x = \frac{\pi}{2}$.

9. If $x_0 = h > 0 \Rightarrow x_1 = x_0 - \frac{f(x_0)}{f'(x_0)} = h - \frac{f(h)}{f'(h)}$
 $= h - \frac{\sqrt{h}}{\left(\frac{1}{2\sqrt{h}}\right)} = h - (\sqrt{h})(2\sqrt{h}) = -h$;

if $x_0 = -h < 0 \Rightarrow x_1 = x_0 - \frac{f(x_0)}{f'(x_0)} = -h - \frac{f(-h)}{f'(-h)}$
 $= -h - \frac{\sqrt{h}}{\left(\frac{-1}{2\sqrt{h}}\right)} = -h + (\sqrt{h})(2\sqrt{h}) = h$.

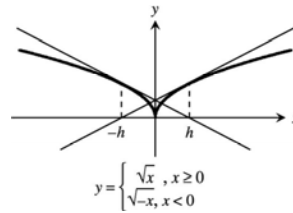

10. $f(x) = x^{1/3} \Rightarrow f'(x) = \left(\frac{1}{3}\right)x^{-2/3}$
 $\Rightarrow x_{n+1} = x_n - \frac{x_n^{1/3}}{\left(\frac{1}{3}\right)x_n^{-2/3}} = -2x_n$; $x_0 = 1$
 $\Rightarrow x_1 = -2, x_2 = 4, x_3 = -8, \text{ and } x_4 = 16$ and so forth. Since $|x_n| = 2|x_{n-1}|$ we may conclude that $n \rightarrow \infty \Rightarrow |x_n| \rightarrow \infty$.

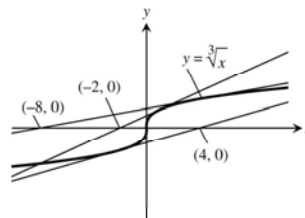

11. i) is equivalent to solving $x^3 - 3x - 1 = 0$.
 ii) is equivalent to solving $x^3 - 3x - 1 = 0$.
 iii) is equivalent to solving $x^3 - 3x - 1 = 0$.
 iv) is equivalent to solving $x^3 - 3x - 1 = 0$.
 All four equations are equivalent.

12. $f(x) = x - 1 - 0.5 \sin x \Rightarrow f'(x) = 1 - 0.5 \cos x \Rightarrow x_{n+1} = x_n - \frac{x_n - 1 - 0.5 \sin x_n}{1 - 0.5 \cos x_n}$; if $x_0 = 1.5$, then $x_1 = 1.49870$

13. $f(x) = \tan x - 2x \Rightarrow f'(x) = \sec^2 x - 2 \Rightarrow x_{n+1} = x_n - \frac{\tan(x_n) - 2x_n}{\sec^2(x_n)}$; $x_0 = 1 \Rightarrow x_1 = 1.2920445$
 $\Rightarrow x_2 = 1.155327774 \Rightarrow x_{16} = x_{17} = 1.165561185$

14. $f(x) = x^4 - 2x^3 - x^2 - 2x + 2 \Rightarrow f'(x) = 4x^3 - 6x^2 - 2x - 2 \Rightarrow x_{n+1} = x_n - \frac{x_n^4 - 2x_n^3 - x_n^2 - 2x_n + 2}{4x_n^3 - 6x_n^2 - 2x_n - 2}$; if $x_0 = 0.5$, then $x_4 = 0.630115396$; if $x_0 = 2.5$, then $x_4 = 2.57327196$

15. (a) The graph of $f(x) = \sin 3x - 0.99 + x^2$ in the window $-2 \leq x \leq 2, -2 \leq y \leq 3$ suggests three roots. However, when you zoom in on the x -axis near $x = 1.2$, you can see that the graph lies above the axis there. There are only two roots, one near $x = -1$, the other near $x = 0.4$.

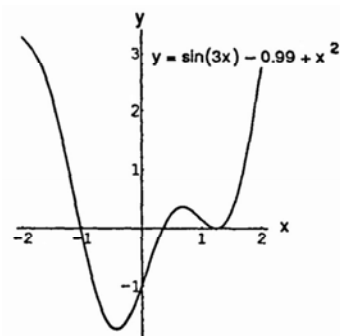

(b) $f(x) = \sin 3x - 0.99 + x^2$
 $\Rightarrow f'(x) = 3 \cos 3x + 2x$
 $\Rightarrow x_{n+1} = x_n - \frac{\sin(3x_n) - 0.99 + x_n^2}{3 \cos(3x_n) + 2x_n}$
 and the solutions are approximately 0.35003501505249 and -1.0261731615301

16. (a) Yes, three times as indicated by the graphs
 (b) $f(x) = \cos 3x - x \Rightarrow f'(x) = -3 \sin 3x - 1$
 $\Rightarrow x_{n+1} = x_n - \frac{\cos(3x_n) - x_n}{-3 \sin(3x_n) - 1}$; at approximately $-0.979367, -0.887726$, and 0.39004 we have $\cos 3x = x$

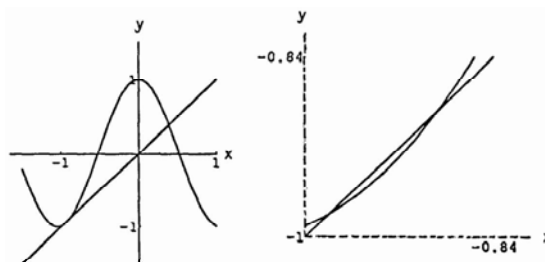

17. $f(x) = 2x^4 - 4x^2 + 1 \Rightarrow f'(x) = 8x^3 - 8x \Rightarrow x_{n+1} = x_n - \frac{2x_n^4 - 4x_n^2 + 1}{8x_n^3 - 8x_n}$; if $x_0 = -2$, then $x_6 = -1.30656296$; if $x_0 = -0.5$, then $x_3 = -0.5411961$; the roots are approximately ± 0.5411961 and ± 1.30656296 because $f(x)$ is an even function.

18. $f(x) = \tan x \Rightarrow f'(x) = \sec^2 x \Rightarrow x_{n+1} = x_n - \frac{\tan(x_n)}{\sec^2(x_n)}$; $x_0 = 3 \Rightarrow x_1 = 3.13971 \Rightarrow x_2 = 3.14159$ and we approximate π to be 3.14159.

19. From the graph we let $x_0 = 0.5$ and $f(x) = \cos x - 2x$
 $\Rightarrow x_{n+1} = x_n - \frac{\cos(x_n) - 2x_n}{-\sin(x_n) - 2} \Rightarrow x_1 = .45063$
 $\Rightarrow x_2 = .45018 \Rightarrow$ at $x \approx 0.45$ we have $\cos x = 2x$.

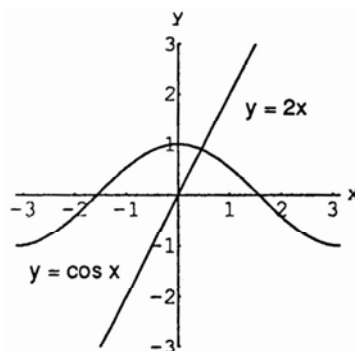

20. From the graph we let $x_0 = -0.7$ and
 $f(x) = \cos x + x \Rightarrow x_{n+1} = x_n - \frac{x_n + \cos(x_n)}{1 - \sin(x_n)}$
 $\Rightarrow x_1 = -0.73944 \Rightarrow x_2 = -0.73908 \Rightarrow$ at $x \approx -0.74$
 we have $\cos x = -x$.

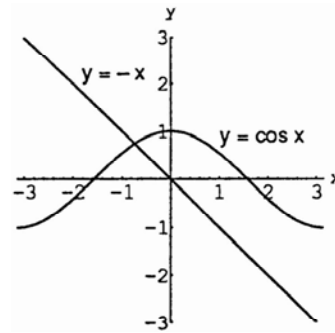

21. The x -coordinate of the point of intersection of $y = x^2(x+1)$ and $y = \frac{1}{x}$ is the solution of $x^2(x+1) = \frac{1}{x}$
 $\Rightarrow x^3 + x^2 - \frac{1}{x} = 0 \Rightarrow$ The x -coordinate is the root of $f(x) = x^3 + x^2 - \frac{1}{x} \Rightarrow f'(x) = 3x^2 + 2x + \frac{1}{x^2}$. Let $x_0 = 1$
 $\Rightarrow x_{n+1} = x_n - \frac{x_n^3 + x_n^2 - \frac{1}{x_n}}{3x_n^2 + 2x_n + \frac{1}{x_n^2}} \Rightarrow x_1 = 0.83333 \Rightarrow x_2 = 0.81924 \Rightarrow x_3 = 0.81917 \Rightarrow x_7 = 0.81917 \Rightarrow r \approx 0.8192$
22. The x -coordinate of the point of intersection of $y = \sqrt{x}$ and $y = 3 - x^2$ is the solution of $\sqrt{x} = 3 - x^2$
 $\Rightarrow \sqrt{x} - 3 + x^2 = 0 \Rightarrow$ The x -coordinate is the root of $f(x) = \sqrt{x} - 3 + x^2 \Rightarrow f'(x) = \frac{1}{2\sqrt{x}} + 2x$. Let $x_0 = 1$
 $\Rightarrow x_{n+1} = x_n - \frac{\sqrt{x_n} - 3 + x_n^2}{\frac{1}{2\sqrt{x_n}} + 2x_n} \Rightarrow x_1 = 1.4 \Rightarrow x_2 = 1.35556 \Rightarrow x_3 = 1.35498 \Rightarrow x_7 = 1.35498 \Rightarrow r \approx 1.3550$
23. Graphing e^{-x^2} and $x^2 - x + 1$ shows that there are two places where the curves intersect, one at $x = 0$ and the other between $x = 0.5$ and $x = 0.6$. Let $f(x) = e^{-x^2} - x^2 + x - 1$, $x_0 = 0.5$, and
 $x_{n+1} = x_n - \frac{f(x_n)}{f'(x_n)} = x_n - \frac{e^{-x_n^2} - x_n^2 + x_n - 1}{-2x_n - 2x_n e^{-x_n^2}}$. Performing iterations on a calculator, spreadsheet, or CAS gives
 $x_1 = 0.536981$, $x_2 = 0.534856$, $x_3 = 0.53485$, $x_4 = 0.53485$. (You may get different results depending upon what you select for $f(x)$ and x_0 , and what calculator or computer you may use.) Therefore, the two curves intersect at $x = 0$ and $x = 0.53485$.
24. Graphing $\ln(1 - x^2)$ and $x - 1$ shows that there are two places where the curves intersect, one between $x = -1$ and $x = -0.9$, and the other between $x = 0.5$ and $x = 0.6$. Let $f(x) = \ln(1 - x^2) - x + 1$, and
 $x_{n+1} = x_n - \frac{f(x_n)}{f'(x_n)} = x_n - \frac{\ln(1 - x_n^2) - x_n + 1}{\frac{-2x_n}{1 - x_n^2} - 1}$. Performing iterations on a calculator, spreadsheet, or CAS with
 $x_0 = 0.5$ gives $x_1 = 0.590992$, $x_2 = 0.583658$, $x_3 = 0.583597$, $x_4 = 0.583597$ and with $x_0 = -0.9$ gives
 $x_1 = -0.928237$, $x_2 = -0.924247$, $x_3 = -0.924119$, $x_4 = -0.924119$. (You may get different results depending upon what you select for $f(x)$ and x_0 , and what calculator or computer you may use.) Therefore, the two curves intersect at $x = -0.924119$ and $x = 0.583597$.
25. If $f(x) = x^3 + 2x - 4$, then $f(1) = -1 < 0$ and $f(2) = 8 > 0 \Rightarrow$ by the Intermediate Value Theorem the equation $x^3 + 2x - 4 = 0$ has a solution between 1 and 2. Consequently, $f'(x) = 3x^2 + 2$ and $x_{n+1} = x_n - \frac{x_n^3 + 2x_n - 4}{3x_n^2 + 2}$. Then
 $x_0 = 1 \Rightarrow x_1 = 1.2 \Rightarrow x_2 = 1.17975 \Rightarrow x_3 = 1.179509 \Rightarrow x_4 = 1.1795090 \Rightarrow$ the root is approximately 1.17951.

26. We wish to solve $8x^4 - 14x^3 - 9x^2 + 11x - 1 = 0$. Let $f(x) = 8x^4 - 14x^3 - 9x^2 + 11x - 1$, then

$$f'(x) = 32x^3 - 42x^2 - 18x + 11 \Rightarrow x_{n+1} = x_n - \frac{8x_n^4 - 14x_n^3 - 9x_n^2 + 11x_n - 1}{32x_n^3 - 42x_n^2 - 18x_n + 11}.$$

x_0	approximation of corresponding root
-1.0	-0.976823589
0.1	0.100363332
0.6	0.642746671
2.0	1.983713587

27. $f(x) = 4x^4 - 4x^2 \Rightarrow f'(x) = 16x^3 - 8x \Rightarrow x_{i+1} = x_i - \frac{f(x_i)}{f'(x_i)} = x_i - \frac{x_i^3 - x_i}{4x_i^2 - 2}$. Iterations are performed using the procedure in problem 13 in this section.

- (a) For $x_0 = -2$ or $x_0 = -0.8$, $x_i \rightarrow -1$ as i gets large.
- (b) For $x_0 = -0.5$ or $x_0 = 0.25$, $x_i \rightarrow 0$ as i gets large.
- (c) For $x_0 = 0.8$ or $x_0 = 2$, $x_i \rightarrow 1$ as i gets large.
- (d) (If your calculator has a CAS, put it in exact mode, otherwise approximate the radicals with a decimal value.) For $x_0 = -\frac{\sqrt{21}}{7}$ or $x_0 = \frac{\sqrt{21}}{7}$, Newton's method does not converge. The values of x_i alternate between $x_0 = -\frac{\sqrt{21}}{7}$ or $x_0 = \frac{\sqrt{21}}{7}$ as i increases.

28. (a) The distance can be represented by $D(x) = \sqrt{(x-2)^2 + \left(x^2 + \frac{1}{2}\right)^2}$, where $x \geq 0$. The distance $D(x)$ is minimized when $f(x) = (x-2)^2 + \left(x^2 + \frac{1}{2}\right)^2$ is minimized. If $f(x) = (x-2)^2 + \left(x^2 + \frac{1}{2}\right)^2$, then $f'(x) = 4(x^3 + x - 1)$ and $f''(x) = 4(3x^2 + 1) > 0$. Now $f'(x) = 0 \Rightarrow x^3 + x - 1 = 0 \Rightarrow x(x^2 + 1) = 1 \Rightarrow x = \frac{1}{x^2 + 1}$.

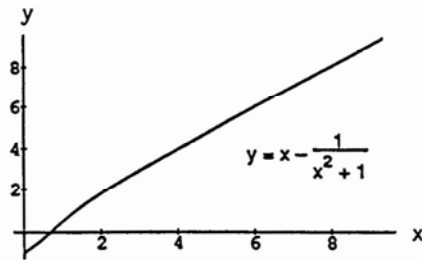

(b) Let $g(x) = \frac{1}{x^2 + 1} - x = (x^2 + 1)^{-1} - x \Rightarrow g'(x) = -(x^2 + 1)^{-2} (2x) - 1 = \frac{-2x}{(x^2 + 1)^2} - 1 \Rightarrow x_{n+1} = x_n - \frac{\left(\frac{1}{x_n^2 + 1} - x_n\right)}{\left(\frac{-2x_n}{(x_n^2 + 1)^2} - 1\right)}$.

$x_0 = 1 \Rightarrow x_4 = 0.68233$ to five decimal places.

29. $f(x) = (x-1)^{40} \Rightarrow f'(x) = 40(x-1)^{39} \Rightarrow x_{n+1} = x_n - \frac{(x_n-1)^{40}}{40(x_n-1)^{39}} = \frac{39x_n+1}{40}$. With $x_0 = 2$, our computer gave $x_{87} = x_{88} = x_{89} = \dots = x_{200} = 1.11051$, coming within 0.11051 of the root $x = 1$.

30. Since $s = r\theta \Rightarrow 3 = r\theta \Rightarrow \theta = \frac{3}{r}$. Bisect the angle θ to obtain a right triangle with hypotenuse r and opposite side of length 1. Then $\sin \frac{\theta}{2} = \frac{1}{r} \Rightarrow \sin \left(\frac{3}{2r}\right) = \frac{1}{r} \Rightarrow \sin \left(\frac{3}{2r}\right) - \frac{1}{r} = 0$. Thus the solution r is a root of

$$f(r) = \sin \left(\frac{3}{2r}\right) - \frac{1}{r} \Rightarrow f'(r) = -\frac{3}{2r^2} \cos \left(\frac{3}{2r}\right) + \frac{1}{r^2}; \quad r_0 = 1 \Rightarrow r_{n+1} = r_n - \frac{\sin \left(\frac{3}{2r_n}\right) - \frac{1}{r_n}}{-\frac{3}{2r_n^2} \cos \left(\frac{3}{2r_n}\right) + \frac{1}{r_n^2}} \Rightarrow r_1 = 1.00280$$

$$\Rightarrow r_2 = 1.00282 \Rightarrow r_3 = 1.00282 \Rightarrow r \approx 1.0028 \Rightarrow \theta = \frac{3}{1.00282} \approx 2.9916$$

4.8 ANTIDERIVATIVES

- | | | |
|--------------------------------|---|---|
| 1. (a) x^2 | (b) $\frac{x^3}{3}$ | (c) $\frac{x^3}{3} - x^2 + x$ |
| 2. (a) $3x^2$ | (b) $\frac{x^8}{8}$ | (c) $\frac{x^8}{8} - 3x^2 + 8x$ |
| 3. (a) x^{-3} | (b) $-\frac{x^{-3}}{3}$ | (c) $-\frac{x^{-3}}{3} + x^2 + 3x$ |
| 4. (a) $-x^{-2}$ | (b) $-\frac{x^{-2}}{4} + \frac{x^3}{3}$ | (c) $\frac{x^{-2}}{2} + \frac{x^2}{2} - x$ |
| 5. (a) $\frac{-1}{x}$ | (b) $\frac{-5}{x}$ | (c) $2x + \frac{5}{x}$ |
| 6. (a) $\frac{1}{x^2}$ | (b) $\frac{-1}{4x^2}$ | (c) $\frac{x^4}{4} + \frac{1}{2x^2}$ |
| 7. (a) $\sqrt{x^3}$ | (b) \sqrt{x} | (c) $\frac{2}{3}\sqrt{x^3} + 2\sqrt{x}$ |
| 8. (a) $x^{4/3}$ | (b) $\frac{1}{2}x^{2/3}$ | (c) $\frac{3}{4}x^{4/3} + \frac{3}{2}x^{2/3}$ |
| 9. (a) $x^{2/3}$ | (b) $x^{1/3}$ | (c) $x^{-1/3}$ |
| 10. (a) $x^{1/2}$ | (b) $x^{-1/2}$ | (c) $x^{-3/2}$ |
| 11. (a) $\ln x $ | (b) $7 \ln x $ | (c) $x - 5 \ln x $ |
| 12. (a) $\frac{1}{3} \ln x $ | (b) $\frac{2}{5} \ln x $ | (c) $x + \frac{4}{3} \ln x + \frac{1}{x}$ |
| 13. (a) $\cos(\pi x)$ | (b) $-3 \cos x$ | (c) $\frac{-\cos(\pi x)}{\pi} + \cos(3x)$ |
| 14. (a) $\sin(\pi x)$ | (b) $\sin\left(\frac{\pi x}{2}\right)$ | (c) $\left(\frac{2}{\pi}\right)\sin\left(\frac{\pi x}{2}\right) + \pi \sin x$ |
| 15. (a) $\tan x$ | (b) $2 \tan\left(\frac{x}{3}\right)$ | (c) $-\frac{2}{3} \tan\left(\frac{3x}{2}\right)$ |
| 16. (a) $-\cot x$ | (b) $\cot\left(\frac{3x}{2}\right)$ | (c) $x + 4 \cot(2x)$ |
| 17. (a) $-\csc x$ | (b) $\frac{1}{5} \csc(5x)$ | (c) $2 \csc\left(\frac{\pi x}{2}\right)$ |
| 18. (a) $\sec x$ | (b) $\frac{4}{3} \sec(3x)$ | (c) $\frac{2}{\pi} \sec\left(\frac{\pi x}{2}\right)$ |
| 19. (a) $\frac{1}{3} e^{3x}$ | (b) $-e^{-x}$ | (c) $2e^{x/2}$ |
| 20. (a) $-\frac{1}{2} e^{-2x}$ | (b) $\frac{3}{4} e^{4x/3}$ | (c) $-5e^{-x/5}$ |

21. (a) $\frac{1}{\ln 3} \cdot 3^x$ (b) $\frac{-1}{\ln 2} \cdot 2^{-x}$ (c) $\frac{1}{\ln(5/3)} \cdot \left(\frac{5}{3}\right)^x$
22. (a) $\frac{1}{\sqrt{3+1}} x^{\sqrt{3+1}}$ (b) $\frac{1}{\pi+1} x^{\pi+1}$ (c) $\frac{1}{\sqrt{2}} x^{\sqrt{2}}$
23. (a) $2 \sin^{-1} x$ (b) $\frac{1}{2} \tan^{-1} x$ (c) $\frac{1}{2} \tan^{-1}(2x)$
24. (a) $\frac{1}{2} x^2 - \frac{1}{\ln(1/2)} \cdot \left(\frac{1}{2}\right)^x$ (b) $\frac{1}{3} x^3 + \frac{1}{\ln 2} \cdot 2^x$ (c) $\frac{1}{\ln \pi} \cdot \pi^x - \ln|x|$
25. $\int (x+1) dx = \frac{x^2}{2} + x + C$ 26. $\int (5-6x) dx = 5x - 3x^2 + C$
27. $\int \left(3t^2 + \frac{t}{2}\right) dt = t^3 + \frac{t^2}{4} + C$ 28. $\int \left(\frac{t^2}{2} + 4t^3\right) dt = \frac{t^3}{6} + t^4 + C$
29. $\int (2x^3 - 5x + 7) dx = \frac{1}{2} x^4 - \frac{5}{2} x^2 + 7x + C$ 30. $\int (1-x^2 - 3x^5) dx = x - \frac{1}{3} x^3 - \frac{1}{2} x^6 + C$
31. $\int \left(\frac{1}{x^2} - x^2 - \frac{1}{3}\right) dx = \int \left(x^{-2} - x^2 - \frac{1}{3}\right) dx = \frac{x^{-1}}{-1} - \frac{x^3}{3} - \frac{1}{3} x + C = -\frac{1}{x} - \frac{x^3}{3} - \frac{x}{3} + C$
32. $\int \left(\frac{1}{5} - \frac{2}{x^3} + 2x\right) dx = \int \left(\frac{1}{5} - 2x^{-3} + 2x\right) dx = \frac{1}{5} x - \left(\frac{2x^{-2}}{-2}\right) + \frac{2x^2}{2} + C = \frac{x}{5} + \frac{1}{x^2} + x^2 + C$
33. $\int x^{-1/3} dx = \frac{x^{2/3}}{2/3} + C = \frac{3}{2} x^{2/3} + C$ 34. $\int x^{-5/4} dx = \frac{x^{-1/4}}{-1/4} + C = \frac{-4}{\sqrt[4]{x}} + C$
35. $\int \left(\sqrt{x} + \sqrt[3]{x}\right) dx = \int \left(x^{1/2} + x^{1/3}\right) dx = \frac{x^{3/2}}{3/2} + \frac{x^{4/3}}{4/3} + C = \frac{2}{3} x^{3/2} + \frac{3}{4} x^{4/3} + C$
36. $\int \left(\frac{\sqrt{x}}{2} + \frac{2}{\sqrt{x}}\right) dx = \int \left(\frac{1}{2} x^{1/2} + 2x^{-1/2}\right) dx = \frac{1}{2} \left(\frac{x^{3/2}}{3/2}\right) + 2 \left(\frac{x^{1/2}}{1/2}\right) + C = \frac{1}{3} x^{3/2} + 4x^{1/2} + C$
37. $\int \left(8y - \frac{2}{y^{1/4}}\right) dy = \int \left(8y - 2y^{-1/4}\right) dy = \frac{8y^2}{2} - 2 \left(\frac{y^{3/4}}{3/4}\right) + C = 4y^2 - \frac{8}{3} y^{3/4} + C$
38. $\int \left(\frac{1}{7} - \frac{1}{y^{5/4}}\right) dy = \int \left(\frac{1}{7} - y^{-5/4}\right) dy = \frac{1}{7} y - \left(\frac{y^{-1/4}}{-1/4}\right) + C = \frac{y}{7} + \frac{4}{y^{1/4}} + C$
39. $\int 2x(1-x^{-3}) dx = \int (2x - 2x^{-2}) dx = \frac{2x^2}{2} - 2 \left(\frac{x^{-1}}{-1}\right) + C = x^2 + \frac{2}{x} + C$
40. $\int x^{-3}(x+1) dx = \int (x^{-2} + x^{-3}) dx = \frac{x^{-1}}{-1} + \left(\frac{x^{-2}}{-2}\right) + C = -\frac{1}{x} - \frac{1}{2x^2} + C$
41. $\int \frac{t\sqrt{t} + \sqrt{t}}{t^2} dt = \int \left(\frac{t^{3/2}}{t^2} + \frac{t^{1/2}}{t^2}\right) dt = \int \left(t^{-1/2} + t^{-3/2}\right) dt = \frac{t^{1/2}}{1/2} + \left(\frac{t^{-1/2}}{-1/2}\right) + C = 2\sqrt{t} - \frac{2}{\sqrt{t}} + C$

$$42. \int \frac{4+\sqrt{t}}{t^3} dt = \int \left(\frac{4}{t^3} + \frac{t^{1/2}}{t^3} \right) dt = \int (4t^{-3} + t^{-5/2}) dt = 4 \left(\frac{t^{-2}}{-2} \right) + \left(\frac{t^{-3/2}}{-3/2} \right) + C = -\frac{2}{t^2} - \frac{2}{3t^{3/2}} + C$$

$$43. \int -2 \cos t dt = -2 \sin t + C$$

$$44. \int -5 \sin t dt = 5 \cos t + C$$

$$45. \int 7 \sin \frac{\theta}{3} d\theta = -21 \cos \frac{\theta}{3} + C$$

$$46. \int 3 \cos 5\theta d\theta = \frac{3}{5} \sin 5\theta + C$$

$$47. \int -3 \csc^2 x dx = 3 \cot x + C$$

$$48. \int -\frac{\sec^2 x}{3} dx = -\frac{\tan x}{3} + C$$

$$49. \int \frac{\csc \theta \cot \theta}{2} d\theta = -\frac{1}{2} \csc \theta + C$$

$$50. \int \frac{2}{5} \sec \theta \tan \theta d\theta = \frac{2}{5} \sec \theta + C$$

$$51. \int (e^{3x} + 5e^{-x}) dx = \frac{e^{3x}}{3} - 5e^{-x} + C$$

$$52. \int (2e^x - 3e^{-2x}) dx = 2e^x + \frac{3}{2}e^{-2x} + C$$

$$53. \int (e^{-x} + 4^x) dx = -e^{-x} + \frac{4^x}{\ln 4} + C$$

$$54. \int (1.3)^x dx = \frac{(1.3)^x}{\ln(1.3)} + C$$

$$55. \int (4 \sec x \tan x - 2 \sec^2 x) dx = 4 \sec x - 2 \tan x + C$$

$$56. \int \frac{1}{2} (\csc^2 x - \csc x \cot x) dx = -\frac{1}{2} \cot x + \frac{1}{2} \csc x + C$$

$$57. \int (\sin 2x - \csc^2 x) dx = -\frac{1}{2} \cos 2x + \cot x + C$$

$$58. \int (2 \cos 2x - 3 \sin 3x) dx = \sin 2x + \cos 3x + C$$

$$59. \int \frac{1+\cos 4t}{2} dt = \int \left(\frac{1}{2} + \frac{1}{2} \cos 4t \right) dt = \frac{1}{2} t + \frac{1}{2} \left(\frac{\sin 4t}{4} \right) + C = \frac{t}{2} + \frac{\sin 4t}{8} + C$$

$$60. \int \frac{1-\cos 6t}{2} dt = \int \left(\frac{1}{2} - \frac{1}{2} \cos 6t \right) dt = \frac{1}{2} t - \frac{1}{2} \left(\frac{\sin 6t}{6} \right) + C = \frac{t}{2} - \frac{\sin 6t}{12} + C$$

$$61. \int \left(\frac{1}{x} - \frac{5}{x^2+1} \right) dx = \ln|x| - 5 \tan^{-1} x + C$$

$$62. \int \left(\frac{2}{\sqrt{1-y^2}} - \frac{1}{y^{1/4}} \right) dy = 2 \sin^{-1} y - \frac{4}{3} y^{3/4} + C$$

$$63. \int 3x^{\sqrt{3}} dx = \frac{3x^{\sqrt{3}+1}}{\sqrt{3}+1} + C$$

$$64. \int x^{(\sqrt{2}-1)} dx = \frac{x^{\sqrt{2}}}{\sqrt{2}} + C$$

$$65. \int (1 + \tan^2 \theta) d\theta = \int \sec^2 \theta d\theta = \tan \theta + C$$

$$66. \int (2 + \tan^2 \theta) d\theta = \int (1 + 1 + \tan^2 \theta) d\theta = \int (1 + \sec^2 \theta) d\theta = \theta + \tan \theta + C$$

$$67. \int \cot^2 x dx = \int (\csc^2 x - 1) dx = -\cot x - x + C$$

$$68. \int (1 - \cot^2 x) dx = \int (1 - (\csc^2 x - 1)) dx = \int (2 - \csc^2 x) dx = 2x + \cot x + C$$

$$69. \int \cos \theta (\tan \theta + \sec \theta) d\theta = \int (\sin \theta + 1) d\theta = -\cos \theta + \theta + C$$

$$70. \int \frac{\csc \theta}{\csc \theta - \sin \theta} d\theta = \int \left(\frac{\csc \theta}{\csc \theta - \sin \theta} \right) \left(\frac{\sin \theta}{\sin \theta} \right) d\theta = \int \frac{1}{1 - \sin^2 \theta} d\theta = \int \frac{1}{\cos^2 \theta} d\theta = \int \sec^2 \theta d\theta = \tan \theta + C$$

$$71. \frac{d}{dx} \left(\frac{(7x-2)^4}{28} + C \right) = \frac{4(7x-2)^3(7)}{28} = (7x-2)^3$$

$$72. \frac{d}{dx} \left(-\frac{(3x+5)^{-1}}{3} + C \right) = -\left(-\frac{(3x+5)^{-2}(3)}{3} \right) = (3x+5)^{-2}$$

$$73. \frac{d}{dx} \left(\frac{1}{5} \tan(5x-1) + C \right) = \frac{1}{5} (\sec^2(5x-1))(5) = \sec^2(5x-1)$$

$$74. \frac{d}{dx} \left(-3 \cot\left(\frac{x-1}{3}\right) + C \right) = -3 \left(-\csc^2\left(\frac{x-1}{3}\right) \right) \left(\frac{1}{3} \right) = \csc^2\left(\frac{x-1}{3}\right)$$

$$75. \frac{d}{dx} \left(\frac{-1}{x+1} + C \right) = (-1)(-1)(x+1)^{-2} = \frac{1}{(x+1)^2}$$

$$76. \frac{d}{dx} \left(\frac{x}{x+1} + C \right) = \frac{(x+1)(1) - x(1)}{(x+1)^2} = \frac{1}{(x+1)^2}$$

$$77. \frac{d}{dx} (\ln|x+1| + C) = \frac{1}{x+1}$$

$$78. \frac{d}{dx} (xe^x - e^x + C) = x \cdot e^x + (1) \cdot e^x - e^x = xe^x$$

$$79. \frac{d}{dx} \left(\frac{1}{a} \tan^{-1}\left(\frac{x}{a}\right) + C \right) = \frac{1}{a} \cdot \frac{1}{1 + \left(\frac{x}{a}\right)^2} \cdot \frac{d}{dx} \left(\frac{x}{a} \right) = \frac{1}{a^2 \left(1 + \frac{x^2}{a^2}\right)} = \frac{1}{a^2 + x^2}$$

$$80. \frac{d}{dx} \left(\sin^{-1}\left(\frac{x}{a}\right) + C \right) = \frac{1}{\sqrt{1 - \left(\frac{x}{a}\right)^2}} \cdot \frac{d}{dx} \left(\frac{x}{a} \right) = \frac{1}{a\sqrt{1 - \left(\frac{x}{a}\right)^2}} = \frac{1}{\sqrt{a^2 - x^2}}$$

81. If $y = \ln x - \frac{1}{2} \ln(1+x^2) - \frac{\tan^{-1} x}{x} + C$, then

$$dy = \left[\frac{1}{x} - \frac{x}{1+x^2} - \frac{\left(\frac{-x}{1+x^2}\right) - \tan^{-1} x}{x^2} \right] dx = \left(\frac{1}{x} - \frac{x}{1+x^2} - \frac{1}{x(1+x^2)} + \frac{\tan^{-1} x}{x^2} \right) dx = \frac{x(1+x^2) - x^3 - x + (\tan^{-1} x)(1+x^2)}{x^2(1+x^2)} dx = \frac{\tan^{-1} x}{x^2} dx,$$

which verifies the formula

82. If $y = x(\sin^{-1} x)^2 - 2x + 2\sqrt{1-x^2} \sin^{-1} x + C$, then

$$dy = \left[(\sin^{-1} x)^2 + \frac{2x(\sin^{-1} x)}{\sqrt{1-x^2}} - 2 + \frac{-2x}{\sqrt{1-x^2}} \sin^{-1} x + 2\sqrt{1-x^2} \left(\frac{1}{\sqrt{1-x^2}} \right) \right] dx = (\sin^{-1} x)^2 dx, \text{ which verifies the formula}$$

83. (a) Wrong: $\frac{d}{dx} \left(\frac{x^2}{2} \sin x + C \right) = \frac{2x}{2} \sin x + \frac{x^2}{2} \cos x = x \sin x + \frac{x^2}{2} \cos x \neq x \sin x$

(b) Wrong: $\frac{d}{dx} (-x \cos x + C) = -\cos x + x \sin x \neq x \sin x$

(c) Right: $\frac{d}{dx} (-x \cos x + \sin x + C) = -\cos x + x \sin x + \cos x = x \sin x$

84. (a) Wrong: $\frac{d}{d\theta} \left(\frac{\sec^3 \theta}{3} + C \right) = \frac{3\sec^2 \theta}{3} (\sec \theta \tan \theta) = \sec^3 \theta \tan \theta \neq \tan \theta \sec^2 \theta$

(b) Right: $\frac{d}{d\theta} \left(\frac{1}{2} \tan^2 \theta + C \right) = \frac{1}{2} (2 \tan \theta) \sec^2 \theta = \tan \theta \sec^2 \theta$

(c) Right: $\frac{d}{d\theta} \left(\frac{1}{2} \sec^2 \theta + C \right) = \frac{1}{2} (2 \sec \theta) \sec \theta \tan \theta = \tan \theta \sec^2 \theta$

85. (a) Wrong: $\frac{d}{dx}\left(\frac{(2x+1)^3}{3} + C\right) = \frac{3(2x+1)^2(2)}{3} = 2(2x+1)^2 \neq (2x+1)^2$
 (b) Wrong: $\frac{d}{dx}((2x+1)^3 + C) = 3(2x+1)^2(2) = 6(2x+1)^2 \neq 3(2x+1)^2$
 (c) Right: $\frac{d}{dx}((2x+1)^3 + C) = 6(2x+1)^2$
86. (a) Wrong: $\frac{d}{dx}(x^2 + x + C)^{1/2} = \frac{1}{2}(x^2 + x + C)^{-1/2}(2x+1) = \frac{2x+1}{2\sqrt{x^2+x+C}} \neq \sqrt{2x+1}$
 (b) Wrong: $\frac{d}{dx}\left((x^2 + x)^{1/2} + C\right) = \frac{1}{2}(x^2 + x)^{-1/2}(2x+1) = \frac{2x+1}{2\sqrt{x^2+x}} \neq \sqrt{2x+1}$
 (c) Right: $\frac{d}{dx}\left(\frac{1}{3}(\sqrt{2x+1})^3 + C\right) = \frac{d}{dx}\left(\frac{1}{3}(2x+1)^{3/2} + C\right) = \frac{3}{6}(2x+1)^{1/2}(2) = \sqrt{2x+1}$
87. Right: $\frac{d}{dx}\left(\frac{(x+3)^3}{x-2} + C\right) = 3\left(\frac{x+3}{x-2}\right)^2 \frac{(x-2) \cdot 1 - (x+3) \cdot 1}{(x-2)^2} = 3 \frac{(x+3)^2}{(x-2)^2} \frac{-5}{(x-2)^2} = \frac{-15(x+3)^2}{(x-2)^4}$
88. Wrong: $\frac{d}{dx}\left(\frac{\sin(x^2)}{x} + C\right) = \frac{x \cos(x^2)(2x) - \sin(x^2) \cdot 1}{x^2} = \frac{2x^2 \cos(x^2) - \sin(x^2)}{x^2} \neq \frac{x \cos(x^2) - \sin(x^2)}{x^2}$
89. Graph (b), because $\frac{dy}{dx} = 2x \Rightarrow y = x^2 + C$. Then $y(1) = 4 \Rightarrow C = 3$.
90. Graph (b), because $\frac{dy}{dx} = -x \Rightarrow y = -\frac{1}{2}x^2 + C$. Then $y(-1) = 1 \Rightarrow C = \frac{3}{2}$.
91. $\frac{dy}{dx} = 2x - 7 \Rightarrow y = x^2 - 7x + C$; at $x = 2$ and $y = 0$ we have $0 = 2^2 - 7(2) + C \Rightarrow C = 10 \Rightarrow y = x^2 - 7x + 10$
92. $\frac{dy}{dx} = 10 - x \Rightarrow y = 10x - \frac{x^2}{2} + C$; at $x = 0$ and $y = -1$ we have $-1 = 10(0) - \frac{0^2}{2} + C \Rightarrow C = -1 \Rightarrow y = 10x - \frac{x^2}{2} - 1$
93. $\frac{dy}{dx} = \frac{1}{x^2} + x = x^{-2} + x \Rightarrow y = -x^{-1} + \frac{x^2}{2} + C$; at $x = 2$ and $y = 1$ we have $1 = -2^{-1} + \frac{2^2}{2} + C \Rightarrow C = -\frac{1}{2}$
 $\Rightarrow y = -x^{-1} + \frac{x^2}{2} - \frac{1}{2}$ or $y = -\frac{1}{x} + \frac{x^2}{2} - \frac{1}{2}$
94. $\frac{dy}{dx} = 9x^2 - 4x + 5 \Rightarrow y = 3x^3 - 2x^2 + 5x + C$; at $x = -1$ and $y = 0$ we have $0 = 3(-1)^3 - 2(-1)^2 + 5(-1) + C$
 $\Rightarrow C = 10 \Rightarrow y = 3x^3 - 2x^2 + 5x + 10$
95. $\frac{dy}{dx} = 3x^{-2/3} \Rightarrow y = \frac{3x^{1/3}}{\frac{1}{3}} + C = 9x^{1/3} + C$; at $x = -1$ and $y = -5$ we have $-5 = 9(-1)^{1/3} + C \Rightarrow C = 4$
 $\Rightarrow y = 9x^{1/3} + 4$
96. $\frac{dy}{dx} = \frac{1}{2\sqrt{x}} = \frac{1}{2}x^{-1/2} \Rightarrow y = x^{1/2} + C$; at $x = 4$ and $y = 0$ we have $0 = 4^{1/2} + C \Rightarrow C = -2 \Rightarrow y = x^{1/2} - 2$
97. $\frac{ds}{dt} = 1 + \cos t \Rightarrow s = t + \sin t + C$; at $t = 0$ and $s = 4$ we have $4 = 0 + \sin 0 + C \Rightarrow C = 4 \Rightarrow s = t + \sin t + 4$
98. $\frac{ds}{dt} = \cos t + \sin t \Rightarrow s = \sin t - \cos t + C$; at $t = \pi$ and $s = 1$ we have $1 = \sin \pi - \cos \pi + C \Rightarrow C = 0$
 $\Rightarrow s = \sin t - \cos t$
99. $\frac{dr}{d\theta} = -\pi \sin \pi\theta \Rightarrow r = \cos(\pi\theta) + C$; at $r = 0$ and $\theta = 0$ we have $0 = \cos(\pi \cdot 0) + C \Rightarrow C = -1 \Rightarrow r = \cos(\pi\theta) - 1$

$$100. \frac{dr}{d\theta} = \cos \pi\theta \Rightarrow r = \frac{1}{\pi} \sin(\pi\theta) + C; \text{ at } r = 1 \text{ and } \theta = 0 \text{ we have } 1 = \frac{1}{\pi} \sin(\pi \cdot 0) + C \Rightarrow C = 1 \Rightarrow r = \frac{1}{\pi} \sin(\pi\theta) + 1$$

$$101. \frac{dv}{dt} = \frac{1}{2} \sec t \tan t \Rightarrow v = \frac{1}{2} \sec t + C; \text{ at } v = 1 \text{ and } t = 0 \text{ we have } 1 = \frac{1}{2} \sec(0) + C \Rightarrow C = \frac{1}{2} \Rightarrow v = \frac{1}{2} \sec t + \frac{1}{2}$$

$$102. \frac{dv}{dt} = 8t + \csc^2 t \Rightarrow v = 4t^2 - \cot t + C; \text{ at } v = -7 \text{ and } t = \frac{\pi}{2} \text{ we have } -7 = 4\left(\frac{\pi}{2}\right)^2 - \cot\left(\frac{\pi}{2}\right) + C \Rightarrow C = -7 - \pi^2 \\ \Rightarrow v = 4t^2 - \cot t - 7 - \pi^2$$

$$103. \frac{dv}{dt} = \frac{3}{t\sqrt{t^2-1}}, t > 1 \Rightarrow v = 3 \sec^{-1} t + C; \text{ at } t = 2 \text{ and } v = 0 \text{ we have } 0 = 3 \sec^{-1} 2 + C \Rightarrow C = -\pi \\ \Rightarrow v = 3 \sec^{-1} t - \pi$$

$$104. \frac{dv}{dt} = \frac{8}{1+t^2} + \sec^2 t \Rightarrow v = 8 \tan^{-1} t + \tan t + C; \text{ at } t = 0 \text{ and } v = 1 \text{ we have } 1 = 8 \tan^{-1}(0) + \tan(0) + C \Rightarrow C = 1 \\ \Rightarrow v = 8 \tan^{-1} t + \tan t + 1$$

$$105. \frac{d^2y}{dx^2} = 2 - 6x \Rightarrow \frac{dy}{dx} = 2x - 3x^2 + C_1; \text{ at } \frac{dy}{dx} = 4 \text{ and } x = 0 \text{ we have } 4 = 2(0) - 3(0)^2 + C_1 \Rightarrow C_1 = 4 \\ \Rightarrow \frac{dy}{dx} = 2x - 3x^2 + 4 \Rightarrow y = x^2 - x^3 + 4x + C_2; \text{ at } y = 1 \text{ and } x = 0 \text{ we have } 1 = 0^2 - 0^3 + 4(0) + C_2 \Rightarrow C_2 = 1 \\ \Rightarrow y = x^2 - x^3 + 4x + 1$$

$$106. \frac{d^2y}{dx^2} = 0 \Rightarrow \frac{dy}{dx} = C_1; \text{ at } \frac{dy}{dx} = 2 \text{ and } x = 0 \text{ we have } C_1 = 2 \Rightarrow \frac{dy}{dx} = 2 \Rightarrow y = 2x + C_2; \text{ at } y = 0 \text{ and } x = 0 \text{ we have } \\ 0 = 2(0) + C_2 \Rightarrow C_2 = 0 \Rightarrow y = 2x$$

$$107. \frac{d^2r}{dt^2} = \frac{2}{t^3} = 2t^{-3} \Rightarrow \frac{dr}{dt} = -t^{-2} + C_1; \text{ at } \frac{dr}{dt} = 1 \text{ and } t = 1 \text{ we have } 1 = -(1)^{-2} + C_1 \Rightarrow C_1 = 2 \Rightarrow \frac{dr}{dt} = -t^{-2} + 2 \\ \Rightarrow r = t^{-1} + 2t + C_2; \text{ at } r = 1 \text{ and } t = 1 \text{ we have } 1 = 1^{-1} + 2(1) + C_2 \Rightarrow C_2 = -2 \Rightarrow r = t^{-1} + 2t - 2 \text{ or } r = \frac{1}{t} + 2t - 2$$

$$108. \frac{d^2s}{dt^2} = \frac{3t}{8} \Rightarrow \frac{ds}{dt} = \frac{3t^2}{16} + C_1; \text{ at } \frac{ds}{dt} = 3 \text{ and } t = 4 \text{ we have } 3 = \frac{3(4)^2}{16} + C_1 \Rightarrow C_1 = 0 \Rightarrow \frac{ds}{dt} = \frac{3t^2}{16} \Rightarrow s = \frac{t^3}{16} + C_2; \text{ at } \\ s = 4 \text{ and } t = 4 \text{ we have } 4 = \frac{4^3}{16} + C_2 \Rightarrow C_2 = 0 \Rightarrow s = \frac{t^3}{16}$$

$$109. \frac{d^3y}{dx^3} = 6 \Rightarrow \frac{d^2y}{dx^2} = 6x + C_1; \text{ at } \frac{d^2y}{dx^2} = -8 \text{ and } x = 0 \text{ we have } -8 = 6(0) + C_1 \Rightarrow C_1 = -8 \Rightarrow \frac{d^2y}{dx^2} = 6x - 8 \\ \Rightarrow \frac{dy}{dx} = 3x^2 - 8x + C_2; \text{ at } \frac{dy}{dx} = 0 \text{ and } x = 0 \text{ we have } 0 = 3(0)^2 - 8(0) + C_2 \Rightarrow C_2 = 0 \Rightarrow \frac{dy}{dx} = 3x^2 - 8x \\ \Rightarrow y = x^3 - 4x^2 + C_3; \text{ at } y = 5 \text{ and } x = 0 \text{ we have } 5 = 0^3 - 4(0)^2 + C_3 \Rightarrow C_3 = 5 \Rightarrow y = x^3 - 4x^2 + 5$$

$$110. \frac{d^3\theta}{dt^3} = 0 \Rightarrow \frac{d^2\theta}{dt^2} = C_1; \text{ at } \frac{d^2\theta}{dt^2} = -2 \text{ and } t = 0 \text{ we have } \frac{d^2\theta}{dt^2} = -2 \Rightarrow \frac{d\theta}{dt} = -2t + C_2; \text{ at } \frac{d\theta}{dt} = -\frac{1}{2} \text{ and } t = 0 \text{ we have } \\ -\frac{1}{2} = -2(0) + C_2 \Rightarrow C_2 = -\frac{1}{2} \Rightarrow \frac{d\theta}{dt} = -2t - \frac{1}{2} \Rightarrow \theta = -t^2 - \frac{1}{2}t + C_3; \text{ at } \theta = \sqrt{2} \text{ and } t = 0 \text{ we have } \\ \sqrt{2} = -0^2 - \frac{1}{2}(0) + C_3 \Rightarrow C_3 = \sqrt{2} \Rightarrow \theta = -t^2 - \frac{1}{2}t + \sqrt{2}$$

$$111. y^{(4)} = -\sin t + \cos t \Rightarrow y''' = \cos t + \sin t + C_1; \text{ at } y''' = 7 \text{ and } t = 0 \text{ we have } 7 = \cos(0) + \sin(0) + C_1 \Rightarrow C_1 = 6 \\ \Rightarrow y''' = \cos t + \sin t + 6 \Rightarrow y'' = \sin t - \cos t + 6t + C_2; \text{ at } y'' = -1 \text{ and } t = 0 \text{ we have } \\ -1 = \sin(0) - \cos(0) + 6(0) + C_2 \Rightarrow C_2 = 0 \Rightarrow y'' = \sin t - \cos t + 6t \Rightarrow y' = -\cos t - \sin t + 3t^2 + C_3; \text{ at}$$

$$y' = -1 \text{ and } t = 0 \text{ we have } -1 = -\cos(0) - \sin(0) + 3(0)^2 + C_3 \Rightarrow C_3 = 0 \Rightarrow y' = -\cos t - \sin t + 3t^2$$

$$\Rightarrow y = -\sin t + \cos t + t^3 + C_4; \text{ at } y = 0 \text{ and } t = 0 \text{ we have } 0 = -\sin(0) + \cos(0) + 0^3 + C_4$$

$$\Rightarrow C_4 = -1 \Rightarrow y = -\sin t + \cos t + t^3 - 1$$

112. $y^{(4)} = -\cos x + 8\sin(2x) \Rightarrow y''' = -\sin x - 4\cos(2x) + C_1$; at $y''' = 0$ and $x = 0$ we have
 $0 = -\sin(0) - 4\cos(2(0)) + C_1 \Rightarrow C_1 = 4 \Rightarrow y''' = -\sin x - 4\cos(2x) + 4 \Rightarrow y'' = \cos x - 2\sin(2x) + 4x + C_2$; at
 $y'' = 1$ and $x = 0$ we have $1 = \cos(0) - 2\sin(2(0)) + 4(0) + C_2 \Rightarrow C_2 = 0 \Rightarrow y'' = \cos x - 2\sin(2x) + 4x$
 $\Rightarrow y' = \sin x + \cos(2x) + 2x^2 + C_3$; at $y' = 1$ and $x = 0$ we have $1 = \sin(0) + \cos(2(0)) + 2(0)^2 + C_3 \Rightarrow C_3 = 0$
 $\Rightarrow y' = \sin x + \cos(2x) + 2x^2 \Rightarrow y = -\cos x + \frac{1}{2}\sin(2x) + \frac{2}{3}x^3 + C_4$; at $y = 3$ and $x = 0$ we have
 $3 = -\cos(0) + \frac{1}{2}\sin(2(0)) + \frac{2}{3}(0)^3 + C_4 \Rightarrow C_4 = 4 \Rightarrow y = -\cos x + \frac{1}{2}\sin(2x) + \frac{2}{3}x^3 + 4$

113. $m = y' = 3\sqrt{x} = 3x^{1/2} \Rightarrow y = 2x^{3/2} + C$; at $(9, 4)$ we have $4 = 2(9)^{3/2} + C \Rightarrow C = -50 \Rightarrow y = 2x^{3/2} - 50$

114. (a) $\frac{d^2y}{dx^2} = 6x \Rightarrow \frac{dy}{dx} = 3x^2 + C_1$; at $y' = 0$ and $x = 0$ we have $0 = 3(0)^2 + C_1 \Rightarrow C_1 = 0 \Rightarrow \frac{dy}{dx} = 3x^2$
 $\Rightarrow y = x^3 + C_2$; at $y = 1$ and $x = 0$ we have $C_2 = 1 \Rightarrow y = x^3 + 1$

(b) One, because any other possible function would differ from $x^3 + 1$ by a constant that must be zero because of the initial conditions

115. $\frac{dy}{dx} = 1 - \frac{4}{3}x^{1/3} \Rightarrow y = \int \left(1 - \frac{4}{3}x^{1/3}\right) dx = x - x^{4/3} + C$; at $(1, 0.5)$ on the curve we have
 $0.5 = 1 - 1^{4/3} + C \Rightarrow C = 0.5 \Rightarrow y = x - x^{4/3} + \frac{1}{2}$

116. $\frac{dy}{dx} = x - 1 \Rightarrow y = \int (x - 1) dx = \frac{x^2}{2} - x + C$; at $(-1, 1)$ on the curve we have
 $1 = \frac{(-1)^2}{2} - (-1) + C \Rightarrow C = -\frac{1}{2} \Rightarrow y = \frac{x^2}{2} - x - \frac{1}{2}$

117. $\frac{dy}{dx} = \sin x - \cos x \Rightarrow y = \int (\sin x - \cos x) dx = -\cos x - \sin x + C$; at $(-\pi, -1)$ on the curve we have
 $-1 = -\cos(-\pi) - \sin(-\pi) + C \Rightarrow C = -2 \Rightarrow y = -\cos x - \sin x - 2$

118. $\frac{dy}{dx} = \frac{1}{2\sqrt{x}} + \pi \sin \pi x = \frac{1}{2}x^{-1/2} + \pi \sin \pi x \Rightarrow y = \int \left(\frac{1}{2}x^{-1/2} + \sin \pi x\right) dx = x^{1/2} - \cos \pi x + C$; at $(1, 2)$ on the curve
we have $2 = 1^{1/2} - \cos \pi(1) + C \Rightarrow C = 0 \Rightarrow y = \sqrt{x} - \cos \pi x$

119. (a) $\frac{ds}{dt} = 9.8t - 3 \Rightarrow s = 4.9t^2 - 3t + C$; (i) at $s = 5$ and $t = 0$ we have $C = 5 \Rightarrow s = 4.9t^2 - 3t + 5$;
displacement = $s(3) - s(1) = ((4.9)(9) - 9 + 5) - (4.9 - 3 + 5) = 33.2$ units; (ii) at $s = -2$ and $t = 0$ we have
 $C = -2 \Rightarrow s = 4.9t^2 - 3t - 2$; displacement = $s(3) - s(1) = ((4.9)(9) - 9 - 2) - (4.9 - 3 - 2) = 33.2$ units;
(iii) at $s = s_0$ and $t = 0$ we have $C = s_0 \Rightarrow s = 4.9t^2 - 3t + s_0$;
displacement = $s(3) - s(1) = ((4.9)(9) - 9 + s_0) - (4.9 - 3 + s_0) = 33.2$ units

(b) True. Given an antiderivative $f(t)$ of the velocity function, we know that the body's position function is $s = f(t) + C$ for some constant C . Therefore, the displacement from $t = a$ to $t = b$ is
 $(f(b) + C) - (f(a) + C) = f(b) - f(a)$. Thus we can find the displacement from any antiderivative f as the numerical difference $f(b) - f(a)$ without knowing the exact values of C and s .

120. $a(t) = v'(t) = 20 \Rightarrow v(t) = 20t + C$; at $(0, 0)$ we have $C = 0 \Rightarrow v(t) = 20t$. When $t = 60$, then $v(60) = 20(60) = 1200$ m/sec.

121. Step 1: $\frac{d^2s}{dt^2} = -k \Rightarrow \frac{ds}{dt} = -kt + C_1$; at $\frac{ds}{dt} = 88$ and $t = 0$ we have

$$C_1 = 88 \Rightarrow \frac{ds}{dt} = -kt + 88 \Rightarrow s = -k\left(\frac{t^2}{2}\right) + 88t + C_2; \text{ at } s = 0 \text{ and } t = 0 \text{ we have } C_2 = 0 \Rightarrow s = -\frac{kt^2}{2} + 88t$$

Step 2: $\frac{ds}{dt} = 0 \Rightarrow 0 = -kt + 88 \Rightarrow t = \frac{88}{k}$

Step 3: $242 = -\frac{k\left(\frac{88}{k}\right)^2}{2} + 88\left(\frac{88}{k}\right) \Rightarrow 242 = -\frac{(88)^2}{2k} + \frac{(88)^2}{k} \Rightarrow 242 = \frac{(88)^2}{2k} \Rightarrow k = 16$

122. $\frac{d^2s}{dt^2} = -k \Rightarrow \frac{ds}{dt} = \int -k dt = -kt + C$; at $\frac{ds}{dt} = 44$ when $t = 0$ we have

$$44 = -k(0) + C \Rightarrow C = 44 \Rightarrow \frac{ds}{dt} = -kt + 44 \Rightarrow s = -\frac{kt^2}{2} + 44t + C_1; \text{ at } s = 0 \text{ when } t = 0 \text{ we have}$$

$$0 = -\frac{k(0)^2}{2} + 44(0) + C_1 \Rightarrow C_1 = 0 \Rightarrow s = -\frac{kt^2}{2} + 44t. \text{ Then } \frac{ds}{dt} = 0 \Rightarrow -kt + 44 = 0 \Rightarrow t = \frac{44}{k} \text{ and}$$

$$s\left(\frac{44}{k}\right) = -\frac{k\left(\frac{44}{k}\right)^2}{2} + 44\left(\frac{44}{k}\right) = 45 \Rightarrow -\frac{968}{k} + \frac{1936}{k} = 45 \Rightarrow k = \frac{968}{45} \approx 21.5 \frac{\text{ft}}{\text{sec}^2}.$$

123. (a) $v = \int a dt = \int (15t^{1/2} - 3t^{-1/2}) dt = 10t^{3/2} - 6t^{1/2} + C$;

$$\frac{ds}{dt}(1) = 4 \Rightarrow 4 = 10(1)^{3/2} - 6(1)^{1/2} + C \Rightarrow C = 0 \Rightarrow v = 10t^{3/2} - 6t^{1/2}$$

(b) $s = \int v dt = \int (10t^{3/2} - 6t^{1/2}) dt = 4t^{5/2} - 4t^{3/2} + C$;

$$s(1) = 0 \Rightarrow 0 = 4(1)^{5/2} - 4(1)^{3/2} + C \Rightarrow C = 0 \Rightarrow s = 4t^{5/2} - 4t^{3/2}$$

124. $\frac{d^2s}{dt^2} = -5.2 \Rightarrow \frac{ds}{dt} = -5.2t + C_1$; at $\frac{ds}{dt} = 0$ and $t = 0$ we have $C_1 = 0 \Rightarrow \frac{ds}{dt} = -5.2t \Rightarrow s = -2.6t^2 + C_2$; at $s = 4$

and $t = 0$ we have $C_2 = 4 \Rightarrow s = -2.6t^2 + 4$. Then $s = 0 \Rightarrow 0 = -2.6t^2 + 4 \Rightarrow t = \sqrt{\frac{4}{2.6}} \approx 1.24$ sec, since $t > 0$

125. $\frac{d^2s}{dt^2} = a \Rightarrow \frac{ds}{dt} = \int a dt = at + C$; $\frac{ds}{dt} = v_0$ when $t = 0 \Rightarrow C = v_0 \Rightarrow \frac{ds}{dt} = at + v_0 \Rightarrow s = \frac{at^2}{2} + v_0t + C_1$; $s = s_0$

$$\text{when } t = 0 \Rightarrow s_0 = \frac{a(0)^2}{2} + v_0(0) + C_1 \Rightarrow C_1 = s_0 \Rightarrow s = \frac{at^2}{2} + v_0t + s_0$$

126. The appropriate initial value problem is: Differential Equation: $\frac{d^2s}{dt^2} = -g$ with Initial Conditions: $\frac{ds}{dt} = v_0$ and

$$s = s_0 \text{ when } t = 0. \text{ Thus } \frac{ds}{dt} = \int -g dt = -gt + C_1; \frac{ds}{dt}(0) = v_0 \Rightarrow v_0 = (-g)(0) + C_1 \Rightarrow C_1 = v_0 \Rightarrow \frac{ds}{dt} = -gt + v_0.$$

$$\text{Thus } s = \int (-gt + v_0) dt = -\frac{1}{2}gt^2 + v_0t + C_2; s(0) = s_0 = -\frac{1}{2}(g)(0)^2 + v_0(0) + C_2 \Rightarrow C_2 = s_0$$

$$\text{Thus } s = -\frac{1}{2}gt^2 + v_0t + s_0.$$

127 (a) $\int f(x) dx = 1 - \sqrt{x} + C_1 = -\sqrt{x} + C$

(b) $\int g(x) dx = x + 2 + C_1 = x + C$

(c) $\int -f(x) dx = -(1 - \sqrt{x}) + C_1 = \sqrt{x} + C$

(d) $\int -g(x) dx = -(x + 2) + C_1 = -x + C$

(e) $\int [f(x) + g(x)] dx = (1 - \sqrt{x}) + (x + 2) + C_1 = x - \sqrt{x} + C$

(f) $\int [f(x) - g(x)] dx = (1 - \sqrt{x}) - (x + 2) + C_1 = -x - \sqrt{x} + C$

128. Yes. If $F(x)$ and $G(x)$ both solve the initial value problem on an interval I then they both have the same first derivative. Therefore, by Corollary 2 of the Mean Value Theorem there is a constant C such that $F(x) = G(x) + C$ for all x . In particular, $F(x_0) = G(x_0) + C$, so $C = F(x_0) - G(x_0) = 0$. Hence $F(x) = G(x)$ for all x .

129–132. Example CAS commands:

Maple:

```
with(student):
f := x -> cos(x)^2 + sin(x);
ic := [x=Pi,y=1];
F := unapply( int( f(x), x ) + C, x );
eq := eval( y=F(x), ic );
solnC := solve( eq, {C} );
Y := unapply( eval( F(x), solnC ), x );
DEplot( diff(y(x),x) = f(x), y(x), x=0..2*Pi, [[y(Pi)=1]],
        color=black, linecolor=black, stepsize=0.05, title="Section 4.8 #129" );
```

Mathematica: (functions and values may vary)

The following commands use the definite integral and the Fundamental Theorem of calculus to construct the solution of the initial value problems for Exercises 129-132.

```
Clear[x, y, yprime]
yprime[x_] = Cos[x]^2 + Sin[x];
initxvalue = Pi; inityvalue = 1;
y[x_] = Integrate[yprime[t], {t, initxvalue, x}] + inityvalue
```

If the solution satisfies the differential equation and initial condition, the following yield True

```
yprime[x]==D[y[x], x]//Simplify
y[initxvalue]==inityvalue
```

Since exercise 132 is a second order differential equation, two integrations will be required.

```
Clear[x, y, yprime]
y2prime[x_] = 3 Exp[x/2] + 1;
initxval = 0; inityval = 4; inityprimeval = -1;
yprime[x_] = Integrate[y2prime[t], {t, initxval, x}] + inityprimeval
y[x_] = Integrate[yprime[t], {t, initxval, x}] + inityval
```

Verify that $y[x]$ solves the differential equation and initial condition and plot the solution (red) and its derivative (blue).

```
y2prime[x]==D[y[x], {x, 2}]/Simplify
y[initxval]==inityval
yprime[initxval]==inityprimeval
Plot[{y[x], yprime[x]}, {x, initxval - 3, initxval + 3}, PlotStyle -> {RGBColor[1,0,0], RGBColor[0,0,1]}]
```

CHAPTER 4 PRACTICE EXERCISES

- No, since $f(x) = x^3 + 2x + \tan x \Rightarrow f'(x) = 3x^2 + 2 + \sec^2 x > 0 \Rightarrow f(x)$ is always increasing on its domain
- No, since $g(x) = \csc x + 2 \cot x \Rightarrow g'(x) = -\csc x \cot x - 2 \csc^2 x = -\frac{\cos x}{\sin^2 x} - \frac{2}{\sin^2 x} = -\frac{1}{\sin^2 x}(\cos x + 2) < 0$
 $\Rightarrow g(x)$ is always decreasing on its domain
- No absolute minimum because $\lim_{x \rightarrow \infty} (7+x)(11-3x)^{1/3} = -\infty$. Next $f'(x) = (11-3x)^{1/3} - (7+x)(11-3x)^{-2/3}$
 $= \frac{(11-3x)-(7+x)}{(11-3x)^{2/3}} = \frac{4(1-x)}{(11-3x)^{2/3}} \Rightarrow x = 1$ and $x = \frac{11}{3}$ are critical points. Since $f' > 0$ if $x < 1$ and $f' < 0$ if $x > 1$, $f(1) = 16$ is the absolute maximum.
- $f(x) = \frac{ax+b}{x^2-1} \Rightarrow f'(x) = \frac{a(x^2-1)-2x(ax+b)}{(x^2-1)^2} = \frac{-(ax^2+2bx+a)}{(x^2-1)^2}$; $f'(3) = 0 \Rightarrow -\frac{1}{64}(9a+6b+a) = 0 \Rightarrow 5a+3b = 0$. We require also that $f(3) = 1$. Thus $1 = \frac{3a+b}{8} \Rightarrow 3a+b = 8$. Solving both equations yields $a = 6$ and $b = -10$. Now, $f'(x) = \frac{-2(3x-1)(x-3)}{(x^2-1)^2}$ so that $f' = \begin{matrix} - & - & - & | & - & - & - & | & + & + & + & | & + & + & + & | & - & - & - & - \end{matrix}$. Thus f' changes sign at $x = 3$ from positive to negative so there is a local maximum at $x = 3$ which has a value $f(3) = 1$.
- $g(x) = e^x - x \Rightarrow g'(x) = e^x - 1 \Rightarrow g' = \begin{matrix} - & - & - & - & | & + & + & + & + \end{matrix}$
 \Rightarrow the graph is decreasing on $(-\infty, 0)$, increasing on $(0, \infty)$;
an absolute minimum value is 1 at $x = 0$; $x = 0$ is the only critical point of g ; there is no absolute maximum value
- $f(x) = \frac{2e^x}{1+x^2} \Rightarrow f'(x) = \frac{(1+x^2) \cdot 2e^x - 2e^x \cdot 2x}{(1+x^2)^2} = \frac{2e^x(1-x)^2}{(1+x^2)^2} \Rightarrow f' = \begin{matrix} + & + & + & | & + & + & + & + \end{matrix}$
 \Rightarrow the graph is increasing on $(-\infty, \infty)$;
 $x = 1$ is the only critical point of f ; there are no absolute maximum values or absolute minimum values.
- $f(x) = x - 2 \ln x$ on $1 \leq x \leq 3 \Rightarrow f'(x) = 1 - \frac{2}{x} \Rightarrow f' = \begin{matrix} - & - & - & | & + & + & + & | \end{matrix}$
 \Rightarrow the graph is decreasing on $(1, 2)$, increasing on $(2, 3)$; an absolute minimum value is $2 - 2 \ln 2$ at $x = 2$; an absolute maximum value is 1 at $x = 1$.
- $f(x) = \frac{4}{x} + \ln x^2$ on $1 \leq x \leq 4 \Rightarrow f'(x) = -\frac{4}{x^2} + \frac{2}{x} = \frac{2x-4}{x^2} \Rightarrow f' = \begin{matrix} - & - & - & | & + & + & + & | \end{matrix}$
 \Rightarrow the graph is decreasing on $(1, 2)$, increasing on $(2, 4)$; an absolute minimum value is $2 + \ln 4$ at $x = 2$; an absolute maximum value is 4 at $x = 1$.
- Yes, because at each point of $[0, 1)$ except $x = 0$, the function's value is a local minimum value as well as a local maximum value. At $x = 0$ the function's value, 0, is not a local minimum value because each open interval around $x = 0$ on the x -axis contains points to the left of 0 where f equals -1 .
- (a) The first derivative of the function $f(x) = x^3$ is zero at $x = 0$ even though f has no local extreme value at $x = 0$.
(b) Theorem 2 says only that if f is differentiable and f has a local extreme at $x = c$ then $f'(c) = 0$. It does not assert the (false) reverse implication $f'(c) = 0 \Rightarrow f$ has a local extreme at $x = c$.
- No, because the interval $0 < x < 1$ fails to be closed. The Extreme Value Theorem says that if the function is continuous throughout a finite closed interval $a \leq x \leq b$ then the existence of absolute extrema is guaranteed on that interval.

12. The absolute maximum is $|-1| = 1$ and the absolute minimum is $|0| = 0$. This is not inconsistent with the Extreme Value Theorem for continuous functions, which says a continuous function on a closed interval attains its extreme values on that interval. The theorem says nothing about the behavior of a continuous function on an interval which is half open and half closed, such as $[-1, 1)$, so there is nothing to contradict.

13. (a) There appear to be local minima at $x = -1.75$ and 1.8 . Points of inflection are indicated at approximately $x = 0$ and $x = \pm 1$.

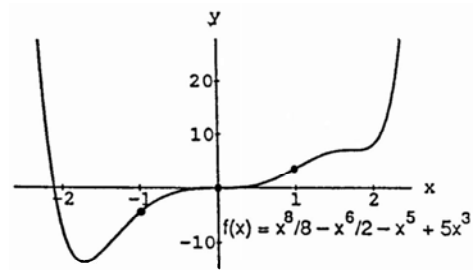

(b) $f'(x) = x^7 - 3x^5 - 5x^4 + 15x^2 = x^2(x^2 - 3)(x^3 - 5)$. The pattern $y' = \text{---} | \text{+++} | \text{+++} | \text{---} | \text{+++}$ indicates a local maximum at $x = \sqrt[3]{5}$ and local minima at $x = \pm\sqrt{3}$.

(c)

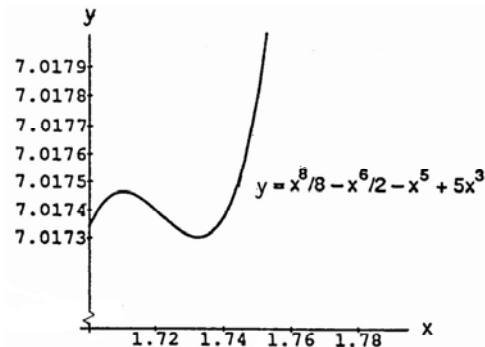

14. (a) The graph does not indicate any local extremum. Points of inflection are indicated at approximately $x = -\frac{3}{4}$ and $x = 1$.

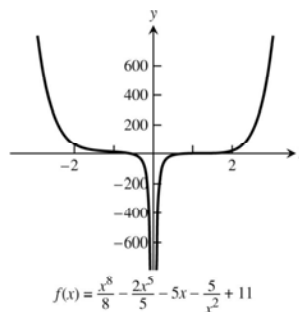

(b) $f'(x) = x^7 - 2x^4 - 5 + \frac{10}{x^3} = x^{-3}(x^3 - 2)(x^7 - 5)$. The pattern $f' = \text{---} | \text{+++} | \text{---} | \text{+++}$ indicates a local maximum at $x = \sqrt[3]{5}$ and a local minimum at $x = \sqrt[3]{2}$.

(c)

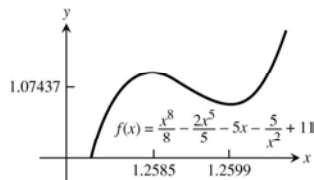

15. (a) $g(t) = \sin^2 t - 3t \Rightarrow g'(t) = 2 \sin t \cos t - 3 = \sin(2t) - 3 \Rightarrow g' < 0 \Rightarrow g(t)$ is always falling and hence must decrease on every interval in its domain.
 (b) One, since $\sin^2 t - 3t - 5 = 0$ and $\sin^2 t - 3t = 5$ have the same solutions: $f(t) = \sin^2 t - 3t - 5$ has the same derivative as $g(t)$ in part (a) and is always decreasing with $f(-3) > 0$ and $f(0) < 0$. The Intermediate Value Theorem guarantees the continuous function f has a root in $[-3, 0]$.
16. (a) $y = \tan \theta \Rightarrow \frac{dy}{d\theta} = \sec^2 \theta > 0 \Rightarrow y = \tan \theta$ is always rising on its domain $\Rightarrow y = \tan \theta$ increases on every interval in its domain
 (b) The interval $\left[\frac{\pi}{4}, \pi\right]$ is not in the tangent's domain because $\tan \theta$ is undefined at $\theta = \frac{\pi}{2}$. Thus the tangent need not increase on this interval.
17. (a) $f(x) = x^4 + 2x^2 - 2 \Rightarrow f'(x) = 4x^3 + 4x$. Since $f(0) = -2 < 0$, $f(1) = 1 > 0$ and $f'(x) \geq 0$ for $0 \leq x \leq 1$, we may conclude from the Intermediate Value Theorem that $f(x)$ has exactly one solution when $0 \leq x \leq 1$.
 (b) $x^2 = \frac{-2 \pm \sqrt{4+8}}{2} > 0 \Rightarrow x^2 = \sqrt{3} - 1$ and $x \geq 0 \Rightarrow x \approx \sqrt{.7320508076} \approx .8555996772$
18. (a) $y = \frac{x}{x+1} \Rightarrow y' = \frac{1}{(x+1)^2} > 0$, for all x in the domain of $\frac{x}{x+1} \Rightarrow y = \frac{x}{x+1}$ is increasing in every interval in its domain.
 (b) $y = x^3 + 2x \Rightarrow y' = 3x^2 + 2 > 0$ for all $x \Rightarrow$ the graph of $y = x^3 + 2x$ is always increasing and can never have a local maximum or minimum
19. Let $V(t)$ represent the volume of the water in the reservoir at time t , in minutes, let $V(0) = a_0$ be the initial amount and $V(1440) = a_0 + (1400)(43,560)(7.58)$ gallons be the amount of water contained in the reservoir after the rain, where 24 hr = 1440 min. Assume that $V(t)$ is continuous on $[0, 1440]$ and differentiable on $(0, 1440)$. The Mean Value Theorem says that for some t_0 in $(0, 1440)$ we have $V'(t_0) = \frac{V(1440) - V(0)}{1440 - 0} = \frac{a_0 + (1400)(43,560)(7.48) - a_0}{1440} = \frac{456,160,320 \text{ gal}}{1440 \text{ min}} = 316,778 \text{ gal/min}$. Therefore at t_0 the reservoir's volume was increasing at a rate in excess of 225,000 gal/min.
20. Yes, all differentiable functions $g(x)$ having 3 as a derivative differ by only a constant. Consequently, the difference $3x - g(x)$ is a constant K because $g'(x) = 3 = \frac{d}{dx}(3x)$. Thus $g(x) = 3x + K$, the same form as $F(x)$.
21. No, $\frac{x}{x+1} = 1 + \frac{-1}{x+1} \Rightarrow \frac{x}{x+1}$ differs from $\frac{-1}{x+1}$ by the constant 1. Both functions have the same derivative $\frac{d}{dx}\left(\frac{x}{x+1}\right) = \frac{(x+1) - x(1)}{(x+1)^2} = \frac{1}{(x+1)^2} = \frac{d}{dx}\left(\frac{-1}{x+1}\right)$.
22. $f'(x) = g'(x) = \frac{2x}{(x^2+1)^2} \Rightarrow f(x) - g(x) = C$ for some constant $C \Rightarrow$ the graphs differ by a vertical shift.
23. The global minimum value of $\frac{1}{2}$ occurs at $x = 2$.
24. (a) The function is increasing on the intervals $[-3, -2]$ and $[1, 2]$.
 (b) The function is decreasing on the intervals $[-2, 0]$ and $(0, 1]$.
 (c) The local maximum values occur only at $x = -2$, and at $x = 2$; local minimum values occur at $x = -3$ and at $x = 1$ provided f is continuous at $x = 0$.
25. (a) $t = 0, 6, 12$ (b) $t = 3, 9$ (c) $6 < t < 12$ (d) $0 < t < 6, 12 < t < 14$
26. (a) $t = 4$ (b) at no time (c) $0 < t < 4$ (d) $4 < t < 8$

27.

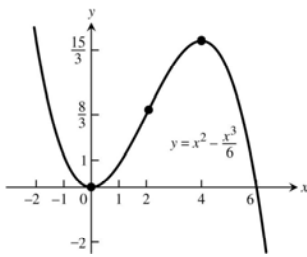

28.

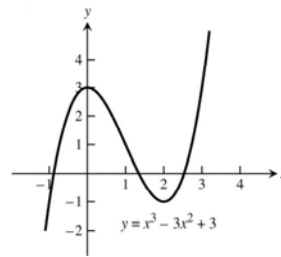

29.

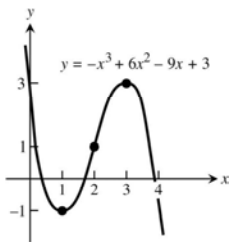

30.

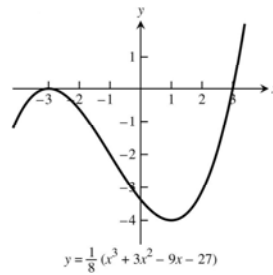

31.

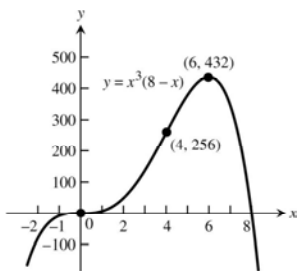

32.

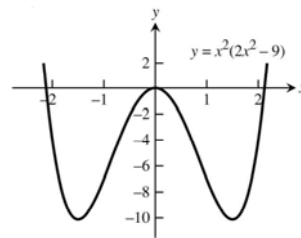

33.

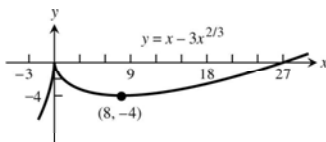

34.

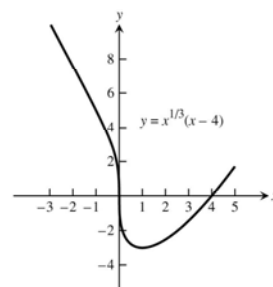

35.

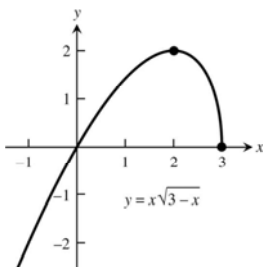

36.

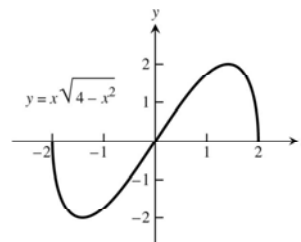

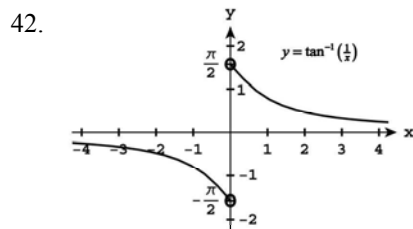
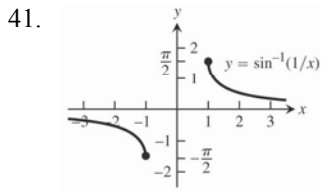
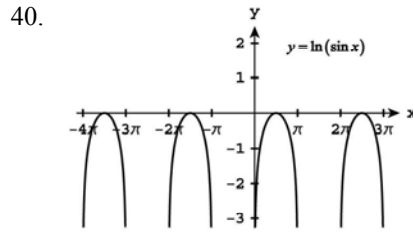
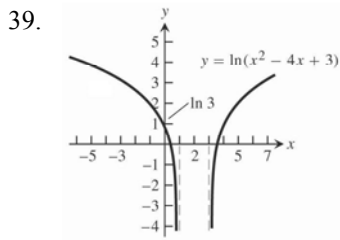
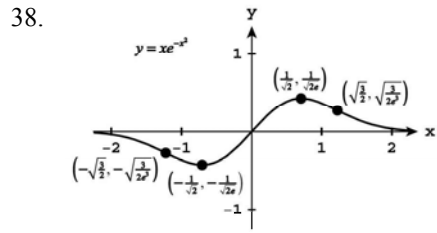
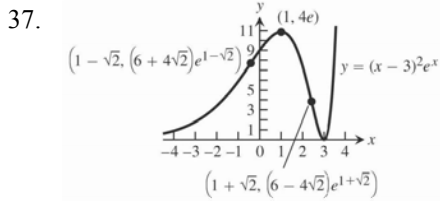

43. (a) $y' = 16 - x^2 \Rightarrow y' = - - - | + + + | - - - \Rightarrow$ the curve is rising on $(-4, 4)$, falling on $(-\infty, -4)$ and $(4, \infty)$
 \Rightarrow a local maximum at $x = 4$ and a local minimum at $x = -4$; $y'' = -2x \Rightarrow y'' = + + + | - - - \Rightarrow$ the curve is
 concave up on $(-\infty, 0)$, concave down on $(0, \infty) \Rightarrow$ a point of inflection at $x = 0$

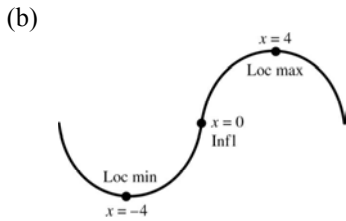

44. (a) $y' = x^2 - x - 6 = (x-3)(x+2) \Rightarrow y' = + + + | - - - | + + + \Rightarrow$ the curve is rising on $(-\infty, -2)$ and $(3, \infty)$,
 falling on $(-2, 3) \Rightarrow$ local maximum at $x = -2$ and a local minimum at $x = 3$; $y'' = 2x - 1 \Rightarrow y'' = - - - | + + +$
 \Rightarrow concave up on $(\frac{1}{2}, \infty)$, concave down on $(-\infty, \frac{1}{2}) \Rightarrow$ a point of inflection at $x = \frac{1}{2}$

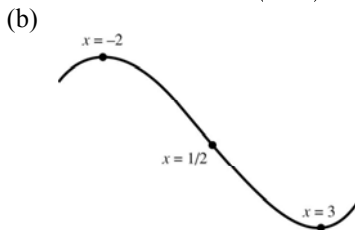

45. (a) $y' = 6x(x+1)(x-2) = 6x^3 - 6x^2 - 12x \Rightarrow y' = \begin{matrix} - & - & - & | & + & + & + & | & - & - & - & | & + & + & + \end{matrix} \Rightarrow$ the graph is rising on $(-1, 0)$ and $(2, \infty)$, falling on $(-\infty, -1)$ and $(0, 2) \Rightarrow$ a local maximum at $x = 0$, local minima at $x = -1$ and $x = 2$; $y'' = 18x^2 - 12x - 12 = 6(3x^2 - 2x - 2) = 6\left(x - \frac{1-\sqrt{7}}{3}\right)\left(x - \frac{1+\sqrt{7}}{3}\right) \Rightarrow y'' = \begin{matrix} + & + & + & | & - & - & - & | & + & + & + \end{matrix}$
 \Rightarrow the curve is concave up on $\left(-\infty, \frac{1-\sqrt{7}}{3}\right)$ and $\left(\frac{1+\sqrt{7}}{3}, \infty\right)$, concave down on $\left(\frac{1-\sqrt{7}}{3}, \frac{1+\sqrt{7}}{3}\right) \Rightarrow$ points of inflection at $x = \frac{1 \pm \sqrt{7}}{3}$

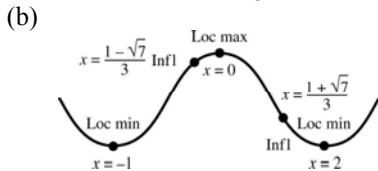

46. (a) $y' = x^2(6-4x) = 6x^2 - 4x^3 \Rightarrow y' = \begin{matrix} + & + & + & | & + & + & + & | & - & - & - \end{matrix} \Rightarrow$ the curve is rising on $(-\infty, \frac{3}{2})$, falling on $(\frac{3}{2}, \infty) \Rightarrow$ a local maximum at $x = \frac{3}{2}$; $y'' = 12x - 12x^2 = 12x(1-x) \Rightarrow y'' = \begin{matrix} - & - & - & | & + & + & + & | & - & - & - \end{matrix} \Rightarrow$ concave up on $(0, 1)$, concave down on $(-\infty, 0)$ and $(1, \infty) \Rightarrow$ points of inflection at $x = 0$ and $x = 1$

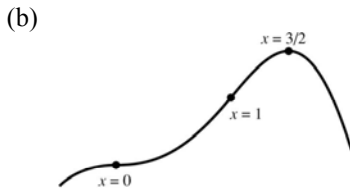

47. (a) $y' = x^4 - 2x^2 = x^2(x^2 - 2) \Rightarrow y' = \begin{matrix} + & + & + & | & - & - & - & | & - & - & - & | & + & + & + \end{matrix} \Rightarrow$ the curve is rising on $(-\infty, -\sqrt{2})$ and $(\sqrt{2}, \infty)$, falling on $(-\sqrt{2}, \sqrt{2}) \Rightarrow$ a local maximum at $x = -\sqrt{2}$ and a local minimum at $x = \sqrt{2}$; $y'' = 4x^3 - 4x = 4x(x-1)(x+1) \Rightarrow y'' = \begin{matrix} - & - & - & | & + & + & + & | & - & - & - & | & + & + & + \end{matrix} \Rightarrow$ concave up on $(-1, 0)$ and $(1, \infty)$, concave down on $(-\infty, -1)$ and $(0, 1) \Rightarrow$ points of inflection at $x = 0$ and $x = \pm 1$

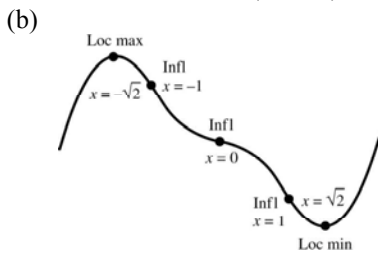

48. (a) $y' = 4x^2 - x^4 = x^2(4-x^2) \Rightarrow y' = \begin{matrix} - & - & - & | & + & + & + & | & + & + & + & | & - & - & - \end{matrix} \Rightarrow$ the curve is rising on $(-2, 0)$ and $(0, 2)$, falling on $(-\infty, -2)$ and $(2, \infty) \Rightarrow$ a local maximum at $x = 2$, a local minimum at $x = -2$; $y'' = 8x - 4x^3 = 4x(2-x^2) \Rightarrow y'' = \begin{matrix} + & + & + & | & - & - & - & | & + & + & + & | & - & - & - \end{matrix} \Rightarrow$ concave up on $(-\infty, -\sqrt{2})$ and $(0, \sqrt{2})$, concave down on $(-\sqrt{2}, 0)$ and $(\sqrt{2}, \infty) \Rightarrow$ points of inflection at $x = 0$ and $x = \pm\sqrt{2}$

(b)

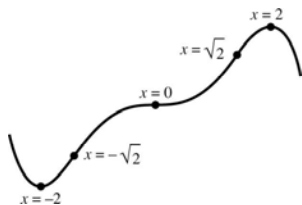

49. The values of the first derivative indicate that the curve is rising on $(0, \infty)$ and falling on $(-\infty, 0)$. The slope of the curve approaches $-\infty$ as $x \rightarrow 0^-$, and approaches ∞ as $x \rightarrow 0^+$ and $x \rightarrow 1$. The curve should therefore have a cusp and local minimum at $x = 0$, and a vertical tangent at $x = 1$.

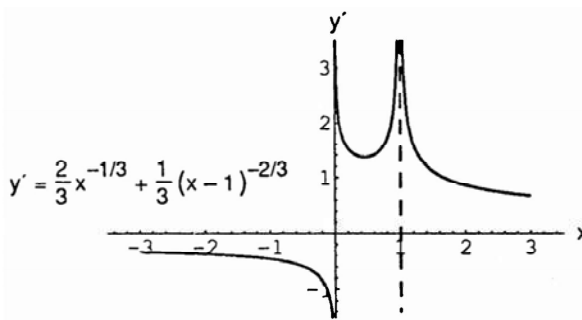
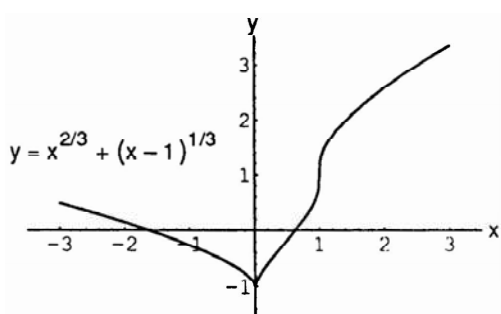

50. The values of the first derivative indicate that the curve is rising on $(0, \frac{1}{2})$ and $(1, \infty)$, and falling on $(-\infty, 0)$ and $(\frac{1}{2}, 1)$. The derivative changes from positive to negative at $x = \frac{1}{2}$, indicating a local maximum there. The slope of the curve approaches $-\infty$ as $x \rightarrow 0^-$ and $x \rightarrow 1^-$, and approaches ∞ as $x \rightarrow 0^+$ and as $x \rightarrow 1^+$, indicating cusps and local minima at both $x = 0$ and $x = 1$.

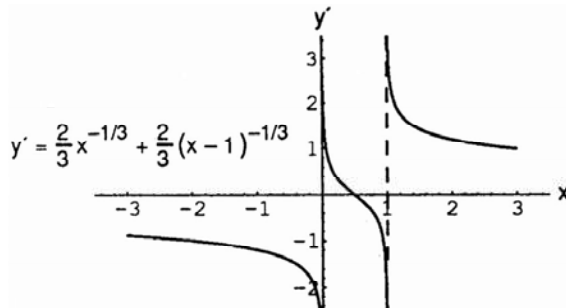
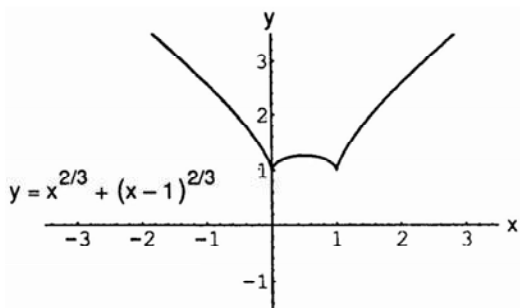

51. The values of the first derivative indicate that the curve is always rising. The slope of the curve approaches ∞ as $x \rightarrow 0$ and as $x \rightarrow 1$, indicating vertical tangents at both $x = 0$ and $x = 1$.

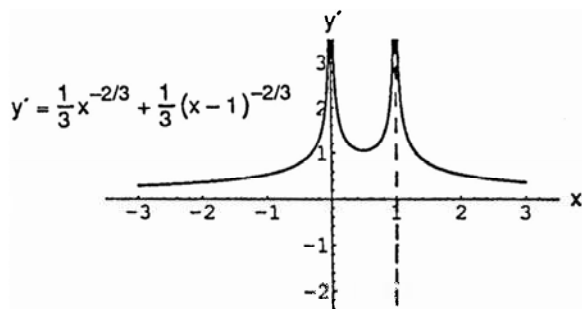
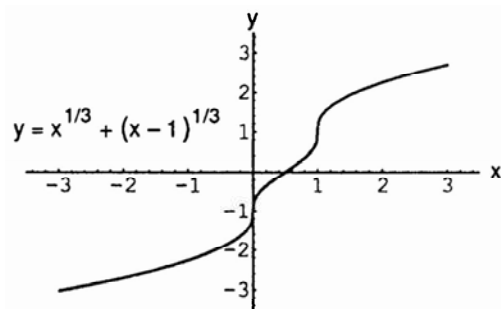

52. The graph of the first derivative indicates that the curve is rising on $(0, \frac{17-\sqrt{33}}{16})$ and $(\frac{17+\sqrt{33}}{16}, \infty)$, falling on $(-\infty, 0)$ and $(\frac{17-\sqrt{33}}{16}, \frac{17+\sqrt{33}}{16}) \Rightarrow$ a local maximum at $x = \frac{17-\sqrt{33}}{16}$, a local minimum at $x = \frac{17+\sqrt{33}}{16}$. The derivative approaches $-\infty$ as $x \rightarrow 0^-$ and $x \rightarrow 1$, and approaches ∞ as $x \rightarrow 0^+$, indicating a cusp and local minimum at $x = 0$ and a vertical tangent at $x = 1$.

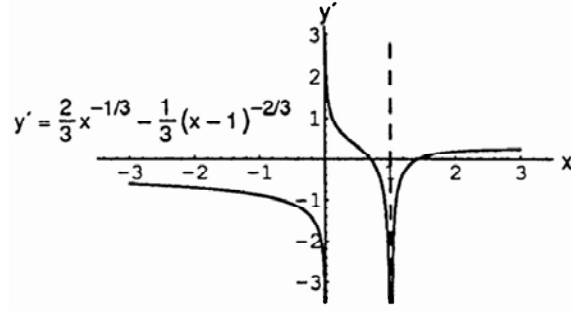
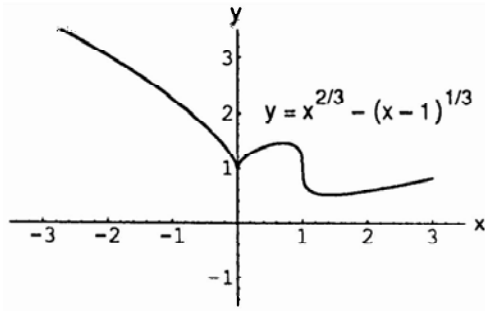

53. $y = \frac{x+1}{x-3} = 1 + \frac{4}{x-3}$

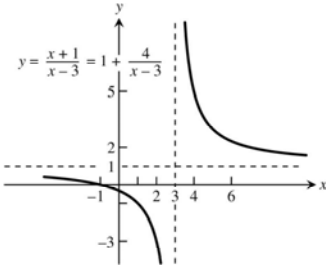

54. $y = \frac{2x}{x+5} = 2 - \frac{10}{x+5}$

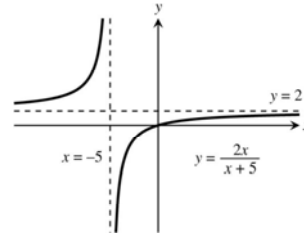

55. $y = \frac{x^2+1}{x} = x + \frac{1}{x}$

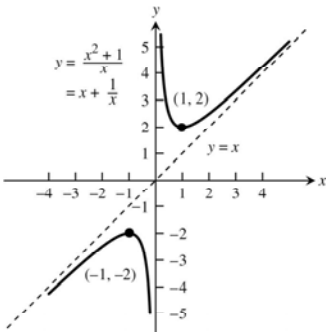

56. $y = \frac{x^2-x+1}{x} = x - 1 + \frac{1}{x}$

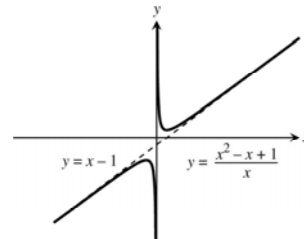

57. $y = \frac{x^3+2}{2x} = \frac{x^2}{2} + \frac{1}{x}$

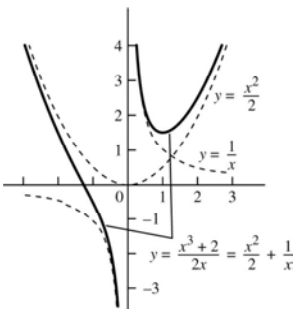

58. $y = \frac{x^4-1}{x^2} = x^2 - \frac{1}{x^2}$

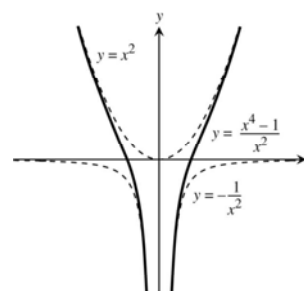

59. $y = \frac{x^2-4}{x^2-3} = 1 - \frac{1}{x^2-3}$

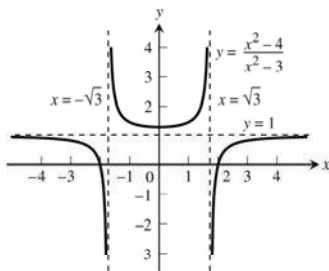

60. $y = \frac{x^2}{x^2-4} = 1 + \frac{4}{x^2-4}$

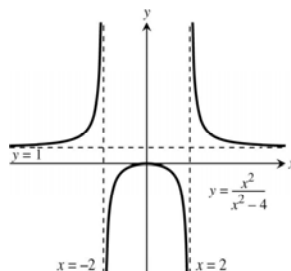

61. $\lim_{x \rightarrow 1} \frac{x^2+3x-4}{x-1} = \lim_{x \rightarrow 1} \frac{2x+3}{1} = 5$

62. $\lim_{x \rightarrow 1} \frac{x^a-1}{x^b-1} = \lim_{x \rightarrow 1} \frac{ax^{a-1}}{bx^{b-1}} = \frac{a}{b}$

63. $\lim_{x \rightarrow \pi} \frac{\tan x}{x} = \frac{\tan \pi}{\pi} = 0$

64. $\lim_{x \rightarrow 0} \frac{\tan x}{x+\sin x} = \lim_{x \rightarrow 0} \frac{\sec^2 x}{1+\cos x} = \frac{1}{1+1} = \frac{1}{2}$

65. $\lim_{x \rightarrow 0} \frac{\sin^2 x}{\tan(x^2)} = \lim_{x \rightarrow 0} \frac{2 \sin x \cdot \cos x}{2x \sec^2(x^2)} = \lim_{x \rightarrow 0} \frac{\sin(2x)}{2x \sec^2(x^2)} = \lim_{x \rightarrow 0} \frac{2 \cos(2x)}{2x(2 \sec^2(x^2) \tan(x^2) \cdot 2x) + 2 \sec^2(x^2)} = \frac{2}{0+2 \cdot 1} = 1$

66. $\lim_{x \rightarrow 0} \frac{\sin(mx)}{\sin(nx)} = \lim_{x \rightarrow 0} \frac{m \cos(mx)}{n \cos(nx)} = \frac{m}{n}$

67. $\lim_{x \rightarrow \pi/2^-} \sec(7x) \cos(3x) = \lim_{x \rightarrow \pi/2^-} \frac{\cos(3x)}{\cos(7x)} = \lim_{x \rightarrow \pi/2^-} \frac{-3 \sin(3x)}{-7 \sin(7x)} = \frac{3}{7}$

68. $\lim_{x \rightarrow 0^+} \sqrt{x} \sec x = \lim_{x \rightarrow 0^+} \frac{\sqrt{x}}{\cos x} = \frac{0}{1} = 0$

69. $\lim_{x \rightarrow 0} (\csc x - \cot x) = \lim_{x \rightarrow 0} \frac{1-\cos x}{\sin x} = \lim_{x \rightarrow 0} \frac{\sin x}{\cos x} = \frac{0}{1} = 0$

70. $\lim_{x \rightarrow 0} \left(\frac{1}{x^4} - \frac{1}{x^2} \right) = \lim_{x \rightarrow 0} \left(\frac{1-x^2}{x^4} \right) = \lim_{x \rightarrow 0} (1-x^2) \cdot \frac{1}{x^4} = \lim_{x \rightarrow 0} (1-x^2) = \lim_{x \rightarrow 0} \frac{1}{x^4} = 1 \cdot \infty = \infty$

71. $\lim_{x \rightarrow \infty} \left(\sqrt{x^2+x+1} - \sqrt{x^2-x} \right) = \lim_{x \rightarrow \infty} \left(\sqrt{x^2+x+1} - \sqrt{x^2-x} \right) \cdot \frac{\sqrt{x^2+x+1} + \sqrt{x^2-x}}{\sqrt{x^2+x+1} + \sqrt{x^2-x}} = \lim_{x \rightarrow \infty} \frac{2x+1}{\sqrt{x^2+x+1} + \sqrt{x^2-x}}$

Notice that $x = \sqrt{x^2}$ for $x > 0$ so this is equivalent to

$$= \lim_{x \rightarrow \infty} \frac{\frac{2x+1}{x}}{\sqrt{\frac{x^2+x+1}{x^2} + \sqrt{\frac{x^2-x}{x^2}}} = \lim_{x \rightarrow \infty} \frac{2+\frac{1}{x}}{\sqrt{1+\frac{1}{x}+\frac{1}{x^2}} + \sqrt{1-\frac{1}{x}}} = \frac{2}{\sqrt{1} + \sqrt{1}} = 1$$

72. $\lim_{x \rightarrow \infty} \left(\frac{x^3}{x^2-1} - \frac{x^3}{x^2+1} \right) = \lim_{x \rightarrow \infty} \frac{x^3(x^2+1) - x^3(x^2-1)}{(x^2-1)(x^2+1)} = \lim_{x \rightarrow \infty} \frac{2x^3}{x^4-1} = \lim_{x \rightarrow \infty} \frac{6x^2}{4x^3} = \lim_{x \rightarrow \infty} \frac{12x}{12x^2} = \lim_{x \rightarrow \infty} \frac{12}{24x} = \lim_{x \rightarrow \infty} \frac{1}{2x} = 0$

73. The limit leads to the indeterminate form $\frac{0}{0}$: $\lim_{x \rightarrow 0} \frac{10^x-1}{x} = \lim_{x \rightarrow 0} \frac{(\ln 10)10^x}{1} = \ln 10$

74. The limit leads to the indeterminate form $\frac{0}{0}$: $\lim_{\theta \rightarrow 0} \frac{3^\theta - 1}{\theta} = \lim_{\theta \rightarrow 0} \frac{(\ln 3)3^\theta}{1} = \ln 3$
75. The limit leads to the indeterminate form $\frac{0}{0}$: $\lim_{x \rightarrow 0} \frac{2^{-\sin x} - 1}{e^x - 1} = \lim_{x \rightarrow 0} \frac{2^{-\sin x}(\ln 2)(-\cos x)}{e^x} = \ln 2$
76. The limit leads to the indeterminate form $\frac{0}{0}$: $\lim_{x \rightarrow 0} \frac{2^{-\sin x} - 1}{e^x - 1} = \lim_{x \rightarrow 0} \frac{2^{-\sin x}(\ln 2)(-\cos x)}{e^x} = -\ln 2$
77. The limit leads to the indeterminate form $\frac{0}{0}$: $\lim_{x \rightarrow 0} \frac{5 - 5\cos x}{e^x - x - 1} = \lim_{x \rightarrow 0} \frac{5\sin x}{e^x - 1} = \lim_{x \rightarrow 0} \frac{5\cos x}{e^x} = 5$
78. The limit leads to the indeterminate form $\frac{0}{0}$: $\lim_{x \rightarrow 0} \frac{4 - 4e^x}{xe^x} = \lim_{x \rightarrow 0} \frac{-4e^x}{e^x + xe^x} = -4$
79. The limit leads to the indeterminate form $\frac{0}{0}$: $\lim_{t \rightarrow 0^+} \frac{t - \ln(1+2t)}{t^2} = \lim_{t \rightarrow 0^+} \frac{(1 - \frac{2}{1+2t})}{2t} = -\infty$
80. The limit leads to the indeterminate form $\frac{0}{0}$:

$$\lim_{x \rightarrow 4} \frac{\sin^2(\pi x)}{e^{x-4} + 3 - x} = \lim_{x \rightarrow 4} \frac{2\pi(\sin \pi x)(\cos \pi x)}{e^{x-4} - 1} = \lim_{x \rightarrow 4} \frac{\pi \sin(2\pi x)}{e^{x-4} - 1} = \lim_{x \rightarrow 4} \frac{2\pi^2 \cos(2\pi x)}{e^{x-4}} = 2\pi^2$$
81. The limit leads to the indeterminate form $\frac{0}{0}$: $\lim_{t \rightarrow 0^+} \left(\frac{e^t}{t} - \frac{1}{t} \right) = \lim_{t \rightarrow 0^+} \left(\frac{e^t - 1}{t} \right) = \lim_{t \rightarrow 0^+} \frac{e^t}{1} = 1$
82. The limit leads to the indeterminate form $\frac{\infty}{\infty}$: $\lim_{y \rightarrow 0^+} e^{-1/y} \ln y = \lim_{y \rightarrow 0^+} \frac{\ln y}{e^{y^{-1}}} = \lim_{y \rightarrow 0^+} \frac{y^{-1}}{-e^{y^{-1}}(y^{-2})} = -\lim_{y \rightarrow 0^+} \frac{y}{e^{y^{-1}}} = 0$
83. $\lim_{x \rightarrow \infty} \left(1 + \frac{b}{x}\right)^{kx} = \lim_{x \rightarrow \infty} \left[\left(1 + \frac{1}{x/b}\right)^{x/b} \right]^{bk} = e^{bk}$
84. $\lim_{x \rightarrow \infty} \left(1 + \frac{2}{x} + \frac{7}{x^2}\right) = 1 + 0 + 0 = 1$
85. (a) Maximize $f(x) = \sqrt{x} - \sqrt{36-x} = x^{1/2} - (36-x)^{1/2}$ where $0 \leq x \leq 36$
 $\Rightarrow f'(x) = \frac{1}{2}x^{-1/2} - \frac{1}{2}(36-x)^{-1/2}(-1) = \frac{\sqrt{36-x} + \sqrt{x}}{2\sqrt{x}\sqrt{36-x}} \Rightarrow$ derivative fails to exist at 0 and 36; $f(0) = -6$, and $f(36) = 6 \Rightarrow$ the numbers are 0 and 36
- (b) Maximize $g(x) = \sqrt{x} + \sqrt{36-x} = x^{1/2} + (36-x)^{1/2}$ where $0 \leq x \leq 36 \Rightarrow g'(x) = \frac{1}{2}x^{-1/2} + \frac{1}{2}(36-x)^{-1/2}(-1) = \frac{\sqrt{36-x} - \sqrt{x}}{2\sqrt{x}\sqrt{36-x}} \Rightarrow$ critical points at 0, 18 and 36; $g(0) = 6$, $g(18) = 2\sqrt{18} = 6\sqrt{2}$ and $g(36) = 6 \Rightarrow$ the numbers are 18 and 18
86. (a) Maximize $f(x) = \sqrt{x}(20-x) = 20x^{1/2} - x^{3/2}$ where $0 \leq x \leq 20 \Rightarrow f'(x) = 10x^{-1/2} - \frac{3}{2}x^{1/2} = \frac{20-3x}{2\sqrt{x}} = 0$
 $\Rightarrow x = 0$ and $x = \frac{20}{3}$ are critical points; $f(0) = f(20) = 0$ and $f\left(\frac{20}{3}\right) = \sqrt{\frac{20}{3}}\left(20 - \frac{20}{3}\right) = \frac{40\sqrt{20}}{3\sqrt{3}} \Rightarrow$ the numbers are $\frac{20}{3}$ and $\frac{40}{3}$.

(b) Maximize $g(x) = x + \sqrt{20-x} = x + (20-x)^{1/2}$ where $0 \leq x \leq 20 \Rightarrow g'(x) = \frac{2\sqrt{20-x}-1}{2\sqrt{20-x}} = 0 \Rightarrow \sqrt{20-x} = \frac{1}{2}$
 $\Rightarrow x = \frac{79}{4}$. The critical points are $x = \frac{79}{4}$ and $x = 20$. Since $g\left(\frac{79}{4}\right) = \frac{81}{4}$ and $g(20) = 20$, the numbers must be $\frac{79}{4}$ and $\frac{1}{4}$.

87. $A(x) = \frac{1}{2}(2x)(27-x^2)$ for $0 \leq x \leq \sqrt{27}$
 $\Rightarrow A'(x) = 3(3+x)(3-x)$ and $A''(x) = -6x$. The critical points are -3 and 3 , but -3 is not in the domain. Since $A''(3) = -18 < 0$ and $A(\sqrt{27}) = 0$, the maximum occurs at $x = 3 \Rightarrow$ the largest area is $A(3) = 54$ sq units.

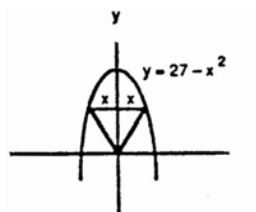

88. The volume is $V = x^2h = 32 \Rightarrow h = \frac{32}{x^2}$. The surface area is $S(x) = x^2 + 4x\left(\frac{32}{x^2}\right) = x^2 + \frac{128}{x}$, where $x > 0$
 $\Rightarrow S'(x) = \frac{2(x-4)(x^2+4x+16)}{x^2} \Rightarrow$ the critical points are 0 and 4 , but 0 is not in the domain. Now $S''(4) = 2 + \frac{256}{4^3} > 0 \Rightarrow$ at $x = 4$ there is a minimum. The dimensions 4 ft by 4 ft by 2 ft minimize the surface area.

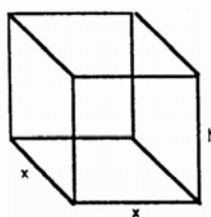

89. From the diagram we have $\left(\frac{h}{2}\right)^2 + r^2 = (\sqrt{3})^2$
 $\Rightarrow r^2 = \frac{12-h^2}{4}$. The volume of the cylinder is $V = \pi r^2 h = \pi\left(\frac{12-h^2}{4}\right)h = \frac{\pi}{4}(12h-h^3)$, where $0 \leq h \leq 2\sqrt{3}$. Then $V'(h) = \frac{3\pi}{4}(2+h)(2-h) \Rightarrow$ the critical points are -2 and 2 , but -2 is not in the domain. At $h = 2$ there is a maximum since $V''(2) = -3\pi < 0$. The dimensions of the largest cylinder are radius $= \sqrt{2}$ and height $= 2$.

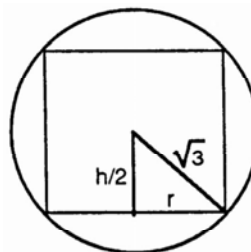

90. From the diagram we have $x =$ radius and $y =$ height $= 12 - 2x$ and $V(x) = \frac{1}{3}\pi x^2(12 - 2x)$, where $0 \leq x \leq 6$
 $\Rightarrow V'(x) = 2\pi x(4-x)$ and $V''(4) = -8\pi$. The critical points are 0 and 4 ; $V(0) = V(6) = 0 \Rightarrow x = 4$ gives the maximum. Thus the values of $r = 4$ and $h = 4$ yield the largest volume for the smaller cone.

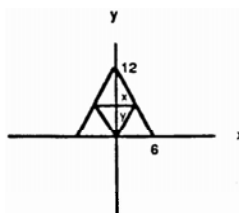

91. The profit $P = 2px + py = 2px + p\left(\frac{40-10x}{5-x}\right)$, where p is the profit on grade B tires and $0 \leq x \leq 4$. Thus $P'(x) = \frac{2p}{(5-x)^2}(x^2 - 10x + 20) \Rightarrow$ the critical points are $(5 - \sqrt{5})$, 5 , and $(5 + \sqrt{5})$, but only $(5 - \sqrt{5})$ is in the domain. Now $P'(x) > 0$ for $0 < x < (5 - \sqrt{5})$ and $P'(x) < 0$ for $(5 - \sqrt{5}) < x < 4 \Rightarrow$ at $x = (5 - \sqrt{5})$ there is a local maximum. Also $P(0) = 8p$, $P(5 - \sqrt{5}) = 4p(5 - \sqrt{5}) \approx 11p$, and $P(4) = 8p \Rightarrow$ at $x = (5 - \sqrt{5})$ there is an absolute maximum. The maximum occurs when $x = (5 - \sqrt{5})$ and $y = 2(5 - \sqrt{5})$, the units are hundreds of tires, i.e., $x \approx 276$ tires and $y \approx 553$ tires.

92. (a) The distance between the particles is $|f(t)|$ where $f(t) = -\cos t + \cos\left(t + \frac{\pi}{4}\right)$. Then, $f'(t) = \sin t - \sin\left(t + \frac{\pi}{4}\right)$. Solving $f'(t) = 0$ graphically, we obtain $t \approx 1.178$, $t \approx 4.320$, and so on.

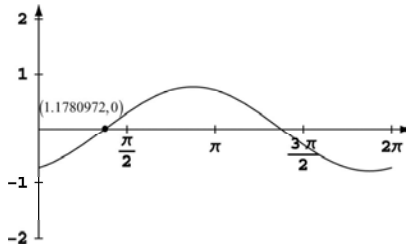

Alternatively, $f'(t) = 0$ may be solved analytically as follows. $f'(t) = \sin\left[\left(t + \frac{\pi}{8}\right) - \frac{\pi}{8}\right] - \sin\left[\left(t + \frac{\pi}{8}\right) + \frac{\pi}{8}\right]$
 $= \left[\sin\left(t + \frac{\pi}{8}\right)\cos\frac{\pi}{8} - \cos\left(t + \frac{\pi}{8}\right)\sin\frac{\pi}{8}\right] - \left[\sin\left(t + \frac{\pi}{8}\right)\cos\frac{\pi}{8} + \cos\left(t + \frac{\pi}{8}\right)\sin\frac{\pi}{8}\right] = -2\sin\frac{\pi}{8}\cos\left(t + \frac{\pi}{8}\right)$ so the critical points occur when $\cos\left(t + \frac{\pi}{8}\right) = 0$, or $t = \frac{3\pi}{8} + k\pi$. At each of these values, $f(t) = \pm\cos\frac{3\pi}{8} \approx \pm 0.765$ units, so the maximum distance between the particles is 0.765 units.

- (b) Solving $\cos t = \cos\left(t + \frac{\pi}{4}\right)$ graphically, we obtain $t \approx 2.749$, $t \approx 5.890$, and so on.

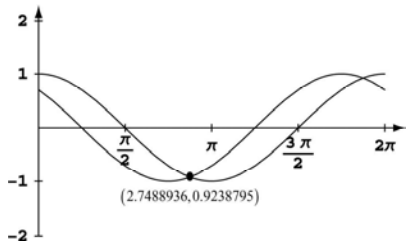

Alternatively, this problem can be solved analytically as follows.

$$\begin{aligned} \cos t &= \cos\left(t + \frac{\pi}{4}\right) \\ \cos\left[\left(t + \frac{\pi}{8}\right) - \frac{\pi}{8}\right] &= \cos\left[\left(t + \frac{\pi}{8}\right) + \frac{\pi}{8}\right] \\ \cos\left(t + \frac{\pi}{8}\right)\cos\frac{\pi}{8} + \sin\left(t + \frac{\pi}{8}\right)\sin\frac{\pi}{8} &= \cos\left(t + \frac{\pi}{8}\right)\cos\frac{\pi}{8} - \sin\left(t + \frac{\pi}{8}\right)\sin\frac{\pi}{8} \\ 2\sin\left(t + \frac{\pi}{8}\right)\sin\frac{\pi}{8} &= 0 \\ \sin\left(t + \frac{\pi}{8}\right) &= 0; \quad t = \frac{7\pi}{8} + k\pi \end{aligned}$$

The particles collide when $t = \frac{7\pi}{8} \approx 2.749$. (Plus multiples of π if they keep going.)

93. The dimensions will be x in. by $10 - 2x$ in. by $16 - 2x$ in., so $V(x) = x(10 - 2x)(16 - 2x) = 4x^3 - 52x^2 + 160x$ for $0 < x < 5$. Then $V'(x) = 12x^2 - 104x + 160 = 4(x - 2)(3x - 20)$, so the critical point in the correct domain is $x = 2$. This critical point corresponds to the maximum possible volume because $V'(x) > 0$ for $0 < x < 2$ and $V'(x) < 0$ for $2 < x < 5$. The box of largest volume has a height of 2 in. and a base measuring 6 in. by 12 in., and its volume is 144 in.^3

Graphical support:

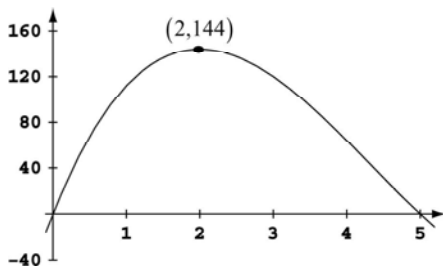

94. The length of the ladder is $d_1 + d_2 = 8 \sec \theta + 6 \csc \theta$.
 We wish to maximize $I(\theta) = 8 \sec \theta + 6 \csc \theta$
 $\Rightarrow I'(\theta) = 8 \sec \theta \tan \theta - 6 \csc \theta \cot \theta$. Then $I'(\theta) = 0$
 $\Rightarrow 8 \sin^3 \theta - 6 \cos^3 \theta = 0 \Rightarrow \tan \Rightarrow \theta = \frac{\sqrt[3]{6}}{2}$
 $\Rightarrow d_1 = 4\sqrt{4 + \sqrt[3]{36}}$ and $d_2 = \sqrt[3]{36}\sqrt{4 + \sqrt[3]{36}} \Rightarrow$ the
 length of the ladder is about $(4 + \sqrt[3]{36})\sqrt{4 + \sqrt[3]{36}}$
 $= (4 + \sqrt[3]{36})^{3/2} \approx 19.7$ ft.

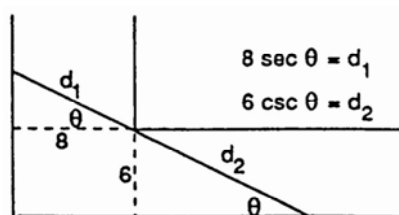

95. $g(x) = 3x - x^3 + 4 \Rightarrow g(2) = 2 > 0$ and $g(3) = -14 < 0 \Rightarrow g(x) = 0$ in the interval $[2, 3]$ by the Intermediate Value Theorem. Then $g'(x) = 3 - 3x^2 \Rightarrow x_{n+1} = x_n - \frac{3x_n - x_n^3 + 4}{3 - 3x_n^2}$; $x_0 = 2 \Rightarrow x_1 = 2.22 \Rightarrow x_2 = 2.196215$, and so forth to $x_5 = 2.195823345$.
96. $g(x) = x^4 - x^3 - 75 \Rightarrow g(3) = -21 < 0$ and $g(4) = 117 > 0 \Rightarrow g(x) = 0$ in the interval $[3, 4]$ by the Intermediate Value Theorem. Then $g'(x) = 4x^3 - 3x^2 \Rightarrow x_{n+1} = x_n - \frac{x_n^4 - x_n^3 - 75}{4x_n^3 - 3x_n^2}$; $x_0 = 3 \Rightarrow x_1 = 3.259259 \Rightarrow x_2 = 3.229050$, and so forth to $x_5 = 3.22857729$.

97. $\int (x^3 + 5x - 7) dx = \frac{x^4}{4} + \frac{5x^2}{2} - 7x + C$

98. $\int (8t^3 - \frac{t^2}{2} + t) dt = \frac{8t^4}{4} - \frac{t^3}{6} + \frac{t^2}{2} + C = 2t^4 - \frac{t^3}{6} + \frac{t^2}{2} + C$

99. $\int (3\sqrt{t} + \frac{4}{t^2}) dt = \int (3t^{1/2} + 4t^{-2}) dt = \frac{3t^{3/2}}{3/2} + \frac{4t^{-1}}{-1} + C = 2t^{3/2} - \frac{4}{t} + C$

100. $\int (\frac{1}{2\sqrt{t}} - \frac{3}{t^4}) dt = \int (\frac{1}{2}t^{-1/2} - 3t^{-4}) dt = \frac{1}{2}(\frac{t^{1/2}}{1/2}) - \frac{3t^{-3}}{(-3)} + C = \sqrt{t} + \frac{1}{t^3} + C$

101. Our trial solution based on the chain rule is $-\frac{1}{(r+5)} + C$. Differentiate the solution to check:

$$\frac{d}{dr} \left[-\frac{1}{(r+5)} + C \right] = \frac{1}{(r+5)^2}. \text{ Thus } \int \frac{dr}{(r+5)^2} = -\frac{1}{(r+5)} + C.$$

102. Our trial solution based on the chain rule is $-\frac{3}{(r-\sqrt{2})^2} + C$. Differentiate the solution to check:

$$\frac{d}{dr} \left[-\frac{3}{(r-\sqrt{2})^2} + C \right] = \frac{6}{(r-\sqrt{2})^3}. \text{ Thus } \int \frac{6dr}{(r-\sqrt{2})^3} = -\frac{3}{(r-\sqrt{2})^2} + C.$$

103. Our trial solution based on the chain rule is $(\theta^2 + 1)^{3/2} + C$. Differentiate the solution to check:

$$\frac{d}{d\theta} \left[(\theta^2 + 1)^{3/2} + C \right] = 3\theta\sqrt{\theta^2 + 1}. \text{ Thus } \int 3\theta\sqrt{\theta^2 + 1} d\theta = (\theta^2 + 1)^{3/2} + C.$$

104. Our trial solution based on the chain rule is $\sqrt{7+\theta^2} + C$. Differentiate the solution to check:

$$\frac{d}{d\theta} \left[\sqrt{7+\theta^2} + C \right] = \frac{\theta}{\sqrt{7+\theta^2}}. \text{ Thus } \int \frac{\theta}{\sqrt{7+\theta^2}} d\theta = \sqrt{7+\theta^2} + C.$$

105. Our trial solution based on the chain rule is $\frac{1}{3}(1+x^4)^{3/4} + C$. Differentiate the solution to check:

$$\frac{d}{dx} \left[\frac{1}{3}(1+x^4)^{3/4} + C \right] = x^3(1+x^4)^{-1/4}. \text{ Thus } \int x^3(1+x^4)^{-1/4} dx = \frac{1}{3}(1+x^4)^{3/4} + C.$$

106. Our trial solution based on the chain rule is $-\frac{5}{8}(2-x)^{8/5} + C$. Differentiate the solution to check:

$$\frac{d}{dx} \left[-\frac{5}{8}(2-x)^{8/5} + C \right] = (2-x)^{3/5}. \text{ Thus } \int (2-x)^{3/5} dx = -\frac{5}{8}(2-x)^{8/5} + C.$$

107. Our trial solution based on the chain rule is $10 \tan \frac{s}{10} + C$. Differentiate the solution to check:

$$\frac{d}{ds} \left[10 \tan \frac{s}{10} + C \right] = \sec^2 \frac{s}{10}. \text{ Thus } \int \sec^2 \frac{s}{10} ds = 10 \tan \frac{s}{10} + C.$$

108. Our trial solution based on the chain rule is $-\frac{1}{\pi} \cot \pi s + C$. Differentiate the solution to check:

$$\frac{d}{ds} \left[-\frac{1}{\pi} \cot \pi s + C \right] = \csc^2 \pi s. \text{ Thus } \int \csc^2 \pi s ds = -\frac{1}{\pi} \cot \pi s + C.$$

109. Our trial solution based on the chain rule is $-\frac{1}{\sqrt{2}} \csc \sqrt{2}\theta + C$. Differentiate the solution to check:

$$\frac{d}{d\theta} \left[-\frac{1}{\sqrt{2}} \csc \sqrt{2}\theta + C \right] = \csc \sqrt{2}\theta \cot \sqrt{2}\theta. \text{ Thus } \int \csc \sqrt{2}\theta \cot \sqrt{2}\theta d\theta = -\frac{1}{\sqrt{2}} \csc \sqrt{2}\theta + C.$$

110. Our trial solution based on the chain rule is $3 \sec \frac{\theta}{3} + C$. Differentiate the solution to check:

$$\frac{d}{d\theta} \left[3 \sec \frac{\theta}{3} + C \right] = \sec \frac{\theta}{3} \tan \frac{\theta}{3}. \text{ Thus } \int \sec \frac{\theta}{3} \tan \frac{\theta}{3} \cot \sqrt{2}\theta d\theta = 3 \sec \frac{\theta}{3} + C.$$

111. Our trial solution based on the chain rule is $\frac{x}{2} - \sin \frac{x}{2} + C$. Differentiate the solution to check:

$$\frac{d}{dx} \left[\frac{x}{2} - \sin \frac{x}{2} + C \right] = \frac{1}{2} - \frac{1}{2} \cos \frac{x}{2} = \sin^2 \frac{x}{4}. \text{ Thus } \int \sin^2 \frac{x}{4} dx = \frac{x}{2} - \sin \frac{x}{2} + C.$$

112. Our trial solution based on the chain rule is $\frac{x}{2} + \frac{1}{2} \sin x + C$. Differentiate the solution to check:

$$\frac{d}{dx} \left[\frac{x}{2} + \frac{1}{2} \sin x + C \right] = \frac{1}{2} + \frac{1}{2} \cos x = \cos^2 \frac{x}{2}. \text{ Thus } \int \cos^2 \frac{x}{2} dx = \frac{x}{2} + \frac{1}{2} \sin x + C.$$

$$113. \int \left(\frac{3}{x} - x \right) dx = 3 \ln |x| - \frac{x^2}{2} + C$$

$$114. \int \left(\frac{5}{x^2} + \frac{2}{x^2+1} \right) dx = \int \left(5x^{-2} + \frac{2}{x^2+1} \right) dx = -5x^{-1} + 2 \tan^{-1} x + C$$

$$115. \int \left(\frac{1}{2} e^t - e^{-t} \right) dt = \frac{1}{2} e^t - \frac{e^{-t}}{-1} + C = \frac{1}{2} e^t + e^{-t} + C$$

$$116. \int (5^s + s^5) ds = \frac{5^s}{\ln 5} + \frac{s^6}{6} + C$$

$$117. \int (\theta^{1-\pi}) d\theta = \frac{\theta^{2-\pi}}{2-\pi} + C$$

118. $\int (2^{\pi+r}) dr = \frac{2^{\pi+r}}{\ln 2} + C$

119. $\int \frac{3}{2x\sqrt{x^2-1}} dx = \frac{3}{2} \int \frac{1}{x\sqrt{x^2-1}} dx = \frac{3}{2} \sec^{-1} x + C$

120. $\int \frac{d\theta}{\sqrt{16-\theta^2}} = \int \frac{d\theta}{\sqrt{16\left(1-\frac{\theta^2}{16}\right)}} = \int \frac{\frac{1}{4}d\theta}{\sqrt{1-\frac{\theta^2}{16}}} = \sin^{-1}\left(\frac{\theta}{4}\right) + C$

121. $y = \int \frac{x^2+1}{x^2} dx = \int (1+x^{-2}) dx = x - x^{-1} + C = x - \frac{1}{x} + C$; $y = -1$ when $x = 1 \Rightarrow 1 - \frac{1}{1} + C = -1 \Rightarrow C = -1$
 $\Rightarrow y = x - \frac{1}{x} - 1$

122. $y = \int \left(x + \frac{1}{x}\right)^2 dx = \int \left(x^2 + 2 + \frac{1}{x^2}\right) dx = \int (x^2 + 2 + x^{-2}) dx = \frac{x^3}{3} + 2x - x^{-1} + C = \frac{x^3}{3} + 2x - \frac{1}{x} + C$;
 $y = 1$ when $x = 1 \Rightarrow \frac{1}{3} + 2 - \frac{1}{1} + C = 1 \Rightarrow C = -\frac{1}{3} \Rightarrow y = \frac{x^3}{3} + 2x - \frac{1}{x} - \frac{1}{3}$

123. $\frac{dr}{dt} = \int \left(15\sqrt{t} + \frac{3}{\sqrt{t}}\right) dt = \int (15t^{1/2} + 3t^{-1/2}) dt = 10t^{3/2} + 6t^{1/2} + C$; $\frac{dr}{dt} = 8$ when $t = 1 \Rightarrow 10(1)^{3/2} + 6(1)^{1/2} + C = 8$
 $\Rightarrow C = -8$. Thus $\frac{dr}{dt} = 10t^{3/2} + 6t^{1/2} - 8 \Rightarrow r = \int (10t^{3/2} + 6t^{1/2} - 8) dt = 4t^{5/2} + 4t^{3/2} - 8t + C$; $r = 0$ when $t = 1$
 $\Rightarrow 4(1)^{5/2} + 4(1)^{3/2} - 8(1) + C_1 = 0 \Rightarrow C_1 = 0$. Therefore, $r = 4t^{5/2} + 4t^{3/2} - 8t$

124. $\frac{d^2r}{dt^2} = \int -\cos t dt = -\sin t + C$; $r'' = 0$ when $t = 0 \Rightarrow -\sin 0 + C = 0 \Rightarrow C = 0$. Thus, $\frac{d^2r}{dt^2} = -\sin t$
 $\Rightarrow \frac{dr}{dt} = \int -\sin t dt = \cos t + C_1$; $r' = 0$ when $t = 0 \Rightarrow 1 + C_1 = 0 \Rightarrow C_1 = -1$. Then
 $\frac{dr}{dt} = \cos t - 1 \Rightarrow r = \int (\cos t - 1) dt = \sin t - t + C_2$; $r = -1$ when $t = 0 \Rightarrow 0 - 0 + C_2 = -1 \Rightarrow C_2 = -1$. Therefore,
 $r = \sin t - t - 1$

125. Yes, $\sin^{-1} x$ and $-\cos^{-1} x$ differ by the constant $\frac{\pi}{2}$

126. Yes, the derivatives of $y = -\cos^{-1} x + C$ and $y = \cos^{-1}(-x) + C$ are both $\frac{1}{\sqrt{1-x^2}}$.

127. $A = xy = xe^{-x^2} \Rightarrow \frac{dA}{dx} = e^{-x^2} + (x)(-2x)e^{-x^2} = e^{-x^2}(1-2x^2)$. Solving $\frac{dA}{dx} = 0 \Rightarrow 1-2x^2 = 0 \Rightarrow x = \frac{1}{\sqrt{2}}$; $\frac{dA}{dx} < 0$
for $x > \frac{1}{\sqrt{2}}$ and $\frac{dA}{dx} > 0$ for $0 < x < \frac{1}{\sqrt{2}} \Rightarrow$ absolute maximum of $\frac{1}{\sqrt{2}}e^{-1/2} = \frac{1}{\sqrt{2}e}$ at $x = \frac{1}{\sqrt{2}}$ units long by
 $y = e^{-1/2} = \frac{1}{\sqrt{e}}$ units high.

128. $A = xy = x\left(\frac{\ln x}{x^2}\right) = \frac{\ln x}{x} \Rightarrow \frac{dA}{dx} = \frac{1}{x^2} - \frac{\ln x}{x^2} = \frac{1-\ln x}{x^2}$. Solving $\frac{dA}{dx} = 0 \Rightarrow 1 - \ln x = 0 \Rightarrow x = e$; $\frac{dA}{dx} < 0$ for $x > e$ and
 $\frac{dA}{dx} > 0$ for $x < e \Rightarrow$ absolute maximum of $\frac{\ln e}{e} = \frac{1}{e}$ at $x = e$ units long and $y = \frac{1}{e^2}$ units high.

129. $y = x \ln 2x - x$
 $\Rightarrow y' = x\left(\frac{2}{2x}\right) + \ln(2x) - 1 = \ln 2x$; solving
 $y' = 0 \Rightarrow x = \frac{1}{2}$; $y' > 0$ for $x > \frac{1}{2}$ and $y' < 0$ for
 $x < \frac{1}{2} \Rightarrow$ relative minimum of $-\frac{1}{2}$ at
 $x = \frac{1}{2}$; $f\left(\frac{1}{2e}\right) = -\frac{1}{e}$ and $f\left(\frac{e}{2}\right) = 0 \Rightarrow$ absolute
 minimum is $-\frac{1}{2}$ at $x = \frac{1}{2}$ and the absolute
 maximum is 0 at $x = \frac{e}{2}$

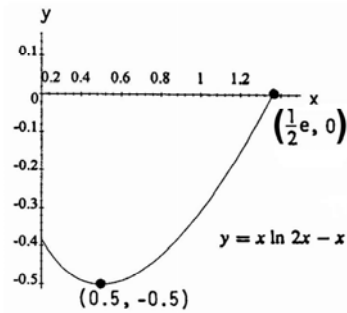

130. $y = 10x(2 - \ln x) \Rightarrow y' = 10(2 - \ln x) - 10x\left(\frac{1}{x}\right)$
 $= 20 - 10 \ln x - 10$
 $= 10(1 - \ln x)$;
 solving $y' = 0 \Rightarrow x = e$; $y' < 0$ for $x > e$ and $y' > 0$
 for $x < e \Rightarrow$ relative maximum at $x = e$ of $10e$; $y \geq 0$
 on $(0, e^2]$ and $y(e^2) = 10e^2(2 - 2 \ln 3) = 0 \Rightarrow$
 absolute minimum is 0 at $x = e^2$ and the absolute
 maximum is $10e$ at $x = e$

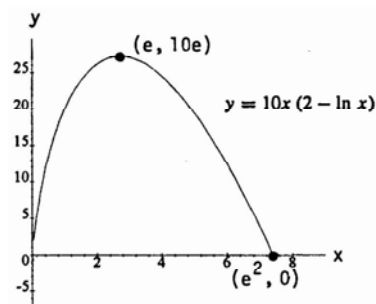

131. $f(x) = e^{x/\sqrt{x^4+1}}$ for all x in $(-\infty, \infty)$;
 $f'(x) = \left[\frac{(\sqrt{x^4+1}) \cdot 1 - x \left(\frac{2x^3}{\sqrt{x^4+1}} \right)}{(\sqrt{x^4+1})^2} \right] e^{x/\sqrt{x^4+1}} = \frac{1-x^4}{(\sqrt{x^4+1})^3} e^{x/\sqrt{x^4+1}} = \frac{(1-x^2)(1+x^2)}{(x^4+1)^{3/2}} e^{x/\sqrt{x^4+1}} = 0 \Rightarrow 1-x^2 = 0 \Rightarrow x = \pm 1$

are critical points. Consider the behavior of f as $x \rightarrow \pm\infty$; $\lim_{x \rightarrow \infty} e^{x/\sqrt{x^4+1}} = \lim_{x \rightarrow -\infty} e^{x/\sqrt{x^4+1}} = 1$ as suggested by
 the following table (14 digit precision, 12 digits displayed):

x	$x/\sqrt{x^4+1}$	$e^{x/\sqrt{x^4+1}}$
$-\infty$	0	1
\vdots	\vdots	\vdots
-100000	-0.0000 10000 0000 00000	0.9999 9000 0050
-10000	-0.0001 0000 0000 000	0.9999 0000 5000
-1000	-0.0010 0000 0000 00	0.9990 0049 9833
-100	-0.0099 9999 9950 00	0.9900 4983 3799
-10	-0.0999 9500 0375 0	0.9048 4194 1895
0	0	1
10	0.0999 9500 0375 0	1.1051 6539 265

100	0.0099 9999 9950 00	1.0100 5016 703
1000	0.0010 0000 0000 00	1.0010 0050 017
10000	0.0001 0000 0000 000	1.0001 0000 500
100000	0.0000 10000 0000 00000	1.0000 1000 005
⋮	⋮	⋮
∞	0	1

Therefore, $y = 1$ is a horizontal asymptote in both directions. Check the critical points for absolute extreme values: $f(-1) = e^{-\sqrt{2}/2} \approx 0.4931$, $f(1) = e^{\sqrt{2}/2} \approx 2.0281 \Rightarrow$ the absolute minimum value of the function is $e^{-\sqrt{2}/2}$ at $x = -1$, and the absolute maximum value is $e^{\sqrt{2}/2}$ at $x = 1$.

132. $f(x) = e^{\sqrt{3-2x-x^2}}$; the domain of g is all x such that $3-2x-x^2 \geq 0$. The parabola $y = 3-2x-x^2$ is concave down with x -intercepts at $x = -3$ and $x = 1$, therefore $3-2x-x^2 \geq 0$ if $-3 \leq x \leq 1$, and this interval is the domain of g ; $g'(x) = -\frac{1+x}{\sqrt{3-2x-x^2}} e^{\sqrt{3-2x-x^2}} = 0 \Rightarrow 1+x=0 \Rightarrow x = -1$ is a critical point;
 $g(-3) = g(1) = e^0 = 1$, $g(1) = e^2 \approx 7.3891 \Rightarrow$ the absolute minimum value of the function is 1 at $x = -3$ and $x = 1$, and the absolute maximum value is e^2 at $x = -1$.

133. (a) $y = \frac{\ln x}{\sqrt{x}} \Rightarrow y' = \frac{1}{x\sqrt{x}} - \frac{\ln x}{2x^{3/2}} = \frac{2-\ln x}{2x\sqrt{x}}$
 $\Rightarrow y'' = -\frac{3}{4}x^{-5/2}(2-\ln x) - \frac{1}{2}x^{-5/2}$
 $= x^{-5/2}(\frac{3}{4}\ln x - 2)$;
 solving $y' = 0 \Rightarrow \ln x = 2 \Rightarrow x = e^2$; $y' < 0$
 for $x > e^2$ and $y' > 0$ for $x < e^2$
 \Rightarrow a maximum of $\frac{2}{e}$; $y'' = 0 \Rightarrow$
 $\ln x = \frac{8}{3} \Rightarrow x = e^{8/3}$; the curve is concave down
 on $(0, e^{8/3})$ and concave up on $(e^{8/3}, \infty)$; so
 there is an inflection point at $(e^{8/3}, \frac{8}{3e^{4/3}})$.

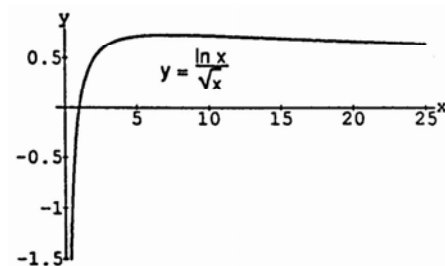

- (b) $y = e^{-x^2} \Rightarrow y' = -2xe^{-x^2}$
 $\Rightarrow y'' = -2e^{-x^2} + 4x^2e^{-x^2} = (4x^2 - 2)e^{-x^2}$;
 solving $y' = 0 \Rightarrow x = 0$; $y' < 0$ for $x > 0$ and
 $y' > 0$ for $x < 0 \Rightarrow$ a maximum at $x = 0$ or
 $e^0 = 1$; there are points of inflection at
 $x = \pm \frac{1}{\sqrt{2}}$; the curve is concave down for
 $-\frac{1}{\sqrt{2}} < x < \frac{1}{\sqrt{2}}$ and concave up otherwise.

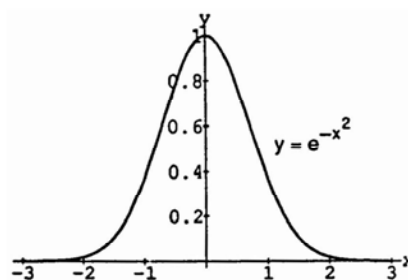

- (c) $y = (1+x)e^{-x}$
 $\Rightarrow y' = e^{-x} - (1+x)e^{-x} = -xe^{-x}$
 $\Rightarrow y'' = -e^{-x} + e^{-x} = (x-1)e^{-x}$; solving
 $y' = 0 \Rightarrow -xe^{-x} = 0 \Rightarrow x = 0$; $y' < 0$ for
 $x > 0$ and $y' > 0$ for $x < 0 \Rightarrow$ a maximum at $x =$
 0 of $(1+0)e^0 = 1$; there is a point of inflection
at $x = 1$ and the curve is concave up for $x > 1$
and concave down for $x < 1$.

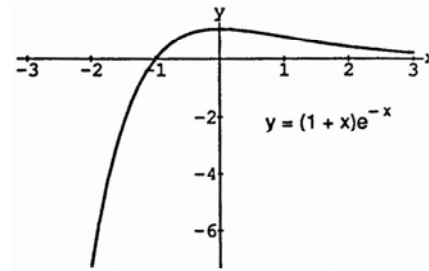

134. $y = x \ln x \Rightarrow y' = \ln x + x\left(\frac{1}{x}\right) = \ln x + 1$; solving
 $y' = 0 \Rightarrow \ln x + 1 = 0 \Rightarrow \ln x = -1 \Rightarrow x = e^{-1}$;
 $y' > 0$ for $x > e^{-1}$ and $y' < 0$ for $x < e^{-1}$
 \Rightarrow a minimum of $e^{-1} \ln e^{-1} = -\frac{1}{e}$ at $x = e^{-1}$. This
minimum is an absolute minimum since $y'' = \frac{1}{x}$ is
positive for all $x > 0$.

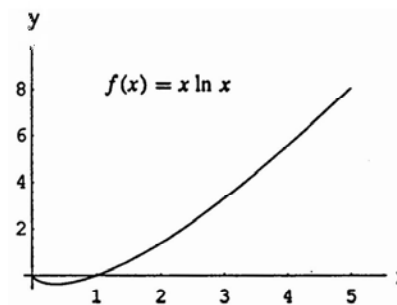

135. In the interval $\pi < x < 2\pi$ the function
 $\sin x < 0 \Rightarrow (\sin x)^{\sin x}$ is not defined for all values
in that interval or its translation by 2π .

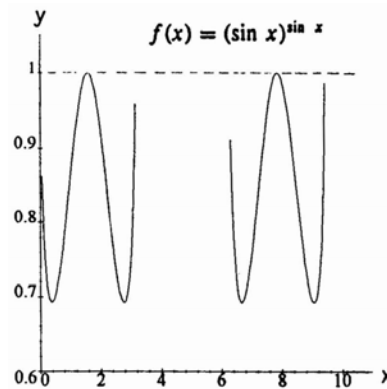

136. $v = x^2 \ln\left(\frac{1}{x}\right) = x^2(\ln 1 - \ln x) = -x^2 \ln x \Rightarrow \frac{dv}{dx} = -2x \ln x - x^2\left(\frac{1}{x}\right) = -x(2 \ln x + 1)$; solving
 $\frac{dv}{dx} = 0 \Rightarrow 2 \ln x + 1 = 0 \Rightarrow \ln x = -\frac{1}{2} \Rightarrow x = e^{-1/2}$; $\frac{dv}{dx} < 0$ for $x > e^{-1/2}$ and $\frac{dv}{dx} > 0$ for $x < e^{-1/2} \Rightarrow$ a relative
maximum at $x = e^{-1/2}$; $\frac{r}{h} = x$ and $r = 1 \Rightarrow h = e^{1/2} = \sqrt{e} \approx 1.65$ cm

CHAPTER 4 ADDITIONAL AND ADVANCED EXERCISES

- If M and m are the maximum and minimum values, respectively, then $m \leq f(x) \leq M$ for all $x \in I$. If $m = M$ then f is constant on I .
- No, the function $f(x) = \begin{cases} 3x + 6, & -2 \leq x < 0 \\ 9 - x^2, & 0 \leq x \leq 2 \end{cases}$ has an absolute minimum value of 0 at $x = -2$ and an absolute maximum value of 9 at $x = 0$, but it is discontinuous at $x = 0$.
- On an open interval the extreme values of a continuous function (if any) must occur at an interior critical point. On a half-open interval the extreme values of a continuous function may be at a critical point or at the closed endpoint. Extreme values occur only where $f' = 0$, f' does not exist, or at the endpoints of the interval. Thus the extreme points will not be at the ends of an open interval.
- The pattern $f' = \underset{1}{+++} | \underset{2}{----} | \underset{3}{----} | \underset{4}{++++} | \underset{4}{++++}$ indicates a local maximum at $x = 1$ and a local minimum at $x = 3$.
- (a) If $y' = 6(x+1)(x-2)^2$, then $y' < 0$ for $x < -1$ and $y' > 0$ for $x > -1$. The sign pattern is $f' = \underset{-1}{----} | \underset{2}{+++} | \underset{2}{+++} \Rightarrow f$ has a local minimum at $x = -1$. Also $y'' = 6(x-2)^2 + 12(x+1)(x-2) = 6(x-2)(3x) \Rightarrow y'' > 0$ for $x < 0$ or $x > 2$, while $y'' < 0$ for $0 < x < 2$. Therefore f has points of inflection at $x = 0$ and $x = 2$. There is no local maximum.
 (b) If $y' = 6x(x+1)(x-2)$, then $y' < 0$ for $x < -1$ and $0 < x < 2$; $y' > 0$ for $-1 < x < 0$ and $x > 2$. The sign pattern is $y' = \underset{-1}{----} | \underset{0}{+++} | \underset{2}{----} | \underset{2}{+++}$. Therefore f has a local maximum at $x = 0$ and local minima at $x = -1$ and $x = 2$. Also, $y'' = 18 \left[x - \left(\frac{1-\sqrt{7}}{3} \right) \right] \left[x - \left(\frac{1+\sqrt{7}}{3} \right) \right]$, so $y'' < 0$ for $\frac{1-\sqrt{7}}{3} < x < \frac{1+\sqrt{7}}{3}$ and $y'' > 0$ for all other $x \Rightarrow f$ has points of inflection at $x = \frac{1 \pm \sqrt{7}}{3}$.
- The Mean Value Theorem indicates that $\frac{f(6)-f(0)}{6-0} = f'(c) \leq 2$ for some c in $(0, 6)$. Then $f(6) - f(0) \leq 12$ indicates the most that f can increase is 12.
- If f is continuous on $[a, c]$ and $f'(x) \leq 0$ on $[a, c]$, then by the Mean Value Theorem for all $x \in [a, c]$ we have $\frac{f(c)-f(x)}{c-x} \leq 0 \Rightarrow f(c) - f(x) \leq 0 \Rightarrow f(x) \geq f(c)$. Also if f is continuous on $(c, b]$ and $f'(x) \geq 0$ on $(c, b]$, then for all $x \in (c, b]$ we have $\frac{f(x)-f(c)}{x-c} \geq 0 \Rightarrow f(x) - f(c) \geq 0 \Rightarrow f(x) \geq f(c)$. Therefore $f(x) \geq f(c)$ for all $x \in [a, b]$.
- (a) For all x , $-(x+1)^2 \leq 0 \leq (x-1)^2 \Rightarrow -(1+x^2) \leq 2x \leq (1+x^2) \Rightarrow -\frac{1}{2} \leq \frac{x}{1+x^2} \leq \frac{1}{2}$.
 (b) There exists $c \in (a, b)$ such that $\frac{c}{1+c^2} = \frac{f(b)-f(a)}{b-a} \Rightarrow \left| \frac{f(b)-f(a)}{b-a} \right| = \left| \frac{c}{1+c^2} \right| \leq \frac{1}{2}$, from part (a) $\Rightarrow |f(b) - f(a)| \leq \frac{1}{2} |b - a|$.
- No. Corollary 1 requires that $f'(x) = 0$ for all x in some interval I , not $f'(x) = 0$ at a single point in I .
- (a) $h(x) = f(x)g(x) \Rightarrow h'(x) = f'(x)g(x) + f(x)g'(x)$ which changes signs at $x = a$ since $f'(x), g'(x) > 0$ when $x < a$, $f'(x), g'(x) < 0$ when $x > a$ and $f(x), g(x) > 0$ for all x . Therefore $h(x)$ does have a local maximum at $x = a$.
 (b) No, let $f(x) = g(x) = x^3$ which have points of inflection at $x = 0$, but $h(x) = x^6$ has no point of inflection (it has a local minimum at $x = 0$).

11. From (ii), $f(-1) = \frac{-1+a}{b-c+2} = 0 \Rightarrow a = 1$; from (iii), either $1 = \lim_{x \rightarrow \infty} f(x)$ or $1 = \lim_{x \rightarrow -\infty} f(x)$. In either case,

$$\lim_{x \rightarrow \pm\infty} f(x) = \lim_{x \rightarrow \pm\infty} \frac{x+1}{bx^2+cx+2} = \lim_{x \rightarrow \pm\infty} \frac{1+\frac{1}{x}}{bx+c+\frac{2}{x}} = 1 \Rightarrow b = 0 \text{ and } c = 1. \text{ For if } b = 1, \text{ then } \lim_{x \rightarrow \pm\infty} \frac{1+\frac{1}{x}}{x+c+\frac{2}{x}} = 0 \text{ and if } c = 0, \text{ then } \lim_{x \rightarrow \pm\infty} \frac{1+\frac{1}{x}}{bx+\frac{2}{x}} = \lim_{x \rightarrow \pm\infty} \frac{1+\frac{1}{x}}{\frac{2}{x}} = \pm\infty. \text{ Thus } a = 1, b = 0, \text{ and } c = 1.$$

12. $\frac{dy}{dx} = 3x^2 + 2kx + 3 = 0 \Rightarrow x = \frac{-2k \pm \sqrt{4k^2 - 36}}{6} \Rightarrow x$ has only one value when $4k^2 - 36 = 0 \Rightarrow k^2 = 9$ or $k = \pm 3$.

13. The area of the $\triangle ABC$ is $A(x) = \frac{1}{2}(2)\sqrt{1-x^2} = (1-x^2)^{1/2}$, where $0 \leq x \leq 1$. Thus $A'(x) = \frac{-x}{\sqrt{1-x^2}} \Rightarrow 0$ and ± 1 are critical points. Also $A(\pm 1) = 0$ so $A(0) = 1$ is the maximum. When $x = 0$ the $\triangle ABC$ is isosceles since $AC = BC = \sqrt{2}$.

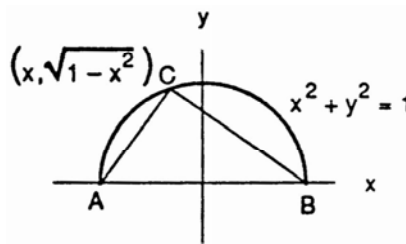

14. $\lim_{h \rightarrow 0} \frac{f'(c+h) - f'(c)}{h} = f''(c) \Rightarrow$ for $\varepsilon = \frac{1}{2}|f''(c)| > 0$ there exists a $\delta > 0$ such that $0 < |h| < \delta$
 $\Rightarrow \left| \frac{f'(c+h) - f'(c)}{h} - f''(c) \right| < \frac{1}{2}|f''(c)|$. Then $f'(c) = 0 \Rightarrow -\frac{1}{2}|f''(c)| < \frac{f'(c+h)}{h} - f''(c) < \frac{1}{2}|f''(c)|$
 $\Rightarrow f''(c) - \frac{1}{2}|f''(c)| < \frac{f'(c+h)}{h} < f''(c) + \frac{1}{2}|f''(c)|$. If $f''(c) < 0$, then $|f''(c)| = -f''(c)$
 $\Rightarrow \frac{3}{2}f''(c) < \frac{f'(c+h)}{h} < \frac{1}{2}f''(c) < 0$; likewise if $f''(c) > 0$, then $0 < \frac{1}{2}f''(c) < \frac{f'(c+h)}{h} < \frac{3}{2}f''(c)$.
 (a) If $f''(c) < 0$, then $-\delta < h < 0 \Rightarrow f'(c+h) > 0$ and $0 < h < \delta \Rightarrow f'(c+h) < 0$. Therefore, $f(c)$ is a local maximum.
 (b) If $f''(c) > 0$, then $-\delta < h < 0 \Rightarrow f'(c+h) < 0$ and $0 < h < \delta \Rightarrow f'(c+h) > 0$. Therefore, $f(c)$ is a local minimum.

15. The time it would take the water to hit the ground from height y is $\sqrt{\frac{2y}{g}}$, where g is the acceleration of gravity. The product of time and exit velocity (rate) yields the distance the water travels:
 $D(y) = \sqrt{\frac{2y}{g}} \sqrt{64(h-y)} = 8\sqrt{\frac{2}{g}}(hy - y^2)^{1/2}$, $0 \leq y \leq h \Rightarrow D'(y) = -4\sqrt{\frac{2}{g}}(hy - y^2)^{-1/2}(h - 2y) \Rightarrow 0$, $\frac{h}{2}$ and h are critical points. Now $D(0) = 0$, $D(\frac{h}{2}) = 8\sqrt{\frac{2}{g}}\left(h\left(\frac{h}{2}\right) - \left(\frac{h}{2}\right)^2\right)^{1/2} = 4h\sqrt{\frac{2}{g}}$ and $D(h) = 0 \Rightarrow$ the best place to drill the hole is at $y = \frac{h}{2}$.

16. From the figure in the text, $\tan(\beta + \theta) = \frac{b+a}{n}$; $\tan(\beta + \theta) = \frac{\tan \beta + \tan \theta}{1 - \tan \beta \tan \theta}$; and $\tan \theta = \frac{a}{h}$. These equations give
 $\frac{b+a}{h} = \frac{\tan \beta + \frac{a}{h}}{1 - \tan \beta \frac{a}{h}} = \frac{h \tan \beta + a}{h - a \tan \beta}$. Solving for $\tan \beta$ gives $\tan \beta = \frac{bh}{h^2 + a(b+a)}$ or $(h^2 - a(b+a)) \tan \beta = bh$.
 Differentiating both sides with respect to h gives $2h \tan \beta + (h^2 + a(b+a)) \sec^2 \beta \frac{d\beta}{dh} = b$. Then
 $\frac{d\beta}{dh} = 0 \Rightarrow 2h \tan \beta = b \Rightarrow 2h \left(\frac{bh}{h^2 + a(b+a)} \right) = b \Rightarrow 2bh^2 = bh^2 + ab(b+a) \Rightarrow h^2 = a(b+a) \Rightarrow h = \sqrt{a(b+a)}$.

17. The surface area of the cylinder is $S = 2\pi r^2 + 2\pi rh$.
 From the diagram we have $\frac{r}{R} = \frac{H-h}{H} \Rightarrow h = \frac{RH-rH}{R}$
 and $S(r) = 2\pi r(r+h) = 2\pi r\left(r+H-r\frac{H}{R}\right)$
 $= 2\pi\left(1-\frac{H}{R}\right)r^2 + 2\pi Hr$, where $0 \leq r \leq R$.

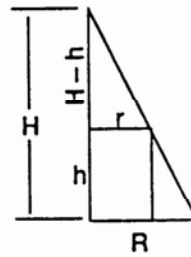

Case 1: $H < R \Rightarrow S(r)$ is a quadratic equation containing the origin and concave upward $\Rightarrow S(r)$ is maximum at $r = R$.

Case 2: $H = R \Rightarrow S(r)$ is a linear equation containing the origin with a positive slope $\Rightarrow S(r)$ is maximum at $r = R$.

Case 3: $H > R \Rightarrow S(r)$ is a quadratic equation containing the origin and concave downward.

Then $\frac{dS}{dr} = 4\pi\left(1-\frac{H}{R}\right)r + 2\pi H$ and $\frac{dS}{dr} = 0 \Rightarrow 4\pi\left(1-\frac{H}{R}\right)r + 2\pi H = 0 \Rightarrow r = \frac{RH}{2(H-R)}$. For simplification we let $r^* = \frac{RH}{2(H-R)}$.

(a) If $R < H < 2R$, then $0 > H - 2R \Rightarrow H > 2(H - R) \Rightarrow r^* = \frac{RH}{2(H-R)} > R$. Therefore, the maximum occurs at the right endpoint R of the interval $0 \leq r \leq R$ because $S(r)$ is an increasing function of r .

(b) If $H = 2R$, then $r^* = \frac{2R^2}{2R} = R \Rightarrow S(r)$ is maximum at $r = R$.

(c) If $H > 2R$, then $2R + H < 2H \Rightarrow H < 2(H - R) \Rightarrow \frac{RH}{2(H-R)} < 1 \Rightarrow \frac{RH}{2(H-R)} < R \Rightarrow r^* < R$. Therefore, $S(r)$ is a maximum at $r = r^* = \frac{RH}{2(H-R)}$.

Conclusion: If $H \in (0, 2R]$, then the maximum surface area is at $r = R$. If $H \in (2R, \infty)$, then the maximum is at $r = r^* = \frac{RH}{2(H-R)}$.

18. $f(x) = mx - 1 + \frac{1}{x} \Rightarrow f'(x) = m - \frac{1}{x^2}$ and $f''(x) = \frac{2}{x^3} > 0$ when $x > 0$. Then $f'(x) = 0 \Rightarrow x = \frac{1}{\sqrt{m}}$ yields a minimum.
 If $f\left(\frac{1}{\sqrt{m}}\right) \geq 0$, then $\sqrt{m} - 1 + \sqrt{m} = 2\sqrt{m} - 1 \geq 0 \Rightarrow m \geq \frac{1}{4}$. Thus the smallest acceptable value for m is $\frac{1}{4}$.

19. (a) $\lim_{x \rightarrow 0} \frac{2\sin(5x)}{3x} = \lim_{x \rightarrow 0} \frac{2\sin(5x)}{\frac{2}{3}(5x)} = \lim_{x \rightarrow 0} \frac{10}{3} \frac{\sin(5x)}{5x} = \frac{10}{3} \cdot 1 = \frac{10}{3}$
- (b) $\lim_{x \rightarrow 0} \sin(5x) \cot(3x) = \lim_{x \rightarrow 0} \frac{\sin(5x)\cos(3x)}{\sin(3x)} = \lim_{x \rightarrow 0} \frac{-3\sin(5x)\sin(3x) + 5\cos(5x)\cos(3x)}{3\cos(3x)} = \frac{5}{3}$
- (c) $\lim_{x \rightarrow 0} x \csc^2 \sqrt{2x} = \lim_{x \rightarrow 0} \frac{x}{\sin^2 \sqrt{2x}} = \lim_{x \rightarrow 0} \frac{1}{\frac{2\sin \sqrt{2x} \cos \sqrt{2x}}{\sqrt{2x}}} = \lim_{x \rightarrow 0} \frac{\sqrt{2x}}{\sin(2\sqrt{2x})} = \lim_{x \rightarrow 0} \frac{\frac{1}{\sqrt{2x}}}{\cos(2\sqrt{2x})} = \lim_{x \rightarrow 0} \frac{1}{\cos(2\sqrt{2x}) \cdot 2} = \frac{1}{2}$
- (d) $\lim_{x \rightarrow \pi/2} (\sec x - \tan x) = \lim_{x \rightarrow \pi/2} \frac{1 - \sin x}{\cos x} = \lim_{x \rightarrow \pi/2} \frac{-\cos x}{-\sin x} = 0$
- (e) $\lim_{x \rightarrow 0} \frac{x - \sin x}{x - \tan x} = \lim_{x \rightarrow 0} \frac{1 - \cos x}{1 - \sec^2 x} = \lim_{x \rightarrow 0} \frac{1 - \cos x}{-5 \tan^2 x} = \lim_{x \rightarrow 0} \frac{\cos x - 1}{\tan^2 x} = \lim_{x \rightarrow 0} \frac{-\sin x}{2 \tan x \sec^2 x} = \lim_{x \rightarrow 0} \frac{-\sin x}{\frac{2\sin x}{\cos^3 x}} = \lim_{x \rightarrow 0} \frac{\cos^3 x}{-2} = -\frac{1}{2}$
- (f) $\lim_{x \rightarrow 0} \frac{\sin(x^2)}{x \sin x} = \lim_{x \rightarrow 0} \frac{2x \cos(x^2)}{x \cos x + \sin x} = \lim_{x \rightarrow 0} \frac{-(2x^2) \sin(x^2) + 2 \cos(x^2)}{-x \sin x + 2 \cos x} = \frac{2}{2} = 1$
- (g) $\lim_{x \rightarrow 0} \frac{\sec x - 1}{x^2} = \lim_{x \rightarrow 0} \frac{\sec x \tan x}{2x} = \lim_{x \rightarrow 0} \frac{\sec^3 x + \tan^2 x \sec x}{2} = \frac{1+0}{2} = \frac{1}{2}$
- (h) $\lim_{x \rightarrow 2} \frac{x^3 - 8}{x^2 - 4} = \lim_{x \rightarrow 2} \frac{(x-2)(x^2 + 2x + 4)}{(x-2)(x+2)} = \lim_{x \rightarrow 2} \frac{x^2 + 2x + 4}{x + 2} = \frac{4+4+4}{4} = 3$

20. (a) $\lim_{x \rightarrow \infty} \frac{\sqrt{x+5}}{\sqrt{x+5}} = \lim_{x \rightarrow \infty} \frac{\sqrt{x+5}}{\sqrt{x}} = \lim_{x \rightarrow \infty} \frac{\sqrt{1+\frac{5}{x}}}{1+\frac{5}{\sqrt{x}}} = \frac{1}{1} = 1$

(b) $\lim_{x \rightarrow \infty} \frac{2x}{x+7\sqrt{x}} = \lim_{x \rightarrow \infty} \frac{\frac{2x}{x}}{\frac{x+7\sqrt{x}}{x}} = \lim_{x \rightarrow \infty} \frac{2}{1+7\sqrt{\frac{1}{x}}} = \frac{2}{1+0} = 2$

21. (a) The profit function is $P(x) = (c - ex)x - (a + bx) = -ex^2 + (c - b)x - a$. $P'(x) = -2ex + c - b = 0 \Rightarrow x = \frac{c-b}{2e}$. $P''(x) = -2e < 0$ if $e > 0$ so that the profit function is maximized at $x = \frac{c-b}{2e}$.

(b) The price therefore that corresponds to a production level yielding a maximum profit is

$$p \Big|_{x=\frac{c-b}{2e}} = c - e \left(\frac{c-b}{2e} \right) = \frac{c+b}{2} \text{ dollars.}$$

(c) The weekly profit at this production level is $P(x) = -e \left(\frac{c-b}{2e} \right)^2 + (c-b) \left(\frac{c-b}{2e} \right) - a = \frac{(c-b)^2}{4e} - a$.

(d) The tax increases cost to the new profit function is $F(x) = (c - ex)x - (a + bx + tx) = -ex^2 + (c - b - t)x - a$. Now $F'(x) = -2ex + c - b - t = 0$ when $x = \frac{t+b-c}{-2e} = \frac{c-b-t}{2e}$. Since $F''(x) = -2e < 0$ if $e > 0$, F is maximized when $x = \frac{c-b-t}{2e}$ units per week. Thus the price per unit is $p = c - e \left(\frac{c-b-t}{2e} \right) = \frac{c+b+t}{2}$ dollars. Thus, such a tax increases the cost per unit by $\frac{c+b+t}{2} - \frac{c+b}{2} = \frac{t}{2}$ dollars if units are priced to maximize profit.

22. (a)

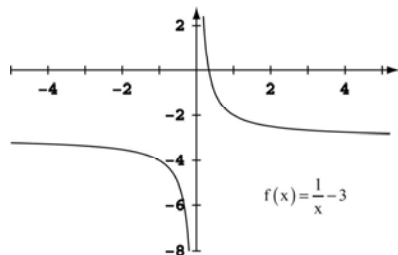

The x -intercept occurs when $\frac{1}{x} - 3 = 0 \Rightarrow \frac{1}{x} = 3 \Rightarrow x = \frac{1}{3}$.

(b) By Newton's method, $x_{n+1} = x_n - \frac{f(x_n)}{f'(x_n)}$. Here $f'(x_n) = -x_n^{-2} = -\frac{1}{x_n^2}$. So $x_{n+1} = x_n - \frac{\frac{1}{x_n} - 3}{-\frac{1}{x_n^2}} = x_n + \left(\frac{1}{x_n} - 3 \right) x_n^2 = x_n + x_n - 3x_n^2 = 2x_n - 3x_n^2 = x_n(2 - 3x_n)$.

23. $x_1 = x_0 - \frac{f(x_0)}{f'(x_0)} = x_0 - \frac{x_0^q - a}{qx_0^{q-1}} = \frac{qx_0^q - x_0^q + a}{qx_0^{q-1}} = \frac{x_0^q(q-1) + a}{qx_0^{q-1}} = x_0 \left(\frac{q-1}{q} \right) + \frac{a}{x_0^{q-1}} \left(\frac{1}{q} \right)$ so that x_1 is a weighted average of x_0 and $\frac{a}{x_0^{q-1}}$ with weights $m_0 = \frac{q-1}{q}$ and $m_1 = \frac{1}{q}$.

In the case where $x_0 = \frac{a}{x_0^{q-1}}$ we have $x_0^q = a$ and $x_1 = \frac{a}{x_0^{q-1}} \left(\frac{q-1}{q} \right) + \frac{a}{x_0^{q-1}} \left(\frac{1}{q} \right) = \frac{a}{x_0^{q-1}} \left(\frac{q-1}{q} + \frac{1}{q} \right) = \frac{a}{x_0^{q-1}}$.

24. We have that $(x-h)^2 + (y-h)^2 = r^2$ and so $2(x-h) + 2(y-h) \frac{dy}{dx} = 0$ and $2 + 2 \frac{dy}{dx} + 2(y-h) \frac{d^2y}{dx^2} = 0$ hold. Thus

$2x + 2y \frac{dy}{dx} = 2h + 2h \frac{dy}{dx}$, by the former. Solving for h , we obtain $h = \frac{x+y \frac{dy}{dx}}{1+\frac{dy}{dx}}$. Substituting this into the second

equation yields $2 + 2 \frac{dy}{dx} + 2y \frac{d^2y}{dx^2} - 2 \left(\frac{x+y \frac{dy}{dx}}{1+\frac{dy}{dx}} \right) \frac{d^2y}{dx^2} = 0$. Dividing by 2 results in $1 + \frac{dy}{dx} + y \frac{d^2y}{dx^2} - \left(\frac{x+y \frac{dy}{dx}}{1+\frac{dy}{dx}} \right) \frac{d^2y}{dx^2} = 0$.

25. $\frac{ds}{dt} = ks \Rightarrow \frac{ds}{s} = k dt \Rightarrow \ln s = kt + C \Rightarrow s = s_0 e^{kt}$
 \Rightarrow the 14th century model of free fall was exponential; note that the motion starts too slowly at first and then becomes too fast after about 7 seconds.

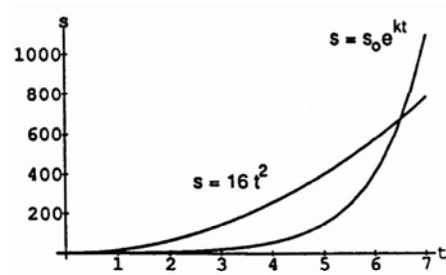

26. Two views of the graph of $y = 1000\left[1 - (.99)^x + \frac{1}{x}\right]$ are shown below.

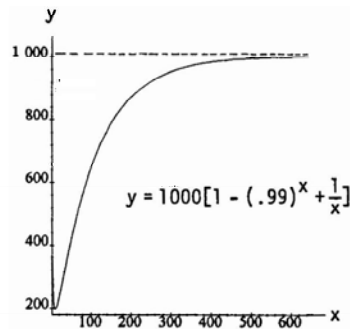
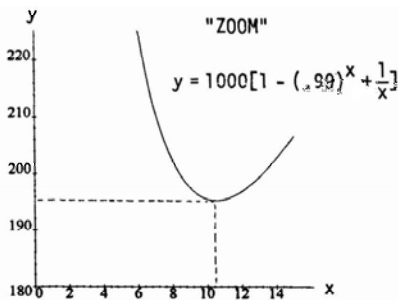

At about $x = 11$ there is a minimum. There is no maximum; however, the curve is asymptotic to $y = 1000$. The curve is near 1000 when $x \geq 643$.

27. (a) $a(t) = s''(t) = -k$ ($k > 0$) $\Rightarrow s'(t) = -kt + C_1$, where $s'(0) = 88 \Rightarrow C_1 = 88 \Rightarrow s'(t) = -kt + 88$. So $s(t) = \frac{-kt^2}{2} + 88t + C_2$ where $s(0) = 0 \Rightarrow C_2 = 0$ so $s(t) = \frac{-kt^2}{2} + 88t$. Now $s(t) = 100$ when $\frac{-kt^2}{2} + 88t = 100$. Solving for t we obtain $t = \frac{88 \pm \sqrt{88^2 - 200k}}{k}$. At such t we want $s'(t) = 0$, thus $-k\left(\frac{88 + \sqrt{88^2 - 200k}}{k}\right) + 88 = 0$ or $-k\left(\frac{88 - \sqrt{88^2 - 200k}}{k}\right) + 88 = 0$. In either case we obtain $88^2 - 200k = 0$ so that $k = \frac{88^2}{200} \approx 38.72$ ft/sec².
- (b) The initial condition that $s'(0) = 44$ ft/sec implies that $s'(t) = -kt + 44$ and $s(t) = \frac{-kt^2}{2} + 44t$ where k is as above. The car is stopped at a time t such that $s'(t) = -kt + 44 = 0 \Rightarrow t = \frac{44}{k}$. At this time the car has traveled a distance $s\left(\frac{44}{k}\right) = \frac{-k}{2}\left(\frac{44}{k}\right)^2 + 44\left(\frac{44}{k}\right) = \frac{44^2}{2k} = \frac{968}{k} = 968\left(\frac{200}{88^2}\right) = 25$ feet. Thus halving the initial velocity quarters stopping distance.

28. $h(x) = f^2(x) + g^2(x) \Rightarrow h'(x) = 2f(x)f'(x) + 2g(x)g'(x) = 2[f(x)f'(x) + g(x)g'(x)]$
 $= 2[f(x)g(x) + g(x)(-f(x))] = 2 \cdot 0 = 0$. Thus $h(x) = c$, a constant. Since $h(0) = 5$, $h(x) = 5$ for all x in the domain of h . Thus $h(10) = 5$.

29. Yes. The curve $y = x$ satisfies all three conditions since $\frac{dy}{dx} = 1$ everywhere, when $x = 0$, $y = 0$, and $\frac{d^2y}{dx^2} = 0$ everywhere.

30. $y' = 3x^2 + 2$ for all $x \Rightarrow y = x^3 + 2x + C$ where $-1 = 1^3 + 2 \cdot 1 + C \Rightarrow C = -4 \Rightarrow y = x^3 + 2x - 4$.

31. $s''(t) = a = -t^2 \Rightarrow v = s'(t) = \frac{-t^3}{3} + C$. We seek $v_0 = s'(0) = C$. We know that $s(t^*) = b$ for some t^* and s is at a maximum for this t^* . Since $s(t) = \frac{-t^4}{12} + Ct + k$ and $s(0) = 0$ we have that $s(t) = \frac{-t^4}{12} + Ct$ and also $s'(t^*) = 0$ so that $t^* = (3C)^{1/3}$. So $\frac{[-(3C)^{1/3}]^4}{12} + C(3C)^{1/3} = b \Rightarrow (3C)^{1/3}(C - \frac{3C}{12}) = b \Rightarrow (3C)^{1/3}(\frac{3C}{4}) = b \Rightarrow 3^{1/3}C^{4/3} = \frac{4b}{3} \Rightarrow C = \frac{(4b)^{3/4}}{3}$. Thus $v_0 = s'(0) = \frac{(4b)^{3/4}}{3} = \frac{2\sqrt{2}}{3}b^{3/4}$.
32. (a) $s''(t) = t^{1/2} - t^{-1/2} \Rightarrow v(t) = s'(t) = \frac{2}{3}t^{3/2} - 2t^{1/2} + k$ where $v(0) = k = \frac{4}{3} \Rightarrow v(t) = \frac{2}{3}t^{3/2} - 2t^{1/2} + \frac{4}{3}$.
 (b) $s(t) = \frac{4}{15}t^{5/2} - \frac{4}{3}t^{3/2} + \frac{4}{3}t + k_2$ where $s(0) = k_2 = -\frac{4}{15}$. Thus $s(t) = \frac{4}{15}t^{5/2} - \frac{4}{3}t^{3/2} + \frac{4}{3}t - \frac{4}{15}$.
33. The graph of $f(x) = ax^2 + bx + c$ with $a > 0$ is a parabola opening upwards. Thus $f(x) \geq 0$ for all x if $f(x) = 0$ for at most one real value of x . The solutions to $f(x) = 0$ are, by the quadratic equation $\frac{-2b \pm \sqrt{(2b)^2 - 4ac}}{2a}$. Thus we require $(2b)^2 - 4ac \leq 0 \Rightarrow b^2 - ac \leq 0$.
34. (a) Clearly $f(x) = (a_1x + b_1)^2 + \dots + (a_nx + b_n)^2 \geq 0$ for all x . Expanding we see

$$f(x) = (a_1^2x^2 + 2a_1b_1x + b_1^2) + \dots + (a_n^2x^2 + 2a_nb_nx + b_n^2)$$

$$= (a_1^2 + a_2^2 + \dots + a_n^2)x^2 + 2(a_1b_1 + a_2b_2 + \dots + a_nb_n)x + (b_1^2 + b_2^2 + \dots + b_n^2) \geq 0$$
. Thus

$$(a_1b_1 + a_2b_2 + \dots + a_nb_n)^2 - (a_1^2 + a_2^2 + \dots + a_n^2)(b_1^2 + b_2^2 + \dots + b_n^2) \leq 0$$
 by Exercise 29. Thus

$$(a_1b_1 + a_2b_2 + \dots + a_nb_n)^2 \leq (a_1^2 + a_2^2 + \dots + a_n^2)(b_1^2 + b_2^2 + \dots + b_n^2)$$
.
- (b) Referring to Exercise 33: It is clear that $f(x) = 0$ for some real $x \Leftrightarrow b^2 - 4ac = 0$, by quadratic formula. Now notice that this implies that $f(x) = (a_1x + b_1)^2 + \dots + (a_nx + b_n)^2$

$$= (a_1^2 + a_2^2 + \dots + a_n^2)x^2 + 2(a_1b_1 + a_2b_2 + \dots + a_nb_n)x + (b_1^2 + b_2^2 + \dots + b_n^2) = 0$$

$$\Leftrightarrow (a_1b_1 + a_2b_2 + \dots + a_nb_n)^2 - (a_1^2 + a_2^2 + \dots + a_n^2)(b_1^2 + b_2^2 + \dots + b_n^2) = 0$$

$$\Leftrightarrow (a_1b_1 + a_2b_2 + \dots + a_nb_n)^2 = (a_1^2 + a_2^2 + \dots + a_n^2)(b_1^2 + b_2^2 + \dots + b_n^2)$$
 But now $f(x) = 0 \Leftrightarrow a_ix + b_i = 0$ for all $i = 1, 2, \dots, n \Leftrightarrow a_ix = -b_i = 0$ for all $i = 1, 2, \dots, n$.
35. (a) $L = k \left(\frac{a - b \cot \theta}{R^4} + \frac{b \csc \theta}{r^4} \right) \Rightarrow \frac{dL}{d\theta} = k \left(\frac{b \csc^2 \theta}{R^4} - \frac{b \csc \theta \cot \theta}{r^4} \right)$; solving

$$\frac{dL}{d\theta} = 0 \Rightarrow r^4 b \csc^2 \theta - b R^4 \csc \theta \cot \theta = 0 \Rightarrow (b \csc \theta)(r^4 \csc \theta - R^4 \cot \theta) = 0$$
; but $b \csc \theta \neq 0$ since

$$\theta \neq \frac{\pi}{2} \Rightarrow r^4 \csc \theta - R^4 \cot \theta = 0 \Rightarrow \cos \theta = \frac{r^4}{R^4} \Rightarrow \theta = \cos^{-1} \left(\frac{r^4}{R^4} \right)$$
, the critical value of θ
- (b) $\theta = \cos^{-1} \left(\frac{5}{6} \right)^4 \approx \cos^{-1}(0.48225) \approx 61^\circ$

CHAPTER 5 INTEGRATION

5.1 AREA AND ESTIMATING WITH FINITE SUMS

1. $f(x) = x^2$

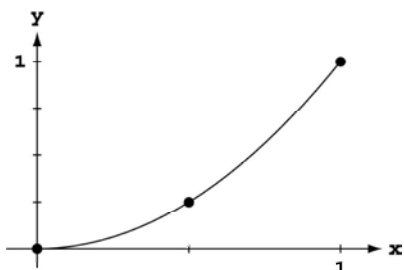

Since f is increasing on $[0, 1]$, we use left endpoints to obtain lower sums and right endpoints to obtain upper sums.

(a) $\Delta x = \frac{1-0}{2} = \frac{1}{2}$ and $x_i = i\Delta x = \frac{i}{2} \Rightarrow$ a lower sum is $\sum_{i=0}^1 \left(\frac{i}{2}\right)^2 \cdot \frac{1}{2} = \frac{1}{2} \left(0^2 + \left(\frac{1}{2}\right)^2\right) = \frac{1}{8}$

(b) $\Delta x = \frac{1-0}{4} = \frac{1}{4}$ and $x_i = i\Delta x = \frac{i}{4} \Rightarrow$ a lower sum is $\sum_{i=0}^3 \left(\frac{i}{4}\right)^2 \cdot \frac{1}{4} = \frac{1}{4} \left(0^2 + \left(\frac{1}{4}\right)^2 + \left(\frac{2}{4}\right)^2 + \left(\frac{3}{4}\right)^2\right) = \frac{1}{4} \cdot \frac{7}{8} = \frac{7}{32}$

(c) $\Delta x = \frac{1-0}{2} = \frac{1}{2}$ and $x_i = i\Delta x = \frac{i}{2} \Rightarrow$ an upper sum is $\sum_{i=1}^2 \left(\frac{i}{2}\right)^2 \cdot \frac{1}{2} = \frac{1}{2} \left(\left(\frac{1}{2}\right)^2 + 1^2\right) = \frac{5}{8}$

(d) $\Delta x = \frac{1-0}{4} = \frac{1}{4}$ and $x_i = i\Delta x = \frac{i}{4} \Rightarrow$ an upper sum is $\sum_{i=1}^4 \left(\frac{i}{4}\right)^2 \cdot \frac{1}{4} = \frac{1}{4} \left(\left(\frac{1}{4}\right)^2 + \left(\frac{2}{4}\right)^2 + \left(\frac{3}{4}\right)^2 + 1^2\right) = \frac{1}{4} \cdot \left(\frac{30}{16}\right) = \frac{15}{32}$

2. $f(x) = x^3$

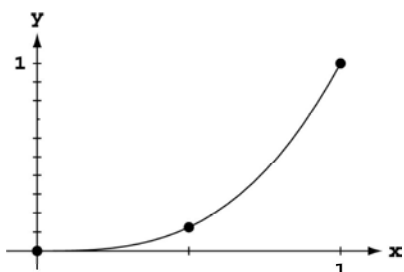

Since f is increasing on $[0, 1]$, we use left endpoints to obtain lower sums and right endpoints to obtain upper sums.

(a) $\Delta x = \frac{1-0}{2} = \frac{1}{2}$ and $x_i = i\Delta x = \frac{i}{2} \Rightarrow$ a lower sum is $\sum_{i=0}^1 \left(\frac{i}{2}\right)^3 \cdot \frac{1}{2} = \frac{1}{2} \left(0^3 + \left(\frac{1}{2}\right)^3\right) = \frac{1}{16}$

(b) $\Delta x = \frac{1-0}{4} = \frac{1}{4}$ and $x_i = i\Delta x = \frac{i}{4} \Rightarrow$ a lower sum is $\sum_{i=0}^3 \left(\frac{i}{4}\right)^3 \cdot \frac{1}{4} = \frac{1}{4} \left(0^3 + \left(\frac{1}{4}\right)^3 + \left(\frac{2}{4}\right)^3 + \left(\frac{3}{4}\right)^3\right) = \frac{36}{256} = \frac{9}{64}$

(c) $\Delta x = \frac{1-0}{2} = \frac{1}{2}$ and $x_i = i\Delta x = \frac{i}{2} \Rightarrow$ an upper sum is $\sum_{i=1}^2 \left(\frac{i}{2}\right)^3 \cdot \frac{1}{2} = \frac{1}{2} \left(\left(\frac{1}{2}\right)^3 + 1^3\right) = \frac{1}{2} \cdot \frac{9}{8} = \frac{9}{16}$

(d) $\Delta x = \frac{1-0}{4} = \frac{1}{4}$ and $x_i = i\Delta x = \frac{i}{4} \Rightarrow$ an upper sum is $\sum_{i=1}^4 \left(\frac{i}{4}\right)^3 \cdot \frac{1}{4} = \frac{1}{4} \left(\left(\frac{1}{4}\right)^3 + \left(\frac{2}{4}\right)^3 + \left(\frac{3}{4}\right)^3 + 1^3\right) = \frac{100}{256} = \frac{25}{64}$

3. $f(x) = \frac{1}{x}$

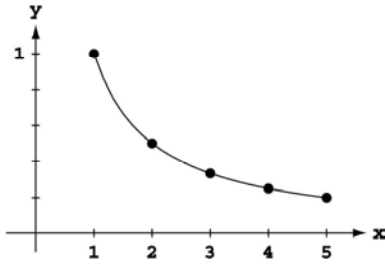

Since f is decreasing on $[1, 5]$, we use left endpoints to obtain upper sums and right endpoints to obtain lower sums.

(a) $\Delta x = \frac{5-1}{2} = 2$ and $x_i = 1 + i\Delta x = 1 + 2i \Rightarrow$ a lower sum is $\sum_{i=1}^2 \frac{1}{x_i} \cdot 2 = 2\left(\frac{1}{3} + \frac{1}{5}\right) = \frac{16}{15}$

(b) $\Delta x = \frac{5-1}{4} = 1$ and $x_i = 1 + i\Delta x = 1 + i \Rightarrow$ a lower sum is $\sum_{i=1}^4 \frac{1}{x_i} \cdot 1 = 1\left(\frac{1}{2} + \frac{1}{3} + \frac{1}{4} + \frac{1}{5}\right) = \frac{77}{60}$

(c) $\Delta x = \frac{5-1}{2} = 2$ and $x_i = 1 + i\Delta x = 1 + 2i \Rightarrow$ an upper sum is $\sum_{i=0}^1 \frac{1}{x_i} \cdot 2 = 2\left(1 + \frac{1}{3}\right) = \frac{8}{3}$

(d) $\Delta x = \frac{5-1}{4} = 1$ and $x_i = 1 + i\Delta x = 1 + i \Rightarrow$ an upper sum is $\sum_{i=0}^3 \frac{1}{x_i} \cdot 1 = 1\left(1 + \frac{1}{2} + \frac{1}{3} + \frac{1}{4}\right) = \frac{25}{12}$

4. $f(x) = 4 - x^2$

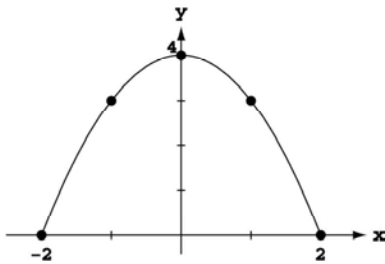

Since f is increasing on $[-2, 0]$ and decreasing on $[0, 2]$, we use left endpoints on $[-2, 0]$ and right endpoints on $[0, 2]$ to obtain lower sums and use right endpoints on $[-2, 0]$ and left endpoints on $[0, 2]$ to obtain upper sums.

(a) $\Delta x = \frac{2-(-2)}{2} = 2$ and $x_i = -2 + i\Delta x = -2 + 2i \Rightarrow$ a lower sum is $2 \cdot (4 - (-2)^2) + 2 \cdot (4 - 2^2) = 0$

(b) $\Delta x = \frac{2-(-2)}{4} = 1$ and $x_i = -2 + i\Delta x = -2 + i \Rightarrow$ a lower sum is $\sum_{i=0}^1 (4 - (x_i)^2) \cdot 1 + \sum_{i=3}^4 (4 - (x_i)^2) \cdot 1$
 $= 1((4 - (-2)^2) + (4 - (-1)^2) + (4 - 1^2) + (4 - 2^2)) = 6$

(c) $\Delta x = \frac{2-(-2)}{2} = 2$ and $x_i = -2 + i\Delta x = -2 + 2i \Rightarrow$ an upper sum is $2 \cdot (4 - (0)^2) + 2 \cdot (4 - 0^2) = 16$

(d) $\Delta x = \frac{2-(-2)}{4} = 1$ and $x_i = -2 + i\Delta x = -2 + i \Rightarrow$ an upper sum is $\sum_{i=1}^2 (4 - (x_i)^2) \cdot 1 + \sum_{i=2}^3 (4 - (x_i)^2) \cdot 1$
 $= 1((4 - (-1)^2) + (4 - 0^2) + (4 - 0^2) + (4 - 1^2)) = 14$

5. $f(x) = x^2$

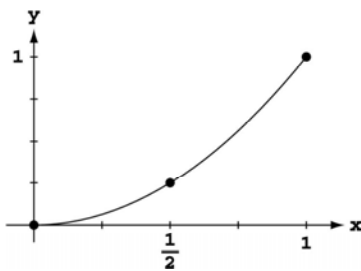

Using 2 rectangles $\Rightarrow \Delta x = \frac{1-0}{2} = \frac{1}{2}$

$\Rightarrow \frac{1}{2} \left(f\left(\frac{1}{4}\right) + f\left(\frac{3}{4}\right) \right) = \frac{1}{2} \left(\left(\frac{1}{4}\right)^2 + \left(\frac{3}{4}\right)^2 \right) = \frac{10}{32} = \frac{5}{16}$

Using 4 rectangles $\Rightarrow \Delta x = \frac{1-0}{4} = \frac{1}{4}$

$\Rightarrow \frac{1}{4} \left(f\left(\frac{1}{8}\right) + f\left(\frac{3}{8}\right) + f\left(\frac{5}{8}\right) + f\left(\frac{7}{8}\right) \right)$
 $= \frac{1}{4} \left(\left(\frac{1}{8}\right)^2 + \left(\frac{3}{8}\right)^2 + \left(\frac{5}{8}\right)^2 + \left(\frac{7}{8}\right)^2 \right) = \frac{21}{64}$

6. $f(x) = x^3$

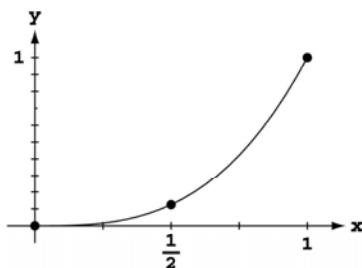

Using 2 rectangles $\Rightarrow \Delta x = \frac{1-0}{2} = \frac{1}{2}$
 $\Rightarrow \frac{1}{2} \left(f\left(\frac{1}{4}\right) + f\left(\frac{3}{4}\right) \right) = \frac{1}{2} \left(\left(\frac{1}{4}\right)^3 + \left(\frac{3}{4}\right)^3 \right) = \frac{28}{2 \cdot 64} = \frac{7}{32}$

Using 4 rectangles $\Rightarrow \Delta x = \frac{1-0}{4} = \frac{1}{4}$
 $\Rightarrow \frac{1}{4} \left(f\left(\frac{1}{8}\right) + f\left(\frac{3}{8}\right) + f\left(\frac{5}{8}\right) + f\left(\frac{7}{8}\right) \right)$
 $= \frac{1}{4} \left(\frac{1^3+3^3+5^3+7^3}{8^3} \right) = \frac{496}{4 \cdot 8^3} = \frac{124}{8^3} = \frac{31}{128}$

7. $f(x) = \frac{1}{x}$

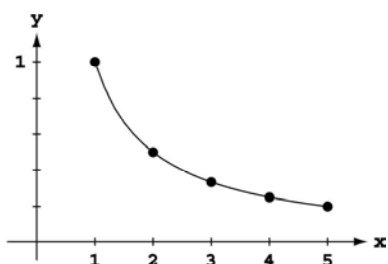

Using 2 rectangles $\Rightarrow \Delta x = \frac{5-1}{2} = 2 \Rightarrow 2(f(2) + f(4))$
 $= 2 \left(\frac{1}{2} + \frac{1}{4} \right) = \frac{3}{2}$

Using 4 rectangles $\Rightarrow \Delta x = \frac{5-1}{4} = 1$
 $\Rightarrow 1 \left(f\left(\frac{3}{2}\right) + f\left(\frac{5}{2}\right) + f\left(\frac{7}{2}\right) + f\left(\frac{9}{2}\right) \right) = 1 \left(\frac{2}{3} + \frac{2}{5} + \frac{2}{7} + \frac{2}{9} \right)$
 $= \frac{1488}{3 \cdot 5 \cdot 7 \cdot 9} = \frac{496}{5 \cdot 7 \cdot 9} = \frac{496}{315}$

8. $f(x) = 4 - x^2$

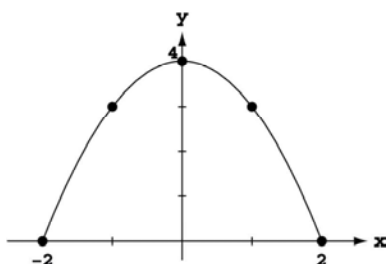

Using 2 rectangles $\Rightarrow \Delta x = \frac{2-(-2)}{2} = 2$
 $\Rightarrow 2(f(-1) + f(1)) = 2(3 + 3) = 12$

Using 4 rectangles $\Rightarrow \Delta x = \frac{2-(-2)}{4} = 1$
 $\Rightarrow 1 \left(f\left(-\frac{3}{2}\right) + f\left(-\frac{1}{2}\right) + f\left(\frac{1}{2}\right) + f\left(\frac{3}{2}\right) \right)$
 $= 1 \left(\left(4 - \left(-\frac{3}{2}\right)^2 \right) + \left(4 - \left(-\frac{1}{2}\right)^2 \right) + \left(4 - \left(\frac{1}{2}\right)^2 \right) + \left(4 - \left(\frac{3}{2}\right)^2 \right) \right)$
 $= 16 - \left(\frac{9}{4} \cdot 2 + \frac{1}{4} \cdot 2 \right) = 16 - \frac{10}{2} = 11$

9. (a) $D \approx (0)(1) + (12)(1) + (22)(1) + (10)(1) + (5)(1) + (13)(1) + (11)(1) + (6)(1) + (2)(1) + (6)(1) = 87$ inches
 (b) $D \approx (12)(1) + (22)(1) + (10)(1) + (5)(1) + (13)(1) + (11)(1) + (6)(1) + (2)(1) + (6)(1) + (0)(1) = 87$ inches

10. (a) $D \approx (1)(300) + (1.2)(300) + (1.7)(300) + (2.0)(300) + (1.8)(300) + (1.6)(300) + (1.4)(300) + (1.2)(300) + (1.0)(300) + (1.8)(300) + (1.5)(300) + (1.2)(300) = 5220$ meters (NOTE: 5 minutes = 300 seconds)
 (b) $D \approx (1.2)(300) + (1.7)(300) + (2.0)(300) + (1.8)(300) + (1.6)(300) + (1.4)(300) + (1.2)(300) + (1.0)(300) + (1.8)(300) + (1.5)(300) + (1.2)(300) + (0)(300) = 4920$ meters (NOTE: 5 minutes = 300 seconds)

11. (a) $D \approx (0)(10) + (44)(10) + (15)(10) + (35)(10) + (30)(10) + (44)(10) + (35)(10) + (15)(10) + (22)(10) + (35)(10) + (44)(10) + (30)(10) = 3490$ feet ≈ 0.66 miles
 (b) $D \approx (44)(10) + (15)(10) + (35)(10) + (30)(10) + (44)(10) + (35)(10) + (15)(10) + (22)(10) + (35)(10) + (44)(10) + (30)(10) + (35)(10) = 3840$ feet ≈ 0.73 miles

12. (a) The distance traveled will be the area under the curve. We will use the approximate velocities at the midpoints of each time interval to approximate this area using rectangles. Thus,
 $D \approx (20)(0.001) + (50)(0.001) + (72)(0.001) + (90)(0.001) + (102)(0.001) + (112)(0.001) + (120)(0.001) + (128)(0.001) + (134)(0.001) + (139)(0.001) \approx 0.967$ miles
 (b) Roughly, after 0.0063 hours, the car would have gone 0.484 miles, where 0.0060 hours = 22.7 sec. At 22.7 sec, the velocity was approximately 120 mi/hr.

13. (a) Because the acceleration is decreasing, an upper estimate is obtained using left endpoints in summing acceleration $\cdot \Delta t$. Thus, $\Delta t = 1$ and speed $\approx [32.00 + 19.41 + 11.77 + 7.14 + 4.33](1) = 74.65$ ft/sec
 (b) Using right endpoints we obtain a lower estimate: speed $\approx [19.41 + 11.77 + 7.14 + 4.33 + 2.63](1) = 45.28$ ft/sec
 (c) Upper estimates for the speed at each second are:

t	0	1	2	3	4	5
v	0	32.00	51.41	63.18	70.32	74.65

Thus, the distance fallen when $t = 3$ seconds is $s \approx [32.00 + 51.41 + 63.18](1) = 146.59$ ft.

14. (a) The speed is a decreasing function of time \Rightarrow right endpoints give a lower estimate for the height (distance) attained. Also

t	0	1	2	3	4	5
v	400	368	336	304	272	240

gives the time-velocity table by subtracting the constant $g = 32$ from the speed at each time increment $\Delta t = 1$ sec. Thus, the speed ≈ 240 ft/sec after 5 seconds.

- (b) A lower estimate for height attained is $h \approx [368 + 336 + 304 + 272 + 240](1) = 1520$ ft.
15. Partition $[0, 2]$ into the four subintervals $[0, 0.5]$, $[0.5, 1]$, $[1, 1.5]$, and $[1.5, 2]$. The midpoints of these subintervals are $m_1 = 0.25$, $m_2 = 0.75$, $m_3 = 1.25$, and $m_4 = 1.75$. The heights of the four approximating rectangles are $f(m_1) = (0.25)^3 = \frac{1}{64}$, $f(m_2) = (0.75)^3 = \frac{27}{64}$, $f(m_3) = (1.25)^3 = \frac{125}{64}$, and $f(m_4) = (1.75)^3 = \frac{343}{64}$

Notice that the average value is approximated by $\frac{1}{2} \left[\left(\frac{1}{4}\right)^3 \left(\frac{1}{2}\right) + \left(\frac{3}{4}\right)^3 \left(\frac{1}{2}\right) + \left(\frac{5}{4}\right)^3 \left(\frac{1}{2}\right) + \left(\frac{7}{4}\right)^3 \left(\frac{1}{2}\right) \right] = \frac{31}{16}$

$= \frac{1}{\text{length of } [0, 2]} \cdot \left[\begin{array}{c} \text{approximate area under} \\ \text{curve } f(x) = x^3 \end{array} \right]$. We use this observation in solving the next several exercises.

16. Partition $[1, 9]$ into the four subintervals $[1, 3]$, $[3, 5]$, $[5, 7]$, and $[7, 9]$. The midpoints of these subintervals are $m_1 = 2$, $m_2 = 4$, $m_3 = 6$, and $m_4 = 8$. The heights of the four approximating rectangles are $f(m_1) = \frac{1}{2}$, $f(m_2) = \frac{1}{4}$, $f(m_3) = \frac{1}{6}$, and $f(m_4) = \frac{1}{8}$. The width of each rectangle is $\Delta x = 2$. Thus,

$$\text{Area} \approx 2 \left(\frac{1}{2} \right) + 2 \left(\frac{1}{4} \right) + 2 \left(\frac{1}{6} \right) + 2 \left(\frac{1}{8} \right) = \frac{25}{12} \Rightarrow \text{average value} \approx \frac{\text{area}}{\text{length of } [1, 9]} = \frac{\left(\frac{25}{12}\right)}{8} = \frac{25}{96}.$$

17. Partition $[0, 2]$ into the four subintervals $[0, 0.5]$, $[0.5, 1]$, $[1, 1.5]$, and $[1.5, 2]$. The midpoints of the subintervals are $m_1 = 0.25$, $m_2 = 0.75$, $m_3 = 1.25$, and $m_4 = 1.75$. The heights of the four approximating rectangles are $f(m_1) = \frac{1}{2} + \sin^2 \frac{\pi}{4} = \frac{1}{2} + \frac{1}{2} = 1$, $f(m_2) = \frac{1}{2} + \sin^2 \frac{3\pi}{4} = \frac{1}{2} + \frac{1}{2} = 1$, $f(m_3) = \frac{1}{2} + \sin^2 \frac{5\pi}{4} = \frac{1}{2} + \left(-\frac{1}{\sqrt{2}}\right)^2 = \frac{1}{2} + \frac{1}{2} = 1$, and $f(m_4) = \frac{1}{2} + \sin^2 \frac{7\pi}{4} = \frac{1}{2} + \left(-\frac{1}{\sqrt{2}}\right)^2 = 1$. The width of each rectangle is $\Delta x = \frac{1}{2}$. Thus, $\text{Area} \approx (1 + 1 + 1 + 1) \left(\frac{1}{2}\right) = 2 \Rightarrow \text{average value} \approx \frac{\text{area}}{\text{length of } [0, 2]} = \frac{2}{2} = 1$.

18. Partition $[0, 4]$ into the four subintervals $[0, 1]$, $[1, 2]$, $[2, 3]$, and $[3, 4]$. The midpoints of the subintervals are $m_1 = \frac{1}{2}$, $m_2 = \frac{3}{2}$, $m_3 = \frac{5}{2}$, and $m_4 = \frac{7}{2}$. The heights of the four approximating rectangles are

$$f(m_1) = 1 - \left(\cos \left(\frac{\pi \left(\frac{1}{2}\right)}{4} \right) \right)^4 = 1 - \left(\cos \left(\frac{\pi}{8} \right) \right)^4 = 0.27145 \text{ (to 5 decimal places), } f(m_2) = 1 - \left(\cos \left(\frac{\pi \left(\frac{3}{2}\right)}{4} \right) \right)^4$$

$$= 1 - \left(\cos \left(\frac{3\pi}{8} \right) \right)^4 = 0.97855, f(m_3) = 1 - \left(\cos \left(\frac{\pi \left(\frac{5}{2}\right)}{4} \right) \right)^4 = 1 - \left(\cos \left(\frac{5\pi}{8} \right) \right)^4 = 0.97855, \text{ and}$$

$$f(m_4) = 1 - \left(\cos \left(\frac{\pi \left(\frac{7}{2} \right)}{4} \right) \right)^4 = 1 - \left(\cos \left(\frac{7\pi}{8} \right) \right)^4 = 0.27145. \text{ The width of each rectangle is } \Delta x = 1. \text{ Thus,}$$

$$\text{Area} \approx (0.27145)(1) + (0.97855)(1) + (0.97855)(1) + (0.27145)(1) = 2.5 \Rightarrow \text{average value} \approx \frac{\text{area}}{\text{length of } [0,4]} = \frac{2.5}{4} = \frac{5}{8}$$

19. Since the leakage is increasing, an upper estimate uses right endpoints and a lower estimate uses left endpoints:

(a) upper estimate = $(70)(1) + (97)(1) + (136)(1) + (190)(1) + (265)(1) = 758$ gal,

lower estimate = $(50)(1) + (70)(1) + (97)(1) + (136)(1) + (190)(1) = 543$ gal.

(b) upper estimate = $(70 + 97 + 136 + 190 + 265 + 369 + 516 + 720) = 2363$ gal,

lower estimate = $(50 + 70 + 97 + 136 + 190 + 265 + 369 + 516) = 1693$ gal.

(c) worst case: $2363 + 720t = 25,000 \Rightarrow t \approx 31.4$ hrs;

best case: $1693 + 720t = 25,000 \Rightarrow t \approx 32.4$ hrs

20. Since the pollutant release increases over time, an upper estimate uses right endpoints and a lower estimate uses left endpoints;

(a) upper estimate = $(0.2)(30) + (0.25)(30) + (0.27)(30) + (0.34)(30) + (0.45)(30) + (0.52)(30) = 60.9$ tons

lower estimate = $(0.05)(30) + (0.2)(30) + (0.25)(30) + (0.27)(30) + (0.34)(30) + (0.45)(30) = 46.8$ tons

(b) Using the lower (best case) estimate: $46.8 + (0.52)(30) + (0.63)(30) + (0.70)(30) + (0.81)(30) = 126.6$ tons, so near the end of September 125 tons of pollutants will have been released.

21. (a) The diagonal of the square has length 2, so the side length is $\sqrt{2}$. Area = $(\sqrt{2})^2 = 2$

(b) Think of the octagon as a collection of 16 right triangles with a hypotenuse of length 1 and an acute angle measuring $\frac{2\pi}{16} = \frac{\pi}{8}$.

$$\text{Area} = 16 \left(\frac{1}{2} \right) \left(\sin \frac{\pi}{8} \right) \left(\cos \frac{\pi}{8} \right) = 4 \sin \frac{\pi}{4} = 2\sqrt{2} \approx 2.828$$

(c) Think of the 16-gon as a collection of 32 right triangles with a hypotenuse of length 1 and an acute angle measuring $\frac{2\pi}{32} = \frac{\pi}{16}$.

$$\text{Area} = 32 \left(\frac{1}{2} \right) \left(\sin \frac{\pi}{16} \right) \left(\cos \frac{\pi}{16} \right) = 8 \sin \frac{\pi}{8} = 2\sqrt{2} \approx 3.061$$

(d) Each area is less than the area of the circle, π . As n increase, the area approaches π .

22. (a) Each of the isosceles triangles is made up of two right triangles having hypotenuse 1 and an acute angle measuring $\frac{2\pi}{2n} = \frac{\pi}{n}$. The area of each isosceles triangle is $A_T = 2 \left(\frac{1}{2} \right) \left(\sin \frac{\pi}{n} \right) \left(\cos \frac{\pi}{n} \right) = \frac{1}{2} \sin \frac{2\pi}{n}$.

(b) The area of the polygon is $A_P = nA_T = \frac{n}{2} \sin \frac{2\pi}{n}$, so $\lim_{n \rightarrow \infty} \frac{n}{2} \sin \frac{2\pi}{n} = \lim_{n \rightarrow \infty} \pi \cdot \frac{\sin \frac{2\pi}{n}}{\left(\frac{2\pi}{n} \right)} = \pi$

(c) Multiply each area by r^2 .

$$A_T = \frac{1}{2} r^2 \sin \frac{2\pi}{n}$$

$$A_P = \frac{n}{2} r^2 \sin \frac{2\pi}{n}$$

$$\lim_{n \rightarrow \infty} A_P = \pi r^2$$

23-26. Example CAS commands:

Maple:

with(Student[Calculus 1]);

f := x -> sin(x);

a := 0;

b := Pi;

Plot(f(x), x=a..b, title="#23(a) (Section 5.1)");

N := [100, 200, 1000];

(b)

```

for n in N do
  Xlist := [ a+1.*(b-a)/n*i $ i=0..n ];
  Ylist := map( f, Xlist );
end do;
for n in N do
  Avg[n] := evalf(add(y,y=Ylist)/nops(Ylist));
end do;
avg := FunctionAverage( f(x), x=a..b, output=value );
evalf( avg );
FunctionAverage(f(x),x=a..b, output=plot);
fsolve( f(x)=avg, x=0.5 );
fsolve( f(x)=avg, x=2.5 );
fsolve( f(x)=Avg[1000], x=0.5 );
fsolve( f(x)=Avg[1000], x=2.5 );

```

Mathematica: (assigned function and values for a and b may vary):
 Symbols for π , \rightarrow , powers, roots, fractions, etc. are available in Palettes.
 Never insert a space between the name of a function and its argument.

```

Clear[x]
f[x_]:=x Sin[1/x]
{a, b}={π/4, π}
Plot[f[x],{x, a, b}]

```

The following code computes the value of the function for each interval midpoint and then finds the average. Each sequence of commands for a different value of n (number of subdivisions) should be placed in a separate cell.

```

n =100; dx = (b - a) /n;
values = Table[N[f[x]], {x, a + dx/2, b, dx}]
average=Sum[values[[i]],{i, 1, Length[values]}/ n
n =200; dx = (b - a) /n;
values = Table[N[f[x]], {x, a + dx/2, b, dx}]
average=Sum[values[[i]],{i, 1, Length[values]}/ n
n =1000; dx = (b - a) /n;
values=Table[N[f[x]],{x, a + dx/2, b, dx}]
average=Sum[values[[i]],{i, 1, Length[values]}/ n
FindRoot[f[x] == average, {x, a}]

```

5.2 SIGMA NOTATION AND LIMITS OF FINITE SUMS

- $$\sum_{k=1}^2 \frac{6k}{k+1} = \frac{6(1)}{1+1} + \frac{6(2)}{2+1} = \frac{6}{2} + \frac{12}{3} = 7$$
- $$\sum_{k=1}^3 \frac{k-1}{k} = \frac{1-1}{1} + \frac{2-1}{2} + \frac{3-1}{3} = 0 + \frac{1}{2} + \frac{2}{3} = \frac{7}{6}$$
- $$\sum_{k=1}^4 \cos k\pi = \cos(1\pi) + \cos(2\pi) + \cos(3\pi) + \cos(4\pi) = -1 + 1 - 1 + 1 = 0$$

4. $\sum_{k=1}^5 \sin k\pi = \sin(1\pi) + \sin(2\pi) + \sin(3\pi) + \sin(4\pi) + \sin(5\pi) = 0 + 0 + 0 + 0 + 0 = 0$

5. $\sum_{k=1}^3 (-1)^{k+1} \sin \frac{\pi}{k} = (-1)^{1+1} \sin \frac{\pi}{1} + (-1)^{2+1} \sin \frac{\pi}{2} + (-1)^{3+1} \sin \frac{\pi}{3} = 0 - 1 + \frac{\sqrt{3}}{2} = \frac{\sqrt{3}-2}{2}$

6. $\sum_{k=1}^4 (-1)^k \cos k\pi = (-1)^1 \cos(1\pi) + (-1)^2 \cos(2\pi) + (-1)^3 \cos(3\pi) + (-1)^4 \cos(4\pi) = -(-1) + 1 - (-1) + 1 = 4$

7. (a) $\sum_{k=1}^6 2^{k-1} = 2^{1-1} + 2^{2-1} + 2^{3-1} + 2^{4-1} + 2^{5-1} + 2^{6-1} = 1 + 2 + 4 + 8 + 16 + 32$

(b) $\sum_{k=0}^5 2^k = 2^0 + 2^1 + 2^2 + 2^3 + 2^4 + 2^5 = 1 + 2 + 4 + 8 + 16 + 32$

(c) $\sum_{k=1}^4 2^{k+1} = 2^{-1+1} + 2^{0+1} + 2^{1+1} + 2^{2+1} + 2^{3+1} + 2^{4+1} = 1 + 2 + 4 + 8 + 16 + 32$

All of them represent $1 + 2 + 4 + 8 + 16 + 32$

8. (a) $\sum_{k=1}^6 (-2)^{k-1} = (-2)^{1-1} + (-2)^{2-1} + (-2)^{3-1} + (-2)^{4-1} + (-2)^{5-1} + (-2)^{6-1} = 1 - 2 + 4 - 8 + 16 - 32$

(b) $\sum_{k=0}^5 (-1)^k 2^k = (-1)^0 2^0 + (-1)^1 2^1 + (-1)^2 2^2 + (-1)^3 2^3 + (-1)^4 2^4 + (-1)^5 2^5 = 1 - 2 + 4 - 8 + 16 - 32$

(c) $\sum_{k=-2}^3 (-1)^{k+1} 2^{k+2} = (-1)^{-2+1} 2^{-2+2} + (-1)^{-1+1} 2^{-1+2} + (-1)^{0+1} 2^{0+2} + (-1)^{1+1} 2^{1+2} + (-1)^{2+1} 2^{2+2} + (-1)^{3+1} 2^{3+2}$
 $= -1 + 2 - 4 + 8 - 16 + 32;$

(a) and (b) represent $1 - 2 + 4 - 8 + 16 - 32$; (c) is not equivalent to the other two

9. (a) $\sum_{k=2}^4 \frac{(-1)^{k-1}}{k-1} = \frac{(-1)^{2-1}}{2-1} + \frac{(-1)^{3-1}}{3-1} + \frac{(-1)^{4-1}}{4-1} = -1 + \frac{1}{2} - \frac{1}{3}$

(b) $\sum_{k=0}^2 \frac{(-1)^k}{k+1} = \frac{(-1)^0}{0+1} + \frac{(-1)^1}{1+1} + \frac{(-1)^2}{2+1} = 1 - \frac{1}{2} + \frac{1}{3}$

(c) $\sum_{k=-1}^1 \frac{(-1)^k}{k+2} = \frac{(-1)^{-1}}{-1+2} + \frac{(-1)^0}{0+2} + \frac{(-1)^1}{1+2} = -1 + \frac{1}{2} - \frac{1}{3}$

(a) and (c) are equivalent; (b) is not equivalent to the other two.

10. (a) $\sum_{k=1}^4 (k-1)^2 = (1-1)^2 + (2-1)^2 + (3-1)^2 + (4-1)^2 = 0 + 1 + 4 + 9$

(b) $\sum_{k=-1}^3 (k+1)^2 = (-1+1)^2 + (0+1)^2 + (1+1)^2 + (2+1)^2 + (3+1)^2 = 0 + 1 + 4 + 9 + 16$

(c) $\sum_{k=-3}^{-1} k^2 = (-3)^2 + (-2)^2 + (-1)^2 = 9 + 4 + 1$

(a) and (c) are equivalent to each other; (b) is not equivalent to the other two.

11. $\sum_{k=1}^6 k$

12. $\sum_{k=1}^4 k^2$

13. $\sum_{k=1}^4 \frac{1}{2^k}$

14. $\sum_{k=1}^5 2k$

15. $\sum_{k=1}^5 (-1)^{k+1} \frac{1}{k}$

16. $\sum_{k=1}^5 (-1)^k \frac{k}{5}$

17. (a) $\sum_{k=1}^n 3a_k = 3 \sum_{k=1}^n a_k = 3(-5) = -15$
 (b) $\sum_{k=1}^n \frac{b_k}{6} = \frac{1}{6} \sum_{k=1}^n b_k = \frac{1}{6}(6) = 1$
 (c) $\sum_{k=1}^n (a_k + b_k) = \sum_{k=1}^n a_k + \sum_{k=1}^n b_k = -5 + 6 = 1$
 (d) $\sum_{k=1}^n (a_k - b_k) = \sum_{k=1}^n a_k - \sum_{k=1}^n b_k = -5 - 6 = -11$
 (e) $\sum_{k=1}^n (b_k - 2a_k) = \sum_{k=1}^n b_k - 2 \sum_{k=1}^n a_k = 6 - 2(-5) = 16$
18. (a) $\sum_{k=1}^n 8a_k = 8 \sum_{k=1}^n a_k = 8(0) = 0$
 (b) $\sum_{k=1}^n 250b_k = 250 \sum_{k=1}^n b_k = 250(1) = 250$
 (c) $\sum_{k=1}^n (a_k + 1) = \sum_{k=1}^n a_k + \sum_{k=1}^n 1 = 0 + n = n$
 (d) $\sum_{k=1}^n (b_k - 1) = \sum_{k=1}^n b_k - \sum_{k=1}^n 1 = 1 - n$
19. (a) $\sum_{k=1}^{10} k = \frac{10(10+1)}{2} = 55$
 (b) $\sum_{k=1}^{10} k^2 = \frac{10(10+1)(2(10)+1)}{6} = 385$
 (c) $\sum_{k=1}^{10} k^3 = \left[\frac{10(10+1)}{2} \right]^2 = 55^2 = 3025$
20. (a) $\sum_{k=1}^{13} k = \frac{13(13+1)}{2} = 91$
 (b) $\sum_{k=1}^{13} k^2 = \frac{13(13+1)(2(13)+1)}{6} = 819$
 (c) $\sum_{k=1}^{13} k^3 = \left[\frac{13(13+1)}{2} \right]^2 = 91^2 = 8281$
21. $\sum_{k=1}^7 -2k = -2 \sum_{k=1}^7 k = -2 \left(\frac{7(7+1)}{2} \right) = -56$
22. $\sum_{k=1}^5 \frac{\pi k}{15} = \frac{\pi}{15} \sum_{k=1}^5 k = \frac{\pi}{15} \left(\frac{5(5+1)}{2} \right) = \pi$
23. $\sum_{k=1}^6 (3 - k^2) = \sum_{k=1}^6 3 - \sum_{k=1}^6 k^2 = 3(6) - \frac{6(6+1)(2(6)+1)}{6} = -73$
24. $\sum_{k=1}^6 (k^2 - 5) = \sum_{k=1}^6 k^2 - \sum_{k=1}^6 5 = \frac{6(6+1)(2(6)+1)}{6} - 5(6) = 61$
25. $\sum_{k=1}^5 k(3k + 5) = \sum_{k=1}^5 (3k^2 + 5k) = 3 \sum_{k=1}^5 k^2 + 5 \sum_{k=1}^5 k = 3 \left(\frac{5(5+1)(2(5)+1)}{6} \right) + 5 \left(\frac{5(5+1)}{2} \right) = 240$
26. $\sum_{k=1}^7 k(2k + 1) = \sum_{k=1}^7 (2k^2 + k) = 2 \sum_{k=1}^7 k^2 + \sum_{k=1}^7 k = 2 \left(\frac{7(7+1)(2(7)+1)}{6} \right) + \frac{7(7+1)}{2} = 308$
27. $\sum_{k=1}^5 \frac{k^3}{225} + \left(\sum_{k=1}^5 k \right)^3 = \frac{1}{225} \sum_{k=1}^5 k^3 + \left(\sum_{k=1}^5 k \right)^3 = \frac{1}{225} \left(\frac{5(5+1)}{2} \right)^2 + \left(\frac{5(5+1)}{2} \right)^3 = 3376$
28. $\left(\sum_{k=1}^7 k \right)^2 - \sum_{k=1}^7 \frac{k^3}{4} = \left(\sum_{k=1}^7 k \right)^2 - \frac{1}{4} \sum_{k=1}^7 k^3 = \left(\frac{7(7+1)}{2} \right)^2 - \frac{1}{4} \left(\frac{7(7+1)}{2} \right)^2 = 588$

29. (a) $\sum_{k=1}^7 3 = 3(7) = 21$ (b) $\sum_{k=1}^{500} 7 = 7(500) = 3500$
 (c) Let $j = k - 2 \Rightarrow k = j + 2$; if $k = 3 \Rightarrow j = 1$ and if $k = 264 \Rightarrow j = 262 \Rightarrow \sum_{k=3}^{264} 10 = \sum_{j=1}^{262} 10 = 10(262) = 2620$
30. (a) Let $j = k - 8 \Rightarrow k = j + 8$; if $k = 9 \Rightarrow j = 1$ and if $k = 36 \Rightarrow j = 28 \Rightarrow \sum_{k=9}^{36} k = \sum_{j=1}^{28} (j + 8) = \sum_{j=1}^{28} j + \sum_{j=1}^{28} 8 = \frac{28(28+1)}{2} + 8(28) = 630$
 (b) Let $j = k - 2 \Rightarrow k = j + 2$; if $k = 3 \Rightarrow j = 1$ and if $k = 17 \Rightarrow j = 15 \Rightarrow \sum_{k=3}^{17} k^2 = \sum_{j=1}^{15} (j + 2)^2 = \sum_{j=1}^{15} (j^2 + 4j + 4) = \sum_{j=1}^{15} j^2 + \sum_{j=1}^{15} 4j + \sum_{j=1}^{15} 4 = \frac{15(15+1)(2(15)+1)}{6} + 4 \cdot \frac{15(15+1)}{2} + 4(15) = 1240 + 480 + 60 = 1780$
 (c) Let $j = k - 17 \Rightarrow k = j + 17$; if $k = 18 \Rightarrow j = 1$ and if $k = 71 \Rightarrow j = 54 \Rightarrow \sum_{k=3}^{71} k(k - 1) = \sum_{j=1}^{54} (j + 17)((j + 17) - 1) = \sum_{j=1}^{54} (j^2 + 33j + 272) = \sum_{j=1}^{54} j^2 + \sum_{j=1}^{54} 33j + \sum_{j=1}^{54} 272 = \frac{54(54+1)(2(54)+1)}{6} + 33 \cdot \frac{54(54+1)}{2} + 272(54) = 53955 + 49005 + 14688 = 117648$

31. (a) $\sum_{k=1}^n 4 = 4n$ (b) $\sum_{k=1}^n c = cn$
 (c) $\sum_{k=1}^n (k - 1) = \sum_{k=1}^n k - \sum_{k=1}^n 1 = \frac{n(n+1)}{2} - n = \frac{n^2 - n}{2}$
32. (a) $\sum_{k=1}^n \left(\frac{1}{n} + 2n\right) = \left(\frac{1}{n} + 2n\right)n = 1 + 2n^2$ (b) $\sum_{k=1}^n \frac{c}{n} = \frac{c}{n} \cdot n = c$
 (c) $\sum_{k=1}^n \frac{k}{n^2} = \frac{1}{n^2} \sum_{k=1}^n k = \frac{1}{n^2} \cdot \frac{n(n+1)}{2} = \frac{n+1}{2n}$

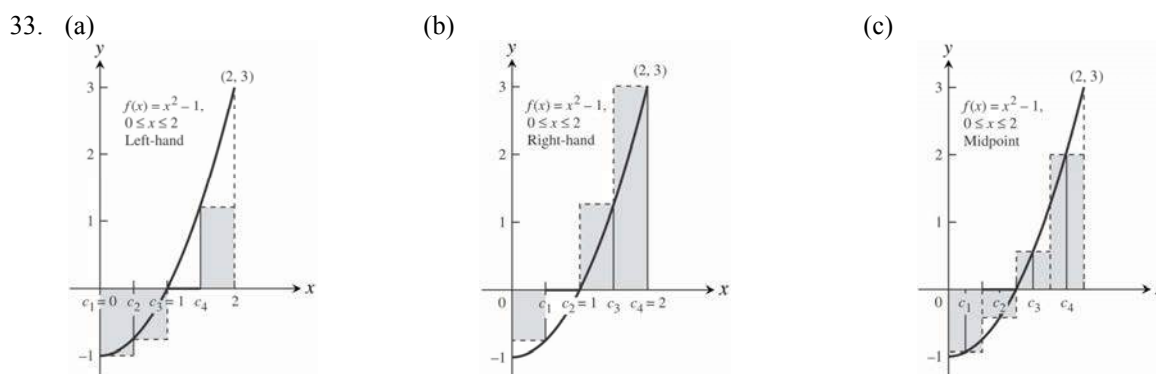

34. (a)

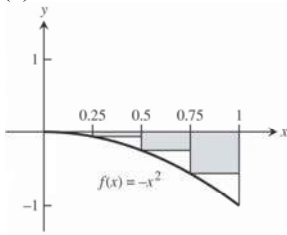

(b)

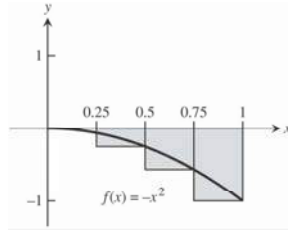

(c)

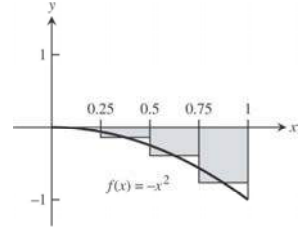

35. (a)

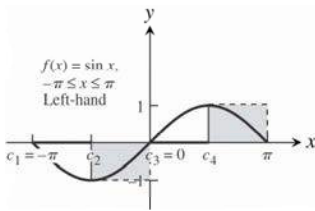

(b)

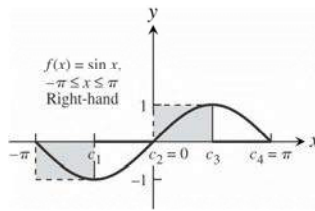

(c)

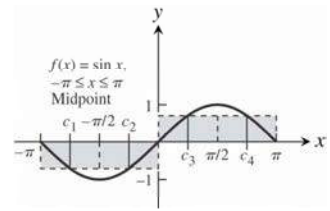

36. (a)

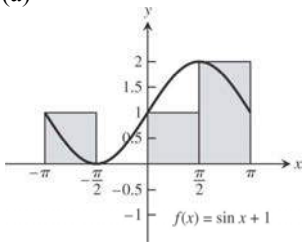

(b)

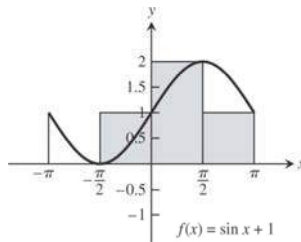

(c)

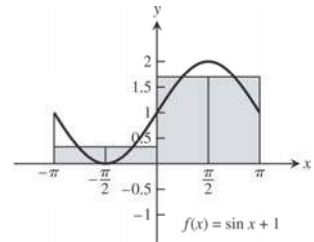

37. $|x_1 - x_0| = |1.2 - 0| = 1.2$, $|x_2 - x_1| = |1.5 - 1.2| = 0.3$, $|x_3 - x_2| = |2.3 - 1.5| = 0.8$, $|x_4 - x_3| = |2.6 - 2.3| = 0.3$, and $|x_5 - x_4| = |3 - 2.6| = 0.4$; the largest is $\|P\| = 1.2$.

38. $|x_1 - x_0| = |-1.6 - (-2)| = 0.4$, $|x_2 - x_1| = |-0.5 - (-1.6)| = 1.1$, $|x_3 - x_2| = |0 - (-0.5)| = 0.5$, $|x_4 - x_3| = |0.8 - 0| = 0.8$, and $|x_5 - x_4| = |1 - 0.8| = 0.2$; the largest is $\|P\| = 1.1$.

39. $f(x) = 1 - x^2$

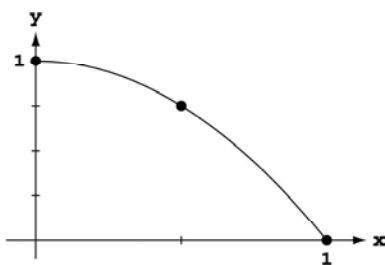

Let $\Delta x = \frac{1-0}{n} = \frac{1}{n}$ and $c_i = i\Delta x = \frac{i}{n}$. The right-hand sum is

$$\sum_{i=1}^n \left(1 - c_i^2\right) \frac{1}{n} = \frac{1}{n} \sum_{i=1}^n \left(1 - \left(\frac{i}{n}\right)^2\right) = \frac{1}{n^3} \sum_{i=1}^n (n^2 - i^2)$$

$$= \frac{n^3}{n^3} - \frac{1}{n^3} \sum_{i=1}^n i^2 = 1 - \frac{n(n+1)(2n+1)}{6n^3} = 1 - \frac{2n^3 + 3n^2 + n}{6n^3}$$

$$= 1 - \frac{2 + \frac{3}{n} + \frac{1}{n^2}}{6}. \text{ Thus, } \lim_{n \rightarrow \infty} \sum_{i=1}^n \left(1 - c_i^2\right) \frac{1}{n}$$

$$= \lim_{n \rightarrow \infty} \left(1 - \frac{2 + \frac{3}{n} + \frac{1}{n^2}}{6}\right) = 1 - \frac{2}{6} = \frac{2}{3}$$

40. $f(x) = 2x$

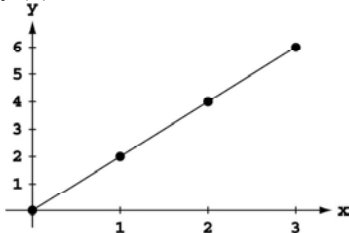

Let $\Delta x = \frac{3-0}{n} = \frac{3}{n}$ and $c_i = i\Delta x = \frac{3i}{n}$. The right-hand sum

$$\text{is } \sum_{i=1}^n 2c_i \left(\frac{3}{n}\right) = \sum_{i=1}^n \frac{6i}{n} \cdot \frac{3}{n} = \frac{18}{n^2} \sum_{i=1}^n i = \frac{18}{n^2} \cdot \frac{n(n+1)}{2} = \frac{9n^2+9n}{n^2}.$$

$$\text{Thus, } \lim_{n \rightarrow \infty} \sum_{i=1}^n \frac{6i}{n} \cdot \frac{3}{n} = \lim_{n \rightarrow \infty} \frac{9n^2+9n}{n^2} = \lim_{n \rightarrow \infty} \left(9 + \frac{9}{n}\right) = 9.$$

41. $f(x) = x^2 + 1$

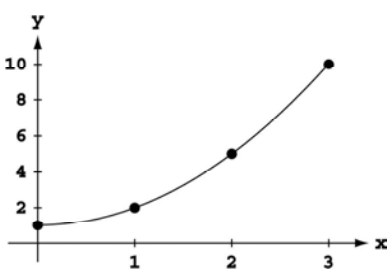

Let $\Delta x = \frac{3-0}{n} = \frac{3}{n}$ and $c_i = i\Delta x = \frac{3i}{n}$. The right-hand sum is

$$\sum_{i=1}^n (c_i^2 + 1) \frac{3}{n} = \sum_{i=1}^n \left(\left(\frac{3i}{n}\right)^2 + 1 \right) \frac{3}{n} = \frac{3}{n} \sum_{i=1}^n \left(\frac{9i^2}{n^2} + 1 \right)$$

$$= \frac{27}{n} \sum_{i=1}^n i^2 + \frac{3}{n} \cdot n = \frac{27}{n^3} \left(\frac{n(n+1)(2n+1)}{6} \right) + 3 = \frac{9(2n^3+3n^2+n)}{2n^3} + 3$$

$$= \frac{18 + \frac{27}{n} + \frac{9}{n^2}}{2} + 3. \text{ Thus, } \lim_{n \rightarrow \infty} \sum_{i=1}^n (c_i^2 + 1) \frac{3}{n}$$

$$= \lim_{n \rightarrow \infty} \left(\frac{18 + \frac{27}{n} + \frac{9}{n^2}}{2} + 3 \right) = 9 + 3 = 12.$$

42. $f(x) = 3x^2$

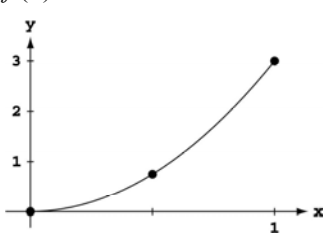

Let $\Delta x = \frac{1-0}{n} = \frac{1}{n}$ and $c_i = i\Delta x = \frac{i}{n}$. The right-hand sum is

$$\sum_{i=1}^n 3c_i^2 \left(\frac{1}{n}\right) = \sum_{i=1}^n 3 \left(\frac{i}{n}\right)^2 \left(\frac{1}{n}\right) = \frac{3}{n^3} \sum_{i=1}^n i^2 = \frac{3}{n^3} \left(\frac{n(n+1)(2n+1)}{6} \right)$$

$$= \frac{2n^3+3n^2+n}{2n^3} = \frac{2 + \frac{3}{n} + \frac{1}{n^2}}{2}. \text{ Thus, } \lim_{n \rightarrow \infty} \sum_{i=1}^n 3c_i^2 \left(\frac{1}{n}\right)$$

$$= \lim_{n \rightarrow \infty} \left(\frac{2 + \frac{3}{n} + \frac{1}{n^2}}{2} \right) = \frac{2}{2} = 1.$$

43. $f(x) = x + x^2 = x(1+x)$

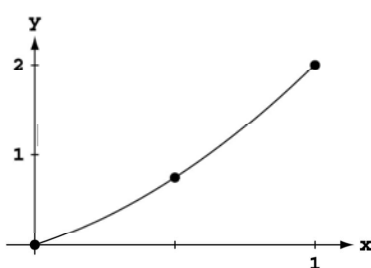

Let $\Delta x = \frac{1-0}{n} = \frac{1}{n}$ and $c_i = i\Delta x = \frac{i}{n}$. The right-hand sum is

$$\sum_{i=1}^n (c_i + c_i^2) \frac{1}{n} = \sum_{i=1}^n \left(\frac{i}{n} + \left(\frac{i}{n}\right)^2 \right) \frac{1}{n} = \frac{1}{n^2} \sum_{i=1}^n i + \frac{1}{n^3} \sum_{i=1}^n i^2$$

$$= \frac{1}{n^2} \left(\frac{n(n+1)}{2} \right) + \frac{1}{n^3} \left(\frac{n(n+1)(2n+1)}{6} \right) = \frac{n^2+n}{2n^2} + \frac{2n^3+3n^2+n}{6n^3}$$

$$= \frac{1 + \frac{1}{n}}{2} + \frac{2 + \frac{3}{n} + \frac{1}{n^2}}{6}. \text{ Thus, } \lim_{n \rightarrow \infty} \sum_{i=1}^n (c_i + c_i^2) \frac{1}{n}$$

$$= \lim_{n \rightarrow \infty} \left[\left(\frac{1 + \frac{1}{n}}{2} \right) + \left(\frac{2 + \frac{3}{n} + \frac{1}{n^2}}{6} \right) \right] = \frac{1}{2} + \frac{2}{6} = \frac{5}{6}.$$

44. $f(x) = 3x + 2x^2$

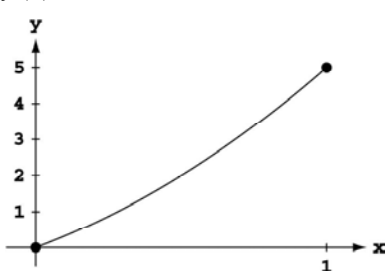

Let $\Delta x = \frac{1-0}{n} = \frac{1}{n}$ and $c_i = i\Delta x = \frac{i}{n}$. The right-hand sum is

$$\sum_{i=1}^n (3c_i + 2c_i^2) \frac{1}{n} = \sum_{i=1}^n \left(\frac{3i}{n} + 2 \left(\frac{i}{n}\right)^2 \right) \frac{1}{n} = \frac{3}{n^2} \sum_{i=1}^n i + \frac{2}{n^3} \sum_{i=1}^n i^2$$

$$= \frac{3}{n^2} \left(\frac{n(n+1)}{2} \right) + \frac{2}{n^3} \left(\frac{n(n+1)(2n+1)}{6} \right) = \frac{3n^2+3n}{2n^2} + \frac{2n^2+3n+1}{3n^2}$$

$$= \frac{3 + \frac{3}{n}}{2} + \frac{2 + \frac{3}{n} + \frac{1}{n^2}}{3}. \text{ Thus, } \lim_{n \rightarrow \infty} \sum_{i=1}^n (3c_i + 2c_i^2) \frac{1}{n}$$

$$= \lim_{n \rightarrow \infty} \left[\left(\frac{3 + \frac{3}{n}}{2} \right) + \left(\frac{2 + \frac{3}{n} + \frac{1}{n^2}}{3} \right) \right] = \frac{3}{2} + \frac{2}{3} = \frac{13}{6}.$$

45. $f(x) = 2x^3$

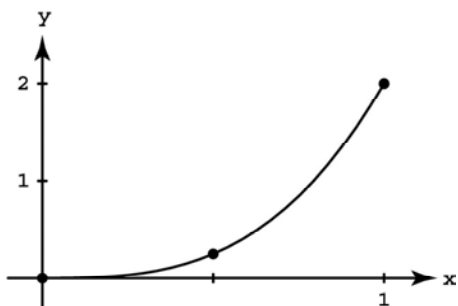

Let $\Delta x = \frac{1-0}{n} = \frac{1}{n}$ and $c_i = i\Delta x = \frac{i}{n}$. The right-hand sum is

$$\sum_{i=1}^n \left(2c_i^3\right) \frac{1}{n} = \sum_{i=1}^n \left(2\left(\frac{i}{n}\right)^3\right) \frac{1}{n} = \frac{2}{n^4} \sum_{i=1}^n i^3 = \frac{2}{n^4} \left(\frac{n(n+1)}{2}\right)^2$$

$$= \frac{2n^2(n^2+2n+1)}{4n^4} = \frac{n^2+2n+1}{2n^2} = \frac{1+\frac{2}{n}+\frac{1}{n^2}}{2}. \text{ Thus, } \lim_{n \rightarrow \infty} \sum_{i=1}^n \left(2c_i^3\right) \frac{1}{n}$$

$$= \lim_{n \rightarrow \infty} \left[\frac{1+\frac{2}{n}+\frac{1}{n^2}}{2} \right] = \frac{1}{2}.$$

46. $f(x) = x^2 - x^3$

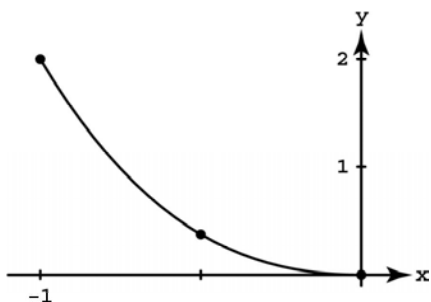

Let $\Delta x = \frac{0-(-1)}{n} = \frac{1}{n}$ and $c_i = -1 + i\Delta x = -1 + \frac{i}{n}$.

The right-hand sum is $\sum_{i=1}^n \left(c_i^2 - c_i^3\right) \frac{1}{n}$

$$= \sum_{i=1}^n \left(\left(-1 + \frac{i}{n}\right)^2 - \left(-1 + \frac{i}{n}\right)^3\right) \frac{1}{n} = \sum_{i=1}^n \left(2 - \frac{5i}{n} + \frac{4i^2}{n^2} - \frac{i^3}{n^3}\right) \frac{1}{n}$$

$$= \sum_{i=1}^n \left(\frac{2}{n} - \frac{5i}{n^2} + \frac{4i^2}{n^3} - \frac{i^3}{n^4}\right) = \sum_{i=1}^n \frac{2}{n} - \frac{5}{n^2} \sum_{i=1}^n i + \frac{4}{n^3} \sum_{i=1}^n i^2 - \frac{1}{n^4} \sum_{i=1}^n i^3$$

$$= \frac{2}{n}(n) - \frac{5}{n^2} \left(\frac{n(n+1)}{2}\right) + \frac{4}{n^3} \left(\frac{n(n+1)(2n+1)}{6}\right) - \frac{1}{n^4} \left(\frac{n(n+1)}{2}\right)^2$$

$$= 2 - \frac{5n+5}{2n} + \frac{4n^2+6n+2}{3n^2} - \frac{n^2+2n+1}{4n^2} = 2 - \frac{5+\frac{5}{n}}{2} + \frac{4+\frac{6}{n}+\frac{2}{n^2}}{3} - \frac{1+\frac{2}{n}+\frac{1}{n^2}}{4}.$$

Thus, $\lim_{n \rightarrow \infty} \sum_{i=1}^n \left(c_i^2 - c_i^3\right) \frac{1}{n}$

$$= \lim_{n \rightarrow \infty} \left[2 - \frac{5+\frac{5}{n}}{2} + \frac{4+\frac{6}{n}+\frac{2}{n^2}}{3} - \frac{1+\frac{2}{n}+\frac{1}{n^2}}{4} \right] = 2 - \frac{5}{2} + \frac{4}{3} - \frac{1}{4} = \frac{7}{12}.$$

5.3 THE DEFINITE INTEGRAL

1. $\int_0^2 x^2 dx$

2. $\int_{-1}^0 2x^3 dx$

3. $\int_{-7}^5 (x^2 - 3x) dx$

4. $\int_1^4 \frac{1}{x} dx$

5. $\int_2^3 \frac{1}{1-x} dx$

6. $\int_0^1 \sqrt{4-x^2} dx$

7. $\int_{-\pi/4}^0 (\sec x) dx$

8. $\int_0^{\pi/4} (\tan x) dx$

9. (a) $\int_2^2 g(x) dx = 0$

(b) $\int_5^1 g(x) dx = -\int_1^5 g(x) dx = -8$

(c) $\int_1^2 3f(x) dx = 3\int_1^2 f(x) dx = 3(-4) = -12$

(d) $\int_2^5 f(x) dx = \int_1^5 f(x) dx - \int_1^2 f(x) dx = 6 - (-4) = 10$

(e) $\int_1^5 [f(x) - g(x)] dx = \int_1^5 f(x) dx - \int_1^5 g(x) dx = 6 - 8 = -2$

(f) $\int_1^5 [4f(x) - g(x)] dx = 4\int_1^5 f(x) dx - \int_1^5 g(x) dx = 4(6) - 8 = 16$

10. (a) $\int_1^9 -2f(x) dx = -2 \int_1^9 f(x) dx = -2(-1) = 2$
 (b) $\int_7^9 [f(x) + h(x)] dx = \int_7^9 f(x) dx + \int_7^9 h(x) dx = 5 + 4 = 9$
 (c) $\int_7^9 [2f(x) - 3h(x)] dx = 2 \int_7^9 f(x) dx - 3 \int_7^9 h(x) dx = 2(5) - 3(4) = -2$
 (d) $\int_9^1 f(x) dx = -\int_1^9 f(x) dx = -(-1) = 1$
 (e) $\int_1^7 f(x) dx = \int_1^9 f(x) dx - \int_7^9 f(x) dx = -1 - 5 = -6$
 (f) $\int_9^7 [h(x) - f(x)] dx = \int_7^9 [f(x) - h(x)] dx = \int_7^9 f(x) dx - \int_7^9 h(x) dx = 5 - 4 = 1$
11. (a) $\int_1^2 f(u) du = \int_1^2 f(x) dx = 5$ (b) $\int_1^2 \sqrt{3} f(z) dz = \sqrt{3} \int_1^2 f(z) dz = 5\sqrt{3}$
 (c) $\int_2^1 f(t) dt = -\int_1^2 f(t) dt = -5$ (d) $\int_1^2 [-f(x)] dx = -\int_1^2 f(x) dx = -5$
12. (a) $\int_0^{-3} g(t) dt = -\int_{-3}^0 g(t) dt = -\sqrt{2}$ (b) $\int_{-3}^0 g(u) du = \int_{-3}^0 g(t) dt = \sqrt{2}$
 (c) $\int_{-3}^0 [-g(x)] dx = -\int_{-3}^0 g(x) dx = -\sqrt{2}$ (d) $\int_{-3}^0 \frac{g(r)}{\sqrt{2}} dr = \frac{1}{\sqrt{2}} \int_{-3}^0 g(t) dt = \left(\frac{1}{\sqrt{2}}\right)(\sqrt{2}) = 1$
13. (a) $\int_3^4 f(z) dz = \int_0^4 f(z) dz - \int_0^3 f(z) dz = 7 - 3 = 4$
 (b) $\int_4^3 f(t) dt = -\int_3^4 f(t) dt = -4$
14. (a) $\int_1^3 h(r) dr = \int_{-1}^3 h(r) dr - \int_{-1}^1 h(r) dr = 6 - 0 = 6$
 (b) $-\int_3^1 h(u) du = -\left(-\int_1^3 h(u) du\right) = \int_1^3 h(u) du = 6$
15. The area of the trapezoid is $A = \frac{1}{2}(B + b)h$
 $= \frac{1}{2}(5 + 2)(6) = 21 \Rightarrow \int_{-2}^4 \left(\frac{x}{2} + 3\right) dx = 21$ square units

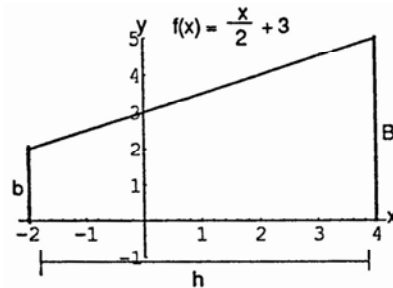

16. The area of the trapezoid is $A = \frac{1}{2}(B + b)h$
 $= \frac{1}{2}(3 + 1)(1) = 2 \Rightarrow \int_{1/2}^{3/2} (-2x + 4) dx = 2$ square units

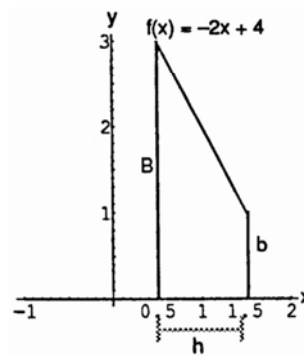

17. The area of the semicircle is $A = \frac{1}{2}\pi r^2 = \frac{1}{2}\pi(3)^2$
 $= \frac{9}{2}\pi \Rightarrow \int_{-3}^3 \sqrt{9-x^2} dx = \frac{9}{2}\pi$ square units

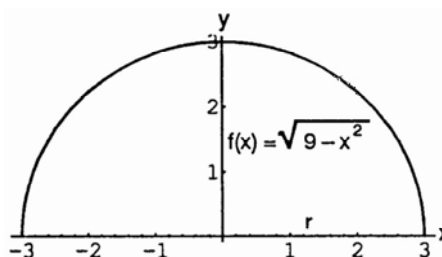

18. The graph of the quarter circle is $A = \frac{1}{4}\pi r^2 = \frac{1}{4}\pi(4)^2$
 $= 4\pi \Rightarrow \int_{-4}^0 \sqrt{16-x^2} dx = 4\pi$ square units

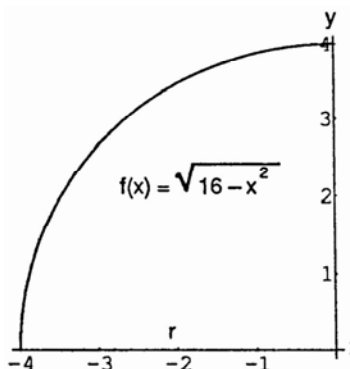

19. The area of the triangle on the left is $A = \frac{1}{2}bh$
 $= \frac{1}{2}(2)(2) = 2$. The area of the triangle on the right is
 $A = \frac{1}{2}bh = \frac{1}{2}(1)(1) = \frac{1}{2}$. Then, the total area is 2.5
 $\Rightarrow \int_{-2}^1 |x| dx = 2.5$ square units

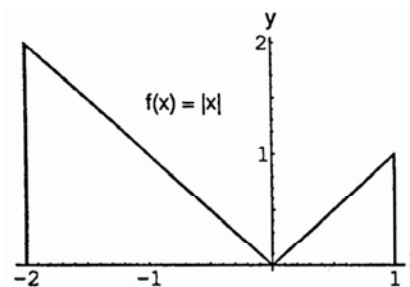

20. The area of the triangle is $A = \frac{1}{2}bh = \frac{1}{2}(2)(1) = 1$
 $\Rightarrow \int_{-1}^1 (1-|x|) dx = 1$ square unit

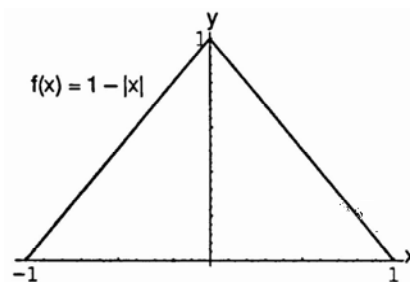

21. The area of the triangular peak is $A = \frac{1}{2}bh = \frac{1}{2}(2)(1) = 1$.
 The area of the rectangular base is $S = \ell w = (2)(1) = 2$.
 Then the total area is $3 \Rightarrow \int_{-1}^1 (2-|x|) dx = 3$ square units

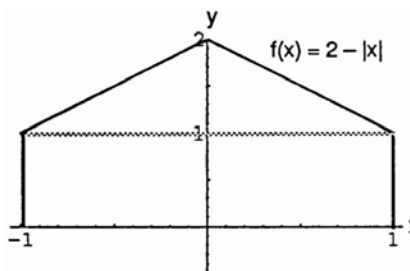

22. $y = 1 + \sqrt{1 - x^2} \Rightarrow y - 1 = \sqrt{1 - x^2} \Rightarrow (y - 1)^2 = 1 - x^2$
 $\Rightarrow x^2 + (y - 1)^2 = 1$, a circle with center $(0, 1)$ and radius of 1 $\Rightarrow y = 1 + \sqrt{1 - x^2}$ is the upper semicircle. The area of this semicircle is $A = \frac{1}{2} \pi r^2 = \frac{1}{2} \pi (1)^2 = \frac{\pi}{2}$. The area of the rectangular base is $A = \ell w = (2)(1) = 2$. Then the total area is $2 + \frac{\pi}{2} \Rightarrow \int_{-1}^1 (1 + \sqrt{1 - x^2}) dx = 2 + \frac{\pi}{2}$ square units

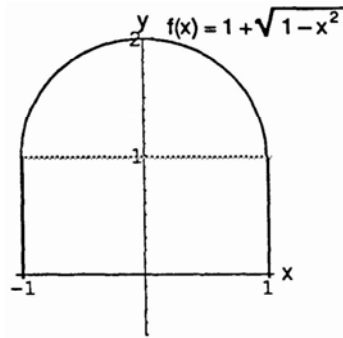

23. $\int_0^b \frac{x}{2} dx = \frac{1}{2}(b)(\frac{b}{2}) = \frac{b^2}{4}$

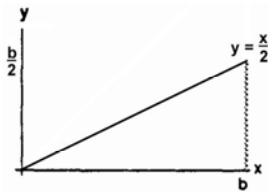

24. $\int_0^b 4x dx = \frac{1}{2}b(4b) = 2b^2$



25. $\int_a^b 2s ds = \frac{1}{2}b(2b) - \frac{1}{2}a(2a) = b^2 - a^2$

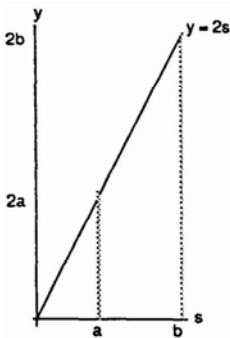

26. $\int_a^b 3t dt = \frac{1}{2}b(3b) - \frac{1}{2}a(3a) = \frac{3}{2}(b^2 - a^2)$

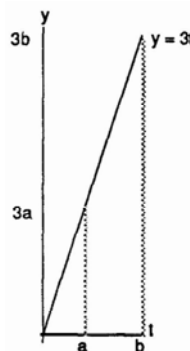

27. (a) $\int_{-2}^2 \sqrt{4 - x^2} dx = \frac{1}{2}[\pi(2)^2] = 2\pi$

(b) $\int_0^2 \sqrt{4 - x^2} dx = \frac{1}{4}[\pi(2)^2] = \pi$

28. (a) $\int_{-1}^0 (3x + \sqrt{1 - x^2}) dx = \int_{-1}^0 3x dx + \int_{-1}^0 \sqrt{1 - x^2} dx = -\frac{1}{2}[(1)(3)] + \frac{1}{4}[\pi(1)^2] = \frac{\pi}{4} - \frac{3}{2}$

(b) $\int_{-1}^1 (3x + \sqrt{1 - x^2}) dx = \int_{-1}^0 3x dx + \int_0^1 3x dx + \int_{-1}^1 \sqrt{1 - x^2} dx = -\frac{1}{2}[(1)(3)] + \frac{1}{2}[(1)(3)] + \frac{1}{2}[\pi(1)^2] = \frac{\pi}{2}$

29. $\int_1^{\sqrt{2}} x dx = \frac{(\sqrt{2})^2}{2} - \frac{(1)^2}{2} = \frac{1}{2}$

30. $\int_{0.5}^{2.5} x dx = \frac{(2.5)^2}{2} - \frac{(0.5)^2}{2} = 3$

31. $\int_{\pi}^{2\pi} \theta d\theta = \frac{(2\pi)^2}{2} - \frac{\pi^2}{2} = \frac{3\pi^2}{2}$

32. $\int_{\sqrt{2}}^{5\sqrt{2}} r dr = \frac{(5\sqrt{2})^2}{2} - \frac{(\sqrt{2})^2}{2} = 24$

$$33. \int_0^{\sqrt[3]{7}} x^2 dx = \frac{(\sqrt[3]{7})^3}{3} = \frac{7}{3}$$

$$34. \int_0^{0.3} s^2 ds = \frac{(0.3)^3}{3} = 0.009$$

$$35. \int_0^{1/2} t^2 dt = \frac{(\frac{1}{2})^3}{3} = \frac{1}{24}$$

$$36. \int_0^{\pi/2} \theta^2 d\theta = \frac{(\frac{\pi}{2})^3}{3} = \frac{\pi^3}{24}$$

$$37. \int_a^{2a} x dx = \frac{(2a)^2}{2} - \frac{a^2}{2} = \frac{3a^2}{2}$$

$$38. \int_a^{\sqrt{3}a} x dx = \frac{(\sqrt{3}a)^2}{2} - \frac{a^2}{2} = a^2$$

$$39. \int_0^{\sqrt[3]{b}} x^2 dx = \frac{(\sqrt[3]{b})^3}{3} = \frac{b}{3}$$

$$40. \int_0^{3b} x^2 dx = \frac{(3b)^3}{3} = 9b^3$$

$$41. \int_3^1 7 dx = 7(1-3) = -14$$

$$42. \int_0^2 5x dx = 5 \int_0^2 x dx = 5 \left[\frac{x^2}{2} - \frac{0^2}{2} \right] = 10$$

$$43. \int_0^2 (2t-3) dt = 2 \int_1^1 t dt - \int_0^2 3 dt = 2 \left[\frac{t^2}{2} - \frac{0^2}{2} \right] - 3(2-0) = 4-6 = -2$$

$$44. \int_0^{\sqrt{2}} (t-\sqrt{2}) dt = \int_0^{\sqrt{2}} t dt - \int_0^{\sqrt{2}} \sqrt{2} dt = \left[\frac{(\sqrt{2})^2}{2} - \frac{0^2}{2} \right] - \sqrt{2} [\sqrt{2}-0] = 1-2 = -1$$

$$45. \int_2^1 \left(1 + \frac{z}{2}\right) dz = \int_2^1 1 dz + \int_2^1 \frac{z}{2} dz = \int_2^1 1 dz - \frac{1}{2} \int_1^2 z dz = 1[1-2] - \frac{1}{2} \left[\frac{z^2}{2} - \frac{1^2}{2} \right] = -1 - \frac{1}{2} \left(\frac{3}{2} \right) = -\frac{7}{4}$$

$$46. \int_3^0 (2z-3) dz = \int_3^0 2z dz - \int_3^0 3 dz = -2 \int_0^3 z dz - \int_3^0 3 dz = -2 \left[\frac{z^2}{2} - \frac{0^2}{2} \right] - 3[0-3] = -9+9 = 0$$

$$47. \int_1^2 3u^2 du = 3 \int_1^2 u^2 du = 3 \left[\int_0^2 u^2 du - \int_0^1 u^2 du \right] = 3 \left(\left[\frac{2^3}{3} - \frac{0^3}{3} \right] - \left[\frac{1^3}{3} - \frac{0^3}{3} \right] \right) = 3 \left[\frac{2^3}{3} - \frac{1^3}{3} \right] = 3 \left(\frac{7}{3} \right) = 7$$

$$48. \int_{1/2}^1 24u^2 du = 24 \int_{1/2}^1 u^2 du = 24 \left[\int_0^1 u^2 du - \int_0^{1/2} u^2 du \right] = 24 \left[\frac{1^3}{3} - \frac{(\frac{1}{2})^3}{3} \right] = 24 \left[\frac{7}{8} \right] = 7$$

$$49. \int_0^2 (3x^2 + x - 5) dx = 3 \int_0^2 x^2 dx + \int_0^2 x dx - \int_0^2 5 dx = 3 \left[\frac{2^3}{3} - \frac{0^3}{3} \right] + \left[\frac{2^2}{2} - \frac{0^2}{2} \right] - 5[2-0] = (8+2) - 10 = 0$$

$$50. \int_1^0 (3x^2 + x - 5) dx = - \int_0^1 (3x^2 + x - 5) dx = - \left[3 \int_0^1 x^2 dx + \int_0^1 x dx - \int_0^1 5 dx \right] = - \left[3 \left(\frac{1^3}{3} - \frac{0^3}{3} \right) + \left(\frac{1^2}{2} - \frac{0^2}{2} \right) - 5(1-0) \right] \\ = - \left(\frac{3}{2} - 5 \right) = \frac{7}{2}$$

51. Let $\Delta x = \frac{b-0}{n} = \frac{b}{n}$ and let $x_0 = 0, x_1 = \Delta x, x_2 = 2\Delta x, \dots, x_{n-1} = (n-1)\Delta x, x_n = n\Delta x = b$. Let the c_k 's be the right endpoints of the subintervals $\Rightarrow c_1 = x_1, c_2 = x_2$, and so on.

The rectangles defined have areas:

$$\begin{aligned} f(c_1)\Delta x &= f(\Delta x)\Delta x = 3(\Delta x)^2 \Delta x = 3(\Delta x)^3 \\ f(c_2)\Delta x &= f(2\Delta x)\Delta x = 3(2\Delta x)^2 \Delta x = 3(2)^2(\Delta x)^3 \\ f(c_3)\Delta x &= f(3\Delta x)\Delta x = 3(3\Delta x)^2 \Delta x = 3(3)^2(\Delta x)^3 \\ &\vdots \\ f(c_n)\Delta x &= f(n\Delta x)\Delta x = 3(n\Delta x)^2 \Delta x = 3(n)^2(\Delta x)^3 \end{aligned}$$

$$\begin{aligned} \text{Then } S_n &= \sum_{k=1}^n f(c_k)\Delta x = \sum_{k=1}^n 3k^2(\Delta x)^3 \\ &= 3(\Delta x)^3 \sum_{k=1}^n k^2 = 3\left(\frac{b^3}{n^3}\right)\left(\frac{n(n+1)(2n+1)}{6}\right) \\ &= \frac{b^3}{2}\left(2 + \frac{3}{n} + \frac{1}{n^2}\right) \Rightarrow \int_0^b 3x^2 dx = \lim_{n \rightarrow \infty} \frac{b^3}{2}\left(2 + \frac{3}{n} + \frac{1}{n^2}\right) = b^3. \end{aligned}$$

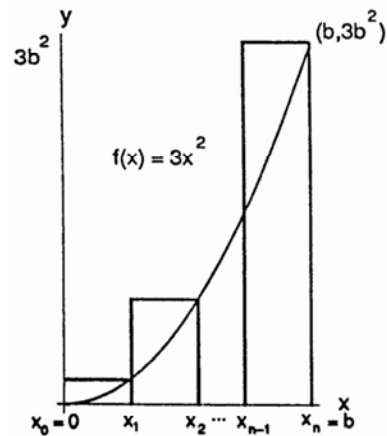

52. Let $\Delta x = \frac{b-0}{n} = \frac{b}{n}$ and let $x_0 = 0, x_1 = \Delta x, x_2 = 2\Delta x, \dots, x_{n-1} = (n-1)\Delta x, x_n = n\Delta x = b$. Let the c_k 's be the right endpoints of the subintervals $\Rightarrow c_1 = x_1, c_2 = x_2$, and so on.

The rectangles defined have areas:

$$\begin{aligned} f(c_1)\Delta x &= f(\Delta x)\Delta x = \pi(\Delta x)^2 \Delta x = \pi(\Delta x)^3 \\ f(c_2)\Delta x &= f(2\Delta x)\Delta x = \pi(2\Delta x)^2 \Delta x = \pi(2)^2(\Delta x)^3 \\ f(c_3)\Delta x &= f(3\Delta x)\Delta x = \pi(3\Delta x)^2 \Delta x = \pi(3)^2(\Delta x)^3 \\ &\vdots \\ f(c_n)\Delta x &= f(n\Delta x)\Delta x = \pi(n\Delta x)^2 \Delta x = \pi(n)^2(\Delta x)^3 \end{aligned}$$

$$\begin{aligned} \text{Then } S_n &= \sum_{k=1}^n f(c_k)\Delta x = \sum_{k=1}^n \pi k^2(\Delta x)^3 = \pi(\Delta x)^3 \sum_{k=1}^n k^2 \\ &= \pi\left(\frac{b^3}{n^3}\right)\left(\frac{n(n+1)(2n+1)}{6}\right) = \frac{\pi b^3}{6}\left(2 + \frac{3}{n} + \frac{1}{n^2}\right) \\ &\Rightarrow \int_0^b \pi x^2 dx = \lim_{n \rightarrow \infty} \frac{\pi b^3}{6}\left(2 + \frac{3}{n} + \frac{1}{n^2}\right) = \frac{\pi b^3}{3}. \end{aligned}$$

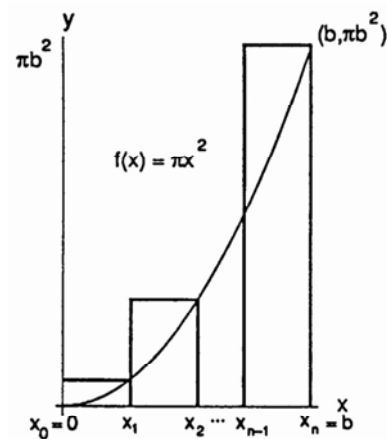

53. Let $\Delta x = \frac{b-0}{n} = \frac{b}{n}$ and let $x_0 = 0, x_1 = \Delta x, x_2 = 2\Delta x, \dots, x_{n-1} = (n-1)\Delta x, x_n = n\Delta x = b$. Let the c_k 's be the right endpoints of the subintervals $\Rightarrow c_1 = x_1, c_2 = x_2$, and so on.

The rectangles defined have areas:

$$\begin{aligned} f(c_1)\Delta x &= f(\Delta x)\Delta x = 2(\Delta x)(\Delta x) = 2(\Delta x)^2 \\ f(c_2)\Delta x &= f(2\Delta x)\Delta x = 2(2\Delta x)(\Delta x) = 2(2)(\Delta x)^2 \\ f(c_3)\Delta x &= f(3\Delta x)\Delta x = 2(3\Delta x)(\Delta x) = 2(3)(\Delta x)^2 \\ &\vdots \\ f(c_n)\Delta x &= f(n\Delta x)\Delta x = 2(n\Delta x)(\Delta x) = 2(n)(\Delta x)^2 \end{aligned}$$

$$\begin{aligned} \text{Then } S_n &= \sum_{k=1}^n f(c_k)\Delta x = \sum_{k=1}^n 2k(\Delta x)^2 \\ &= 2(\Delta x)^2 \sum_{k=1}^n k = 2\left(\frac{b^2}{n^2}\right)\left(\frac{n(n+1)}{2}\right) = b^2\left(1 + \frac{1}{n}\right) \\ &\Rightarrow \int_0^b 2x dx = \lim_{n \rightarrow \infty} b^2\left(1 + \frac{1}{n}\right) = b^2. \end{aligned}$$

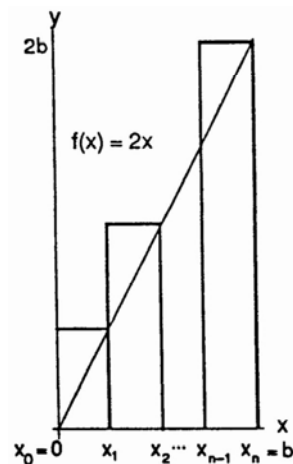

54. Let $\Delta x = \frac{b-0}{n} = \frac{b}{n}$ and let $x_0 = 0, x_1 = \Delta x, x_2 = 2\Delta x, \dots, x_{n-1} = (n-1)\Delta x, x_n = n\Delta x = b$. Let the c_k 's be the right endpoints of the subintervals $\Rightarrow c_1 = x_1, c_2 = x_2$, and so on. The rectangles defined have areas:

$$f(c_1)\Delta x = f(\Delta x)\Delta x = \left(\frac{\Delta x}{2} + 1\right)(\Delta x) = \frac{1}{2}(\Delta x)^2 + \Delta x$$

$$f(c_2)\Delta x = f(2\Delta x)\Delta x = \left(\frac{2\Delta x}{2} + 1\right)(\Delta x) = \frac{1}{2}(2)(\Delta x)^2 + \Delta x$$

$$f(c_3)\Delta x = f(3\Delta x)\Delta x = \left(\frac{3\Delta x}{2} + 1\right)(\Delta x) = \frac{1}{2}(3)(\Delta x)^2 + \Delta x$$

$$\vdots$$

$$f(c_n)\Delta x = f(n\Delta x)\Delta x = \left(\frac{n\Delta x}{2} + 1\right)(\Delta x) = \frac{1}{2}(n)(\Delta x)^2 + \Delta x$$

$$\text{Then } S_n = \sum_{k=1}^n f(c_k)\Delta x = \sum_{k=1}^n \left(\frac{1}{2}k(\Delta x)^2 + \Delta x\right) = \frac{1}{2}(\Delta x)^2 \sum_{k=1}^n k + \Delta x \sum_{k=1}^n 1 = \frac{1}{2}\left(\frac{b^2}{n^2}\right)\left(\frac{n(n+1)}{2}\right) + \left(\frac{b}{n}\right)(n)$$

$$= \frac{1}{4}b^2\left(1 + \frac{1}{n}\right) + b \Rightarrow \int_0^b \left(\frac{x}{2} + 1\right) dx = \lim_{n \rightarrow \infty} \left(\frac{1}{4}b^2\left(1 + \frac{1}{n}\right) + b\right) = \frac{1}{4}b^2 + b.$$

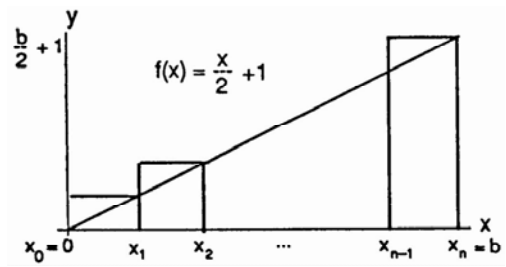

55. $\text{av}(f) = \left(\frac{1}{\sqrt{3}-0}\right) \int_0^{\sqrt{3}} (x^2 - 1) dx = \frac{1}{\sqrt{3}} \int_0^{\sqrt{3}} x^2 dx - \frac{1}{\sqrt{3}} \int_0^{\sqrt{3}} 1 dx$

$$= \frac{1}{\sqrt{3}} \left(\frac{(\sqrt{3})^3}{3}\right) - \frac{1}{\sqrt{3}}(\sqrt{3} - 0) = 1 - 1 = 0.$$

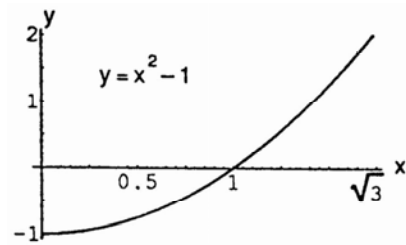

56. $\text{av}(f) = \left(\frac{1}{3-0}\right) \int_0^3 \left(-\frac{x^2}{2}\right) dx = \frac{1}{3}\left(-\frac{1}{2}\right) \int_0^3 x^2 dx$

$$= -\frac{1}{6}\left(\frac{3^3}{3}\right) = -\frac{3}{2}.$$

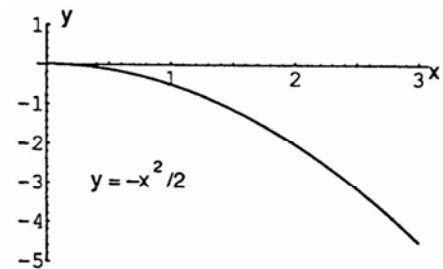

57. $\text{av}(f) = \left(\frac{1}{1-0}\right) \int_0^1 (-3x^2 - 1) dx = -3 \int_0^1 x^2 dx - \int_0^1 1 dx$

$$= -3\left(\frac{1^3}{3}\right) - (1 - 0) = -2.$$

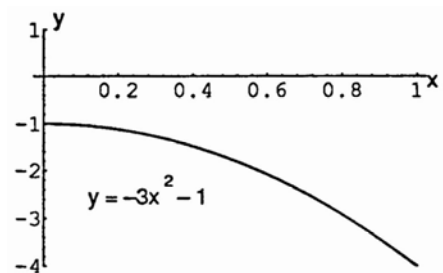

58. $\text{av}(f) = \left(\frac{1}{1-0}\right) \int_0^1 (3x^2 - 3) dx = 3 \int_0^1 x^2 dx - \int_0^1 3 dx$

$$= 3\left(\frac{1^3}{3}\right) - 3(1 - 0) = -2.$$

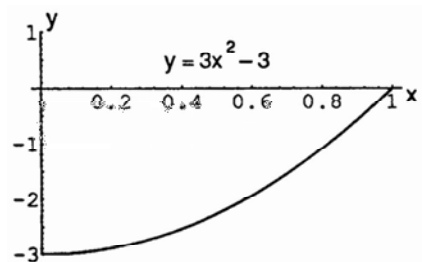

$$\begin{aligned}
 59. \quad \text{av}(f) &= \left(\frac{1}{3-0}\right) \int_0^3 (t-1)^2 dt = \frac{1}{3} \int_0^3 t^2 dt - \frac{2}{3} \int_0^3 t dt + \frac{1}{3} \int_0^3 1 dt \\
 &= \frac{1}{3} \left(\frac{3^3}{3}\right) - \frac{2}{3} \left(\frac{3^2}{2} - \frac{0^2}{2}\right) + \frac{1}{3}(3-0) = 1.
 \end{aligned}$$

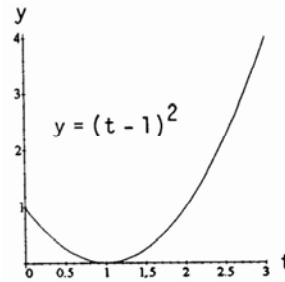

$$\begin{aligned}
 60. \quad \text{av}(f) &= \left(\frac{1}{1-(-2)}\right) \int_{-2}^1 (t^2 - t) dt = \frac{1}{3} \int_{-2}^1 t^2 dt - \frac{1}{3} \int_{-2}^1 t dt \\
 &= \frac{1}{3} \int_0^1 t^2 dt - \frac{1}{3} \int_0^{-2} t^2 dt - \frac{1}{3} \left(\frac{1^2}{2} - \frac{(-2)^2}{2}\right) \\
 &= \frac{1}{3} \left(\frac{1^3}{3}\right) - \frac{1}{3} \left(\frac{(-2)^3}{3}\right) + \frac{1}{2} = \frac{3}{2}.
 \end{aligned}$$

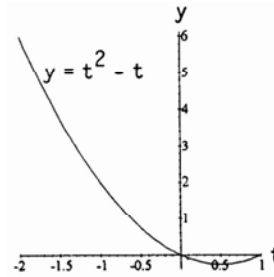

$$\begin{aligned}
 61. \quad (a) \quad \text{av}(g) &= \left(\frac{1}{1-(-1)}\right) \int_{-1}^1 (|x|-1) dx \\
 &= \frac{1}{2} \int_{-1}^0 (-x-1) dx + \frac{1}{2} \int_0^1 (x-1) dx \\
 &= -\frac{1}{2} \int_{-1}^0 x dx - \frac{1}{2} \int_{-1}^0 1 dx + \frac{1}{2} \int_0^1 x dx - \frac{1}{2} \int_0^1 1 dx \\
 &= -\frac{1}{2} \left(\frac{0^2}{2} - \frac{(-1)^2}{2}\right) - \frac{1}{2}(0 - (-1)) + \frac{1}{2} \left(\frac{1^2}{2} - \frac{0^2}{2}\right) - \frac{1}{2}(1-0) \\
 &= -\frac{1}{2}.
 \end{aligned}$$

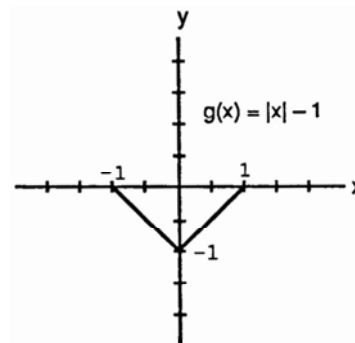

$$\begin{aligned}
 (b) \quad \text{av}(g) &= \left(\frac{1}{3-1}\right) \int_1^3 (|x|-1) dx = \frac{1}{2} \int_1^3 (x-1) dx \\
 &= \frac{1}{2} \int_1^3 x dx - \frac{1}{2} \int_1^3 1 dx = \frac{1}{2} \left(\frac{3^2}{2} - \frac{1^2}{2}\right) - \frac{1}{2}(3-1) = 1.
 \end{aligned}$$

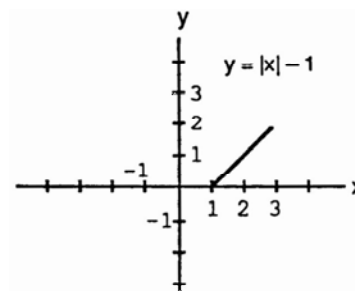

$$\begin{aligned}
 (c) \quad \text{av}(g) &= \left(\frac{1}{3-1(-1)}\right) \int_{-1}^3 (|x|-1) dx \\
 &= \frac{1}{4} \int_{-1}^1 (|x|-1) dx + \frac{1}{4} \int_1^3 (|x|-1) dx \\
 &= \frac{1}{4}(-1+2) = \frac{1}{4} \quad (\text{see parts (a) and (b) above}).
 \end{aligned}$$

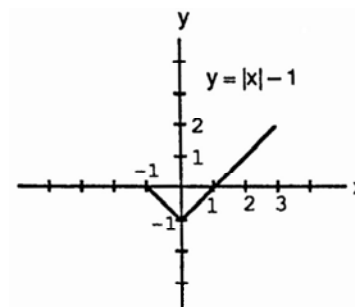

62. (a) $av(h) = \left(\frac{1}{0-(-1)}\right) \int_{-1}^0 -|x| dx = \int_{-1}^0 -(-x) dx$
 $= \int_{-1}^0 x dx = \frac{0^2}{2} - \frac{(-1)^2}{2} = -\frac{1}{2}.$

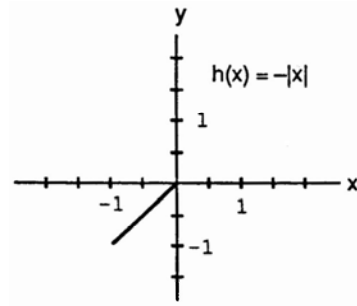

(b) $av(h) = \left(\frac{1}{1-0}\right) \int_0^1 -|x| dx = -\int_0^1 x dx$
 $= -\left(\frac{1^2}{2} - \frac{0^2}{2}\right) = -\frac{1}{2}.$

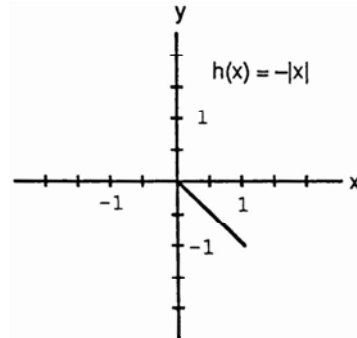

(c) $av(h) = \left(\frac{1}{1-(-1)}\right) \int_{-1}^1 -|x| dx$
 $= \frac{1}{2} \left(\int_{-1}^0 -|x| dx + \int_0^1 -|x| dx \right)$
 $= \frac{1}{2} \left(-\frac{1}{2} + \left(-\frac{1}{2}\right) \right) = -\frac{1}{2}$ (see parts (a) and (b) above).

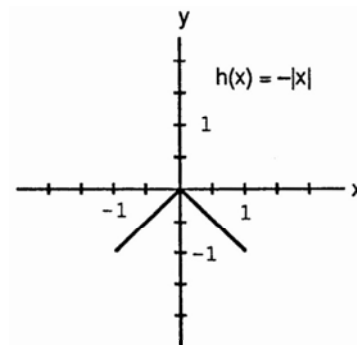

63. Consider the partition P that subdivides the interval $[a, b]$ into n subintervals of width $\Delta x = \frac{b-a}{n}$ and let c_k be the right endpoint of each subinterval. So the partition is $P = \left\{ a, a + \frac{b-a}{n}, a + \frac{2(b-a)}{n}, \dots, a + \frac{n(b-a)}{n} \right\}$ and

$c_k = a + \frac{k(b-a)}{n}$. We get the Riemann sum $\sum_{k=1}^n f(c_k) \Delta x = \sum_{k=1}^n c \cdot \frac{b-a}{n} = \frac{c(b-a)}{n} \sum_{k=1}^n 1 = \frac{c(b-a)}{n} \cdot n = c(b-a)$.

As $n \rightarrow \infty$ and $\|P\| \rightarrow 0$ this expression remains $c(b-a)$. Thus, $\int_a^b c dx = c(b-a)$.

64. Consider the partition P that subdivides the interval $[0, 2]$ into n subintervals of width $\Delta x = \frac{2-0}{n} = \frac{2}{n}$ and let c_k be the right endpoint of each subinterval. So the partition is $P = \left\{ 0, \frac{2}{n}, 2 \cdot \frac{2}{n}, \dots, n \cdot \frac{2}{n} = 2 \right\}$ and $c_k = k \cdot \frac{2}{n} = \frac{2k}{n}$.

We get the Riemann sum

$\sum_{k=1}^n f(c_k) \Delta x = \sum_{k=1}^n \left[2 \left(\frac{2k}{n} \right) + 1 \right] \cdot \frac{2}{n} = \frac{2}{n} \sum_{k=1}^n \left(\frac{4k}{n} + 1 \right) = \frac{8}{n^2} \sum_{k=1}^n k + \frac{2}{n} \sum_{k=1}^n 1 = \frac{8}{n^2} \cdot \frac{n(n+1)}{2} + \frac{2}{n} \cdot n = \frac{4(n+1)}{n} + 2$. As $n \rightarrow \infty$ and

$\|P\| \rightarrow 0$ the expression $\frac{4(n+1)}{n} + 2$ has the value $4 + 2 = 6$. Thus, $\int_0^2 (2x+1) dx = 6$.

65. Consider the partition P that subdivides the interval $[a, b]$ into n subintervals of width $\Delta x = \frac{b-a}{n}$ and let c_k be the right endpoint of each subinterval. So the partition is $P = \left\{ a, a + \frac{b-a}{n}, a + \frac{2(b-a)}{n}, \dots, a + \frac{n(b-a)}{n} \right\}$ and

$$\begin{aligned}
 c_k &= a + \frac{k(b-a)}{n}. \text{ We get the Riemann sum } \sum_{k=1}^n f(c_k)\Delta x = \sum_{k=1}^n c_k^2 \left(\frac{b-a}{n}\right) = \frac{b-a}{n} \sum_{k=1}^n \left(a + \frac{k(b-a)}{n}\right)^2 \\
 &= \frac{b-a}{n} \sum_{k=1}^n \left(a^2 + \frac{2ak(b-a)}{n} + \frac{k^2(b-a)^2}{n^2}\right) = \frac{b-a}{n} \left(\sum_{k=1}^n a^2 + \frac{2a(b-a)}{n} \sum_{k=1}^n k + \frac{(b-a)^2}{n^2} \sum_{k=1}^n k^2\right) \\
 &= \frac{b-a}{n} \cdot na^2 + \frac{2a(b-a)}{n^2} \cdot \frac{n(n+1)}{2} + \frac{(b-a)^3}{n^3} \cdot \frac{n(n+1)(2n+1)}{6} = (b-a)a^2 + a(b-a)^2 \cdot \frac{n+1}{n} + \frac{(b-a)^3}{6^2} \cdot \frac{(n+1)(2n+1)}{n} \\
 &= (b-a)a^2 + a(b-a)^2 \cdot \frac{1+\frac{1}{n}}{1} + \frac{(b-a)^3}{6} \cdot \frac{2+\frac{3}{n}+\frac{1}{n^2}}{1} \text{ As } n \rightarrow \infty \text{ and } \|P\| \rightarrow 0 \text{ this expression has value} \\
 &(b-a)a^2 + a(b-a)^2 \cdot 1 + \frac{(b-a)^3}{6} \cdot 2 = ba^2 - a^3 + ab^2 - 2a^2b + a^3 + \frac{1}{3}(b^3 - 3b^2a + 3ba^2 - a^3) = \frac{b^3}{3} - \frac{a^3}{3}. \text{ Thus,} \\
 &\int_a^b x^2 dx = \frac{b^3}{3} - \frac{a^3}{3}.
 \end{aligned}$$

66. Consider the partition P that subdivides the interval $[-1, 0]$ into n subintervals of width $\Delta x = \frac{0-(-1)}{n} = \frac{1}{n}$ and let c_k be the right endpoint of each subinterval. So the partition is $P = \left\{ -1, -1 + \frac{1}{n}, -1 + 2 \cdot \frac{1}{n}, \dots, -1 + n \cdot \frac{1}{n} = 0 \right\}$

$$\begin{aligned}
 \text{and } c_k &= -1 + k \cdot \frac{1}{n} = -1 + \frac{k}{n}. \text{ We get the Riemann sum } \sum_{k=1}^n f(c_k)\Delta x = \sum_{k=1}^n \left(\left(-1 + \frac{k}{n}\right) - \left(-1 + \frac{k}{n}\right)^2 \right) \cdot \frac{1}{n} \\
 &= \frac{1}{n} \sum_{k=1}^n \left(-1 + \frac{k}{n} - 1 + \frac{2k}{n} - \left(\frac{k}{n}\right)^2 \right) = -\frac{2}{n} \sum_{k=1}^n 1 + \frac{3}{n^2} \sum_{k=1}^n k - \frac{1}{n^3} \sum_{k=1}^n k^2 = -\frac{2}{n} \cdot n + \frac{3}{n^2} \cdot \frac{n(n+1)}{2} - \frac{1}{n^3} \cdot \frac{n(n+1)(2n+1)}{6} \\
 &= -2 + \frac{3(n+1)}{2n} - \frac{(n+1)(2n+1)}{6n^2}. \text{ As } n \rightarrow \infty \text{ and } \|P\| \rightarrow 0 \text{ this expression has value } -2 + \frac{3}{2} - \frac{1}{3} = -\frac{5}{6}. \\
 \text{Thus, } &\int_{-1}^0 (x - x^2) dx = -\frac{5}{6}.
 \end{aligned}$$

67. Consider the partition P that subdivides the interval $[-1, 2]$ into n subintervals of width $\Delta x = \frac{2-(-1)}{n} = \frac{3}{n}$ and let c_k be the right endpoint of each subinterval. So the partition is $P = \left\{ -1, -1 + \frac{3}{n}, -1 + 2 \cdot \frac{3}{n}, \dots, -1 + n \cdot \frac{3}{n} = 2 \right\}$

$$\begin{aligned}
 \text{and } c_k &= -1 + k \cdot \frac{3}{n} = -1 + \frac{3k}{n}. \text{ We get the Riemann sum } \sum_{k=1}^n f(c_k)\Delta x = \sum_{k=1}^n \left(3\left(-1 + \frac{3k}{n}\right)^2 - 2\left(-1 + \frac{3k}{n}\right) + 1 \right) \cdot \frac{3}{n} \\
 &= \frac{3}{n} \sum_{k=1}^n \left(3 - \frac{18k}{n} + \frac{27k^2}{n^2} + 2 - \frac{6k}{n} + 1 \right) = \frac{18}{n} \sum_{k=1}^n 1 - \frac{72}{n^2} \sum_{k=1}^n k + \frac{81}{n^3} \sum_{k=1}^n k^2 = \frac{18}{n} \cdot n - \frac{72}{n^2} \cdot \frac{n(n+1)}{2} + \frac{81}{n^3} \cdot \frac{n(n+1)(2n+1)}{6} \\
 &= 18 - \frac{36(n+1)}{n} + \frac{27(n+1)(2n+1)}{2n^2}. \text{ As } n \rightarrow \infty \text{ and } \|P\| \rightarrow 0 \text{ this expression has value } 18 - 36 + 27 = 9. \\
 \text{Thus, } &\int_{-1}^2 (3x^2 - 2x + 1)dx = 9.
 \end{aligned}$$

68. Consider the partition P that subdivides the interval $[-1, 1]$ into n subintervals of width $\Delta x = \frac{1-(-1)}{n} = \frac{2}{n}$ and let c_k be the right endpoint of each subinterval. So the partition is $P = \left\{ -1, -1 + \frac{2}{n}, -1 + 2 \cdot \frac{2}{n}, \dots, -1 + n \cdot \frac{2}{n} = 1 \right\}$ and

$$\begin{aligned}
 c_k &= -1 + k \cdot \frac{2}{n} = -1 + \frac{2k}{n}. \text{ We get the Riemann sum } \sum_{k=1}^n f(c_k)\Delta x = \sum_{k=1}^n c_k^3 \left(\frac{2}{n}\right) = \frac{2}{n} \sum_{k=1}^n \left(-1 + \frac{2k}{n}\right)^3 \\
 &= \frac{2}{n} \sum_{k=1}^n \left(-1 + \frac{6k}{n} - \frac{12k^2}{n^2} + \frac{8k^3}{n^3} \right) = \frac{2}{n} \left(-\sum_{k=1}^n 1 + \frac{6}{n} \sum_{k=1}^n k - \frac{12}{n^2} \sum_{k=1}^n k^2 + \frac{8}{n^3} \sum_{k=1}^n k^3 \right) \\
 &= -\frac{2}{n} \cdot n + \frac{12}{n^2} \cdot \frac{n(n+1)}{2} - \frac{24}{n^3} \cdot \frac{n(n+1)(2n+1)}{6} + \frac{16}{n^4} \cdot \left(\frac{n(n+1)}{2}\right)^2 = -2 + 6 \cdot \frac{n+1}{n} - 4 \cdot \frac{(n+1)(2n+1)}{n^2} + 4 \cdot \frac{(n+1)^2}{n^2} = -2 + 6 \cdot \frac{1+\frac{1}{n}}{1}
 \end{aligned}$$

$$= -2 + 6 \cdot \frac{1+\frac{1}{n}}{1} - 4 \cdot \frac{2+\frac{3}{n}+\frac{1}{n^2}}{1} + 4 \cdot \frac{1+\frac{2}{n}+\frac{1}{n^2}}{1}. \text{ As } n \rightarrow \infty \text{ and } \|P\| \rightarrow 0 \text{ this expression has value } -2 + 6 - 8 + 4 = 0.$$

Thus, $\int_{-1}^1 x^3 dx = 0$.

69. Consider the partition P that subdivides the interval $[a, b]$ into n subintervals of width $\Delta x = \frac{b-a}{n}$ and let c_k be the right endpoint of each subinterval. So the partition is $P = \left\{ a, a + \frac{b-a}{n}, a + \frac{2(b-a)}{n}, \dots, a + \frac{n(b-a)}{n} = b \right\}$ and

$$\begin{aligned} c_k &= a + \frac{k(b-a)}{n}. \text{ We get the Riemann sum } \sum_{k=1}^n f(c_k)\Delta x = \sum_{k=1}^n c_k^3 \left(\frac{b-a}{n}\right) = \frac{b-a}{n} \sum_{k=1}^n \left(a + \frac{k(b-a)}{n}\right)^3 \\ &= \frac{b-a}{n} \sum_{k=1}^n \left(a^3 + \frac{3a^2k(b-a)}{n} + \frac{3ak^2(b-a)^2}{n^2} + \frac{k^3(b-a)^3}{n^3}\right) = \frac{b-a}{n} \left(\sum_{k=1}^n a^3 + \frac{3a^2(b-a)}{n} \sum_{k=1}^n k + \frac{3a(b-a)^2}{n^2} \sum_{k=1}^n k^2 + \frac{(b-a)^3}{n^3} \sum_{k=1}^n k^3\right) \\ &= \frac{b-a}{n} \cdot na^3 + \frac{3a^2(b-a)^2}{n^2} \cdot \frac{n(n+1)}{2} + \frac{3a(b-a)^3}{n^3} \cdot \frac{n(n+1)(2n+1)}{6} + \frac{(b-a)^4}{n^4} \cdot \left(\frac{n(n+1)}{2}\right)^2 \\ &= (b-a)a^3 + \frac{3a^2(b-a)^2}{2} \cdot \frac{n+1}{n} + \frac{a(b-a)^3}{2} \cdot \frac{(n+1)(2n+1)}{n^2} + \frac{(b-a)^4}{4} \cdot \frac{(n+1)^2}{n^2} \\ &= (b-a)a^3 + \frac{3a^2(b-a)^2}{2} \cdot \frac{1+\frac{1}{n}}{1} + \frac{a(b-a)^3}{2} \cdot \frac{2+\frac{3}{n}+\frac{1}{n^2}}{1} + \frac{(b-a)^4}{4} \cdot \frac{1+\frac{2}{n}+\frac{1}{n^2}}{1}. \text{ As } n \rightarrow \infty \text{ and } \|P\| \rightarrow 0 \text{ this expression has} \\ &\text{value } (b-a)a^3 + \frac{3a^2(b-a)^2}{2} + a(b-a)^3 + \frac{(b-a)^4}{4} = \frac{b^4}{4} - \frac{a^4}{4}. \text{ Thus, } \int_a^b x^3 dx = \frac{b^4}{4} - \frac{a^4}{4}. \end{aligned}$$

70. Consider the partition P that subdivides the interval $[0, 1]$ into n subintervals of width $\Delta x = \frac{1-0}{n} = \frac{1}{n}$ and let c_k be the right endpoint of each subinterval. So the partition is $P = \left\{ 0, 0 + \frac{1}{n}, 0 + 2 \cdot \frac{1}{n}, \dots, 0 + n \cdot \frac{1}{n} = 1 \right\}$ and

$$\begin{aligned} c_k &= 0 + k \cdot \frac{1}{n} = \frac{k}{n}. \text{ We get the Riemann sum } \sum_{k=1}^n f(c_k)\Delta x = \sum_{k=1}^n (3c_k - c_k^3) \left(\frac{1}{n}\right) = \frac{1}{n} \sum_{k=1}^n \left(3 \cdot \frac{k}{n} - \left(\frac{k}{n}\right)^3\right) \\ &= \frac{1}{n} \left(\frac{3}{n} \sum_{k=1}^n k - \frac{1}{n^3} \sum_{k=1}^n k^3\right) = \frac{3}{n^2} \cdot \frac{n(n+1)}{2} - \frac{1}{n^4} \cdot \left(\frac{n(n+1)}{2}\right)^2 = \frac{3}{2} \cdot \frac{n+1}{n} - \frac{1}{4} \cdot \frac{(n+1)^2}{n^2} = \frac{3}{2} \cdot \frac{1+\frac{1}{n}}{1} - \frac{1}{4} \cdot \frac{1+\frac{2}{n}+\frac{1}{n^2}}{1}. \text{ As } n \rightarrow \infty \text{ and} \end{aligned}$$

$\|P\| \rightarrow 0$ this expression has value $\frac{3}{2} - \frac{1}{4} = \frac{5}{4}$. Thus, $\int_0^1 (3x - x^3) dx = \frac{5}{4}$.

71. To find where $x - x^2 \geq 0$, let $x - x^2 = 0 \Rightarrow x(1-x) = 0 \Rightarrow x = 0$ or $x = 1$. If $0 < x < 1$, then $0 < x - x^2 \Rightarrow a = 0$ and $b = 1$ maximize the integral.

72. To find where $x^4 - 2x^2 \leq 0$, let $x^4 - 2x^2 = 0 \Rightarrow x^2(x^2 - 2) = 0 \Rightarrow x = 0$ or $x = \pm\sqrt{2}$. By the sign graph, $\begin{matrix} ++++++ & 0 & - - - - & 0 & ++++++ \\ & -\sqrt{2} & & \sqrt{2} & \end{matrix}$, we can see that $x^4 - 2x^2 \leq 0$ on $[-\sqrt{2}, \sqrt{2}] \Rightarrow a = -\sqrt{2}$ and $b = \sqrt{2}$ minimize the integral.

73. $f(x) = \frac{1}{1+x^2}$ is decreasing on $[0, 1] \Rightarrow$ maximum value of f occurs at $0 \Rightarrow \max f = f(0) = 1$; minimum value of f occurs at $1 \Rightarrow \min f = f(1) = \frac{1}{1+1^2} = \frac{1}{2}$. Therefore, $(1-0) \min f \leq \int_0^1 \frac{1}{1+x^2} dx \leq (1-0) \max f \Rightarrow \frac{1}{2} \leq \int_0^1 \frac{1}{1+x^2} dx \leq 1$. That is, an upper bound = 1 and a lower bound = $\frac{1}{2}$.

74. See Exercise 73 above. On $[0, 0.5]$, $\max f = \frac{1}{1+0^2} = 1$, $\min f = \frac{1}{1+(0.5)^2} = 0.8$. Therefore
 $(0.5-0) \min f \leq \int_0^{0.5} f(x) dx \leq (0.5-0) \max f \Rightarrow \frac{2}{5} \leq \int_0^{0.5} \frac{1}{1+x^2} dx \leq \frac{1}{2}$. On $[0.5, 1]$, $\max f = \frac{1}{1+(0.5)^2} = 0.8$
and $\min f = \frac{1}{1+1^2} = 0.5$. Therefore $(1-0.5) \min f \leq \int_{0.5}^1 \frac{1}{1+x^2} dx \leq (1-0.5) \max f \Rightarrow \frac{1}{4} \leq \int_{0.5}^1 \frac{1}{1+x^2} dx \leq \frac{2}{5}$.
Then $\frac{1}{4} + \frac{2}{5} \leq \int_0^{0.5} \frac{1}{1+x^2} dx + \int_{0.5}^1 \frac{1}{1+x^2} dx \leq \frac{1}{2} + \frac{2}{5} \Rightarrow \frac{13}{20} \leq \int_0^1 \frac{1}{1+x^2} dx \leq \frac{9}{10}$.
75. $-1 \leq \sin(x^2) \leq 1$ for all $x \Rightarrow (1-0)(-1) \leq \int_0^1 \sin(x^2) dx \leq (1-0)(1)$ or $\int_0^1 \sin x^2 dx \leq 1 \Rightarrow \int_0^1 \sin x^2 dx$ cannot equal 2.
76. $f(x) = \sqrt{x+8}$ is increasing on $[0, 1] \Rightarrow \max f = f(1) = \sqrt{1+8} = 3$ and $\min f = f(0) = \sqrt{0+8} = 2\sqrt{2}$. Therefore,
 $(1-0) \min f \leq \int_0^1 \sqrt{x+8} dx \leq (1-0) \max f \Rightarrow 2\sqrt{2} \leq \int_0^1 \sqrt{x+8} dx \leq 3$.
77. If $f(x) \geq 0$ on $[a, b]$, then $\min f \geq 0$ and $\max f \geq 0$ on $[a, b]$. Now, $(b-a) \min f \leq \int_a^b f(x) dx \leq (b-a) \max f$.
Then $b \geq a \Rightarrow b-a \geq 0 \Rightarrow (b-a) \min f \geq 0 \Rightarrow \int_a^b f(x) dx \geq 0$.
78. If $f(x) \leq 0$ on $[a, b]$, then $\min f \leq 0$ and $\max f \leq 0$. Now, $(b-a) \min f \leq \int_a^b f(x) dx \leq (b-a) \max f$. Then
 $b \geq a \Rightarrow b-a \geq 0 \Rightarrow (b-a) \max f \leq 0 \Rightarrow \int_a^b f(x) dx \leq 0$.
79. $\sin x \leq x$ for $x \geq 0 \Rightarrow \sin x - x \leq 0$ for $x \geq 0 \Rightarrow \int_0^1 (\sin x - x) dx \leq 0$ (see Exercise 78) $\Rightarrow \int_0^1 \sin x dx - \int_0^1 x dx \leq 0$
 $\Rightarrow \int_0^1 \sin x dx \leq \int_0^1 x dx \Rightarrow \int_0^1 \sin x dx \leq \left(\frac{1^2}{2} - \frac{0^2}{2}\right) \Rightarrow \int_0^1 \sin x dx \leq \frac{1}{2}$. Thus an upper bound is $\frac{1}{2}$.
80. $\sec x \geq 1 + \frac{x^2}{2}$ on $(-\frac{\pi}{2}, \frac{\pi}{2}) \Rightarrow \sec x - \left(1 + \frac{x^2}{2}\right) \geq 0$ on $(-\frac{\pi}{2}, \frac{\pi}{2}) \Rightarrow \int_0^1 \left[\sec x - \left(1 + \frac{x^2}{2}\right)\right] dx \geq 0$ (see Exercise 77)
since $[0, 1]$ is contained in $(-\frac{\pi}{2}, \frac{\pi}{2}) \Rightarrow \int_0^1 \sec x dx - \int_0^1 \left(1 + \frac{x^2}{2}\right) dx \geq 0 \Rightarrow \int_0^1 \sec x dx \geq \int_0^1 \left(1 + \frac{x^2}{2}\right) dx$
 $\Rightarrow \int_0^1 \sec x dx \geq \int_0^1 1 dx + \frac{1}{2} \int_0^1 x^2 dx \Rightarrow \int_0^1 \sec x dx \geq (1-0) + \frac{1}{2} \left(\frac{1^3}{3}\right) \Rightarrow \int_0^1 \sec x dx \geq \frac{7}{6}$. Thus a lower bound is $\frac{7}{6}$.
81. Yes, for the following reasons: $\text{av}(f) = \frac{1}{b-a} \int_a^b f(x) dx$ is a constant K . Thus
 $\int_a^b \text{av}(f) dx = \int_a^b K dx = K(b-a) \Rightarrow \int_a^b \text{av}(f) dx = (b-a)K = (b-a) \cdot \frac{1}{b-a} \int_a^b f(x) dx = \int_a^b f(x) dx$.
82. All three rules hold. The reasons: On any interval $[a, b]$ on which f and g are integrable, we have:
(a) $\text{av}(f+g) = \frac{1}{b-a} \int_a^b [f(x)+g(x)] dx = \frac{1}{b-a} \left[\int_a^b f(x) dx + \int_a^b g(x) dx \right] = \frac{1}{b-a} \int_a^b f(x) dx + \frac{1}{b-a} \int_a^b g(x) dx$
 $= \text{av}(f) + \text{av}(g)$
(b) $\text{av}(kf) = \frac{1}{b-a} \int_a^b kf(x) dx = \frac{1}{b-a} \left[k \int_a^b f(x) dx \right] = k \left[\frac{1}{b-a} \int_a^b f(x) dx \right] = k \text{av}(f)$

(c) $av(f) = \frac{1}{b-a} \int_a^b f(x) dx = \frac{1}{b-a} \int_a^b g(x) dx$ since $f(x) \leq g(x)$ on $[a, b]$, and $\frac{1}{b-a} \int_a^b g(x) dx = av(g)$.

Therefore, $av(f) \leq av(g)$.

83. (a) $U = \max_1 \Delta x + \max_2 \Delta x + \dots + \max_n \Delta x$ where $\max_1 = f(x_1), \max_2 = f(x_2), \dots, \max_n = f(x_n)$ since f is increasing on $[a, b]$; $L = \min_1 \Delta x + \min_2 \Delta x + \dots + \min_n \Delta x$ where $\min_1 = f(x_0), \min_2 = f(x_1), \dots, \min_n = f(x_{n-1})$ since f is increasing on $[a, b]$. Therefore

$$U - L = (\max_1 - \min_1) \Delta x + (\max_2 - \min_2) \Delta x + \dots + (\max_n - \min_n) \Delta x$$

$$= (f(x_1) - f(x_0)) \Delta x + (f(x_2) - f(x_1)) \Delta x + \dots + (f(x_n) - f(x_{n-1})) \Delta x = (f(x_n) - f(x_0)) \Delta x$$

$$= (f(b) - f(a)) \Delta x.$$

(b) $U = \max_1 \Delta x_1 + \max_2 \Delta x_2 + \dots + \max_n \Delta x_n$ where $\max_1 = f(x_1), \max_2 = f(x_2), \dots, \max_n = f(x_n)$ since f is increasing on $[a, b]$; $L = \min_1 \Delta x_1 + \min_2 \Delta x_2 + \dots + \min_n \Delta x_n$ where $\min_1 = f(x_0), \min_2 = f(x_1), \dots, \min_n = f(x_{n-1})$ since f is increasing on $[a, b]$. Therefore

$$U - L = (\max_1 - \min_1) \Delta x_1 + (\max_2 - \min_2) \Delta x_2 + \dots + (\max_n - \min_n) \Delta x_n$$

$$= (f(x_1) - f(x_0)) \Delta x_1 + (f(x_2) - f(x_1)) \Delta x_2 + \dots + (f(x_n) - f(x_{n-1})) \Delta x_n$$

$$\leq (f(x_1) - f(x_0)) \Delta x_{\max} + (f(x_2) - f(x_1)) \Delta x_{\max} + \dots + (f(x_n) - f(x_{n-1})) \Delta x_{\max}.$$

Then

$$U - L \leq (f(x_n) - f(x_0)) \Delta x_{\max} = (f(b) - f(a)) \Delta x_{\max} = |f(b) - f(a)| \Delta x_{\max}$$

since $f(b) \geq f(a)$. Thus

$$\lim_{\|P\| \rightarrow 0} (U - L) = \lim_{\|P\| \rightarrow 0} (f(b) - f(a)) \Delta x_{\max} = 0, \text{ since } \Delta x_{\max} = \|P\|.$$

84. (a) $U = \max_1 \Delta x + \max_2 \Delta x + \dots + \max_n \Delta x$ where $\max_1 = f(x_0), \max_2 = f(x_1), \dots, \max_n = f(x_{n-1})$ since f is decreasing on $[a, b]$;

$L = \min_1 \Delta x + \min_2 \Delta x + \dots + \min_n \Delta x$ where $\min_1 = f(x_1), \min_2 = f(x_2), \dots, \min_n = f(x_n)$ since f is decreasing on $[a, b]$. Therefore

$$U - L = (\max_1 - \min_1) \Delta x + (\max_2 - \min_2) \Delta x$$

$$+ \dots + (\max_n - \min_n) \Delta x$$

$$= (f(x_0) - f(x_1)) \Delta x + (f(x_1) - f(x_2)) \Delta x$$

$$+ \dots + (f(x_{n-1}) - f(x_n)) \Delta x$$

$$= (f(x_0) - f(x_n)) \Delta x = (f(a) - f(b)) \Delta x.$$

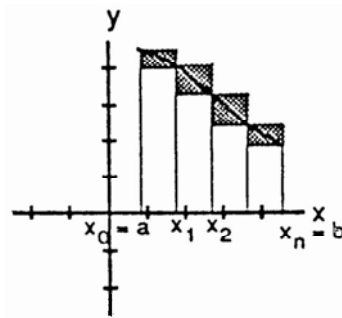

(b) $U = \max_1 \Delta x_1 + \max_2 \Delta x_2 + \dots + \max_n \Delta x_n$ where $\max_1 = f(x_0), \max_2 = f(x_1), \dots, \max_n = f(x_{n-1})$ since f is decreasing on $[a, b]$; $L = \min_1 \Delta x_1 + \min_2 \Delta x_2 + \dots + \min_n \Delta x_n$ where $\min_1 = f(x_1), \min_2 = f(x_2), \dots, \min_n = f(x_n)$ since f is decreasing on $[a, b]$. Therefore

$$U - L = (\max_1 - \min_1) \Delta x_1 + (\max_2 - \min_2) \Delta x_2 + \dots + (\max_n - \min_n) \Delta x_n$$

$$= (f(x_0) - f(x_1)) \Delta x_1 + (f(x_1) - f(x_2)) \Delta x_2 + \dots + (f(x_{n-1}) - f(x_n)) \Delta x_n \leq (f(x_0) - f(x_n)) \Delta x_{\max}$$

$$= (f(a) - f(b)) \Delta x_{\max} = |f(b) - f(a)| \Delta x_{\max}$$

since $f(b) \leq f(a)$. Thus

$$\lim_{\|P\| \rightarrow 0} (U - L) = \lim_{\|P\| \rightarrow 0} |f(b) - f(a)| \Delta x_{\max} = 0, \text{ since } \Delta x_{\max} = \|P\|.$$

85. (a) Partition $\left[0, \frac{\pi}{2}\right]$ into n subintervals, each of length $\Delta x = \frac{\pi}{2n}$ with points $x_0 = 0, x_1 = \Delta x, x_2 = 2\Delta x, \dots, x_n = n\Delta x = \frac{\pi}{2}$. Since $\sin x$ is increasing on $\left[0, \frac{\pi}{2}\right]$, the upper sum U is the sum of the areas of the circumscribed rectangles of areas $f(x_1) \Delta x = (\sin \Delta x) \Delta x, f(x_2) \Delta x = (\sin 2\Delta x) \Delta x, \dots, f(x_n) \Delta x = (\sin n\Delta x) \Delta x$.

$$\begin{aligned} \text{Then } U &= (\sin \Delta x + \sin 2\Delta x + \dots + \sin n\Delta x)\Delta x = \left[\frac{\cos \frac{\Delta x}{2} - \cos \left((n + \frac{1}{2})\Delta x \right)}{2 \sin \frac{\Delta x}{2}} \right] \Delta x = \left[\frac{\cos \frac{\pi}{4n} - \cos \left((n + \frac{1}{2})\frac{\pi}{2n} \right)}{2 \sin \frac{\pi}{4n}} \right] \left(\frac{\pi}{2n} \right) \\ &= \frac{\pi \left(\cos \frac{\pi}{4n} - \cos \left(\frac{\pi}{2} + \frac{\pi}{4n} \right) \right)}{4n \sin \frac{\pi}{4n}} = \frac{\cos \frac{\pi}{4n} - \cos \left(\frac{\pi}{2} + \frac{\pi}{4n} \right)}{\left(\frac{\sin \frac{\pi}{4n}}{\frac{\pi}{4n}} \right)} \end{aligned}$$

(b) The area is $\int_0^{\pi/2} \sin x \, dx = \lim_{n \rightarrow \infty} \frac{\cos \frac{\pi}{4n} - \cos \left(\frac{\pi}{2} + \frac{\pi}{4n} \right)}{\left(\frac{\sin \frac{\pi}{4n}}{\frac{\pi}{4n}} \right)} = \frac{1 - \cos \frac{\pi}{2}}{1} = 1.$

86. (a) The area of the shaded region is $\sum_{i=1}^n \Delta x_i \cdot m_i$ which is equal to L .
 (b) The area of the shaded region is $\sum_{i=1}^n \Delta x_i \cdot M_i$ which is equal to U .
 (c) The area of the shaded region is the difference in the areas of the shaded regions shown in the second part of the figure and the first part of the figure. Thus this area is $U - L$.

87. By Exercise 86, $U - L = \sum_{i=1}^n \Delta x_i \cdot M_i - \sum_{i=1}^n \Delta x_i \cdot m_i$ where $M_i = \max \{f(x) \text{ on the } i\text{th subinterval}\}$ and $m_i = \min \{f(x) \text{ on } i\text{th subinterval}\}$. Thus $U - L = \sum_{i=1}^n (M_i - m_i)\Delta x_i < \sum_{i=1}^n \epsilon \cdot \Delta x_i$ provided $\Delta x_i < \delta$ for each $i = 1, \dots, n$. Since $\sum_{i=1}^n \epsilon \cdot \Delta x_i = \epsilon \sum_{i=1}^n \Delta x_i = \epsilon(b - a)$ the result, $U - L < \epsilon(b - a)$ follows.

88. The car drove the first 150 miles in 5 hours and the second 150 miles in 3 hours, which means it drove 300 miles in 8 hours, for an average value of $\frac{300}{8}$ mi/hr = 37.5 mi/hr. In terms of average value of functions, the function whose average value we seek is $v(t) = \begin{cases} 30, & 0 \leq t \leq 5 \\ 50, & 5 \leq t \leq 8 \end{cases}$, and the average value is $\frac{(30)(5) + (50)(3)}{8} = 37.5$.

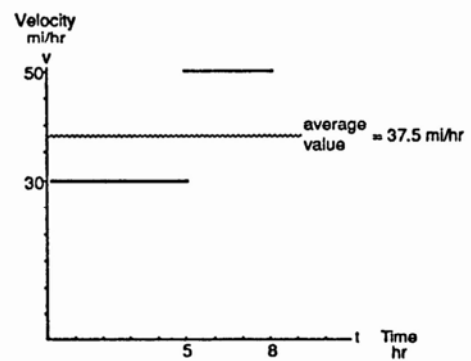

89-94. Example CAS commands:

Maple:

```
with(plots);
with(Student[Calculus1]);
f := x -> 1-x;
a := 0;
b := 1;
N := [4, 10, 20, 50];
P := [seq( RiemannSum( f(x), x=a..b, partition=n, method=random, output=plot ), n=N )];
display( P, insequence=true);
```

95-102. Example CAS commands:

Maple:

```

with( Student[Calculus1] );
f := x -> sin(x);
a := 0;
b := Pi;
plot( f(x), x=a..b, title= "#95(a) (Section 5.3)" );
N := [ 100, 200, 1000 ]; # (b)
for n in N do
  Xlist := [ a+1.*(b-a)/n*i $ i=0..n ];
  Ylist := map( f, Xlist );
end do;
for n in N do # (c)
  Avg[n] := evalf(add(y,y=Ylist)/nops(Ylist));
end do;
avg := FunctionAverage( f(x), x=a..b, output=value );
evalf( avg );
FunctionAverage(f(x),x=a..b, output=plot); # (d)
fsolve( f(x)=avg, x=0.5 );
fsolve( f(x)=avg, x=2.5 );
fsolve( f(x)=Avg[1000], x=0.5 );
fsolve( f(x)=Avg[1000], x=2.5 );

```

89-102. Example CAS commands:

Mathematica: (assigned function and values for a, b, and n may vary)

Sums of rectangles evaluated at left-hand endpoints can be represented and evaluated by this set of commands

```

Clear[x, f, a, b, n]
{a, b}={0, Pi}; n =10; dx = (b - a)/n;
f = Sin[x]^2;
xvals=Table[N[x], {x, a, b - dx, dx}];
yvals = f /. x -> xvals;
boxes = MapThread[Line[{{#1, 0}, {#1, #3}}, {#2, #3}, {#2, 0}]&, {xvals, xvals + dx, yvals}];
Plot[f, {x, a, b}, Epilog -> boxes];
Sum[yvals[[i]] dx, {i, 1, Length[yvals]}]//N

```

Sums of rectangles evaluated at right-hand endpoints can be represented and evaluated by this set of commands.

```

Clear[x, f, a, b, n]
{a, b}={0, Pi}; n =10; dx = (b - a)/n;
f = Sin[x]^2;
xvals =Table[N[x], {x, a + dx, b, dx}];
yvals = f /. x -> xvals;
boxes = MapThread[Line[{{#1, 0}, {#1, #3}}, {#2, #3}, {#2, 0}]&, {xvals, -dx, xvals, yvals}];
Plot[f, {x, a, b}, Epilog -> boxes];
Sum[yvals[[i]] dx, {i, 1, Length[yvals]}]//N

```

Sums of rectangles evaluated at midpoints can be represented and evaluated by this set of commands.

```
Clear[x, f, a, b, n]
{a, b} = {0, π}; n = 10; dx = (b - a)/n;
f = Sin[x]^2;
xvals = Table[N[x], {x, a + dx/2, b - dx/2, dx}];
yvals = f /. x -> xvals;
boxes = MapThread[Line[{{#1, 0}, {#1, #3}}, {#2, #3}, {#2, 0}] &, {xvals, -dx/2, xvals + dx/2, yvals}];
Plot[f, {x, a, b}, Epilog -> boxes];
Sum[yvals[[i]] dx, {i, 1, Length[yvals]}]/N
```

5.4 THE FUNDAMENTAL THEOREM OF CALCULUS

$$1. \int_0^2 x(x-3) dx = \int_0^2 (x^2 - 3x) dx = \left[\frac{x^3}{3} - \frac{3x^2}{2} \right]_0^2 = \left(\frac{(2)^3}{3} - \frac{3(2)^2}{2} \right) - \left(\frac{(0)^3}{3} - \frac{3(0)^2}{2} \right) = -\frac{10}{3}$$

$$2. \int_{-1}^1 (x^2 - 2x + 3) dx = \left[\frac{x^3}{3} - x^2 + 3x \right]_{-1}^1 = \left(\frac{(1)^3}{3} - (1)^2 + 3(1) \right) - \left(\frac{(-1)^3}{3} - (-1)^2 + 3(-1) \right) = \frac{20}{3}$$

$$3. \int_{-2}^2 \frac{3}{(x+3)^4} dx = \left[-\frac{1}{(x+3)^3} \right]_{-2}^2 = \left(-\frac{1}{(5)^3} - \left(-\frac{1}{(1)^3} \right) \right) = 1 - \frac{1}{125} = \frac{124}{125}$$

$$4. \int_{-1}^1 x^{299} dx = \left[\frac{x^{300}}{300} \right]_{-1}^1 = \frac{1}{300} \left((1)^{300} - (-1)^{300} \right) = \frac{1}{300} (1 - 1) = 0$$

$$5. \int_1^4 \left(3x^2 - \frac{x^3}{4} \right) dx = \left[x^3 - \frac{x^4}{16} \right]_1^4 = \left(\left(4^3 - \frac{4^4}{16} \right) - \left(1^3 - \frac{1^4}{16} \right) \right) = \left(64 - 16 - 1 + \frac{1}{16} \right) = \frac{753}{16}$$

$$6. \int_{-2}^3 (x^3 - 2x + 3) dx = \left[\frac{x^4}{4} - x^2 + 3x \right]_{-2}^3 = \left(\frac{3^4}{4} - 3^2 + 3(3) \right) - \left(\frac{(-2)^4}{4} - (-2)^2 + 3(-2) \right) = \frac{81}{4} + 6 = \frac{105}{4}$$

$$7. \int_0^1 (x^2 + \sqrt{x}) dx = \left[\frac{x^3}{3} + \frac{2}{3} x^{3/2} \right]_0^1 = \left(\frac{1}{3} + \frac{2}{3} \right) - 0 = 1$$

$$8. \int_1^{32} x^{-6/5} dx = \left[-5x^{-1/5} \right]_1^{32} = \left(-\frac{5}{2} \right) - (-5) = \frac{5}{2}$$

$$9. \int_0^{\pi/3} 2 \sec^2 x dx = [2 \tan x]_0^{\pi/3} = \left(2 \tan \left(\frac{\pi}{3} \right) \right) - (2 \tan 0) = 2\sqrt{3} - 0 = 2\sqrt{3}$$

10. $\int_0^{\pi} (1 + \cos x) dx = [x + \sin x]_0^{\pi} = (\pi + \sin \pi) - (0 + \sin 0) = \pi$
11. $\int_{\pi/4}^{3\pi/4} \csc \theta \cot \theta d\theta = [-\csc \theta]_{\pi/4}^{3\pi/4} = \left(-\csc\left(\frac{3\pi}{4}\right)\right) - \left(-\csc\left(\frac{\pi}{4}\right)\right) = -\sqrt{2} - (-\sqrt{2}) = 0$
12. $\int_0^{\pi/3} 4 \frac{\sin u}{\cos^2 u} du = \frac{4}{\cos u} \Big|_0^{\pi/3} = \left(\frac{4}{(1/2)} - \frac{4}{1}\right) = 4$
13. $\int_{\pi/2}^0 \frac{1+\cos 2t}{2} dt = \int_{\pi/2}^0 \left(\frac{1}{2} + \frac{1}{2} \cos 2t\right) dt = \left[\frac{1}{2}t + \frac{1}{4} \sin 2t\right]_{\pi/2}^0 = \left(\frac{1}{2}(0) + \frac{1}{4} \sin 2(0)\right) - \left(\frac{1}{2}\left(\frac{\pi}{2}\right) + \frac{1}{4} \sin 2\left(\frac{\pi}{2}\right)\right) = -\frac{\pi}{4}$
14. $\int_{-\pi/3}^{\pi/3} \sin^2 t dt$ Use the double angle formula $\cos 2t = 1 - 2\sin^2 t$ which implies that $\sin^2 t = \frac{1 - \cos(2t)}{2}$.
- $$\int_{-\pi/3}^{\pi/3} \sin^2 t dt = \int_{-\pi/3}^{\pi/3} \frac{1 - \cos 2t}{2} dt = \left[\frac{t}{2} - \frac{\sin 2t}{4}\right]_{-\pi/3}^{\pi/3}$$
- $$= \left(\frac{\pi}{6} - \frac{1}{4}\left(\frac{\sqrt{3}}{2}\right)\right) - \left(-\frac{\pi}{6} - \frac{1}{4}\left(-\frac{\sqrt{3}}{2}\right)\right) = \frac{\pi}{3} - \frac{\sqrt{3}}{4}$$
15. $\int_0^{\pi/4} \tan^2 x dx = \int_0^{\pi/4} (\sec^2 x - 1) dx = [\tan x - x]_0^{\pi/4} = \left(\tan\left(\frac{\pi}{4}\right) - \frac{\pi}{4}\right) - (\tan(0) - 0) = 1 - \frac{\pi}{4}$
16. $\int_0^{\pi/6} (\sec x + \tan x)^2 dx = \int_0^{\pi/6} (\sec^2 x + 2 \sec x \tan x + \tan^2 x) dx = \int_0^{\pi/6} (2 \sec^2 x + 2 \sec x \tan x - 1) dx$
 $= [2 \tan x + 2 \sec x - x]_0^{\pi/6} = \left(2 \tan\left(\frac{\pi}{6}\right) + 2 \sec\left(\frac{\pi}{6}\right) - \left(\frac{\pi}{6}\right)\right) - (2 \tan 0 + 2 \sec 0 - 0) = 2\sqrt{3} - \frac{\pi}{6} - 2$
17. $\int_0^{\pi/8} \sin 2x dx = \left[-\frac{1}{2} \cos 2x\right]_0^{\pi/8} = \left(-\frac{1}{2} \cos 2\left(\frac{\pi}{8}\right)\right) - \left(-\frac{1}{2} \cos 2(0)\right) = \frac{2 - \sqrt{2}}{4}$
18. $\int_{-\pi/3}^{-\pi/4} \left(4 \sec^2 t + \frac{\pi}{t^2}\right) dt = \int_{-\pi/3}^{-\pi/4} (4 \sec^2 t + \pi t^{-2}) dt = \left[4 \tan t - \frac{\pi}{t}\right]_{-\pi/3}^{-\pi/4}$
 $= \left(4 \tan\left(-\frac{\pi}{4}\right) - \frac{\pi}{(-\pi/4)}\right) - \left(4 \tan\left(\frac{\pi}{3}\right) - \frac{\pi}{(-\pi/3)}\right) = (4(-1) + 4) - (4(-\sqrt{3}) + 3) = 4\sqrt{3} - 3$
19. $\int_1^{-1} (r+1)^2 dr = \int_1^{-1} (r^2 + 2r + 1) dr = \left[\frac{r^3}{3} + r^2 + r\right]_1^{-1} = \left(\frac{(-1)^3}{3} + (-1)^2 + (-1)\right) - \left(\frac{1^3}{3} + 1^2 + 1\right) = -\frac{8}{3}$
20. $\int_{-\sqrt{3}}^{\sqrt{3}} (t+1)(t^2+4) dt = \int_{-\sqrt{3}}^{\sqrt{3}} (t^3 + t^2 + 4t + 4) dt = \left[\frac{t^4}{4} + \frac{t^3}{3} + 2t^2 + 4t\right]_{-\sqrt{3}}^{\sqrt{3}}$
 $= \left(\frac{(\sqrt{3})^4}{4} + \frac{(\sqrt{3})^3}{3} + 2(\sqrt{3})^2 + 4\sqrt{3}\right) - \left(\frac{(-\sqrt{3})^4}{4} + \frac{(-\sqrt{3})^3}{3} + 2(-\sqrt{3})^2 + 4(-\sqrt{3})\right) = 10\sqrt{3}$

21. $\int_{\sqrt{2}}^1 \left(\frac{u^7}{2} - \frac{1}{u^5} \right) du = \int_{\sqrt{2}}^1 \left(\frac{u^7}{2} - u^{-5} \right) du = \left[\frac{u^8}{16} + \frac{1}{4u^4} \right]_{\sqrt{2}}^1 = \left(\frac{1^8}{16} + \frac{1}{4(1)^4} \right) - \left(\frac{(\sqrt{2})^8}{16} + \frac{1}{4(\sqrt{2})^4} \right) = -\frac{3}{4}$
22. $\int_{-3}^{-1} \frac{y^5 - 2y}{y^3} dy = \int_{-3}^{-1} (y^2 - 2y^{-2}) dy = \left[\frac{y^3}{3} + 2y^{-1} \right]_{-3}^{-1} = \left(\frac{(-1)^3}{3} + \frac{2}{(-1)} \right) - \left(\frac{(-3)^3}{3} + \frac{2}{(-3)} \right) = \frac{22}{3}$
23. $\int_1^{\sqrt{2}} \frac{s^2 + \sqrt{s}}{s^2} ds = \int_1^{\sqrt{2}} (1 + s^{-3/2}) ds = \left[s - \frac{2}{\sqrt{s}} \right]_1^{\sqrt{2}} = \left(\sqrt{2} - \frac{2}{\sqrt{\sqrt{2}}} \right) - \left(1 - \frac{2}{\sqrt{1}} \right) = \sqrt{2} - 2^{3/4} + 1 = \sqrt{2} - \sqrt[4]{8} + 1$
24. $\int_1^8 \frac{(x^{1/3} + 1)(2 - x^{2/3})}{x^{1/3}} dx = \int_1^8 \frac{2x^{1/3} - x + 2 - x^{2/3}}{x^{1/3}} dx = \int_1^8 (2 - x^{2/3} + 2x^{-1/3} - x^{1/3}) dx = \left[2x - \frac{3}{5}x^{5/3} + 3x^{2/3} - \frac{3}{4}x^{4/3} \right]_1^8 = \left(2(8) - \frac{3}{5}(8)^{5/3} + 3(8)^{2/3} - \frac{3}{4}(8)^{4/3} \right) - \left(2(1) - \frac{3}{5}(1)^{5/3} + 3(1)^{2/3} - \frac{3}{4}(1)^{4/3} \right) = -\frac{137}{20}$
25. $\int_{\pi/2}^{\pi} \frac{\sin 2x}{2 \sin x} dx = \int_{\pi/2}^{\pi} \frac{2 \sin x \cos x}{2 \sin x} dx = \int_{\pi/2}^{\pi} \cos x dx = [\sin x]_{\pi/2}^{\pi} = (\sin(\pi)) - \left(\sin\left(\frac{\pi}{2}\right) \right) = -1$
26. $\int_0^{\pi/3} (\cos x + \sec x)^2 dx = \int_0^{\pi/3} (\cos^2 x + 2 + \sec^2 x) dx = \int_0^{\pi/3} \left(\frac{\cos 2x + 1}{2} + 2 + \sec^2 x \right) dx = \int_0^{\pi/3} \left(\frac{1}{2} \cos 2x + \frac{5}{2} + \sec^2 x \right) dx = \left[\frac{1}{4} \sin 2x + \frac{5}{2}x + \tan x \right]_0^{\pi/3} = \left(\frac{1}{4} \sin 2\left(\frac{\pi}{3}\right) + \frac{5}{2}\left(\frac{\pi}{3}\right) + \tan\left(\frac{\pi}{3}\right) \right) - \left(\frac{1}{4} \sin 2(0) + \frac{5}{2}(0) + \tan(0) \right) = \frac{5\pi}{6} + \frac{9\sqrt{3}}{8}$
27. $\int_{-4}^4 |x| dx = \int_{-4}^0 |x| dx + \int_0^4 |x| dx = -\int_{-4}^0 x dx + \int_0^4 x dx = \left[-\frac{x^2}{2} \right]_{-4}^0 + \left[\frac{x^2}{2} \right]_0^4 = \left(-\frac{0^2}{2} + \frac{(-4)^2}{2} \right) + \left(\frac{4^2}{2} - \frac{0^2}{2} \right) = 16$
28. $\int_0^{\pi} \frac{1}{2} (\cos x + |\cos x|) dx = \int_0^{\pi/2} \frac{1}{2} (\cos x + \cos x) dx + \int_{\pi/2}^{\pi} \frac{1}{2} (\cos x - \cos x) dx = \int_0^{\pi/2} \cos x dx = [\sin x]_0^{\pi/2} = \sin \frac{\pi}{2} - \sin 0 = 1$
29. $\int_0^{\ln 2} e^{3x} dx = \frac{1}{3} e^{3x} \Big|_0^{\ln 2} = \frac{1}{3} e^{3 \ln 2} - \frac{1}{3} e^0 = \frac{1}{3} e^{\ln 8} - \frac{1}{3} = \frac{8}{3} - \frac{1}{3} = \frac{7}{3}$
30. $\int_1^2 \left(\frac{1}{x} - e^{-x} \right) dx = (\ln x + e^{-x}) \Big|_1^2 = (\ln 2 + e^{-2}) - (\ln 1 + e^{-1}) = \ln 2 + \frac{1}{e^2} - \frac{1}{e}$
31. $\int_0^{1/2} \frac{4}{\sqrt{1-x^2}} dx = 4 \sin^{-1} x \Big|_0^{1/2} = 4 \sin^{-1} \left(\frac{1}{2} \right) - 4 \sin^{-1} 0 = 4 \left(\frac{\pi}{6} \right) - 4(0) = \frac{2\pi}{3}$
32. $\int_0^{1/\sqrt{3}} \frac{dx}{1+4x^2} = \int_0^{1/\sqrt{3}} \frac{dx}{1+2^2 x^2} = \frac{1}{2} \tan^{-1}(2x) \Big|_0^{1/\sqrt{3}} = \frac{1}{2} \tan^{-1} \left(\frac{2}{\sqrt{3}} \right) - \frac{1}{2} \tan^{-1}(0) = \frac{1}{2} \tan^{-1} \left(\frac{2}{\sqrt{3}} \right)$
33. $\int_2^4 x^{\pi-1} dx = \frac{x^{\pi}}{\pi} \Big|_2^4 = \frac{1}{\pi} (4^{\pi} - 2^{\pi})$

$$34. \int_{-1}^0 \pi^{x-1} dx = \frac{1}{\ln \pi} \cdot \pi^{x-1} \Big|_{-1}^0 = \frac{1}{\ln \pi} (\pi^{-1} - \pi^{-2})$$

$$35. \int_0^1 x e^{x^2} dx = \frac{1}{2} e^{x^2} \Big|_0^1 = \frac{1}{2} e^1 - \frac{1}{2} e^0 = \frac{1}{2} (e - 1)$$

$$36. \int_1^2 \frac{\ln x}{x} dx = \frac{1}{2} (\ln x)^2 \Big|_1^2 = \frac{1}{2} (\ln 2)^2 - \frac{1}{2} (\ln 1)^2 = \frac{1}{2} (\ln 2)^2$$

$$37. \int_2^5 \frac{x}{\sqrt{1+x^2}} dx = \int_2^5 x(1+x^2)^{1/2} dx = \sqrt{1+x^2} \Big|_2^5 = \sqrt{26} - \sqrt{5}$$

$$38. \int_0^{\pi/3} \sin^2 x \cos x dx = \int_0^{\pi/3} (\sin x)^2 \cos x dx = \frac{1}{3} (\sin x)^3 \Big|_0^{\pi/3} = \frac{1}{3} \sin^3 \left(\frac{\pi}{3} \right) - \frac{1}{3} \sin^3 (0) = \frac{\sqrt{3}}{8}$$

$$39. \text{(a)} \int_0^{\sqrt{x}} \cos t dt = [\sin t]_0^{\sqrt{x}} = \sin \sqrt{x} - \sin 0 = \sin \sqrt{x} \Rightarrow \frac{d}{dx} \left(\int_0^{\sqrt{x}} \cos t dt \right) \\ = \frac{d}{dx} (\sin \sqrt{x}) = \cos \sqrt{x} \left(\frac{1}{2} x^{-1/2} \right) = \frac{\cos \sqrt{x}}{2\sqrt{x}}$$

$$\text{(b)} \frac{d}{dx} \left(\int_0^{\sqrt{x}} \cos t dt \right) = (\cos \sqrt{x}) \left(\frac{d}{dx} (\sqrt{x}) \right) = (\cos \sqrt{x}) \left(\frac{1}{2} x^{-1/2} \right) = \frac{\cos \sqrt{x}}{2\sqrt{x}}$$

$$40. \text{(a)} \int_1^{\sin x} 3t^2 dt = [t^3]_1^{\sin x} = \sin^3 x - 1 \Rightarrow \frac{d}{dx} \left(\int_1^{\sin x} 3t^2 dt \right) = \frac{d}{dx} (\sin^3 x - 1) = 3 \sin^2 x \cos x$$

$$\text{(b)} \frac{d}{dx} \left(\int_1^{\sin x} 3t^2 dt \right) = (3 \sin^2 x) \left(\frac{d}{dx} (\sin x) \right) = 3 \sin^2 x \cos x$$

$$41. \text{(a)} \int_0^{t^4} \sqrt{u} du = \int_0^{t^4} u^{1/2} du = \left[\frac{2}{3} u^{3/2} \right]_0^{t^4} = \frac{2}{3} (t^4)^{3/2} - 0 = \frac{2}{3} t^6 \Rightarrow \frac{d}{dt} \left(\int_0^{t^4} \sqrt{u} du \right) = \frac{d}{dt} \left(\frac{2}{3} t^6 \right) = 4t^5$$

$$\text{(b)} \frac{d}{dt} \left(\int_0^{t^4} \sqrt{u} du \right) = \sqrt{t^4} \left(\frac{d}{dt} (t^4) \right) = t^2 (4t^3) = 4t^5$$

$$42. \text{(a)} \int_0^{\tan \theta} \sec^2 y dy = [\tan y]_0^{\tan \theta} = \tan(\tan \theta) - 0 = \tan(\tan \theta) \Rightarrow \frac{d}{d\theta} \left(\int_0^{\tan \theta} \sec^2 y dy \right) \\ = \frac{d}{d\theta} (\tan(\tan \theta)) = (\sec^2(\tan \theta)) \sec^2 \theta$$

$$\text{(b)} \frac{d}{d\theta} \left(\int_0^{\tan \theta} \sec^2 y dy \right) = (\sec^2(\tan \theta)) \left(\frac{d}{d\theta} (\tan \theta) \right) = (\sec^2(\tan \theta)) \sec^2 \theta$$

$$43. \text{(a)} \int_0^{x^3} e^{-t} dt = -e^{-t} \Big|_0^{x^3} = -e^{-x^3} + 1 \Rightarrow \frac{d}{dx} \left(\int_0^{x^3} e^{-t} dt \right) = \frac{d}{dx} (-e^{-x^3} + 1) = 3x^2 e^{-x^3}$$

$$\text{(b)} \frac{d}{dx} \left(\int_0^{x^3} e^{-t} dt \right) = e^{-x^3} \cdot \frac{d}{dx} (x^3) = 3x^2 e^{-x^3}$$

$$44. \text{ (a) } \int_0^{\sqrt{t}} \left(x^4 + \frac{3}{\sqrt{1-x^2}} \right) dx = \frac{x^5}{5} + 3 \sin^{-1} x \Big|_0^{\sqrt{t}} = \frac{1}{5} t^{5/2} + 3 \sin^{-1} \sqrt{t}$$

$$\Rightarrow \frac{d}{dt} \int_0^{\sqrt{t}} \left(x^4 + \frac{3}{\sqrt{1-x^2}} \right) dx = \frac{d}{dt} \left(\frac{1}{5} t^{5/2} + 3 \sin^{-1} \sqrt{t} \right) = \frac{1}{5} \cdot \frac{5}{2} t^{3/2} + \frac{3}{\sqrt{1-t}} \cdot \frac{1}{2\sqrt{t}} = \frac{1}{2} t^{3/2} + \frac{3}{2\sqrt{t-t^2}}$$

$$\text{(b) } \frac{d}{dt} \int_0^{\sqrt{t}} \left(x^4 + \frac{3}{\sqrt{1-x^2}} \right) dx = \left(t^2 + \frac{3}{\sqrt{1-t}} \right) \cdot \frac{d}{dt} (\sqrt{t}) = \left(t^2 + \frac{3}{\sqrt{1-t}} \right) \cdot \frac{1}{2\sqrt{t}} = \frac{1}{2} t^{3/2} + \frac{3}{2\sqrt{t-t^2}}$$

$$45. \quad y = \int_0^x \sqrt{1+t^2} dt \Rightarrow \frac{dy}{dx} = \sqrt{1+x^2} \qquad 46. \quad y = \int_1^x \frac{1}{t} dt \Rightarrow \frac{dy}{dx} = \frac{1}{x}, x > 0$$

$$47. \quad y = \int_{\sqrt{x}}^0 \sin t^2 dt = -\int_0^{\sqrt{x}} \sin t^2 dt \Rightarrow \frac{dy}{dx} = -(\sin(\sqrt{x})^2) \left(\frac{d}{dx} (\sqrt{x}) \right) = -(\sin x) \left(\frac{1}{2} x^{-1/2} \right) = -\frac{\sin x}{2\sqrt{x}}$$

$$48. \quad y = x \int_2^{x^2} \sin t^3 dt \Rightarrow \frac{dy}{dx} = x \cdot \frac{d}{dx} \left(\int_2^{x^2} \sin t^3 dt \right) + 1 \cdot \int_2^{x^2} \sin t^3 dt = x \cdot \sin(x^2)^3 \frac{d}{dx} (x^2) + \int_2^{x^2} \sin t^3 dt$$

$$= 2x^2 \sin x^6 + \int_2^{x^2} \sin t^3 dt$$

$$49. \quad y = \int_{-1}^x \frac{t^2}{t^2+4} dt - \int_3^x \frac{t^2}{t^2+4} dt \Rightarrow \frac{dy}{dx} = \frac{x^2}{x^2+4} - \frac{x^2}{x^2+4} = 0$$

$$50. \quad y = \left(\int_0^x (t^3 + 1)^{10} dt \right)^3 \Rightarrow \frac{dy}{dx} = 3 \left(\int_0^x (t^3 + 1)^{10} dt \right)^2 \frac{d}{dx} \left(\int_0^x (t^3 + 1)^{10} dt \right) = 3(x^3 + 1)^{10} \left(\int_0^x (t^3 + 1)^{10} dt \right)^2$$

$$51. \quad y = \int_0^{\sin x} \frac{dt}{\sqrt{1-t^2}}, |x| < \frac{\pi}{2} \Rightarrow \frac{dy}{dx} = \frac{1}{\sqrt{1-\sin^2 x}} \left(\frac{d}{dx} (\sin x) \right) = \frac{1}{\sqrt{\cos^2 x}} (\cos x) = \frac{\cos x}{|\cos x|} = \frac{\cos x}{\cos x} = 1 \text{ since } |x| < \frac{\pi}{2}$$

$$52. \quad y = \int_0^{\tan x} \frac{dt}{1+t^2} \Rightarrow \frac{dy}{dx} = \left(\frac{1}{1+\tan^2 x} \right) \left(\frac{d}{dx} (\tan x) \right) = \left(\frac{1}{\sec^2 x} \right) (\sec^2 x) = 1$$

$$53. \quad y = \int_0^{e^{x^2}} \frac{1}{\sqrt{t}} dt \Rightarrow \frac{dy}{dx} = \frac{1}{\sqrt{e^{x^2}}} \cdot \frac{d}{dx} (e^{x^2}) = \frac{1}{e^{x^2/2}} \cdot 2xe^{x^2} = 2xe^{x^2/2}$$

$$54. \quad y = \int_{2^x}^1 \sqrt[3]{t} dt = -\int_1^{2^x} t^{1/3} dt \Rightarrow \frac{dy}{dx} = -(2^x)^{1/3} \cdot \frac{d}{dx} (2^x) = -2^{x/3} \cdot 2^x \ln 2 = -2^{4x/3} \ln 2$$

$$55. \quad y = \int_0^{\sin^{-1} t} \cos t dt \Rightarrow \frac{dy}{dx} = \cos(\sin^{-1} x) \cdot \frac{d}{dx} (\sin^{-1} x) = \sqrt{1-x^2} \cdot \frac{1}{\sqrt{1-x^2}} = 1$$

$$56. \quad y = \int_{-1}^{x^{1/\pi}} \sin^{-1} t dt \Rightarrow \frac{dy}{dx} = \sin^{-1} \left(x^{1/\pi} \right) \cdot \frac{d}{dx} \left(x^{1/\pi} \right) = \sin^{-1} \left(x^{1/\pi} \right) \cdot \frac{1}{\pi} x^{1/\pi - 1}$$

57. $-x^2 - 2x = 0 \Rightarrow -x(x+2) = 0 \Rightarrow x = 0$ or $x = -2$;

$$\begin{aligned} \text{Area} &= -\int_{-3}^{-2} (-x^2 - 2x) dx + \int_{-2}^0 (-x^2 - 2x) dx \\ &\quad - \int_0^2 (-x^2 - 2x) dx \\ &= -\left[-\frac{x^3}{3} - x^2\right]_{-3}^{-2} + \left[-\frac{x^3}{3} - x^2\right]_{-2}^0 - \left[-\frac{x^3}{3} - x^2\right]_0^2 \\ &= -\left(\left(-\frac{(-2)^3}{3} - (-2)^2\right) - \left(-\frac{(-3)^3}{3} - (-3)^2\right)\right) \\ &\quad + \left(\left(-\frac{0^3}{3} - 0^2\right) - \left(-\frac{(-2)^3}{3} - (-2)^2\right)\right) \\ &\quad - \left(\left(-\frac{2^3}{3} - 2^2\right) - \left(-\frac{0^3}{3} - 0^2\right)\right) = \frac{28}{3} \end{aligned}$$

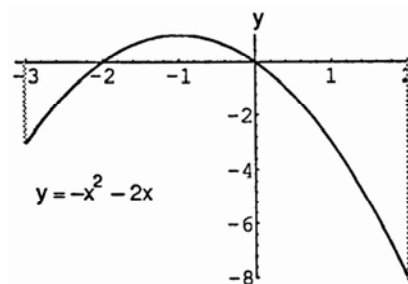

58. $3x^2 - 3 = 0 \Rightarrow x^2 = 1 \Rightarrow x = \pm 1$;
because of symmetry about the y -axis,

$$\begin{aligned} \text{Area} &= 2\left(-\int_0^1 (3x^2 - 3) dx + \int_1^2 (3x^2 - 3) dx\right) \\ &= 2\left(-[x^3 - 3x]_0^1 + [x^3 - 3x]_1^2\right) \\ &= 2\left[-((1^3 - 3(1)) - (0^3 - 3(0))) + ((2^3 - 3(2)) - (1^3 - 3(1)))\right] \\ &= 2(6) = 12 \end{aligned}$$

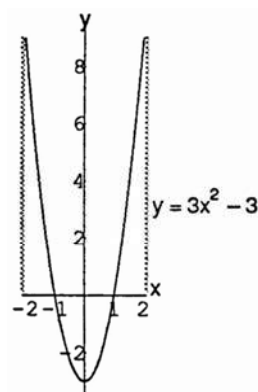

59. $x^3 - 3x^2 + 2x = 0 \Rightarrow x(x^2 - 3x + 2) = 0$
 $\Rightarrow x(x-2)(x-1) = 0 \Rightarrow x = 0, 1,$ or 2 ;

$$\begin{aligned} \text{Area} &= \int_0^1 (x^3 - 3x^2 + 2x) dx - \int_1^2 (x^3 - 3x^2 + 2x) dx \\ &= \left[\frac{x^4}{4} - x^3 + x^2\right]_0^1 - \left[\frac{x^4}{4} - x^3 + x^2\right]_1^2 = \left(\frac{1^4}{4} - 1^3 + 1^2\right) - \left(\frac{0^4}{4} - 0^3 + 0^2\right) \\ &\quad - \left[\left(\frac{2^4}{4} - 2^3 + 2^2\right) - \left(\frac{1^4}{4} - 1^3 + 1^2\right)\right] = \frac{1}{2} \end{aligned}$$

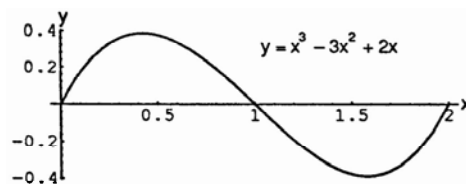

60. $x^{1/3} - x = 0 \Rightarrow x^{1/3}(1 - x^{2/3}) = 0 \Rightarrow x^{1/3} = 0$ or $1 - x^{2/3} = 0 \Rightarrow x = 0$
or $1 = x^{2/3} \Rightarrow x = 0$ or $1 = x^2 \Rightarrow x = 0$ or $x = \pm 1$;

$$\begin{aligned} \text{Area} &= -\int_{-1}^0 (x^{1/3} - x) dx + \int_0^1 (x^{1/3} - x) dx - \int_1^8 (x^{1/3} - x) dx \\ &= -\left[\frac{3}{4}x^{4/3} - \frac{x^2}{2}\right]_{-1}^0 + \left[\frac{3}{4}x^{4/3} - \frac{x^2}{2}\right]_0^1 - \left[\frac{3}{4}x^{4/3} - \frac{x^2}{2}\right]_1^8 \\ &= -\left[\left(\frac{3}{4}(0)^{4/3} - \frac{0^2}{2}\right) - \left(\frac{3}{4}(-1)^{4/3} - \frac{(-1)^2}{2}\right)\right] \\ &\quad + \left[\left(\frac{3}{4}(1)^{4/3} - \frac{1^2}{2}\right) - \left(\frac{3}{4}(0)^{4/3} - \frac{0^2}{2}\right)\right] \\ &\quad - \left[\left(\frac{3}{4}(8)^{4/3} - \frac{8^2}{2}\right) - \left(\frac{3}{4}(1)^{4/3} - \frac{1^2}{2}\right)\right] \\ &= \frac{1}{4} + \frac{1}{4} - \left(-20 - \frac{3}{4} + \frac{1}{2}\right) = \frac{83}{4} \end{aligned}$$

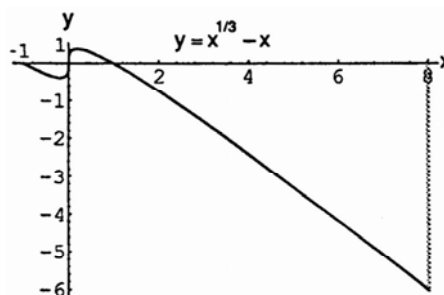

61. The area of the rectangle bounded by the lines $y = 2$, $y = 0$, $x = \pi$, and $x = 0$ is 2π . The area under the curve $y = 1 + \cos x$ on $[0, \pi]$ is $\int_0^\pi (1 + \cos x) dx = [x + \sin x]_0^\pi = (\pi + \sin \pi) - (0 + \sin 0) = \pi$. Therefore the area of the shaded region is $2\pi - \pi = \pi$.
62. The area of the rectangle bounded by the lines by the lines $x = \frac{\pi}{6}$, $x = \frac{5\pi}{6}$, $y = \sin \frac{\pi}{6} = \frac{1}{2} = \sin \frac{5\pi}{6}$, and $y = 0$ is $\frac{1}{2}(\frac{5\pi}{6} - \frac{\pi}{6}) = \frac{\pi}{3}$. The area under the curve $y = \sin x$ on $[\frac{\pi}{6}, \frac{5\pi}{6}]$ is $\int_{\pi/6}^{5\pi/6} \sin x dx = [-\cos x]_{\pi/6}^{5\pi/6} = (-\cos \frac{5\pi}{6}) - (-\cos \frac{\pi}{6}) = -(-\frac{\sqrt{3}}{2}) + \frac{\sqrt{3}}{2} = \sqrt{3}$. Therefore the area of the shaded region is $\sqrt{3} - \frac{\pi}{3}$.
63. On $[-\frac{\pi}{4}, 0]$: The area of the rectangle bounded by the lines $y = \sqrt{2}$, $y = 0$, $\theta = 0$, and $\theta = -\frac{\pi}{4}$ is $\sqrt{2}(\frac{\pi}{4}) = \frac{\pi\sqrt{2}}{4}$. The area between the curve $y = \sec \theta \tan \theta$ and $y = 0$ is $-\int_{-\pi/4}^0 \sec \theta \tan \theta d\theta = [-\sec \theta]_{-\pi/4}^0 = (-\sec 0) - (-\sec(-\frac{\pi}{4})) = \sqrt{2} - 1$. Therefore the area of the shaded region on $[-\frac{\pi}{4}, 0]$ is $\frac{\pi\sqrt{2}}{4} + (\sqrt{2} - 1)$.
On $[0, \frac{\pi}{4}]$: The area of the rectangle bounded by $\theta = \frac{\pi}{4}$, $\theta = 0$, $y = \sqrt{2}$, and $y = 0$ is $\sqrt{2}(\frac{\pi}{4}) = \frac{\pi\sqrt{2}}{4}$. The area under the curve $y = \sec \theta \tan \theta$ is $\int_0^{\pi/4} \sec \theta \tan \theta d\theta = [\sec \theta]_0^{\pi/4} = \sec \frac{\pi}{4} - \sec 0 = \sqrt{2} - 1$. Therefore the area of the shaded region on $[0, \frac{\pi}{4}]$ is $\frac{\pi\sqrt{2}}{4} - (\sqrt{2} - 1)$. Thus, the area of the total shaded region is $(\frac{\pi\sqrt{2}}{4} + \sqrt{2} - 1) + (\frac{\pi\sqrt{2}}{4} - \sqrt{2} + 1) = \frac{\pi\sqrt{2}}{2}$.
64. The area of the rectangle bounded by the lines $y = 2$, $y = 0$, $t = -\frac{\pi}{4}$, and $t = 1$ is $2(1 - (-\frac{\pi}{4})) = 2 + \frac{\pi}{2}$. The area under the curve $y = \sec^2 t$ on $[-\frac{\pi}{4}, 0]$ is $\int_{-\pi/4}^0 \sec^2 t dt = [\tan t]_{-\pi/4}^0 = \tan 0 - \tan(-\frac{\pi}{4}) = 1$. The area under the curve $y = 1 - t^2$ on $[0, 1]$ is $\int_0^1 (1 - t^2) dt = [t - \frac{t^3}{3}]_0^1 = (1 - \frac{1^3}{3}) - (0 - \frac{0^3}{3}) = \frac{2}{3}$. Thus, the total area under the curves on $[-\frac{\pi}{4}, 1]$ is $1 + \frac{2}{3} = \frac{5}{3}$. Therefore the area of the shaded region is $(2 + \frac{\pi}{2}) - \frac{5}{3} = \frac{1}{3} + \frac{\pi}{2}$.
65. $y = \int_\pi^x \frac{1}{t} dt - 3 \Rightarrow \frac{dy}{dx} = \frac{1}{x}$ and $y(\pi) = \int_\pi^\pi \frac{1}{t} dt - 3 = 0 - 3 = -3 \Rightarrow (d)$ is a solution to this problem.
66. $y = \int_{-1}^x \sec t dt + 4 \Rightarrow \frac{dy}{dx} = \sec x$ and $y(-1) = \int_{-1}^{-1} \sec t dt + 4 = 0 + 4 = 4 \Rightarrow (c)$ is a solution to this problem.
67. $y = \int_0^x \sec t dt + 4 \Rightarrow \frac{dy}{dx} = \sec x$ and $y(0) = \int_0^0 \sec t dt + 4 = 0 + 4 = 4 \Rightarrow (b)$ is a solution to this problem.
68. $y = \int_1^x \frac{1}{t} dt - 3 \Rightarrow \frac{dy}{dx} = \frac{1}{x}$ and $y(1) = \int_1^1 \frac{1}{t} dt - 3 = 0 - 3 = -3 \Rightarrow (a)$ is a solution to this problem.
69. $y = \int_2^x \sec t dt + 3$
70. $y = \int_1^x \sqrt{1+t^2} dt - 2$

$$\begin{aligned}
 71. \text{ Area} &= \int_{-b/2}^{b/2} \left(h - \frac{4h}{b^2} x^2 \right) dx = \left[hx - \frac{4hx^3}{3b^2} \right]_{-b/2}^{b/2} \\
 &= \left(h \left(\frac{b}{2} \right) - \frac{4h \left(\frac{b}{2} \right)^2}{3b^2} \right) - \left(h \left(-\frac{b}{2} \right) - \frac{4h \left(-\frac{b}{2} \right)^2}{3b^2} \right) \\
 &= \left(\frac{bh}{2} - \frac{bh}{6} \right) - \left(-\frac{bh}{2} + \frac{bh}{6} \right) = bh - \frac{bh}{3} = \frac{2}{3} bh
 \end{aligned}$$

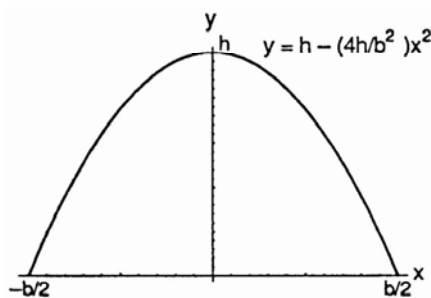

$$\begin{aligned}
 72. \quad k > 0 \Rightarrow \text{one arch of } y = \sin kx \text{ will occur over the interval } \left[0, \frac{\pi}{k} \right] \Rightarrow \text{the area} &= \int_0^{\pi/k} \sin kx \, dx = \left[-\frac{1}{k} \cos kx \right]_0^{\pi/k} \\
 &= -\frac{1}{k} \cos \left(k \left(\frac{\pi}{k} \right) \right) - \left(-\frac{1}{k} \cos(0) \right) = \frac{2}{k}
 \end{aligned}$$

$$73. \quad \frac{dc}{dx} = \frac{1}{2\sqrt{x}} = \frac{1}{2} x^{-1/2} \Rightarrow c = \int_0^x \frac{1}{2} t^{-1/2} dt = [t^{1/2}]_0^x = \sqrt{x}; \quad c(100) - c(1) = \sqrt{100} - \sqrt{1} = \$9.00$$

$$\begin{aligned}
 74. \quad r &= \int_0^3 \left(2 - \frac{2}{(x+1)^2} \right) dx = 2 \int_0^3 \left(1 - \frac{1}{(x+1)^2} \right) dx = 2 \left[x - \left(\frac{-1}{x+1} \right) \right]_0^3 = 2 \left[\left(3 + \frac{1}{3+1} \right) - \left(0 + \frac{1}{0+1} \right) \right] \\
 &= 2 \left[3\frac{1}{4} - 1 \right] = 2 \left(2\frac{1}{4} \right) = 4.5 \text{ or } \$4500
 \end{aligned}$$

$$75. \quad \text{(a) } t = 0 \Rightarrow T = 85 - 3\sqrt{25-0} = 70^\circ\text{F}; \quad t = 16 \Rightarrow T = 85 - 3\sqrt{25-16} = 76^\circ\text{F};$$

$$t = 25 \Rightarrow T = 85 - 3\sqrt{25-25} = 85^\circ\text{F}$$

$$\begin{aligned}
 \text{(b) average temperature} &= \frac{1}{25-0} \int_0^{25} (85 - 3\sqrt{25-t}) dt = \frac{1}{25} \left[85t + 2(25-t)^{3/2} \right]_0^{25} \\
 &= \frac{1}{25} \left(85(25) + 2(25-25)^{3/2} \right) - \frac{1}{25} \left(85(0) + 2(25-0)^{3/2} \right) = 75^\circ\text{F}
 \end{aligned}$$

$$76. \quad \text{(a) } t = 0 \Rightarrow H = \sqrt{0+1} + 5(0)^{1/3} = 1 \text{ ft}; \quad t = 4 \Rightarrow H = \sqrt{4+1} + 5(4)^{1/3} = \sqrt{5} + 5\sqrt[3]{4} \approx 10.17 \text{ ft};$$

$$t = 8 \Rightarrow H = \sqrt{8+1} + 5(8)^{1/3} = 13 \text{ ft}$$

$$\begin{aligned}
 \text{(b) average height} &= \frac{1}{8-0} \int_0^8 (\sqrt{t+1} + 5t^{1/3}) dt = \frac{1}{8} \left[\frac{2}{3}(t+1)^{3/2} + \frac{15}{4}t^{4/3} \right]_0^8 \\
 &= \frac{1}{8} \left(\frac{2}{3}(8+1)^{3/2} + \frac{15}{4}(8)^{4/3} \right) - \frac{1}{8} \left(\frac{2}{3}(0+1)^{3/2} + \frac{15}{4}(0)^{4/3} \right) = \frac{29}{3} \approx 9.67 \text{ ft}
 \end{aligned}$$

$$77. \quad \int_1^x f(t) dt = x^2 - 2x + 1 \Rightarrow f(x) = \frac{d}{dx} \int_1^x f(t) dt = \frac{d}{dx} (x^2 - 2x + 1) = 2x - 2$$

$$78. \quad \int_0^x f(t) dt = x \cos \pi x \Rightarrow f(x) = \frac{d}{dx} \int_0^x f(t) dt = \cos \pi x - \pi x \sin \pi x \Rightarrow f(4) = \cos \pi(4) - \pi(4) \sin \pi(4) = 1$$

$$\begin{aligned}
 79. \quad f(x) &= 2 - \int_2^{x+1} \frac{9}{1+t} dt \Rightarrow f'(x) = -\frac{9}{1+(x+1)} = \frac{-9}{x+2} \Rightarrow f'(1) = -3; \quad f(1) = 2 - \int_2^{1+1} \frac{9}{1+t} dt = 2 - 0 = 2; \\
 L(x) &= -3(x-1) + f(1) = -3(x-1) + 2 = -3x + 5
 \end{aligned}$$

80. $g(x) = 3 + \int_1^{x^2} \sec(t-1) dt \Rightarrow g'(x) = (\sec(x^2 - 1))(2x) = 2x \sec(x^2 - 1) \Rightarrow g'(-1) = 2(-1) \sec((-1)^2 - 1) = -2;$

$$g(-1) = 3 + \int_1^{(-1)^2} \sec(t-1) dt = 3 + \int_1^1 \sec(t-1) dt = 3 + 0 = 3;$$

$$L(x) = -2(x - (-1)) + g(-1) = -2(x + 1) + 3 = -2x + 1$$

81. (a) True: since f is continuous, g is differentiable by Part 1 of the Fundamental Theorem of Calculus.
 (b) True: g is continuous because it is differentiable.
 (c) True: since $g'(1) = f(1) = 0$.
 (d) False, since $g''(1) = f'(1) > 0$.
 (e) True, since $g'(1) = 0$ and $g''(1) = f'(1) > 0$.
 (f) False: $g''(x) = f'(x) > 0$, so g'' never changes sign.
 (g) True, since $g'(1) = f(1) = 0$ and $g'(x) = f(x)$ is an increasing function of x (because $f'(x) > 0$).

82. Let $a = x_0 < x_1 < x_2 \cdots < x_n = b$ be any partition of $[a, b]$ and left F be any antiderivative of f .

(a) $\sum_{i=1}^n [F(x_i) - F(x_{i-1})]$
 $= [F(x_1) - F(x_0)] + [F(x_2) - F(x_1)] + [F(x_3) - F(x_2)] + \cdots + [F(x_{n-1}) - F(x_{n-2})] + [F(x_n) - F(x_{n-1})]$
 $= -F(x_0) + F(x_1) - F(x_1) + F(x_2) - F(x_2) + \cdots + F(x_{n-1}) - F(x_{n-1}) + F(x_n)$
 $= F(x_n) - F(x_0) = F(b) - F(a)$

(b) Since F is any antiderivative of f on $[a, b] \Rightarrow F$ is differentiable on $[a, b] \Rightarrow F$ is continuous on $[a, b]$. Consider any subinterval $[x_{i-1}, x_i]$ in $[a, b]$, then by the Mean Value Theorem there is at least one number c_i in (x_{i-1}, x_i) such that $[F(x_i) - F(x_{i-1})] = F'(c_i)(x_i - x_{i-1}) = f(c_i)(x_i - x_{i-1}) = f(c_i)\Delta x_i$.

$$\text{Thus } F(b) - F(a) = \sum_{i=1}^n [F(x_i) - F(x_{i-1})] = \sum_{i=1}^n f(c_i)\Delta x_i.$$

(c) Taking the limit of $F(b) - F(a) = \sum_{i=1}^n f(c_i)\Delta x_i$ we obtain $\lim_{\|P\| \rightarrow 0} (F(b) - F(a)) = \lim_{\|P\| \rightarrow 0} \left(\sum_{i=1}^n f(c_i)\Delta x_i \right)$

$$\Rightarrow F(b) - F(a) = \int_a^b f(x) dx$$

83. (a) $v = \frac{ds}{dt} = \frac{d}{dt} \int_0^t f(x) dx = f(t) \Rightarrow v(5) = f(5) = 2$ m/sec

(b) $a = \frac{df}{dt}$ is negative since the slope of the tangent line at $t = 5$ is negative

(c) $s = \int_0^3 f(x) dx = \frac{1}{2}(3)(3) = \frac{9}{2}$ m since the integral is the area of the triangle formed by $y = f(x)$, the x -axis and $x = 3$

(d) $t = 6$ since from $t = 6$ to $t = 9$, the region lies below the x -axis

(e) At $t = 4$ and $t = 7$, since there are horizontal tangents there

(f) Toward the origin between $t = 6$ and $t = 9$ since the velocity is negative on this interval. Away from the origin between $t = 0$ and $t = 6$ since the velocity is positive there.

(g) Right or positive side, because the integral of f from 0 to 9 is positive, there being more area above the x -axis than below it.

84. $\lim_{x \rightarrow \infty} \frac{1}{\sqrt{x}} \int_1^x \frac{dt}{\sqrt{t}} = \lim_{x \rightarrow \infty} \frac{1}{\sqrt{x}} [2\sqrt{t}]_1^x = \lim_{x \rightarrow \infty} \frac{1}{\sqrt{x}} (2\sqrt{x} - 2) = \lim_{x \rightarrow \infty} \left(2 - \frac{2}{\sqrt{x}} \right) = 2 - 0 = 2$

85–88. Example CAS commands:

Maple:

```

with( plots );
f := x -> x^3-4*x^2+3*x;
a := 0;
b := 4;
F := unapply( int(f(t),t=a..x), x );          # (a)
p1 := plot( [f(x),F(x)], x=a..b, legend=["y = f(x)","y = F(x)"], title="#85(a) (Section 5.4)" );
p1;
dF := D(F);                                # (b)
q1 := solve( dF(x)=0, x );
pts1 := [ seq( [x,f(x)], x=remove(has,evalf([q1]),I) ) ];
p2 := plot( pts1, style=point, color=blue, symbolsize=18, symbol=diamond, legend="(x,f(x))
          where F'(x)=0" );
display( [p1, p2], title="85(b) (Section 5.4)" );
incr := solve( dF(x)>0, x );                 # (c)
decr := solve( dF(x)<0, x );
df := D(f);                                 # (d)
p3 := plot( [df(x),F(x)], x=a..b, legend=["y = f'(x)","y = F(x)"], title="#85(d) (Section 5.4)" );
p3;
q2 := solve( df(x)=0, x );
pts2 := [ seq( [x,F(x)], x=remove(has,evalf([q2]),I) ) ];
p4 := plot( pts2, style=point, color=blue, symbolsize=18, symbol=diamond, legend="(x,f(x))
          where f'(x)=0" );
display( [p3,p4], title="85(d) (Section 5.4)" );

```

89-92. Example CAS commands:

Maple:

```

a := 1;
u := x -> x^2;
f := x -> sqrt(1-x^2);
F := unapply( int( f(t),t=a..u(x) ), x );
dF := D(F);                                # (b)
cp := solve( dF(x)=0, x );
solve( dF(x)>0, x );
solve( dF(x)<0, x );
d2F := D(dF);                              # (c)
solve( d2F(x)=0, x );
plot( F(x), x=-1..1, title="#89(d) (Section 5.4)" );

```

93. Example CAS commands:

Maple:

```
f := `f`;
q1 := Diff( Int( f(t), t=a..u(x) ), x );
d1 := value( q1 );
```

94. Example CAS commands:

Maple:

```
f := `f`;
q2 := Diff( Int( f(t), t=a..u(x) ), x,x );
value( q2 );
```

85-94. Example CAS commands:

Mathematica: (assigned function and values for a, and b may vary)

For transcendental functions the FindRoot is needed instead of the Solve command.

The Map command executes FindRoot over a set of initial guesses

Initial guesses will vary as the functions vary.

```
Clear[x, f, F]
{a, b}={0, 2π}; f[x_] = Sin[2x] Cos[x/3]
F[x_] = Integrate[f[t], {t, a, x}]
Plot[{f[x], F[x]}, {x, a, b}]
x/.Map[FindRoot[F'[x]==0, {x, #}] &, {2, 3, 5, 6}]
x/.Map[FindRoot[f'[x]==0, {x, #}] &, {1, 2, 4, 5, 6}]
```

Slightly alter above commands for 89–94.

```
Clear[x, f, F, u]
a=0; f[x_] = x2 - 2x - 3
u[x_] = 1 - x2
F[x_] = Integrate[f[t], {t, a, u(x)}]
x/.Map[FindRoot[F'[x]==0, {x, #}] &, {1, 2, 3, 4}]
x/.Map[FindRoot[F''[x]==0, {x, #}] &, {1, 2, 3, 4}]
```

After determining an appropriate value for b, the following can be entered

```
b = 4;
Plot[{F[x]}, {x, a, b}]
```

5.5 INDEFINITE INTEGRALS AND THE SUBSTITUTION METHOD

1. Let $u = 2x + 4 \Rightarrow du = 2 dx \Rightarrow \frac{1}{2} du = dx$

$$\int 2(2x+4)^5 dx = \int 2u^5 \frac{1}{2} du = \int u^5 du = \frac{1}{6}u^6 + C = \frac{1}{6}(2x+4)^6 + C$$

2. Let $u = 7x - 1 \Rightarrow du = 7 dx \Rightarrow \frac{1}{7} du = dx$

$$\int 7\sqrt{7x-1} dx = \int 7(7x-1)^{1/2} dx = \int 7u^{1/2} \frac{1}{7} du = \int u^{1/2} du = \frac{2}{3}u^{3/2} + C = \frac{2}{3}(7x-1)^{3/2} + C$$

3. Let $u = x^2 + 5 \Rightarrow du = 2x dx \Rightarrow \frac{1}{2} du = x dx$
 $\int 2x(x^2 + 5)^{-4} dx = \int 2u^{-4} \frac{1}{2} du = \int u^{-4} du = -\frac{1}{3}u^{-3} + C = -\frac{1}{3}(x^2 + 5)^{-3} + C$
4. Let $u = x^4 + 1 \Rightarrow du = 4x^3 dx \Rightarrow \frac{1}{4} du = x^3 dx$
 $\int \frac{4x^3}{(x^4 + 1)^2} dx = \int 4x^3(x^4 + 1)^{-2} dx = \int 4u^{-2} \frac{1}{4} du = \int u^{-2} du = -u^{-1} + C = \frac{-1}{x^4 + 1} + C$
5. Let $u = 3x^2 + 4x \Rightarrow du = (6x + 4)dx = 2(3x + 2)dx \Rightarrow \frac{1}{2} du = (3x + 2)dx$
 $\int (3x + 2)(3x^2 + 4x)^4 dx = \int u^4 \frac{1}{2} du = \frac{1}{2} \int u^4 du = \frac{1}{10}u^5 + C = \frac{1}{10}(3x^2 + 4x)^5 + C$
6. Let $u = 1 + \sqrt{x} \Rightarrow du = \frac{1}{2\sqrt{x}} dx \Rightarrow 2 du = \frac{1}{\sqrt{x}} dx$
 $\int \frac{(1 + \sqrt{x})^{1/3}}{\sqrt{x}} dx = \int (1 + \sqrt{x})^{1/3} \frac{1}{\sqrt{x}} dx = \int u^{1/3} 2 du = 2 \int u^{1/3} du = 2 \cdot \frac{3}{4}u^{4/3} + C = \frac{3}{2}(1 + \sqrt{x})^{4/3} + C$
7. Let $u = 3x \Rightarrow du = 3 dx \Rightarrow \frac{1}{3} du = dx$
 $\int \sin 3x dx = \int \frac{1}{3} \sin u du = -\frac{1}{3} \cos u + C = -\frac{1}{3} \cos 3x + C$
8. Let $u = 2x^2 \Rightarrow du = 4x dx \Rightarrow \frac{1}{4} du = x dx$
 $\int x \sin(2x^2) dx = \int \frac{1}{4} \sin u du = -\frac{1}{4} \cos u + C = -\frac{1}{4} \cos 2x^2 + C$
9. Let $u = 2t \Rightarrow du = 2 dt \Rightarrow \frac{1}{2} du = dt$
 $\int \sec 2t \tan 2t dt = \int \frac{1}{2} \sec u \tan u du = \frac{1}{2} \sec u + C = \frac{1}{2} \sec 2t + C$
10. Let $u = 1 - \cos \frac{t}{2} \Rightarrow du = \frac{1}{2} \sin \frac{t}{2} dt \Rightarrow 2 du = \sin \frac{t}{2} dt$
 $\int (1 - \cos \frac{t}{2})^2 (\sin \frac{t}{2}) dt = \int 2u^2 du = \frac{2}{3}u^3 + C = \frac{2}{3}(1 - \cos \frac{t}{2})^3 + C$
11. Let $u = 1 - r^3 \Rightarrow du = -3r^2 dr \Rightarrow -3 du = 9r^2 dr$
 $\int \frac{9r^2 dr}{\sqrt{1 - r^3}} = \int -3u^{-1/2} du = -3(2)u^{1/2} + C = -6(1 - r^3)^{1/2} + C$
12. Let $u = y^4 + 4y^2 + 1 \Rightarrow du = (4y^3 + 8y) dy \Rightarrow 3 du = 12(y^3 + 2y) dy$
 $\int 12(y^4 + 4y^2 + 1)^2 (y^3 + 2y) dy = \int 3u^2 du = u^3 + C = (y^4 + 4y^2 + 1)^3 + C$
13. Let $u = x^{3/2} - 1 \Rightarrow du = \frac{3}{2}x^{1/2} dx \Rightarrow \frac{2}{3} du = \sqrt{x} dx$
 $\int \sqrt{x} \sin^2(x^{3/2} - 1) dx = \int \frac{2}{3} \sin^2 u du = \frac{2}{3} \left(\frac{u}{2} - \frac{1}{4} \sin 2u \right) + C = \frac{1}{3}(x^{3/2} - 1) - \frac{1}{6} \sin(2x^{3/2} - 2) + C$
14. Let $u = -\frac{1}{x} \Rightarrow du = \frac{1}{x^2} dx$
 $\int \frac{1}{x^2} \cos^2\left(\frac{1}{x}\right) dx = \int \cos^2(-u) du = \int \cos^2(u) du = \left(\frac{u}{2} + \frac{1}{4} \sin 2u\right) + C = -\frac{1}{2x} + \frac{1}{4} \sin\left(-\frac{2}{x}\right) + C = -\frac{1}{2x} - \frac{1}{4} \sin\left(\frac{2}{x}\right) + C$
15. (a) Let $u = \cot 2\theta \Rightarrow du = -2 \csc^2 2\theta d\theta \Rightarrow -\frac{1}{2} du = \csc^2 2\theta d\theta$
 $\int \csc^2 2\theta \cot 2\theta d\theta = -\int \frac{1}{2} u du = -\frac{1}{2} \left(\frac{u^2}{2}\right) + C = -\frac{u^2}{4} + C = -\frac{1}{4} \cot^2 2\theta + C$

- (b) Let $u = \csc 2\theta \Rightarrow du = -2 \csc 2\theta \cot 2\theta d\theta \Rightarrow -\frac{1}{2} du = \csc 2\theta \cot 2\theta d\theta$
 $\int \csc^2 2\theta \cot 2\theta d\theta = \int -\frac{1}{2} u du = -\frac{1}{2} \left(\frac{u^2}{2} \right) + C = -\frac{u^2}{4} + C = -\frac{1}{4} \csc^2 2\theta + C$
16. (a) Let $u = 5x + 8 \Rightarrow du = 5 dx \Rightarrow \frac{1}{5} du = dx$
 $\int \frac{dx}{\sqrt{5x+8}} = \int \frac{1}{5} \left(\frac{1}{\sqrt{u}} \right) du = \frac{1}{5} \int u^{-1/2} du = \frac{1}{5} (2u^{1/2}) + C = \frac{2}{5} u^{1/2} + C = \frac{2}{5} \sqrt{5x+8} + C$
- (b) Let $u = \sqrt{5x+8} \Rightarrow du = \frac{1}{2} (5x+8)^{-1/2} (5) dx \Rightarrow \frac{2}{5} du = \frac{dx}{\sqrt{5x+8}}$
 $\int \frac{dx}{\sqrt{5x+8}} = \int \frac{2}{5} du = \frac{2}{5} u + C = \frac{2}{5} \sqrt{5x+8} + C$
17. Let $u = 3 - 2s \Rightarrow du = -2 ds \Rightarrow -\frac{1}{2} du = ds$
 $\int \sqrt{3-2s} ds = \int \sqrt{u} \left(-\frac{1}{2} du \right) = -\frac{1}{2} \int u^{1/2} du = \left(-\frac{1}{2} \right) \left(\frac{2}{3} u^{3/2} \right) + C = -\frac{1}{3} (3-2s)^{3/2} + C$
18. Let $u = 5s + 4 \Rightarrow du = 5 ds \Rightarrow \frac{1}{5} du = ds$
 $\int \frac{1}{\sqrt{5s+4}} ds = \int \frac{1}{\sqrt{u}} \left(\frac{1}{5} du \right) = \frac{1}{5} \int u^{-1/2} du = \left(\frac{1}{5} \right) (2u^{1/2}) + C = \frac{2}{5} \sqrt{5s+4} + C$
19. Let $u = 1 - \theta^2 \Rightarrow du = -2\theta d\theta \Rightarrow -\frac{1}{2} du = \theta d\theta$
 $\int \theta^4 \sqrt{1-\theta^2} d\theta = \int \sqrt[4]{u} \left(-\frac{1}{2} du \right) = -\frac{1}{2} \int u^{1/4} du = \left(-\frac{1}{2} \right) \left(\frac{4}{5} u^{5/4} \right) + C = -\frac{2}{5} (1-\theta^2)^{5/4} + C$
20. Let $u = 7 - 3y^2 \Rightarrow du = -6y dy \Rightarrow -\frac{1}{2} du = 3y dy$
 $\int 3y \sqrt{7-3y^2} dy = \int \sqrt{u} \left(-\frac{1}{2} du \right) = -\frac{1}{2} \int u^{1/2} du = \left(-\frac{1}{2} \right) \left(\frac{2}{3} u^{3/2} \right) + C = -\frac{1}{3} (7-3y^2)^{3/2} + C$
21. Let $u = 1 + \sqrt{x} \Rightarrow du = \frac{1}{2\sqrt{x}} dx \Rightarrow 2 du = \frac{1}{\sqrt{x}} dx$
 $\int \frac{1}{\sqrt{x(1+\sqrt{x})^2}} dx = \int \frac{2 du}{u^2} = -\frac{2}{u} + C = \frac{-2}{1+\sqrt{x}} + C$
22. Let $u = \sin x \Rightarrow du = \cos x dx$
 $\int \sqrt{\sin x} (1 - \sin^2 x) \cos x dx = \int (u^{1/2} - u^{5/2}) du = \frac{2}{3} u^{3/2} - \frac{2}{7} u^{7/2} + C = \frac{2}{3} \sin^{3/2} x - \frac{2}{7} \sin^{7/2} x + C$
23. Let $u = 3x + 2 \Rightarrow du = 3 dx \Rightarrow \frac{1}{3} du = dx$
 $\int \sec^2(3x+2) dx = \int (\sec^2 u) \left(\frac{1}{3} du \right) = \frac{1}{3} \int \sec^2 u du = \frac{1}{3} \tan u + C = \frac{1}{3} \tan(3x+2) + C$
24. Let $u = \tan x \Rightarrow du = \sec^2 x dx$
 $\int \tan^2 x \sec^2 x dx = \int u^2 du = \frac{1}{3} u^3 + C = \frac{1}{3} \tan^3 x + C$
25. Let $u = \sin \left(\frac{x}{3} \right) \Rightarrow du = \frac{1}{3} \cos \left(\frac{x}{3} \right) dx \Rightarrow 3 du = \cos \left(\frac{x}{3} \right) dx$
 $\int \sin^5 \left(\frac{x}{3} \right) \cos \left(\frac{x}{3} \right) dx = \int u^5 (3 du) = 3 \left(\frac{1}{6} u^6 \right) + C = \frac{1}{2} \sin^6 \left(\frac{x}{3} \right) + C$
26. Let $u = \tan \left(\frac{x}{2} \right) \Rightarrow du = \frac{1}{2} \sec^2 \left(\frac{x}{2} \right) dx \Rightarrow 2 du = \sec^2 \left(\frac{x}{2} \right) dx$
 $\int \tan^7 \left(\frac{x}{2} \right) \sec^2 \left(\frac{x}{2} \right) dx = \int u^7 (2 du) = 2 \left(\frac{1}{8} u^8 \right) + C = \frac{1}{4} \tan^8 \left(\frac{x}{2} \right) + C$

27. Let $u = \frac{r^3}{18} - 1 \Rightarrow du = \frac{r^2}{6} dr \Rightarrow 6 du = r^2 dr$
 $\int r^2 \left(\frac{r^3}{18} - 1 \right)^5 dr = \int u^5 (6 du) = 6 \int u^5 du = 6 \left(\frac{u^6}{6} \right) + C = \left(\frac{r^3}{18} - 1 \right)^6 + C$
28. Let $u = 7 - \frac{r^5}{10} \Rightarrow du = -\frac{1}{2} r^4 dr \Rightarrow -2 du = r^4 dr$
 $\int r^4 \left(7 - \frac{r^5}{10} \right)^3 dr = \int u^3 (-2 du) = -2 \int u^3 du = -2 \left(\frac{u^4}{4} \right) + C = -\frac{1}{2} \left(7 - \frac{r^5}{10} \right)^4 + C$
29. Let $u = x^{3/2} + 1 \Rightarrow du = \frac{3}{2} x^{1/2} dx \Rightarrow \frac{2}{3} du = x^{1/2} dx$
 $\int x^{1/2} \sin(x^{3/2} + 1) dx = \int (\sin u) \left(\frac{2}{3} du \right) = \frac{2}{3} \int \sin u du = \frac{2}{3} (-\cos u) + C = -\frac{2}{3} \cos(x^{3/2} + 1) + C$
30. Let $u = \csc\left(\frac{v-\pi}{2}\right) \Rightarrow du = -\frac{1}{2} \csc\left(\frac{v-\pi}{2}\right) \cot\left(\frac{v-\pi}{2}\right) dv \Rightarrow -2du = \csc\left(\frac{v-\pi}{2}\right) \cot\left(\frac{v-\pi}{2}\right) dv$
 $\int \csc\left(\frac{v-\pi}{2}\right) \cot\left(\frac{v-\pi}{2}\right) dv = \int -2du = -2u + C = -2 \csc\left(\frac{v-\pi}{2}\right) + C$
31. Let $u = \cos(2t+1) \Rightarrow du = -2 \sin(2t+1) dt \Rightarrow -\frac{1}{2} du = \sin(2t+1) dt$
 $\int \frac{\sin(2t+1)}{\cos^2(2t+1)} dt = \int -\frac{1}{2} \frac{du}{u^2} = \frac{1}{2u} + C = \frac{1}{2\cos(2t+1)} + C$
32. Let $u = \sec z \Rightarrow du = \sec z \tan z dz$
 $\int \frac{\sec z \tan z}{\sqrt{\sec z}} dz = \int \frac{1}{\sqrt{u}} du = \int u^{-1/2} du = 2u^{1/2} + C = 2\sqrt{\sec z} + C$
33. Let $u = \frac{1}{t} - 1 = t^{-1} - 1 \Rightarrow du = -t^{-2} dt \Rightarrow -du = \frac{1}{t^2} dt$
 $\int \frac{1}{t^2} \cos\left(\frac{1}{t} - 1\right) dt = \int (\cos u)(-du) = -\int \cos u du = -\sin u + C = -\sin\left(\frac{1}{t} - 1\right) + C$
34. Let $u = \sqrt{t} + 3 = t^{1/2} + 3 \Rightarrow du = \frac{1}{2} t^{-1/2} dt \Rightarrow 2du = \frac{1}{\sqrt{t}} dt$
 $\int \frac{1}{\sqrt{t}} \cos(\sqrt{t} + 3) dt = \int (\cos u)(2 du) = 2 \int \cos u du = 2 \sin u + C = 2 \sin(\sqrt{t} + 3) + C$
35. Let $u = \sin \frac{1}{\theta} \Rightarrow du = \left(\cos \frac{1}{\theta} \right) \left(-\frac{1}{\theta^2} \right) d\theta \Rightarrow -du = \frac{1}{\theta^2} \cos \frac{1}{\theta} d\theta$
 $\int \frac{1}{\theta^2} \sin \frac{1}{\theta} \cos \frac{1}{\theta} d\theta = \int -u du = -\frac{1}{2} u^2 + C = -\frac{1}{2} \sin^2 \frac{1}{\theta} + C$
36. Let $u = \csc \sqrt{\theta} \Rightarrow du = \left(-\csc \sqrt{\theta} \cot \sqrt{\theta} \right) \left(\frac{1}{2\sqrt{\theta}} \right) d\theta \Rightarrow -2du = \frac{1}{\sqrt{\theta}} \cot \sqrt{\theta} \csc \sqrt{\theta} d\theta$
 $\int \frac{\cos \sqrt{\theta}}{\sqrt{\theta} \sin^2 \sqrt{\theta}} d\theta = \int \frac{1}{\sqrt{\theta}} \cot \sqrt{\theta} \csc \sqrt{\theta} d\theta = \int -2 du = -2u + C = -2 \csc \sqrt{\theta} + C = -\frac{2}{\sin \sqrt{\theta}} + C$
37. Let $u = 1 + x \Rightarrow x = u - 1 \Rightarrow dx = du$
 $\int \frac{x}{\sqrt{1+x}} dx = \int \frac{u-1}{\sqrt{u}} du = \int \left(u^{1/2} - u^{-1/2} \right) du = \frac{2}{3} u^{3/2} - 2u^{1/2} + C = \frac{2}{3} (1+x)^{3/2} - 2(1+x)^{1/2} + C$
38. Let $u = 1 - \frac{1}{x} \Rightarrow du = \frac{1}{x^2} dx$
 $\int \sqrt{\frac{x-1}{x^5}} dx = \int \frac{1}{x^2} \sqrt{\frac{x-1}{x}} dx = \int \frac{1}{x^2} \sqrt{1 - \frac{1}{x}} dx = \int \sqrt{u} du = \int u^{1/2} du = \frac{2}{3} u^{3/2} + C = \frac{2}{3} \left(1 - \frac{1}{x} \right)^{3/2} + C$
39. Let $u = 2 - \frac{1}{x} \Rightarrow du = \frac{1}{x^2} dx$
 $\int \frac{1}{x^2} \sqrt{2 - \frac{1}{x}} dx = \int \sqrt{u} du = \int u^{1/2} du = \frac{2}{3} u^{3/2} + C = \frac{2}{3} \left(2 - \frac{1}{x} \right)^{3/2} + C$

40. Let $u = 1 - \frac{1}{x^2} \Rightarrow du = \frac{2}{x^3} dx \Rightarrow \frac{1}{2} du = \frac{1}{x^3} dx$

$$\int \frac{1}{x^3} \sqrt{\frac{x^2-1}{x^2}} dx = \int \frac{1}{x^3} \sqrt{1 - \frac{1}{x^2}} dx = \int \sqrt{u} \frac{1}{2} du = \frac{1}{2} \int u^{1/2} du = \frac{1}{3} u^{3/2} + C = \frac{1}{3} \left(1 - \frac{1}{x^2}\right)^{3/2} + C$$
41. Let $u = 1 - \frac{3}{x^3} \Rightarrow du = \frac{9}{x^4} dx \Rightarrow \frac{1}{9} du = \frac{1}{x^4} dx$

$$\int \sqrt{\frac{x^3-3}{x^{11}}} dx = \int \frac{1}{x^4} \sqrt{\frac{x^3-3}{x^3}} dx = \int \frac{1}{x^4} \sqrt{1 - \frac{3}{x^3}} dx = \int \sqrt{u} \frac{1}{9} du = \frac{1}{9} \int u^{1/2} du = \frac{2}{27} u^{3/2} + C = \frac{2}{27} \left(1 - \frac{3}{x^3}\right)^{3/2} + C$$
42. Let $u = x^3 - 1 \Rightarrow du = 3x^2 dx \Rightarrow \frac{1}{3} du = x^2 dx$

$$\int \sqrt{\frac{x^4}{x^3-1}} dx = \int \frac{x^2}{\sqrt{x^3-1}} dx = \int \frac{1}{\sqrt{u}} \frac{1}{3} du = \frac{1}{3} \int u^{-1/2} du = \frac{2}{3} u^{1/2} + C = \frac{2}{3} (x^3 - 1)^{1/2} + C$$
43. Let $u = x - 1$. Then $du = dx$ and $x = u + 1$. Thus $\int x(x-1)^{10} dx = \int (u+1)u^{10} du = \int (u^{11} + u^{10}) du$

$$= \frac{1}{12} u^{12} + \frac{1}{11} u^{11} + C = \frac{1}{12} (x-1)^{12} + \frac{1}{11} (x-1)^{11} + C$$
44. Let $u = 4 - x$. Then $du = -1 dx$ and $(-1)du = dx$ and $x = 4 - u$. Thus $\int x\sqrt{4-x} dx = \int (4-u)\sqrt{u}(-1) du$

$$= \int (4-u)(-u^{1/2}) du = \int (u^{3/2} - 4u^{1/2}) du = \frac{2}{5} u^{5/2} - \frac{8}{3} u^{3/2} + C = \frac{2}{5} (4-x)^{5/2} - \frac{8}{3} (4-x)^{3/2} + C$$
45. Let $u = 1 - x$. Then $du = -1 dx$ and $(-1)du = dx$ and $x = 1 - u$. Thus $\int (x+1)^2(1-x)^5 dx$

$$= \int (2-u)^2 u^5 (-1) du = \int (-u^7 + 4u^6 - 4u^5) du = -\frac{1}{8} u^8 + \frac{4}{7} u^7 - \frac{2}{3} u^6 + C = -\frac{1}{8} (1-x)^8 + \frac{4}{7} (1-x)^7 - \frac{2}{3} (1-x)^6 + C$$
46. Let $u = x - 5$. Then $du = dx$ and $x = u + 5$. Thus $\int (x+5)(x-5)^{1/3} dx = \int (u+10)u^{1/3} du = \int (u^{4/3} + 10u^{1/3}) du$

$$= \frac{3}{7} u^{7/3} + \frac{15}{2} u^{4/3} + C = \frac{3}{7} (x-5)^{7/3} + \frac{15}{2} (x-5)^{4/3} + C$$
47. Let $u = x^2 + 1$. Then $du = 2x dx$ and $\frac{1}{2} du = x dx$ and $x^2 = u - 1$. Thus $\int x^3 \sqrt{x^2 + 1} dx = \int (u-1) \frac{1}{2} \sqrt{u} du$

$$= \frac{1}{2} \int (u^{3/2} - u^{1/2}) du = \frac{1}{2} \left[\frac{2}{5} u^{5/2} - \frac{2}{3} u^{3/2} \right] + C = \frac{1}{5} u^{5/2} - \frac{1}{3} u^{3/2} + C = \frac{1}{5} (x^2 + 1)^{5/2} - \frac{1}{3} (x^2 + 1)^{3/2} + C$$
48. Let $u = x^3 + 1 \Rightarrow du = 3x^2 dx$ and $x^3 = u - 1$. So $\int 3x^5 \sqrt{x^3 + 1} dx = \int (u-1)\sqrt{u} du = \int (u^{3/2} - u^{1/2}) du$

$$= \frac{2}{5} u^{5/2} - \frac{2}{3} u^{3/2} + C = \frac{2}{5} (x^3 + 1)^{5/2} - \frac{2}{3} (x^3 + 1)^{3/2} + C$$
49. Let $u = x^2 - 4 \Rightarrow du = 2x dx$ and $\frac{1}{2} du = x dx$. Thus $\int \frac{x}{(x^2-4)^3} dx = \int (x^2-4)^{-3} x dx = \int u^{-3} \frac{1}{2} du = \frac{1}{2} \int u^{-3} du$

$$= -\frac{1}{4} u^{-2} + C = -\frac{1}{4} (x^2 - 4)^{-2} + C$$
50. Let $u = 2x - 1 \Rightarrow x = \frac{1}{2}(u+1) \Rightarrow dx = \frac{1}{2} du$. Thus $\int \frac{x}{(2x-1)^{2/3}} dx = \int \frac{\frac{1}{2}(u+1)}{u^{2/3}} \left(\frac{1}{2} du\right) = \frac{1}{4} \int (u^{1/3} + u^{-2/3}) du$

$$= \frac{1}{4} \left(\frac{3}{4} u^{4/3} + 3u^{1/3} \right) + C = \frac{3}{16} (2x-1)^{4/3} + \frac{3}{4} (2x-1)^{1/3} + C$$
51. Let $u = \sin x \Rightarrow du = \cos x dx$

$$\int (\cos x) e^{\sin x} dx = \int e^u du = e^u + C = e^{\sin x} + C$$
52. Let $u = \sin^2 \theta \Rightarrow du = 2 \sin \theta \cos \theta d\theta = \sin 2\theta d\theta$

$$\int (\sin 2\theta) e^{\sin^2 \theta} d\theta = \int e^u du = e^u + C = e^{\sin^2 \theta} + C$$

53. Let $u = e^{\sqrt{x}} + 1 \Rightarrow du = \frac{1}{2\sqrt{x}} e^{\sqrt{x}} dx \Rightarrow 2 du = \frac{1}{\sqrt{x}} e^{\sqrt{x}} dx = \frac{1}{\sqrt{x}e^{-\sqrt{x}}} dx$
 $\int \frac{1}{\sqrt{x}e^{-\sqrt{x}}} \sec^2(e^{\sqrt{x}} + 1) dx = 2 \int \sec^2 u du = 2 \tan u + C = 2 \tan(e^{\sqrt{x}} + 1) + C$
54. Let $u = 1 + e^{\frac{1}{x}} \Rightarrow du = e^{\frac{1}{x}} \cdot \frac{-1}{x^2} dx \Rightarrow -du = e^{\frac{1}{x}} \cdot \frac{1}{x^2} dx$
 $\int \frac{1}{x^2} e^{\frac{1}{x}} \sec\left(1 + e^{\frac{1}{x}}\right) \tan\left(1 + e^{\frac{1}{x}}\right) dx = -\int \sec u \tan u du = -\sec u + C = -\sec\left(1 + e^{\frac{1}{x}}\right) + C$
55. Let $u = \ln x \Rightarrow du = \frac{1}{x} dx$
 $\int \frac{1}{x \ln x} dx = \int \frac{1}{u} du = \ln|u| + C = \ln|\ln x| + C$
56. Let $u = \ln t \Rightarrow du = \frac{1}{t} dt$
 $\int \frac{\ln \sqrt{t}}{t} dt = \int \frac{\ln t^{1/2}}{t} dt = \frac{1}{2} \int \frac{\ln t}{t} dt = \frac{1}{2} \int u du = \frac{1}{2} \cdot \frac{u^2}{2} + C = \frac{1}{4} (\ln t)^2 + C$
57. Let $u = e^{-z} + 1 \Rightarrow du = -e^{-z} dz \Rightarrow -du = e^{-z} dz$
 $\int \frac{dz}{1+e^z} = \int \frac{1}{1+e^z} \cdot \frac{e^{-z}}{e^{-z}} dz = \int \frac{e^{-z}}{e^{-z}+1} dz = -\int \frac{1}{u} du = -\ln|u| + C = -\ln(e^{-z} + 1) + C = -\ln\left(\frac{1+e^z}{e^z}\right) + C$
 $= -(\ln(1+e^z) - \ln e^z) + C = z - \ln(1+e^z) + C$
58. Let $u = x^2 \Rightarrow du = 2x dx \Rightarrow \frac{1}{2} du = x dx$
 $\int \frac{dx}{x\sqrt{x^4-1}} = \int \frac{x dx}{x^2 \sqrt{(x^2)^2-1}} = \frac{1}{2} \int \frac{du}{u\sqrt{u^2-1}} = \frac{1}{2} \sec^{-1} u + C = \frac{1}{2} \sec^{-1}(x^2) + C$
59. Let $u = \frac{2}{3}r \Rightarrow du = \frac{2}{3} dr \Rightarrow \frac{3}{2} du = dr$
 $\int \frac{5}{9+4r^2} dr = \frac{5}{9} \int \frac{1}{1+(\frac{2}{3}r)^2} dr = \frac{5}{9} \int \frac{\frac{3}{2} du}{1+u^2} = \frac{5}{6} \tan^{-1} u + C = \frac{5}{6} \tan^{-1}\left(\frac{2}{3}r\right) + C$
60. Let $u = e^{\theta} \Rightarrow du = e^{\theta} d\theta$
 $\int \frac{1}{\sqrt{e^{2\theta}-1}} d\theta = \int \frac{e^{\theta} d\theta}{e^{\theta} \sqrt{(e^{\theta})^2-1}} = \int \frac{du}{u\sqrt{u^2-1}} = \sec^{-1} u + C = \sec^{-1}(e^{\theta}) + C$
61. $\int \frac{e^{\sin^{-1} x}}{\sqrt{1-x^2}} dx = \int e^u du$, where $u = \sin^{-1} x$ and $du = \frac{dx}{\sqrt{1-x^2}} = e^u + C = e^{\sin^{-1} x} + C$
62. $\int \frac{e^{\cos^{-1} x}}{\sqrt{1-x^2}} dx = -\int e^u du$, where $u = \cos^{-1} x$ and $du = \frac{-dx}{\sqrt{1-x^2}} = -e^u + C = -e^{\cos^{-1} x} + C$
63. $\int \frac{(\sin^{-1} x)^2}{\sqrt{1-x^2}} dx = \int u^2 du$, where $u = \sin^{-1} x$ and $du = \frac{dx}{\sqrt{1-x^2}} = \frac{u^3}{3} + C = \frac{(\sin^{-1} x)^3}{3} + C$

64. $\int \frac{\sqrt{\tan^{-1} x}}{1+x^2} dx = \int u^{1/2} du$, where $u = \tan^{-1} x$ and $du = \frac{dx}{1+x^2} = \frac{2}{3}u^{3/2} + C = \frac{2}{3}(\tan^{-1} x)^{3/2} + C = \frac{2}{3}\sqrt{(\tan^{-1} x)^3} + C$

65. $\int \frac{1}{(\tan^{-1} y)(1+y^2)} dy = \int \frac{\left(\frac{1}{1+y^2}\right)}{\tan^{-1} y} dy = \int \frac{1}{u} du$, where $u = \tan^{-1} y$ and $du = \frac{dy}{1+y^2} = \ln|u| + C = \ln|\tan^{-1} y| + C$

66. $\int \frac{1}{(\sin^{-1} y)\sqrt{1-y^2}} dy = \int \frac{\left(\frac{1}{\sqrt{1-y^2}}\right)}{\sin^{-1} y} dy = \int \frac{1}{u} du$, where $u = \sin^{-1} y$ and $du = \frac{dy}{\sqrt{1-y^2}} = \ln|u| + C = \ln|\sin^{-1} y| + C$

67. (a) Let $u = \tan x \Rightarrow du = \sec^2 x dx$; $v = u^3 \Rightarrow dv = 3u^2 du \Rightarrow 6dv = 18u^2 du$; $w = 2 + v \Rightarrow dw = dv$
 $\int \frac{18 \tan^2 x \sec^2 x}{(2 + \tan^3 x)^2} dx = \int \frac{18u^2}{(2+u^3)^2} du = \int \frac{6dv}{(2+v)^2} = \int \frac{6dw}{w^2} = 6 \int w^{-2} dw = -6w^{-1} + C = -\frac{6}{2+v} + C$
 $= -\frac{6}{2+u^3} + C = -\frac{6}{2+\tan^3 x} + C$

(b) Let $u = \tan^3 x \Rightarrow du = 3 \tan^2 x \sec^2 x dx \Rightarrow 6 du = 18 \tan^2 x \sec^2 x dx$; $v = 2 + u \Rightarrow dv = du$
 $\int \frac{18 \tan^2 x \sec^2 x}{(2 + \tan^3 x)^2} dx = \int \frac{6 du}{(2+u)^2} = \int \frac{6 dv}{v^2} = -\frac{6}{v} + C = -\frac{6}{2+u} + C = -\frac{6}{2+\tan^3 x} + C$

(c) Let $u = 2 + \tan^3 x \Rightarrow du = 3 \tan^2 x \sec^2 x dx \Rightarrow 6 du = 18 \tan^2 x \sec^2 x dx$
 $\int \frac{18 \tan^2 x \sec^2 x}{(2 + \tan^3 x)^2} dx = \int \frac{6 du}{u^2} = -\frac{6}{u} + C = -\frac{6}{2+\tan^3 x} + C$

68. (a) Let $u = x - 1 \Rightarrow du = dx$; $v = \sin u \Rightarrow dv = \cos u du$; $w = 1 + v^2 \Rightarrow dw = 2v dv \Rightarrow \frac{1}{2} dw = v dv$
 $\int \sqrt{1 + \sin^2(x-1)} \sin(x-1) \cos(x-1) dx = \int \sqrt{1 + \sin^2 u} \sin u \cos u du = \int v \sqrt{1 + v^2} dv$
 $= \int \frac{1}{2} \sqrt{w} dw = \frac{1}{3} w^{3/2} + C = \frac{1}{3} (1 + v^2)^{3/2} + C = \frac{1}{3} (1 + \sin^2 u)^{3/2} + C = \frac{1}{3} (1 + \sin^2(x-1))^{3/2} + C$

(b) Let $u = \sin(x-1) \Rightarrow du = \cos(x-1) dx$; $v = 1 + u^2 \Rightarrow dv = 2u du \Rightarrow \frac{1}{2} dv = u du$
 $\int \sqrt{1 + \sin^2(x-1)} \sin(x-1) \cos(x-1) dx = \int u \sqrt{1 + u^2} du = \int \frac{1}{2} \sqrt{v} dv = \int \frac{1}{2} v^{1/2} dv$
 $= \left(\frac{1}{2} \left(\frac{2}{3}\right) v^{3/2}\right) + C = \frac{1}{3} v^{3/2} + C = \frac{1}{3} (1 + u^2)^{3/2} + C = \frac{1}{3} (1 + \sin^2(x-1))^{3/2} + C$

(c) Let $u = 1 + \sin^2(x-1) \Rightarrow du = 2 \sin(x-1) \cos(x-1) dx \Rightarrow \frac{1}{2} du = \sin(x-1) \cos(x-1) dx$
 $\int \sqrt{1 + \sin^2(x-1)} \sin(x-1) \cos(x-1) dx = \int \frac{1}{2} \sqrt{u} du = \int \frac{1}{2} u^{1/2} du = \frac{1}{2} \left(\frac{2}{3} u^{3/2}\right) + C = \frac{1}{3} (1 + \sin^2(x-1))^{3/2} + C$

69. Let $u = 3(2r-1)^2 + 6 \Rightarrow du = 6(2r-1)(2) dr \Rightarrow \frac{1}{12} du = (2r-1)dr$; $v = \sqrt{u} \Rightarrow dv = \frac{1}{2\sqrt{u}} du \Rightarrow \frac{1}{6} dv = \frac{1}{12\sqrt{u}} du$
 $\int \frac{(2r-1) \cos \sqrt{3(2r-1)^2 + 6}}{\sqrt{3(2r-1)^2 + 6}} dr = \int \left(\frac{\cos \sqrt{u}}{\sqrt{u}}\right) \left(\frac{1}{12} du\right) = \int (\cos v) \left(\frac{1}{6} dv\right) = \frac{1}{6} \sin v + C = \frac{1}{6} \sin \sqrt{u} + C$
 $= \frac{1}{6} \sin \sqrt{3(2r-1)^2 + 6} + C$

70. Let $u = \cos \sqrt{\theta} \Rightarrow du = (-\sin \sqrt{\theta}) \left(\frac{1}{2\sqrt{\theta}}\right) d\theta \Rightarrow -2du = \frac{\sin \sqrt{\theta}}{\sqrt{\theta}} d\theta$
 $\int \frac{\sin \sqrt{\theta}}{\sqrt{\theta} \cos^3 \sqrt{\theta}} d\theta = \int \frac{\sin \sqrt{\theta}}{\sqrt{\theta} \sqrt{\cos^3 \sqrt{\theta}}} d\theta = \int \frac{-2du}{u^{3/2}} = -2 \int u^{-3/2} du = -2(-2u^{-1/2}) + C = \frac{4}{\sqrt{u}} + C = \frac{4}{\sqrt{\cos \sqrt{\theta}}} + C$

71. Let $u = \sin x \Rightarrow du = \cos x dx$.
 $\int \cot x = \int \frac{\cos x}{\sin x} dx = \int \frac{du}{u} = \ln|u| + C = \ln|\sin x| + C$

72. $\int \csc x \, dx = \int \csc x(1) \, dx = \int \csc x \left(\frac{\csc x + \cot x}{\csc x + \cot x} \right) dx$. Let $u = \csc x + \cot x \Rightarrow du = -(\csc^2 x + \csc x \cot x) \, dx$.

$$\int \csc x \, dx = -\int \frac{du}{u} = -\ln|u| + C = -\ln|\csc x + \cot x| + C$$

73. Let $u = 3t^2 - 1 \Rightarrow du = 6t \, dt \Rightarrow 2du = 12t \, dt$

$$s = \int 12t(3t^2 - 1)^3 \, dt = \int u^3 (2du) = 2 \left(\frac{1}{4} u^4 \right) + C = \frac{1}{2} u^4 + C = \frac{1}{2} (3t^2 - 1)^4 + C;$$

$$s = 3 \text{ when } t = 1 \Rightarrow 3 = \frac{1}{2} (3 - 1)^4 + C \Rightarrow 3 = 8 + C \Rightarrow C = -5 \Rightarrow s = \frac{1}{2} (3t^2 - 1)^4 - 5$$

74. Let $u = x^2 + 8 \Rightarrow du = 2x \, dx \Rightarrow 2du = 4x \, dx$

$$y = \int 4x(x^2 + 8)^{-1/3} \, dx = \int u^{-1/3} (2du) = 2 \left(\frac{3}{2} u^{2/3} \right) + C = 3u^{2/3} + C = 3(x^2 + 8)^{2/3} + C;$$

$$y = 0 \text{ when } x = 0 \Rightarrow 0 = 3(8)^{2/3} + C \Rightarrow C = -12 \Rightarrow y = 3(x^2 + 8)^{2/3} - 12$$

75. Let $u = t + \frac{\pi}{12} \Rightarrow du = dt$

$$s = \int 8 \sin^2 \left(t + \frac{\pi}{12} \right) dt = \int 8 \sin^2 u \, du = 8 \left(\frac{u}{2} - \frac{1}{4} \sin 2u \right) + C = 4 \left(t + \frac{\pi}{12} \right) - 2 \sin \left(2t + \frac{\pi}{6} \right) + C;$$

$$s = 8 \text{ when } t = 0 \Rightarrow 8 = 4 \left(\frac{\pi}{12} \right) - 2 \sin \left(\frac{\pi}{6} \right) + C \Rightarrow C = 8 - \frac{\pi}{3} + 1 = 9 - \frac{\pi}{3}$$

$$\Rightarrow s = 4 \left(t + \frac{\pi}{12} \right) - 2 \sin \left(2t + \frac{\pi}{6} \right) + 9 - \frac{\pi}{3} = 4t - 2 \sin \left(2t + \frac{\pi}{6} \right) + 9$$

76. Let $u = \frac{\pi}{4} - \theta \Rightarrow -du = d\theta$

$$r = \int 3 \cos^2 \left(\frac{\pi}{4} - \theta \right) d\theta = -\int 3 \cos^2 u \, du = -3 \left(\frac{u}{2} + \frac{1}{4} \sin 2u \right) + C = -\frac{3}{2} \left(\frac{\pi}{4} - \theta \right) - \frac{3}{4} \sin \left(\frac{\pi}{2} - 2\theta \right) + C;$$

$$r = \frac{\pi}{8} \text{ when } \theta = 0 \Rightarrow \frac{\pi}{8} = -\frac{3\pi}{8} - \frac{3}{4} \sin \frac{\pi}{2} + C \Rightarrow C = \frac{\pi}{2} + \frac{3}{4} \Rightarrow r = -\frac{3}{2} \left(\frac{\pi}{4} - \theta \right) - \frac{3}{4} \sin \left(\frac{\pi}{2} - 2\theta \right) + \frac{\pi}{2} + \frac{3}{4}$$

$$\Rightarrow r = \frac{3}{2} \theta - \frac{3}{4} \sin \left(\frac{\pi}{2} - 2\theta \right) + \frac{\pi}{8} + \frac{3}{4} \Rightarrow r = \frac{3}{2} \theta - \frac{3}{4} \cos 2\theta + \frac{\pi}{8} + \frac{3}{4}$$

77. Let $u = 2t - \frac{\pi}{2} \Rightarrow du = 2 \, dt \Rightarrow -2 \, du = -4 \, dt$

$$\frac{ds}{dt} = \int -4 \sin \left(2t - \frac{\pi}{2} \right) dt = \int (\sin u)(-2 \, du) = 2 \cos u + C_1 = 2 \cos \left(2t - \frac{\pi}{2} \right) + C_1;$$

$$\text{at } t = 0 \text{ and } \frac{ds}{dt} = 100 \text{ we have } 100 = 2 \cos \left(-\frac{\pi}{2} \right) + C_1 \Rightarrow C_1 = 100 \Rightarrow \frac{ds}{dt} = 2 \cos \left(2t - \frac{\pi}{2} \right) + 100$$

$$\Rightarrow s = \int \left(2 \cos \left(2t - \frac{\pi}{2} \right) + 100 \right) dt = \int (\cos u + 50) \, du = \sin u + 50u + C_2 = \sin \left(2t - \frac{\pi}{2} \right) + 50 \left(2t - \frac{\pi}{2} \right) + C_2;$$

$$\text{at } t = 0 \text{ and } s = 0 \text{ we have } 0 = \sin \left(-\frac{\pi}{2} \right) + 50 \left(-\frac{\pi}{2} \right) + C_2 \Rightarrow C_2 = 1 + 25\pi$$

$$\Rightarrow s = \sin \left(2t - \frac{\pi}{2} \right) + 100t - 25\pi + (1 + 25\pi) \Rightarrow s = \sin \left(2t - \frac{\pi}{2} \right) + 100t + 1$$

78. Let $u = \tan 2x \Rightarrow du = 2 \sec^2 2x \, dx \Rightarrow 2du = 4 \sec^2 2x \, dx$; $v = 2x \Rightarrow dv = 2 \, dx \Rightarrow \frac{1}{2} dv = dx$

$$\frac{dy}{dx} = \int 4 \sec^2 2x \tan 2x \, dx = \int u(2 \, du) = u^2 + C_1 = \tan^2 2x + C_1;$$

$$\text{at } x = 0 \text{ and } \frac{dy}{dx} = 4 \text{ we have } 4 = 0 + C_1 \Rightarrow C_1 = 4 \Rightarrow \frac{dy}{dx} = \tan^2 2x + 4 = (\sec^2 2x - 1) + 4 = \sec^2 2x + 3$$

$$\Rightarrow y = \int (\sec^2 2x + 3) \, dx = \int (\sec^2 v + 3) \left(\frac{1}{2} dv \right) = \frac{1}{2} \tan v + \frac{3}{2} v + C_2 = \frac{1}{2} \tan 2x + 3x + C_2;$$

$$\text{at } x = 0 \text{ and } y = -1 \text{ we have } -1 = \frac{1}{2} (0) + 0 + C_2 \Rightarrow C_2 = -1 \Rightarrow y = \frac{1}{2} \tan 2x + 3x - 1$$

79. Let $u = 2t \Rightarrow du = 2 \, dt \Rightarrow 3 \, du = 6 \, dt$

$$s = \int 6 \sin 2t \, dt = \int (\sin u)(3 \, du) = -3 \cos u + C = -3 \cos 2t + C;$$

$$\text{at } t = 0 \text{ and } s = 0 \text{ we have } 0 = -3 \cos 0 + C \Rightarrow C = 3 \Rightarrow s = 3 - 3 \cos 2t \Rightarrow s \left(\frac{\pi}{2} \right) = 3 - 3 \cos(\pi) = 6 \, m$$

80. Let $u = \pi t \Rightarrow du = \pi dt \Rightarrow \pi du = \pi^2 dt$
 $v = \int \pi^2 \cos \pi t dt = \int (\cos u)(\pi du) = \pi \sin u + C_1 = \pi \sin(\pi t) + C_1$;
 at $t = 0$ and $v = 8$ we have $8 = \pi(0) + C_1 \Rightarrow C_1 = 8 \Rightarrow v = \frac{ds}{dt} = \pi \sin(\pi t) + 8 \Rightarrow s = \int (\pi \sin(\pi t) + 8) dt$
 $= \int \sin u du + 8t + C_2 = -\cos(\pi t) + 8t + C_2$; at $t = 0$ and $s = 0$ we have $0 = -1 + C_2 \Rightarrow C_2 = 1$
 $\Rightarrow s = 8t - \cos(\pi t) + 1 \Rightarrow s(1) = 8 - \cos \pi + 1 = 10 m$
81. All three integrations are correct. In each case, the derivative of the function on the right is the integrand on the left, and each formula has an arbitrary constant for generating the remaining antiderivatives. Moreover,
 $\sin^2 x + C_1 = 1 - \cos^2 x + C_1 \Rightarrow C_2 = 1 + C_1$; also $-\cos^2 x + C_2 = -\frac{\cos 2x}{2} - \frac{1}{2} + C_2 \Rightarrow C_3 = C_2 - \frac{1}{2} = C_1 + \frac{1}{2}$.

82. (a) $\left(\frac{1}{60-0}\right) \int_0^{1/60} V_{\max} \sin 120\pi t dt = 60 \left[-V_{\max} \left(\frac{1}{120\pi}\right) \cos(120\pi t)\right]_0^{1/60} = -\frac{V_{\max}}{2\pi} [\cos 2\pi - \cos 0]$
 $= -\frac{V_{\max}}{2\pi} [1 - 1] = 0$

(b) $V_{\max} = \sqrt{2}V_{\text{rms}} = \sqrt{2}(240) \approx 339$ volts

(c) $\int_0^{1/60} (V_{\max})^2 \sin^2 120\pi t dt = (V_{\max})^2 \int_0^{1/60} \left(\frac{1 - \cos 240\pi t}{2}\right) dt = \frac{(V_{\max})^2}{2} \int_0^{1/60} (1 - \cos 240\pi t) dt$
 $= \frac{(V_{\max})^2}{2} \left[t - \left(\frac{1}{240\pi}\right) \sin 240\pi t\right]_0^{1/60} = \frac{(V_{\max})^2}{2} \left[\left(\frac{1}{60} - \left(\frac{1}{240\pi}\right) \sin(4\pi)\right) - \left(0 - \left(\frac{1}{240\pi}\right) \sin(0)\right)\right] = \frac{(V_{\max})^2}{120}$

5.6 SUBSTITUTION AND AREA BETWEEN CURVES

1. (a) Let $u = y + 1 \Rightarrow du = dy$; $y = 0 \Rightarrow u = 1$, $y = 3 \Rightarrow u = 4$
 $\int_0^3 \sqrt{y+1} dy = \int_1^4 u^{1/2} du = \left[\frac{2}{3} u^{3/2}\right]_1^4 = \left(\frac{2}{3}\right)(4)^{3/2} - \left(\frac{2}{3}\right)(1)^{3/2} = \left(\frac{2}{3}\right)(8) - \left(\frac{2}{3}\right)(1) = \frac{14}{3}$
- (b) Use the same substitution for u as in part (a); $y = -1 \Rightarrow u = 0$, $y = 0 \Rightarrow u = 1$
 $\int_{-1}^0 \sqrt{y+1} dy = \int_0^1 u^{1/2} du = \left[\frac{2}{3} u^{3/2}\right]_0^1 = \left(\frac{2}{3}\right)(1)^{3/2} - 0 = \frac{2}{3}$
2. (a) Let $u = 1 - r^2 \Rightarrow du = -2r dr \Rightarrow -\frac{1}{2} du = r dr$; $r = 0 \Rightarrow u = 1$, $r = 1 \Rightarrow u = 0$
 $\int_0^1 r\sqrt{1-r^2} dr = \int_1^0 -\frac{1}{2}\sqrt{u} du = \left[-\frac{1}{3} u^{3/2}\right]_1^0 = 0 - \left(-\frac{1}{3}\right)(1)^{3/2} = \frac{1}{3}$
- (b) Use the same substitution for u as in part (a); $r = -1 \Rightarrow u = 0$, $r = 1 \Rightarrow u = 0$
 $\int_{-1}^1 r\sqrt{1-r^2} dr = \int_0^0 -\frac{1}{2}\sqrt{u} du = 0$
3. (a) Let $u = \tan x \Rightarrow du = \sec^2 x dx$; $x = 0 \Rightarrow u = 0$, $x = \frac{\pi}{4} \Rightarrow u = 1$
 $\int_0^{\pi/4} \tan x \sec^2 x dx = \int_0^1 u du = \left[\frac{u^2}{2}\right]_0^1 = \frac{1^2}{2} - 0 = \frac{1}{2}$
- (b) Use the same substitution as in part (a); $x = -\frac{\pi}{4} \Rightarrow u = -1$, $x = 0 \Rightarrow u = 0$
 $\int_{-\pi/4}^0 \tan x \sec^2 x dx = \int_{-1}^0 u du = \left[\frac{u^2}{2}\right]_{-1}^0 = 0 - \frac{1}{2} = -\frac{1}{2}$
4. (a) Let $u = \cos x \Rightarrow du = -\sin x dx \Rightarrow -du = \sin x dx$; $x = 0 \Rightarrow u = 1$, $x = \pi \Rightarrow u = -1$
 $\int_0^\pi 3 \cos^2 x \sin x dx = \int_1^{-1} -3u^2 du = \left[-u^3\right]_1^{-1} = -(-1)^3 - (-1)^3 = 2$

- (b) Use the same substitution as in part (a);
- $x=2\pi \Rightarrow u=1$
- ,
- $x=3\pi \Rightarrow u=-1$

$$\int_{2\pi}^{3\pi} 3 \cos^2 x \sin x \, dx = \int_1^{-1} -3u^2 \, du = 2$$

5. (a)
- $u = 1+t^4 \Rightarrow du = 4t^3 dt \Rightarrow \frac{1}{4} du = t^3 dt$
- ;
- $t=0 \Rightarrow u=1$
- ,
- $t=1 \Rightarrow u=2$

$$\int_0^1 t^3 (1+t^4)^3 \, dt = \int_1^2 \frac{1}{4} u^3 \, du = \left[\frac{u^4}{16} \right]_1^2 = \frac{2^4}{16} - \frac{1^4}{16} = \frac{15}{16}$$

- (b) Use the same substitution as in part (a);
- $t=-1 \Rightarrow u=2$
- ,
- $t=1 \Rightarrow u=2$

$$\int_{-1}^1 t^3 (1+t^4)^3 \, dt = \int_2^2 \frac{1}{4} u^3 \, du = 0$$

6. (a) Let
- $u = t^2 + 1 \Rightarrow du = 2t \, dt \Rightarrow \frac{1}{2} du = t \, dt$
- ;
- $t=0 \Rightarrow u=1$
- ,
- $t=\sqrt{7} \Rightarrow u=8$

$$\int_0^{\sqrt{7}} t(t^2+1)^{1/3} \, dt = \int_1^8 \frac{1}{2} u^{1/3} \, du = \left[\left(\frac{1}{2} \right) \left(\frac{3}{4} \right) u^{4/3} \right]_1^8 = \left(\frac{3}{8} \right) (8)^{4/3} - \left(\frac{3}{8} \right) (1)^{4/3} = \frac{45}{8}$$

- (b) Use the same substitution as in part (a);
- $t=-\sqrt{7} \Rightarrow u=8$
- ,
- $t=0 \Rightarrow u=1$

$$\int_{-\sqrt{7}}^0 t(t^2+1)^{1/3} \, dt = \int_8^1 \frac{1}{2} u^{1/3} \, du = -\int_1^8 \frac{1}{2} u^{1/3} \, du = -\frac{45}{8}$$

7. (a) Let
- $u = 4+r^2 \Rightarrow du = 2r \, dr \Rightarrow \frac{1}{2} du = r \, dr$
- ;
- $r=-1 \Rightarrow u=5$
- ,
- $r=1 \Rightarrow u=5$

$$\int_{-1}^1 \frac{5r}{(4+r^2)^2} \, dr = 5 \int_5^5 \frac{1}{2} u^{-2} \, du = 0$$

- (b) Use the same substitution as in part (a);
- $r=0 \Rightarrow u=4$
- ,
- $r=1 \Rightarrow u=5$

$$\int_0^1 \frac{5r}{(4+r^2)^2} \, dr = 5 \int_4^5 \frac{1}{2} u^{-2} \, du = 5 \left[-\frac{1}{2} u^{-1} \right]_4^5 = 5 \left(-\frac{1}{2} (5)^{-1} \right) - 5 \left(-\frac{1}{2} (4)^{-1} \right) = \frac{1}{8}$$

8. (a) Let
- $u = 1+v^{3/2} \Rightarrow du = \frac{3}{2} v^{1/2} \, dv \Rightarrow \frac{20}{3} du = 10\sqrt{v} \, dv$
- ;
- $v=0 \Rightarrow u=1$
- ,
- $v=1 \Rightarrow u=2$

$$\int_0^1 \frac{10\sqrt{v}}{(1+v^{3/2})^2} \, dv = \int_1^2 \frac{1}{u^2} \left(\frac{20}{3} du \right) = \frac{20}{3} \int_1^2 u^{-2} \, du = -\frac{20}{3} \left[\frac{1}{u} \right]_1^2 = -\frac{20}{3} \left[\frac{1}{2} - 1 \right] = \frac{10}{3}$$

- (b) Use the same substitution as in part (a);
- $v=1 \Rightarrow u=2$
- ,
- $v=4 \Rightarrow u=1+4^{3/2}=9$

$$\int_1^4 \frac{10\sqrt{v}}{(1+v^{3/2})^2} \, dv = \int_2^9 \frac{1}{u^2} \left(\frac{20}{3} du \right) = -\frac{20}{3} \left[\frac{1}{u} \right]_2^9 = -\frac{20}{3} \left(\frac{1}{9} - \frac{1}{2} \right) = -\frac{20}{3} \left(-\frac{7}{18} \right) = \frac{70}{27}$$

9. (a) Let
- $u = x^2 + 1 \Rightarrow du = 2x \, dx \Rightarrow 2 \, du = 4x \, dx$
- ;
- $x=0 \Rightarrow u=1$
- ,
- $x=\sqrt{3} \Rightarrow u=4$

$$\int_0^{\sqrt{3}} \frac{4x}{\sqrt{x^2+1}} \, dx = \int_1^4 \frac{2}{\sqrt{u}} \, du = \int_1^4 2u^{-1/2} \, du = [4u^{1/2}]_1^4 = 4(4)^{1/2} - 4(1)^{1/2} = 4$$

- (b) Use the same substitution as in part (a);
- $x=-\sqrt{3} \Rightarrow u=4$
- ,
- $x=\sqrt{3} \Rightarrow u=4$

$$\int_{-\sqrt{3}}^{\sqrt{3}} \frac{4x}{\sqrt{x^2+1}} \, dx = \int_4^4 \frac{2}{\sqrt{u}} \, du = 0$$

10. (a) Let
- $u = x^4 + 9 \Rightarrow du = 4x^3 \, dx \Rightarrow \frac{1}{4} du = x^3 \, dx$
- ;
- $x=0 \Rightarrow u=9$
- ,
- $x=1 \Rightarrow u=10$

$$\int_0^1 \frac{x^3}{\sqrt{x^4+9}} \, dx = \int_9^{10} \frac{1}{4} u^{-1/2} \, du = \left[\frac{1}{4} (2) u^{1/2} \right]_9^{10} = \frac{1}{2} (10)^{1/2} - \frac{1}{2} (9)^{1/2} = \frac{\sqrt{10}-3}{2}$$

- (b) Use the same substitution as in part (a);
- $x=-1 \Rightarrow u=10$
- ,
- $x=0 \Rightarrow u=9$

$$\int_{-1}^0 \frac{x^3}{\sqrt{x^4+9}} \, dx = \int_{10}^9 \frac{1}{4} u^{-1/2} \, du = -\int_9^{10} \frac{1}{4} u^{-1/2} \, du = -\frac{3-\sqrt{10}}{2}$$

11. (a) Let $u = 4 + 5t \Rightarrow t = \frac{1}{5}(u - 4)$, $dt = \frac{1}{5}du$; $t = 0 \Rightarrow u = 4$, $t = 1 \Rightarrow u = 9$.

$$\begin{aligned} \int_0^1 t\sqrt{4+5t} dt &= \frac{1}{25} \int_4^9 (u-4)\sqrt{u} du = \frac{1}{25} \int_4^9 (u^{3/2} - 4u^{1/2}) du \\ &= \frac{1}{25} \left[\frac{2}{5}u^{5/2} - \frac{8}{3}u^{3/2} \right]_4^9 = \frac{1}{25} \left(\left(\frac{2}{5}(243) - \frac{8}{3}(27) \right) - \left(\frac{2}{5}(32) - \frac{8}{3}(8) \right) \right) = \frac{506}{375} \end{aligned}$$

- (b) Use the same substitution as in (a); $t = 1 \Rightarrow u = 9$, $t = 9 \Rightarrow u = 49$.

$$\begin{aligned} \int_1^9 t\sqrt{4+5t} dt &= \frac{1}{25} \int_9^{49} (u^{3/2} - 4u^{1/2}) du = \frac{1}{25} \left[\frac{2}{5}u^{5/2} - \frac{8}{3}u^{3/2} \right]_9^{49} \\ &= \frac{1}{25} \left(\left(\frac{2}{5}(16,807) - \frac{8}{3}(343) \right) - \left(\frac{2}{5}(243) - \frac{8}{3}(27) \right) \right) = \frac{86,744}{375} \end{aligned}$$

12. (a) Let $u = 1 - \cos 3t \Rightarrow du = 3 \sin 3t dt \Rightarrow \frac{1}{3} du = \sin 3t dt$; $t = 0 \Rightarrow u = 0$, $t = \frac{\pi}{6} \Rightarrow u = 1 - \cos \frac{\pi}{2} = 1$

$$\int_0^{\pi/6} (1 - \cos 3t) \sin 3t dt = \int_0^1 \frac{1}{3} u du = \left[\frac{1}{3} \left(\frac{u^2}{2} \right) \right]_0^1 = \frac{1}{6}(1)^2 - \frac{1}{6}(0)^2 = \frac{1}{6}$$

- (b) Use the same substitution as in part (a); $t = \frac{\pi}{6} \Rightarrow u = 1$, $t = \frac{\pi}{3} \Rightarrow u = 1 - \cos \pi = 2$

$$\int_{\pi/6}^{\pi/3} (1 - \cos 3t) \sin 3t dt = \int_1^2 \frac{1}{3} u du = \left[\frac{1}{3} \left(\frac{u^2}{2} \right) \right]_1^2 = \frac{1}{6}(2)^2 - \frac{1}{6}(1)^2 = \frac{1}{2}$$

13. (a) Let $u = 4 + 3 \sin z \Rightarrow du = 3 \cos z dz \Rightarrow \frac{1}{3} du = \cos z dz$; $z = 0 \Rightarrow u = 4$, $z = 2\pi \Rightarrow u = 4$

$$\int_0^{2\pi} \frac{\cos z}{\sqrt{4+3\sin z}} dz = \int_4^4 \frac{1}{\sqrt{u}} \left(\frac{1}{3} du \right) = 0$$

- (b) Use the same substitution as in part (a); $z = -\pi \Rightarrow u = 4 + 3 \sin(-\pi) = 4$, $z = \pi \Rightarrow u = 4$

$$\int_{-\pi}^{\pi} \frac{\cos z}{\sqrt{4+3\sin z}} dz = \int_4^4 \frac{1}{\sqrt{u}} \left(\frac{1}{3} du \right) = 0$$

14. (a) Let $u = 2 + \tan \frac{t}{2} \Rightarrow du = \frac{1}{2} \sec^2 \frac{t}{2} dt \Rightarrow 2 du = \sec^2 \frac{t}{2} dt$; $t = \frac{-\pi}{2} \Rightarrow u = 2 + \tan \left(\frac{-\pi}{4} \right) = 1$, $t = 0 \Rightarrow u = 2$

$$\int_{-\pi/2}^0 \left(2 + \tan \frac{t}{2} \right) \sec^2 \frac{t}{2} dt = \int_1^2 u(2 du) = [u^2]_1^2 = 2^2 - 1^2 = 3$$

- (b) Use the same substitution as in part (a); $t = \frac{-\pi}{2} \Rightarrow u = 1$, $t = \frac{\pi}{2} \Rightarrow u = 3$

$$\int_{-\pi/2}^{\pi/2} \left(2 + \tan \frac{t}{2} \right) \sec^2 \frac{t}{2} dt = 2 \int_1^3 u du = [u^2]_1^3 = 3^2 - 1^2 = 8$$

15. Let $u = t^5 + 2t \Rightarrow du = (5t^4 + 2) dt$; $t = 0 \Rightarrow u = 0$, $t = 1 \Rightarrow u = 3$

$$\int_0^1 \sqrt{t^5 + 2t} (5t^4 + 2) dt = \int_0^3 u^{1/2} du = \left[\frac{2}{3} u^{3/2} \right]_0^3 = \frac{2}{3}(3)^{3/2} - \frac{2}{3}(0)^{3/2} = 2\sqrt{3}$$

16. Let $u = 1 + \sqrt{y} \Rightarrow du = \frac{dy}{2\sqrt{y}}$; $y = 1 \Rightarrow u = 2$, $y = 4 \Rightarrow u = 3$

$$\int_1^4 \frac{dy}{2\sqrt{y}(1+\sqrt{y})^2} = \int_2^3 \frac{1}{u^2} du = \int_2^3 u^{-2} du = [-u^{-1}]_2^3 = \left(-\frac{1}{3} \right) - \left(-\frac{1}{2} \right) = \frac{1}{6}$$

17. Let $u = \cos 2\theta \Rightarrow du = -2 \sin 2\theta d\theta \Rightarrow -\frac{1}{2} du = \sin 2\theta d\theta$; $\theta = 0 \Rightarrow u = 1$, $\theta = \frac{\pi}{6} \Rightarrow u = \cos 2\left(\frac{\pi}{6}\right) = \frac{1}{2}$

$$\int_0^{\pi/6} \cos^{-3} 2\theta \sin 2\theta d\theta = \int_1^{1/2} u^{-3} \left(-\frac{1}{2} du\right) = -\frac{1}{2} \int_1^{1/2} u^{-3} du = \left[-\frac{1}{2} \left(\frac{u^{-2}}{-2}\right)\right]_1^{1/2} = \frac{1}{4\left(\frac{1}{2}\right)^2} - \frac{1}{4(1)^2} = \frac{3}{4}$$

18. Let $u = \tan\left(\frac{\theta}{6}\right) \Rightarrow du = \frac{1}{6} \sec^2\left(\frac{\theta}{6}\right) d\theta \Rightarrow 6 du = \sec^2\left(\frac{\theta}{6}\right) d\theta$; $\theta = \pi \Rightarrow u = \tan\left(\frac{\pi}{6}\right) = \frac{1}{\sqrt{3}}$, $\theta = \frac{3\pi}{2} \Rightarrow u = \tan\frac{\pi}{4} = 1$

$$\int_{\pi}^{3\pi/2} \cot^5\left(\frac{\theta}{6}\right) \sec^2\left(\frac{\theta}{6}\right) d\theta = \int_{1/\sqrt{3}}^1 u^{-5} (6 du) = \left[6\left(\frac{u^{-4}}{-4}\right)\right]_{1/\sqrt{3}}^1 = \left[-\frac{3}{2u^4}\right]_{1/\sqrt{3}}^1 = -\frac{3}{2(1)^4} - \left(-\frac{3}{2\left(\frac{1}{\sqrt{3}}\right)^4}\right) = 12$$

19. Let $u = 5 - 4 \cos t \Rightarrow du = 4 \sin t dt \Rightarrow \frac{1}{4} du = \sin t dt$; $t = 0 \Rightarrow u = 5 - 4 \cos 0 = 1$, $t = \pi \Rightarrow u = 5 - 4 \cos \pi = 9$

$$\int_0^{\pi} 5(5 - 4 \cos t)^{1/4} \sin t dt = \int_1^9 5u^{1/4} \left(\frac{1}{4} du\right) = \frac{5}{4} \int_1^9 u^{1/4} du = \left[\frac{5}{4} \left(\frac{4}{5} u^{5/4}\right)\right]_1^9 = 9^{5/4} - 1 = 3^{5/2} - 1$$

20. Let $u = 1 - \sin 2t \Rightarrow du = -2 \cos 2t dt \Rightarrow -\frac{1}{2} du = \cos 2t dt$; $t = 0 \Rightarrow u = 1$, $t = \frac{\pi}{4} \Rightarrow u = 0$

$$\int_0^{\pi/4} (1 - \sin 2t)^{3/2} \cos 2t dt = \int_1^0 -\frac{1}{2} u^{3/2} du = \left[-\frac{1}{2} \left(\frac{2}{5} u^{5/2}\right)\right]_1^0 = \left(-\frac{1}{5}(0)^{5/2}\right) - \left(-\frac{1}{5}(1)^{5/2}\right) = \frac{1}{5}$$

21. Let $u = 4y - y^2 + 4y^3 + 1 \Rightarrow du = (4 - 2y + 12y^2) dy$; $y = 0 \Rightarrow u = 1$, $y = 1 \Rightarrow u = 4(1) - (1)^2 + 4(1)^3 + 1 = 8$

$$\int_0^1 (4y - y^2 + 4y^3 + 1)^{-2/3} (12y^2 - 2y + 4) dy = \int_1^8 u^{-2/3} du = [3u^{1/3}]_1^8 = 3(8)^{1/3} - 3(1)^{1/3} = 3$$

22. Let $u = y^3 + 6y^2 - 12y + 9 \Rightarrow du = (3y^2 + 12y - 12) dy \Rightarrow \frac{1}{3} du = (y^2 + 4y - 4) dy$; $y = 0 \Rightarrow u = 9$, $y = 1 \Rightarrow u = 4$

$$\int_0^1 (y^3 + 6y^2 - 12y + 9)^{-1/2} (y^2 + 4y - 4) dy = \int_9^4 \frac{1}{3} u^{-1/2} du = \left[\frac{1}{3} (2u^{1/2})\right]_9^4 = \frac{2}{3}(4)^{1/2} - \frac{2}{3}(9)^{1/2} = \frac{2}{3}(2 - 3) = -\frac{2}{3}$$

23. Let $u = \theta^{3/2} \Rightarrow du = \frac{3}{2} \theta^{1/2} d\theta \Rightarrow \frac{2}{3} du = \sqrt{\theta} d\theta$; $\theta = 0 \Rightarrow u = 0$, $\theta = \sqrt[3]{\pi^2} \Rightarrow u = \pi$

$$\int_0^{\sqrt[3]{\pi^2}} \sqrt{\theta} \cos^2(\theta^{3/2}) d\theta = \int_0^{\pi} \cos^2 u \left(\frac{2}{3} du\right) = \left[\frac{2}{3} \left(\frac{u}{2} + \frac{1}{4} \sin 2u\right)\right]_0^{\pi} = \frac{2}{3} \left(\frac{\pi}{2} + \frac{1}{4} \sin 2\pi\right) - \frac{2}{3}(0) = \frac{\pi}{3}$$

24. Let $u = 1 + \frac{1}{t} \Rightarrow du = -t^{-2} dt$; $t = -1 \Rightarrow u = 0$, $t = -\frac{1}{2} \Rightarrow u = -1$

$$\int_{-1}^{-1/2} t^{-2} \sin^2\left(1 + \frac{1}{t}\right) dt = \int_0^{-1} -\sin^2 u du = \left[-\left(\frac{u}{2} - \frac{1}{4} \sin 2u\right)\right]_0^{-1} = -\left[\left(-\frac{1}{2} - \frac{1}{4} \sin(-2)\right) - \left(0 - \frac{1}{4} \sin 0\right)\right] \\ = \frac{1}{2} - \frac{1}{4} \sin 2$$

25. Let $u = \tan \theta \Rightarrow du = \sec^2 \theta d\theta$; $\theta = 0 \Rightarrow u = 0$, $\theta = \pi/4 \Rightarrow u = 1$;

$$\int_0^{\pi/4} (1 + e^{\tan \theta}) \sec^2 \theta d\theta = \int_0^{\pi/4} \sec^2 \theta d\theta + \int_0^{\pi/4} e^u du = [\tan \theta]_0^{\pi/4} + [e^u]_0^1 = [\tan(\pi/4) - \tan(0)] + (e^1 - e^0) = \\ (1 - 0) + (e - 1) = e$$

26. Let $u = \cot \theta \Rightarrow du = -\csc^2 \theta d\theta$; $\theta = \pi/4 \Rightarrow u = 1$, $\theta = \pi/2 \Rightarrow u = 0$;

$$\int_{\pi/4}^{\pi/2} (1 + e^{\cot \theta}) \csc^2 \theta d\theta = \int_{\pi/4}^{\pi/2} \csc^2 \theta d\theta - \int_1^0 e^u du = [-\cot \theta]_{\pi/4}^{\pi/2} - [e^u]_1^0 = [-\cot(\pi/2) + \cot(\pi/4)] - (e^0 - e^1) = \\ (1 - 0) - (1 - e) = e$$

27. $\int_0^\pi \frac{\sin t}{2-\cos t} dt = [\ln|2-\cos t|]_0^\pi = \ln 3 - \ln 1 = \ln 3$; or let $u = 2 - \cos t \Rightarrow du = \sin t dt$ with $t = 0 \Rightarrow u = 1$ and $t = \pi \Rightarrow u = 3 \Rightarrow \int_0^\pi \frac{\sin t}{2-\cos t} dt = \int_1^3 \frac{1}{u} du = [\ln|u|]_1^3 = \ln 3 - \ln 1 = \ln 3$

28. $\int_0^{\pi/3} \frac{4\sin\theta}{1-4\cos\theta} d\theta = [\ln|1-4\cos\theta|]_0^{\pi/3} = \ln 1 - \ln 3 = -\ln 3 = \ln \frac{1}{3}$; or let $u = 1 - 4\cos\theta \Rightarrow du = 4\sin\theta d\theta$ with $\theta = 0 \Rightarrow u = -3$ and $\theta = \frac{\pi}{3} \Rightarrow u = -1 \Rightarrow \int_0^{\pi/3} \frac{4\sin\theta}{1-4\cos\theta} d\theta = \int_{-3}^{-1} \frac{1}{u} du = [\ln|u|]_{-3}^{-1} = -\ln 3 = \ln \frac{1}{3}$

29. Let $u = \ln x \Rightarrow du = \frac{1}{x} dx$; $x = 1 \Rightarrow u = 0$ and $x = 2 \Rightarrow u = \ln 2$; $\int_1^2 \frac{2\ln x}{x} dx = \int_0^{\ln 2} 2u du = [u^2]_0^{\ln 2} = (\ln 2)^2$

30. Let $u = \ln x \Rightarrow du = \frac{1}{x} dx$; $x = 2 \Rightarrow u = \ln 2$ and $x = 4 \Rightarrow u = \ln 4$; $\int_2^4 \frac{dx}{x \ln x} = \int_{\ln 2}^{\ln 4} \frac{1}{u} du = [\ln u]_{\ln 2}^{\ln 4} = \ln(\ln 4) - \ln(\ln 2) = \ln\left(\frac{\ln 4}{\ln 2}\right) = \ln\left(\frac{\ln 2^2}{\ln 2}\right) = \ln\left(\frac{2\ln 2}{\ln 2}\right) = \ln 2$

31. Let $u = \ln x \Rightarrow du = \frac{1}{x} dx$; $x = 2 \Rightarrow u = \ln 2$ and $x = 4 \Rightarrow u = \ln 4$; $\int_2^4 \frac{dx}{x(\ln x)^2} = \int_{\ln 2}^{\ln 4} u^{-2} du = \left[-\frac{1}{u}\right]_{\ln 2}^{\ln 4} = -\frac{1}{\ln 4} + \frac{1}{\ln 2} = -\frac{1}{\ln 2^2} + \frac{1}{\ln 2} = -\frac{1}{2\ln 2} + \frac{1}{\ln 2} = \frac{1}{2\ln 2} = \frac{1}{\ln 4}$

32. Let $u = \ln x \Rightarrow du = \frac{1}{x} dx$; $x = 2 \Rightarrow u = \ln 2$ and $x = 16 \Rightarrow u = \ln 16$; $\int_2^{16} \frac{dx}{2x\sqrt{\ln x}} = \frac{1}{2} \int_{\ln 2}^{\ln 16} u^{-1/2} du = \left[u^{1/2}\right]_{\ln 2}^{\ln 16} = \sqrt{\ln 16} - \sqrt{\ln 2} = \sqrt{4\ln 2} - \sqrt{\ln 2} = 2\sqrt{\ln 2} - \sqrt{\ln 2} = \sqrt{\ln 2}$

33. Let $u = \cos \frac{x}{2} \Rightarrow du = -\frac{1}{2} \sin \frac{x}{2} dx \Rightarrow -2 du = \sin \frac{x}{2} dx$; $x = 0 \Rightarrow u = 1$ and $x = \frac{\pi}{2} \Rightarrow u = \frac{1}{\sqrt{2}}$; $\int_0^{\pi/2} \tan \frac{x}{2} dx = \int_0^{\pi/2} \frac{\sin(\pi/2)}{\cos(\pi/2)} dx = -2 \int_1^{1/\sqrt{2}} \frac{du}{u} = [-2 \ln|u|]_1^{1/\sqrt{2}} = -2 \ln \frac{1}{\sqrt{2}} = 2 \ln \sqrt{2} = \ln 2$

34. Let $u = \sin t \Rightarrow \cos t dt$; $t = \frac{\pi}{4} \Rightarrow u = \frac{1}{\sqrt{2}}$ and $t = \frac{\pi}{2} \Rightarrow u = 1$; $\int_{\pi/4}^{\pi/2} \cot t dt = \int_{\pi/4}^{\pi/2} \frac{\cos t}{\sin t} dt = \int_{1/\sqrt{2}}^1 \frac{du}{u} = [\ln|u|]_{1/\sqrt{2}}^1 = -\ln \frac{1}{\sqrt{2}} = \ln \sqrt{2}$

35. $\tan^2 \theta \cos \theta = (\sec^2 \theta - 1) \cos \theta = \sec \theta - \cos \theta \Rightarrow \int_0^{\pi/3} \tan^2 \theta \cos \theta d\theta = \int_0^{\pi/3} \sec \theta d\theta - \int_0^{\pi/3} \cos \theta d\theta$

The second integral is $[-\sin \theta]_0^{\pi/3} = -\frac{\sqrt{3}}{2}$. Rewrite the first integral as

$\int_0^{\pi/3} \sec \theta \left(\frac{\sec \theta + \tan \theta}{\sec \theta + \tan \theta} \right) d\theta = \int_0^{\pi/3} \frac{\sec^2 \theta + \sec \theta \tan \theta}{\sec \theta + \tan \theta} d\theta$. Let $u = \sec \theta + \tan \theta \Rightarrow du = (\sec \theta \tan \theta + \sec^2 \theta) d\theta =$

$(\sec^2 \theta + \sec \theta \tan \theta) d\theta$; $\theta = 0 \Rightarrow u = 1 + 0 = 1$; $\theta = \pi/3 \Rightarrow 2 + \sqrt{3}$;

$\int_0^{\pi/3} \frac{\sec^2 \theta + \sec \theta \tan \theta}{\sec \theta + \tan \theta} d\theta = \int_1^{2+\sqrt{3}} \frac{1}{u} du = \ln [u]_1^{2+\sqrt{3}} = \ln(2 + \sqrt{3})$; thus the original definite integral is equal to $-\frac{\sqrt{3}}{2} + \ln(2 + \sqrt{3})$.

36. Let $u = \cos 3x \Rightarrow du = -3 \sin 3x dx$; $-2 du = 6 \sin 3x dx$; $x = 0 \Rightarrow u = 1$, $x = \pi/12 \Rightarrow u = 1/\sqrt{2}$;

$$\int_0^{\pi/12} 6 \tan 3x dx = \int_0^{\pi/12} \frac{6 \sin 3x}{\cos 3x} dx = -2 \int_1^{1/\sqrt{2}} \frac{du}{u} = -2 [\ln |u|]_1^{1/\sqrt{2}} = -2 \ln \frac{1}{\sqrt{2}} - \ln 1 = 2 \ln \sqrt{2} = \ln 2$$

37. $\int_{-\pi/2}^{\pi/2} \frac{2 \cos \theta d\theta}{1 + (\sin \theta)^2} = 2 \int_{-1}^1 \frac{du}{1 + u^2}$, where $u = \sin \theta \Rightarrow du = \cos \theta d\theta$; $\theta = -\frac{\pi}{2} \Rightarrow u = -1$, $\theta = \frac{\pi}{2} \Rightarrow u = 1$,

$$= [2 \tan^{-1} u]_{-1}^1 = 2(\tan^{-1} 1 - \tan^{-1}(-1)) = 2\left[\frac{\pi}{4} - \left(-\frac{\pi}{4}\right)\right] = \pi$$

38. $\int_{\pi/6}^{\pi/4} \frac{\csc^2 x dx}{1 + (\cot x)^2} = -\int_{\sqrt{3}}^1 \frac{du}{\sqrt{3} + u^2}$, where $u = \cot x \Rightarrow du = -\csc^2 x dx$; $x = \frac{\pi}{6} \Rightarrow u = \sqrt{3}$, $x = \frac{\pi}{4} \Rightarrow u = 1$,

$$= [-\tan^{-1} u]_{\sqrt{3}}^1 = -\tan^{-1} 1 + \tan^{-1} \sqrt{3} = -\frac{\pi}{4} + \frac{\pi}{3} = \frac{\pi}{12}$$

39. $\int_0^{\ln \sqrt{3}} \frac{e^x dx}{1 + e^{2x}} = \int_1^{\sqrt{3}} \frac{du}{1 + u^2}$, where $u = e^x$ and $du = e^x dx$; $x = 0 \Rightarrow u = 1$, $x = \ln \sqrt{3} \Rightarrow u = \sqrt{3}$,

$$= [\tan^{-1} u]_1^{\sqrt{3}} = \tan^{-1} \sqrt{3} - \tan^{-1} 1 = \frac{\pi}{3} - \frac{\pi}{4} = \frac{\pi}{12}$$

40. $\int_1^{e^{\pi/4}} \frac{4 dt}{t(1 + \ln^2 t)} = 4 \int_0^{\pi/4} \frac{du}{1 + u^2}$, where $u = \ln t$ and $du = \frac{1}{t} dt$; $t = 1 \Rightarrow u = 0$, $t = e^{\pi/4} \Rightarrow u = \pi/4$,

$$= [4 \tan^{-1} u]_0^{\pi/4} = 4(\tan^{-1} \frac{\pi}{4} - \tan^{-1} 0) = 4 \tan^{-1} \frac{\pi}{4}$$

41. $\int_0^1 \frac{4 ds}{\sqrt{4 - s^2}} = [4 \sin^{-1} \frac{s}{2}]_0^1 = 4(\sin^{-1} \frac{1}{2} - \sin^{-1} 0) = 4(\frac{\pi}{6} - 0) = \frac{2\pi}{3}$

42. $\int_0^{3\sqrt{2}/4} \frac{ds}{\sqrt{9 - s^2}} = \frac{1}{2} \int_0^{3\sqrt{2}/4} \frac{du}{\sqrt{9 - u^2}}$, where $u = 2s$ and $du = 2 ds$; $s = 0 \Rightarrow u = 0$, $s = \frac{3\sqrt{2}}{4} \Rightarrow u = \frac{3\sqrt{2}}{2}$,

$$= [\frac{1}{2} \sin^{-1} \frac{u}{3}]_0^{3\sqrt{2}/2} = \frac{1}{2}(\sin^{-1} \frac{\sqrt{2}}{2} - \sin^{-1} 0) = \frac{1}{2}(\frac{\pi}{4} - 0) = \frac{\pi}{8}$$

43. $\int_{\sqrt{2}}^2 \frac{\sec^2(\sec^{-1} x)}{x\sqrt{x^2 - 1}} dx = \int_{\pi/4}^{\pi/3} \sec^2 u du$, where $u = \sec^{-1} x$ and $du = \frac{dx}{x\sqrt{x^2 - 1}}$; $x = \sqrt{2} \Rightarrow u = \frac{\pi}{4}$, $x = 2 \Rightarrow u = \frac{\pi}{3}$,

$$= [\tan u]_{\pi/4}^{\pi/3} = \tan \frac{\pi}{3} - \tan \frac{\pi}{4} = \sqrt{3} - 1$$

44. $\int_{2\sqrt{3}}^2 \frac{\cos(\sec^{-1} x)}{x\sqrt{x^2 - 1}} dx = \int_{\pi/6}^{\pi/3} \cos u du$, where $u = \sec^{-1} x$ and $du = \frac{dx}{x\sqrt{x^2 - 1}}$; $x = \frac{2}{\sqrt{3}} \Rightarrow u = \frac{\pi}{6}$, $x = 2 \Rightarrow u = \frac{\pi}{3}$,

$$= [\sin u]_{\pi/6}^{\pi/3} = \sin \frac{\pi}{3} - \sin \frac{\pi}{6} = \frac{\sqrt{3} - 1}{2}$$

45. $\int_{-1}^{-\sqrt{2}/2} \frac{dy}{y\sqrt{4y^2-1}} = \int_{-2}^{-\sqrt{2}} \frac{du}{u\sqrt{u^2-1}}$, where $u = 2y$ and $du = 2 dy$; $y = -1 \Rightarrow u = -2$, $y = -\frac{\sqrt{2}}{2} \Rightarrow u = -\sqrt{2}$,
 $= [\sec^{-1}|u|]_{-2}^{-\sqrt{2}} = \sec^{-1}|-\sqrt{2}| - \sec^{-1}|-2| = \frac{\pi}{4} - \frac{\pi}{3} = -\frac{\pi}{12}$

46. $\int_0^3 \frac{y dy}{\sqrt{5y+1}} = \frac{1}{25} \int_1^{16} \frac{u-1}{u^{1/2}} du$, where $u = 5y+1$ and $du = 5 dy$; $y = 0 \Rightarrow u = 1$, $y = 3 \Rightarrow u = 16$,
 $= \frac{1}{25} \int u^{1/2} - u^{-1/2} du = \frac{1}{25} \left[\frac{2}{3} u^{3/2} - 2u^{1/2} \right]_1^{16} = \frac{1}{25} \left[\left(\frac{2}{3} \cdot 64 - 8 \right) - \left(\frac{2}{3} - 2 \right) \right] = \frac{36}{25}$

47. Let $u = 4 - x^2 \Rightarrow du = -2x dx \Rightarrow -\frac{1}{2} du = x dx$; $x = -2 \Rightarrow u = 0$, $x = 0 \Rightarrow u = 4$, $x = 2 \Rightarrow u = 0$
 $A = -\int_{-2}^0 x\sqrt{4-x^2} dx + \int_0^2 x\sqrt{4-x^2} dx = -\int_0^4 -\frac{1}{2} u^{1/2} du + \int_4^0 -\frac{1}{2} u^{1/2} du = 2 \int_0^4 \frac{1}{2} u^{1/2} du = \int_0^4 u^{1/2} du$
 $= \left[\frac{2}{3} u^{3/2} \right]_0^4 = \frac{2}{3} (4)^{3/2} - \frac{2}{3} (0)^{3/2} = \frac{16}{3}$

48. Let $u = 1 - \cos x \Rightarrow du = \sin x dx$; $x = 0 \Rightarrow u = 0$, $x = \pi \Rightarrow u = 2$
 $\int_0^\pi (1 - \cos x) \sin x dx = \int_0^2 u du = \left[\frac{u^2}{2} \right]_0^2 = \frac{2^2}{2} - \frac{0^2}{2} = 2$

49. Let $u = 1 + \cos x \Rightarrow du = -\sin x dx \Rightarrow -du = \sin x dx$; $x = -\pi \Rightarrow u = 1 + \cos(-\pi) = 0$, $x = 0 \Rightarrow u = 1 + \cos 0 = 2$
 $A = -\int_{-\pi}^0 3(\sin x)\sqrt{1+\cos x} dx = -\int_0^2 3u^{1/2}(-du) = 3 \int_0^2 u^{1/2} du = \left[2u^{3/2} \right]_0^2 = 2(2)^{3/2} - 2(0)^{3/2} = 2^{5/2}$

50. Let $u = \pi + \pi \sin x \Rightarrow du = \pi \cos x dx \Rightarrow \frac{1}{\pi} du = \cos x dx$; $x = -\frac{\pi}{2} \Rightarrow u = \pi + \pi \sin\left(-\frac{\pi}{2}\right) = 0$, $x = 0 \Rightarrow u = \pi$
 Because of symmetry about $x = -\frac{\pi}{2}$, $A = 2 \int_{-\pi/2}^0 \frac{\pi}{2} (\cos x)(\sin(\pi + \pi \sin x)) dx = 2 \int_0^\pi \frac{\pi}{2} (\sin u) \left(\frac{1}{\pi} du \right)$
 $= \int_0^\pi \sin u du = [-\cos u]_0^\pi = (-\cos \pi) - (-\cos 0) = 2$

51. For the sketch given, $a = 0$, $b = \pi$; $f(x) - g(x) = 1 - \cos^2 x = \sin^2 x = \frac{1 - \cos 2x}{2}$;
 $A = \int_0^\pi \frac{(1 - \cos 2x)}{2} dx = \frac{1}{2} \int_0^\pi (1 - \cos 2x) dx = \frac{1}{2} \left[x - \frac{\sin 2x}{2} \right]_0^\pi = \frac{1}{2} [(\pi - 0) - (0 - 0)] = \frac{\pi}{2}$

52. For the sketch given, $a = -\frac{\pi}{3}$, $b = \frac{\pi}{3}$; $f(t) - g(t) = \frac{1}{2} \sec^2 t - (-4 \sin^2 t) = \frac{1}{2} \sec^2 t + 4 \sin^2 t$;
 $A = \int_{-\pi/3}^{\pi/3} \left(\frac{1}{2} \sec^2 t + 4 \sin^2 t \right) dt = \frac{1}{2} \int_{-\pi/3}^{\pi/3} \sec^2 t dt + 4 \int_{-\pi/3}^{\pi/3} \sin^2 t dt = \frac{1}{2} \int_{-\pi/3}^{\pi/3} \sec^2 t dt + 4 \int_{-\pi/3}^{\pi/3} \frac{(1 - \cos 2t)}{2} dt$
 $= \frac{1}{2} \int_{-\pi/3}^{\pi/3} \sec^2 t dt + 2 \int_{-\pi/3}^{\pi/3} (1 - \cos 2t) dt = \frac{1}{2} [\tan t]_{-\pi/3}^{\pi/3} + 2 \left[t - \frac{\sin 2t}{2} \right]_{-\pi/3}^{\pi/3} = \sqrt{3} + 4 \cdot \frac{\pi}{3} - \sqrt{3} = \frac{4\pi}{3}$

53. For the sketch given, $a = -2$, $b = 2$; $f(x) - g(x) = 2x^2 - (x^4 - 2x^2) = 4x^2 - x^4$;
 $A = \int_{-2}^2 (4x^2 - x^4) dx = \left[\frac{4x^3}{3} - \frac{x^5}{5} \right]_{-2}^2 = \left(\frac{32}{3} - \frac{32}{5} \right) - \left[-\frac{32}{3} - \left(-\frac{32}{5} \right) \right] = \frac{64}{3} - \frac{64}{5} = \frac{320 - 192}{15} = \frac{128}{15}$

54. For the sketch given, $c = 0$, $d = 1$; $f(y) - g(y) = y^2 - y^3$;

$$A = \int_0^1 (y^2 - y^3) dy = \int_0^1 y^2 dy - \int_0^1 y^3 dy = \left[\frac{y^3}{3} \right]_0^1 - \left[\frac{y^4}{4} \right]_0^1 = \frac{(1-0)}{3} - \frac{(1-0)}{4} = \frac{1}{3} - \frac{1}{4} = \frac{1}{12}$$

55. For the sketch given, $c = 0$, $d = 1$; $f(y) - g(y) = (12y^2 - 12y^3) - (2y^2 - 2y) = 10y^2 - 12y^3 + 2y$;

$$A = \int_0^1 (10y^2 - 12y^3 + 2y) dy = \int_0^1 10y^2 dy - \int_0^1 12y^3 dy + \int_0^1 2y dy = \left[\frac{10}{3} y^3 \right]_0^1 - \left[\frac{12}{4} y^4 \right]_0^1 + \left[\frac{2}{2} y^2 \right]_0^1 \\ = \left(\frac{10}{3} - 0 \right) - (3 - 0) + (1 - 0) = \frac{4}{3}$$

56. For the sketch given, $a = -1$, $b = 1$; $f(x) - g(x) = x^2 - (-2x^4) = x^2 + 2x^4$;

$$A = \int_{-1}^1 (x^2 + 2x^4) dx = \left[\frac{x^3}{3} + \frac{2x^5}{5} \right]_{-1}^1 = \left(\frac{1}{3} + \frac{2}{5} \right) - \left[-\frac{1}{3} + \left(-\frac{2}{5} \right) \right] = \frac{2}{3} + \frac{4}{5} = \frac{10+12}{15} = \frac{22}{15}$$

57. We want the area between the line $y = 1$, $0 \leq x \leq 2$, and the curve $y = \frac{x^2}{4}$, *minus* the area of a triangle

(formed by $y = x$ and $y = 1$) with base 1 and height 1. Thus, $A = \int_0^2 \left(1 - \frac{x^2}{4} \right) dx - \frac{1}{2}(1)(1) = \left[x - \frac{x^3}{12} \right]_0^2 - \frac{1}{2}$
 $= \left(2 - \frac{8}{12} \right) - \frac{1}{2} = 2 - \frac{2}{3} - \frac{1}{2} = \frac{5}{6}$

58. We want the area between the x -axis and the curve $y = x^2$, $0 \leq x \leq 1$ *plus* the area of a triangle (formed by

$x = 1$, $x + y = 2$, and the x -axis) with base 1 and height 1. Thus, $A = \int_0^1 x^2 dx + \frac{1}{2}(1)(1) = \left[\frac{x^3}{3} \right]_0^1 + \frac{1}{2} = \frac{1}{3} + \frac{1}{2} = \frac{5}{6}$

59. AREA = $A_1 + A_2$

A1: For the sketch given, $a = -3$ and we find b by solving the equations $y = x^2 - 4$ and $y = -x^2 - 2x$ simultaneously for x : $x^2 - 4 = -x^2 - 2x \Rightarrow 2x^2 + 2x - 4 = 0 \Rightarrow 2(x+2)(x-1) \Rightarrow x = -2$ or $x = 1$ so

$$b = -2: f(x) - g(x) = (x^2 - 4) - (-x^2 - 2x) = 2x^2 + 2x - 4 \Rightarrow A_1 = \int_{-3}^{-2} (2x^2 + 2x - 4) dx$$

$$= \left[\frac{2x^3}{3} + \frac{2x^2}{2} - 4x \right]_{-3}^{-2} = \left(-\frac{16}{3} + 4 + 8 \right) - (-18 + 9 + 12) = 9 - \frac{16}{3} = \frac{11}{3};$$

A2: For the sketch given, $a = -2$ and $b = 1$: $f(x) - g(x) = (-x^2 - 2x) - (x^2 - 4) = -2x^2 - 2x + 4$

$$\Rightarrow A_2 = -\int_{-2}^1 (2x^2 + 2x - 4) dx = -\left[\frac{2x^3}{3} + x^2 - 4x \right]_{-2}^1 = -\left(\frac{2}{3} + 1 - 4 \right) + \left(-\frac{16}{3} + 4 + 8 \right)$$

$$= -\frac{2}{3} - 1 + 4 - \frac{16}{3} + 4 + 8 = 9;$$

$$\text{Therefore, AREA} = A_1 + A_2 = \frac{11}{3} + 9 = \frac{38}{3}$$

60. AREA = $A_1 + A_2$

A1: For the sketch given, $a = -2$ and $b = 0$: $f(x) - g(x) = (2x^3 - x^2 - 5x) - (-x^2 + 3x) = 2x^3 - 8x$

$$\Rightarrow A_1 = \int_{-2}^0 (2x^3 - 8x) dx = \left[\frac{2x^4}{4} - \frac{8x^2}{2} \right]_{-2}^0 = 0 - (8 - 16) = 8;$$

A2: For the sketch given, $a = 0$ and $b = 2$: $f(x) - g(x) = (-x^2 + 3x) - (2x^3 - x^2 - 5x) = 8x - 2x^3$

$$\Rightarrow A_2 = \int_0^2 (8x - 2x^3) dx = \left[\frac{8x^2}{2} - \frac{2x^4}{4} \right]_0^2 = (16 - 8) = 8;$$

$$\text{Therefore, AREA} = A_1 + A_2 = 16$$

61. AREA = A1 + A2 + A3

A1: For the sketch given, $a = -2$ and $b = -1$: $f(x) - g(x) = (-x + 2) - (4 - x^2) = x^2 - x - 2$

$$\Rightarrow A1 = \int_{-2}^{-1} (x^2 - x - 2) dx = \left[\frac{x^3}{3} - \frac{x^2}{2} - 2x \right]_{-2}^{-1} = \left(-\frac{1}{3} - \frac{1}{2} + 2 \right) - \left(-\frac{8}{3} - \frac{4}{2} + 4 \right) = \frac{7}{3} - \frac{1}{2} = \frac{14-3}{6} = \frac{11}{6};$$

A2: For the sketch given, $a = -1$ and $b = 2$: $f(x) - g(x) = (4 - x^2) - (-x + 2) = -(x^2 - x - 2)$

$$\Rightarrow A2 = -\int_{-1}^2 (x^2 - x - 2) dx = -\left[\frac{x^3}{3} - \frac{x^2}{2} - 2x \right]_{-1}^2 = -\left(\frac{8}{3} - \frac{4}{2} - 4 \right) + \left(-\frac{1}{3} - \frac{1}{2} + 2 \right) = -3 + 8 - \frac{1}{2} = \frac{9}{2};$$

A3: For the sketch given, $a = 2$ and $b = 3$: $f(x) - g(x) = (-x + 2) - (4 - x^2) = x^2 - x - 2$

$$\Rightarrow A3 = \int_2^3 (x^2 - x - 2) dx = \left[\frac{x^3}{3} - \frac{x^2}{2} - 2x \right]_2^3 = \left(\frac{27}{3} - \frac{9}{2} - 6 \right) - \left(\frac{8}{3} - \frac{4}{2} - 4 \right) = 9 - \frac{9}{2} - \frac{8}{3};$$

$$\text{Therefore, AREA} = A1 + A2 + A3 = \frac{11}{6} + \frac{9}{2} + \left(9 - \frac{9}{2} - \frac{8}{3} \right) = 9 - \frac{5}{6} = \frac{49}{6}$$

62. AREA = A1 + A2 + A3

A1: For the sketch given, $a = -2$ and $b = 0$: $f(x) - g(x) = \left(\frac{x^3}{3} - x \right) - \frac{x}{3} = \frac{x^3}{3} - \frac{4}{3}x = \frac{1}{3}(x^3 - 4x)$

$$\Rightarrow A1 = \frac{1}{3} \int_{-2}^0 (x^3 - 4x) dx = \frac{1}{3} \left[\frac{x^4}{4} - 2x^2 \right]_{-2}^0 = 0 - \frac{1}{3}(4 - 8) = \frac{4}{3};$$

A2: For the sketch given, $a = 0$ and we find b by solving the equations $y = \frac{x^3}{3} - x$ and $y = \frac{x}{3}$ simultaneously

$$\text{for } x: \frac{x^3}{3} - x = \frac{x}{3} \Rightarrow \frac{x^3}{3} - \frac{4}{3}x = 0 \Rightarrow \frac{x}{3}(x-2)(x+2) = 0 \Rightarrow x = -2, x = 0, \text{ or } x = 2 \text{ so } b = 2: f(x) - g(x) \\ = \frac{x}{3} - \left(\frac{x^3}{3} - x \right) = -\frac{1}{3}(x^3 - 4x) \Rightarrow A2 = -\frac{1}{3} \int_0^2 (x^3 - 4x) dx = \frac{1}{3} \int_0^2 (4x - x^3) dx = \frac{1}{3} \left[2x^2 - \frac{x^4}{4} \right]_0^2 = \frac{1}{3}(8 - 4) = \frac{4}{3};$$

A3: For the sketch given, $a = 2$ and $b = 3$: $f(x) - g(x) = \left(\frac{x^3}{3} - x \right) - \frac{x}{3} = \frac{1}{3}(x^3 - 4x)$

$$\Rightarrow A3 = \frac{1}{3} \int_2^3 (x^3 - 4x) dx = \frac{1}{3} \left[\frac{x^4}{4} - 2x^2 \right]_2^3 = \frac{1}{3} \left[\left(\frac{81}{4} - 2 \cdot 9 \right) - \left(\frac{16}{4} - 8 \right) \right] = \frac{1}{3} \left(\frac{81}{4} - 14 \right) = \frac{25}{12};$$

$$\text{Therefore, AREA} = A1 + A2 + A3 = \frac{4}{3} + \frac{4}{3} + \frac{25}{12} = \frac{32+25}{12} = \frac{19}{4}$$

63. $a = -2, b = 2$;

$$f(x) - g(x) = 2 - (x^2 - 2) = 4 - x^2$$

$$\Rightarrow A = \int_{-2}^2 (4 - x^2) dx = \left[4x - \frac{x^3}{3} \right]_{-2}^2 = \left(8 - \frac{8}{3} \right) - \left(-8 + \frac{8}{3} \right)$$

$$= 2 \cdot \left(\frac{24}{3} - \frac{8}{3} \right) = \frac{32}{3}$$

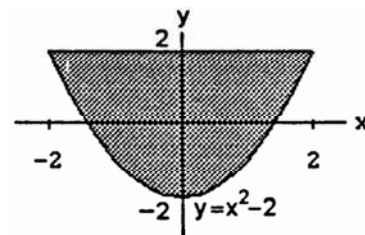
64. $a = -1, b = 3$;

$$f(x) - g(x) = (2x - x^2) - (-3) = 2x - x^2 + 3$$

$$\Rightarrow A = \int_{-1}^3 (2x - x^2 + 3) dx = \left[x^2 - \frac{x^3}{3} + 3x \right]_{-1}^3$$

$$= \left(9 - \frac{27}{3} + 9 \right) - \left(1 + \frac{1}{3} - 3 \right) = 11 - \frac{1}{3} = \frac{32}{3}$$

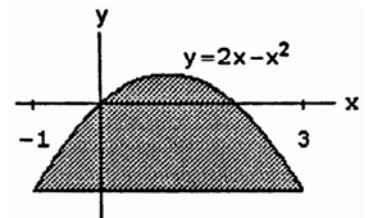

65. $a = 0, b = 2;$

$$f(x) - g(x) = 8x - x^4 \Rightarrow A = \int_0^2 (8x - x^4) dx$$

$$= \left[\frac{8x^2}{2} - \frac{x^5}{5} \right]_0^2 = 16 - \frac{32}{5} = \frac{80-32}{5} = \frac{48}{5}$$

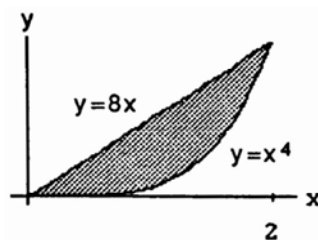

66. Limits of integration: $x^2 - 2x = x \Rightarrow x^2 - 3x = 0$
 $\Rightarrow x(x-3) = 0 \Rightarrow a = 0$ and $b = 3;$

$$f(x) - g(x) = x - (x^2 - 2x) = 3x - x^2$$

$$\Rightarrow A = \int_0^3 (3x - x^2) dx = \left[\frac{3x^2}{2} - \frac{x^3}{3} \right]_0^3 = \frac{27}{2} - 9 = \frac{27-18}{2} = \frac{9}{2}$$

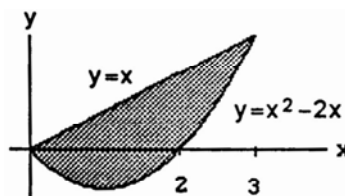

67. Limits of integration: $x^2 = -x^2 + 4x \Rightarrow 2x^2 - 4x = 0$
 $\Rightarrow 2x(x-2) = 0 \Rightarrow a = 0$ and $b = 2;$

$$f(x) - g(x) = (-x^2 + 4x) - x^2 = -2x^2 + 4x$$

$$\Rightarrow A = \int_0^2 (-2x^2 + 4x) dx = \left[-\frac{2x^3}{3} + \frac{4x^2}{2} \right]_0^2$$

$$= -\frac{16}{3} + \frac{16}{2} = \frac{-32+48}{6} = \frac{8}{3}$$

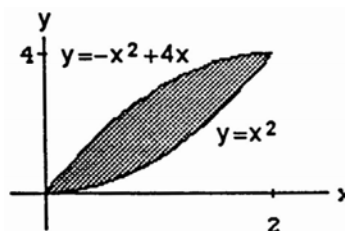

68. Limits of integration: $7 - 2x^2 = x^2 + 4 \Rightarrow 3x^2 - 3 = 0$
 $\Rightarrow 3(x-1)(x+1) = 0 \Rightarrow a = -1$ and $b = 1;$

$$f(x) - g(x) = (7 - 2x^2) - (x^2 + 4) = 3 - 3x^2$$

$$\Rightarrow A = \int_{-1}^1 (3 - 3x^2) dx = 3 \left[x - \frac{x^3}{3} \right]_{-1}^1 = 3 \left[\left(1 - \frac{1}{3}\right) - \left(-1 + \frac{1}{3}\right) \right]$$

$$= 6 \left(\frac{2}{3} \right) = 4$$

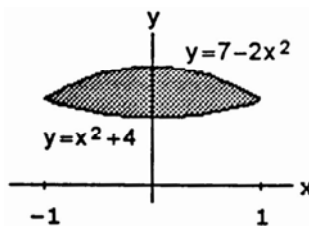

69. Limits of integration: $x^4 - 4x^2 + 4 = x^2 \Rightarrow x^4 - 5x^2 + 4 = 0$
 $\Rightarrow (x^2 - 4)(x^2 - 1) = 0 \Rightarrow (x+2)(x-2)(x+1)(x-1) = 0$

$$\Rightarrow x = -2, -1, 1, 2; f(x) - g(x) = (x^4 - 4x^2 + 4) - x^2$$

$$= x^4 - 5x^2 + 4 \text{ and}$$

$$g(x) - f(x) = x^2 - (x^4 - 4x^2 + 4) = -x^4 + 5x^2 - 4$$

$$\Rightarrow A = \int_{-2}^{-1} (-x^4 + 5x^2 - 4) dx + \int_{-1}^1 (x^4 - 5x^2 + 4) dx$$

$$+ \int_1^2 (-x^4 + 5x^2 - 4) dx$$

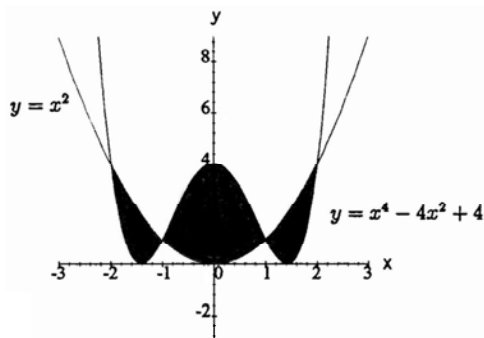

$$= \left[-\frac{x^5}{5} + \frac{5x^3}{3} - 4x \right]_{-2}^{-1} + \left[\frac{x^5}{5} - \frac{5x^3}{3} + 4x \right]_{-1}^1 + \left[-\frac{x^5}{5} + \frac{5x^3}{3} - 4x \right]_1^2$$

$$= \left(\frac{1}{5} - \frac{5}{3} + 4 \right) - \left(\frac{32}{5} - \frac{40}{3} + 8 \right) + \left(\frac{1}{5} - \frac{5}{3} + 4 \right) - \left(-\frac{1}{5} + \frac{5}{3} - 4 \right) + \left(-\frac{32}{5} + \frac{40}{3} - 8 \right) - \left(-\frac{1}{5} + \frac{5}{3} - 4 \right) = -\frac{60}{5} + \frac{60}{3} = \frac{300-180}{15} = 8$$

70. Limits of integration: $x\sqrt{a^2 - x^2} = 0 \Rightarrow x = 0$ or $\sqrt{a^2 - x^2} = 0 \Rightarrow x = 0$ or $a^2 - x^2 = 0 \Rightarrow x = -a, 0, a$;

$$A = \int_{-a}^0 -x\sqrt{a^2 - x^2} dx + \int_0^a x\sqrt{a^2 - x^2} dx$$

$$= \frac{1}{2} \left[\frac{2}{3} (a^2 - x^2)^{3/2} \right]_{-a}^0 - \frac{1}{2} \left[\frac{2}{3} (a^2 - x^2)^{3/2} \right]_0^a$$

$$= \frac{1}{3} (a^2)^{3/2} - \left[-\frac{1}{3} (a^2)^{3/2} \right] = \frac{2a^3}{3}$$

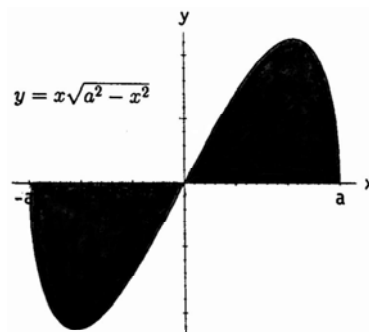

71. Limits of integration: $y = \sqrt{|x|} = \begin{cases} \sqrt{-x}, & x \leq 0 \\ \sqrt{x}, & x \geq 0 \end{cases}$ and

$5y = x + 6$ or $y = \frac{x}{5} + \frac{6}{5}$; for $x \leq 0$; $\sqrt{-x} = \frac{x}{5} + \frac{6}{5}$

$$\Rightarrow 5\sqrt{-x} = x + 6 \Rightarrow 25(-x) = x^2 + 12x + 36$$

$$\Rightarrow x^2 + 37x + 36 = 0 \Rightarrow (x+1)(x+36) = 0$$

$$\Rightarrow x = -1, -36 \text{ (but } x = -36 \text{ is not a solution);}$$

for $x \geq 0$: $5\sqrt{x} = x + 6 \Rightarrow 25x = x^2 + 12x + 36$

$$\Rightarrow x^2 - 13x + 36 = 0 \Rightarrow (x-4)(x-9) = 0$$

$$\Rightarrow x = 4, 9; \text{ there are three intersection points and}$$

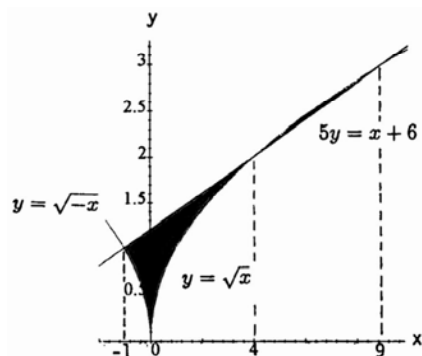

$$A = \int_{-1}^0 \left(\frac{x+6}{5} - \sqrt{-x} \right) dx + \int_0^4 \left(\frac{x+6}{5} - \sqrt{x} \right) dx + \int_4^9 \left(\sqrt{x} - \frac{x+6}{5} \right) dx$$

$$= \left[\frac{(x+6)^2}{10} + \frac{2}{3} (-x)^{3/2} \right]_{-1}^0 + \left[\frac{(x+6)^2}{10} - \frac{2}{3} x^{3/2} \right]_0^4 + \left[\frac{2}{3} x^{3/2} - \frac{(x+6)^2}{10} \right]_4^9$$

$$= \left(\frac{36}{10} - \frac{25}{10} - \frac{2}{3} \right) + \left(\frac{100}{10} - \frac{2}{3} \cdot 4^{3/2} - \frac{36}{10} + 0 \right) + \left(\frac{2}{3} \cdot 9^{3/2} - \frac{225}{10} - \frac{2}{3} \cdot 4^{3/2} + \frac{100}{10} \right) = -\frac{50}{10} + \frac{20}{3} = \frac{5}{3}$$

72. Limits of integration: $y = |x^2 - 4| = \begin{cases} x^2 - 4, & x \leq -2 \text{ or } x \geq 2 \\ 4 - x^2, & -2 \leq x \leq 2 \end{cases}$

for $x \leq -2$ and $x \geq 2$: $x^2 - 4 = \frac{x^2}{2} + 4$

$$\Rightarrow 2x^2 - 8 = x^2 + 8 \Rightarrow x^2 = 16 \Rightarrow x = \pm 4; \text{ for } -2 \leq x \leq 2:$$

$$4 - x^2 = \frac{x^2}{2} + 4 \Rightarrow 8 - 2x^2 = x^2 + 8 \Rightarrow x^2 = 0 \Rightarrow x = 0; \text{ by}$$

symmetry of the graph,

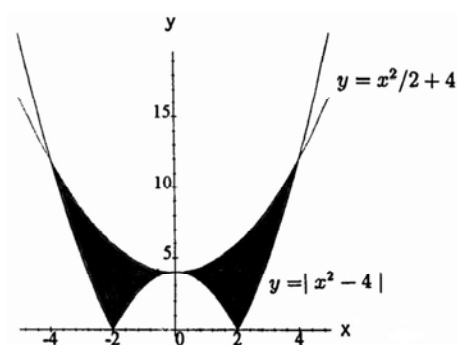

$$A = 2 \int_0^2 \left[\left(\frac{x^2}{2} + 4 \right) - (4 + x^2) \right] dx$$

$$+ 2 \int_2^4 \left[\left(\frac{x^2}{2} + 4 \right) - (x^2 - 4) \right] dx = 2 \left[\frac{x^3}{2} \right]_0^2 + 2 \left[8x - \frac{x^3}{6} \right]_2^4$$

$$= 2 \left(\frac{8}{2} - 0 \right) + 2 \left(32 - \frac{64}{6} - 16 + \frac{8}{6} \right) = 40 - \frac{56}{3} = \frac{64}{3}$$

73. Limits of integration: $c = 0$ and $d = 3$;

$$f(y) - g(y) = 2y^2 - 0 = 2y^2$$

$$\Rightarrow A = \int_0^3 2y^2 dy = \left[\frac{2y^3}{3} \right]_0^3 = 2 \cdot 9 = 18$$

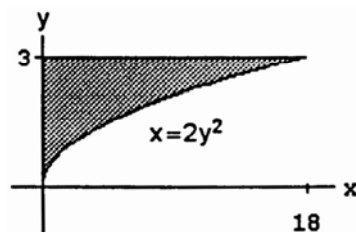

74. Limits of integration: $y^2 = y + 2 \Rightarrow (y+1)(y-2) = 0$

$$\Rightarrow c = -1 \text{ and } d = 2; f(y) - g(y) = (y+2) - y^2$$

$$\Rightarrow A = \int_{-1}^2 (y+2-y^2) dy = \left[\frac{y^2}{2} + 2y - \frac{y^3}{3} \right]_{-1}^2$$

$$= \left(\frac{4}{2} + 4 - \frac{8}{3} \right) - \left(\frac{1}{2} - 2 + \frac{1}{3} \right) = 6 - \frac{8}{3} - \frac{1}{2} + 2 - \frac{1}{3} = \frac{9}{2}$$

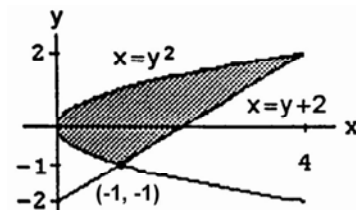

75. Limits of integration: $4x = y^2 - 4$ and

$$4x = 16 + y \Rightarrow y^2 - 4 = 16 + y \Rightarrow y^2 - y - 20 = 0$$

$$\Rightarrow (y-5)(y+4) = 0 \Rightarrow c = -4 \text{ and } d = 5;$$

$$f(y) - g(y) = \left(\frac{16+y}{4} \right) - \left(\frac{y^2-4}{4} \right) = \frac{-y^2+y+20}{4}$$

$$\Rightarrow A = \frac{1}{4} \int_{-4}^5 (-y^2 + y + 20) dy = \frac{1}{4} \left[-\frac{y^3}{3} + \frac{y^2}{2} + 20y \right]_{-4}^5$$

$$= \frac{1}{4} \left(-\frac{125}{3} + \frac{25}{2} + 100 \right) - \frac{1}{4} \left(\frac{64}{3} + \frac{16}{2} - 80 \right)$$

$$= \frac{1}{4} \left(-\frac{189}{3} + \frac{9}{2} + 180 \right) = \frac{243}{8}$$

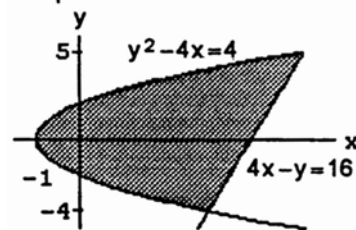

76. Limits of integration: $x = y^2$ and $x = 3 - 2y^2$

$$\Rightarrow y^2 = 3 - 2y^2 \Rightarrow 3y^2 - 3 = 0 \Rightarrow 3(y-1)(y+1) = 0$$

$$\Rightarrow c = -1 \text{ and } d = 1; f(y) - g(y) = (3 - 2y^2) - y^2$$

$$= 3 - 3y^2 = 3(1 - y^2) \Rightarrow A = 3 \int_{-1}^1 (1 - y^2) dy$$

$$= 3 \left[y - \frac{y^3}{3} \right]_{-1}^1 = 3 \left(1 - \frac{1}{3} \right) - 3 \left(-1 + \frac{1}{3} \right) = 3 \cdot 2 \left(1 - \frac{1}{3} \right) = 4$$

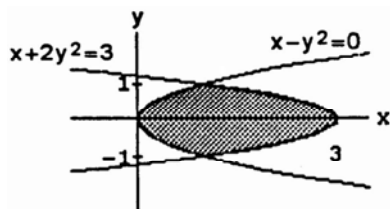

77. Limits of integration: $x = -y^2$ and $x = 2 - 3y^2$

$$\Rightarrow -y^2 = 2 - 3y^2 \Rightarrow 2y^2 - 2 = 0$$

$$\Rightarrow 2(y-1)(y+1) = 0 \Rightarrow c = -1 \text{ and } d = 1;$$

$$f(y) - g(y) = (2 - 3y^2) - (-y^2) = 2 - 2y^2 = 2(1 - y^2)$$

$$\Rightarrow A = 2 \int_{-1}^1 (1 - y^2) dy = 2 \left[y - \frac{y^3}{3} \right]_{-1}^1$$

$$= 2 \left(1 - \frac{1}{3} \right) - 2 \left(-1 + \frac{1}{3} \right) = 4 \left(\frac{2}{3} \right) = \frac{8}{3}$$

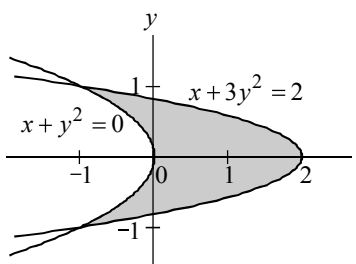

78. Limits of integration: $x = y^{2/3}$ and $x = 2 - y^4 \Rightarrow y^{2/3} = 2 - y^4 \Rightarrow c = -1$ and $d = 1$;
 $f(y) - g(y) = (2 - y^4) - y^{2/3} \Rightarrow A = \int_{-1}^1 (2 - y^4 - y^{2/3}) dy$
 $= \left[2y - \frac{y^5}{5} - \frac{3}{5} y^{5/3} \right]_{-1}^1 = \left(2 - \frac{1}{5} - \frac{3}{5} \right) - \left(-2 + \frac{1}{5} + \frac{3}{5} \right)$
 $= 2 \left(2 - \frac{1}{5} - \frac{3}{5} \right) = \frac{12}{5}$

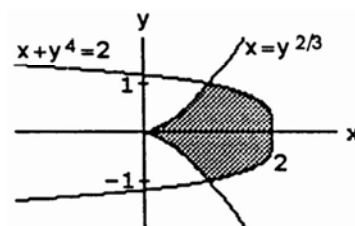

79. Limits of integration: $x = y^2 - 1$ and $x = |y| \sqrt{1 - y^2}$
 $\Rightarrow y^2 - 1 = |y| \sqrt{1 - y^2} \Rightarrow y^4 - 2y^2 + 1 = y^2(1 - y^2)$
 $\Rightarrow y^4 - 2y^2 + 1 = y^2 - y^4 \Rightarrow 2y^4 - 3y^2 + 1 = 0$
 $\Rightarrow (2y^2 - 1)(y^2 - 1) = 0 \Rightarrow 2y^2 - 1 = 0$ or $y^2 - 1 = 0 \Rightarrow y^2 = \frac{1}{2}$
 or $y^2 = 1 \Rightarrow y = \pm \frac{\sqrt{2}}{2}$ or $y = \pm 1$.
 Substitution shows that $\frac{\pm\sqrt{2}}{2}$ are not solutions $\Rightarrow y = \pm 1$;
 for $-1 \leq y \leq 0$, $f(x) - g(x) = -y\sqrt{1 - y^2} - (y^2 - 1)$
 $= 1 - y^2 - y(1 - y^2)^{1/2}$, and by symmetry of the graph,

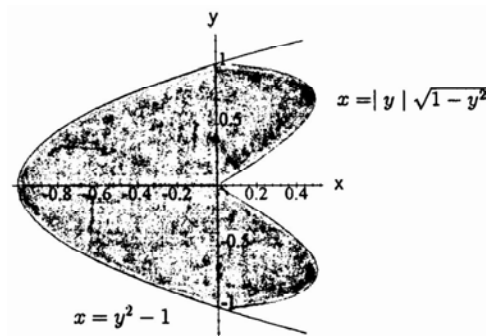

$$A = 2 \int_{-1}^0 [1 - y^2 - y(1 - y^2)^{1/2}] dy = 2 \int_{-1}^0 (1 - y^2) dy - 2 \int_{-1}^0 y(1 - y^2)^{1/2} dy$$

$$= 2 \left[y - \frac{y^3}{3} \right]_{-1}^0 + 2 \left(\frac{1}{2} \right) \left[\frac{2(1 - y^2)^{3/2}}{3} \right]_{-1}^0 = 2 \left[(0 - 0) - \left(-1 + \frac{1}{3} \right) \right] + \left(\frac{2}{3} - 0 \right) = 2$$

80. AREA = A1 + A2
 Limits of integration: $x = 2y$ and $x = y^3 - y^2 \Rightarrow y^3 - y^2 - 2y = 0$
 $\Rightarrow y(y^2 - y - 2) = y(y + 1)(y - 2) = 0 \Rightarrow y = -1, 0, 2$;
 for $-1 \leq y \leq 0$, $f(y) - g(y) = y^3 - y^2 - 2y$

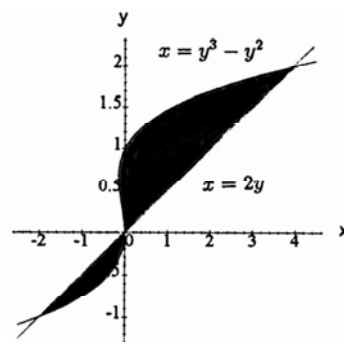

$$\Rightarrow A1 = \int_{-1}^0 (y^3 - y^2 - 2y) dy = \left[\frac{y^4}{4} - \frac{y^3}{3} - y^2 \right]_{-1}^0$$

$$= 0 - \left(\frac{1}{4} + \frac{1}{3} - 1 \right) = \frac{5}{12};$$

for $0 \leq y \leq 2$, $f(y) - g(y) = 2y - y^3 + y^2$

$$\Rightarrow A2 = \int_0^2 (2y - y^3 + y^2) dy = \left[y^2 - \frac{y^4}{4} + \frac{y^3}{3} \right]_0^2$$

$$= \left(4 - \frac{16}{4} + \frac{8}{3} \right) - 0 = \frac{8}{3}; \text{ Therefore, } A1 + A2 = \frac{5}{12} + \frac{8}{3} = \frac{37}{12}$$

81. Limits of integration: $y = -4x^2 + 4$ and $y = x^4 - 1$
 $\Rightarrow x^4 - 1 = -4x^2 + 4 \Rightarrow x^4 + 4x^2 - 5 = 0$
 $\Rightarrow (x^2 + 5)(x - 1)(x + 1) = 0 \Rightarrow a = -1$ and $b = 1$;
 $f(x) - g(x) = -4x^2 + 4 - x^4 + 1 = -4x^2 - x^4 + 5$
 $\Rightarrow A = \int_{-1}^1 (-4x^2 - x^4 + 5) dx = \left[-\frac{4x^3}{3} - \frac{x^5}{5} + 5x \right]_{-1}^1$
 $= \left(-\frac{4}{3} - \frac{1}{5} + 5 \right) - \left(\frac{4}{3} + \frac{1}{5} - 5 \right) = 2 \left(-\frac{4}{3} - \frac{1}{5} + 5 \right) = \frac{104}{15}$

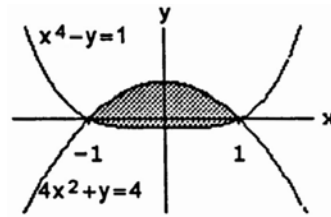

82. Limits of integration: $y = x^3$ and $y = 3x^2 - 4$
 $\Rightarrow x^3 - 3x^2 + 4 = 0 \Rightarrow (x^2 - x - 2)(x - 2) = 0$
 $\Rightarrow (x + 1)(x - 2)^2 = 0 \Rightarrow a = -1$ and $b = 2$;
 $f(x) - g(x) = x^3 - (3x^2 - 4) = x^3 - 3x^2 + 4$
 $\Rightarrow A = \int_{-1}^2 (x^3 - 3x^2 + 4) dx = \left[\frac{x^4}{4} - \frac{3x^3}{3} + 4x \right]_{-1}^2$
 $= \left(\frac{16}{4} - \frac{24}{3} + 8 \right) - \left(\frac{1}{4} + 1 - 4 \right) = \frac{27}{4}$

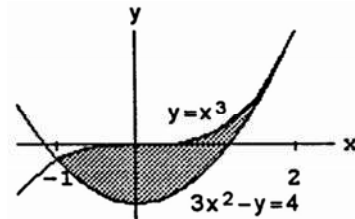

83. Limits of integration: $x = 4 - 4y^2$ and $x = 1 - y^4$
 $\Rightarrow 4 - 4y^2 = 1 - y^4 \Rightarrow y^4 - 4y^2 + 3 = 0$
 $\Rightarrow (y - \sqrt{3})(y + \sqrt{3})(y - 1)(y + 1) = 0 \Rightarrow c = -1$ and $d = 1$
 since $x \geq 0$; $f(y) - g(y) = (4 - 4y^2) - (1 - y^4)$
 $= 3 - 4y^2 + y^4 \Rightarrow A = \int_{-1}^1 (3 - 4y^2 + y^4) dy$
 $= \left[3y - \frac{4y^3}{3} + \frac{y^5}{5} \right]_{-1}^1 = 2 \left(3 - \frac{4}{3} + \frac{1}{5} \right) = \frac{56}{15}$

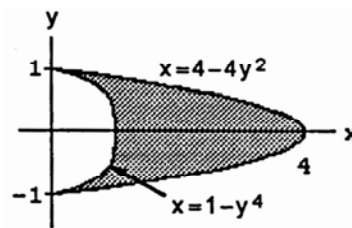

84. Limits of integration: $x = 3 - y^2$ and $x = -\frac{y^2}{4}$
 $\Rightarrow 3 - y^2 = -\frac{y^2}{4} \Rightarrow \frac{3y^2}{4} - 3 = 0 \Rightarrow \frac{3}{4}(y - 2)(y + 2) = 0$
 $\Rightarrow c = -2$ and $d = 2$; $f(y) - g(y) = (3 - y^2) - \left(-\frac{y^2}{4} \right)$
 $= 3 \left(1 - \frac{y^2}{4} \right) \Rightarrow A = 3 \int_{-2}^2 \left(1 - \frac{y^2}{4} \right) dy = 3 \left[y - \frac{y^3}{12} \right]_{-2}^2$
 $= 3 \left[\left(2 - \frac{8}{12} \right) - \left(-2 + \frac{8}{12} \right) \right] = 3 \left(4 - \frac{16}{12} \right) = 12 - 4 = 8$

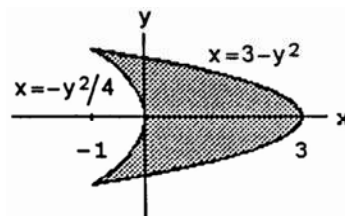

85. $a = 0$, $b = \pi$; $f(x) - g(x) = 2 \sin x - \sin 2x$
 $\Rightarrow A = \int_0^\pi (2 \sin x - \sin 2x) dx = \left[-2 \cos x + \frac{\cos 2x}{2} \right]_0^\pi$
 $= \left[-2(-1) + \frac{1}{2} \right] - \left(-2 \cdot 1 + \frac{1}{2} \right) = 4$

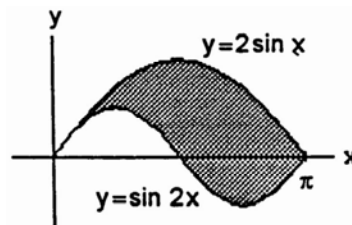

$$\begin{aligned}
 86. \quad a &= -\frac{\pi}{3}, b = \frac{\pi}{3}; f(x) - g(x) = 8 \cos x - \sec^2 x \\
 \Rightarrow A &= \int_{-\pi/3}^{\pi/3} (8 \cos x - \sec^2 x) dx = [8 \sin x - \tan x]_{-\pi/3}^{\pi/3} \\
 &= \left(8 \cdot \frac{\sqrt{3}}{2} - \sqrt{3}\right) - \left(-8 \cdot \frac{\sqrt{3}}{2} + \sqrt{3}\right) = 6\sqrt{3}
 \end{aligned}$$

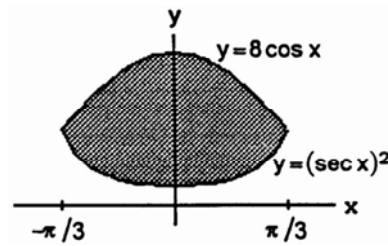

$$\begin{aligned}
 87. \quad a &= -1, b = 1; f(x) - g(x) = (1 - x^2) - \cos\left(\frac{\pi x}{2}\right) \\
 \Rightarrow A &= \int_{-1}^1 \left[1 - x^2 - \cos\left(\frac{\pi x}{2}\right)\right] dx \\
 &= \left[x - \frac{x^3}{3} - \frac{2}{\pi} \sin\left(\frac{\pi x}{2}\right)\right]_{-1}^1 = \left(1 - \frac{1}{3} - \frac{2}{\pi}\right) - \left(-1 + \frac{1}{3} + \frac{2}{\pi}\right) \\
 &= 2\left(\frac{2}{3} - \frac{2}{\pi}\right) = \frac{4}{3} - \frac{4}{\pi}
 \end{aligned}$$

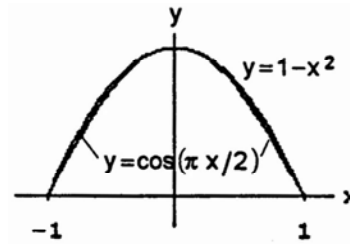

$$\begin{aligned}
 88. \quad A &= A_1 + A_2 \\
 a_1 &= -1, b_1 = 0 \text{ and } a_2 = 0, b_2 = 1; \\
 f_1(x) - g_1(x) &= x - \sin\left(\frac{\pi x}{2}\right) \text{ and } f_2(x) - g_2(x) \\
 &= \sin\left(\frac{\pi x}{2}\right) - x \Rightarrow \text{by symmetry about the origin,} \\
 A_1 + A_2 &= 2A_1 \Rightarrow A = 2 \int_0^1 \left[\sin\left(\frac{\pi x}{2}\right) - x\right] dx \\
 &= 2 \left[-\frac{2}{\pi} \cos\left(\frac{\pi x}{2}\right) - \frac{x^2}{2}\right]_0^1 = 2 \left[\left(-\frac{2}{\pi} \cdot 0 - \frac{1}{2}\right) - \left(-\frac{2}{\pi} \cdot 1 - 0\right)\right] \\
 &= 2 \left(\frac{2}{\pi} - \frac{1}{2}\right) = 2 \left(\frac{4 - \pi}{2\pi}\right) = \frac{4 - \pi}{\pi}
 \end{aligned}$$

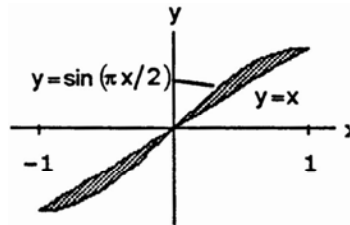

$$\begin{aligned}
 89. \quad a &= -\frac{\pi}{4}, b = \frac{\pi}{4}; f(x) - g(x) = \sec^2 x - \tan^2 x \\
 \Rightarrow A &= \int_{-\pi/4}^{\pi/4} (\sec^2 x - \tan^2 x) dx \\
 &= \int_{-\pi/4}^{\pi/4} [\sec^2 x - (\sec^2 x - 1)] dx \\
 &= \int_{-\pi/4}^{\pi/4} 1 \cdot dx = [x]_{-\pi/4}^{\pi/4} = \frac{\pi}{4} - \left(-\frac{\pi}{4}\right) = \frac{\pi}{2}
 \end{aligned}$$

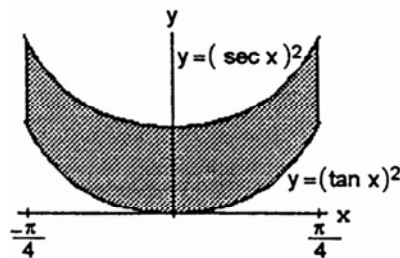

$$\begin{aligned}
 90. \quad c &= -\frac{\pi}{4}, d = \frac{\pi}{4}; f(y) - g(y) \\
 &= \tan^2 y - (-\tan^2 y) = 2 \tan^2 y = 2(\sec^2 y - 1) \\
 \Rightarrow A &= \int_{-\pi/4}^{\pi/4} 2(\sec^2 y - 1) dy = 2[(\tan y - y)]_{-\pi/4}^{\pi/4} \\
 &= 2 \left[\left(1 - \frac{\pi}{4}\right) - \left(-1 + \frac{\pi}{4}\right)\right] = 4 \left(1 - \frac{\pi}{4}\right) = 4 - \pi
 \end{aligned}$$

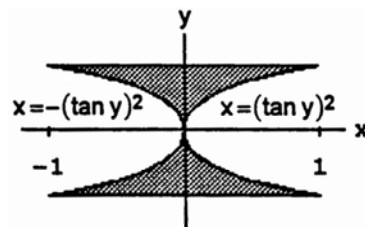

91. $c = 0, d = \frac{\pi}{2}; f(y) - g(y)$
 $= 3 \sin y \sqrt{\cos y} - 0 = 3 \sin y \sqrt{\cos y}$
 $\Rightarrow A = 3 \int_0^{\pi/2} \sin y \sqrt{\cos y} dy = -3 \left[\frac{2}{3} (\cos y)^{3/2} \right]_0^{\pi/2}$
 $= -2(0 - 1) = 2$

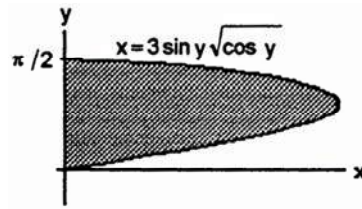

92. $a = -1, b = 1; f(x) - g(x) = \sec^2\left(\frac{\pi x}{3}\right) - x^{1/3}$
 $\Rightarrow A = \int_{-1}^1 \left[\sec^2\left(\frac{\pi x}{3}\right) - x^{1/3} \right] dx$
 $= \left[\frac{3}{\pi} \tan\left(\frac{\pi x}{3}\right) - \frac{3}{4} x^{4/3} \right]_{-1}^1$
 $= \left(\frac{3}{\pi} \sqrt{3} - \frac{3}{4} \right) - \left[\frac{3}{\pi} (-\sqrt{3}) - \frac{3}{4} \right] = \frac{6\sqrt{3}}{\pi}$

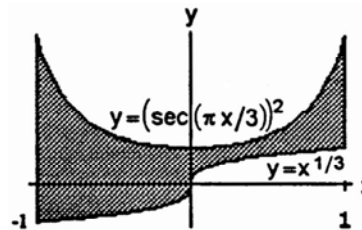

93. $A = A_1 + A_2$
 Limits of integration: $x = y^3$ and $x = y \Rightarrow y = y^3$
 $\Rightarrow y^3 - y = 0 \Rightarrow y(y-1)(y+1) = 0 \Rightarrow c_1 = -1, d_1 = 0$
 and $c_2 = 0, d_2 = 1; f_1(y) - g_1(y) = y^3 - y$ and
 $f_2(y) - g_2(y) = y - y^3 \Rightarrow$ by symmetry
 about the origin, $A_1 + A_2 = 2A_2 \Rightarrow A =$
 $2 \int_0^1 (y - y^3) dy = 2 \left[\frac{y^2}{2} - \frac{y^4}{4} \right]_0^1 = 2 \left(\frac{1}{2} - \frac{1}{4} \right) = \frac{1}{2}$

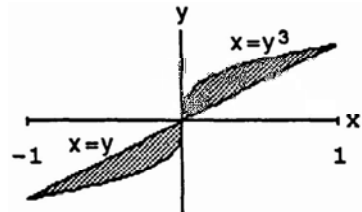

94. $A = A_1 + A_2$
 Limits of integration: $y = x^3$ and $y = x^5 \Rightarrow x^3 = x^5$
 $\Rightarrow x^5 - x^3 = 0 \Rightarrow x^3(x-1)(x+1) = 0 \Rightarrow a_1 = -1, b_1 = 0$
 and $a_2 = 0, b_2 = 1; f_1(x) - g_1(x) = x^3 - x^5$ and
 $f_2(x) - g_2(x) = x^5 - x^3 \Rightarrow$ by symmetry about the
 origin, $A_1 + A_2 = 2A_2 \Rightarrow A = 2 \int_0^1 (x^3 - x^5) dx$
 $= 2 \left[\frac{x^4}{4} - \frac{x^6}{6} \right]_0^1 = 2 \left(\frac{1}{4} - \frac{1}{6} \right) = \frac{1}{6}$

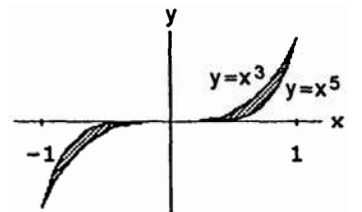

95. $A = A_1 + A_2$
 Limits of integration: $y = x$ and $y = \frac{1}{x^2} \Rightarrow x = \frac{1}{x^2}, x \neq 0$
 $\Rightarrow x^3 = 1 \Rightarrow x = 1, f_1(x) - g_1(x) = x - 0 = x$
 $\Rightarrow A_1 = \int_0^1 x dx = \left[\frac{x^2}{2} \right]_0^1 = \frac{1}{2}; f_2(x) - g_2(x) = \frac{1}{x^2} - 0$
 $= x^{-2} \Rightarrow A_2 = \int_1^2 x^{-2} dx = \left[\frac{-1}{x} \right]_1^2 = -\frac{1}{2} + 1 = \frac{1}{2};$
 $A = A_1 + A_2 = \frac{1}{2} + \frac{1}{2} = 1$

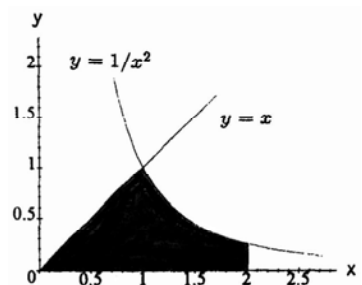

96. Limits of integration: $\sin x = \cos x \Rightarrow x = \frac{\pi}{4} \Rightarrow a = 0$ and
 $b = \frac{\pi}{4}$; $f(x) - g(x) = \cos x - \sin x$
 $\Rightarrow A = \int_0^{\pi/4} (\cos x - \sin x) dx = [\sin x + \cos x]_0^{\pi/4}$
 $= \left(\frac{\sqrt{2}}{2} + \frac{\sqrt{2}}{2}\right) - (0 + 1) = \sqrt{2} - 1$

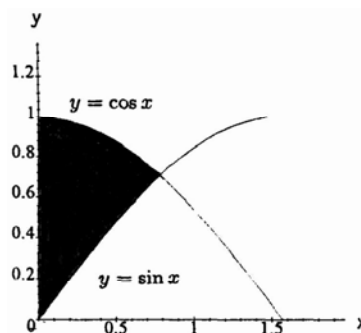

97. $\int_1^5 (\ln 2x - \ln x) dx = \int_1^5 (-\ln x + \ln 2 + \ln x) dx = (\ln 2) \int_1^5 dx = (\ln 2)(5 - 1) = \ln 2^4 = \ln 16$

98. $\int_{-\pi/4}^0 -\tan x dx + \int_0^{\pi/3} \tan x dx = \int_{-\pi/4}^0 \frac{-\sin x}{\cos x} dx - \int_0^{\pi/3} \frac{\sin x}{\cos x} dx = [\ln|\cos x|]_{-\pi/4}^0 - [\ln|\cos x|]_0^{\pi/3} =$
 $(\ln 1 - \ln \frac{1}{\sqrt{2}}) - (\ln \frac{1}{2} - \ln 1) = \ln \sqrt{2} + \ln 2 = \frac{3}{2} \ln 2$

99. $\int_0^{\ln 3} (e^{2x} - e^x) dx = \left[\frac{e^{2x}}{2} - e^x\right]_0^{\ln 3} = \left(\frac{e^{2\ln 3}}{2} - e^{\ln 3}\right) - \left(\frac{e^0}{2} - e^0\right) = \left(\frac{9}{2} - 3\right) - \left(\frac{1}{2} - 1\right) = \frac{8}{2} - 2 = 2$

100. $\int_0^{2\ln 2} (e^{x/2} - e^{-x/2}) dx = \left[2e^{x/2} + 2e^{-x/2}\right]_0^{2\ln 2} = (2e^{\ln 2} + 2e^{-\ln 2}) - (2e^0 + 2e^0) = (4 + 1) - (2 + 2) = 5 - 4 = 1$

101. $\int_{-2}^2 \frac{2x}{1+x^2} dx = 2 \int_0^2 \frac{2x}{1+x^2} dx$; $[u = 1 + x^2 \Rightarrow du = 2x dx; x = 0 \Rightarrow u = 1, x = 2 \Rightarrow u = 5]$
 $= 2 \int_1^5 \frac{1}{u} du = 2 [\ln|u|]_1^5 = 2(\ln 5 - \ln 1) = 2 \ln 5$

102. $\int_{-1}^1 2^{(1-x)} dx = 2 \int_{-1}^1 \left(\frac{1}{2}\right)^x dx = 2 \left[\frac{\frac{1}{2}^x}{\ln(\frac{1}{2})}\right]_{-1}^1 = -\frac{2}{\ln 2} \left(\frac{1}{2} - 2\right) = \left(-\frac{2}{\ln 2}\right) \left(-\frac{3}{2}\right) = \frac{3}{\ln 2}$

103. (a) The coordinates of the points of intersection of the line and parabola are $c = x^2 \Rightarrow x = \pm\sqrt{c}$ and $y = c$
 (b) $f(y) - g(y) = \sqrt{y} - (-\sqrt{y}) = 2\sqrt{y} \Rightarrow$ the area of the lower section is, $A_L = \int_0^c [f(y) - g(y)] dy$
 $= 2 \int_0^c \sqrt{y} dy = 2 \left[\frac{2}{3} y^{3/2}\right]_0^c = \frac{4}{3} c^{3/2}$. The area of

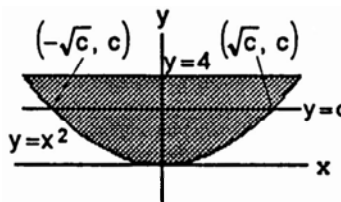

the entire shaded region can be found by setting $c = 4$: $A = \left(\frac{4}{3}\right) 4^{3/2} = \frac{4 \cdot 8}{3} = \frac{32}{3}$. Since we want c to divide the region into subsections of equal area we have $A = 2A_L \Rightarrow \frac{32}{3} = 2\left(\frac{4}{3} c^{3/2}\right) \Rightarrow c = 4^{2/3}$

(c) $f(x) - g(x) = c - x^2 \Rightarrow A_L = \int_{-\sqrt{c}}^{\sqrt{c}} [f(x) - g(x)] dx = \int_{-\sqrt{c}}^{\sqrt{c}} (c - x^2) dx = \left[cx - \frac{x^3}{3} \right]_{-\sqrt{c}}^{\sqrt{c}} = 2 \left[c^{3/2} - \frac{c^{3/2}}{3} \right] = \frac{4}{3} c^{3/2}$. Again, the area of the whole shaded region can be found by setting $c = 4 \Rightarrow A = \frac{32}{3}$. From the condition $A = 2A_L$, we get $\frac{4}{3} c^{3/2} = \frac{32}{3} \Rightarrow c = 4^{2/3}$ as in part (b).

104. (a) Limits of integration: $y = 3 - x^2$ and $y = -1$
 $\Rightarrow 3 - x^2 = -1 \Rightarrow x^2 = 4 \Rightarrow a = -2$ and $b = 2$;
 $f(x) - g(x) = (3 - x^2) - (-1) = 4 - x^2$
 $\Rightarrow A = \int_{-2}^2 (4 - x^2) dx = \left[4x - \frac{x^3}{3} \right]_{-2}^2$
 $= \left(8 - \frac{8}{3} \right) - \left(-8 + \frac{8}{3} \right) = 16 - \frac{16}{3} = \frac{32}{3}$

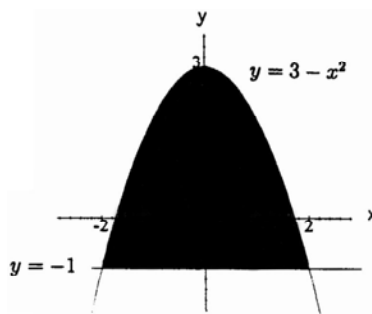

(b) Limits of integration: let $x = 0$ in $y = 3 - x^2$
 $\Rightarrow y = 3$; $f(y) - g(y) = \sqrt{3 - y} - (-\sqrt{3 - y})$
 $= 2(3 - y)^{1/2} \Rightarrow A = 2 \int_{-1}^3 (3 - y)^{1/2} dy = -2 \int_{-1}^3 (3 - y)^{1/2} (-1) dy = (-2) \left[\frac{2(3 - y)^{3/2}}{3} \right]_{-1}^3$
 $= \left(-\frac{4}{3} \right) \left[0 - (3 + 1)^{3/2} \right] = \left(\frac{4}{3} \right) (8) = \frac{32}{3}$

105. Limits of integration: $y = 1 + \sqrt{x}$ and $y = \frac{2}{\sqrt{x}}$
 $\Rightarrow 1 + \sqrt{x} = \frac{2}{\sqrt{x}}, x \neq 0 \Rightarrow \sqrt{x} + x = 2 \Rightarrow x = (2 - x)^2$
 $\Rightarrow x = 4 - 4x + x^2 \Rightarrow x^2 - 5x + 4 = 0$
 $\Rightarrow (x - 4)(x - 1) = 0 \Rightarrow x = 1, 4$ (but $x = 4$ does not satisfy the equation); $y = \frac{2}{\sqrt{x}}$ and $y = \frac{x}{4} \Rightarrow \frac{2}{\sqrt{x}} = \frac{x}{4}$
 $\Rightarrow 8 = x\sqrt{x} \Rightarrow 64 = x^3 \Rightarrow x = 4$. Therefore,
 AREA = $A_1 + A_2$; $f_1(x) - g_1(x) = \left(1 + x^{1/2} \right) - \frac{x}{4}$

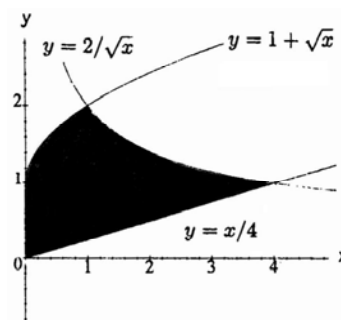

$\Rightarrow A_1 = \int_0^1 \left(1 + x^{1/2} - \frac{x}{4} \right) dx = \left[x + \frac{2}{3} x^{3/2} - \frac{x^2}{8} \right]_0^1 = \left(1 + \frac{2}{3} - \frac{1}{8} \right) - 0 = \frac{37}{24}$; $f_2(x) - g_2(x) = 2x^{-1/2} - \frac{x}{4}$
 $\Rightarrow A_2 = \int_1^4 \left(2x^{-1/2} - \frac{x}{4} \right) dx = \left[4x^{1/2} - \frac{x^2}{8} \right]_1^4 = \left(4 \cdot 2 - \frac{16}{8} \right) - \left(4 - \frac{1}{8} \right) = 4 - \frac{15}{8} = \frac{17}{8}$; Therefore,
 AREA = $A_1 + A_2 = \frac{37}{24} + \frac{17}{8} = \frac{37+51}{24} = \frac{88}{24} = \frac{11}{3}$

106. Limits of integration: $(y - 1)^2 = 3 - y$
 $\Rightarrow y^2 - 2y + 1 = 3 - y \Rightarrow y^2 - y - 2 = 0$
 $\Rightarrow (y - 2)(y + 1) = 0 \Rightarrow y = 2$ since $y > 0$; also,
 $2\sqrt{y} = 3 - y \Rightarrow 4y = 9 - 6y + y^2 \Rightarrow y^2 - 10y + 9 = 0$
 $\Rightarrow (y - 9)(y - 1) = 0 \Rightarrow y = 1$ since $y = 9$ does not satisfy the equation;
 AREA = $A_1 + A_2$

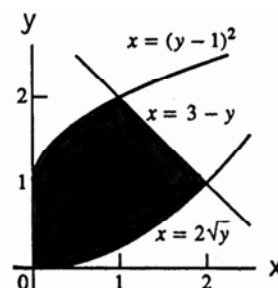

$f_1(y) - g_1(y) = 2\sqrt{y} - 0 = 2y^{1/2} \Rightarrow A_1 = 2 \int_0^1 y^{1/2} dy = 2 \left[\frac{2y^{3/2}}{3} \right]_0^1 = \frac{4}{3}$;

$f_2(y) - g_2(y) = (3 - y) - (y - 1)^2 \Rightarrow A_2 = \int_1^2 [3 - y - (y - 1)^2] dy = \left[3y - \frac{1}{2}y^2 - \frac{1}{3}(y - 1)^3 \right]_1^2$
 $= \left(6 - 2 - \frac{1}{3} \right) - \left(3 - \frac{1}{2} + 0 \right) = 1 - \frac{1}{3} + \frac{1}{2} = \frac{7}{6}$. Therefore, $A_1 + A_2 = \frac{4}{3} + \frac{7}{6} = \frac{15}{6} = \frac{5}{2}$

107. Area between parabola and $y = a^2$: $A = 2 \int_0^a (a^2 - x^2) dx = 2 \left[a^2 x - \frac{1}{3} x^3 \right]_0^a = 2 \left(a^3 - \frac{a^3}{3} \right) - 0 = \frac{4a^3}{3}$;

Area of triangle AOC: $\frac{1}{2}(2a)(a^2) = a^3$; limit of ratio = $\lim_{a \rightarrow 0^+} \frac{a^3}{\left(\frac{4a^3}{3}\right)} = \frac{3}{4}$ which is independent of a .

108. $A = \int_a^b 2f(x) dx - \int_a^b f(x) dx = 2 \int_a^b f(x) dx - \int_a^b f(x) dx = \int_a^b f(x) dx = 4$

109. Neither one; they are both zero. Neither integral takes into account the changes in the formulas for the region's upper and lower bounding curves at $x = 0$. The area of the shaded region is actually

$$A = \int_{-1}^0 [-x - (-x)] dx + \int_0^1 [x - (-x)] dx = \int_{-1}^0 -2x dx + \int_0^1 2x dx = 2.$$

110. It is sometimes true. It is true if $f(x) \geq g(x)$ for all x between a and b . Otherwise it is false. If the graph of f lies below the graph of g for a portion of the interval of integration, the integral over that portion will be negative and the integral over $[a, b]$ will be less than the area between the curves (see Exercise 71).

111. Let $u = 2x \Rightarrow du = 2 dx \Rightarrow \frac{1}{2} du = dx$; $x = 1 \Rightarrow u = 2$, $x = 3 \Rightarrow u = 6$

$$\int_1^3 \frac{\sin 2x}{x} dx = \int_2^6 \frac{\sin u}{\left(\frac{u}{2}\right)} \left(\frac{1}{2} du\right) = \int_2^6 \frac{\sin u}{u} du = [F(u)]_2^6 = F(6) - F(2)$$

112. Let $u = 1 - x \Rightarrow du = -dx \Rightarrow -du = dx$; $x = 0 \Rightarrow u = 1$, $x = 1 \Rightarrow u = 0$

$$\int_0^1 f(1-x) dx = \int_1^0 f(u)(-du) = -\int_1^0 f(u) du = \int_0^1 f(u) du = \int_0^1 f(x) dx$$

113. (a) Let $u = -x \Rightarrow du = -dx$; $x = -1 \Rightarrow u = 1$, $x = 0 \Rightarrow u = 0$

$$\begin{aligned} f \text{ odd} \Rightarrow f(-x) = -f(x). \text{ Then } \int_{-1}^0 f(x) dx &= \int_1^0 f(-u)(-du) = \int_1^0 -f(u)(-du) = \int_1^0 f(u) du \\ &= -\int_0^1 f(u) du = -3 \end{aligned}$$

(b) Let $u = -x \Rightarrow du = -dx$; $x = -1 \Rightarrow u = 1$, $x = 0 \Rightarrow u = 0$

$$f \text{ even} \Rightarrow f(-x) = f(x). \text{ Then } \int_{-1}^0 f(x) dx = \int_1^0 f(-u)(-du) = -\int_1^0 f(u) du = \int_0^1 f(u) du = 3$$

114. (a) Consider $\int_{-a}^0 f(x) dx$ when f is odd. Let $u = -x \Rightarrow du = -dx \Rightarrow -du = dx$ and $x = -a \Rightarrow u = a$ and

$$x = 0 \Rightarrow u = 0. \text{ Thus } \int_{-a}^0 f(x) dx = \int_a^0 -f(-u) du = \int_a^0 f(u) du = -\int_0^a f(u) du = -\int_0^a f(x) dx. \text{ Thus}$$

$$\int_{-a}^a f(x) dx = \int_{-a}^0 f(x) dx + \int_0^a f(x) dx = -\int_0^a f(x) dx + \int_0^a f(x) dx = 0.$$

(b) $\int_{-\pi/2}^{\pi/2} \sin x dx = [-\cos x]_{-\pi/2}^{\pi/2} = -\cos\left(\frac{\pi}{2}\right) + \cos\left(-\frac{\pi}{2}\right) = 0 + 0 = 0.$

115. Let $u = a - x \Rightarrow du = -dx$; $x = 0 \Rightarrow u = a$, $x = a \Rightarrow u = 0$

$$I = \int_0^a \frac{f(x) dx}{f(x)+f(a-x)} = \int_a^0 \frac{f(a-u)}{f(a-u)+f(u)} (-du) = \int_0^a \frac{f(a-u) du}{f(u)+f(a-u)} = \int_0^a \frac{f(a-x) dx}{f(x)+f(a-x)}$$

$$\Rightarrow I + I = \int_0^a \frac{f(x) dx}{f(x)+f(a-x)} + \int_0^a \frac{f(a-x) dx}{f(x)+f(a-x)} = \int_0^a \frac{f(x)+f(a-x)}{f(x)+f(a-x)} dx = \int_0^a dx = [x]_0^a = a - 0 = a.$$

Therefore, $2I = a \Rightarrow I = \frac{a}{2}$.

116. Let $u = \frac{xy}{t} \Rightarrow du = -\frac{xy}{t^2} dt \Rightarrow -\frac{t}{xy} du = \frac{1}{t} dt \Rightarrow -\frac{1}{u} du = \frac{1}{t} dt$; $t = x \Rightarrow u = y$, $t = xy \Rightarrow u = 1$. Therefore,

$$\int_x^{xy} \frac{1}{t} dt = \int_y^1 -\frac{1}{u} du = -\int_y^1 \frac{1}{u} du = \int_1^y \frac{1}{u} du = \int_1^y \frac{1}{t} dt$$

117. Let $u = x + c \Rightarrow du = dx$; $x = a - c \Rightarrow u = a$, $x = b - c \Rightarrow u = b$

$$\int_{a-c}^{b-c} f(x+c) dx = \int_a^b f(u) du = \int_a^b f(x) dx$$

118. (a)

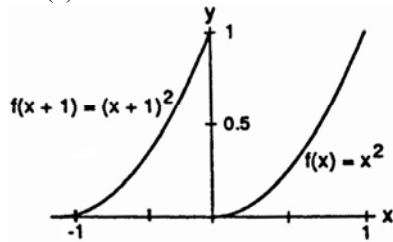

(b)

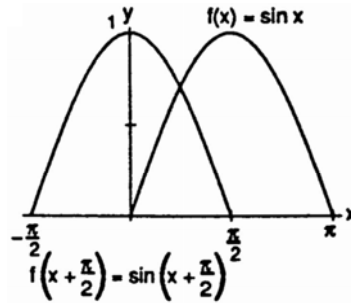

(c)

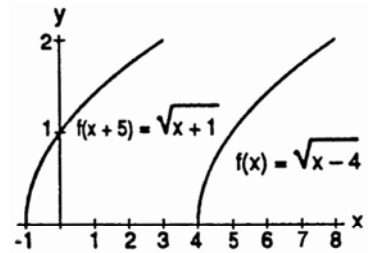

119-122. Example CAS commands:

Maple:

```
f := x -> x^3/3-x^2/2-2*x+1/3;
g := x -> x-1;
plot([f(x),g(x)], x=-5..5, legend=["y = f(x)", "y = g(x)"], title="#119(a) (Section 5.6)");
q1 := [-5, -2, 1, 4]; # (b)
q2 := [seq( fsolve( f(x)=g(x), x=q1[i]..q1[i+1]), i=1..nops(q1)-1)];
for i from 1 to nops(q2)-1 do # (c)
  area[i] := int( abs(f(x)-g(x)), x=q2[i]..q2[i+1]);
end do;
add( area[i], i=1..nops(q2)-1); # (d)
```

Mathematica: (assigned functions may vary)

```
Clear[x, f, g]
f[x_] = x^2 Cos[x]
g[x_] = x^3 - x
Plot[{f[x], g[x]}, {x, -2, 2}]
```

After examining the plots, the initial guesses for FindRoot can be determined.

```
pts = x.Map[FindRoot[f[x]==g[x], {x, #}]&, {-1, 0, 1}]
i1=NIntegrate[f[x]-g[x], {x, pts[[1]], pts[[2]]}]
i2=NIntegrate[f[x]-g[x], {x, pts[[2]], pts[[3]]}]
i1+i2
```

CHAPTER 5 PRACTICE EXERCISES

1. (a) Each time subinterval is of length $\Delta t = 0.4$ sec. The distance traveled over each subinterval, using the midpoint rule, is $\Delta h = \frac{1}{2}(v_i + v_{i+1})\Delta t$, where v_i is the velocity at the left endpoint and v_{i+1} the velocity at the right endpoint of the subinterval. We then add Δh to the height attained so far at the left endpoint v_i to arrive at the height associated with velocity v_{i+1} at the right endpoint. Using this methodology we build the following table based on the figure in the text:

t (sec)	0	0.4	0.8	1.2	1.6	2.0	2.4	2.8	3.2	3.6	4.0	4.4	4.8	5.2	5.6	6.0
v (fps)	0	10	25	55	100	190	180	165	150	140	130	115	105	90	76	65
h (ft)	0	2	9	25	56	114	188	257	320	378	432	481	525	564	592	620.2

t (sec)	6.4	6.8	7.2	7.6	8.0
v (fps)	50	37	25	12	0
h (ft)	643.2	660.6	672	679.4	681.8

NOTE: Your table values may vary slightly from ours depending on the v -values you read from the graph. Remember that some shifting of the graph occurs in the printing process. The total height attained is about 680 ft.

- (b) The graph is based on the table in part (a).

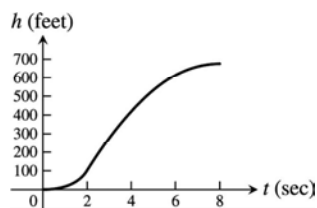

2. (a) Each time subinterval is of length $\Delta t = 1$ sec. The distance traveled over each subinterval, using the midpoint rule, is $\Delta s = \frac{1}{2}(v_i + v_{i+1}) \Delta t$, where v_i is the velocity at the left, and v_{i+1} the velocity at the right, endpoint of the subinterval. We then add Δs to the distance attained so far at the left endpoint v_i to arrive at the distance associated with velocity v_{i+1} at the right endpoint. Using this methodology we build the table given below based on the figure in the text, obtaining approximately 26 m for the total distance traveled:

t (sec)	0	1	2	3	4	5	6	7	8	9	10
v (m/sec)	0	0.5	1.2	2	3.4	4.5	4.8	4.5	3.5	2	0
s (m)	0	0.25	1.1	2.7	5.4	9.35	14	18.65	22.65	25.4	26.4

- (b) The graph shows the distance traveled by the moving body as a function of time for $0 \leq t \leq 10$.

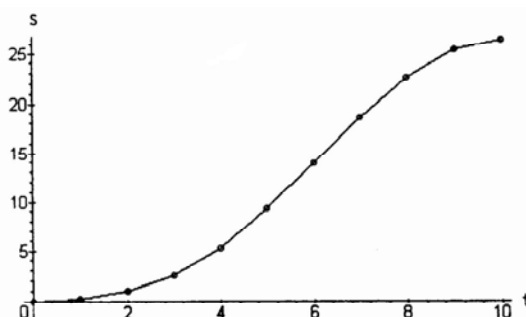

$$\begin{aligned}
3. \quad (a) \quad & \sum_{k=1}^{10} \frac{a_k}{4} = \frac{1}{4} \sum_{k=1}^{10} a_k = \frac{1}{4}(-2) = -\frac{1}{2} \\
(b) \quad & \sum_{k=1}^{10} (b_k - 3a_k) = \sum_{k=1}^{10} b_k - 3 \sum_{k=1}^{10} a_k = 25 - 3(-2) = 31 \\
(c) \quad & \sum_{k=1}^{10} (a_k + b_k - 1) = \sum_{k=1}^{10} a_k + \sum_{k=1}^{10} b_k - \sum_{k=1}^{10} 1 = -2 + 25 - (1)(10) = 13 \\
(d) \quad & \sum_{k=1}^{10} \left(\frac{5}{2} - b_k\right) = \sum_{k=1}^{10} \frac{5}{2} - \sum_{k=1}^{10} b_k = \frac{5}{2}(10) - 25 = 0
\end{aligned}$$

$$\begin{aligned}
4. \quad (a) \quad & \sum_{k=1}^{20} 3a_k = 3 \sum_{k=1}^{20} a_k = 3(0) = 0 \\
(b) \quad & \sum_{k=1}^{20} (a_k + b_k) = \sum_{k=1}^{20} a_k + \sum_{k=1}^{20} b_k = 0 + 7 = 7 \\
(c) \quad & \sum_{k=1}^{20} \left(\frac{1}{2} - \frac{2b_k}{7}\right) = \sum_{k=1}^{20} \frac{1}{2} - \frac{2}{7} \sum_{k=1}^{20} b_k = \frac{1}{2}(20) - \frac{2}{7}(7) = 8 \\
(d) \quad & \sum_{k=1}^{20} (a_k - 2) = \sum_{k=1}^{20} a_k - \sum_{k=1}^{20} 2 = 0 - 2(20) = -40
\end{aligned}$$

$$5. \text{ Let } u = 2x - 1 \Rightarrow du = 2 dx \Rightarrow \frac{1}{2} du = dx; x = 1 \Rightarrow u = 1, x = 5 \Rightarrow u = 9$$

$$\int_1^5 (2x - 1)^{-1/2} dx = \int_1^9 u^{-1/2} \left(\frac{1}{2} du\right) = \left[u^{1/2}\right]_1^9 = 3 - 1 = 2$$

$$6. \text{ Let } u = x^2 - 1 \Rightarrow du = 2x dx \Rightarrow \frac{1}{2} du = x dx; x = 1 \Rightarrow u = 0, x = 3 \Rightarrow u = 8$$

$$\int_1^3 x(x^2 - 1)^{1/3} dx = \int_0^8 u^{1/3} \left(\frac{1}{2} du\right) = \left[\frac{3}{8} u^{4/3}\right]_0^8 = \frac{3}{8}(16 - 0) = 6$$

$$7. \text{ Let } u = \frac{x}{2} \Rightarrow 2 du = dx; x = -\pi \Rightarrow u = -\frac{\pi}{2}, x = 0 \Rightarrow u = 0$$

$$\int_{-\pi}^0 \cos\left(\frac{x}{2}\right) dx = \int_{-\pi/2}^0 (\cos u)(2 du) = [2 \sin u]_{-\pi/2}^0 = 2 \sin 0 - 2 \sin\left(-\frac{\pi}{2}\right) = 2(0 - (-1)) = 2$$

$$8. \text{ Let } u = \sin x \Rightarrow du = \cos x dx; x = 0 \Rightarrow u = 0, x = \frac{\pi}{2} \Rightarrow u = 1$$

$$\int_0^{\pi/2} (\sin x)(\cos x) dx = \int_0^1 u du = \left[\frac{u^2}{2}\right]_0^1 = \frac{1}{2}$$

$$9. \quad (a) \quad \int_{-2}^2 f(x) dx = \frac{1}{3} \int_{-2}^2 3 f(x) dx = \frac{1}{3}(12) = 4$$

$$(b) \quad \int_2^5 f(x) dx = \int_{-2}^5 f(x) dx - \int_{-2}^2 f(x) dx = 6 - 4 = 2$$

$$(c) \quad \int_5^{-2} g(x) dx = -\int_{-2}^5 g(x) dx = -2$$

$$(d) \quad \int_{-2}^5 (-\pi g(x)) dx = -\pi \int_{-2}^5 g(x) dx = -\pi(2) = -2\pi$$

$$(e) \quad \int_{-2}^5 \left(\frac{f(x)+g(x)}{5}\right) dx = \frac{1}{5} \int_{-2}^5 f(x) dx + \frac{1}{5} \int_{-2}^5 g(x) dx = \frac{1}{5}(6) + \frac{1}{5}(2) = \frac{8}{5}$$

10. (a) $\int_0^2 g(x) dx = \frac{1}{7} \int_0^2 7 g(x) dx = \frac{1}{7}(7) = 1$
 (b) $\int_1^2 g(x) dx = \int_0^2 g(x) dx - \int_0^1 g(x) dx = 1 - 2 = -1$
 (c) $\int_2^0 f(x) dx = -\int_0^2 f(x) dx = -\pi$
 (d) $\int_0^2 \sqrt{2} f(x) dx = \sqrt{2} \int_0^2 f(x) dx = \sqrt{2}(\pi) = \pi\sqrt{2}$
 (e) $\int_0^2 [g(x) - 3f(x)] dx = \int_0^2 g(x) dx - 3 \int_0^2 f(x) dx = 1 - 3\pi$

11. $x^2 - 4x + 3 = 0 \Rightarrow (x-3)(x-1) = 0 \Rightarrow x = 3$ or $x = 1$;

$$\begin{aligned} \text{Area} &= \int_0^1 (x^2 - 4x + 3) dx - \int_1^3 (x^2 - 4x + 3) dx \\ &= \left[\frac{x^3}{3} - 2x^2 + 3x \right]_0^1 - \left[\frac{x^3}{3} - 2x^2 + 3x \right]_1^3 \\ &= \left[\left(\frac{1^3}{3} - 2(1)^2 + 3(1) \right) - 0 \right] \\ &\quad - \left[\left(\frac{3^3}{3} - 2(3)^2 + 3(3) \right) - \left(\frac{1^3}{3} - 2(1)^2 + 3(1) \right) \right] \\ &= \left(\frac{1}{3} + 1 \right) - \left[0 - \left(\frac{1}{3} + 1 \right) \right] = \frac{8}{3} \end{aligned}$$

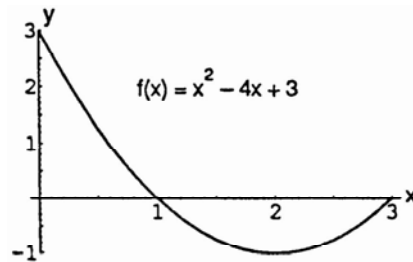

12. $1 - \frac{x^2}{4} = 0 \Rightarrow 4 - x^2 = 0 \Rightarrow x = \pm 2$;

$$\begin{aligned} \text{Area} &= \int_{-2}^2 \left(1 - \frac{x^2}{4} \right) dx - \int_2^3 \left(1 - \frac{x^2}{4} \right) dx \\ &= \left[x - \frac{x^3}{12} \right]_{-2}^2 - \left[x - \frac{x^3}{12} \right]_2^3 \\ &= \left[\left(2 - \frac{2^3}{12} \right) - \left(-2 - \frac{(-2)^3}{12} \right) \right] - \left[\left(3 - \frac{3^3}{12} \right) - \left(2 - \frac{2^3}{12} \right) \right] \\ &= \left[\frac{4}{3} - \left(-\frac{4}{3} \right) \right] - \left[\frac{3}{4} - \frac{4}{3} \right] = \frac{13}{4} \end{aligned}$$

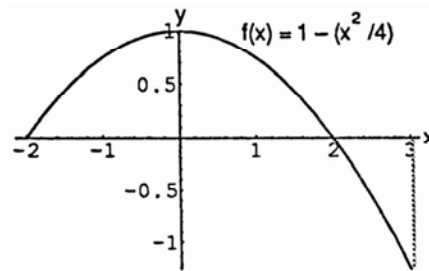

13. $5 - 5x^{2/3} = 0 \Rightarrow 1 - x^{2/3} = 0 \Rightarrow x = \pm 1$;

$$\begin{aligned} \text{Area} &= \int_{-1}^1 (5 - 5x^{2/3}) dx - \int_1^8 (5 - 5x^{2/3}) dx \\ &= \left[5x - 3x^{5/3} \right]_{-1}^1 - \left[5x - 3x^{5/3} \right]_1^8 \\ &= \left[\left(5(1) - 3(1)^{5/3} \right) - \left(5(-1) - 3(-1)^{5/3} \right) \right] \\ &\quad - \left[\left(5(8) - 3(8)^{5/3} \right) - \left(5(1) - 3(1)^{5/3} \right) \right] \\ &= [2 - (-2)] - [(40 - 96) - 2] = 62 \end{aligned}$$

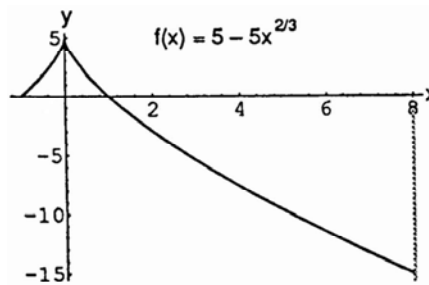

14. $1 - \sqrt{x} = 0 \Rightarrow x = 1$;

$$\begin{aligned} \text{Area} &= \int_0^1 (1 - \sqrt{x}) dx - \int_1^4 (1 - \sqrt{x}) dx \\ &= \left[x - \frac{2}{3} x^{3/2} \right]_0^1 - \left[x - \frac{2}{3} x^{3/2} \right]_1^4 \\ &= \left[\left(1 - \frac{2}{3} (1)^{3/2} \right) - 0 \right] - \left[\left(4 - \frac{2}{3} (4)^{3/2} \right) - \left(1 - \frac{2}{3} (1)^{3/2} \right) \right] \\ &= \frac{1}{3} - \left[\left(4 - \frac{16}{3} \right) - \frac{1}{3} \right] = 2 \end{aligned}$$

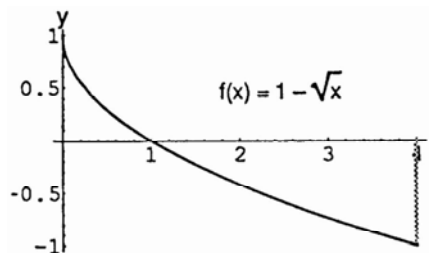

15. $f(x) = x, g(x) = \frac{1}{x^2}, a = 1, b = 2$
 $\Rightarrow A = \int_a^b [f(x) - g(x)] dx$
 $= \int_1^2 \left(x - \frac{1}{x^2}\right) dx = \left[\frac{x^2}{2} + \frac{1}{x}\right]_1^2 = \left(\frac{4}{2} + \frac{1}{2}\right) - \left(\frac{1}{2} + 1\right) = 1$

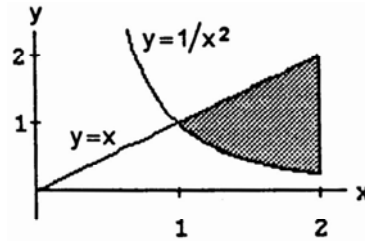

16. $f(x) = x, g(x) = \frac{1}{\sqrt{x}}, a = 1, b = 2$
 $\Rightarrow A = \int_a^b [f(x) - g(x)] dx$
 $\Rightarrow A = \int_1^2 \left(x - \frac{1}{\sqrt{x}}\right) dx = \left[\frac{x^2}{2} - 2\sqrt{x}\right]_1^2$
 $= \left(\frac{4}{2} - 2\sqrt{2}\right) - \left(\frac{1}{2} - 2\right) = \frac{7-4\sqrt{2}}{2}$

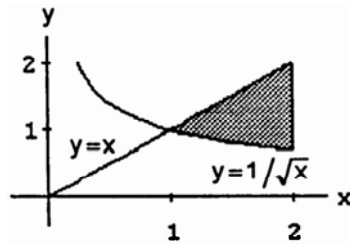

17. $f(x) = (1 - \sqrt{x})^2, g(x) = 0, a = 0, b = 1$
 $\Rightarrow A = \int_a^b [f(x) - g(x)] dx = \int_0^1 (1 - \sqrt{x})^2 dx = \int_0^1 (1 - 2\sqrt{x} + x) dx$
 $= \int_0^1 (1 - 2x^{1/2} + x) dx = \left[x - \frac{4}{3}x^{3/2} + \frac{x^2}{2}\right]_0^1 = 1 - \frac{4}{3} + \frac{1}{2} = \frac{1}{6}(6 - 8 + 3) = \frac{1}{6}$

18. $f(x) = (1 - x^3)^2, g(x) = 0, a = 0, b = 1$
 $\Rightarrow A = \int_a^b [f(x) - g(x)] dx = \int_0^1 (1 - x^3)^2 dx = \int_0^1 (1 - 2x^3 + x^6) dx$
 $= \left[x - \frac{x^4}{2} + \frac{x^7}{7}\right]_0^1 = 1 - \frac{1}{2} + \frac{1}{7} = \frac{9}{14}$

19. $f(y) = 2y^2, g(y) = 0, c = 0, d = 3$
 $\Rightarrow A = \int_c^d [f(y) - g(y)] dy = \int_0^3 (2y^2 - 0) dy$
 $= 2 \int_0^3 y^2 dy = \frac{2}{3} [y^3]_0^3 = 18$

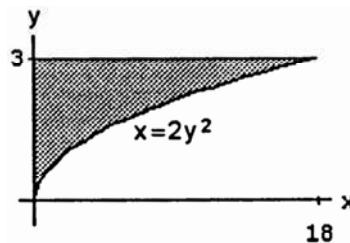

20. $f(y) = 4 - y^2, g(y) = 0, c = -2, d = 2$
 $\Rightarrow A = \int_c^d [f(y) - g(y)] dy = \int_{-2}^2 (4 - y^2) dy$
 $= \left[4y - \frac{y^3}{3}\right]_{-2}^2 = 2\left(8 - \frac{8}{3}\right) = \frac{32}{3}$

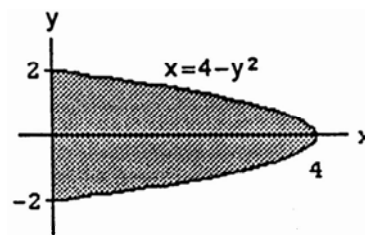

21. Let us find the intersection points: $\frac{y^2}{4} = \frac{y+2}{4}$
 $\Rightarrow y^2 - y - 2 = 0 \Rightarrow (y - 2)(y + 1) = 0 \Rightarrow y = -1$ or $y = 2$
 $\Rightarrow c = -1, d = 2; f(y) = \frac{y+2}{4}, g(y) = \frac{y^2}{4}$
 $\Rightarrow A = \int_c^d [f(y) - g(y)] dy = \int_{-1}^2 \left(\frac{y+2}{4} - \frac{y^2}{4}\right) dy$

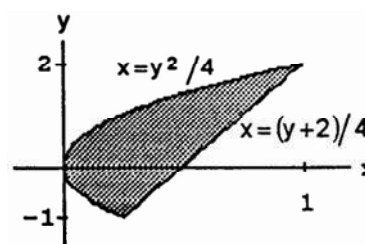

$$= \frac{1}{4} \int_{-1}^2 (y+2-y^2) dy = \frac{1}{4} \left[\frac{y^2}{2} + 2y - \frac{y^3}{3} \right]_{-1}^2$$

$$= \frac{1}{4} \left[\left(\frac{4}{2} + 4 - \frac{8}{3} \right) - \left(\frac{1}{2} - 2 + \frac{1}{3} \right) \right] = \frac{9}{8}$$

22. Let us find the intersection points: $\frac{y^2-4}{4} = \frac{y+16}{4}$
 $\Rightarrow y^2 - y - 20 = 0 \Rightarrow (y-5)(y+4) = 0 \Rightarrow y = -4$ or $y = 5$
 $\Rightarrow c = -4, d = 5; f(y) = \frac{y+16}{4}, g(y) = \frac{y^2-4}{4}$
 $\Rightarrow A = \int_c^d [f(y) - g(y)] dy = \int_{-4}^5 \left(\frac{y+16}{4} - \frac{y^2-4}{4} \right) dy$
 $= \frac{1}{4} \int_{-4}^5 (y+20-y^2) dy = \frac{1}{4} \left[\frac{y^2}{2} + 20y - \frac{y^3}{3} \right]_{-4}^5$
 $= \frac{1}{4} \left[\left(\frac{25}{2} + 100 - \frac{125}{3} \right) - \left(\frac{16}{2} - 80 + \frac{64}{3} \right) \right]$
 $= \frac{1}{4} \left(\frac{9}{2} + 180 - 63 \right) = \frac{1}{4} \left(\frac{9}{2} + 117 \right) = \frac{1}{8} (9 + 234) = \frac{243}{8}$

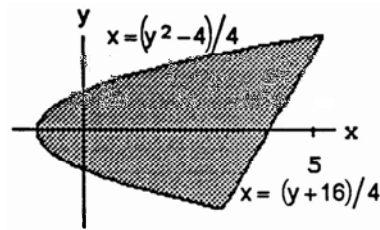

23. $f(x) = x, g(x) = \sin x, a = 0, b = \frac{\pi}{4}$
 $\Rightarrow A = \int_a^b [f(x) - g(x)] dx = \int_0^{\pi/4} (x - \sin x) dx$
 $= \left[\frac{x^2}{2} + \cos x \right]_0^{\pi/4} = \left(\frac{\pi^2}{32} + \frac{\sqrt{2}}{2} \right) - 1$

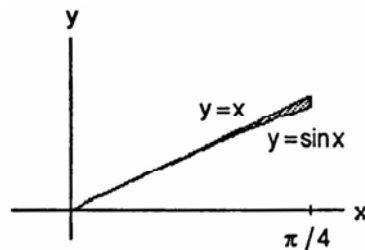

24. $f(x) = 1, g(x) = |\sin x|, a = -\frac{\pi}{2}, b = \frac{\pi}{2}$
 $\Rightarrow A = \int_a^b [f(x) - g(x)] dx = \int_{-\pi/2}^{\pi/2} (1 - |\sin x|) dx$
 $= \int_{-\pi/2}^0 (1 + \sin x) dx + \int_0^{\pi/2} (1 - \sin x) dx$
 $= 2 \int_0^{\pi/2} (1 - \sin x) dx = 2[x + \cos x]_0^{\pi/2}$
 $= 2 \left(\frac{\pi}{2} - 1 \right) = \pi - 2$

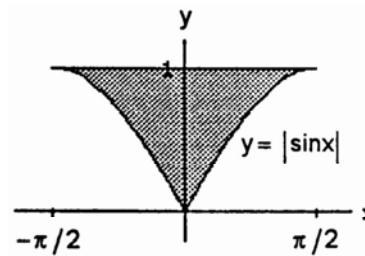

25. $a = 0, b = \pi, f(x) - g(x) = 2 \sin x - \sin 2x$
 $\Rightarrow A = \int_0^{\pi} (2 \sin x - \sin 2x) dx = \left[-2 \cos x + \frac{\cos 2x}{2} \right]_0^{\pi}$
 $= \left[-2 \cdot (-1) + \frac{1}{2} \right] - \left(-2 \cdot 1 + \frac{1}{2} \right) = 4$

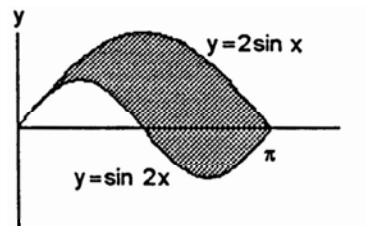

26. $a = -\frac{\pi}{3}, b = \frac{\pi}{3}, f(x) - g(x) = 8 \cos x - \sec^2 x$
 $\Rightarrow A = \int_{-\pi/3}^{\pi/3} (8 \cos x - \sec^2 x) dx = [8 \sin x - \tan x]_{-\pi/3}^{\pi/3}$
 $= \left(8 \cdot \frac{\sqrt{3}}{2} - \sqrt{3} \right) - \left(-8 \cdot \frac{\sqrt{3}}{2} + \sqrt{3} \right) = 6\sqrt{3}$

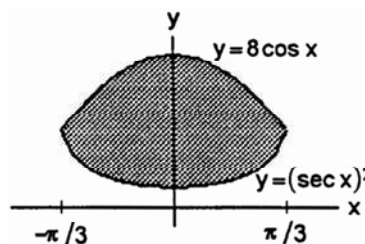

27. $f(y) = \sqrt{y}, g(y) = 2 - y, c = 1, d = 2$
 $\Rightarrow A = \int_c^d [f(y) - g(y)] dy = \int_1^2 [\sqrt{y} - (2 - y)] dy$
 $= \int_1^2 (\sqrt{y} - 2 + y) dy = \left[\frac{2}{3} y^{3/2} - 2y + \frac{y^2}{2} \right]_1^2$
 $= \left(\frac{4}{3} \sqrt{2} - 4 + 2 \right) - \left(\frac{2}{3} - 2 + \frac{1}{2} \right) = \frac{4}{3} \sqrt{2} - \frac{7}{6} = \frac{8\sqrt{2}-7}{6}$

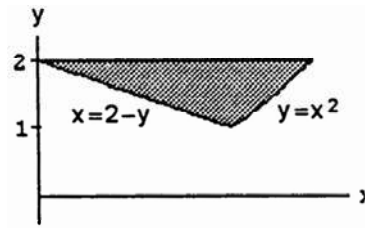

28. $f(y) = 6 - y, g(y) = y^2, c = 1, d = 2$
 $\Rightarrow A = \int_c^d [f(y) - g(y)] dy = \int_1^2 (6 - y - y^2) dy$
 $= \left[6y - \frac{y^2}{2} - \frac{y^3}{3} \right]_1^2 = \left(12 - 2 - \frac{8}{3} \right) - \left(6 - \frac{1}{2} - \frac{1}{3} \right)$
 $= 4 - \frac{7}{3} + \frac{1}{2} = \frac{24 - 14 + 3}{6} = \frac{13}{6}$

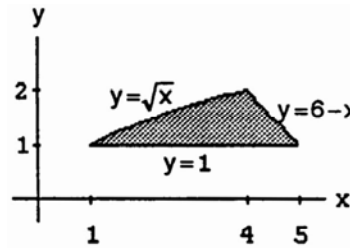

29. $f(x) = x^3 - 3x^2 = x^2(x - 3) \Rightarrow f'(x) = 3x^2 - 6x = 3x(x - 2) \Rightarrow f' = + + + | - - - - | + + + \Rightarrow f(0) = 0$ is a maximum and $f(2) = -4$ is a minimum. $A = -\int_0^3 (x^3 - 3x^2) dx = -\left[\frac{x^4}{4} - x^3 \right]_0^3 = -\left(\frac{81}{4} - 27 \right) = \frac{27}{4}$

30. $A = \int_0^a (a^{1/2} - x^{1/2})^2 dx = \int_0^a (a - 2\sqrt{ax}^{1/2} + x) dx = \left[ax - \frac{4}{3} \sqrt{ax}^{3/2} + \frac{x^2}{2} \right]_0^a = a^2 - \frac{4}{3} \sqrt{a} \cdot a \sqrt{a} + \frac{a^2}{2} = a^2 \left(1 - \frac{4}{3} + \frac{1}{2} \right) = \frac{a^2}{6} (6 - 8 + 3) = \frac{a^2}{6}$

31. The area above the x-axis is $A_1 = \int_0^1 (y^{2/3} - y) dy$
 $= \left[\frac{3y^{5/3}}{5} - \frac{y^2}{2} \right]_0^1 = \frac{1}{10}$; the area below the x-axis is
 $A_2 = \int_{-1}^0 (y^{2/3} - y) dy = \left[\frac{3y^{5/3}}{5} - \frac{y^2}{2} \right]_{-1}^0 = \frac{11}{10} \Rightarrow$ the total area is $A_1 + A_2 = \frac{6}{5}$

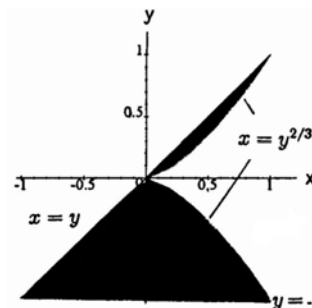

32. $A = \int_0^{\pi/4} (\cos x - \sin x) dx + \int_{\pi/4}^{5\pi/4} (\sin x - \cos x) dx$
 $+ \int_{5\pi/4}^{3\pi/2} (\cos x - \sin x) dx$
 $= [\sin x + \cos x]_0^{\pi/4} + [-\cos x - \sin x]_{\pi/4}^{5\pi/4}$
 $+ [\sin x + \cos x]_{5\pi/4}^{3\pi/2}$
 $= \left[\left(\frac{\sqrt{2}}{2} + \frac{\sqrt{2}}{2} \right) - (0 + 1) \right] + \left[\left(\frac{\sqrt{2}}{2} + \frac{\sqrt{2}}{2} \right) - \left(-\frac{\sqrt{2}}{2} - \frac{\sqrt{2}}{2} \right) \right]$
 $+ \left[(-1 + 0) - \left(-\frac{\sqrt{2}}{2} - \frac{\sqrt{2}}{2} \right) \right] = \frac{8\sqrt{2}}{2} - 2 = 4\sqrt{2} - 2$

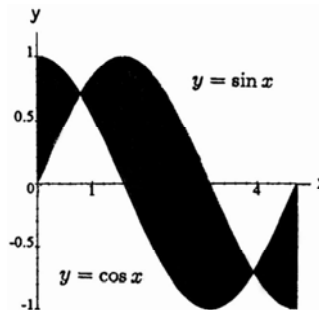

33. $A = \int_1^e \frac{2 \ln x}{x} dx = \int_0^1 2u du = [u^2]_0^1 = 1$, where $u = \ln x$ and $du = \frac{1}{x} dx$; $x = 1 \Rightarrow u = 0$, $x = e \Rightarrow u = 1$
34. (a) $A_1 = \int_{10}^{20} \frac{1}{x} dx = [\ln|x|]_{10}^{20} = \ln 20 - \ln 10 = \ln \frac{20}{10} = \ln 2$, and $A_2 = \int_1^2 \frac{1}{x} dx = [\ln|x|]_1^2 = \ln 2 - \ln 1 = \ln 2$
 (b) $A_1 = \int_{ka}^{kb} \frac{1}{x} dx = [\ln|x|]_{ka}^{kb} = \ln kb - \ln ka = \ln \frac{kb}{ka} = \ln \frac{b}{a} = \ln b - \ln a$, and $A_2 = \int_a^b \frac{1}{x} dx = [\ln|x|]_a^b = \ln b - \ln a$
35. $y = x^2 + \int_1^x \frac{1}{t} dt \Rightarrow \frac{dy}{dx} = 2x + \frac{1}{x} \Rightarrow \frac{d^2y}{dx^2} = 2 - \frac{1}{x^2}$; $y(1) = 1 + \int_1^1 \frac{1}{t} dt = 1$ and $y'(1) = 2 + 1 = 3$
36. $y = \int_0^x (1 + 2\sqrt{\sec t}) dt \Rightarrow \frac{dy}{dx} = 1 + 2\sqrt{\sec x} \Rightarrow \frac{d^2y}{dx^2} = 2\left(\frac{1}{2}\right)(\sec x)^{-1/2}(\sec x \tan x) = \sqrt{\sec x}(\tan x)$;
 $x = 0 \Rightarrow y = \int_0^0 (1 + 2\sqrt{\sec t}) dt = 0$ and $x = 0 \Rightarrow \frac{dy}{dx} = 1 + 2\sqrt{\sec 0} = 3$
37. $y = \int_5^x \frac{\sin t}{t} dt - 3 \Rightarrow \frac{dy}{dx} = \frac{\sin x}{x}$; $x = 5 \Rightarrow y = \int_5^5 \frac{\sin t}{t} dt - 3 = -3$
38. $y = \int_{-1}^x \sqrt{2 - \sin^2 t} dt + 2$ so that $\frac{dy}{dx} = \sqrt{2 - \sin^2 x}$; $x = -1 \Rightarrow y = \int_{-1}^{-1} \sqrt{2 - \sin^2 t} dt + 2 = 2$
39. $\frac{dy}{dx} = \frac{1}{\sqrt{1-x^2}} \Rightarrow dy = \frac{dx}{\sqrt{1-x^2}} \Rightarrow y = \sin^{-1} x + C$; $x = 0$ and $y = 0 \Rightarrow 0 = \sin^{-1} 0 + C \Rightarrow C = 0 \Rightarrow y = \sin^{-1} x$
40. $\frac{dy}{dx} = \frac{1}{x^2+1} - 1 \Rightarrow dy = \left(\frac{1}{1+x^2} - 1\right) dx \Rightarrow y = \tan^{-1}(x) - x + C$;
 $x = 0$ and $y = 1 \Rightarrow 1 = \tan^{-1} 0 - 0 + C \Rightarrow C = 1 \Rightarrow y = \tan^{-1}(x) - x + 1$
41. $\frac{dy}{dx} = \frac{1}{x\sqrt{x^2-1}} \Rightarrow dy = \frac{dx}{x\sqrt{x^2-1}} \Rightarrow y = \sec^{-1}|x| + C$;
 $x = 2$ and $y = \pi \Rightarrow \pi = \sec^{-1} 2 + C \Rightarrow C = \pi - \sec^{-1} 2 = \pi - \frac{\pi}{3} = \frac{2\pi}{3} \Rightarrow y = \sec^{-1}(x) + \frac{2\pi}{3}$, $x > 1$
42. $\frac{dy}{dx} = \frac{1}{1+x^2} - \frac{2}{\sqrt{1-x^2}} \Rightarrow dy = \left(\frac{1}{1+x^2} - \frac{2}{\sqrt{1-x^2}}\right) dx \Rightarrow y = \tan^{-1} x - 2 \sin^{-1} x + C$;
 $x = 0$ and $y = 2 \Rightarrow 2 = \tan^{-1} 0 - 2 \sin^{-1} 0 + C \Rightarrow C = 2 \Rightarrow y = \tan^{-1} x - 2 \sin^{-1} x + 2$
43. Let $u = \cos x \Rightarrow du = -\sin x dx \Rightarrow -du = \sin x dx$
 $\int 2(\cos x)^{-1/2} \sin x dx = \int 2u^{-1/2} (-du) = -2 \int u^{-1/2} du = -2 \left(\frac{u^{1/2}}{1/2}\right) + C = -4u^{1/2} + C = -4(\cos x)^{1/2} + C$
44. Let $u = \tan x \Rightarrow du = \sec^2 x dx$
 $\int (\tan x)^{-3/2} \sec^2 x dx = \int u^{-3/2} du = \frac{u^{-1/2}}{(-1/2)} + C = -2u^{-1/2} + C = \frac{-2}{(\tan x)^{1/2}} + C$

45. Let $u = 2\theta + 1 \Rightarrow du = 2 d\theta \Rightarrow \frac{1}{2} du = d\theta$

$$\int [2\theta + 1 + 2 \cos(2\theta + 1)] d\theta = \int (u + 2 \cos u) \left(\frac{1}{2} du\right) = \frac{u^2}{4} + \sin u + C_1 = \frac{(2\theta + 1)^2}{4} + \sin(2\theta + 1) + C_1$$

$$= \theta^2 + \theta + \sin(2\theta + 1) + C, \text{ where } C = C_1 + \frac{1}{4} \text{ is still an arbitrary constant}$$

46. Let $u = 2\theta - \pi \Rightarrow du = 2 d\theta \Rightarrow \frac{1}{2} du = d\theta$

$$\int \left(\frac{1}{\sqrt{2\theta - \pi}} + 2 \sec^2(2\theta - \pi)\right) d\theta = \int \left(\frac{1}{\sqrt{u}} + 2 \sec^2 u\right) \left(\frac{1}{2} du\right) = \frac{1}{2} \int (u^{-1/2} + 2 \sec^2 u) du = \frac{1}{2} \left(\frac{u^{1/2}}{\frac{1}{2}}\right) + \frac{1}{2} (2 \tan u) + C$$

$$= u^{1/2} + \tan u + C = (2\theta - \pi)^{1/2} + \tan(2\theta - \pi) + C$$

47. $\int \left(t - \frac{2}{t}\right) \left(t + \frac{2}{t}\right) dt = \int \left(t^2 - \frac{4}{t^2}\right) dt = \int (t^2 - 4t^{-2}) dt = \frac{t^3}{3} - 4 \left(\frac{t^{-1}}{-1}\right) + C = \frac{t^3}{3} + \frac{4}{t} + C$

48. $\int \frac{(t+1)^2 - 1}{t^4} dt = \int \frac{t^2 + 2t}{t^4} dt = \int \left(\frac{1}{t^2} + \frac{2}{t^3}\right) dt = \int (t^{-2} + 2t^{-3}) dt = \frac{t^{-1}}{(-1)} + 2 \left(\frac{t^{-2}}{-2}\right) + C = -\frac{1}{t} - \frac{1}{t^2} + C$

49. Let $u = 2t^{3/2} \Rightarrow du = 3\sqrt{t} dt \Rightarrow \frac{1}{3} du = \sqrt{t} dt$

$$\int \sqrt{t} \sin(2t^{3/2}) dt = \frac{1}{3} \int \sin u du = -\frac{1}{3} \cos u + C = -\frac{1}{3} \cos(2t^{3/2}) + C$$

50. Let $u = 1 + \sec \theta \Rightarrow du = \sec \theta \tan \theta d\theta \Rightarrow \int \sec \theta \tan \theta \sqrt{1 + \sec \theta} d\theta = \int u^{1/2} du = \frac{2}{3} u^{3/2} + C = \frac{2}{3} (1 + \sec \theta)^{3/2} + C$

51. $\int e^x \sec^2(e^x - 7) dx = \int \sec^2 u du$, where $u = e^x - 7$ and $du = e^x dx$

$$= \tan u + C = \tan(e^x - 7) + C$$

52. $\int e^y \csc(e^y + 1) \cot(e^y + 1) dy = \int \csc u \cot u du$, where $u = e^y + 1$ and $du = e^y dy$

$$= -\csc u + C = -\csc(e^y + 1) + C$$

53. $\int (\sec^2 x) e^{\tan x} dx = \int e^u du$, where $u = \tan x$ and $du = \sec^2 x dx$

$$= e^u + C = e^{\tan x} + C$$

54. $\int (\csc^2 x) e^{\cot x} dx = -\int e^u du$, where $u = \cot x$ and $du = -\csc^2 x dx$

$$= -e^u + C = -e^{\cot x} + C$$

55. $\int_{-1}^1 \frac{1}{3x-4} dx = \frac{1}{3} \int_{-7}^{-1} \frac{1}{u} du$, where $u = 3x - 4$, $du = 3 dx$; $x = -1 \Rightarrow u = -7$, $x = 1 \Rightarrow u = -1$

$$= \frac{1}{3} [\ln|u|]_{-7}^{-1} = \frac{1}{3} [\ln|-1| - \ln|-7|] = \frac{1}{3} [0 - \ln 7] = -\frac{\ln 7}{3}$$

56. $\int_1^e \frac{\sqrt{\ln x}}{x} dx = \int_0^1 u^{1/2} du$, where $u = \ln x$, $du = \frac{1}{x} dx$; $x = 1 \Rightarrow u = 0$, $x = e \Rightarrow u = 1$

$$= \left[\frac{2}{3} u^{3/2}\right]_0^1 = \left[\frac{2}{3} 1^{3/2} - \frac{2}{3} 0^{3/2}\right] = \frac{2}{3}$$

$$57. \int_0^4 \frac{2t}{t^2-25} dt = \int_{-25}^{-9} \frac{1}{u} du, \text{ where } u = t^2 - 25, du = 2t dt, t = 0 \Rightarrow u = -25, t = 4 \Rightarrow u = -9$$

$$= \left[\ln |u| \right]_{-25}^{-9} = \ln |-9| - \ln |-25| = \ln 9 - \ln 25 = \ln \frac{9}{25}$$

$$58. \int \frac{\tan(\ln v)}{v} dv = \int \tan u du = \int \frac{\sin u}{\cos u} du, \text{ where } u = \ln v \text{ and } du = \frac{1}{v} dv$$

$$= -\ln |\cos u| + C = -\ln |\cos(\ln v)| + C$$

$$59. \int \frac{(\ln x)^{-3}}{x} dx = \int u^{-3} du, \text{ where } u = \ln x \text{ and } du = \frac{1}{x} dx$$

$$= \frac{u^{-2}}{-2} + C = -\frac{1}{2} (\ln x)^{-2} + C$$

$$60. \int \frac{1}{r} \csc^2(1 + \ln r) dr = \int \csc^2 u du, \text{ where } u = 1 + \ln r \text{ and } du = \frac{1}{r} dr$$

$$= -\cot u + C = -\cot(1 + \ln r) + C$$

$$61. \int x 3^{x^2} dx = \frac{1}{2} \int 3^u du, \text{ where } u = x^2 \text{ and } du = 2x dx$$

$$= \frac{1}{2 \ln 3} (3^u) + C = \frac{1}{2 \ln 3} (3^{x^2}) + C$$

$$62. \int 2^{\tan x} \sec^2 x dx = \int 2^u du, \text{ where } u = \tan x \text{ and } du = \sec^2 x dx$$

$$= \frac{1}{\ln 2} (2^u) + C = \frac{2^{\tan x}}{\ln 2} + C$$

$$63. \int \frac{3 dr}{\sqrt{1-4(r-1)^2}} = \frac{3}{2} \int \frac{du}{\sqrt{1-u^2}}, \text{ where } u = 2(r-1) \text{ and } du = 2 dr$$

$$= \frac{3}{2} \sin^{-1} u + C = \frac{3}{2} \sin^{-1} 2(r-1) + C$$

$$64. \int \frac{6 dr}{\sqrt{4-(r+1)^2}} = 6 \int \frac{du}{\sqrt{4-u^2}}, \text{ where } u = r+1 \text{ and } du = dr$$

$$= 6 \sin^{-1} \frac{u}{2} + C = 6 \sin^{-1} \left(\frac{r+1}{2} \right) + C$$

$$65. \int \frac{dx}{2+(x-1)^2} = \int \frac{du}{2+u^2}, \text{ where } u = x-1 \text{ and } du = dx$$

$$= \frac{1}{\sqrt{2}} \tan^{-1} \frac{u}{\sqrt{2}} + C = \frac{1}{\sqrt{2}} \tan^{-1} \left(\frac{x-1}{\sqrt{2}} \right) + C$$

$$66. \int \frac{dx}{1+(3x+1)^2} = \frac{1}{3} \int \frac{du}{1+u^2}, \text{ where } u = 3x+1 \text{ and } du = 3 dx$$

$$= \frac{1}{3} \tan^{-1} u + C = \frac{1}{3} \tan^{-1} (3x+1) + C$$

$$67. \int \frac{dx}{(2x-1)\sqrt{(2x-1)^2-4}} = \frac{1}{2} \int \frac{du}{u\sqrt{u^2-4}}, \text{ where } u = 2x-1 \text{ and } du = 2 dx$$

$$= \frac{1}{2} \cdot \frac{1}{2} \sec^{-1} \left| \frac{u}{2} \right| + C = \frac{1}{4} \sec^{-1} \left| \frac{2x-1}{2} \right| + C$$

$$68. \int \frac{dx}{(x+3)\sqrt{(x+3)^2-25}} = \int \frac{du}{u\sqrt{u^2-25}}, \text{ where } u = x+3 \text{ and } du = dx$$

$$= \frac{1}{5} \sec^{-1} \left| \frac{u}{5} \right| + C = \frac{1}{5} \sec^{-1} \left| \frac{x+3}{5} \right| + C$$

$$69. \int \frac{e^{\sin^{-1} \sqrt{x}}}{2\sqrt{x-x^2}} dx = \int e^u du, \text{ where } u = \sin^{-1} \sqrt{x} \text{ and } du = \frac{dx}{2\sqrt{x-x^2}}$$

$$= e^u + C = e^{\sin^{-1} \sqrt{x}} + C$$

$$70. \int \frac{\sqrt{\sin^{-1} x}}{\sqrt{1-x^2}} dx = \int u^{1/2} du, \text{ where } u = \sin^{-1} x \text{ and } du = \frac{dx}{\sqrt{1-x^2}}$$

$$= \frac{2}{3} u^{3/2} + C = \frac{2}{3} (\sin^{-1} x)^{3/2} + C$$

$$71. \int \frac{1}{\sqrt{\tan^{-1} y(1+y^2)}} dy = \int \frac{\left(\frac{1}{1+y^2}\right)}{\sqrt{\tan^{-1} y}} dy = \int u^{-1/2} du, \text{ where } u = \tan^{-1} y \text{ and } du = \frac{dy}{1+y^2}$$

$$= 2u^{1/2} + C = 2\sqrt{\tan^{-1} y} + C$$

$$72. \int \frac{(\tan^{-1} x)^2}{1+x^2} dx = \int u^2 du, \text{ where } u = \tan^{-1} x \text{ and } du = \frac{dx}{1+x^2}$$

$$= \frac{1}{3} u^3 + C = \frac{1}{3} (\tan^{-1} x)^3 + C$$

$$73. \int_{-1}^1 (3x^2 - 4x + 7) dx = [x^3 - 2x^2 + 7x]_{-1}^1 = [1^3 - 2(1)^2 + 7(1)] - [(-1)^3 - 2(-1)^2 + 7(-1)] = 6 - (-10) = 16$$

$$74. \int_0^1 (8s^3 - 12s^2 + 5) ds = [2s^4 - 4s^3 + 5s]_0^1 = [2(1)^4 - 4(1)^3 + 5(1)] - 0 = 3$$

$$75. \int_1^2 \frac{4}{v^2} dv = \int_1^2 4v^{-2} dv = [-4v^{-1}]_1^2 = \left(-\frac{4}{2}\right) - \left(-\frac{4}{1}\right) = 2$$

$$76. \int_1^{27} x^{-4/3} dx = [-3x^{-1/3}]_1^{27} = -3(27)^{-1/3} - (-3(1)^{-1/3}) = -3\left(\frac{1}{3}\right) + 3(1) = 2$$

$$77. \int_1^4 \frac{dt}{t\sqrt{t}} = \int_1^4 \frac{dt}{t^{3/2}} = \int_1^4 t^{-3/2} dt = [-2t^{-1/2}]_1^4 = \frac{-2}{\sqrt{4}} - \frac{(-2)}{\sqrt{1}} = 1$$

$$78. \text{ Let } x = 1 + \sqrt{u} \Rightarrow dx = \frac{1}{2} u^{-1/2} du \Rightarrow 2 dx = \frac{du}{\sqrt{u}}; u = 1 \Rightarrow x = 2, u = 4 \Rightarrow x = 3$$

$$\int_1^4 \frac{(1+\sqrt{u})^{1/2}}{\sqrt{u}} du = \int_2^3 x^{1/2} (2 dx) = \left[2\left(\frac{2}{3}\right)x^{3/2}\right]_2^3 = \frac{4}{3}(3^{3/2}) - \frac{4}{3}(2^{3/2}) = 4\sqrt{3} - \frac{8}{3}\sqrt{2} = \frac{4}{3}(3\sqrt{3} - 2\sqrt{2})$$

$$79. \text{ Let } u = 2x + 1 \Rightarrow du = 2 dx \Rightarrow 18 du \Rightarrow 36 dx; x = 0 \Rightarrow u = 1, x = 1 \Rightarrow u = 3$$

$$\int_0^1 \frac{36 dx}{(2x+1)^3} = \int_1^3 18u^{-3} du = \left[\frac{18u^{-2}}{-2}\right]_1^3 = \left[\frac{-9}{u^2}\right]_1^3 = \left(\frac{-9}{3^2}\right) - \left(\frac{-9}{1^2}\right) = 8$$

80. Let $u = 7 - 5r \Rightarrow du = -5 dr \Rightarrow -\frac{1}{5} du = dr$; $r = 0 \Rightarrow u = 7$, $r = 1 \Rightarrow u = 2$

$$\int_0^1 \frac{dr}{\sqrt[3]{(7-5r)^2}} = \int_0^1 (7-5r)^{-2/3} du = \int_7^2 u^{-2/3} \left(-\frac{1}{5} du\right) = -\frac{1}{5} [3u^{1/3}]_7^2 = \frac{3}{5} (\sqrt[3]{7} - \sqrt[3]{2})$$
81. Let $u = 1 - x^{2/3} \Rightarrow du = -\frac{2}{3} x^{-1/3} dx \Rightarrow -\frac{3}{2} du = x^{-1/3} dx$; $x = \frac{1}{8} \Rightarrow u = 1 - \left(\frac{1}{8}\right)^{2/3} = \frac{3}{4}$, $x = 1 \Rightarrow u = 1 - 1^{2/3} = 0$

$$\int_{1/8}^1 x^{-1/3} (1 - x^{2/3})^{3/2} dx = \int_{3/4}^0 u^{3/2} \left(-\frac{3}{2} du\right) = \left[\left(-\frac{3}{2}\right) \left(\frac{u^{5/2}}{5/2}\right) \right]_{3/4}^0 = \left[-\frac{3}{5} u^{5/2} \right]_{3/4}^0$$

$$= -\frac{3}{5} (0)^{5/2} - \left(-\frac{3}{5}\right) \left(\frac{3}{4}\right)^{5/2} = \frac{27\sqrt{3}}{160}$$
82. Let $u = 1 + 9x^4 \Rightarrow du = 36x^3 dx \Rightarrow \frac{1}{36} du = x^3 dx$; $x = 0 \Rightarrow u = 1$, $x = \frac{1}{2} \Rightarrow u = 1 + 9\left(\frac{1}{2}\right)^4 = \frac{25}{16}$

$$\int_0^{1/2} x^3 (1 + 9x^4)^{-3/2} dx = \int_1^{25/16} u^{-3/2} \left(\frac{1}{36} du\right) = \left[\frac{1}{36} \left(\frac{u^{-1/2}}{-1/2}\right) \right]_1^{25/16} = \left[-\frac{1}{18} u^{-1/2} \right]_1^{25/16}$$

$$= -\frac{1}{18} \left(\frac{25}{16}\right)^{-1/2} - \left(-\frac{1}{18}\right) (1)^{-1/2} = \frac{1}{90}$$
83. Let $u = 5r \Rightarrow du = 5 dr \Rightarrow \frac{1}{5} du = dr$; $r = 0 \Rightarrow u = 0$, $r = \pi \Rightarrow u = 5\pi$

$$\int_0^\pi \sin^2 5r dr = \int_0^{5\pi} (\sin^2 u) \left(\frac{1}{5} du\right) = \frac{1}{5} \left[\frac{u}{2} - \frac{\sin 2u}{4} \right]_0^{5\pi} = \left(\frac{\pi}{2} - \frac{\sin 10\pi}{20}\right) - \left(0 - \frac{\sin 0}{20}\right) = \frac{\pi}{2}$$
84. Let $u = 4t - \frac{\pi}{4} \Rightarrow du = 4 dt \Rightarrow \frac{1}{4} du = dt$; $t = 0 \Rightarrow u = -\frac{\pi}{4}$, $t = \frac{\pi}{4} \Rightarrow u = \frac{3\pi}{4}$

$$\int_0^{\pi/4} \cos^2 \left(4t - \frac{\pi}{4}\right) dt = \int_{-\pi/4}^{3\pi/4} (\cos^2 u) \left(\frac{1}{4} du\right) = \frac{1}{4} \left[\frac{u}{2} + \frac{\sin 2u}{4} \right]_{-\pi/4}^{3\pi/4} = \frac{1}{4} \left(\frac{3\pi}{8} + \frac{\sin\left(\frac{3\pi}{2}\right)}{4} \right) - \frac{1}{4} \left(-\frac{\pi}{8} + \frac{\sin\left(-\frac{\pi}{2}\right)}{4} \right)$$

$$= \frac{\pi}{8} - \frac{1}{16} + \frac{1}{16} = \frac{\pi}{8}$$
85.
$$\int_0^{\pi/3} \sec^2 \theta d\theta = [\tan \theta]_0^{\pi/3} = \tan \frac{\pi}{3} - \tan 0 = \sqrt{3}$$
86.
$$\int_{\pi/4}^{3\pi/4} \csc^2 x dx = [-\cot x]_{\pi/4}^{3\pi/4} = \left(-\cot \frac{3\pi}{4}\right) - \left(-\cot \frac{\pi}{4}\right) = 2$$
87. Let $u = \frac{x}{6} \Rightarrow du = \frac{1}{6} dx \Rightarrow 6 du = dx$; $x = \pi \Rightarrow u = \frac{\pi}{6}$, $x = 3\pi \Rightarrow u = \frac{\pi}{2}$

$$\int_\pi^{3\pi} \cot^2 \frac{x}{6} dx = \int_{\pi/6}^{\pi/2} 6 \cot^2 u du = 6 \int_{\pi/6}^{\pi/2} (\csc^2 u - 1) du = [6(-\cot u - u)]_{\pi/6}^{\pi/2} =$$

$$6\left(-\cot \frac{\pi}{2} - \frac{\pi}{2}\right) - 6\left(-\cot \frac{\pi}{6} - \frac{\pi}{6}\right) = 6\sqrt{3} - 2\pi$$
88. Let $u = \frac{\theta}{3} \Rightarrow du = \frac{1}{3} d\theta \Rightarrow 3 du = d\theta$; $\theta = 0 \Rightarrow u = 0$, $\theta = \pi \Rightarrow u = \frac{\pi}{3}$

$$\int_0^\pi \tan^2 \frac{\theta}{3} d\theta = \int_0^\pi \left(\sec^2 \frac{\theta}{3} - 1\right) d\theta = \int_0^{\pi/3} 3(\sec^2 u - 1) du = [3 \tan u - 3u]_0^{\pi/3} = \left[3 \tan \frac{\pi}{3} - 3\left(\frac{\pi}{3}\right)\right] - (3 \tan 0 - 0)$$

$$= 3\sqrt{3} - \pi$$
89.
$$\int_{-\pi/3}^0 \sec x \tan x dx = [\sec x]_{-\pi/3}^0 = \sec 0 - \sec\left(-\frac{\pi}{3}\right) = 1 - 2 = -1$$

$$90. \int_{\pi/4}^{3\pi/4} \csc z \cot z \, dz = [-\csc z]_{\pi/4}^{3\pi/4} = \left(-\csc \frac{3\pi}{4}\right) - \left(-\csc \frac{\pi}{4}\right) = -\sqrt{2} + \sqrt{2} = 0$$

$$91. \text{ Let } u = \sin x \Rightarrow du = \cos x \, dx; x = 0 \Rightarrow u = 0, x = \frac{\pi}{2} \Rightarrow u = 1$$

$$\int_0^{\pi/2} 5(\sin x)^{3/2} \cos x \, dx = \int_0^1 5u^{3/2} \, du = \left[5\left(\frac{2}{5}\right)u^{5/2}\right]_0^1 = [2u^{5/2}]_0^1 = 2(1)^{5/2} - 2(0)^{5/2} = 2$$

$$92. \text{ Let } u = \sin 3x \Rightarrow du = 3 \cos 3x \, dx \Rightarrow \frac{1}{3} du = \cos 3x \, dx; x = -\frac{\pi}{2} \Rightarrow u = \sin\left(-\frac{3\pi}{2}\right) = 1, x = \frac{\pi}{2} \Rightarrow u = \sin\left(\frac{3\pi}{2}\right) = -1$$

$$\int_{-\pi/2}^{\pi/2} 15 \sin^4 3x \cos 3x \, dx = \int_1^{-1} 5u^4 \left(\frac{1}{3} du\right) = \int_1^{-1} 5u^4 \, du = [u^5]_1^{-1} = (-1)^5 - (1)^5 = -2$$

$$93. \text{ Let } u = 1 + 3 \sin^2 x \Rightarrow du = 6 \sin x \cos x \, dx \Rightarrow \frac{1}{2} du = 3 \sin x \cos x \, dx; x = 0 \Rightarrow u = 1, x = \frac{\pi}{2} \Rightarrow u = 1 + 3 \sin^2 \frac{\pi}{2} = 4$$

$$\int_0^{\pi/2} \frac{3 \sin x \cos x}{\sqrt{1+3 \sin^2 x}} \, dx = \int_1^4 \frac{1}{\sqrt{u}} \left(\frac{1}{2} du\right) = \int_1^4 \frac{1}{2} u^{-1/2} \, du = \left[\frac{1}{2} \left(\frac{u^{1/2}}{\frac{1}{2}}\right)\right]_1^4 = [u^{1/2}]_1^4 = 4^{1/2} - 1^{1/2} = 1$$

$$94. \text{ Let } u = 1 + 7 \tan x \Rightarrow du = 7 \sec^2 x \, dx \Rightarrow \frac{1}{7} du = \sec^2 x \, dx; x = 0 \Rightarrow u = 1 + 7 \tan 0 = 1, x = \frac{\pi}{4} \Rightarrow u = 1 + 7 \tan \frac{\pi}{4} = 8$$

$$\int_0^{\pi/4} \frac{\sec^2 x}{(1+7 \tan x)^{2/3}} \, dx = \int_1^8 \frac{1}{u^{2/3}} \left(\frac{1}{7} du\right) = \int_1^8 \frac{1}{7} u^{-2/3} \, du = \left[\frac{1}{7} \left(\frac{u^{1/3}}{\frac{1}{3}}\right)\right]_1^8 = \left[\frac{3}{7} u^{1/3}\right]_1^8 = \frac{3}{7}(8)^{1/3} - \frac{3}{7}(1)^{1/3} = \frac{3}{7}$$

$$95. \int_1^4 \left(\frac{x}{8} + \frac{1}{2x}\right) dx = \frac{1}{2} \int_1^4 \left(\frac{1}{4}x + \frac{1}{x}\right) dx = \frac{1}{2} \left[\frac{1}{8}x^2 + \ln|x|\right]_1^4 = \frac{1}{2} \left[\left(\frac{16}{8} + \ln 4\right) - \left(\frac{1}{8} + \ln 1\right)\right] = \frac{15}{16} + \frac{1}{2} \ln 4$$

$$= \frac{15}{16} + \ln \sqrt{4} = \frac{15}{16} + \ln 2$$

$$96. \int_1^8 \left(\frac{2}{3x} - \frac{8}{x^2}\right) dx = \frac{2}{3} \int_1^8 \left(\frac{1}{x} - 12x^{-2}\right) dx = \frac{2}{3} \left[\ln|x| + 12x^{-1}\right]_1^8 = \frac{2}{3} \left[(\ln 8 + \frac{12}{8}) - (\ln 1 + 12)\right] = \frac{2}{3} \left(\ln 8 + \frac{3}{2} - 12\right)$$

$$= \frac{2}{3} \left(\ln 8 - \frac{21}{2}\right) = \frac{2}{3} (\ln 8) - 7 = \ln(8^{2/3}) - 7 = \ln 4 - 7$$

$$97. \int_{-2}^{-1} e^{-(x+1)} \, dx = -\int_1^0 e^u \, du, \text{ where } u = -(x+1), du = -dx; x = -2 \Rightarrow u = 1, x = -1 \Rightarrow u = 0$$

$$= -[e^u]_1^0 = -(e^0 - e^1) = e - 1$$

$$98. \int_{-\ln 2}^0 e^{2w} \, dw = \frac{1}{2} \int_{\ln(1/4)}^0 e^u \, du, \text{ where } u = 2w, du = 2 \, dw; w = -\ln 2 \Rightarrow u = \ln \frac{1}{4}, w = 0 \Rightarrow u = 0$$

$$= \frac{1}{2} [e^u]_{\ln(1/4)}^0 = \frac{1}{2} [e^0 - e^{\ln(1/4)}] = \frac{1}{2} \left(1 - \frac{1}{4}\right) = \frac{3}{8}$$

$$99. \int_1^{\ln 5} e^r (3e^r + 1)^{-3/2} \, dr = \frac{1}{3} \int_4^{16} u^{-3/2} \, du, \text{ where } u = 3e^r + 1, du = 3e^r \, dr; r = 0 \Rightarrow u = 4, r = \ln 5 \Rightarrow u = 16$$

$$= -\frac{2}{3} [u^{-1/2}]_4^{16} = -\frac{2}{3} (16^{-1/2} - 4^{-1/2}) = \left(-\frac{2}{3}\right) \left(\frac{1}{4} - \frac{1}{2}\right) = \left(-\frac{2}{3}\right) \left(-\frac{1}{4}\right) = \frac{1}{6}$$

$$100. \int_0^{\ln 9} e^\theta (e^\theta - 1)^{1/2} \, d\theta = \int_0^8 u^{1/2} \, du, \text{ where } u = e^\theta - 1, du = e^\theta \, d\theta; \theta = 0 \Rightarrow u = 0, \theta = \ln 9 \Rightarrow u = 8$$

$$= \frac{2}{3} [u^{3/2}]_0^8 = \frac{2}{3} (8^{3/2} - 0^{3/2}) = \frac{2}{3} (2^{9/2} - 0) = \frac{2^{11/2}}{3} = \frac{32\sqrt{2}}{3}$$

101. $\int_1^e \frac{1}{x}(1+7\ln x)^{-1/3} dx = \frac{1}{7} \int_1^8 u^{-1/3} du$, where $u = 1 + 7 \ln x$, $du = \frac{7}{x} dx$, $x = 1 \Rightarrow u = 1$, $x = e \Rightarrow u = 8$
 $= \frac{3}{14} [u^{2/3}]_1^8 = \frac{3}{14} (8^{2/3} - 1^{2/3}) = \left(\frac{3}{14}\right)(4 - 1) = \frac{9}{14}$
102. $\int_1^3 \frac{[\ln(v+1)]^2}{v+1} dv = \int_1^3 [\ln(v+1)]^2 \frac{1}{v+1} dv = \int_{\ln 2}^{\ln 4} u^2 du$, where $u = \ln(v+1)$, $du = \frac{1}{v+1} dv$; $v = 1 \Rightarrow u = \ln 2$, $v = 3$
 $\Rightarrow u = \ln 4$;
 $= \frac{1}{3} [u^3]_{\ln 2}^{\ln 4} = \frac{1}{3} [(\ln 4)^3 - (\ln 2)^3] = \frac{1}{3} [(2 \ln 2)^3 - (\ln 2)^3] = \frac{(\ln 2)^3}{3} (8 - 1) = \frac{7}{3} (\ln 2)^3$
103. $\int_1^8 \frac{\log_4 \theta}{\theta} d\theta = \frac{1}{\ln 4} \int_1^8 (\ln \theta) \left(\frac{1}{\theta}\right) d\theta = \frac{1}{\ln 4} \int_0^{\ln 8} u du$, where $u = \ln \theta$, $du = \frac{1}{\theta} d\theta$, $\theta = 1 \Rightarrow u = 0$, $\theta = 8 \Rightarrow u = \ln 8$
 $= \frac{1}{2 \ln 4} [u^2]_0^{\ln 8} = \frac{1}{\ln 16} [(\ln 8)^2 - 0^2] = \frac{(3 \ln 2)^2}{4 \ln 2} = \frac{9 \ln 2}{4}$
104. $\int_1^e \frac{8(\ln 3)(\log_3 \theta)}{\theta} d\theta = \int_1^e \frac{8(\ln 3)(\ln \theta)}{\theta(\ln 3)} d\theta = 8 \int_1^e (\ln \theta) \left(\frac{1}{\theta}\right) d\theta = 8 \int_0^1 u du$, where $u = \ln \theta$, $du = \frac{1}{\theta} d\theta$; $\theta = 1$
 $\Rightarrow u = 0$, $\theta = e \Rightarrow u = 1$
 $= 4 [u^2]_0^1 = 4(1^2 - 0^2) = 4$
105. $\int_{-3/4}^{3/4} \frac{6}{\sqrt{9-4x^2}} dx = 3 \int_{-3/4}^{3/4} \frac{2}{\sqrt{3^2-(2x)^2}} dx = 3 \int_{-3/2}^{3/2} \frac{1}{\sqrt{3^2-u^2}} du$, where $u = 2x$, $du = 2 dx$; $x = -\frac{3}{4} \Rightarrow u = -\frac{3}{2}$, $x = \frac{3}{4}$
 $\Rightarrow u = \frac{3}{2}$
 $= 3 \left[\sin^{-1} \left(\frac{u}{3}\right) \right]_{-3/2}^{3/2} = 3 \left[\sin^{-1} \left(\frac{1}{2}\right) - \sin^{-1} \left(-\frac{1}{2}\right) \right] = 3 \left[\frac{\pi}{6} - \left(-\frac{\pi}{6}\right) \right] = 3 \left(\frac{\pi}{3}\right) = \pi$
106. $\int_{-1/5}^{1/5} \frac{6}{\sqrt{4-25x^2}} dx = \frac{6}{5} \int_{-1/5}^{1/5} \frac{5}{\sqrt{2^2-(5x)^2}} dx = \frac{6}{5} \int_{-1}^1 \frac{1}{\sqrt{2^2-u^2}} du$, where $u = 5x$, $du = 5 dx$;
 $x = -\frac{1}{5} \Rightarrow u = -1$, $x = \frac{1}{5} \Rightarrow u = 1$
 $= \frac{6}{5} \left[\sin^{-1} \left(\frac{u}{2}\right) \right]_{-1}^1 = \frac{6}{5} \left[\sin^{-1} \left(\frac{1}{2}\right) - \sin^{-1} \left(-\frac{1}{2}\right) \right] = \frac{6}{5} \left[\frac{\pi}{6} - \left(-\frac{\pi}{6}\right) \right] = \frac{6}{5} \left(\frac{\pi}{3}\right) = \frac{2\pi}{5}$
107. $\int_{-2}^2 \frac{3}{4+3t^2} dt = \sqrt{3} \int_{-2}^2 \frac{\sqrt{3}}{2^2+(\sqrt{3}t)} dt = \sqrt{3} \int_{-2\sqrt{3}}^{2\sqrt{3}} \frac{1}{2^2+u^2} du$, where $u = \sqrt{3}t$, $du = \sqrt{3} dt$;
 $t = -2 \Rightarrow u = -2\sqrt{3}$, $t = 2 \Rightarrow u = 2\sqrt{3}$
 $= \sqrt{3} \left[\frac{1}{2} \tan^{-1} \left(\frac{u}{2}\right) \right]_{-2\sqrt{3}}^{2\sqrt{3}} = \frac{\sqrt{3}}{2} \left[\tan^{-1}(\sqrt{3}) - \tan^{-1}(-\sqrt{3}) \right] = \frac{\sqrt{3}}{2} \left[\frac{\pi}{3} - \left(-\frac{\pi}{3}\right) \right] = \frac{\pi}{\sqrt{3}}$
108. $\int_{\sqrt{3}}^3 \frac{1}{3+t^2} dt = \int_{\sqrt{3}}^3 \frac{1}{(\sqrt{3})^2+t^2} dt = \left[\frac{1}{\sqrt{3}} \tan^{-1} \left(\frac{t}{\sqrt{3}}\right) \right]_{\sqrt{3}}^3 = \frac{1}{\sqrt{3}} \left(\tan^{-1} \sqrt{3} - \tan^{-1} 1 \right) = \frac{1}{\sqrt{3}} \left(\frac{\pi}{3} - \frac{\pi}{4} \right) = \frac{\sqrt{3}\pi}{36}$
109. $\int_{1/\sqrt{3}}^1 \frac{1}{y\sqrt{4y^2-1}} dy = \int_{1/\sqrt{3}}^1 \frac{2}{(2y)\sqrt{(2y)^2-1}} dy = \int_{1/\sqrt{3}}^1 \frac{1}{u\sqrt{u^2-1}} du$, where $u = 2y$ and $du = 2 dy$
 $= \left[\sec^{-1} |u| \right]_{1/\sqrt{3}}^1 = \left[\sec^{-1} |2y| \right]_{1/\sqrt{3}}^1 = \sec^{-1} 2 - \sec^{-1} 2/\sqrt{3} = \frac{\pi}{3} - \frac{\pi}{6} = \frac{\pi}{6}$

$$110. \int_{4\sqrt{2}}^8 \frac{24}{y\sqrt{y^2-16}} dy = 24 \int_{4\sqrt{2}}^8 \frac{1}{y\sqrt{y^2-4^2}} dy = 24 \left[\frac{1}{4} \sec^{-1} \left| \frac{y}{4} \right| \right]_{4\sqrt{2}}^8 = \left[6 \sec^{-1} \left| \frac{y}{4} \right| \right]_{4\sqrt{2}}^8 = 6(\sec^{-1} 2 - \sec^{-1} \sqrt{2}) = 6\left(\frac{\pi}{3} - \frac{\pi}{4}\right) = 6\left(\frac{\pi}{12}\right) = \frac{\pi}{2}$$

$$111. \int_{\sqrt{2/3}}^{2/3} \frac{1}{|y|\sqrt{9y^2-1}} dy = \int_{\sqrt{2/3}}^{2/3} \frac{3}{|3y|\sqrt{(3y)^2-1}} dy = \int_{\sqrt{2}}^2 \frac{1}{|u|\sqrt{u^2-1}} du, \text{ where } u = 3y, du = 3 dy;$$

$$y = \frac{\sqrt{2}}{3} \Rightarrow u = \sqrt{2}, y = \frac{2}{3} \Rightarrow u = 2$$

$$= [\sec^{-1} u]_{\sqrt{2}}^2 = [\sec^{-1} 2 - \sec^{-1} \sqrt{2}] = \frac{\pi}{3} - \frac{\pi}{4} = \frac{\pi}{12}$$

$$112. \int_{-2/\sqrt{5}}^{-\sqrt{6}/\sqrt{5}} \frac{1}{|y|\sqrt{5y^2-3}} dy = \int_{-2/\sqrt{5}}^{-\sqrt{6}/\sqrt{5}} \frac{\sqrt{5}}{-\sqrt{5}y\sqrt{(\sqrt{5}y)^2-(\sqrt{3})^2}} dy = \int_{-2}^{-\sqrt{6}} \frac{1}{-u\sqrt{u^2-(\sqrt{3})^2}} du,$$

where $u = \sqrt{5}y, du = \sqrt{5} dy; y = -\frac{2}{\sqrt{5}} \Rightarrow u = -2, y = -\frac{\sqrt{6}}{\sqrt{5}} \Rightarrow u = -\sqrt{6}$

$$= \left[-\frac{1}{\sqrt{3}} \sec^{-1} \left| \frac{u}{\sqrt{3}} \right| \right]_{-2}^{-\sqrt{6}} = \frac{-1}{\sqrt{3}} \left[\sec^{-1} \sqrt{2} - \sec^{-1} \frac{2}{\sqrt{3}} \right] = \frac{-1}{\sqrt{3}} \left(\frac{\pi}{4} - \frac{\pi}{6} \right) = \frac{-1}{\sqrt{3}} \left[\frac{3\pi}{12} - \frac{2\pi}{12} \right] = \frac{-\pi}{12\sqrt{3}} = \frac{-\sqrt{3}\pi}{36}$$

$$113. (a) \text{ av}(f) = \frac{1}{1-(-1)} \int_{-1}^1 (mx+b) dx = \frac{1}{2} \left[\frac{mx^2}{2} + bx \right]_{-1}^1 = \frac{1}{2} \left[\left(\frac{m(1)^2}{2} + b(1) \right) - \left(\frac{m(-1)^2}{2} + b(-1) \right) \right] = \frac{1}{2}(2b) = b$$

$$(b) \text{ av}(f) = \frac{1}{k-(-k)} \int_{-k}^k (mx+b) dx = \frac{1}{2k} \left[\frac{mx^2}{2} + bx \right]_{-k}^k = \frac{1}{2k} \left[\left(\frac{m(k)^2}{2} + b(k) \right) - \left(\frac{m(-k)^2}{2} + b(-k) \right) \right]$$

$$= \frac{1}{2k}(2bk) = b$$

$$114. (a) y_{\text{av}} = \frac{1}{3-0} \int_0^3 \sqrt{3x} dx = \frac{1}{3} \int_0^3 \sqrt{3} x^{1/2} dx = \frac{\sqrt{3}}{3} \left[\frac{2}{3} x^{3/2} \right]_0^3 = \frac{\sqrt{3}}{3} \left[\frac{2}{3} (3)^{3/2} - \frac{2}{3} (0)^{3/2} \right] = \frac{\sqrt{3}}{3} (2\sqrt{3}) = 2$$

$$(b) y_{\text{av}} = \frac{1}{a-0} \int_0^a \sqrt{ax} dx = \frac{1}{a} \int_0^a \sqrt{a} x^{1/2} dx = \frac{\sqrt{a}}{a} \left[\frac{2}{3} x^{3/2} \right]_0^a = \frac{\sqrt{a}}{a} \left(\frac{2}{3} (a)^{3/2} - \frac{2}{3} (0)^{3/2} \right) = \frac{\sqrt{a}}{a} \left(\frac{2}{3} a\sqrt{a} \right) = \frac{2}{3} a$$

$$115. f'_{\text{av}} = \frac{1}{b-a} \int_a^b f'(x) dx = \frac{1}{b-a} [f(x)]_a^b = \frac{1}{b-a} [f(b) - f(a)] = \frac{f(b)-f(a)}{b-a} \text{ so the average value of } f' \text{ over } [a, b] \text{ is the slope of the secant line joining the points } (a, f(a)) \text{ and } (b, f(b)), \text{ which is the average rate of change of } f \text{ over } [a, b].$$

$$116. \text{ Yes, because the average value of } f \text{ on } [a, b] \text{ is } \frac{1}{b-a} \int_a^b f(x) dx. \text{ If the length of the interval is 2, then } b-a=2$$

and the average value of the function is $\frac{1}{2} \int_a^b f(x) dx$.

$$117. (a) \frac{d}{dx}(x \ln x - x + C) = x \cdot \frac{1}{x} + \ln x - 1 + 0 = \ln x$$

$$(b) \text{ average value} = \frac{1}{e-1} \int_1^e \ln x dx = \frac{1}{e-1} [x \ln x - x]_1^e = \frac{1}{e-1} [(e \ln e - e) - (1 \ln 1 - 1)] = \frac{1}{e-1} (e - e + 1) = \frac{1}{e-1}$$

$$118. \text{ average value} = \frac{1}{2-1} \int_1^2 \frac{1}{x} dx = [\ln|x|]_1^2 = \ln 2 - \ln 1 = \ln 2$$

119. We want to evaluate

$$\frac{1}{365-0} \int_0^{365} f(x) dx = \frac{1}{365} \int_0^{365} \left(37 \sin \left[\frac{2\pi}{365} (x-101) \right] + 25 \right) dx = \frac{37}{365} \int_0^{365} \sin \left[\frac{2\pi}{365} (x-101) \right] dx + \frac{25}{365} \int_0^{365} dx$$

Notice that the period of $y = \sin \left[\frac{2\pi}{365} (x-101) \right]$ is $\frac{2\pi}{\frac{2\pi}{365}} = 365$ and that we are integrating this function over an interval of length 365. Thus the value of $\frac{37}{365} \int_0^{365} \sin \left[\frac{2\pi}{365} (x-101) \right] dx + \frac{25}{365} \int_0^{365} dx$ is $\frac{37}{365} \cdot 0 + \frac{25}{365} \cdot 365 = 25$.

$$120. \frac{1}{675-20} \int_{20}^{675} (8.27 + 10^{-5} (26T - 1.87T^2)) dT = \frac{1}{655} \left[8.27T + \frac{26T^2}{2 \cdot 10^5} - \frac{1.87T^3}{3 \cdot 10^5} \right]_{20}^{675}$$

$$= \frac{1}{655} \left(\left[8.27(675) + \frac{26(675)^2}{2 \cdot 10^5} - \frac{1.87(675)^3}{3 \cdot 10^5} \right] - \left[8.27(20) + \frac{26(20)^2}{2 \cdot 10^5} - \frac{1.87(20)^3}{3 \cdot 10^5} \right] \right)$$

$\approx \frac{1}{655} (3724.44 - 165.40) = 5.43 =$ the average value of C_v on $[20, 675]$. To find the temperature T at which $C_v = 5.43$, solve $5.43 = 8.27 + 10^{-5} (26T - 1.87T^2)$ for T . We obtain $1.87T^2 - 26T - 284000 = 0$

$\Rightarrow T = \frac{26 \pm \sqrt{(26)^2 - 4(1.87)(-284000)}}{2(1.87)} = \frac{26 \pm \sqrt{2124996}}{3.74}$. So $T = -382.82$ or $T = 396.72$. Only $T = 396.72$ lies in the interval $[20, 675]$, so $T = 396.72^\circ\text{C}$.

$$121. \frac{dy}{dx} = \sqrt{2 + \cos^3 x}$$

$$122. \frac{dy}{dx} = \sqrt{2 + \cos^3(7x^2)} \cdot \frac{d}{dx}(7x^2) = 14x\sqrt{2 + \cos^3(7x^2)}$$

$$123. \frac{dy}{dx} = \frac{d}{dx} \left(-\int_1^x \frac{6}{3+t^4} dt \right) = -\frac{6}{3+x^4}$$

$$124. \frac{dy}{dx} = \frac{d}{dx} \left(\int_{\sec x}^2 \frac{1}{t^2+1} dt \right) = -\frac{d}{dx} \left(\int_2^{\sec x} \frac{1}{t^2+1} dt \right) = -\frac{1}{\sec^2 x + 1} \frac{d}{dx}(\sec x) = -\frac{\sec x \tan x}{1 + \sec^2 x}$$

$$125. y = \int_{\ln x^2}^0 e^{\cos t} dt = -\int_0^{\ln x^2} e^{\cos t} dt \Rightarrow \frac{dy}{dx} = -e^{\cos(\ln x^2)} \cdot \frac{d}{dx}(\ln x^2) = -\frac{2}{x} e^{\cos(\ln x^2)}$$

$$126. y = \int_1^{e^{\sqrt{x}}} \ln(t^2 + 1) dt \Rightarrow \frac{dy}{dx} = \ln(e^{2\sqrt{x}} + 1) \cdot \frac{d}{dx}(e^{\sqrt{x}}) = \frac{e^{\sqrt{x}}}{2\sqrt{x}} \ln(e^{2\sqrt{x}} + 1)$$

$$127. y = \int_0^{\sin^{-1} x} \frac{dt}{\sqrt{1-t^2}} \Rightarrow \frac{dy}{dx} = \frac{1}{\sqrt{1-(\sin^{-1} x)^2}} \cdot \frac{d}{dx}(\sin^{-1} x) = \frac{1}{\sqrt{1-(\sin^{-1} x)^2}} \cdot \frac{1}{\sqrt{1-x^2}}$$

$$128. y = \int_{\tan^{-1} x}^{\pi/4} e^{\sqrt{t}} dt = -\int_{\pi/4}^{\tan^{-1} x} e^{\sqrt{t}} dt \Rightarrow \frac{dy}{dx} = -e^{\sqrt{\tan^{-1} x}} \cdot \frac{d}{dx}(\tan^{-1} x) = -\frac{e^{\sqrt{\tan^{-1} x}}}{1+x^2}$$

129. Yes. The function f , being differentiable on $[a, b]$, is then continuous on $[a, b]$. The Fundamental Theorem of Calculus says that every continuous function on $[a, b]$ is the derivative of a function on $[a, b]$.

130. The second part of the Fundamental Theorem of Calculus states that if $F(x)$ is an antiderivative of $f(x)$ on $[a, b]$, then $\int_a^b f(x) dx = F(b) - F(a)$. In particular, if $F(x)$ is an antiderivative of $\sqrt{1+x^4}$ on $[0, 1]$, then

$$\int_0^1 \sqrt{1+x^4} dx = F(1) - F(0).$$

$$131. y = \int_x^1 \sqrt{1+t^2} dt = - \int_1^x \sqrt{1+t^2} dt \Rightarrow \frac{dy}{dx} = \frac{d}{dx} \left[- \int_1^x \sqrt{1+t^2} dt \right] = - \frac{d}{dx} \left[\int_1^x \sqrt{1+t^2} dt \right] = -\sqrt{1+x^2}$$

$$132. y = \int_{\cos x}^0 \frac{1}{1-t^2} dt = - \int_0^{\cos x} \frac{1}{1-t^2} dt \Rightarrow \frac{dy}{dx} = \frac{d}{dx} \left[- \int_0^{\cos x} \frac{1}{1-t^2} dt \right] = - \frac{d}{dx} \left[\int_0^{\cos x} \frac{1}{1-t^2} dt \right]$$

$$= - \left(\frac{1}{1-\cos^2 x} \right) \left(\frac{d}{dx} (\cos x) \right) = - \left(\frac{1}{\sin^2 x} \right) (-\sin x) = \frac{1}{\sin x} = \csc x$$

133. We estimate the area A using midpoints of the vertical intervals, and we will estimate the width of the parking lot on each interval by averaging the widths at top and bottom. This gives the estimate $A \approx 15 \cdot \left(\frac{0+36}{2} + \frac{36+54}{2} + \frac{54+51}{2} + \frac{51+49.5}{2} + \frac{49.5+54}{2} + \frac{54+64.4}{2} + \frac{64.4+67.5}{2} + \frac{67.5+42}{2} \right) \approx 5961 \text{ ft}^2$. The cost is $\text{Area} \cdot (\$2.10/\text{ft}^2) \approx (5961 \text{ ft}^2)(\$2.10/\text{ft}^2) = \$12,518.10 \Rightarrow$ the job cannot be done for \$11,000.

134. (a) Before the chute opens for A , $a = -32 \text{ ft/sec}^2$. Since the helicopter is hovering $v_0 = 0 \text{ ft/sec}$
 $\Rightarrow v = \int -32 dt = -32t + v_0 = -32t$. Then $s_0 = 6400 \text{ ft} \Rightarrow s = \int -32t dt = -16t^2 + s_0 = -16t^2 + 6400$.
 At $t = 4 \text{ sec}$, $s = -16(4)^2 + 6400 = 6144 \text{ ft}$ when A 's chute opens;
- (b) For B , $s_0 = 7000 \text{ ft}$, $v_0 = 0$, $a = -32 \text{ ft/sec}^2 \Rightarrow v = \int -32 dt = -32t + v_0 = -32t \Rightarrow s = \int -32t dt = -16t^2 + s_0 = -16t^2 + 7000$. At $t = 13 \text{ sec}$, $s = -16(13)^2 + 7000 = 4296 \text{ ft}$ when B 's chute opens;
- (c) After the chutes open, $v = -16 \text{ ft/sec} \Rightarrow s = \int -16 dt = -16t + s_0$. For A , $s_0 = 6144 \text{ ft}$ and for B , $s_0 = 4296 \text{ ft}$. Therefore, for A , $s = -16t + 6144$ and for B , $s = -16t + 4296$. When they hit the ground, $s = 0 \Rightarrow$ for A , $0 = -16t + 6144 \Rightarrow t = \frac{6144}{16} = 384$ seconds, and for B , $0 = -16t + 4296 \Rightarrow t = \frac{4296}{16} = 268.5$ seconds to hit the ground after the chutes open, Since B 's chutes opens 58 seconds after A 's opens $\Rightarrow B$ hits the ground first.

CHAPTER 5 ADDITIONAL AND ADVANCED EXERCISES

1. (a) Yes, because $\int_0^1 f(x) dx = \frac{1}{7} \int_0^1 7f(x) dx = \frac{1}{7}(7) = 1$

(b) No. For example, $\int_0^1 8x dx = [4x^2]_0^1 = 4$, but $\int_0^1 \sqrt{8x} dx = \left[2\sqrt{2} \left(\frac{x^{3/2}}{\frac{3}{2}} \right) \right]_0^1 = \frac{4\sqrt{2}}{3} (1^{3/2} - 0^{3/2}) = \frac{4\sqrt{2}}{3} \neq \sqrt{4}$

2. (a) True: $\int_5^2 f(x) dx = - \int_2^5 f(x) dx = -3$

(b) True: $\int_{-2}^5 [f(x) + g(x)] dx = \int_{-2}^5 f(x) dx + \int_{-2}^5 g(x) dx = \int_{-2}^2 f(x) dx + \int_2^5 f(x) dx + \int_{-2}^5 g(x) dx$
 $= 4 + 3 + 2 = 9$

(c) False: $\int_{-2}^5 f(x) dx = 4 + 3 = 7 > 2 = \int_{-2}^5 g(x) dx \Rightarrow \int_{-2}^5 [f(x) - g(x)] dx > 0 \Rightarrow \int_{-2}^5 [g(x) - f(x)] dx < 0$. On the other hand, $f(x) \leq g(x) \Rightarrow [g(x) - f(x)] \geq 0 \Rightarrow \int_{-2}^5 [g(x) - f(x)] dx \geq 0$ which is a contradiction.

$$\begin{aligned}
 3. \quad y &= \frac{1}{a} \int_0^x f(t) \sin a(x-t) dt = \frac{1}{a} \int_0^x f(t) \sin ax \cos at dt - \frac{1}{a} \int_0^x f(t) \cos ax \sin at dt \\
 &= \frac{\sin ax}{a} \int_0^x f(t) \cos at dt - \frac{\cos ax}{a} \int_0^x f(t) \sin at dt \Rightarrow \frac{dy}{dx} \\
 &= \cos ax \left(\int_0^x f(t) \cos at dt \right) + \frac{\sin ax}{a} \left(\frac{d}{dx} \int_0^x f(t) \cos at dt \right) + \sin ax \int_0^x f(t) \sin at dt - \frac{\cos ax}{a} \left(\frac{d}{dx} \int_0^x f(t) \sin at dt \right) \\
 &= \cos ax \int_0^x f(t) \cos at dt + \frac{\sin ax}{a} (f(x) \cos ax) + \sin ax \int_0^x f(t) \sin at dt - \frac{\cos ax}{a} (f(x) \sin ax) \\
 &\Rightarrow \frac{dy}{dx} = \cos ax \int_0^x f(t) \cos at dt + \sin ax \int_0^x f(t) \sin at dt. \text{ Next, } \frac{d^2y}{dx^2} = \\
 &-a \sin ax \int_0^x f(t) \cos at dt + (\cos ax) \left(\frac{d}{dx} \int_0^x f(t) \cos at dt \right) + a \cos ax \int_0^x f(t) \sin at dt + (\sin ax) \left(\frac{d}{dx} \int_0^x f(t) \sin at dt \right) \\
 &= -a \sin ax \int_0^x f(t) \cos at dt + (\cos ax) f(x) \cos ax + a \cos ax \int_0^x f(t) \sin at dt + (\sin ax) f(x) \sin ax \\
 &= -a \sin ax \int_0^x f(t) \cos at dt + a \cos ax \int_0^x f(t) \sin at dt + f(x). \text{ Therefore, } y'' + a^2 y \\
 &= a \cos ax \int_0^x f(t) \sin at dt - a \sin ax \int_0^x f(t) \cos at dt + f(x) + a^2 \left(\frac{\sin ax}{a} \int_0^x f(t) \cos at dt - \frac{\cos ax}{a} \int_0^x f(t) \sin at dt \right) \\
 &= f(x). \text{ Note also that } y'(0) = y(0) = 0.
 \end{aligned}$$

$$\begin{aligned}
 4. \quad x &= \int_0^y \frac{1}{\sqrt{1+4t^2}} dt \Rightarrow \frac{d}{dx}(x) = \frac{d}{dx} \int_0^y \frac{1}{\sqrt{1+4t^2}} dt = \frac{d}{dy} \left[\int_0^y \frac{1}{\sqrt{1+4t^2}} dt \right] \left(\frac{dy}{dx} \right) \text{ from the chain rule} \\
 &\Rightarrow 1 = \frac{1}{\sqrt{1+4y^2}} \left(\frac{dy}{dx} \right) \Rightarrow \frac{dy}{dx} = \sqrt{1+4y^2}. \text{ Then } \frac{d^2y}{dx^2} = \frac{d}{dx} \left(\sqrt{1+4y^2} \right) = \frac{d}{dy} \left(\sqrt{1+4y^2} \right) \left(\frac{dy}{dx} \right) \\
 &= \frac{1}{2} (1+4y^2)^{-1/2} (8y) \left(\frac{dy}{dx} \right) = \frac{4y \left(\frac{dy}{dx} \right)}{\sqrt{1+4y^2}} = \frac{4y \left(\sqrt{1+4y^2} \right)}{\sqrt{1+4y^2}} = 4y. \text{ Thus } \frac{d^2y}{dx^2} = 4y, \text{ and the constant of proportionality} \\
 &\text{is 4.}
 \end{aligned}$$

$$\begin{aligned}
 5. \quad (a) \quad \int_0^{x^2} f(t) dt &= x \cos \pi x \Rightarrow \frac{d}{dx} \int_0^{x^2} f(t) dt = \cos \pi x - \pi x \sin \pi x \Rightarrow f(x^2)(2x) = \cos \pi x - \pi x \sin \pi x \\
 &\Rightarrow f(x^2) = \frac{\cos \pi x - \pi x \sin \pi x}{2x}. \text{ Thus, } x = 2 \Rightarrow f(4) = \frac{\cos 2\pi - 2\pi \sin 2\pi}{4} = \frac{1}{4} \\
 (b) \quad \int_0^{f(x)} t^2 dt &= \left[\frac{t^3}{3} \right]_0^{f(x)} = \frac{1}{3} (f(x))^3 \Rightarrow \frac{1}{3} (f(x))^3 = x \cos \pi x \Rightarrow (f(x))^3 = 3x \cos \pi x \Rightarrow f(x) = \sqrt[3]{3x \cos \pi x} \\
 &\Rightarrow f(4) = \sqrt[3]{3(4) \cos 4\pi} = \sqrt[3]{12}
 \end{aligned}$$

$$\begin{aligned}
 6. \quad \int_0^a f(x) dx &= \frac{a^2}{2} + \frac{a}{2} \sin a + \frac{\pi}{2} \cos a. \text{ Let } F(a) = \int_0^a f(t) dt \Rightarrow f(a) = F'(a). \text{ Now } F(a) = \frac{a^2}{2} + \frac{a}{2} \sin a + \frac{\pi}{2} \cos a \\
 &\Rightarrow f(a) = F'(a) = a + \frac{1}{2} \sin a + \frac{a}{2} \cos a - \frac{\pi}{2} \sin a \Rightarrow f\left(\frac{\pi}{2}\right) = \frac{\pi}{2} + \frac{1}{2} \sin \frac{\pi}{2} + \frac{\left(\frac{\pi}{2}\right)}{2} \cos \frac{\pi}{2} - \frac{\pi}{2} \sin \frac{\pi}{2} = \frac{\pi}{2} + \frac{1}{2} - \frac{\pi}{2} = \frac{1}{2}
 \end{aligned}$$

$$7. \quad \int_1^b f(x) dx = \sqrt{b^2+1} - \sqrt{2} \Rightarrow f(b) = \frac{d}{db} \int_1^b f(x) dx = \frac{1}{2} (b^2+1)^{-1/2} (2b) = \frac{b}{\sqrt{b^2+1}} \Rightarrow f(x) = \frac{x}{\sqrt{x^2+1}}$$

8. The derivative of the left side of the equation is: $\frac{d}{dx} \left[\int_0^x \left[\int_0^u f(t) dt \right] du \right] = \int_0^x f(t) dt$; the derivative of the right side of the equation is: $\frac{d}{dx} \left[\int_0^x f(u)(x-u) du \right] = \frac{d}{dx} \int_0^x f(u) x du - \frac{d}{dx} \int_0^x u f(u) du$
 $= \frac{d}{dx} \left[x \int_0^x f(u) du \right] - \frac{d}{dx} \int_0^x u f(u) du = \int_0^x f(u) du + x \left[\frac{d}{dx} \int_0^x f(u) du \right] - x f(x) = \int_0^x f(u) du + x f(x) - x f(x)$
 $= \int_0^x f(u) du$. Since each side has the same derivative, they differ by a constant, and since both sides equal 0 when $x = 0$, the constant must be 0. Therefore, $\int_0^x \left[\int_0^u f(t) dt \right] du = \int_0^x f(u)(x-u) du$.

9. $\frac{dy}{dx} = 3x^2 + 2 \Rightarrow y = \int (3x^2 + 2) dx = x^3 + 2x + C$. Then $(1, -1)$ lies on the curve $\Rightarrow 1^3 + 2(1) + C = -1$
 $\Rightarrow C = -4 \Rightarrow y = x^3 + 2x - 4$

10. The acceleration due to gravity downward is $-32 \text{ ft/sec}^2 \Rightarrow v = \int -32 dt = -32t + v_0$, where v_0 is the initial velocity $\Rightarrow v = -32t + 32 \Rightarrow s = \int (-32t + 32) dt = -16t^2 + 32t + C$. If the release point, at $t = 0$, is $s = 0$, then $C = 0 \Rightarrow s = -16t^2 + 32t$. Then $s = 17 \Rightarrow 17 = -16t^2 + 32t \Rightarrow 16t^2 - 32t + 17 = 0$. The discriminant of this quadratic equation is -64 which says there is no real time when $s = 17$ ft. You had better duck.

11. $\int_{-8}^3 f(x) dx = \int_{-8}^0 x^{2/3} dx + \int_0^3 -4 dx$
 $= \left[\frac{3}{5} x^{5/3} \right]_{-8}^0 + [-4x]_0^3$
 $= \left(0 - \frac{3}{5} (-8)^{5/3} \right) + (-4(3) - 0) = \frac{96}{5} - 12 = \frac{36}{5}$

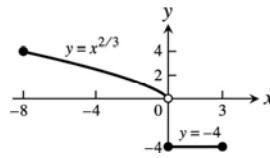

12. $\int_{-4}^3 f(x) dx = \int_{-4}^0 \sqrt{-x} dx + \int_0^3 (x^2 - 4) dx$
 $= \left[-\frac{2}{3} (-x)^{3/2} \right]_{-4}^0 + \left[\frac{x^3}{3} - 4x \right]_0^3$
 $= \left[0 - \left(-\frac{2}{3} (4)^{3/2} \right) \right] + \left[\left(\frac{3^3}{3} - 4(3) \right) - 0 \right] = \frac{16}{3} - 3 = \frac{7}{3}$

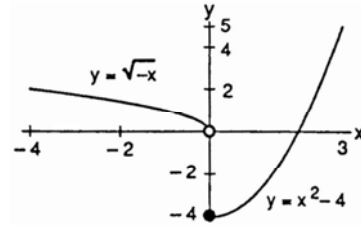

13. $\int_0^2 g(t) dt = \int_0^1 t dt + \int_1^2 \sin \pi t dt$
 $= \left[\frac{t^2}{2} \right]_0^1 + \left[-\frac{1}{\pi} \cos \pi t \right]_1^2$
 $= \left(\frac{1}{2} - 0 \right) + \left[-\frac{1}{\pi} \cos 2\pi - \left(-\frac{1}{\pi} \cos \pi \right) \right] = \frac{1}{2} - \frac{2}{\pi}$

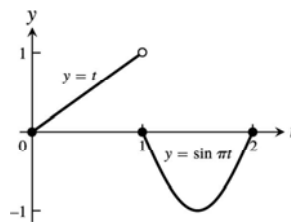

14. $\int_0^2 h(z) dz = \int_0^1 \sqrt{1-z} dz + \int_1^2 (7z-6)^{-1/3} dz$
 $= \left[-\frac{2}{3} (1-z)^{3/2} \right]_0^1 + \left[\frac{3}{14} (7z-6)^{2/3} \right]_1^2$
 $= \left[-\frac{2}{3} (1-1)^{3/2} - \left(-\frac{2}{3} (1-0)^{3/2} \right) \right]$
 $\quad + \left[\frac{3}{14} (7(2)-6)^{2/3} - \frac{3}{14} (7(1)-6)^{2/3} \right]$
 $= \frac{2}{3} + \left(\frac{6}{7} - \frac{3}{14} \right) = \frac{55}{42}$

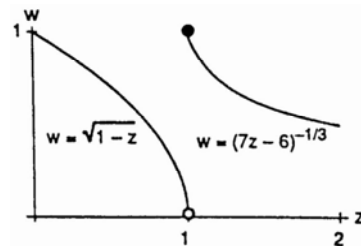

$$\begin{aligned}
 15. \int_{-2}^2 f(x) dx &= \int_{-2}^{-1} dx + \int_{-1}^1 (1-x^2) dx + \int_1^2 2 dx \\
 &= [x]_{-2}^{-1} + \left[x - \frac{x^3}{3} \right]_{-1}^1 + [2x]_1^2 \\
 &= (-1 - (-2)) + \left[\left(1 - \frac{1^3}{3} \right) - \left(-1 - \frac{(-1)^3}{3} \right) \right] + [2(2) - 2(1)] \\
 &= 1 + \frac{2}{3} - \left(-\frac{2}{3} \right) + 4 - 2 = \frac{13}{3}
 \end{aligned}$$

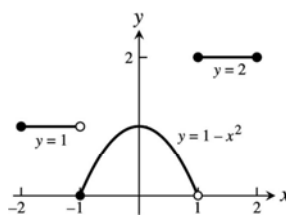

$$\begin{aligned}
 16. \int_{-1}^2 h(r) dr &= \int_{-1}^0 r dr + \int_0^1 (1-r^2) dr + \int_1^2 dr \\
 &= \left[\frac{r^2}{2} \right]_{-1}^0 + \left[r - \frac{r^3}{3} \right]_0^1 + [r]_1^2 \\
 &= \left(0 - \frac{(-1)^2}{2} \right) + \left(\left(1 - \frac{1^3}{3} \right) - 0 \right) + (2 - 1) = -\frac{1}{2} + \frac{2}{3} + 1 = \frac{7}{6}
 \end{aligned}$$

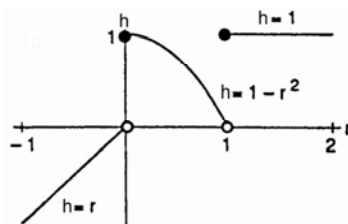

$$\begin{aligned}
 17. \text{Ave. value} &= \frac{1}{b-a} \int_a^b f(x) dx = \frac{1}{2-0} \int_0^2 f(x) dx = \frac{1}{2} \left[\int_0^1 x dx + \int_1^2 (x-1) dx \right] = \frac{1}{2} \left[\frac{x^2}{2} \right]_0^1 + \frac{1}{2} \left[\frac{x^2}{2} - x \right]_1^2 \\
 &= \frac{1}{2} \left[\left(\frac{1^2}{2} - 0 \right) + \left(\frac{2^2}{2} - 2 \right) - \left(\frac{1^2}{2} - 1 \right) \right] = \frac{1}{2}
 \end{aligned}$$

$$18. \text{Ave. value} = \frac{1}{b-a} \int_a^b f(x) dx = \frac{1}{3-0} \int_0^3 f(x) dx = \frac{1}{3} \left[\int_0^1 dx + \int_1^2 0 dx + \int_2^3 dx \right] = \frac{1}{3} [1 - 0 + 0 + 3 - 2] = \frac{2}{3}$$

$$19. \lim_{b \rightarrow 1^-} \int_0^b \frac{1}{\sqrt{1-x^2}} dx = \lim_{b \rightarrow 1^-} [\sin^{-1} x]_0^b = \lim_{b \rightarrow 1^-} (\sin^{-1} b - \sin^{-1} 0) = \lim_{b \rightarrow 1^-} (\sin^{-1} b - 0) = \lim_{b \rightarrow 1^-} \sin^{-1} b = \frac{\pi}{2}$$

$$\begin{aligned}
 20. \lim_{x \rightarrow \infty} \frac{1}{x} \int_0^x \tan^{-1} t dt &= \lim_{x \rightarrow \infty} \frac{\int_0^x \tan^{-1} t dt}{x} \quad \left(\frac{\infty}{\infty} \text{ form} \right) \\
 &= \lim_{x \rightarrow \infty} \frac{\tan^{-1} x}{1} = \frac{\pi}{2}
 \end{aligned}$$

$$\begin{aligned}
 21. \lim_{n \rightarrow \infty} \left(\frac{1}{n+1} + \frac{1}{n+2} + \dots + \frac{1}{2n} \right) &= \lim_{n \rightarrow \infty} \left(\left(\frac{1}{n} \right) \left[\frac{1}{1+(\frac{1}{n})} \right] + \left(\frac{1}{n} \right) \left[\frac{1}{1+2(\frac{1}{n})} \right] + \dots + \left(\frac{1}{n} \right) \left[\frac{1}{1+n(\frac{1}{n})} \right] \right) \text{ which can be interpreted as a} \\
 \text{Riemann sum with partitioning } \Delta x = \frac{1}{n} &\Rightarrow \lim_{n \rightarrow \infty} \left(\frac{1}{n+1} + \frac{1}{n+2} + \dots + \frac{1}{2n} \right) = \int_0^1 \frac{1}{1+x} dx = [\ln(1+x)]_0^1 = \ln 2
 \end{aligned}$$

$$\begin{aligned}
 22. \lim_{n \rightarrow \infty} \frac{1}{n} [e^{1/n} + e^{2/n} + \dots + e] &= \lim_{n \rightarrow \infty} \left[\left(\frac{1}{n} \right) e^{(1/n)} + \left(\frac{1}{n} \right) e^{2(1/n)} + \dots + \left(\frac{1}{n} \right) e^{n(1/n)} \right] \text{ which can be interpreted as a} \\
 \text{Riemann sum with partitioning } \Delta x = \frac{1}{n} &\Rightarrow \lim_{n \rightarrow \infty} \frac{1}{n} [e^{1/n} + e^{2/n} + \dots + e] = \int_0^1 e^x dx = [e^x]_0^1 = e - 1
 \end{aligned}$$

$$\begin{aligned}
 23. \text{Let } f(x) = x^5 \text{ on } [0, 1]. \text{ Partition } [0, 1] \text{ into } n \text{ subintervals with } \Delta x = \frac{1-0}{n} = \frac{1}{n}. \text{ Then } \frac{1}{n}, \frac{2}{n}, \dots, \frac{n}{n} \text{ are the right-hand} \\
 \text{endpoints of the subintervals. Since } f \text{ is increasing on } [0, 1], U = \sum_{j=1}^n \left(\frac{j}{n} \right)^5 \left(\frac{1}{n} \right) \text{ is the upper sum for } f(x) = x^5 \text{ on} \\
 [0, 1] \Rightarrow \lim_{n \rightarrow \infty} \sum_{j=1}^n \left(\frac{j}{n} \right)^5 \left(\frac{1}{n} \right) &= \lim_{n \rightarrow \infty} \frac{1}{n} \left[\left(\frac{1}{n} \right)^5 + \left(\frac{2}{n} \right)^5 + \dots + \left(\frac{n}{n} \right)^5 \right] = \lim_{n \rightarrow \infty} \left[\frac{1^5 + 2^5 + \dots + n^5}{n^6} \right] = \int_0^1 x^5 dx = \left[\frac{x^6}{6} \right]_0^1 = \frac{1}{6}
 \end{aligned}$$

24. Let $f(x) = x^3$ on $[0, 1]$. Partition $[0, 1]$ into n subintervals with $\Delta x = \frac{1-0}{n} = \frac{1}{n}$. Then $\frac{1}{n}, \frac{2}{n}, \dots, \frac{n}{n}$ are the right-hand endpoints of the subintervals. Since f is increasing on $[0, 1]$, $U = \sum_{j=1}^n \left(\frac{j}{n}\right)^3 \left(\frac{1}{n}\right)$ is the upper sum for $f(x) = x^3$ on $[0, 1] \Rightarrow \lim_{n \rightarrow \infty} \sum_{j=1}^n \left(\frac{j}{n}\right)^3 \left(\frac{1}{n}\right) = \lim_{n \rightarrow \infty} \frac{1}{n} \left[\left(\frac{1}{n}\right)^3 + \left(\frac{2}{n}\right)^3 + \dots + \left(\frac{n}{n}\right)^3 \right] = \lim_{n \rightarrow \infty} \left[\frac{1^3 + 2^3 + \dots + n^3}{n^4} \right] = \int_0^1 x^3 dx = \left[\frac{x^4}{4} \right]_0^1 = \frac{1}{4}$
25. Let $y = f(x)$ on $[0, 1]$. Partition $[0, 1]$ into n subintervals with $\Delta x = \frac{1-0}{n} = \frac{1}{n}$. Then $\frac{1}{n}, \frac{2}{n}, \dots, \frac{n}{n}$ are the right-hand endpoints of the subintervals. Since f is continuous on $[0, 1]$, $\sum_{j=1}^n f\left(\frac{j}{n}\right) \left(\frac{1}{n}\right)$ is a Riemann sum of $y = f(x)$ on $[0, 1] \Rightarrow \lim_{n \rightarrow \infty} \sum_{j=1}^n f\left(\frac{j}{n}\right) \left(\frac{1}{n}\right) = \lim_{n \rightarrow \infty} \frac{1}{n} \left[f\left(\frac{1}{n}\right) + f\left(\frac{2}{n}\right) + \dots + f\left(\frac{n}{n}\right) \right] = \int_0^1 f(x) dx$
26. (a) $\lim_{n \rightarrow \infty} \frac{1}{n^2} [2 + 4 + 6 + \dots + 2n] = \lim_{n \rightarrow \infty} \frac{1}{n} \left[\frac{2}{n} + \frac{4}{n} + \frac{6}{n} + \dots + \frac{2n}{n} \right] = \int_0^1 2x dx = [x^2]_0^1 = 1$, where $f(x) = 2x$ on $[0, 1]$ (see Exercise 21)
- (b) $\lim_{n \rightarrow \infty} \frac{1}{n^{16}} [1^{15} + 2^{15} + \dots + n^{15}] = \lim_{n \rightarrow \infty} \frac{1}{n} \left[\left(\frac{1}{n}\right)^{15} + \left(\frac{2}{n}\right)^{15} + \dots + \left(\frac{n}{n}\right)^{15} \right] = \int_0^1 x^{15} dx = \left[\frac{x^{16}}{16} \right]_0^1 = \frac{1}{16}$, where $f(x) = x^{15}$ on $[0, 1]$ (see Exercise 21)
- (c) $\lim_{n \rightarrow \infty} \frac{1}{n} \left[\sin \frac{\pi}{n} + \sin \frac{2\pi}{n} + \dots + \sin \frac{n\pi}{n} \right] = \int_0^1 \sin n\pi dx = \left[-\frac{1}{\pi} \cos \pi x \right]_0^1 = -\frac{1}{\pi} \cos \pi - \left(-\frac{1}{\pi} \cos 0 \right) = \frac{2}{\pi}$, where $f(x) = \sin \pi x$ on $[0, 1]$ (see Exercise 21)
- (d) $\lim_{n \rightarrow \infty} \frac{1}{n^{17}} [1^{15} + 2^{15} + \dots + n^{15}] = \left(\lim_{n \rightarrow \infty} \frac{1}{n} \right) \left(\lim_{n \rightarrow \infty} \frac{1}{n^{16}} [1^{15} + 2^{15} + \dots + n^{15}] \right) = \left(\lim_{n \rightarrow \infty} \frac{1}{n} \right) \int_0^1 x^{15} dx = 0 \left(\frac{1}{16} \right) = 0$ (see part (b) above)
- (e) $\lim_{n \rightarrow \infty} \frac{1}{n^{15}} [1^{15} + 2^{15} + \dots + n^{15}] = \lim_{n \rightarrow \infty} \frac{n}{n^{16}} [1^{15} + 2^{15} + \dots + n^{15}] = \left(\lim_{n \rightarrow \infty} n \right) \left(\lim_{n \rightarrow \infty} \frac{1}{n^{16}} [1^{15} + 2^{15} + \dots + n^{15}] \right) = \left(\lim_{n \rightarrow \infty} n \right) \int_0^1 x^{15} dx = \infty$ (see part (b) above)
27. (a) Let the polygon be inscribed in a circle of radius r . If we draw a radius from the center of the circle (and the polygon) to each vertex of the polygon, we have n isosceles triangles formed (the equal sides are equal to r , the radius of the circle) and a vertex angle of θ_n where $\theta_n = \frac{2\pi}{n}$. The area of each triangle is $A_n = \frac{1}{2} r^2 \sin \theta_n \Rightarrow$ the area of the polygon is $A = nA_n = \frac{nr^2}{2} \sin \theta_n = \frac{nr^2}{2} \sin \frac{2\pi}{n}$.
- (b) $\lim_{n \rightarrow \infty} A = \lim_{n \rightarrow \infty} \frac{nr^2}{2} \sin \frac{2\pi}{n} = \lim_{n \rightarrow \infty} \frac{n\pi r^2}{2\pi} \sin \frac{2\pi}{n} = \lim_{n \rightarrow \infty} \left(\pi r^2 \right) \frac{\sin\left(\frac{2\pi}{n}\right)}{\left(\frac{2\pi}{n}\right)} = \left(\pi r^2 \right) \lim_{2\pi/n \rightarrow 0} \frac{\sin\left(\frac{2\pi}{n}\right)}{\left(\frac{2\pi}{n}\right)} = \pi r^2$
28. Partition $[0, 1]$ into n subintervals, each of length $\Delta x = \frac{1}{n}$ with the points $x_0 = 0, x_1 = \frac{1}{n}, x_2 = \frac{2}{n}, \dots, x_n = \frac{n}{n} = 1$. The inscribed rectangles so determined have areas $f(x_0) \Delta x = (0)^2 \Delta x, f(x_1) \Delta x = \left(\frac{1}{n}\right)^2 \Delta x, f(x_2) \Delta x = \left(\frac{2}{n}\right)^2 \Delta x, \dots, f(x_{n-1}) \Delta x = \left(\frac{n-1}{n}\right)^2 \Delta x$. The sum of these areas is $S_n = \left(0^2 + \left(\frac{1}{n}\right)^2 + \left(\frac{2}{n}\right)^2 + \dots + \left(\frac{n-1}{n}\right)^2 \right) \Delta x = \left(\frac{1^2}{n^2} + \frac{2^2}{n^2} + \dots + \frac{(n-1)^2}{n^2} \right) \frac{1}{n} = \frac{1^2}{n^3} + \frac{2^2}{n^3} + \dots + \frac{(n-1)^2}{n^3}$. Then $\lim_{n \rightarrow \infty} S_n = \lim_{n \rightarrow \infty} \left(\frac{1^2}{n^3} + \frac{2^2}{n^3} + \dots + \frac{(n-1)^2}{n^3} \right) = \int_0^1 x^2 dx = \frac{1^3}{3} = \frac{1}{3}$.

29. (a) $g(1) = \int_1^1 f(t) dt = 0$
- (b) $g(3) = \int_1^3 f(t) dt = -\frac{1}{2}(2)(1) = -1$
- (c) $g(-1) = \int_1^{-1} f(t) dt = -\int_{-1}^1 f(t) dt = -\frac{1}{4}(\pi 2^2) = -\pi$
- (d) $g'(x) = f(x) = 0 \Rightarrow x = -3, 1, 3$ and the sign chart for $g'(x) = f(x)$ is $\begin{array}{c|c|c|c} & -3 & 1 & 3 \\ \hline & + & + & + \\ \hline & - & - & - \\ \hline & + & + & + \end{array}$. So g has a relative maximum at $x = 1$.
- (e) $g'(-1) = f(-1) = 2$ is the slope and $g(-1) = \int_1^{-1} f(t) dt = -\pi$, by (c). Thus the equation is $y + \pi = 2(x + 1) \Rightarrow y = 2x + 2 - \pi$.
- (f) $g''(x) = f'(x) = 0$ at $x = -1$ and $g''(x) = f'(x)$ is negative on $(-3, -1)$ and positive on $(-1, 1)$ so there is an inflection point for g at $x = -1$. We notice that $g''(x) = f'(x) < 0$ for x on $(-1, 2)$ and $g''(x) = f'(x) > 0$ for x on $(2, 4)$, even though $g''(2)$ does not exist, g has a tangent line at $x = 2$, so there is an inflection point at $x = 2$.
- (g) g is continuous on $[-3, 4]$ and so it attains its absolute maximum and minimum values on this interval. We saw in (d) that $g'(x) = 0 \Rightarrow x = -3, 1, 3$. We have that $g(-3) = \int_1^{-3} f(t) dt = -\int_{-3}^1 f(t) dt = -\frac{\pi 2^2}{2} = -2\pi$
- $$g(1) = \int_1^1 f(t) dt = 0$$
- $$g(3) = \int_1^3 f(t) dt = -1$$
- $$g(4) = \int_1^4 f(t) dt = -1 + \frac{1}{2} \cdot 1 \cdot 1 = -\frac{1}{2}$$
- Thus, the absolute minimum is -2π and the absolute maximum is 0. Thus, the range is $[-2\pi, 0]$.

30. $y = \sin x + \int_x^\pi \cos 2t dt + 1 = \sin x - \int_\pi^x \cos 2t dt + 1 \Rightarrow y' = \cos x - \cos(2x)$; when $x = \pi$ we have $y' = \cos \pi - \cos(2\pi) = -1 - 1 = -2$. And $y'' = -\sin x + 2\sin(2x)$; when $x = \pi$, $y = \sin \pi + \int_x^\pi \cos 2t dt + 1 = 0 + 0 + 1 = 1$.

31. $f(x) = \int_{1/x}^x \frac{1}{t} dt \Rightarrow f'(x) = \frac{1}{x} \left(\frac{dx}{dx} \right) - \left(\frac{1}{x} \right) \left(\frac{d}{dx} \left(\frac{1}{x} \right) \right) = \frac{1}{x} - x \left(-\frac{1}{x^2} \right) = \frac{1}{x} + \frac{1}{x} = \frac{2}{x}$

32. $f(x) = \int_{\cos x}^{\sin x} \frac{1}{1-t^2} dt \Rightarrow f'(x) = \left(\frac{1}{1-\sin^2 x} \right) \left(\frac{d}{dx} (\sin x) \right) - \left(\frac{1}{1-\cos^2 x} \right) \left(\frac{d}{dx} (\cos x) \right) = \frac{\cos x}{\cos^2 x} + \frac{\sin x}{\sin^2 x} = \frac{1}{\cos x} + \frac{1}{\sin x}$

33. $g(y) = \int_{\sqrt{y}}^{2\sqrt{y}} \sin t^2 dt \Rightarrow g'(y) = \left(\sin (2\sqrt{y})^2 \right) \left(\frac{d}{dy} (2\sqrt{y}) \right) - \left(\sin (\sqrt{y})^2 \right) \left(\frac{d}{dy} (\sqrt{y}) \right) = \frac{\sin 4y}{\sqrt{y}} - \frac{\sin y}{2\sqrt{y}}$

34. $g(y) = \int_{\sqrt{y}}^{y^2} \frac{e^t}{t} dt \Rightarrow g'(y) = \frac{e^{y^2}}{y^2} \cdot \frac{d}{dy} (y^2) - \frac{e^{\sqrt{y}}}{\sqrt{y}} \cdot \frac{d}{dy} (\sqrt{y}) = \frac{e^{y^2}}{y^2} (2y) - \frac{e^{\sqrt{y}}}{\sqrt{y}} \cdot \frac{1}{2\sqrt{y}} = \frac{4e^{y^2}}{2y} - \frac{e^{\sqrt{y}}}{2y} = \frac{4e^{y^2} - e^{\sqrt{y}}}{2y}$

35. $y = \int_{x^2/2}^{x^2} \ln \sqrt{t} dt \Rightarrow \frac{dy}{dx} = \left(\ln \sqrt{x^2} \right) \cdot \frac{d}{dx} (x^2) - \left(\ln \sqrt{\frac{x^2}{2}} \right) \cdot \frac{d}{dx} \left(\frac{x^2}{2} \right) = 2x \ln |x| - x \ln \frac{|x|}{\sqrt{2}}$

36. $y = \int_{\sqrt{x}}^{\sqrt[3]{x}} \ln t \, dt$
 $\Rightarrow \frac{dy}{dx} = (\ln \sqrt[3]{x}) \cdot \frac{d}{dx}(\sqrt[3]{x}) - (\ln \sqrt{x}) \cdot \frac{d}{dx}(\sqrt{x}) = (\ln \sqrt[3]{x})\left(\frac{1}{3}x^{-2/3}\right) - (\ln \sqrt{x})\left(\frac{1}{2}x^{-1/2}\right) = \frac{\ln \sqrt[3]{x}}{3\sqrt[3]{x^2}} - \frac{\ln \sqrt{x}}{2\sqrt{x}} \sqrt[3]{x}$
37. $\int_0^{\ln x} \sin e^t \, dt \Rightarrow y' = (\sin e^{\ln x}) \cdot \frac{d}{dx}(\ln x) = \frac{\sin x}{x}$
38. $y = \int_{e^{4\sqrt{x}}}^{3^{2x}} \ln t \, dt \Rightarrow y' = (\ln e^{2x}) \cdot \frac{d}{dx}(e^{2x}) - (\ln e^{4\sqrt{x}}) \cdot \frac{d}{dx}(e^{4\sqrt{x}}) = (2x)(2e^{2x}) - (4\sqrt{x})(e^{4\sqrt{x}}) \cdot \frac{d}{dx}(4\sqrt{x})$
 $= 4xe^{2x} - 4\sqrt{x}e^{4\sqrt{x}}\left(\frac{2}{\sqrt{x}}\right) = 4xe^{2x} - 8e^{4\sqrt{x}}$
39. $f(x) = \int_x^{x+3} t(5-t) \, dt \Rightarrow f'(x) = (x+3)(5-(x+3))\left(\frac{d}{dx}(x+3)\right) - x(5-x)\left(\frac{dx}{dx}\right) = (x+3)(2-x) - x(5-x)$
 $= 6 - x - x^2 - 5x + x^2 = 6 - 6x$. Thus $f'(x) = 0 \Rightarrow 6 - 6x = 0 \Rightarrow x = 1$. Also, $f''(x) = -6 < 0 \Rightarrow x = 1$ gives a maximum.
40. $\ln x^{(x^x)} = x^x \ln x$ and $\ln(x^x)^x = x \ln x^x = x^2 \ln x$; then $x^x \ln x = x^2 \ln x \Rightarrow (x^x - x^2) \ln x = 0 \Rightarrow x^x = x^2$ or $\ln x = 0$. $\ln x = 0 \Rightarrow x = 1$; $x^x = x^2 \Rightarrow x \ln x = 2 \ln x \Rightarrow x = 2$. Therefore, $x^{(x^x)} = (x^x)^x$ when $x = 2$ or $x = 1$.
41. $A_1 = \int_1^e \frac{2 \log_2 x}{x} \, dx = \frac{2}{\ln 2} \int_1^e \frac{\ln x}{x} \, dx = \left[\frac{(\ln x)^2}{\ln 2} \right]_1^e = \frac{1}{\ln 2}$;
 $A_2 = \int_1^e \frac{2 \log_4 x}{4} \, dx = \frac{2}{\ln 4} \int_1^e \frac{\ln x}{x} \, dx = \left[\frac{(\ln x)^2}{2 \ln 2} \right]_1^e = \frac{1}{2 \ln 2} \Rightarrow A_1 : A_2 = 2 : 1$
42. (a) $\frac{df}{dx} = \frac{2 \ln e^x}{e^x} \cdot e^x = 2x$
 (b) $f(0) = \int_1^1 \frac{2 \ln t}{t} \, dt = 0$
 (c) $\frac{df}{dx} = 2x \Rightarrow f(x) = x^2 + C$; $f(0) = 0 \Rightarrow C = 0 \Rightarrow f(x) = x^2 \Rightarrow$ the graph of $f(x)$ is a parabola.
43. $f(x) = e^{g(x)} \Rightarrow f'(x) = e^{g(x)} g'(x)$, where $g'(x) = \frac{x}{1+x^4} \Rightarrow f'(2) = e^0 \left(\frac{2}{1+16}\right) = \frac{2}{17}$
44. The area of the blue shaded region is $\int_0^1 \sin^{-1} x \, dx = \int_0^1 \sin^{-1} y \, dy$, which is the same as the area of the region to the left of the curve $y = \sin x$ (and part of the rectangle formed by the coordinate axes and dashed lines $y = 1$, $x = \frac{\pi}{2}$). The area of the rectangle is $\frac{\pi}{2} = \int_0^1 \sin^{-1} y \, dy + \int_0^{\pi/2} \sin x \, dx$, so we have
 $\frac{\pi}{2} = \int_0^1 \sin^{-1} x \, dx + \int_0^{\pi/2} \sin x \, dx \Rightarrow \int_0^{\pi/2} \sin x \, dx = \frac{\pi}{2} - \int_0^1 \sin^{-1} x \, dx$.
45. (a) slope of $L_3 <$ slope of $L_2 <$ slope of $L_1 \Rightarrow \frac{1}{b} < \frac{\ln b - \ln a}{b-a} < \frac{1}{a}$
 (b) area of small (shaded) rectangle $<$ area under curve $<$ area of large rectangle
 $\Rightarrow \frac{1}{b}(b-a) < \int_a^b \frac{1}{x} \, dx < \frac{1}{a}(b-a) \Rightarrow \frac{1}{b} < \frac{\ln b - \ln a}{b-a} < \frac{1}{a}$

46. (a) If f is continuously differentiable on $[a, b]$, then so is the function $g(x) = (x - c)f(x)$. So the two integrals on the right side exist and

$$\begin{aligned} \int_a^c (x - c)f(x) dx + \int_c^b (x - c)f(x) dx &= \int_a^b (x - c)f(x) dx \\ &= \int_a^b x f(x) dx - \int_a^b c f(x) dx = \int_a^b x f(x) dx - c(0) = \int_a^b x f(x) dx \end{aligned}$$

- (b) Split the right side in part (a) into two integrals and write it as $-\int_0^\ell t f(c - t) dt + \int_0^\ell t f(c + t) dt$. For the first integral above, use the substitution $t = c - x, \Rightarrow x = c - t, dt = -dx$; when $t = 0, x = c$ and when $t = \ell = (b - a)/2, x = (a + b)/2 - (b - a)/2 = a$. (Note that when x is in $[a, c], c - x$ is positive and thus $c - x$ agrees in sign with t .) $-\int_0^\ell t f(c - t) dt = \int_\ell^0 t f(c - t) dt = \int_a^c -(x - c)f(x)(-dx) = \int_a^c (x - c)f(x) dx$.

Thus the first integral above is equal to $\int_a^c (x - c)f(x) dx$. For the second integral above, use the substitution $t = x - c, \Rightarrow c + t = x$ and $dt = dx$; when $t = 0, x = c$ and when $t = \ell = (b - a)/2,$

$$\begin{aligned} x = (b - a)/2 + (a + b)/2 = b. \text{ Thus the second integral above is equal to } \int_c^b (x - c)f(x) dx \text{ and} \\ \int_a^b x f(x) dx = \int_a^c (x - c)f(x) dx + \int_c^b (x - c)f(x) dx = \int_0^\ell t f(c + t) dt - \int_0^\ell t f(c - t) dt \\ = \int_0^\ell t(f(c + t) - f(c - t)) dt. \end{aligned}$$

- (c) According to the mean value theorem of Section 4.2, for every t in $(0, \ell)$, there is a point in q in $(c - t, c + t)$ at which $\frac{f(c + t) - f(c - t)}{(c + t) - (c - t)} = \frac{f(c + t) - f(c - t)}{2t} = f'(q)$. Since for all these q belonging to each t , we have $f'(q) \leq M, f(c + t) - f(c - t) \leq 2tM$ for all t in $(0, \ell)$. Thus

$$\left| \int_a^b x f(x) dx \right| = \left| \int_0^\ell t(f(c + t) - f(c - t)) dt \right| \leq \int_0^\ell (t)(2tM) = \frac{2}{3} M t^3 \Big|_0^{(b-a)/2} = \frac{(b-a)^3}{12} M.$$

CHAPTER 6 APPLICATIONS OF DEFINITE INTEGRALS

6.1 VOLUMES USING CROSS-SECTIONS

$$1. A(x) = \frac{(\text{diagonal})^2}{2} = \frac{(\sqrt{x} - (-\sqrt{x}))^2}{2} = 2x; \quad a = 0, b = 4; \quad V = \int_a^b A(x) dx = \int_0^4 2x dx = \left[x^2 \right]_0^4 = 16$$

$$2. A(x) = \frac{\pi(\text{diameter})^2}{4} = \frac{\pi[(2-x^2) - x^2]^2}{4} = \frac{\pi[2(1-x^2)]^2}{4} = \pi(1-2x^2+x^4); \quad a = -1, b = 1;$$

$$V = \int_a^b A(x) dx = \int_{-1}^1 \pi(1-2x^2+x^4) dx = \pi \left[x - \frac{2}{3}x^3 + \frac{x^5}{5} \right]_{-1}^1 = 2\pi \left(1 - \frac{2}{3} + \frac{1}{5} \right) = \frac{16\pi}{15}$$

$$3. A(x) = (\text{edge})^2 = \left[\sqrt{1-x^2} - (-\sqrt{1-x^2}) \right]^2 = \left(2\sqrt{1-x^2} \right)^2 = 4(1-x^2); \quad a = -1, b = 1;$$

$$V = \int_a^b A(x) dx = \int_{-1}^1 4(1-x^2) dx = 4 \left[x - \frac{x^3}{3} \right]_{-1}^1 = 8 \left(1 - \frac{1}{3} \right) = \frac{16}{3}$$

$$4. A(x) = \frac{(\text{diagonal})^2}{2} = \frac{[\sqrt{1-x^2} - (-\sqrt{1-x^2})]^2}{2} = 2 \frac{(2\sqrt{1-x^2})^2}{2} = 2(1-x^2); \quad a = -1, b = 1;$$

$$V = \int_a^b A(x) dx = 2 \int_{-1}^1 (1-x^2) dx = 2 \left[x - \frac{x^3}{3} \right]_{-1}^1 = 4 \left(1 - \frac{1}{3} \right) = \frac{8}{3}$$

$$5. (a) \text{ STEP 1) } A(x) = \frac{1}{2}(\text{side}) \cdot (\text{side}) \cdot \left(\sin \frac{\pi}{3} \right) = \frac{1}{2} \cdot (2\sqrt{\sin x}) \cdot (2\sqrt{\sin x}) \left(\sin \frac{\pi}{3} \right) = \sqrt{3} \sin x$$

$$\text{STEP 2) } a = 0, b = \pi$$

$$\text{STEP 3) } V = \int_a^b A(x) dx = \sqrt{3} \int_0^\pi \sin x dx = \left[-\sqrt{3} \cos x \right]_0^\pi = \sqrt{3}(1+1) = 2\sqrt{3}$$

$$(b) \text{ STEP 1) } A(x) = (\text{side})^2 = (2\sqrt{\sin x}) (2\sqrt{\sin x}) = 4 \sin x$$

$$\text{STEP 2) } a = 0, b = \pi$$

$$\text{STEP 3) } V = \int_a^b A(x) dx = \int_0^\pi 4 \sin x dx = \left[-4 \cos x \right]_0^\pi = 8$$

$$6. (a) \text{ STEP 1) } A(x) = \frac{\pi(\text{diameter})^2}{4} = \frac{\pi}{4}(\sec x - \tan x)^2 = \frac{\pi}{4}(\sec^2 x + \tan^2 x - 2 \sec x \tan x)$$

$$= \frac{\pi}{4} \left[\sec^2 x + (\sec^2 x - 1) - 2 \frac{\sin x}{\cos^2 x} \right]$$

$$\text{STEP 2) } a = -\frac{\pi}{3}, b = \frac{\pi}{3}$$

$$\text{STEP 3) } V = \int_a^b A(x) dx = \int_{-\pi/3}^{\pi/3} \frac{\pi}{4} \left(2 \sec^2 x - 1 - \frac{2 \sin x}{\cos^2 x} \right) dx = \frac{\pi}{4} \left[2 \tan x - x + 2 \left(-\frac{1}{\cos x} \right) \right]_{-\pi/3}^{\pi/3}$$

$$= \frac{\pi}{4} \left[2\sqrt{3} - \frac{\pi}{3} + 2 \left(-\frac{1}{\left(\frac{1}{2}\right)} \right) - \left(-2\sqrt{3} + \frac{\pi}{3} + 2 \left(-\frac{1}{\left(\frac{1}{2}\right)} \right) \right) \right] = \frac{\pi}{4} \left(4\sqrt{3} - \frac{2\pi}{3} \right)$$

(b) STEP 1) $A(x) = (\text{edge})^2 = (\sec x - \tan x)^2 = \left(2 \sec^2 x - 1 - 2 \frac{\sin x}{\cos^2 x}\right)$

STEP 2) $a = -\frac{\pi}{3}, b = \frac{\pi}{3}$

STEP 3) $V = \int_a^b A(x) dx = \int_{-\pi/3}^{\pi/3} \left(2 \sec^2 x - 1 - \frac{2 \sin x}{\cos^2 x}\right) dx = 2 \left(2\sqrt{3} - \frac{\pi}{3}\right) = 4\sqrt{3} - \frac{2\pi}{3}$

7. (a) STEP 1) $A(x) = (\text{length}) \cdot (\text{height}) = (6 - 3x) \cdot (10) = 60 - 30x$

STEP 2) $a = 0, b = 2$

STEP 3) $V = \int_a^b A(x) dx = \int_0^2 (60 - 30x) dx = \left[60x - 15x^2\right]_0^2 = (120 - 60) - 0 = 60$

(b) STEP 1) $A(x) = (\text{length}) \cdot (\text{height}) = (6 - 3x) \cdot \left(\frac{20 - 2(6 - 3x)}{2}\right) = (6 - 3x)(4 + 3x) = 24 + 6x - 9x^2$

STEP 2) $a = 0, b = 2$

STEP 3) $V = \int_a^b A(x) dx = \int_0^2 (24 + 6x + 9x^2) dx = \left[24x + 3x^2 - 3x^3\right]_0^2 = (48 + 12 - 24) - 0 = 36$

8. (a) STEP 1) $A(x) = \frac{1}{2}(\text{base}) \cdot (\text{height}) = \left(\sqrt{x} - \frac{x}{2}\right) \cdot (6) = 6\sqrt{x} - 3x$

STEP 2) $a = 0, b = 4$

STEP 3) $V = \int_a^b A(x) dx = \int_0^4 (6x^{1/2} - 3x) dx = \left[4x^{3/2} - \frac{3}{2}x^2\right]_0^4 = (32 - 24) - 0 = 8$

(b) STEP 1) $A(x) = \frac{1}{2} \cdot \pi \left(\frac{\text{diameter}}{2}\right)^2 = \frac{1}{2} \cdot \pi \left(\frac{\sqrt{x} - \frac{x}{2}}{2}\right)^2 = \frac{\pi}{2} \cdot \frac{x - x^{3/2} + \frac{1}{4}x^2}{4} = \frac{\pi}{8} \left(x - x^{3/2} + \frac{1}{4}x^2\right)$

STEP 2) $a = 0, b = 4$

STEP 3) $V = \int_a^b A(x) dx = \frac{\pi}{8} \int_0^4 \left(x - x^{3/2} + \frac{1}{4}x^2\right) dx = \left[\frac{1}{2}x^2 - \frac{2}{5}x^{5/2} + \frac{1}{12}x^3\right]_0^4 = \frac{\pi}{8} \left(8 - \frac{64}{5} + \frac{16}{3}\right) - \frac{\pi}{8}(0) = \frac{\pi}{15}$

9. $A(y) = \frac{\pi}{4}(\text{diameter})^2 = \frac{\pi}{4}(\sqrt{5}y^2 - 0)^2 = \frac{5\pi}{4}y^4;$

$c = 0, d = 2; V = \int_c^d A(y) dy$

$= \int_0^2 \frac{5\pi}{4}y^4 dy = \left[\left(\frac{5\pi}{4}\right)\left(\frac{y^5}{5}\right)\right]_0^2 = \frac{\pi}{4}(2^5 - 0) = 8\pi$

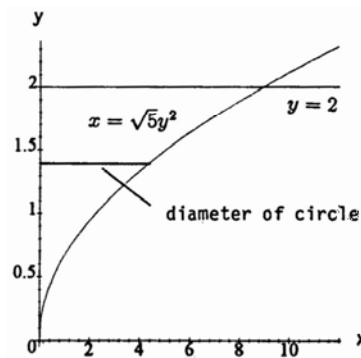

10. $A(y) = \frac{1}{2}(\text{leg})(\text{leg}) = \frac{1}{2} \left[\sqrt{1 - y^2} - \left(-\sqrt{1 - y^2}\right) \right]^2 = \frac{1}{2} \left(2\sqrt{1 - y^2} \right)^2 = 2(1 - y^2); c = -1, d = 1;$

$V = \int_c^d A(y) dy = \int_{-1}^1 2(1 - y^2) dy = 2 \left[y - \frac{y^3}{3} \right]_{-1}^1 = 4 \left(1 - \frac{1}{3} \right) = \frac{8}{3}$

11. The slices perpendicular to the edge labeled 5 are triangles, and by similar triangles we have $\frac{b}{h} = \frac{4}{3} \Rightarrow h = \frac{3}{4}b$. The equation of the line through (5, 0) and (0, 4) is $y = -\frac{4}{5}x + 4$, thus the length of the base $= -\frac{4}{5}x + 4$ and the height $= \frac{3}{4}(-\frac{4}{5}x + 4) = -\frac{3}{5}x + 3$. Thus $A(x) = \frac{1}{2}(\text{base}) \cdot (\text{height}) = \frac{1}{2}(-\frac{4}{5}x + 4) \cdot (-\frac{3}{5}x + 3)$
 $= \frac{6}{25}x^2 - \frac{12}{5}x + 6$ and $V = \int_a^b A(x) dx = \int_0^5 (\frac{6}{25}x^2 - \frac{12}{5}x + 6) dx = [\frac{2}{25}x^3 - \frac{6}{5}x^2 + 6x]_0^5 = (10 - 30 + 30) - 0 = 10$

12. The slices parallel to the base are squares. The cross section of the pyramid is a triangle, and by similar triangles we have $\frac{b}{h} = \frac{3}{5} \Rightarrow b = \frac{3}{5}h$. Thus $A(y) = (\text{base})^2 = (\frac{3}{5}y)^2 = \frac{9}{25}y^2 \Rightarrow V = \int_c^d A(y) dy = \int_0^5 \frac{9}{25}y^2 dy$
 $= [\frac{3}{25}y^3]_0^5 = 15 - 0 = 15$

13. (a) It follows from Cavalieri's Principle that the volume of a column is the same as the volume of a right prism with a square base of side length s and altitude h . Thus,
 STEP 1) $A(x) = (\text{sidelength})^2 = s^2$;
 STEP 2) $a = 0, b = h$;
 STEP 3) $V = \int_a^b A(x) dx = \int_0^h s^2 dx = s^2h$
 (b) From Cavalieri's Principle we conclude that the volume of the column is the same as the volume of the prism described above, regardless of the number of turns $\Rightarrow V = s^2h$

14. 1) The solid and the cone have the same altitude of 12.
 2) The cross sections of the solid are disks of diameter $x - (\frac{x}{2}) = \frac{x}{2}$. If we place the vertex of the cone at the origin of the coordinate system and make its axis of symmetry coincide with the x -axis then the cone's cross sections will be circular disks of diameter $\frac{x}{4} - (-\frac{x}{4}) = \frac{x}{2}$ (see accompanying figure).
 3) The solid and the cone have equal altitudes and identical parallel cross sections. From Cavalier's Principle we conclude that the solid and the cone have the same volume.

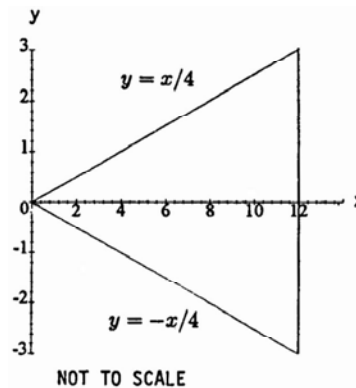

15. $R(x) = y = 1 - \frac{x}{2} \Rightarrow V = \int_0^2 \pi [R(x)]^2 dx = \pi \int_0^2 (1 - \frac{x}{2})^2 dx = \pi \int_0^2 (1 - x + \frac{x^2}{4}) dx = \pi [x - \frac{x^2}{2} + \frac{x^3}{12}]_0^2$
 $= \pi (2 - \frac{4}{2} + \frac{8}{12}) = \frac{2\pi}{3}$

16. $R(y) = x = \frac{3y}{2} \Rightarrow V = \int_0^2 \pi [R(y)]^2 dy = \pi \int_0^2 (\frac{3y}{2})^2 dy = \pi \int_0^2 \frac{9}{4}y^2 dy = \pi [\frac{3}{4}y^3]_0^2 = \pi \cdot \frac{3}{4} \cdot 8 = 6\pi$

17. $R(y) = \tan(\frac{\pi}{4}y); u = \frac{\pi}{4}y \Rightarrow du = \frac{\pi}{4}dy \Rightarrow 4 du = \pi dy; y = 0 \Rightarrow u = 0, y = 1 \Rightarrow u = \frac{\pi}{4};$
 $V = \int_0^1 \pi [R(y)]^2 dy = \pi \int_0^1 [\tan(\frac{\pi}{4}y)]^2 dy = 4 \int_0^{\pi/4} \tan^2 u du = 4 \int_0^{\pi/4} (-1 + \sec^2 u) du = 4 [-u + \tan u]_0^{\pi/4}$
 $= 4(-\frac{\pi}{4} + 1 - 0) = 4 - \pi$

18. $R(x) = \sin x \cos x$; $R(x) = 0 \Rightarrow a = 0$ and $b = \frac{\pi}{2}$ are the limits of integration;

$$V = \int_0^{\pi/2} \pi [R(x)]^2 dx = \pi \int_0^{\pi/2} (\sin x \cos x)^2 dx = \pi \int_0^{\pi/2} \frac{(\sin 2x)^2}{4} dx; \left[u = 2x \Rightarrow du = 2 dx \Rightarrow \frac{du}{8} = \frac{dx}{4}; \right.$$

$$x = 0 \Rightarrow u = 0, x = \frac{\pi}{2} \Rightarrow u = \pi \left. \right] \rightarrow V = \pi \int_0^{\pi} \frac{1}{8} \sin^2 u du = \frac{\pi}{8} \left[\frac{u}{2} - \frac{1}{4} \sin 2u \right]_0^{\pi} = \frac{\pi}{8} \left[\left(\frac{\pi}{2} - 0 \right) - 0 \right] = \frac{\pi^2}{16}$$

19. $R(x) = x^2 \Rightarrow V = \int_0^2 \pi [R(x)]^2 dx$

$$= \pi \int_0^2 (x^2)^2 dx = \pi \int_0^2 x^4 dx = \pi \left[\frac{x^5}{5} \right]_0^2 = \frac{32\pi}{5}$$

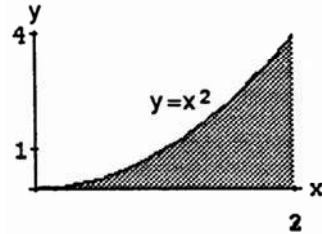

20. $R(x) = x^3 \Rightarrow V = \int_0^2 \pi [R(x)]^2 dx$

$$= \pi \int_0^2 (x^3)^2 dx = \pi \int_0^2 x^6 dx = \pi \left[\frac{x^7}{7} \right]_0^2 = \frac{128\pi}{7}$$

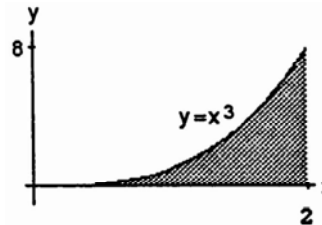

21. $R(x) = \sqrt{9-x^2} \Rightarrow V = \int_{-3}^3 \pi [R(x)]^2 dx$

$$= \pi \int_{-3}^3 (9-x^2) dx = \pi \left[9x - \frac{x^3}{3} \right]_{-3}^3$$

$$= 2\pi \left[9(3) - \frac{27}{3} \right] = 2 \cdot \pi \cdot 18 = 36\pi$$

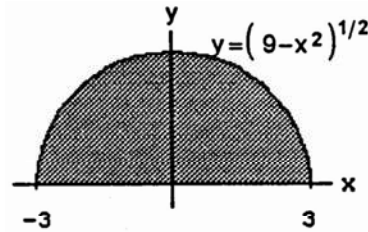

22. $R(x) = x - x^2 \Rightarrow V = \int_0^1 \pi [R(x)]^2 dx$

$$= \pi \int_0^1 (x - x^2)^2 dx = \pi \int_0^1 (x^2 - 2x^3 + x^4) dx$$

$$= \pi \left[\frac{x^3}{3} - \frac{2x^4}{4} + \frac{x^5}{5} \right]_0^1 = \pi \left(\frac{1}{3} - \frac{1}{2} + \frac{1}{5} \right)$$

$$= \frac{\pi}{30} (10 - 15 + 6) = \frac{\pi}{30}$$

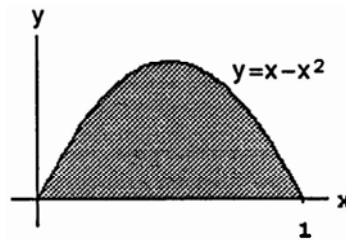

23. $R(x) = \sqrt{\cos x} \Rightarrow V = \int_0^{\pi/2} \pi [R(x)]^2 dx$

$$= \pi \int_0^{\pi/2} \cos x dx = \pi [\sin x]_0^{\pi/2} = \pi(1-0) = \pi$$

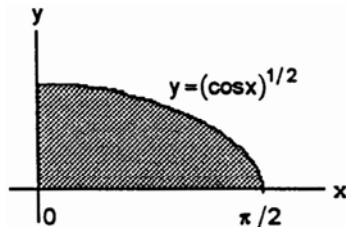

$$\begin{aligned}
 24. \quad R(x) = \sec x &\Rightarrow V = \int_{-\pi/4}^{\pi/4} \pi [R(x)]^2 dx \\
 &= \pi \int_{-\pi/4}^{\pi/4} \sec^2 x dx = \pi [\tan x]_{-\pi/4}^{\pi/4} = \pi[1 - (-1)] = 2\pi
 \end{aligned}$$

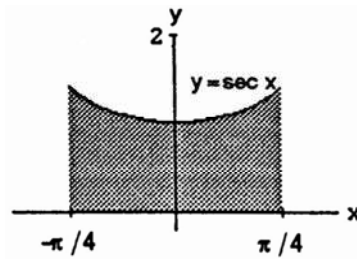

$$\begin{aligned}
 25. \quad R(x) = e^{-x} &\Rightarrow V = \int_0^1 \pi [R(x)]^2 dx = \pi \int_0^1 (e^{-x})^2 dx \\
 &= \pi \int_0^1 e^{-2x} dx = -\frac{\pi}{2} e^{-2x} \Big|_0^1 = -\frac{\pi}{2} (e^{-2} - 1) \\
 &= \frac{\pi}{2} \left(1 - \frac{1}{e^2}\right) = \frac{\pi(e^2 - 1)}{2e^2}
 \end{aligned}$$

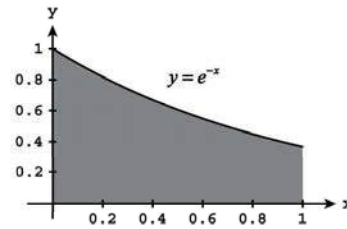

$$\begin{aligned}
 26. \quad R(x) = \sqrt{\cot x} &\Rightarrow V = \int_{\pi/6}^{\pi/2} \pi [R(x)]^2 dx = \pi \int_{\pi/6}^{\pi/2} (\sqrt{\cot x})^2 dx = \pi \int_{\pi/6}^{\pi/2} \cot x dx = \pi \int_{\pi/6}^{\pi/2} \frac{\cos x}{\sin x} dx \\
 &= \pi [\ln(\sin x)]_{\pi/6}^{\pi/2} \\
 &= \pi \left(\ln 1 - \ln \frac{1}{2}\right) = \pi \ln 2
 \end{aligned}$$

$$27. \quad R(x) = \frac{1}{2\sqrt{x}} \Rightarrow V = \int_{1/4}^4 \pi [R(x)]^2 dx = \pi \int_{1/4}^4 \left(\frac{1}{2\sqrt{x}}\right)^2 dx = \frac{\pi}{4} \int_{1/4}^4 \frac{1}{x} dx = \frac{\pi}{4} [\ln x]_{1/4}^4 = \frac{\pi}{4} \left(\ln 4 - \ln \frac{1}{4}\right) = \frac{\pi}{2} \ln 4$$

$$28. \quad R(x) = e^{x-1} \Rightarrow V = \int_1^3 \pi [R(x)]^2 dx = \pi \int_1^3 (e^{x-1})^2 dx = \pi \int_1^3 e^{2x-2} dx = \frac{\pi}{2} [e^{2x-2}]_1^3 = \frac{\pi}{2} (e^4 - 1) \approx 84.19$$

$$\begin{aligned}
 29. \quad R(x) = \sqrt{2} - \sec x \tan x &\Rightarrow V = \int_0^{\pi/4} \pi [R(x)]^2 dx \\
 &= \pi \int_0^{\pi/4} (\sqrt{2} - \sec x \tan x)^2 dx \\
 &= \pi \int_0^{\pi/4} (2 - 2\sqrt{2} \sec x \tan x + \sec^2 x \tan^2 x) dx \\
 &= \pi \left(\int_0^{\pi/4} 2 dx - 2\sqrt{2} \int_0^{\pi/4} \sec x \tan x dx \right. \\
 &\quad \left. + \int_0^{\pi/4} (\tan x)^2 \sec^2 x dx \right) \\
 &= \pi \left([2x]_0^{\pi/4} - 2\sqrt{2} [\sec x]_0^{\pi/4} + \left[\frac{\tan^3 x}{3}\right]_0^{\pi/4} \right) \\
 &= \pi \left[\left(\frac{\pi}{2} - 0\right) - 2\sqrt{2} (\sqrt{2} - 1) + \frac{1}{3} (1^3 - 0) \right] \\
 &= \pi \left(\frac{\pi}{2} + 2\sqrt{2} - \frac{11}{3} \right)
 \end{aligned}$$

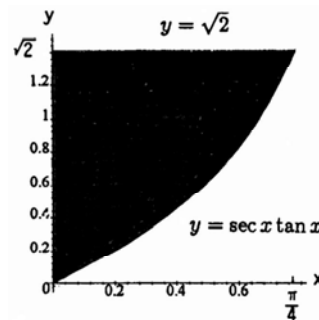

$$\begin{aligned}
 30. \quad R(x) &= 2 - 2 \sin x = 2(1 - \sin x) \Rightarrow V = \int_0^{\pi/2} \pi [R(x)]^2 dx \\
 &= \pi \int_0^{\pi/2} 4(1 - \sin x)^2 dx = 4\pi \int_0^{\pi/2} (1 + \sin^2 x - 2 \sin x) dx \\
 &= 4\pi \int_0^{\pi/2} \left[1 + \frac{1}{2}(1 - \cos 2x) - 2 \sin x \right] dx \\
 &= 4\pi \int_0^{\pi/2} \left(\frac{3}{2} - \frac{\cos 2x}{2} - 2 \sin x \right) dx \\
 &= 4\pi \left[\frac{3}{2}x - \frac{\sin 2x}{4} + 2 \cos x \right]_0^{\pi/2} \\
 &= 4\pi \left[\left(\frac{3\pi}{4} - 0 + 0 \right) - (0 - 0 + 2) \right] = \pi(3\pi - 8)
 \end{aligned}$$

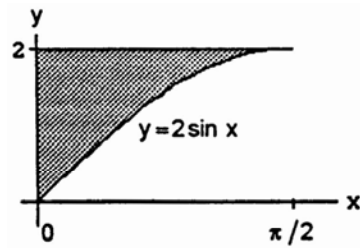

$$\begin{aligned}
 31. \quad R(y) &= \sqrt{5}y^2 \Rightarrow V = \int_{-1}^1 \pi [R(y)]^2 dy = \pi \int_{-1}^1 5y^4 dy \\
 &= \pi \left[y^5 \right]_{-1}^1 = \pi[1 - (-1)] = 2\pi
 \end{aligned}$$

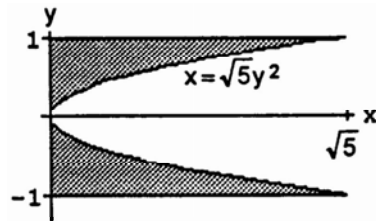

$$\begin{aligned}
 32. \quad R(y) &= y^{3/2} \Rightarrow V = \int_0^2 \pi [R(y)]^2 dy = \pi \int_0^2 y^3 dy \\
 &= \pi \left[\frac{y^4}{4} \right]_0^2 = 4\pi
 \end{aligned}$$

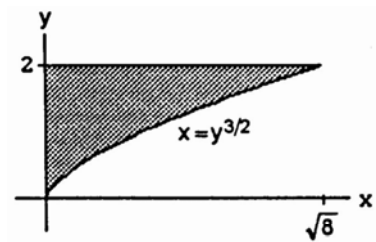

$$\begin{aligned}
 33. \quad R(y) &= \sqrt{2 \sin 2y} \Rightarrow V = \int_0^{\pi/2} \pi [R(y)]^2 dy \\
 &= \pi \int_0^{\pi/2} 2 \sin 2y dy = \pi [-\cos 2y]_0^{\pi/2} \\
 &= \pi[1 - (-1)] = 2\pi
 \end{aligned}$$

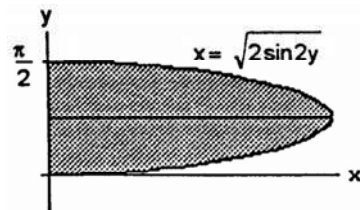

$$\begin{aligned}
 34. \quad R(y) &= \sqrt{\cos \frac{\pi y}{4}} \Rightarrow V = \int_{-2}^0 \pi [R(y)]^2 dy \\
 &= \pi \int_{-2}^0 \cos \left(\frac{\pi y}{4} \right) dy = 4 \left[\sin \frac{\pi y}{4} \right]_{-2}^0 = 4[0 - (-1)] = 4
 \end{aligned}$$

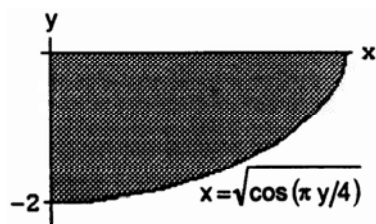

$$\begin{aligned}
 35. \quad R(y) &= \frac{2}{y+1} \Rightarrow V = \int_0^3 \pi [R(y)]^2 dy = 4\pi \int_0^3 \frac{1}{(y+1)^2} dy \\
 &= 4\pi \left[-\frac{1}{y+1} \right]_0^3 = 4\pi \left[-\frac{1}{4} - (-1) \right] = 3\pi
 \end{aligned}$$

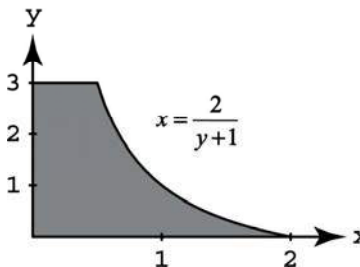

$$\begin{aligned}
 36. \quad R(y) &= \sqrt{\frac{2y}{y^2+1}} \Rightarrow V = \int_0^1 \pi [R(y)]^2 dy \\
 &= \pi \int_0^1 2y (y^2+1)^{-2} dy; \quad [u = y^2+1 \Rightarrow du = 2y dy; \\
 & \quad y=0 \Rightarrow u=1, y=1 \Rightarrow u=2] \\
 &\rightarrow V = \pi \int_1^2 u^{-2} du = \pi \left[-\frac{1}{u} \right]_1^2 = \pi \left[-\frac{1}{2} - (-1) \right] = \frac{\pi}{2}
 \end{aligned}$$

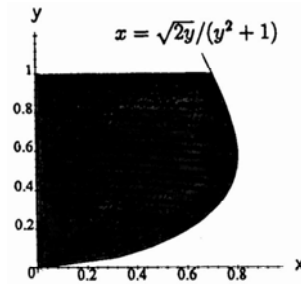

$$\begin{aligned}
 37. \quad \text{For the sketch given, } a = -\frac{\pi}{2}, b = \frac{\pi}{2}; R(x) = 1, r(x) = \sqrt{\cos x}; V &= \int_a^b \pi ([R(x)]^2 - [r(x)]^2) dx \\
 &= \int_{-\pi/2}^{\pi/2} \pi (1 - \cos x) dx = 2\pi \int_0^{\pi/2} (1 - \cos x) dx = 2\pi [x - \sin x]_0^{\pi/2} = 2\pi \left(\frac{\pi}{2} - 1 \right) = \pi^2 - 2\pi
 \end{aligned}$$

$$\begin{aligned}
 38. \quad \text{For the sketch given, } c = 0, d = \frac{\pi}{4}; R(y) = 1, r(y) = \tan y; V &= \int_c^d \pi ([R(y)]^2 - [r(y)]^2) dy \\
 &= \pi \int_0^{\pi/4} (1 - \tan^2 y) dy = \pi \int_0^{\pi/4} (2 - \sec^2 y) dy = \pi [2y - \tan y]_0^{\pi/4} = \pi \left(\frac{\pi}{2} - 1 \right) = \frac{\pi^2}{2} - \pi
 \end{aligned}$$

$$\begin{aligned}
 39. \quad r(x) = x \text{ and } R(x) = 1 \Rightarrow V &= \int_0^1 \pi ([R(x)]^2 - [r(x)]^2) dx \\
 &= \int_0^1 \pi (1 - x^2) dx = \pi \left[x - \frac{x^3}{3} \right]_0^1 = \pi \left[\left(1 - \frac{1}{3} \right) - 0 \right] = \frac{2\pi}{3}
 \end{aligned}$$

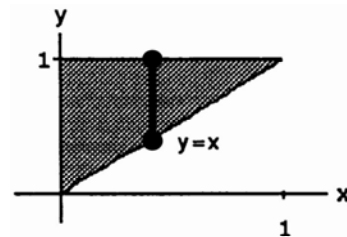

$$\begin{aligned}
 40. \quad r(x) = 2\sqrt{x} \text{ and } R(x) = 2 \Rightarrow V &= \int_0^1 \pi ([R(x)]^2 - [r(x)]^2) dx \\
 &= \pi \int_0^1 (4 - 4x) dx = 4\pi \left[x - \frac{x^2}{2} \right]_0^1 = 4\pi \left(1 - \frac{1}{2} \right) = 2\pi
 \end{aligned}$$

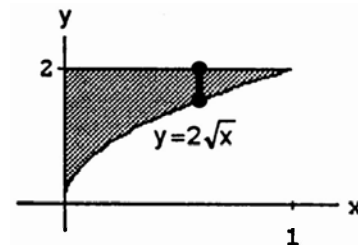

$$\begin{aligned}
 41. \quad r(x) = x^2 + 1 \text{ and } R(x) = x + 3 \\
 \Rightarrow V &= \int_{-1}^2 \pi ([R(x)]^2 - [r(x)]^2) dx \\
 &= \pi \int_{-1}^2 [(x+3)^2 - (x^2+1)^2] dx \\
 &= \pi \int_{-1}^2 [(x^2+6x+9) - (x^4+2x^2+1)] dx \\
 &= \pi \int_{-1}^2 (-x^4 - x^2 + 6x + 8) dx = \pi \left[-\frac{x^5}{5} - \frac{x^3}{3} + \frac{6x^2}{2} + 8x \right]_{-1}^2 \\
 &= \pi \left[\left(-\frac{32}{5} - \frac{8}{3} + 24 + 16 \right) - \left(\frac{1}{5} + \frac{1}{3} + \frac{6}{2} - 8 \right) \right] \\
 &= \pi \left(-\frac{33}{5} - 3 + 28 - 3 + 8 \right) = \pi \left(\frac{5 \cdot 30 - 33}{5} \right) = \frac{117\pi}{5}
 \end{aligned}$$

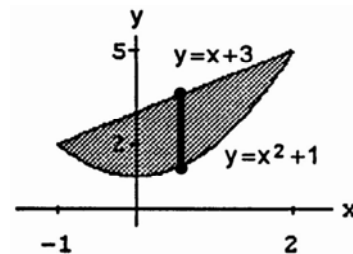

42. $r(x) = 2 - x$ and $R(x) = 4 - x^2$

$$\begin{aligned} \Rightarrow V &= \int_{-1}^2 \pi \left([R(x)]^2 - [r(x)]^2 \right) dx \\ &= \pi \int_{-1}^2 \left[(4 - x^2)^2 - (2 - x)^2 \right] dx \\ &= \pi \int_{-1}^2 \left[(16 - 8x^2 + x^4) - (4 - 4x + x^2) \right] dx \\ &= \pi \int_{-1}^2 (12 + 4x - 9x^2 + x^4) dx = \pi \left[12x + 2x^2 - 3x^3 + \frac{x^5}{5} \right]_{-1}^2 \\ &= \pi \left[(24 + 8 - 24 + \frac{32}{5}) - (-12 + 2 + 3 - \frac{1}{5}) \right] = \pi \left(15 + \frac{33}{5} \right) = \frac{108\pi}{5} \end{aligned}$$

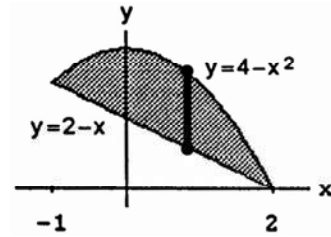

43. $r(x) = \sec x$ and $R(x) = \sqrt{2}$

$$\begin{aligned} \Rightarrow V &= \int_{-\pi/4}^{\pi/4} \pi \left([R(x)]^2 - [r(x)]^2 \right) dx \\ &= \pi \int_{-\pi/4}^{\pi/4} (2 - \sec^2 x) dx = \pi [2x - \tan x]_{-\pi/4}^{\pi/4} \\ &= \pi \left[\left(\frac{\pi}{2} - 1 \right) - \left(-\frac{\pi}{2} + 1 \right) \right] = \pi(\pi - 2) \end{aligned}$$

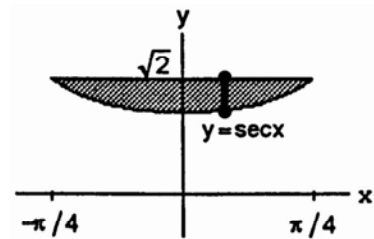

44. $R(x) = \sec x$ and $r(x) = \tan x \Rightarrow V = \int_0^1 \pi \left([R(x)]^2 - [r(x)]^2 \right) dx$

$$= \pi \int_0^1 (\sec^2 x - \tan^2 x) dx = \pi \int_0^1 1 dx = \pi [x]_0^1 = \pi$$

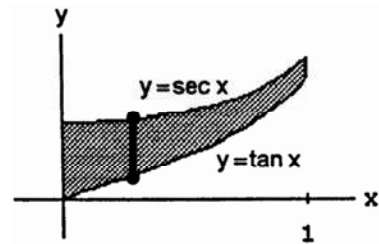

45. $r(y) = 1$ and $R(y) = 1 + y \Rightarrow V = \int_0^1 \pi \left([R(y)]^2 - [r(y)]^2 \right) dy$

$$\begin{aligned} &= \pi \int_0^1 [(1 + y)^2 - 1] dy = \pi \int_0^1 (1 + 2y + y^2 - 1) dy \\ &= \pi \int_0^1 (2y + y^2) dy = \pi \left[y^2 + \frac{y^3}{3} \right]_0^1 = \pi \left(1 + \frac{1}{3} \right) = \frac{4\pi}{3} \end{aligned}$$

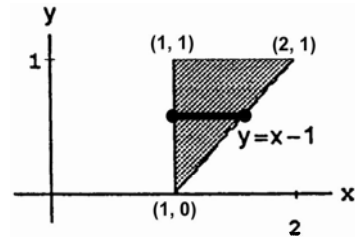

46. $R(y) = 1$ and $r(y) = 1 - y \Rightarrow V = \int_0^1 \pi \left([R(y)]^2 - [r(y)]^2 \right) dy$

$$\begin{aligned} &= \pi \int_0^1 [1 - (1 - y)^2] dy = \pi \int_0^1 [1 - (1 - 2y + y^2)] dy \\ &= \pi \int_0^1 (2y - y^2) dy = \pi \left[y^2 - \frac{y^3}{3} \right]_0^1 = \pi \left(1 - \frac{1}{3} \right) = \frac{2\pi}{3} \end{aligned}$$

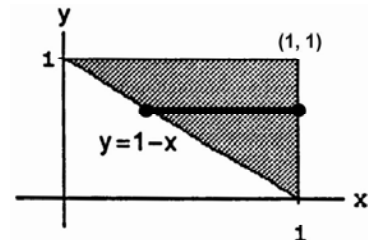

$$47. \quad R(y) = 2 \text{ and } r(y) = \sqrt{y} \Rightarrow V = \int_0^4 \pi \left([R(y)]^2 - [r(y)]^2 \right) dy$$

$$= \pi \int_0^4 (4 - y) dy = \pi \left[4y - \frac{y^2}{2} \right]_0^4 = \pi(16 - 8) = 8\pi$$

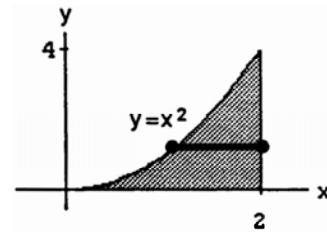

$$48. \quad R(y) = \sqrt{3} \text{ and } r(y) = \sqrt{3 - y^2}$$

$$\Rightarrow V = \int_0^{\sqrt{3}} \pi \left([R(y)]^2 - [r(y)]^2 \right) dy$$

$$= \pi \int_0^{\sqrt{3}} [3 - (3 - y^2)] dy = \pi \int_0^{\sqrt{3}} y^2 dy = \pi \left[\frac{y^3}{3} \right]_0^{\sqrt{3}} = \pi\sqrt{3}$$

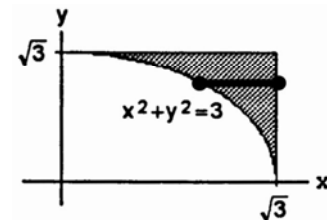

$$49. \quad R(y) = 2 \text{ and } r(y) = 1 + \sqrt{y} \Rightarrow V = \int_0^1 \pi \left([R(y)]^2 - [r(y)]^2 \right) dy$$

$$= \pi \int_0^1 [4 - (1 + \sqrt{y})^2] dy = \pi \int_0^1 (4 - 1 - 2\sqrt{y} - y) dy$$

$$= \pi \int_0^1 (3 - 2\sqrt{y} - y) dy = \pi \left[3y - \frac{4}{3}y^{3/2} - \frac{y^2}{2} \right]_0^1$$

$$= \pi \left(3 - \frac{4}{3} - \frac{1}{2} \right) = \pi \left(\frac{18 - 8 - 3}{6} \right) = \frac{7\pi}{6}$$

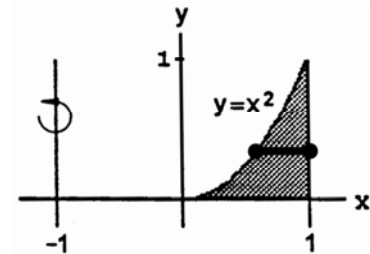

$$50. \quad R(y) = 2 - y^{1/3} \text{ and } r(y) = 1 \Rightarrow V = \int_0^1 \pi \left([R(y)]^2 - [r(y)]^2 \right) dy$$

$$= \pi \int_0^1 \left[(2 - y^{1/3})^2 - 1 \right] dy = \pi \int_0^1 (4 - 4y^{1/3} + y^{2/3} - 1) dy$$

$$= \pi \int_0^1 (3 - 4y^{1/3} + y^{2/3}) dy = \pi \left[3y - 3y^{4/3} + \frac{3y^{5/3}}{5} \right]_0^1$$

$$= \pi \left(3 - 3 + \frac{3}{5} \right) = \frac{3\pi}{5}$$

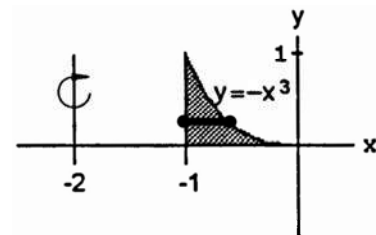

$$51. \quad (a) \quad r(x) = \sqrt{x} \text{ and } R(x) = 2$$

$$\Rightarrow V = \int_0^4 \pi \left([R(x)]^2 - [r(x)]^2 \right) dx$$

$$= \pi \int_0^4 (4 - x) dx = \pi \left[4x - \frac{x^2}{2} \right]_0^4 = \pi(16 - 8) = 8\pi$$

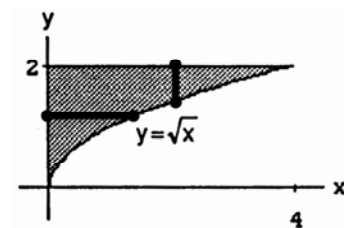

$$(b) \quad r(y) = 0 \text{ and } R(y) = y^2 \Rightarrow V = \int_0^2 \pi \left([R(y)]^2 - [r(y)]^2 \right) dy = \pi \int_0^2 y^4 dy = \pi \left[\frac{y^5}{5} \right]_0^2 = \frac{32\pi}{5}$$

$$(c) \quad r(x) = 0 \text{ and } R(x) = 2 - \sqrt{x} \Rightarrow V = \int_0^4 \pi \left([R(x)]^2 - [r(x)]^2 \right) dx = \pi \int_0^4 (2 - \sqrt{x})^2 dx$$

$$= \pi \int_0^4 (4 - 4\sqrt{x} + x) dx = \pi \left[4x - \frac{8x^{3/2}}{3} + \frac{x^2}{2} \right]_0^4 = \pi \left(16 - \frac{64}{3} + \frac{16}{2} \right) = \frac{8\pi}{3}$$

$$\begin{aligned}
 \text{(d) } r(y) = 4 - y^2 \text{ and } R(y) = 4 &\Rightarrow V = \int_0^2 \pi \left([R(y)]^2 - [r(y)]^2 \right) dy = \pi \int_0^2 \left[16 - (4 - y^2)^2 \right] dy \\
 &= \pi \int_0^2 (16 - 16 + 8y^2 - y^4) dy = \pi \int_0^2 (8y^2 - y^4) dy = \pi \left[\frac{8}{3}y^3 - \frac{y^5}{5} \right]_0^2 = \pi \left(\frac{64}{3} - \frac{32}{5} \right) = \frac{224\pi}{15}
 \end{aligned}$$

$$\begin{aligned}
 \text{52. (a) } r(y) = 0 \text{ and } R(y) = 1 - \frac{y}{2} \\
 \Rightarrow V = \int_0^2 \pi \left([R(y)]^2 - [r(y)]^2 \right) dy \\
 = \pi \int_0^2 \left(1 - \frac{y}{2} \right)^2 dy = \pi \int_0^2 \left(1 - y + \frac{y^2}{4} \right) dy \\
 = \pi \left[y - \frac{y^2}{2} + \frac{y^3}{12} \right]_0^2 = \pi \left(2 - \frac{4}{2} + \frac{8}{12} \right) = \frac{2\pi}{3}
 \end{aligned}$$

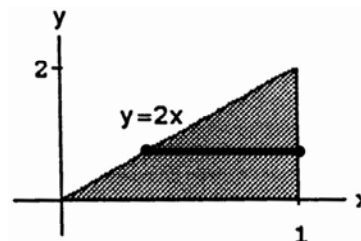

$$\begin{aligned}
 \text{(b) } r(y) = 1 \text{ and } R(y) = 2 - \frac{y}{2} \\
 \Rightarrow V = \int_0^2 \pi \left([R(y)]^2 - [r(y)]^2 \right) dy = \pi \int_0^2 \left[\left(2 - \frac{y}{2} \right)^2 - 1 \right] dy = \pi \int_0^2 \left(4 - 2y + \frac{y^2}{4} - 1 \right) dy \\
 = \pi \int_0^2 \left(3 - 2y + \frac{y^2}{4} \right) dy = \pi \left[3y - y^2 + \frac{y^3}{12} \right]_0^2 = \pi \left(6 - 4 + \frac{8}{12} \right) = \pi \left(2 + \frac{2}{3} \right) = \frac{8\pi}{3}
 \end{aligned}$$

$$\begin{aligned}
 \text{53. (a) } r(x) = 0 \text{ and } R(x) = 1 - x^2 &\Rightarrow V = \int_{-1}^1 \pi \left([R(x)]^2 - [r(x)]^2 \right) dx \\
 &= \pi \int_{-1}^1 (1 - x^2)^2 dx = \pi \int_{-1}^1 (1 - 2x^2 + x^4) dx \\
 &= \pi \left[x - \frac{2x^3}{3} + \frac{x^5}{5} \right]_{-1}^1 = 2\pi \left(1 - \frac{2}{3} + \frac{1}{5} \right) = 2\pi \left(\frac{15-10+3}{15} \right) = \frac{16\pi}{15}
 \end{aligned}$$

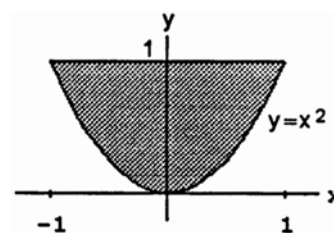

$$\begin{aligned}
 \text{(b) } r(x) = 1 \text{ and } R(x) = 2 - x^2 &\Rightarrow V = \int_{-1}^1 \pi \left([R(x)]^2 - [r(x)]^2 \right) dx = \pi \int_{-1}^1 \left[(2 - x^2)^2 - 1 \right] dx \\
 &= \pi \int_{-1}^1 (4 - 4x^2 + x^4 - 1) dx = \pi \int_{-1}^1 (3 - 4x^2 + x^4) dx = \pi \left[3x - \frac{4}{3}x^3 + \frac{x^5}{5} \right]_{-1}^1 = 2\pi \left(3 - \frac{4}{3} + \frac{1}{5} \right) \\
 &= \frac{2\pi}{15} (45 - 20 + 3) = \frac{56\pi}{15}
 \end{aligned}$$

$$\begin{aligned}
 \text{(c) } r(x) = 1 + x^2 \text{ and } R(x) = 2 &\Rightarrow V = \int_{-1}^1 \pi \left([R(x)]^2 - [r(x)]^2 \right) dx = \pi \int_{-1}^1 \left[4 - (1 + x^2)^2 \right] dx \\
 &= \pi \int_{-1}^1 (4 - 1 - 2x^2 - x^4) dx = \pi \int_{-1}^1 (3 - 2x^2 - x^4) dx = \pi \left[3x - \frac{2}{3}x^3 - \frac{x^5}{5} \right]_{-1}^1 = 2\pi \left(3 - \frac{2}{3} - \frac{1}{5} \right) \\
 &= \frac{2\pi}{15} (45 - 10 - 3) = \frac{64\pi}{15}
 \end{aligned}$$

$$\begin{aligned}
 \text{54. (a) } r(x) = 0 \text{ and } R(x) = -\frac{h}{b}x + h \\
 \Rightarrow V = \int_0^b \pi \left([R(x)]^2 - [r(x)]^2 \right) dx \\
 = \pi \int_0^b \left(-\frac{h}{b}x + h \right)^2 dx = \pi \int_0^b \left(\frac{h^2}{b^2}x^2 - \frac{2h^2}{b}x + h^2 \right) dx \\
 = \pi h^2 \left[\frac{x^3}{3b^2} - \frac{x^2}{b} + x \right]_0^b = \pi h^2 \left(\frac{b}{3} - b + b \right) = \frac{\pi h^2 b}{3}
 \end{aligned}$$

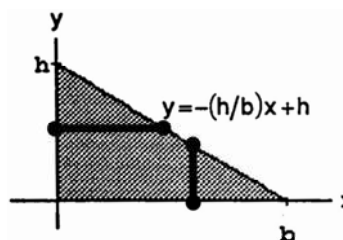

(b) $r(y) = 0$ and $R(y) = b\left(1 - \frac{y}{h}\right) \Rightarrow V = \int_0^h \pi \left([R(y)]^2 - [r(y)]^2 \right) dy = \pi b^2 \int_0^h \left(1 - \frac{y}{h}\right)^2 dy$
 $= \pi b^2 \int_0^h \left(1 - \frac{2y}{h} + \frac{y^2}{h^2}\right) dy = \pi b^2 \left[y - \frac{y^2}{h} + \frac{y^3}{3h^2} \right]_0^h = \pi b^2 \left(h - h + \frac{h}{3} \right) = \frac{\pi b^2 h}{3}$

55. $R(y) = b + \sqrt{a^2 - y^2}$ and $r(y) = b - \sqrt{a^2 - y^2}$
 $\Rightarrow V = \int_{-a}^a \pi \left([R(y)]^2 - [r(y)]^2 \right) dy$
 $= \pi \int_{-a}^a \left[\left(b + \sqrt{a^2 - y^2} \right)^2 - \left(b - \sqrt{a^2 - y^2} \right)^2 \right] dy$
 $= \pi \int_{-a}^a 4b\sqrt{a^2 - y^2} dy = 4b\pi \int_{-a}^a \sqrt{a^2 - y^2} dy$
 $= 4b\pi \cdot \text{area of semicircle of radius } a = 4b\pi \cdot \frac{\pi a^2}{2} = 2a^2 b\pi^2$

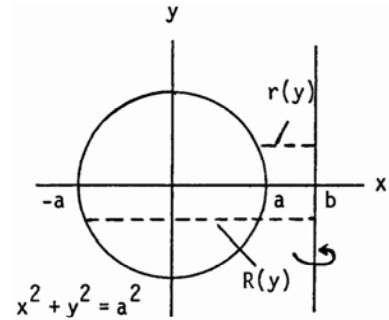

56. (a) A cross section has radius $r = \sqrt{2y}$ and area $\pi r^2 = 2\pi y$. The volume is $\int_0^5 2\pi y dy = \pi [y^2]_0^5 = 25\pi$.
 (b) $V(h) = \int A(h)dh$, so $\frac{dV}{dh} = A(h)$. Therefore $\frac{dV}{dt} = \frac{dV}{dh} \cdot \frac{dh}{dt} = A(h) \cdot \frac{dh}{dt}$, so $\frac{dh}{dt} = \frac{1}{A(h)} \cdot \frac{dV}{dt}$.
 For $h = 4$, the area is $2\pi(4) = 8\pi$, so $\frac{dh}{dt} = \frac{1}{8\pi} \cdot 3 \frac{\text{units}^3}{\text{sec}} = \frac{3}{8\pi} \frac{\text{units}^3}{\text{sec}}$.

57. (a) $R(y) = \sqrt{a^2 - y^2} \Rightarrow V = \pi \int_{-a}^{h-a} (a^2 - y^2) dy = \pi \left[a^2 y - \frac{y^3}{3} \right]_{-a}^{h-a} = \pi \left[a^2 h - a^3 - \frac{(h-a)^3}{3} - \left(-a^3 + \frac{a^3}{3} \right) \right]$
 $= \pi \left[a^2 h - \frac{1}{3}(h^3 - 3h^2 a + 3ha^2 - a^3) - \frac{a^3}{3} \right] = \pi \left(a^2 h - \frac{h^3}{3} + h^2 a - ha^2 \right) = \frac{\pi h^2 (3a-h)}{3}$
 (b) Given $\frac{dV}{dt} = 0.2 \text{ m}^3/\text{sec}$ and $a = 5 \text{ m}$, find $\frac{dh}{dt} \Big|_{h=4}$. From part (a), $V(h) = \frac{\pi h^2 (15-h)}{3} = 5\pi h^2 - \frac{\pi h^3}{3}$
 $\Rightarrow \frac{dV}{dh} = 10\pi h - \pi h^2 \Rightarrow \frac{dV}{dt} = \frac{dV}{dh} \cdot \frac{dh}{dt} = \pi h(10-h) \frac{dh}{dt} \Rightarrow \frac{dh}{dt} \Big|_{h=4} = \frac{0.2}{4\pi(10-4)} = \frac{1}{(20\pi)(6)} = \frac{1}{120\pi} \text{ m/sec}$.

58. Suppose the solid is produced by revolving $y = 2 - x$ about the y -axis. Cast a shadow of the solid on a plane parallel to the xy -plane. Use an approximation such as the Trapezoid Rule, to estimate $\int_a^b \pi [R(y)]^2 dy \approx \sum_{k=1}^n \pi \left(\frac{d_k}{2} \right)^2 \Delta y$.

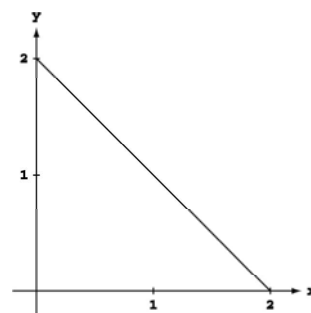

59. The cross section of a solid right circular cylinder with a cone removed is a disk with radius R from which a disk of radius h has been removed. Thus its area is $A_1 = \pi R^2 - \pi h^2 = \pi(R^2 - h^2)$. The cross section of the hemisphere is a disk of radius $\sqrt{R^2 - h^2}$. Therefore its area is $A_2 = \pi \left(\sqrt{R^2 - h^2} \right)^2 = \pi(R^2 - h^2)$. We can see that $A_1 = A_2$. The altitudes of both solids are R . Applying Cavalieri's Principle we find
 Volume of Hemisphere = (Volume of Cylinder) - (Volume of Cone) = $(\pi R^2) R - \frac{1}{3} \pi (R^2) R = \frac{2}{3} \pi R^3$.

$$60. \quad R(x) = \frac{x}{12}\sqrt{36-x^2} \Rightarrow V = \int_0^6 \pi [R(x)]^2 dx = \pi \int_0^6 \frac{x^2}{144} (36-x^2) dx = \frac{\pi}{144} \int_0^6 (36x^2 - x^4) dx$$

$$= \frac{\pi}{144} \left[12x^3 - \frac{x^5}{5} \right]_0^6 = \frac{\pi}{144} \left(12 \cdot 6^3 - \frac{6^5}{5} \right) = \frac{\pi \cdot 6^3}{144} \left(12 - \frac{36}{5} \right) = \left(\frac{196\pi}{144} \right) \left(\frac{60-36}{5} \right) = \frac{36\pi}{5} \text{ cm}^3.$$

The plumb bob will weigh about $W = (8.5) \left(\frac{36\pi}{5} \right) \approx 192$ gm, to the nearest gram.

$$61. \quad R(y) = \sqrt{256-y^2} \Rightarrow V = \int_{-16}^{-7} \pi [R(y)]^2 dy = \pi \int_{-16}^{-7} (256-y^2) dy = \pi \left[256y - \frac{y^3}{3} \right]_{-16}^{-7}$$

$$= \pi \left[(256)(-7) + \frac{7^3}{3} - \left((256)(-16) + \frac{16^3}{3} \right) \right] = \pi \left(\frac{7^3}{3} + 256(16-7) - \frac{16^3}{3} \right) = 1053\pi \text{ cm}^3 \approx 3308 \text{ cm}^3$$

$$62. \quad (a) \quad R(x) = |c - \sin x|, \text{ so } V = \pi \int_0^\pi [R(x)]^2 dx = \pi \int_0^\pi (c - \sin x)^2 dx = \pi \int_0^\pi (c^2 - 2c \sin x + \sin^2 x) dx$$

$$= \pi \int_0^\pi \left(c^2 - 2c \sin x + \frac{1-\cos 2x}{2} \right) dx = \pi \int_0^\pi \left(c^2 + \frac{1}{2} - 2c \sin x - \frac{\cos 2x}{2} \right) dx = \pi \left[\left(c^2 + \frac{1}{2} \right) x + 2c \cos x - \frac{\sin 2x}{4} \right]_0^\pi$$

$$= \pi \left[\left(c^2 \pi + \frac{\pi}{2} - 2c - 0 \right) - \left(0 + 2c - 0 \right) \right] = \pi \left(c^2 \pi + \frac{\pi}{2} - 4c \right).$$

Let $V(c) = \pi \left(c^2 \pi + \frac{\pi}{2} - 4c \right)$. We find the extreme values of $V(c)$: $\frac{dV}{dc} = \pi(2c\pi - 4) = 0 \Rightarrow c = \frac{2}{\pi}$ is a critical point, and $V\left(\frac{2}{\pi}\right) = \pi \left(\frac{4}{\pi} + \frac{\pi}{2} - \frac{8}{\pi} \right) = \pi \left(\frac{\pi}{2} - \frac{4}{\pi} \right) = \frac{\pi^2}{2} - 4$; Evaluate V at the endpoints: $V(0) = \frac{\pi^2}{2}$ and $V(1) = \pi \left(\frac{3}{2} \pi - 4 \right) = \frac{\pi^2}{2} - (4 - \pi)\pi$.

Now we see that the function's absolute minimum value is $\frac{\pi^2}{2} - 4$, taken on at the critical point $c = \frac{2}{\pi}$.

(See also the accompanying graph.)

(b) From the discussion in part (a) we conclude that the function's absolute maximum value is $\frac{\pi^2}{2}$, taken on at the endpoint $c = 0$.

(c) The graph of the solid's volume as a function of c for $0 \leq c \leq 1$ is given at the right. As c moves away from $[0, 1]$ the volume of the solid increases without bound. If we approximate the solid as a set of solid disks, we can see that the radius of a typical disk increases without bounds as c moves away from $[0, 1]$.

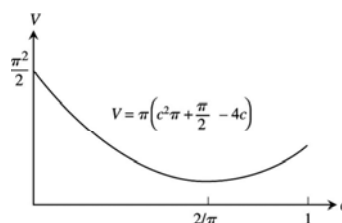

$$63. \quad \text{Volume of the solid generated by rotating the region bounded by the } x\text{-axis and } y = f(x) \text{ from } x = a \text{ to } x = b \text{ about the } x\text{-axis is } V = \int_a^b \pi [f(x)]^2 dx = 4\pi, \text{ and the volume of the solid generated by rotating the same region about the line } y = -1 \text{ is } V = \int_a^b \pi [f(x) + 1]^2 dx = 8\pi. \text{ Thus } \int_a^b \pi [f(x) + 1]^2 dx - \int_a^b \pi [f(x)]^2 dx = 8\pi - 4\pi$$

$$\Rightarrow \pi \int_a^b \left([f(x)]^2 + 2f(x) + 1 - [f(x)]^2 \right) dx = 4\pi \Rightarrow \int_a^b (2f(x) + 1) dx = 4 \Rightarrow 2 \int_a^b f(x) dx + \int_a^b dx = 4$$

$$\Rightarrow \int_a^b f(x) dx + \frac{1}{2}(b-a) = 2 \Rightarrow \int_a^b f(x) dx = \frac{4-b+a}{2}$$

$$64. \quad \text{Volume of the solid generated by rotating the region bounded by the } x\text{-axis and } y = f(x) \text{ from } x = a \text{ to } x = b \text{ about the } x\text{-axis is } V = \int_a^b \pi [f(x)]^2 dx = 6\pi, \text{ and the volume of the solid generated by rotating the same region about the line } y = -2 \text{ is } V = \int_a^b \pi [f(x) + 2]^2 dx = 10\pi. \text{ Thus}$$

$$\int_a^b \pi [f(x) + 2]^2 dx - \int_a^b \pi [f(x)]^2 dx = 10\pi - 6\pi \Rightarrow \pi \int_a^b ([f(x)]^2 + 4f(x) + 4 - [f(x)]^2) dx = 4\pi$$

$$\Rightarrow \int_a^b (4f(x) + 4) dx = 4 \Rightarrow 4 \int_a^b f(x) dx + 4 \int_a^b dx = 4 \Rightarrow \int_a^b f(x) dx + (b - a) = 1 \Rightarrow \int_a^b f(x) dx = 1 - b + a$$

6.2 VOLUMES USING CYLINDRICAL SHELLS

1. For the sketch given, $a = 0, b = 2$;

$$V = \int_a^b 2\pi \left(\begin{matrix} \text{shell} \\ \text{radius} \end{matrix} \right) \left(\begin{matrix} \text{shell} \\ \text{height} \end{matrix} \right) dx = \int_0^2 2\pi x \left(1 + \frac{x^2}{4} \right) dx = 2\pi \int_0^2 \left(x + \frac{x^3}{4} \right) dx = 2\pi \left[\frac{x^2}{2} + \frac{x^4}{16} \right]_0^2 = 2\pi \left(\frac{4}{2} + \frac{16}{16} \right) = 2\pi \cdot 3 = 6\pi$$

2. For the sketch given, $a = 0, b = 2$;

$$V = \int_a^b 2\pi \left(\begin{matrix} \text{shell} \\ \text{radius} \end{matrix} \right) \left(\begin{matrix} \text{shell} \\ \text{height} \end{matrix} \right) dx = \int_0^2 2\pi x \left(2 - \frac{x^2}{4} \right) dx = 2\pi \int_0^2 \left(2x - \frac{x^3}{4} \right) dx = 2\pi \left[x^2 - \frac{x^4}{16} \right]_0^2 = 2\pi (4 - 1) = 6\pi$$

3. For the sketch given, $c = 0, d = \sqrt{2}$;

$$V = \int_c^d 2\pi \left(\begin{matrix} \text{shell} \\ \text{radius} \end{matrix} \right) \left(\begin{matrix} \text{shell} \\ \text{height} \end{matrix} \right) dy = \int_0^{\sqrt{2}} 2\pi y \cdot (y^2) dy = 2\pi \int_0^{\sqrt{2}} y^3 dy = 2\pi \left[\frac{y^4}{4} \right]_0^{\sqrt{2}} = 2\pi$$

4. For the sketch given, $c = 0, d = \sqrt{3}$;

$$V = \int_c^d 2\pi \left(\begin{matrix} \text{shell} \\ \text{radius} \end{matrix} \right) \left(\begin{matrix} \text{shell} \\ \text{height} \end{matrix} \right) dy = \int_0^{\sqrt{3}} 2\pi y \cdot [3 - (3 - y^2)] dy = 2\pi \int_0^{\sqrt{3}} y^3 dy = 2\pi \left[\frac{y^4}{4} \right]_0^{\sqrt{3}} = \frac{9\pi}{2}$$

5. For the sketch given, $a = 0, b = \sqrt{3}$;

$$V = \int_a^b 2\pi \left(\begin{matrix} \text{shell} \\ \text{radius} \end{matrix} \right) \left(\begin{matrix} \text{shell} \\ \text{height} \end{matrix} \right) dx = \int_0^{\sqrt{3}} 2\pi x \cdot (\sqrt{x^2 + 1}) dx;$$

$$[u = x^2 + 1 \Rightarrow du = 2x dx; x = 0 \Rightarrow u = 1, x = \sqrt{3} \Rightarrow u = 4]$$

$$\rightarrow V = \pi \int_1^4 u^{1/2} du = \pi \left[\frac{2}{3} u^{3/2} \right]_1^4 = \frac{2\pi}{3} (4^{3/2} - 1) = \left(\frac{2\pi}{3} \right) (8 - 1) = \frac{14\pi}{3}$$

6. For the sketch given, $a = 0, b = 3$;

$$V = \int_a^b 2\pi \left(\begin{matrix} \text{shell} \\ \text{radius} \end{matrix} \right) \left(\begin{matrix} \text{shell} \\ \text{height} \end{matrix} \right) dx = \int_0^3 2\pi x \left(\frac{9x}{\sqrt{x^3 + 9}} \right) dx;$$

$$[u = x^3 + 9 \Rightarrow du = 3x^2 dx \Rightarrow 3 du = 9x^2 dx; x = 0 \Rightarrow u = 9, x = 3 \Rightarrow u = 36]$$

$$\rightarrow V = 2\pi \int_9^{36} 3u^{-1/2} du = 6\pi \left[2u^{1/2} \right]_9^{36} = 12\pi (\sqrt{36} - \sqrt{9}) = 36\pi$$

7. $a = 0, b = 2$;

$$V = \int_a^b 2\pi \left(\begin{matrix} \text{shell} \\ \text{radius} \end{matrix} \right) \left(\begin{matrix} \text{shell} \\ \text{height} \end{matrix} \right) dx = \int_0^2 2\pi x \left[x - \left(-\frac{x}{2} \right) \right] dx$$

$$= \int_0^2 2\pi x^2 \cdot \frac{3}{2} dx = \pi \int_0^2 3x^2 dx = \pi \left[x^3 \right]_0^2 = 8\pi$$

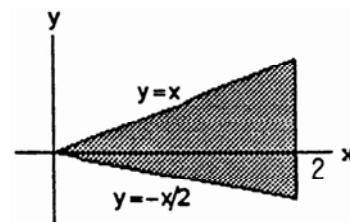

8. $a = 0, b = 1;$

$$V = \int_a^b 2\pi \left(\begin{matrix} \text{shell} \\ \text{radius} \end{matrix} \right) \left(\begin{matrix} \text{shell} \\ \text{height} \end{matrix} \right) dx = \int_0^1 2\pi x \left(2x - \frac{x}{2} \right) dx$$

$$= \pi \int_0^1 2 \left(\frac{3x^2}{2} \right) dx = \pi \int_0^1 3x^2 dx = \pi \left[x^3 \right]_0^1 = \pi$$

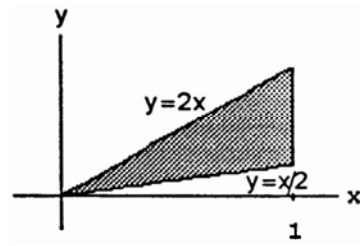

9. $a = 0, b = 1;$

$$V = \int_a^b 2\pi \left(\begin{matrix} \text{shell} \\ \text{radius} \end{matrix} \right) \left(\begin{matrix} \text{shell} \\ \text{height} \end{matrix} \right) dx = \int_0^1 2\pi x \left[(2-x) - x^2 \right] dx$$

$$= 2\pi \int_0^1 (2x - x^2 - x^3) dx = 2\pi \left[x^2 - \frac{x^3}{3} - \frac{x^4}{4} \right]_0^1$$

$$= 2\pi \left(1 - \frac{1}{3} - \frac{1}{4} \right) = 2\pi \left(\frac{12-4-3}{12} \right) = \frac{10\pi}{12} = \frac{5\pi}{6}$$

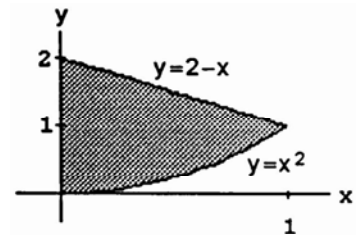

10. $a = 0, b = 1;$

$$V = \int_a^b 2\pi \left(\begin{matrix} \text{shell} \\ \text{radius} \end{matrix} \right) \left(\begin{matrix} \text{shell} \\ \text{height} \end{matrix} \right) dx = \int_0^1 2\pi x \left[(2-x^2) - x^2 \right] dx$$

$$= 2\pi \int_0^1 x (2-2x^2) dx = 4\pi \int_0^1 (x-x^3) dx$$

$$= 4\pi \left[\frac{x^2}{2} - \frac{x^4}{4} \right]_0^1 = 4\pi \left(\frac{1}{2} - \frac{1}{4} \right) = \pi$$

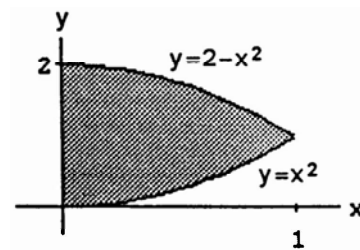

11. $a = 0, b = 1;$

$$V = \int_a^b 2\pi \left(\begin{matrix} \text{shell} \\ \text{radius} \end{matrix} \right) \left(\begin{matrix} \text{shell} \\ \text{height} \end{matrix} \right) dx = \int_0^1 2\pi x \left[\sqrt{x} - (2x-1) \right] dx$$

$$= 2\pi \int_0^1 (x^{3/2} - 2x^2 + x) dx = 2\pi \left[\frac{2}{5} x^{5/2} - \frac{2}{3} x^3 + \frac{1}{2} x^2 \right]_0^1$$

$$= 2\pi \left(\frac{2}{5} - \frac{2}{3} + \frac{1}{2} \right) = 2\pi \left(\frac{12-20+15}{30} \right) = \frac{7\pi}{15}$$

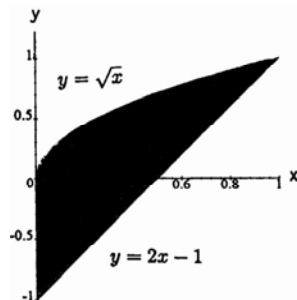

12. $a = 1, b = 4;$

$$V = \int_a^b 2\pi \left(\begin{matrix} \text{shell} \\ \text{radius} \end{matrix} \right) \left(\begin{matrix} \text{shell} \\ \text{height} \end{matrix} \right) dx = \int_1^4 2\pi x \left(\frac{3}{2} x^{-1/2} \right) dx$$

$$= 3\pi \int_1^4 x^{1/2} dx = 3\pi \left[\frac{2}{3} x^{3/2} \right]_1^4 = 2\pi (4^{3/2} - 1)$$

$$= 2\pi(8-1) = 14\pi$$

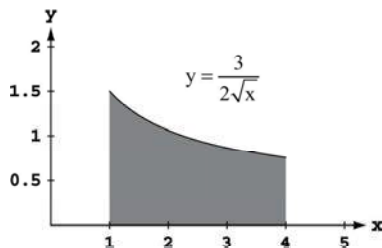

13. (a) $xf(x) = \begin{cases} x \cdot \frac{\sin x}{x}, & 0 < x \leq \pi \\ x, & x = 0 \end{cases} \Rightarrow xf(x) = \begin{cases} \sin x, & 0 < x \leq \pi \\ 0, & x = 0 \end{cases}$; since $\sin 0 = 0$ we have

$$xf(x) = \begin{cases} \sin x, & 0 < x \leq \pi \\ \sin x, & x = 0 \end{cases} \Rightarrow xf(x) = \sin x, 0 \leq x \leq \pi$$

$$(b) \quad V = \int_a^b 2\pi \left(\begin{array}{c} \text{shell} \\ \text{radius} \end{array} \right) \left(\begin{array}{c} \text{shell} \\ \text{height} \end{array} \right) dx = \int_0^\pi 2\pi x \cdot f(x) dx \text{ and } x \cdot f(x) = \sin x, 0 \leq x \leq \pi \text{ by part (a)}$$

$$\Rightarrow V = 2\pi \int_0^\pi \sin x dx = 2\pi [-\cos x]_0^\pi = 2\pi(-\cos \pi + \cos 0) = 4\pi$$

$$14. (a) \quad xg(x) = \begin{cases} x \cdot \frac{\tan^2 x}{x}, & 0 < x \leq \frac{\pi}{4} \\ x \cdot 0, & x = 0 \end{cases} \Rightarrow xg(x) = \begin{cases} \tan^2 x, & 0 < x \leq \pi/4 \\ 0, & x = 0 \end{cases}; \text{ since } \tan 0 = 0 \text{ we have}$$

$$xg(x) = \begin{cases} \tan^2 x, & 0 < x \leq \pi/4 \\ \tan^2 x, & x = 0 \end{cases} \Rightarrow xg(x) = \tan^2 x, 0 \leq x \leq \pi/4$$

$$(b) \quad V = \int_a^b 2\pi \left(\begin{array}{c} \text{shell} \\ \text{radius} \end{array} \right) \left(\begin{array}{c} \text{shell} \\ \text{height} \end{array} \right) dx = \int_0^{\pi/4} 2\pi x \cdot g(x) dx \text{ and } x \cdot g(x) = \tan^2 x, 0 \leq x \leq \pi/4 \text{ by part (a)}$$

$$\Rightarrow V = 2\pi \int_0^{\pi/4} \tan^2 x dx = 2\pi \int_0^{\pi/4} (\sec^2 x - 1) dx = 2\pi [\tan x - x]_0^{\pi/4} = 2\pi \left(1 - \frac{\pi}{4}\right) = \frac{4\pi - \pi^2}{2}$$

$$15. \quad c = 0, d = 2;$$

$$V = \int_c^d 2\pi \left(\begin{array}{c} \text{shell} \\ \text{radius} \end{array} \right) \left(\begin{array}{c} \text{shell} \\ \text{height} \end{array} \right) dy = \int_0^2 2\pi y [\sqrt{y} - (-y)] dy$$

$$= 2\pi \int_0^2 (y^{3/2} + y^2) dy = 2\pi \left[\frac{2y^{5/2}}{5} + \frac{y^3}{3} \right]_0^2$$

$$= 2\pi \left[\frac{2}{5} (\sqrt{2})^5 + \frac{2^3}{3} \right] = 2\pi \left(\frac{8\sqrt{2}}{5} + \frac{8}{3} \right) = 16\pi \left(\frac{\sqrt{2}}{5} + \frac{1}{3} \right)$$

$$= \frac{16\pi}{15} (3\sqrt{2} + 5)$$

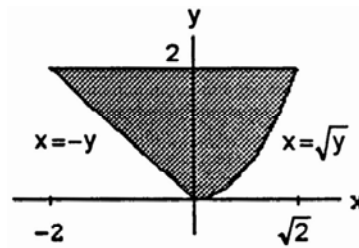

$$16. \quad c = 0, d = 2;$$

$$V = \int_c^d 2\pi \left(\begin{array}{c} \text{shell} \\ \text{radius} \end{array} \right) \left(\begin{array}{c} \text{shell} \\ \text{height} \end{array} \right) dy = \int_0^2 2\pi y [y^2 - (-y)] dy$$

$$= 2\pi \int_0^2 (y^3 + y^2) dy = 2\pi \left[\frac{y^4}{4} + \frac{y^3}{3} \right]_0^2 = 16\pi \left(\frac{2}{4} + \frac{1}{3} \right)$$

$$= 16\pi \left(\frac{5}{6} \right) = \frac{40\pi}{3}$$

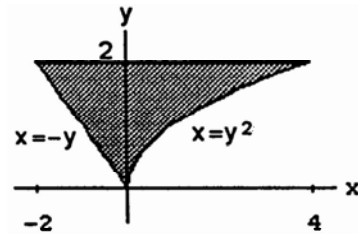

$$17. \quad c = 0, d = 2;$$

$$V = \int_c^d 2\pi \left(\begin{array}{c} \text{shell} \\ \text{radius} \end{array} \right) \left(\begin{array}{c} \text{shell} \\ \text{height} \end{array} \right) dy = \int_0^2 2\pi y (2y - y^2) dy$$

$$= 2\pi \int_0^2 (2y^2 - y^3) dy = 2\pi \left[\frac{2y^3}{3} - \frac{y^4}{4} \right]_0^2 = 2\pi \left(\frac{16}{3} - \frac{16}{4} \right)$$

$$= 32\pi \left(\frac{1}{3} - \frac{1}{4} \right) = \frac{32\pi}{12} = \frac{8\pi}{3}$$

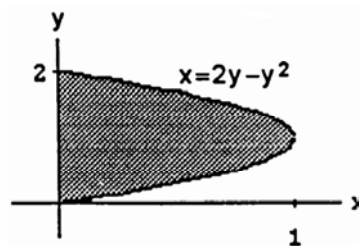

18. $c = 0, d = 1;$

$$\begin{aligned} V &= \int_c^d 2\pi \left(\text{shell radius} \right) \left(\text{shell height} \right) dy = \int_0^1 2\pi y (2y - y^2 - y) dy \\ &= 2\pi \int_0^1 y (y - y^2) dy = 2\pi \int_0^1 (y^2 - y^3) dy \\ &= 2\pi \left[\frac{y^3}{3} - \frac{y^4}{4} \right]_0^1 = 2\pi \left(\frac{1}{3} - \frac{1}{4} \right) = \frac{\pi}{6} \end{aligned}$$

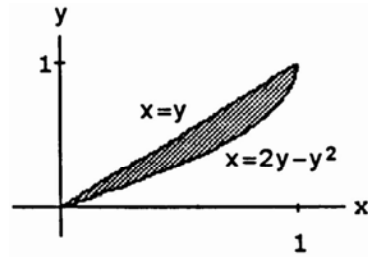

19. $c = 0, d = 1;$

$$\begin{aligned} V &= \int_c^d 2\pi \left(\text{shell radius} \right) \left(\text{shell height} \right) dy = 2\pi \int_0^1 y [y - (-y)] dy \\ &= 2\pi \int_0^1 2y^2 dy = \frac{4\pi}{3} \left[y^3 \right]_0^1 = \frac{4\pi}{3} \end{aligned}$$

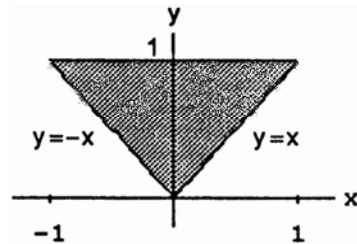

20. $c = 0, d = 2;$

$$\begin{aligned} V &= \int_c^d 2\pi \left(\text{shell radius} \right) \left(\text{shell height} \right) dy = \int_0^2 2\pi y \left(y - \frac{y}{2} \right) dy \\ &= 2\pi \int_0^2 \frac{y^2}{2} dy = \frac{\pi}{3} \left[y^3 \right]_0^2 = \frac{8\pi}{3} \end{aligned}$$

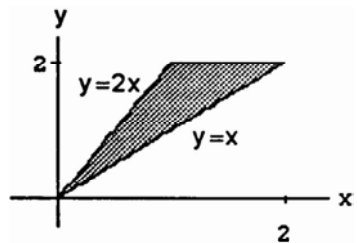

21. $c = 0, d = 2;$

$$\begin{aligned} V &= \int_c^d 2\pi \left(\text{shell radius} \right) \left(\text{shell height} \right) dy = \int_0^2 2\pi y [(2 + y) - y^2] dy \\ &= 2\pi \int_0^2 (2y + y^2 - y^3) dy = 2\pi \left[y^2 + \frac{y^3}{3} - \frac{y^4}{4} \right]_0^2 \\ &= 2\pi \left(4 + \frac{8}{3} - \frac{16}{4} \right) = \frac{\pi}{6} (48 + 32 - 48) = \frac{16\pi}{3} \end{aligned}$$

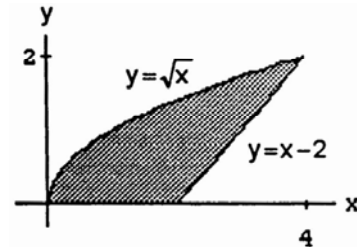

22. $c = 0, d = 1;$

$$\begin{aligned} V &= \int_c^d 2\pi \left(\text{shell radius} \right) \left(\text{shell height} \right) dy = \int_0^1 2\pi y [(2 - y) - y^2] dy \\ &= 2\pi \int_0^1 (2y - y^2 - y^3) dy = 2\pi \left[y^2 - \frac{y^3}{3} - \frac{y^4}{4} \right]_0^1 \\ &= 2\pi \left(1 - \frac{1}{3} - \frac{1}{4} \right) = \frac{\pi}{6} (12 - 4 - 3) = \frac{5\pi}{6} \end{aligned}$$

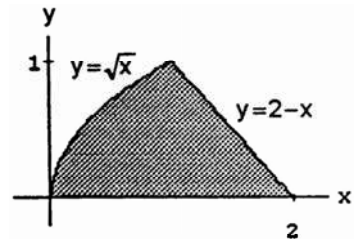

23. (a) $V = \int_a^b 2\pi \left(\text{shell radius} \right) \left(\text{shell height} \right) dx = \int_0^2 2\pi x (3x) dx = 6\pi \int_0^2 x^2 dx = 2\pi \left[x^3 \right]_0^2 = 16\pi$

(b) $V = \int_a^b 2\pi \left(\text{shell radius} \right) \left(\text{shell height} \right) dx = \int_0^2 2\pi (4 - x) (3x) dx = 6\pi \int_0^2 (4x - x^2) dx = 6\pi \left[2x^2 - \frac{1}{3}x^3 \right]_0^2$
 $= 6\pi \left(8 - \frac{8}{3} \right) = 32\pi$

- (c) $V = \int_a^b 2\pi \left(\frac{\text{shell}}{\text{radius}} \right) \left(\frac{\text{shell}}{\text{height}} \right) dx = \int_0^2 2\pi(x+1)(3x)dx = 6\pi \int_0^2 (x^2+x) dx = 6\pi \left[\frac{1}{3}x^3 + \frac{1}{2}x^2 \right]_0^2$
 $= 6\pi \left(\frac{8}{3} + 2 \right) = 28\pi$
- (d) $V = \int_c^d 2\pi \left(\frac{\text{shell}}{\text{radius}} \right) \left(\frac{\text{shell}}{\text{height}} \right) dy = \int_0^6 2\pi y \left(2 - \frac{1}{3}y \right) dy = 2\pi \int_0^6 \left(2y - \frac{1}{3}y^2 \right) dy = 2\pi \left[y^2 - \frac{1}{9}y^3 \right]_0^6$
 $= 2\pi(36 - 24) = 24\pi$
- (e) $V = \int_c^d 2\pi \left(\frac{\text{shell}}{\text{radius}} \right) \left(\frac{\text{shell}}{\text{height}} \right) dy = \int_0^6 2\pi(7-y) \left(2 - \frac{1}{3}y \right) dy = 2\pi \int_0^6 \left(14 - \frac{13}{3}y + \frac{1}{3}y^2 \right) dy$
 $= 2\pi \left[14y - \frac{13}{6}y^2 + \frac{1}{9}y^3 \right]_0^6 = 2\pi(84 - 78 + 24) = 60\pi$
- (f) $V = \int_c^d 2\pi \left(\frac{\text{shell}}{\text{radius}} \right) \left(\frac{\text{shell}}{\text{height}} \right) dy = \int_0^6 2\pi(y+2) \left(2 - \frac{1}{3}y \right) dy = 2\pi \int_0^6 \left(4 + \frac{4}{3}y - \frac{1}{3}y^2 \right) dy$
 $= 2\pi \left[4y + \frac{2}{3}y^2 - \frac{1}{9}y^3 \right]_0^6 = 2\pi(24 + 24 - 24) = 48\pi$
24. (a) $V = \int_a^b 2\pi \left(\frac{\text{shell}}{\text{radius}} \right) \left(\frac{\text{shell}}{\text{height}} \right) dx = \int_0^2 2\pi x(8-x^3) dx = 2\pi \int_0^2 (8x-x^4) dx = 2\pi \left[4x^2 - \frac{1}{5}x^5 \right]_0^2$
 $= 2\pi \left(16 - \frac{32}{5} \right) = \frac{96\pi}{5}$
- (b) $V = \int_a^b 2\pi \left(\frac{\text{shell}}{\text{radius}} \right) \left(\frac{\text{shell}}{\text{height}} \right) dx = \int_0^2 2\pi(3-x)(8-x^3) dx = 2\pi \int_0^2 (24-8x-3x^3+x^4) dx$
 $= 2\pi \left[24x - 4x^2 - \frac{3}{4}x^4 + \frac{1}{5}x^5 \right]_0^2 = 2\pi \left(48 - 16 - 12 + \frac{32}{5} \right) = \frac{264\pi}{5}$
- (c) $V = \int_a^b 2\pi \left(\frac{\text{shell}}{\text{radius}} \right) \left(\frac{\text{shell}}{\text{height}} \right) dx = \int_0^2 2\pi(x+2)(8-x^3) dx = 2\pi \int_0^2 (16+8x-2x^3-x^4) dx$
 $= 2\pi \left[16x + 4x^2 - \frac{1}{2}x^4 - \frac{1}{5}x^5 \right]_0^2 = 2\pi \left(32 + 16 - 8 - \frac{32}{5} \right) = \frac{336\pi}{5}$
- (d) $V = \int_c^d 2\pi \left(\frac{\text{shell}}{\text{radius}} \right) \left(\frac{\text{shell}}{\text{height}} \right) dy = \int_0^8 2\pi y \cdot y^{1/3} dy = 2\pi \int_0^8 y^{4/3} dy = \frac{6\pi}{7} \left[y^{7/3} \right]_0^8 = \frac{6\pi}{7} (128) = \frac{768\pi}{7}$
- (e) $V = \int_c^d 2\pi \left(\frac{\text{shell}}{\text{radius}} \right) \left(\frac{\text{shell}}{\text{height}} \right) dy = \int_0^8 2\pi(8-y)y^{1/3} dy = 2\pi \int_0^8 (8y^{1/3} - y^{4/3}) dy = 2\pi \left[6y^{4/3} - \frac{3}{7}y^{7/3} \right]_0^8$
 $= 2\pi \left(96 - \frac{384}{7} \right) = \frac{576\pi}{7}$
- (f) $V = \int_c^d 2\pi \left(\frac{\text{shell}}{\text{radius}} \right) \left(\frac{\text{shell}}{\text{height}} \right) dy = \int_0^8 2\pi(y+1)y^{1/3} dy = 2\pi \int_0^8 (y^{4/3} + y^{1/3}) dy = 2\pi \left[\frac{3}{7}y^{7/3} + \frac{3}{4}y^{4/3} \right]_0^8$
 $= 2\pi \left(\frac{384}{7} + 12 \right) = \frac{936\pi}{7}$
25. (a) $V = \int_a^b 2\pi \left(\frac{\text{shell}}{\text{radius}} \right) \left(\frac{\text{shell}}{\text{height}} \right) dx = \int_{-1}^2 2\pi(2-x)(x+2-x^2) dx = 2\pi \int_{-1}^2 (4-3x^2+x^3) dx$
 $= 2\pi \left[4x - x^3 + \frac{1}{4}x^4 \right]_{-1}^2 = 2\pi(8-8+4) - 2\pi(-4+1+\frac{1}{4}) = \frac{27\pi}{2}$
- (b) $V = \int_a^b 2\pi \left(\frac{\text{shell}}{\text{radius}} \right) \left(\frac{\text{shell}}{\text{height}} \right) dx = \int_{-1}^2 2\pi(x+1)(x+2-x^2) dx = 2\pi \int_{-1}^2 (2+3x-x^3) dx$
 $= 2\pi \left[2x + \frac{3}{2}x^2 - \frac{1}{4}x^4 \right]_{-1}^2 = 2\pi(4+6-4) - 2\pi(-2+\frac{3}{2}-\frac{1}{4}) = \frac{27\pi}{2}$

- (c)
$$V = \int_c^d 2\pi \left(\frac{\text{shell}}{\text{radius}} \right) \left(\frac{\text{shell}}{\text{height}} \right) dy = \int_0^1 2\pi y (\sqrt{y} - (-\sqrt{y})) dy + \int_1^4 2\pi y (\sqrt{y} - (y-2)) dy$$

$$= 4\pi \int_0^1 y^{3/2} dy + 2\pi \int_1^4 (y^{3/2} - y^2 + 2y) dy = \frac{8\pi}{5} [y^{5/2}]_0^1 + 2\pi \left[\frac{2}{5} y^{5/2} - \frac{1}{3} y^3 + y^2 \right]_1^4$$

$$= \frac{8\pi}{5} (1) + 2\pi \left(\frac{64}{5} - \frac{64}{3} + 16 \right) - 2\pi \left(\frac{2}{5} - \frac{1}{3} + 1 \right) = \frac{72\pi}{5}$$
- (d)
$$V = \int_c^d 2\pi \left(\frac{\text{shell}}{\text{radius}} \right) \left(\frac{\text{shell}}{\text{height}} \right) dy = \int_0^1 2\pi (4-y) (\sqrt{y} - (-\sqrt{y})) dy + \int_1^4 2\pi (4-y) (\sqrt{y} - (y-2)) dy$$

$$= 4\pi \int_0^1 (4\sqrt{y} - y^{3/2}) dy + 2\pi \int_1^4 (y^2 - y^{3/2} - 6y + 4\sqrt{y} + 8) dy$$

$$= 4\pi \left[\frac{8}{3} y^{3/2} - \frac{2}{5} y^{5/2} \right]_0^1 + 2\pi \left[\frac{1}{3} y^3 - \frac{2}{5} y^{5/2} - 3y^2 + \frac{8}{3} y^{3/2} + 8y \right]_1^4$$

$$= 4\pi \left(\frac{8}{3} - \frac{2}{5} \right) + 2\pi \left(\frac{64}{3} - \frac{64}{5} - 48 + \frac{64}{3} + 32 \right) - 2\pi \left(\frac{1}{3} - \frac{2}{5} - 3 + \frac{8}{3} + 8 \right) = \frac{108\pi}{5}$$
26. (a)
$$V = \int_a^b 2\pi \left(\frac{\text{shell}}{\text{radius}} \right) \left(\frac{\text{shell}}{\text{height}} \right) dx = \int_{-1}^1 2\pi (1-x) (4-3x^2-x^4) dx = 2\pi \int_{-1}^1 (x^5 - x^4 + 3x^3 - 3x^2 - 4x + 4) dx$$

$$= 2\pi \left[\frac{1}{6} x^6 - \frac{1}{5} x^5 + \frac{3}{4} x^4 - x^3 - 2x^2 + 4x \right]_{-1}^1 = 2\pi \left(\frac{1}{6} - \frac{1}{5} + \frac{3}{4} - 1 - 2 + 4 \right) - 2\pi \left(\frac{1}{6} + \frac{1}{5} + \frac{3}{4} + 1 - 2 - 4 \right) = \frac{56\pi}{5}$$
- (b)
$$V = \int_c^d 2\pi \left(\frac{\text{shell}}{\text{radius}} \right) \left(\frac{\text{shell}}{\text{height}} \right) dy = \int_0^1 2\pi y (4\sqrt{y} - (-4\sqrt{y})) dy + \int_1^4 2\pi y \left[\sqrt{\frac{4-y}{3}} - \left(-\sqrt{\frac{4-y}{3}} \right) \right] dy$$

$$= 4\pi \int_0^1 y^{5/4} dy + \frac{4\pi}{\sqrt{3}} \int_1^4 y \sqrt{4-y} dy \quad [u = 4-y \Rightarrow y = 4-u \Rightarrow du = -du; y=1 \Rightarrow u=3, y=4 \Rightarrow u=0]$$

$$= \frac{16\pi}{9} \left[y^{9/4} \right]_0^1 - \frac{4\pi}{\sqrt{3}} \int_3^0 (4-u)\sqrt{u} du = \frac{16\pi}{9} (1) + \frac{4\pi}{\sqrt{3}} \int_0^3 (4\sqrt{u} - u^{3/2}) du = \frac{16\pi}{9} + \frac{4\pi}{\sqrt{3}} \left[\frac{8}{3} u^{3/2} - \frac{2}{5} u^{5/2} \right]_0^3$$

$$= \frac{16\pi}{9} + \frac{4\pi}{\sqrt{3}} \left(8\sqrt{3} - \frac{18}{5}\sqrt{3} \right) = \frac{16\pi}{9} + \frac{88\pi}{5} = \frac{872\pi}{45}$$
27. (a)
$$V = \int_c^d 2\pi \left(\frac{\text{shell}}{\text{radius}} \right) \left(\frac{\text{shell}}{\text{height}} \right) dy = \int_0^1 2\pi y \cdot 12 (y^2 - y^3) dy = 24\pi \int_0^1 (y^3 - y^4) dy = 24\pi \left[\frac{y^4}{4} - \frac{y^5}{5} \right]_0^1$$

$$= 24\pi \left(\frac{1}{4} - \frac{1}{5} \right) = \frac{24\pi}{20} = \frac{6\pi}{5}$$
- (b)
$$V = \int_c^d 2\pi \left(\frac{\text{shell}}{\text{radius}} \right) \left(\frac{\text{shell}}{\text{height}} \right) dy = \int_0^1 2\pi (1-y) \left[12 (y^2 - y^3) \right] dy = 24\pi \int_0^1 (1-y) (y^2 - y^3) dy$$

$$= 24\pi \int_0^1 (y^2 - 2y^3 + y^4) dy = 24\pi \left[\frac{y^3}{3} - \frac{y^4}{2} + \frac{y^5}{5} \right]_0^1 = 24\pi \left(\frac{1}{3} - \frac{1}{2} + \frac{1}{5} \right) = 24\pi \left(\frac{1}{30} \right) = \frac{4\pi}{5}$$
- (c)
$$V = \int_c^d 2\pi \left(\frac{\text{shell}}{\text{radius}} \right) \left(\frac{\text{shell}}{\text{height}} \right) dy = \int_0^1 2\pi \left(\frac{8}{5} - y \right) \left[12 (y^2 - y^3) \right] dy = 24\pi \int_0^1 \left(\frac{8}{5} - y \right) (y^2 - y^3) dy$$

$$= 24\pi \int_0^1 \left(\frac{8}{5} y^2 - \frac{13}{5} y^3 + y^4 \right) dy = 24\pi \left[\frac{8}{15} y^3 - \frac{13}{20} y^4 + \frac{y^5}{5} \right]_0^1 = 24\pi \left(\frac{8}{15} - \frac{13}{20} + \frac{1}{5} \right)$$

$$= \frac{24\pi}{60} (32 - 39 + 12) = \frac{24\pi}{12} = 2\pi$$
- (d)
$$V = \int_c^d 2\pi \left(\frac{\text{shell}}{\text{radius}} \right) \left(\frac{\text{shell}}{\text{height}} \right) dy = \int_0^1 2\pi \left(y + \frac{2}{5} \right) \left[12 (y^2 - y^3) \right] dy = 24\pi \int_0^1 \left(y + \frac{2}{5} \right) (y^2 - y^3) dy$$

$$= 24\pi \int_0^1 \left(y^3 - y^4 + \frac{2}{5} y^2 - \frac{2}{5} y^3 \right) dy = 24\pi \int_0^1 \left(\frac{2}{5} y^2 + \frac{3}{5} y^3 - y^4 \right) dy = 24\pi \left[\frac{2}{15} y^3 + \frac{3}{20} y^4 - \frac{y^5}{5} \right]_0^1$$

$$= 24\pi \left(\frac{2}{15} + \frac{3}{20} - \frac{1}{5} \right) = \frac{24\pi}{60} (8 + 9 - 12) = \frac{24\pi}{12} = 2\pi$$

28. (a) $V = \int_c^d 2\pi \left(\begin{smallmatrix} \text{shell} \\ \text{radius} \end{smallmatrix} \right) \left(\begin{smallmatrix} \text{shell} \\ \text{height} \end{smallmatrix} \right) dy = \int_0^2 2\pi y \left[\frac{y^2}{2} - \left(\frac{y^4}{4} - \frac{y^2}{2} \right) \right] dy = \int_0^2 2\pi y \left(y^2 - \frac{y^4}{4} \right) dy = 2\pi \int_0^2 \left(y^3 - \frac{y^5}{4} \right) dy$
 $= 2\pi \left[\frac{y^4}{4} - \frac{y^6}{24} \right]_0^2 = 2\pi \left(\frac{2^4}{4} - \frac{2^6}{24} \right) = 32\pi \left(\frac{1}{4} - \frac{4}{24} \right) = 32\pi \left(\frac{1}{4} - \frac{1}{6} \right) = 32\pi \left(\frac{2}{24} \right) = \frac{8\pi}{3}$

(b) $V = \int_c^d 2\pi \left(\begin{smallmatrix} \text{shell} \\ \text{radius} \end{smallmatrix} \right) \left(\begin{smallmatrix} \text{shell} \\ \text{height} \end{smallmatrix} \right) dy = \int_0^2 2\pi(2-y) \left[\frac{y^2}{2} - \left(\frac{y^4}{4} - \frac{y^2}{2} \right) \right] dy = \int_0^2 2\pi(2-y) \left(y^2 - \frac{y^4}{4} \right) dy$
 $= 2\pi \int_0^2 \left(2y^2 - \frac{y^4}{2} - y^3 + \frac{y^5}{4} \right) dy = 2\pi \left[\frac{2y^3}{3} - \frac{y^5}{10} - \frac{y^4}{4} + \frac{y^6}{24} \right]_0^2 = 2\pi \left(\frac{16}{3} - \frac{32}{10} - \frac{16}{4} + \frac{64}{24} \right) = \frac{8\pi}{5}$

(c) $V = \int_c^d 2\pi \left(\begin{smallmatrix} \text{shell} \\ \text{radius} \end{smallmatrix} \right) \left(\begin{smallmatrix} \text{shell} \\ \text{height} \end{smallmatrix} \right) dy = \int_0^2 2\pi(5-y) \left[\frac{y^2}{2} - \left(\frac{y^4}{4} - \frac{y^2}{2} \right) \right] dy = \int_0^2 2\pi(5-y) \left(y^2 - \frac{y^4}{4} \right) dy$
 $= 2\pi \int_0^2 \left(5y^2 - \frac{5}{4}y^4 - y^3 + \frac{y^5}{4} \right) dy = 2\pi \left[\frac{5y^3}{3} - \frac{5y^5}{20} - \frac{y^4}{4} + \frac{y^6}{24} \right]_0^2 = 2\pi \left(\frac{40}{3} - \frac{160}{20} - \frac{16}{4} + \frac{64}{24} \right) = 8\pi$

(d) $V = \int_c^d 2\pi \left(\begin{smallmatrix} \text{shell} \\ \text{radius} \end{smallmatrix} \right) \left(\begin{smallmatrix} \text{shell} \\ \text{height} \end{smallmatrix} \right) dy = \int_0^2 2\pi \left(y + \frac{5}{8} \right) \left[\frac{y^2}{2} - \left(\frac{y^4}{4} - \frac{y^2}{2} \right) \right] dy = \int_0^2 2\pi \left(y + \frac{5}{8} \right) \left(y^2 - \frac{y^4}{4} \right) dy$
 $= 2\pi \int_0^2 \left(y^3 - \frac{y^5}{4} + \frac{5}{8}y^2 - \frac{5}{32}y^4 \right) dy = 2\pi \left[\frac{y^4}{4} - \frac{y^6}{24} + \frac{5y^3}{24} - \frac{5y^5}{160} \right]_0^2 = 2\pi \left(\frac{16}{4} - \frac{64}{24} + \frac{40}{24} - \frac{160}{160} \right) = 4\pi$

29. (a) About x -axis: $V = \int_c^d 2\pi \left(\begin{smallmatrix} \text{shell} \\ \text{radius} \end{smallmatrix} \right) \left(\begin{smallmatrix} \text{shell} \\ \text{height} \end{smallmatrix} \right) dy$
 $= \int_0^1 2\pi y (\sqrt{y} - y) dy = 2\pi \int_0^1 (y^{3/2} - y^2) dy$
 $= 2\pi \left[\frac{2}{5}y^{5/2} - \frac{1}{3}y^3 \right]_0^1 = 2\pi \left(\frac{2}{5} - \frac{1}{3} \right) = \frac{2\pi}{15}$

About y -axis: $V = \int_a^b 2\pi \left(\begin{smallmatrix} \text{shell} \\ \text{radius} \end{smallmatrix} \right) \left(\begin{smallmatrix} \text{shell} \\ \text{height} \end{smallmatrix} \right) dx$
 $= \int_0^1 2\pi x (x - x^2) dx = 2\pi \int_0^1 (x^2 - x^3) dx$
 $= 2\pi \left[\frac{x^3}{3} - \frac{x^4}{4} \right]_0^1 = 2\pi \left(\frac{1}{3} - \frac{1}{4} \right) = \frac{\pi}{6}$

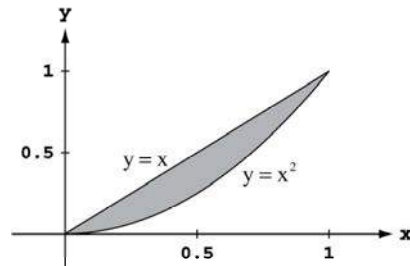

(b) About x -axis: $R(x) = x$ and $r(x) = x^2 \Rightarrow V = \int_a^b \pi \left([R(x)]^2 - [r(x)]^2 \right) dx = \int_0^1 \pi (x^2 - x^4) dx$
 $= \pi \left[\frac{x^3}{3} - \frac{x^5}{5} \right]_0^1 = \pi \left(\frac{1}{3} - \frac{1}{5} \right) = \frac{2\pi}{15}$

About y -axis: $R(y) = \sqrt{y}$ and $r(y) = y \Rightarrow V = \int_c^d \pi \left([R(y)]^2 - [r(y)]^2 \right) dy = \int_0^1 \pi (y - y^2) dy$
 $= \pi \left[\frac{y^2}{2} - \frac{y^3}{3} \right]_0^1 = \pi \left(\frac{1}{2} - \frac{1}{3} \right) = \frac{\pi}{6}$

30. (a) $V = \int_a^b \pi \left([R(x)]^2 - [r(x)]^2 \right) dx = \pi \int_0^4 \left[\left(\frac{x}{2} + 2 \right)^2 - x^2 \right] dx$
 $= \pi \int_0^4 \left(-\frac{3}{4}x^2 + 2x + 4 \right) dx = \pi \left[-\frac{x^3}{4} + x^2 + 4x \right]_0^4$
 $= \pi(-16 + 16 + 16) = 16\pi$

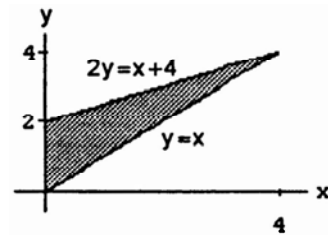

$$(b) \quad V = \int_a^b 2\pi \left(\begin{smallmatrix} \text{shell} \\ \text{radius} \end{smallmatrix} \right) \left(\begin{smallmatrix} \text{shell} \\ \text{height} \end{smallmatrix} \right) dx = \int_0^4 2\pi x \left(\frac{x}{2} + 2 - x \right) dx = \int_0^4 2\pi x \left(2 - \frac{x}{2} \right) dx = 2\pi \int_0^4 \left(2x - \frac{x^2}{2} \right) dx$$

$$= 2\pi \left[x^2 - \frac{x^3}{6} \right]_0^4 = 2\pi \left(16 - \frac{64}{6} \right) = \frac{32\pi}{3}$$

$$(c) \quad V = \int_a^b 2\pi \left(\begin{smallmatrix} \text{shell} \\ \text{radius} \end{smallmatrix} \right) \left(\begin{smallmatrix} \text{shell} \\ \text{height} \end{smallmatrix} \right) dx = \int_0^4 2\pi(4-x) \left(\frac{x}{2} + 2 - x \right) dx = \int_0^4 2\pi(4-x) \left(2 - \frac{x}{2} \right) dx = 2\pi \int_0^4 \left(8 - 4x - \frac{x^2}{2} \right) dx$$

$$= 2\pi \left[8x - 2x^2 + \frac{x^3}{6} \right]_0^4 = 2\pi \left(32 - 32 + \frac{64}{6} \right) = \frac{64\pi}{3}$$

$$(d) \quad V = \int_a^b \pi \left([R(x)]^2 - [r(x)]^2 \right) dx = \pi \int_0^4 \left[(8-x)^2 - \left(6 - \frac{x}{2} \right)^2 \right] dx = \pi \int_0^4 \left[(64 - 16x + x^2) - \left(36 - 6x + \frac{x^2}{4} \right) \right] dx$$

$$\pi \int_0^4 \left(\frac{3}{4}x^2 - 10x + 28 \right) dx = \pi \left[\frac{x^3}{4} - 5x^2 + 28x \right]_0^4 = \pi [16 - (5)(16) + (7)(16)] = \pi(3)(16) = 48\pi$$

31. (a) $V = \int_c^d 2\pi \left(\begin{smallmatrix} \text{shell} \\ \text{radius} \end{smallmatrix} \right) \left(\begin{smallmatrix} \text{shell} \\ \text{height} \end{smallmatrix} \right) dy = \int_1^2 2\pi y(y-1) dy$

$$= 2\pi \int_1^2 (y^2 - y) dy = 2\pi \left[\frac{y^3}{3} - \frac{y^2}{2} \right]_1^2$$

$$= 2\pi \left[\left(\frac{8}{3} - \frac{4}{2} \right) - \left(\frac{1}{3} - \frac{1}{2} \right) \right]$$

$$= 2\pi \left(\frac{7}{3} - 2 + \frac{1}{2} \right) = \frac{\pi}{3} (14 - 12 + 3) = \frac{5\pi}{3}$$

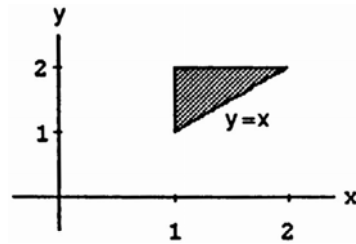

(b) $V = \int_a^b 2\pi \left(\begin{smallmatrix} \text{shell} \\ \text{radius} \end{smallmatrix} \right) \left(\begin{smallmatrix} \text{shell} \\ \text{height} \end{smallmatrix} \right) dx = \int_1^2 2\pi x(2-x) dx = 2\pi \int_1^2 (2x - x^2) dx = 2\pi \left[x^2 - \frac{x^3}{3} \right]_1^2$

$$= 2\pi \left[\left(4 - \frac{8}{3} \right) - \left(1 - \frac{1}{3} \right) \right] = 2\pi \left[\left(\frac{12-8}{3} \right) - \left(\frac{3-1}{3} \right) \right] = 2\pi \left(\frac{4}{3} - \frac{2}{3} \right) = \frac{4\pi}{3}$$

(c) $V = \int_a^b 2\pi \left(\begin{smallmatrix} \text{shell} \\ \text{radius} \end{smallmatrix} \right) \left(\begin{smallmatrix} \text{shell} \\ \text{height} \end{smallmatrix} \right) dx = \int_1^2 2\pi \left(\frac{10}{3} - x \right) (2-x) dx = 2\pi \int_1^2 \left(\frac{20}{3} - \frac{16}{3}x + x^2 \right) dx$

$$= 2\pi \left[\frac{20}{3}x - \frac{8}{3}x^2 + \frac{1}{3}x^3 \right]_1^2 = 2\pi \left[\left(\frac{40}{3} - \frac{32}{3} + \frac{8}{3} \right) - \left(\frac{20}{3} - \frac{8}{3} + \frac{1}{3} \right) \right] = 2\pi \left(\frac{3}{3} \right) = 2\pi$$

(d) $V = \int_c^d 2\pi \left(\begin{smallmatrix} \text{shell} \\ \text{radius} \end{smallmatrix} \right) \left(\begin{smallmatrix} \text{shell} \\ \text{height} \end{smallmatrix} \right) dy = \int_1^2 2\pi(y-1)(y-1) dy = 2\pi \int_1^2 (y-1)^2 dy = 2\pi \left[\frac{(y-1)^3}{3} \right]_1^2 = \frac{2\pi}{3}$

32. (a) $V = \int_c^d 2\pi \left(\begin{smallmatrix} \text{shell} \\ \text{radius} \end{smallmatrix} \right) \left(\begin{smallmatrix} \text{shell} \\ \text{height} \end{smallmatrix} \right) dy = \int_0^2 2\pi y(y^2 - 0) dy$

$$= 2\pi \int_0^2 y^3 dy = 2\pi \left[\frac{y^4}{4} \right]_0^2 = 2\pi \left(\frac{2^4}{4} \right) = 8\pi$$

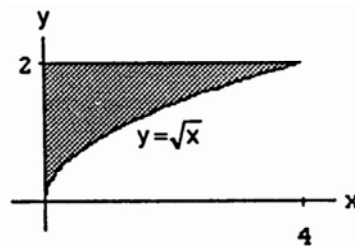

(b) $V = \int_a^b 2\pi \left(\begin{smallmatrix} \text{shell} \\ \text{radius} \end{smallmatrix} \right) \left(\begin{smallmatrix} \text{shell} \\ \text{height} \end{smallmatrix} \right) dx$

$$= \int_0^4 2\pi x(2 - \sqrt{x}) dx = 2\pi \int_0^4 (2x - x^{3/2}) dx$$

$$= 2\pi \left[x^2 - \frac{2}{5}x^{5/2} \right]_0^4 = 2\pi \left(16 - \frac{2 \cdot 2^5}{5} \right)$$

$$= 2\pi \left(16 - \frac{64}{5} \right) = \frac{2\pi}{5} (80 - 64) = \frac{32\pi}{5}$$

(c) $V = \int_a^b 2\pi \left(\begin{smallmatrix} \text{shell} \\ \text{radius} \end{smallmatrix} \right) \left(\begin{smallmatrix} \text{shell} \\ \text{height} \end{smallmatrix} \right) dx = \int_0^4 2\pi(4-x)(2 - \sqrt{x}) dx = 2\pi \int_0^4 (8 - 4x^{1/2} - 2x + x^{3/2}) dx$

$$= 2\pi \left[8x - \frac{8}{3}x^{3/2} - x^2 + \frac{2}{5}x^{5/2} \right]_0^4 = 2\pi \left(32 - \frac{64}{3} - 16 + \frac{64}{5} \right) = \frac{2\pi}{15} (240 - 320 + 192) = \frac{2\pi}{15} (112) = \frac{224\pi}{15}$$

$$\begin{aligned}
 \text{(d)} \quad V &= \int_c^d 2\pi \left(\begin{matrix} \text{shell} \\ \text{radius} \end{matrix} \right) \left(\begin{matrix} \text{shell} \\ \text{height} \end{matrix} \right) dy = \int_0^2 2\pi(2-y)(y^2) dy = 2\pi \int_0^2 (2y^2 - y^3) dy = 2\pi \left[\frac{2}{3}y^3 - \frac{y^4}{4} \right]_0^2 \\
 &= 2\pi \left(\frac{16}{3} - \frac{16}{4} \right) = \frac{32\pi}{12} (4-3) = \frac{8\pi}{3}
 \end{aligned}$$

$$\begin{aligned}
 \text{33. (a)} \quad V &= \int_c^d 2\pi \left(\begin{matrix} \text{shell} \\ \text{radius} \end{matrix} \right) \left(\begin{matrix} \text{shell} \\ \text{height} \end{matrix} \right) dy = \int_0^1 2\pi y (y - y^3) dy \\
 &= \int_0^1 2\pi (y^2 - y^4) dy = 2\pi \left[\frac{y^3}{3} - \frac{y^5}{5} \right]_0^1 = 2\pi \left(\frac{1}{3} - \frac{1}{5} \right) = \frac{4\pi}{15}
 \end{aligned}$$

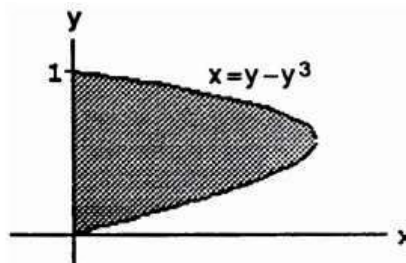

$$\begin{aligned}
 \text{(b)} \quad V &= \int_c^d 2\pi \left(\begin{matrix} \text{shell} \\ \text{radius} \end{matrix} \right) \left(\begin{matrix} \text{shell} \\ \text{height} \end{matrix} \right) dy = \int_0^1 2\pi(1-y)(y - y^3) dy \\
 &= 2\pi \int_0^1 (y - y^2 - y^3 + y^4) dy = 2\pi \left[\frac{y^2}{2} - \frac{y^3}{3} - \frac{y^4}{4} + \frac{y^5}{5} \right]_0^1 \\
 &= 2\pi \left(\frac{1}{2} - \frac{1}{3} - \frac{1}{4} + \frac{1}{5} \right) = \frac{2\pi}{60} (30 - 20 - 15 + 12) = \frac{7\pi}{30}
 \end{aligned}$$

$$\begin{aligned}
 \text{34. (a)} \quad V &= \int_c^d 2\pi \left(\begin{matrix} \text{shell} \\ \text{radius} \end{matrix} \right) \left(\begin{matrix} \text{shell} \\ \text{height} \end{matrix} \right) dy = \int_0^1 2\pi y [1 - (y - y^3)] dy \\
 &= 2\pi \int_0^1 (y - y^2 + y^4) dy = 2\pi \left[\frac{y^2}{2} - \frac{y^3}{3} + \frac{y^5}{5} \right]_0^1 \\
 &= 2\pi \left(\frac{1}{2} - \frac{1}{3} + \frac{1}{5} \right) = \frac{2\pi}{30} (15 - 10 + 6) = \frac{11\pi}{15}
 \end{aligned}$$

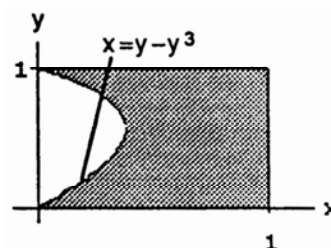

(b) Use the washer method:

$$\begin{aligned}
 V &= \int_c^d \pi \left([R(y)]^2 - [r(y)]^2 \right) dy = \int_0^1 \pi \left[1^2 - (y - y^3)^2 \right] dy = \pi \int_0^1 (1 - y^2 - y^6 + 2y^4) dy \\
 &= \pi \left[y - \frac{y^3}{3} - \frac{y^7}{7} + \frac{2y^5}{5} \right]_0^1 = \pi \left(1 - \frac{1}{3} - \frac{1}{7} + \frac{2}{5} \right) = \frac{\pi}{105} (105 - 35 - 15 + 42) = \frac{97\pi}{105}
 \end{aligned}$$

(c) Use the washer method:

$$\begin{aligned}
 V &= \int_c^d \pi \left([R(y)]^2 - [r(y)]^2 \right) dy = \int_0^1 \pi \left[[1 - (y - y^3)]^2 - 0 \right] dy = \pi \int_0^1 [1 - 2(y - y^3) + (y - y^3)^2] dy \\
 &= \pi \int_0^1 (1 + y^2 + y^6 - 2y + 2y^3 - 2y^4) dy = \pi \left[y + \frac{y^3}{3} + \frac{y^7}{7} - y^2 + \frac{y^4}{2} - \frac{2y^5}{5} \right]_0^1 \\
 &= \pi \left(1 + \frac{1}{3} + \frac{1}{7} - 1 + \frac{1}{2} - \frac{2}{5} \right) = \frac{\pi}{210} (70 + 30 + 105 - 2 \cdot 42) = \frac{121\pi}{210}
 \end{aligned}$$

$$\begin{aligned}
 \text{(d)} \quad V &= \int_c^d 2\pi \left(\begin{matrix} \text{shell} \\ \text{radius} \end{matrix} \right) \left(\begin{matrix} \text{shell} \\ \text{height} \end{matrix} \right) dy = \int_0^1 2\pi(1-y) [1 - (y - y^3)] dy = 2\pi \int_0^1 (1-y)(1 - y + y^3) dy \\
 &= 2\pi \int_0^1 (1 - y + y^3 - y + y^2 - y^4) dy = 2\pi \int_0^1 (1 - 2y + y^2 + y^3 - y^4) dy = 2\pi \left[y - y^2 + \frac{y^3}{3} + \frac{y^4}{4} - \frac{y^5}{5} \right]_0^1 \\
 &= 2\pi \left(1 - 1 + \frac{1}{3} + \frac{1}{4} - \frac{1}{5} \right) = \frac{2\pi}{60} (20 + 15 - 12) = \frac{23\pi}{30}
 \end{aligned}$$

$$\begin{aligned}
 35. \quad (a) \quad V &= \int_c^d 2\pi \left(\frac{\text{shell radius}}{\text{radius}} \right) \left(\frac{\text{shell height}}{\text{height}} \right) dy = \int_0^1 2\pi y (\sqrt{8y} - y^2) dy \\
 &= 2\pi \int_0^1 (2\sqrt{2}y^{3/2} - y^3) dy = 2\pi \left[\frac{4\sqrt{2}}{5} y^{5/2} - \frac{y^4}{4} \right]_0^1 \\
 &= 2\pi \left(\frac{4\sqrt{2}(\sqrt{2})^5}{5} - \frac{2^4}{4} \right) = 2\pi \left(\frac{4 \cdot 2^3}{5} - \frac{4 \cdot 4}{4} \right) \\
 &= 2\pi \cdot 4 \left(\frac{8}{5} - 1 \right) = \frac{8\pi}{5} (8 - 5) = \frac{24\pi}{5}
 \end{aligned}$$

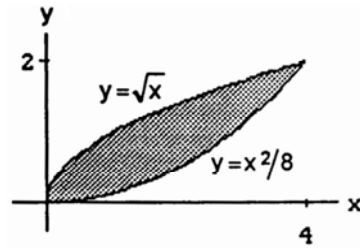

$$\begin{aligned}
 (b) \quad V &= \int_a^b 2\pi \left(\frac{\text{shell radius}}{\text{radius}} \right) \left(\frac{\text{shell height}}{\text{height}} \right) dx = \int_0^4 2\pi x \left(\sqrt{x} - \frac{x^2}{8} \right) dx = 2\pi \int_0^4 \left(x^{3/2} - \frac{x^3}{8} \right) dx = 2\pi \left[\frac{2}{5} x^{5/2} - \frac{x^4}{32} \right]_0^4 \\
 &= 2\pi \left(\frac{2 \cdot 2^5}{5} - \frac{4^4}{32} \right) = 2\pi \left(\frac{2^6}{5} - \frac{2^8}{32} \right) = \frac{\pi \cdot 2^7 \cdot 3}{160} (32 - 20) = \frac{\pi \cdot 2^9 \cdot 3}{160} = \frac{\pi \cdot 2^4 \cdot 3}{5} = \frac{48\pi}{5}
 \end{aligned}$$

$$\begin{aligned}
 36. \quad (a) \quad V &= \int_a^b 2\pi \left(\frac{\text{shell radius}}{\text{radius}} \right) \left(\frac{\text{shell height}}{\text{height}} \right) dx = \int_0^1 2\pi x \left[(2x - x^2) - x \right] dx \\
 &= 2\pi \int_0^1 x (x - x^2) dx = 2\pi \int_0^1 (x^2 - x^3) dx \\
 &= 2\pi \left[\frac{x^3}{3} - \frac{x^4}{4} \right]_0^1 = 2\pi \left(\frac{1}{3} - \frac{1}{4} \right) = \frac{\pi}{6}
 \end{aligned}$$

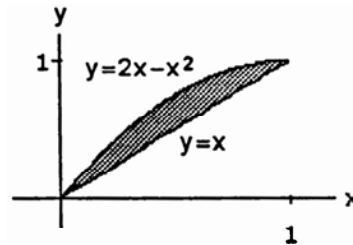

$$\begin{aligned}
 (b) \quad V &= \int_a^b 2\pi \left(\frac{\text{shell radius}}{\text{radius}} \right) \left(\frac{\text{shell height}}{\text{height}} \right) dx = \int_0^1 2\pi (1-x) \left[(2x - x^2) - x \right] dx = 2\pi \int_0^1 (1-x)(x - x^2) dx \\
 &= 2\pi \int_0^1 (x - 2x^2 + x^3) dx = 2\pi \left[\frac{x^2}{2} - \frac{2}{3}x^3 + \frac{x^4}{4} \right]_0^1 = 2\pi \left(\frac{1}{2} - \frac{2}{3} + \frac{1}{4} \right) = \frac{2\pi}{12} (6 - 8 + 3) = \frac{\pi}{6}
 \end{aligned}$$

$$\begin{aligned}
 37. \quad (a) \quad V &= \int_a^b \pi \left([R(x)]^2 - [r(x)]^2 \right) dx = \pi \int_{1/16}^1 (x^{-1/2} - 1) dx \\
 &= \pi \left[2x^{1/2} - x \right]_{1/16}^1 = \pi \left[(2 - 1) - \left(2 \cdot \frac{1}{4} - \frac{1}{16} \right) \right] \\
 &= \pi \left(1 - \frac{7}{16} \right) = \frac{9\pi}{16}
 \end{aligned}$$

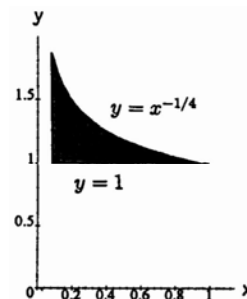

$$\begin{aligned}
 (b) \quad V &= \int_c^d 2\pi \left(\frac{\text{shell radius}}{\text{radius}} \right) \left(\frac{\text{shell height}}{\text{height}} \right) dy = \int_1^2 2\pi y \left(\frac{1}{y^4} - \frac{1}{16} \right) dy \\
 &= 2\pi \int_1^2 \left(y^{-3} - \frac{y}{16} \right) dy = 2\pi \left[-\frac{1}{2} y^{-2} - \frac{y^2}{32} \right]_1^2 \\
 &= 2\pi \left[\left(-\frac{1}{8} - \frac{1}{8} \right) - \left(-\frac{1}{2} - \frac{1}{32} \right) \right] = 2\pi \left(\frac{1}{4} + \frac{1}{32} \right) \\
 &= \frac{2\pi}{32} (8 + 1) = \frac{9\pi}{16}
 \end{aligned}$$

$$\begin{aligned}
 38. \quad (a) \quad V &= \int_c^d \pi \left([R(y)]^2 - [r(y)]^2 \right) dy = \int_1^2 \pi \left(\frac{1}{y^4} - \frac{1}{16} \right) dy \\
 &= \pi \left[-\frac{1}{3} y^{-3} - \frac{y}{16} \right]_1^2 = \pi \left[\left(-\frac{1}{24} - \frac{1}{8} \right) - \left(-\frac{1}{3} - \frac{1}{16} \right) \right] \\
 &= \frac{\pi}{48} (-2 - 6 + 16 + 3) = \frac{11\pi}{48}
 \end{aligned}$$

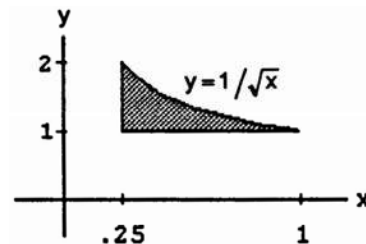

$$\begin{aligned} \text{(b)} \quad V &= \int_a^b 2\pi \left(\begin{matrix} \text{shell} \\ \text{radius} \end{matrix} \right) \left(\begin{matrix} \text{shell} \\ \text{height} \end{matrix} \right) dx = \int_{1/4}^1 2\pi \left(\frac{1}{\sqrt{x}} - 1 \right) dx = 2\pi \int_{1/4}^1 (x^{1/2} - x) dx = 2\pi \left[\frac{2}{3} x^{3/2} - \frac{x^2}{2} \right]_{1/4}^1 \\ &= 2\pi \left[\left(\frac{2}{3} - \frac{1}{2} \right) - \left(\frac{2}{3} \cdot \frac{1}{8} - \frac{1}{32} \right) \right] = \pi \left(\frac{4}{3} - 1 - \frac{1}{6} + \frac{1}{16} \right) = \frac{\pi}{48} (4 \cdot 16 - 48 - 8 + 3) = \frac{11\pi}{48} \end{aligned}$$

39. (a) *Disk*: $V = V_1 - V_2$

$$V_1 = \int_{a_1}^{b_1} \pi [R_1(x)]^2 dx \text{ and } V_2 = \int_{a_2}^{b_2} \pi [R_2(x)]^2 dx \text{ with } R_1(x) = \sqrt{\frac{x+2}{3}} \text{ and } R_2(x) = \sqrt{x},$$

$a_1 = -2, b_1 = 1; a_2 = 0, b_2 = 1 \Rightarrow$ two integrals are required

(b) *Washer*: $V = V_1 + V_2$

$$V_1 = \int_{a_1}^{b_1} \pi \left([R_1(x)]^2 - [r_1(x)]^2 \right) dx \text{ with } R_1(x) = \sqrt{\frac{x+2}{3}} \text{ and } r_1(x) = 0; a_1 = -2 \text{ and } b_1 = 0;$$

$$V_2 = \int_{a_2}^{b_2} \pi \left([R_2(x)]^2 - [r_2(x)]^2 \right) dx \text{ with } R_2(x) = \sqrt{\frac{x+2}{3}} \text{ and } r_2(x) = \sqrt{x}; a_2 = 0 \text{ and } b_2 = 1$$

\Rightarrow two integrals are required

(c) *Shell*: $V = \int_c^d 2\pi \left(\begin{matrix} \text{shell} \\ \text{radius} \right) \left(\begin{matrix} \text{shell} \\ \text{height} \end{matrix} \right) dy = \int_c^d 2\pi y \left(\begin{matrix} \text{shell} \\ \text{height} \end{matrix} \right) dy$ where shell height $= y^2 - (3y^2 - 2) = 2 - 2y^2$;

$c = 0$ and $d = 1$. Only *one* integral is required. It is, therefore preferable to use the *shell* method.

However, whichever method you use, you will get $V = \pi$.

40. (a) *Disk*: $V = V_1 - V_2 - V_3$

$$V_i = \int_{c_i}^{d_i} \pi [R_i(y)]^2 dy, \quad i = 1, 2, 3 \text{ with } R_1(y) = 1 \text{ and } c_1 = -1, d_1 = 1; R_2(y) = \sqrt{y} \text{ and } c_2 = 0 \text{ and } d_2 = 1;$$

$R_3(y) = (-y)^{1/4}$ and $c_3 = -1, d_3 = 0 \Rightarrow$ three integrals are required

(b) *Washer*: $V = V_1 + V_2$

$$V_i = \int_{c_i}^{d_i} \pi \left([R_i(y)]^2 - [r_i(y)]^2 \right) dy, \quad i = 1, 2 \text{ with } R_1(y) = 1, r_1(y) = \sqrt{y}, c_1 = 0 \text{ and } d_1 = 1;$$

$R_2(y) = 1, r_2(y) = (-y)^{1/4}, c_2 = -1 \text{ and } d_2 = 0 \Rightarrow$ two integrals are required

(c) *Shell*: $V = \int_a^b 2\pi \left(\begin{matrix} \text{shell} \\ \text{radius} \right) \left(\begin{matrix} \text{shell} \\ \text{height} \end{matrix} \right) dx = \int_a^b 2\pi x \left(\begin{matrix} \text{shell} \\ \text{height} \end{matrix} \right) dx$, where shell height $= x^2 - (-x^4) = x^2 + x^4, a = 0$

and $b = 1 \Rightarrow$ only one integral is required. It is, therefore preferable to use the *shell* method.

However, whichever method you use, you will get $V = \frac{5\pi}{6}$.

$$\text{41. (a)} \quad V = \int_a^b \pi \left([R(x)]^2 - [r(x)]^2 \right) dx = \int_{-4}^4 \pi \left[\left(\sqrt{25-x^2} \right)^2 - (3)^2 \right] dx = \pi \int_{-4}^4 (25-x^2-9) dx = \pi \int_{-4}^4 (16-x^2) dx$$

$$= \pi \left[16x - \frac{1}{3}x^3 \right]_{-4}^4 = \pi \left(64 - \frac{64}{3} \right) - \pi \left(-64 + \frac{64}{3} \right) = \frac{256\pi}{3}$$

(b) Volume of sphere $= \frac{4}{3}\pi(5)^3 = \frac{500\pi}{3} \Rightarrow$ Volume of portion removed $= \frac{500\pi}{3} - \frac{256\pi}{3} = \frac{244\pi}{3}$

$$\text{42. } V = \int_a^b 2\pi \left(\begin{matrix} \text{shell} \\ \text{radius} \end{matrix} \right) \left(\begin{matrix} \text{shell} \\ \text{height} \end{matrix} \right) dx = \int_1^{\sqrt{1+\pi}} 2\pi x \sin(x^2-1) dx; [u = x^2-1 \Rightarrow du = 2x dx;$$

$$x = 1 \Rightarrow u = 0, x = \sqrt{1+\pi} \Rightarrow u = \pi] \rightarrow \pi \int_0^\pi \sin u du = -\pi [\cos u]_0^\pi = -\pi(-1-1) = 2\pi$$

$$43. V = \int_a^b 2\pi \left(\frac{\text{shell}}{\text{radius}} \right) \left(\frac{\text{shell}}{\text{height}} \right) dx = \int_0^r 2\pi x \left(-\frac{h}{r}x + h \right) dx = 2\pi \int_0^r \left(-\frac{h}{r}x^2 + hx \right) dx = 2\pi \left[-\frac{h}{3r}x^3 + \frac{h}{2}x^2 \right]_0^r$$

$$= 2\pi \left(-\frac{r^2h}{3} + \frac{r^2h}{2} \right) = \frac{1}{3}\pi r^2h$$

$$44. V = \int_c^d 2\pi \left(\frac{\text{shell}}{\text{radius}} \right) \left(\frac{\text{shell}}{\text{height}} \right) dy = \int_0^r 2\pi y \left[\sqrt{r^2 - y^2} - \left(-\sqrt{r^2 - y^2} \right) \right] dy = 4\pi \int_0^r y\sqrt{r^2 - y^2} dy$$

$$[u = r^2 - y^2 \Rightarrow du = -2y dy; y = 0 \Rightarrow u = r^2, y = r \Rightarrow u = 0] \rightarrow -2\pi \int_{r^2}^0 \sqrt{u} du = 2\pi \int_0^{r^2} u^{1/2} du = \frac{4\pi}{3} \left[u^{3/2} \right]_0^{r^2}$$

$$= \frac{4\pi}{3} r^3$$

$$45. W(a) = \int_{f(a)}^{f(a)} \pi[(f^{-1}(y))^2 - a^2] dy = 0 = \int_a^a 2\pi x[f(a) - f(x)] dx = S(a);$$

$$W'(t) = \pi[f^{-1}(f(t))]^2 - a^2] f'(t) = \pi(t^2 - a^2) f'(t); \text{ also}$$

$$S(t) = 2\pi f(t) \int_a^t x dx - 2\pi \int_a^t xf(x) dx = [\pi f(t)t^2 - \pi f(t)a^2] - 2\pi \int_a^t xf(x) dx$$

$$\Rightarrow S'(t) = \pi t^2 f'(t) + 2\pi t f(t) - \pi a^2 f'(t) - 2\pi t f(t) = \pi(t^2 - a^2) f'(t) \Rightarrow W'(t) = S'(t). \text{ Therefore, } W(t) = S(t)$$

for all $t \in [a, b]$.

$$46. V = \pi \int_0^{\pi/3} [2^2 - (\sec y)^2] dy = \pi [4y - \tan y]_0^{\pi/3} = \pi \left(\frac{4\pi}{3} - \sqrt{3} \right)$$

$$47. V = \int_a^b 2\pi \left(\frac{\text{shell}}{\text{radius}} \right) \left(\frac{\text{shell}}{\text{height}} \right) dx = \int_0^1 2\pi x e^{-x^2} dx = -\pi e^{-x^2} \Big|_0^1 = -\pi(e^{-1} - e^0) = \pi \left(1 - \frac{1}{e} \right)$$

48. Use washer cross sections. A washer has inner radius

$$r = 1, \text{ outer radius } R = e^{x/2}, \text{ and area}$$

$$\pi(R^2 - r^2) = \pi(e^x - 1). \text{ The volume is}$$

$$V = \int_0^{\ln 3} \pi(e^x - 1) dx = \pi [e^x - x]_0^{\ln 3}$$

$$= \pi(3 - \ln 3 - 1) = \pi(2 - \ln 3)$$

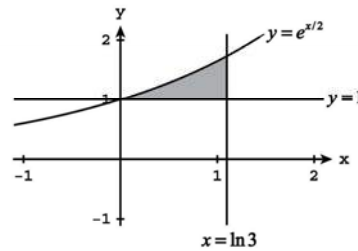

6.3 ARC LENGTH

$$1. \frac{dy}{dx} = \frac{1}{3} \cdot \frac{3}{2} (x^2 + 2)^{1/2} \cdot 2x = \sqrt{(x^2 + 2)} \cdot x$$

$$\Rightarrow L = \int_0^3 \sqrt{1 + (x^2 + 2)x^2} dx = \int_0^3 \sqrt{1 + 2x^2 + x^4} dx$$

$$= \int_0^3 \sqrt{(1 + x^2)^2} dx = \int_0^3 (1 + x^2) dx = \left[x + \frac{x^3}{3} \right]_0^3$$

$$= 3 + \frac{27}{3} = 12$$

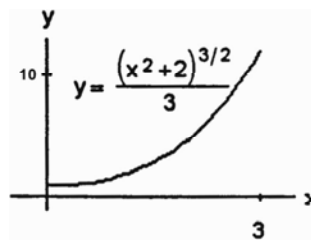

$$2. \frac{dy}{dx} = \frac{3}{2}\sqrt{x} \Rightarrow L = \int_0^4 \sqrt{1 + \frac{9}{4}x} dx;$$

$$\left[u = 1 + \frac{9}{4}x \Rightarrow du = \frac{9}{4}dx \Rightarrow \frac{4}{9}du = dx; \right.$$

$$x = 0 \Rightarrow u = 1; x = 4 \Rightarrow u = 10]$$

$$\rightarrow L = \int_1^{10} u^{1/2} \left(\frac{4}{9} du \right) = \frac{4}{9} \left[\frac{2}{3} u^{3/2} \right]_1^{10} = \frac{8}{27} (10\sqrt{10} - 1)$$

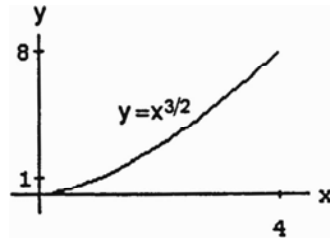

$$3. \frac{dx}{dy} = y^2 - \frac{1}{4y^2} \Rightarrow \left(\frac{dx}{dy} \right)^2 = y^4 - \frac{1}{2} + \frac{1}{16y^4}$$

$$\Rightarrow L = \int_1^3 \sqrt{1 + y^4 - \frac{1}{2} + \frac{1}{16y^4}} dy = \int_1^3 \sqrt{y^4 + \frac{1}{2} + \frac{1}{16y^4}} dy$$

$$= \int_1^3 \sqrt{\left(y^2 + \frac{1}{4y^2} \right)^2} dy = \int_1^3 \left(y^2 + \frac{1}{4y^2} \right) dy$$

$$= \left[\frac{y^3}{3} - \frac{y^{-1}}{4} \right]_1^3 = \left(\frac{27}{3} - \frac{1}{12} \right) - \left(\frac{1}{3} - \frac{1}{4} \right) = 9 - \frac{1}{12} - \frac{1}{3} + \frac{1}{4}$$

$$= 9 + \frac{(-1-4+3)}{12} = 9 + \frac{(-2)}{12} = \frac{53}{6}$$

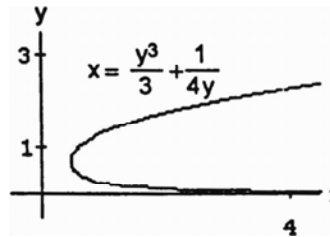

$$4. \frac{dx}{dy} = \frac{1}{2}y^{1/2} - \frac{1}{2}y^{-1/2} \Rightarrow \left(\frac{dx}{dy} \right)^2 = \frac{1}{4} \left(y - 2 + \frac{1}{y} \right)$$

$$\Rightarrow L = \int_1^9 \sqrt{1 + \frac{1}{4} \left(y - 2 + \frac{1}{y} \right)} dy = \int_1^9 \sqrt{\frac{1}{4} \left(y + 2 + \frac{1}{y} \right)} dy$$

$$= \int_1^9 \frac{1}{2} \sqrt{\left(\sqrt{y} + \frac{1}{\sqrt{y}} \right)^2} dy = \frac{1}{2} \int_1^9 \left(y^{1/2} + y^{-1/2} \right) dy$$

$$= \frac{1}{2} \left[\frac{2}{3} y^{3/2} + 2y^{1/2} \right]_1^9 = \left[\frac{y^{3/2}}{3} + y^{1/2} \right]_1^9$$

$$= \left(\frac{3^3}{3} + 3 \right) - \left(\frac{1}{3} + 1 \right) = 11 - \frac{1}{3} = \frac{32}{3}$$

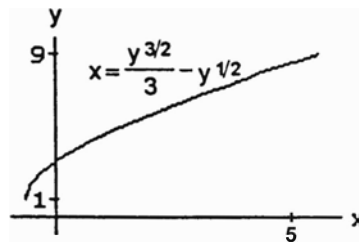

$$5. \frac{dx}{dy} = y^3 - \frac{1}{4y^3} \Rightarrow \left(\frac{dx}{dy} \right)^2 = y^6 - \frac{1}{2} + \frac{1}{16y^6}$$

$$\Rightarrow L = \int_1^2 \sqrt{1 + y^6 - \frac{1}{2} + \frac{1}{16y^6}} dy = \int_1^2 \sqrt{y^6 + \frac{1}{2} + \frac{1}{16y^6}} dy$$

$$= \int_1^2 \sqrt{\left(y^3 + \frac{y^{-3}}{4} \right)^2} dy = \int_1^2 \left(y^3 + \frac{y^{-3}}{4} \right) dy = \left[\frac{y^4}{4} - \frac{y^{-2}}{8} \right]_1^2$$

$$= \left(\frac{16}{4} - \frac{1}{(16)(2)} \right) - \left(\frac{1}{4} - \frac{1}{8} \right) = 4 - \frac{1}{32} - \frac{1}{4} + \frac{1}{8}$$

$$= \frac{128-1-8+4}{32} = \frac{123}{32}$$

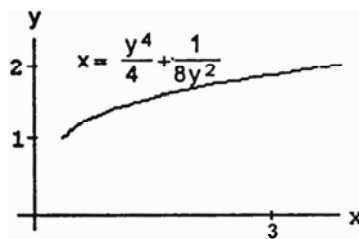

$$\begin{aligned}
 6. \quad \frac{dx}{dy} &= \frac{y^2}{2} - \frac{1}{2y^2} \Rightarrow \left(\frac{dx}{dy}\right)^2 = \frac{1}{4}(y^4 - 2 + y^{-4}) \\
 &\Rightarrow L = \int_2^3 \sqrt{1 + \frac{1}{4}(y^4 - 2 + y^{-4})} dy \\
 &= \int_2^3 \sqrt{\frac{1}{4}(y^4 + 2 + y^{-4})} dy \\
 &= \frac{1}{2} \int_2^3 \sqrt{(y^2 + y^{-2})^2} dy = \frac{1}{2} \int_2^3 (y^2 + y^{-2}) dy \\
 &= \frac{1}{2} \left[\frac{y^3}{3} - y^{-1} \right]_2^3 = \frac{1}{2} \left[\left(\frac{27}{3} - \frac{1}{3} \right) - \left(\frac{8}{3} - \frac{1}{2} \right) \right] \\
 &= \frac{1}{2} \left(\frac{26}{3} - \frac{8}{3} + \frac{1}{2} \right) = \frac{1}{2} \left(6 + \frac{1}{2} \right) = \frac{13}{4}
 \end{aligned}$$

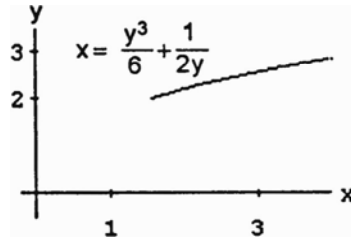

$$\begin{aligned}
 7. \quad \frac{dy}{dx} &= x^{1/3} - \frac{1}{4}x^{-1/3} \Rightarrow \left(\frac{dy}{dx}\right)^2 = x^{2/3} - \frac{1}{2} + \frac{x^{-2/3}}{16} \\
 &\Rightarrow L = \int_1^8 \sqrt{1 + x^{2/3} - \frac{1}{2} + \frac{x^{-2/3}}{16}} dx \\
 &= \int_1^8 \sqrt{x^{2/3} + \frac{1}{2} + \frac{x^{-2/3}}{16}} dx = \int_1^8 \sqrt{\left(x^{1/3} + \frac{1}{4}x^{-1/3}\right)^2} dx \\
 &= \int_1^8 \left(x^{1/3} + \frac{1}{4}x^{-1/3}\right) dx = \left[\frac{3}{4}x^{4/3} + \frac{3}{8}x^{2/3} \right]_1^8 \\
 &= \frac{3}{8} \left[2x^{4/3} + x^{2/3} \right]_1^8 = \frac{3}{8} \left[(2 \cdot 2^4 + 2^2) - (2 + 1) \right] \\
 &= \frac{3}{8} (32 + 4 - 3) = \frac{99}{8}
 \end{aligned}$$

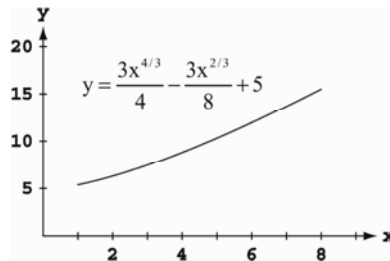

$$\begin{aligned}
 8. \quad \frac{dy}{dx} &= x^2 + 2x + 1 - \frac{4}{(4x+4)^2} = x^2 + 2x + 1 - \frac{1}{(1+x)^2} \\
 &= (1+x)^2 - \frac{1}{(1+x)^2} \Rightarrow \left(\frac{dy}{dx}\right)^2 = (1+x)^4 - \frac{1}{16(1+x)^4} \\
 &\Rightarrow L = \int_0^2 \sqrt{1 + (1+x)^4 - \frac{1}{2} + \frac{(1+x)^{-4}}{16}} dx \\
 &= \int_0^2 \sqrt{(1+x)^4 + \frac{1}{2} + \frac{(1+x)^{-4}}{16}} dx \\
 &= \int_0^2 \sqrt{\left[(1+x)^2 + \frac{(1+x)^{-2}}{4}\right]^2} dx \\
 &= \int_0^2 \left[(1+x)^2 + \frac{(1+x)^{-2}}{4} \right] dx; [u = 1+x \Rightarrow du = dx; x=0 \Rightarrow u=1, x=2 \Rightarrow u=3] \rightarrow L = \int_1^3 \left(u^2 + \frac{1}{4}u^{-2} \right) du \\
 &= \left[\frac{u^3}{3} - \frac{1}{4}u^{-1} \right]_1^3 = \left(9 - \frac{1}{12} \right) - \left(\frac{1}{3} - \frac{1}{4} \right) = \frac{108-1-4+3}{12} = \frac{106}{12} = \frac{53}{6}
 \end{aligned}$$

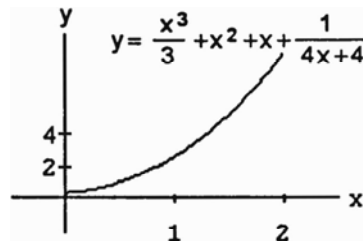

$$\begin{aligned}
 9. \quad \frac{dx}{dy} &= \frac{1}{x} - \frac{x}{4} = \left(\frac{dx}{dy}\right)^2 = \left(\frac{1}{x} - \frac{x}{4}\right)^2 = \frac{1}{x^2} - \frac{1}{2} + \frac{x^2}{16} \\
 \Rightarrow L &= \int_1^2 \sqrt{1 + \frac{1}{x^2} - \frac{1}{2} + \frac{x^2}{16}} dx = \int_1^2 \sqrt{\frac{1}{x^2} + \frac{1}{2} + \frac{x^2}{16}} dx = \\
 &= \int_1^2 \sqrt{\left(\frac{1}{x} + \frac{x}{4}\right)^2} dx = \int_1^2 \left(\frac{1}{x} + \frac{x}{4}\right) dx = \left[\ln|x| + \frac{x^2}{8}\right]_1^2 = \\
 &= \left(\ln 2 + \frac{4}{8}\right) - \left(\ln 1 - \frac{1}{8}\right) = \ln 2 + \frac{3}{8}
 \end{aligned}$$

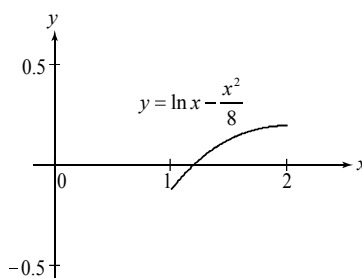

$$\begin{aligned}
 10. \quad \frac{dy}{dx} &= x - \frac{1}{4x} \Rightarrow \left(\frac{dy}{dx}\right)^2 = \left(x - \frac{1}{4x}\right)^2 = x^2 - \frac{1}{2} + \frac{1}{16x^2} \\
 \Rightarrow L &= \int_1^3 \sqrt{1 + x^2 - \frac{1}{2} + \frac{1}{16x^2}} dx = \\
 &= \int_1^3 \sqrt{x^2 + \frac{1}{2} + \frac{1}{16x^2}} dx = \int_1^3 \sqrt{\left(x + \frac{1}{4x}\right)^2} dx = \\
 &= \int_1^3 \left(x + \frac{1}{4x}\right) dx = \left[\frac{x^2}{2} + \frac{1}{4} \ln|x|\right]_1^3 = \\
 &= \left(\frac{9}{2} + \frac{1}{4} \ln 3\right) - \left(\frac{1}{2} + \frac{1}{4} \ln 1\right) = 4 + \frac{1}{4} \ln 3
 \end{aligned}$$

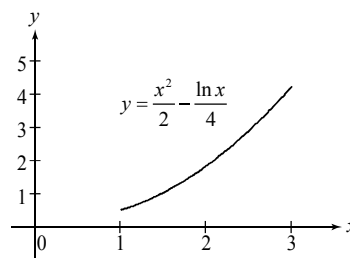

$$\begin{aligned}
 11. \quad \frac{dy}{dx} &= x^2 - \frac{1}{4x^2} \Rightarrow \left(\frac{dy}{dx}\right)^2 = \left(x^2 - \frac{1}{4x^2}\right)^2 = x^4 - \frac{1}{2} + \frac{1}{16x^4} \\
 \Rightarrow L &= \int_1^3 \sqrt{1 + x^4 - \frac{1}{2} + \frac{1}{16x^4}} dx = \\
 &= \int_1^3 \sqrt{x^4 + \frac{1}{2} + \frac{1}{16x^4}} dx = \int_1^3 \sqrt{\left(x^2 + \frac{1}{4x^2}\right)^2} dx = \\
 &= \int_1^3 \left(x^2 + \frac{1}{4x^2}\right) dx = \left[\frac{x^3}{3} - \frac{1}{4x}\right]_1^3 = \left(9 + \frac{1}{12}\right) - \left(\frac{1}{3} + \frac{1}{3}\right) = \frac{53}{6}
 \end{aligned}$$

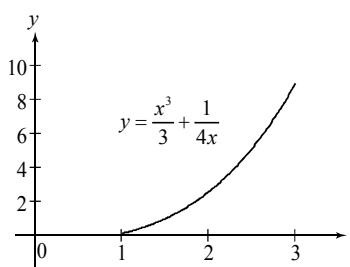

$$\begin{aligned}
 12. \quad \frac{dy}{dx} &= x^4 - \frac{1}{4x^4} \Rightarrow \left(\frac{dy}{dx}\right)^2 = \left(x^4 - \frac{1}{4x^4}\right)^2 = x^8 - \frac{1}{2} + \frac{1}{16x^8} \\
 \Rightarrow L &= \int_{1/2}^1 \sqrt{1 + x^8 - \frac{1}{2} + \frac{1}{16x^8}} dx = \\
 &= \int_{1/2}^1 \sqrt{x^8 + \frac{1}{2} + \frac{1}{16x^8}} dx = \int_{1/2}^1 \sqrt{\left(x^4 + \frac{1}{4x^4}\right)^2} dx = \\
 &= \int_{1/2}^1 \left(x^4 + \frac{1}{4x^4}\right) dx = \left[\frac{x^5}{5} - \frac{1}{12x^3}\right]_{1/2}^1 = \\
 &= \left(\frac{1}{5} - \frac{1}{12}\right) - \left(\frac{1}{160} - \frac{2}{3}\right) = \frac{373}{480}
 \end{aligned}$$

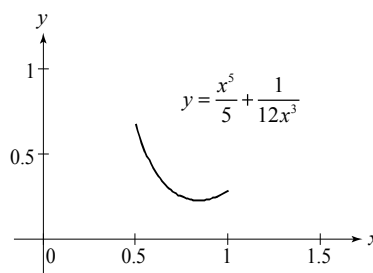

$$\begin{aligned}
 13. \quad \frac{dx}{dy} &= \sqrt{\sec^4 y - 1} \Rightarrow \left(\frac{dx}{dy}\right)^2 = \sec^4 y - 1 \\
 \Rightarrow L &= \int_{-\pi/4}^{\pi/4} \sqrt{1 + (\sec^4 y - 1)} dy = \int_{-\pi/4}^{\pi/4} \sec^2 y dy \\
 &= [\tan y]_{-\pi/4}^{\pi/4} = 1 - (-1) = 2
 \end{aligned}$$

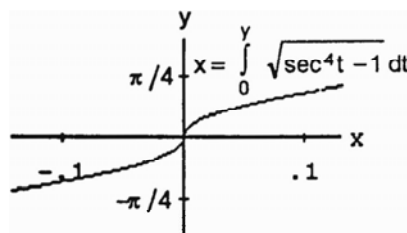

14. $\frac{dy}{dx} = \sqrt{3x^4 - 1} \Rightarrow \left(\frac{dy}{dx}\right)^2 = 3x^4 - 1$
 $\Rightarrow L = \int_{-2}^{-1} \sqrt{1 + (3x^4 - 1)} dx = \int_{-2}^{-1} \sqrt{3} x^2 dx$
 $= \sqrt{3} \left[\frac{x^3}{3} \right]_{-2}^{-1} = \frac{\sqrt{3}}{3} [-1 - (-2)^3] = \frac{\sqrt{3}}{3} (-1 + 8) = \frac{7\sqrt{3}}{3}$

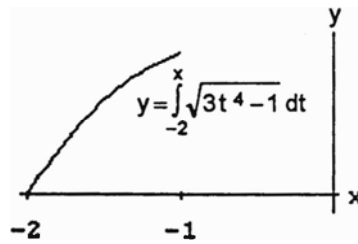

15. (a) $\frac{dy}{dx} = 2x \Rightarrow \left(\frac{dy}{dx}\right)^2 = 4x^2$
 $\Rightarrow L = \int_{-1}^2 \sqrt{1 + \left(\frac{dy}{dx}\right)^2} dx$
 $= \int_{-1}^2 \sqrt{1 + 4x^2} dx$
 (c) $L \approx 6.13$

(b)

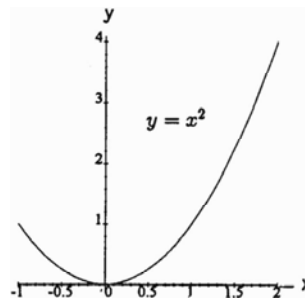

16. (a) $\frac{dy}{dx} = \sec^2 x \Rightarrow \left(\frac{dy}{dx}\right)^2 = \sec^4 x$
 $\Rightarrow L = \int_{-\pi/3}^0 \sqrt{1 + \sec^4 x} dx$
 (c) $L \approx 2.06$

(b)

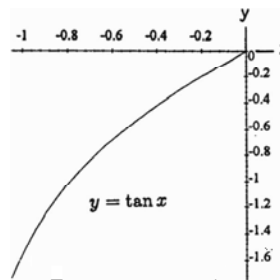

17. (a) $\frac{dx}{dy} = \cos y \Rightarrow \left(\frac{dx}{dy}\right)^2 = \cos^2 y$
 $\Rightarrow L = \int_0^\pi \sqrt{1 + \cos^2 y} dy$
 (c) $L \approx 3.82$

(b)

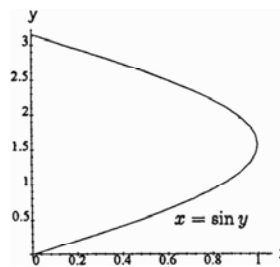

18. (a) $\frac{dx}{dy} = -\frac{y}{\sqrt{1-y^2}} \Rightarrow \left(\frac{dx}{dy}\right)^2 = \frac{y^2}{1-y^2}$
 $\Rightarrow L = \int_{-1/2}^{1/2} \sqrt{1 + \frac{y^2}{1-y^2}} dy = \int_{-1/2}^{1/2} \sqrt{\frac{1}{1-y^2}} dy$
 $= \int_{-1/2}^{1/2} (1-y^2)^{-1/2} dy$
 (c) $L \approx 1.05$

(b)

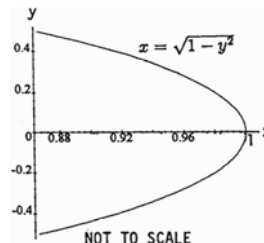

19. (a) $2y + 2 = 2 \frac{dx}{dy} \Rightarrow \left(\frac{dx}{dy}\right)^2 = (y+1)^2$
 $\Rightarrow L = \int_{-1}^3 \sqrt{1+(y+1)^2} dy$
 (c) $L \approx 9.29$

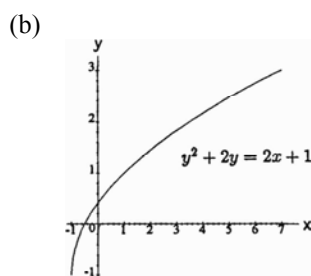

20. (a) $\frac{dy}{dx} = \cos x - \cos x + x \sin x \Rightarrow \left(\frac{dy}{dx}\right)^2 = x^2 \sin^2 x$
 $\Rightarrow L = \int_0^\pi \sqrt{1+x^2 \sin^2 x} dx$
 (c) $L \approx 4.70$

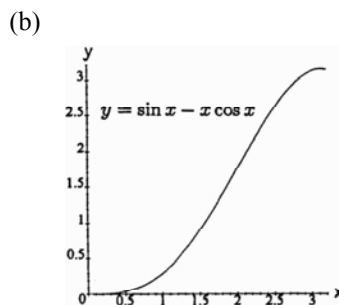

21. (a) $\frac{dy}{dx} = \tan x \Rightarrow \left(\frac{dy}{dx}\right)^2 = \tan^2 x$
 $\Rightarrow L = \int_0^{\pi/6} \sqrt{1+\tan^2 x} dx = \int_0^{\pi/6} \sqrt{\frac{\sin^2 x + \cos^2 x}{\cos^2 x}} dx$
 $= \int_0^{\pi/6} \frac{dx}{\cos x} = \int_0^{\pi/6} \sec x dx$
 (c) $L \approx 0.55$

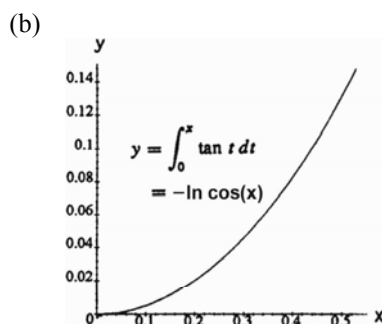

22. (a) $\frac{dx}{dy} = \sqrt{\sec^2 y - 1} \Rightarrow \left(\frac{dx}{dy}\right)^2 = \sec^2 y - 1$
 $\Rightarrow L = \int_{-\pi/3}^{\pi/4} \sqrt{1+(\sec^2 y - 1)} dy = \int_{-\pi/3}^{\pi/4} |\sec y| dy$
 $= \int_{-\pi/3}^{\pi/4} \sec y dy$
 (c) $L \approx 2.20$

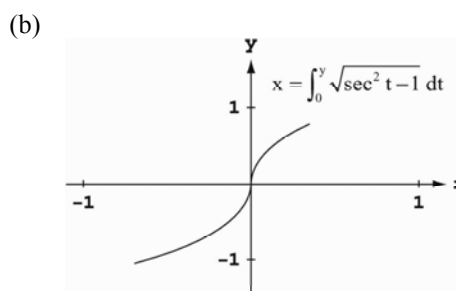

23. (a) $\left(\frac{dy}{dx}\right)^2$ corresponds to $\frac{1}{4x}$ here, so take $\frac{dy}{dx}$ as $\frac{1}{2\sqrt{x}}$. Then $y = \sqrt{x} + C$ and since $(1, 1)$ lies on the curve, $C = 0$. So $y = \sqrt{x}$ from $(1, 1)$ to $(4, 2)$.

(b) Only one. We know the derivative of the function and the value of the function at one value of x .

24. (a) $\left(\frac{dx}{dy}\right)^2$ corresponds to $\frac{1}{y^4}$ here, so take $\frac{dx}{dy}$ as $\frac{1}{y^2}$. Then $x = -\frac{1}{y} + C$ and, since $(0, 1)$ lies on the curve, $C = 1$. So $y = \frac{1}{1-x}$.

(b) Only one. We know the derivative of the function and the value of the function at one value of x .

$$25. \quad y = \int_0^x \sqrt{\cos 2t} \, dt \Rightarrow \frac{dy}{dx} = \sqrt{\cos 2x} \Rightarrow L = \int_0^{\pi/4} \sqrt{1 + [\sqrt{\cos 2x}]^2} \, dx = \int_0^{\pi/4} \sqrt{1 + \cos 2x} \, dx = \int_0^{\pi/4} \sqrt{2 \cos^2 x} \, dx \\ = \int_0^{\pi/4} \sqrt{2} \cos x \, dx = \sqrt{2} [\sin x]_0^{\pi/4} = \sqrt{2} \sin\left(\frac{\pi}{4}\right) - \sqrt{2} \sin(0) = 1$$

$$26. \quad y = (1 - x^{2/3})^{3/2}, \frac{\sqrt{2}}{4} \leq x \leq 1 \Rightarrow \frac{dy}{dx} = \frac{3}{2}(1 - x^{2/3})^{1/2} \left(-\frac{2}{3}x^{-1/3}\right) = -\frac{(1 - x^{2/3})^{1/2}}{x^{1/3}} \Rightarrow L = \int_{\sqrt{2}/4}^1 \sqrt{1 + \left[-\frac{(1 - x^{2/3})^{1/2}}{x^{1/3}}\right]^2} \, dx \\ = \int_{\sqrt{2}/4}^1 \sqrt{1 + \frac{1 - x^{2/3}}{x^{2/3}}} \, dx = \int_{\sqrt{2}/4}^1 \sqrt{1 + \frac{1}{x^{2/3}} - 1} \, dx = \int_{\sqrt{2}/4}^1 \sqrt{\frac{1}{x^{2/3}}} \, dx = \int_{\sqrt{2}/4}^1 \frac{1}{x^{1/3}} \, dx = \int_{\sqrt{2}/4}^1 x^{-1/3} \, dx = \frac{3}{2} \left[x^{2/3} \right]_{\sqrt{2}/4}^1 \\ = \frac{3}{2}(1)^{2/3} - \frac{3}{2}\left(\frac{\sqrt{2}}{4}\right)^{2/3} = \frac{3}{2} - \frac{3}{2}\left(\frac{1}{2}\right) = \frac{3}{4} \Rightarrow \text{total length} = 8\left(\frac{3}{4}\right) = 6$$

$$27. \quad y = 3 - 2x, 0 \leq x \leq 2 \Rightarrow \frac{dy}{dx} = -2 \Rightarrow L = \int_0^2 \sqrt{1 + (-2)^2} \, dx = \int_0^2 \sqrt{5} \, dx = [\sqrt{5} x]_0^2 = 2\sqrt{5}. \\ d = \sqrt{(2-0)^2 + (3-(-1))^2} = 2\sqrt{5}$$

28. Consider the circle $x^2 + y^2 = r^2$, we will find the length of the portion in the first quadrant, and multiply our result by 4.

$$y = \sqrt{r^2 - x^2}, 0 \leq x \leq r \Rightarrow \frac{dy}{dx} = \frac{-x}{\sqrt{r^2 - x^2}} \Rightarrow L = 4 \int_0^r \sqrt{1 + \left[\frac{-x}{\sqrt{r^2 - x^2}}\right]^2} \, dx = 4 \int_0^r \sqrt{1 + \frac{x^2}{r^2 - x^2}} \, dx = 4 \int_0^r \sqrt{\frac{r^2}{r^2 - x^2}} \, dx \\ = 4 \int_0^r \frac{r}{\sqrt{r^2 - x^2}} \, dx = 4r \int_0^r \frac{dx}{\sqrt{r^2 - x^2}}$$

$$29. \quad 9x^2 = y(y-3)^2 \Rightarrow \frac{d}{dy}[9x^2] = \frac{d}{dy}[y(y-3)^2] \Rightarrow 18x \frac{dx}{dy} = 2y(y-3) + (y-3)^2 = 3(y-3)(y-1) \\ \Rightarrow \frac{dx}{dy} = \frac{(y-3)(y-1)}{6x} \Rightarrow dx = \frac{(y-3)(y-1)}{6x} dy; \quad ds^2 = dx^2 + dy^2 = \left[\frac{(y-3)(y-1)}{6x} dy\right]^2 + dy^2 = \frac{(y-3)^2(y-1)^2}{36x^2} dy^2 + dy^2 \\ = \frac{(y-3)^2(y-1)^2}{4y(y-3)^2} dy^2 + dy^2 = \left[\frac{(y-1)^2}{4y} + 1\right] dy^2 = \frac{y^2 - 2y + 1 + 4y}{4y} dy^2 = \frac{(y+1)^2}{4y} dy^2$$

$$30. \quad 4x^2 - y^2 = 64 \Rightarrow \frac{d}{dx}[4x^2 - y^2] = \frac{d}{dx}[64] \Rightarrow 8x - 2y \frac{dy}{dx} = 0 \Rightarrow \frac{dy}{dx} = \frac{4x}{y} \Rightarrow dy = \frac{4x}{y} dx; \\ ds^2 = dx^2 + dy^2 = dx^2 + \left[\frac{4x}{y} dx\right]^2 = dx^2 + \frac{16x^2}{y^2} dx^2 = \left(1 + \frac{16x^2}{y^2}\right) dx^2 = \frac{y^2 + 16x^2}{y^2} dx^2 = \frac{4x^2 - 64 + 16x^2}{y^2} dx^2 \\ = \frac{20x^2 - 64}{y^2} dx^2 = \frac{4}{y^2} (5x^2 - 16) dx^2$$

$$31. \quad \sqrt{2} x = \int_0^x \sqrt{1 + \left(\frac{dy}{dt}\right)^2} \, dt, x \geq 0 \Rightarrow \sqrt{2} = \sqrt{1 + \left(\frac{dy}{dx}\right)^2} \Rightarrow \frac{dy}{dx} = \pm 1 \Rightarrow y = f(x) = \pm x + C \text{ where } C \text{ is any real number.}$$

32. (a) From the accompanying figure and definition of the differential (change along the tangent line) we see that $dy = f'(x_{k-1})\Delta x_k \Rightarrow$ length of k th tangent fin is

$$\sqrt{(\Delta x_k)^2 + (dy)^2} = \sqrt{(\Delta x_k)^2 + [f'(x_{k-1})\Delta x_k]^2}.$$

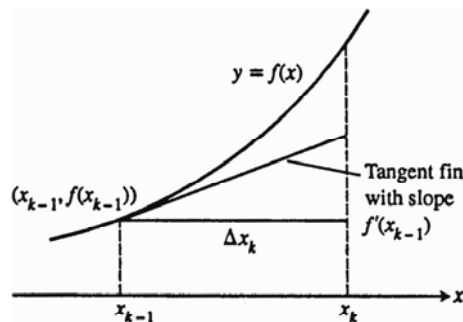

(b) Length of curve = $\lim_{n \rightarrow \infty} \sum_{k=1}^n$ (length of k th tangent fin) = $\lim_{n \rightarrow \infty} \sum_{k=1}^n \sqrt{(\Delta x_k)^2 + [f'(x_{k-1})\Delta x_k]^2}$
 $= \lim_{n \rightarrow \infty} \sum_{k=1}^n \sqrt{1 + [f'(x_{k-1})]^2} \Delta x_k = \int_a^b \sqrt{1 + [f'(x)]^2} dx$

33. $x^2 + y^2 = 1 \Rightarrow y = \sqrt{1 - x^2}$; $P = \{0, \frac{1}{4}, \frac{1}{2}, \frac{3}{4}, 1\} \Rightarrow L \approx \sum_{k=1}^4 \sqrt{(x_i - x_{i-1})^2 + (y_i - y_{i-1})^2}$
 $= \sqrt{(\frac{1}{4} - 0)^2 + (\frac{\sqrt{15}}{4} - 1)^2} + \sqrt{(\frac{1}{2} - \frac{1}{4})^2 + (\frac{\sqrt{3}}{2} - \frac{\sqrt{15}}{4})^2} + \sqrt{(\frac{3}{4} - \frac{1}{2})^2 + (\frac{\sqrt{7}}{4} - \frac{\sqrt{3}}{2})^2} + \sqrt{(1 - \frac{3}{4})^2 + (0 - \frac{\sqrt{7}}{4})^2}$
 ≈ 1.55225

34. Let (x_1, y_1) and (x_2, y_2) , with $x_2 > x_1$, lie on $y = mx + b$, where $m = \frac{y_2 - y_1}{x_2 - x_1}$, then $\frac{dy}{dx} = m$
 $\Rightarrow L = \int_{x_1}^{x_2} \sqrt{1 + m^2} dx = \sqrt{1 + m^2} [x]_{x_1}^{x_2} = \sqrt{1 + m^2} (x_2 - x_1) = \sqrt{1 + (\frac{y_2 - y_1}{x_2 - x_1})^2} (x_2 - x_1)$
 $= \sqrt{\frac{(x_2 - x_1)^2 + (y_2 - y_1)^2}{(x_2 - x_1)^2}} (x_2 - x_1) = \frac{\sqrt{(x_2 - x_1)^2 + (y_2 - y_1)^2}}{(x_2 - x_1)} (x_2 - x_1) = \sqrt{(x_2 - x_1)^2 + (y_2 - y_1)^2}.$

35. $y = 2x^{3/2} \Rightarrow \frac{dy}{dx} = 3x^{1/2}$; $L(x) = \int_0^x \sqrt{1 + (3t^{1/2})^2} dt = \int_0^x \sqrt{1 + 9t} dt$;
 $[u = 1 + 9t \Rightarrow du = 9dt; t = 0 \Rightarrow u = 1, t = x \Rightarrow u = 1 + 9x] \rightarrow \frac{1}{9} \int_1^{1+9x} \sqrt{u} du = \frac{2}{27} [u^{3/2}]_1^{1+9x} = \frac{2}{27} (1 + 9x)^{3/2} - \frac{2}{27}$;
 $L(1) = \frac{2}{27} (10)^{3/2} - \frac{2}{27} = \frac{2(10\sqrt{10}-1)}{27}$

36. $y = \frac{x^3}{3} + x^2 + x + \frac{1}{4x+4} \Rightarrow \frac{dy}{dx} = x^2 + 2x + 1 - \frac{1}{4(x+1)^2} = (x+1)^2 - \frac{1}{4(x+1)^2}$;
 $L(x) = \int_0^x \sqrt{1 + \left[(t+1)^2 - \frac{1}{4(t+1)^2} \right]^2} dt = \int_0^x \sqrt{1 + \left[\frac{4(t+1)^4 - 1}{4(t+1)^2} \right]^2} dt = \int_0^x \sqrt{1 + \frac{[4(t+1)^4 - 1]^2}{16(t+1)^4}} dt$
 $= \int_0^x \sqrt{\frac{16(t+1)^4 + 16(t+1)^8 - 8(t+1)^4 + 1}{16(t+1)^4}} dt = \int_0^x \sqrt{\frac{16(t+1)^8 + 8(t+1)^4 + 1}{16(t+1)^4}} dt = \int_0^x \sqrt{\frac{[4(t+1)^4 + 1]^2}{16(t+1)^4}} dt = \int_0^x \frac{4(t+1)^4 + 1}{4(t+1)^2} dt$
 $= \int_0^x \left[(t+1)^2 + \frac{1}{4(t+1)^2} \right] dt$; $[u = t+1 \Rightarrow du = dt; t = 0 \Rightarrow u = 1, t = x \Rightarrow u = x+1] \rightarrow \int_1^{x+1} \left[u^2 + \frac{1}{4}u^{-2} \right] du$
 $= \left[\frac{1}{3}u^3 - \frac{1}{4}u^{-1} \right]_1^{x+1} = \left(\frac{1}{3}(x+1)^3 - \frac{1}{4(x+1)} \right) - \left(\frac{1}{3} - \frac{1}{4} \right) = \frac{1}{3}(x+1)^3 - \frac{1}{4(x+1)} - \frac{1}{12}$; $L(1) = \frac{8}{3} - \frac{1}{8} - \frac{1}{12} = \frac{59}{24}$

37-42. Example CAS commands:

Maple:

```
with( plots );
with( Student[Calculus1] );
with( student );
f := x -> sqrt(1-x^2); a := -1;
b := 1;
N := [2, 4, 8];
for n in N do
  xx := [seq( a+i*(b-a)/n, i=0..n )];
  pts := [seq([x, f(x)], x=xx)];
  L := simplify(add( distance(pts[i+1], pts[i]), i=1..n )); # (b)
  T := sprintf("#37(a) (Section 6.3)nn=%3d L=%8.5f\n", n, L );
  P[n] := plot( [f(x), pts], x=a..b, title=T ); # (a)
end do;
display( [seq(P[n], n=N)], insequence=true, scaling=constrained );
L := ArcLength( f(x), x=a..b, output=integral );
L = evalf( L ); # (c)
```

Mathematica: (assigned function and values for a, b, and n may vary)

```
Clear[x, f]
{a, b} = {-1, 1}; f[x_] = Sqrt[1 - x^2]
p1 = Plot[f[x], {x, a, b}]
n = 8;
pts = Table[{xn, f[xn]}, {xn, a, b, (b - a)/n} // N
Show[p1, Graphics[{Line[pts]}]]
Sum[ Sqrt[ (pts[[i+1, 1]] - pts[[i, 1]])^2 + (pts[[i+1, 2]] - pts[[i, 2]])^2 ], {i, 1, n} ]
NIntegrate[Sqrt[ 1 + f'[x]^2 ], {x, a, b}]
```

6.4 AREAS OF SURFACES OF REVOLUTION

1. (a) $\frac{dy}{dx} = \sec^2 x \Rightarrow \left(\frac{dy}{dx}\right)^2 = \sec^4 x$
 $\Rightarrow S = 2\pi \int_0^{\pi/4} (\tan x) \sqrt{1 + \sec^4 x} dx$
- (c) $S \approx 3.84$

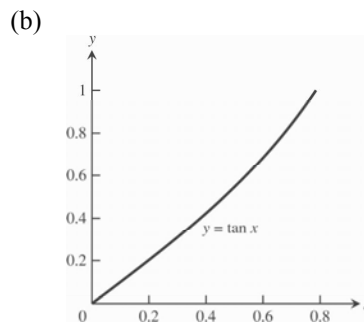

2. (a) $\frac{dy}{dx} = 2x \Rightarrow \left(\frac{dy}{dx}\right)^2 = 4x^2$
 $\Rightarrow S = 2\pi \int_0^2 x^2 \sqrt{1+4x^2} dx$
 (c) $S \approx 53.23$

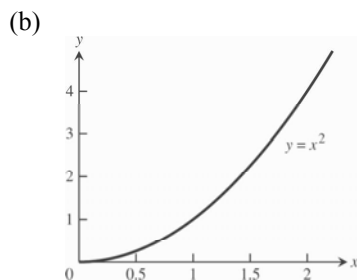

3. (a) $xy = 1 \Rightarrow x = \frac{1}{y} \Rightarrow \frac{dx}{dy} = -\frac{1}{y^2} \Rightarrow \left(\frac{dx}{dy}\right)^2 = \frac{1}{y^4}$
 $\Rightarrow S = 2\pi \int_1^2 \frac{1}{y} \sqrt{1+y^{-4}} dy$
 (c) $S \approx 5.02$

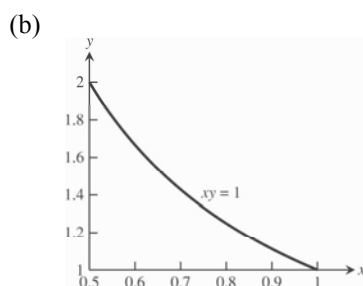

4. (a) $\frac{dx}{dy} = \cos y \Rightarrow \left(\frac{dx}{dy}\right)^2 = \cos^2 y$
 $\Rightarrow S = 2\pi \int_0^\pi (\sin y) \sqrt{1+\cos^2 y} dy$
 (c) $S \approx 14.42$

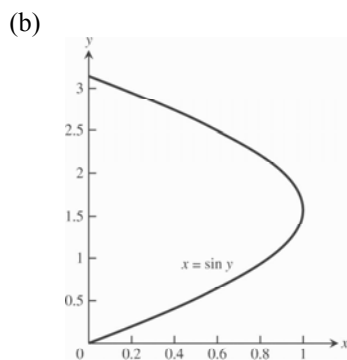

5. (a) $x^{1/2} + y^{1/2} = 3 \Rightarrow y = (3-x^{1/2})^2$
 $\Rightarrow \frac{dy}{dx} = 2(3-x^{1/2})\left(-\frac{1}{2}x^{-1/2}\right)$
 $\Rightarrow \left(\frac{dy}{dx}\right)^2 = (1-3x^{-1/2})^2$
 $\Rightarrow S = 2\pi \int_1^4 (3-x^{1/2})^2 \sqrt{1+(1-3x^{-1/2})^2} dx$
 (c) $S \approx 63.37$

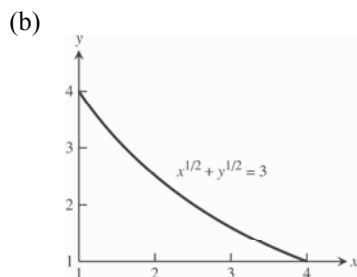

6. (a) $\frac{dx}{dy} = 1+y^{-1/2} \Rightarrow \left(\frac{dx}{dy}\right)^2 = (1+y^{-1/2})^2$
 $\Rightarrow S = 2\pi \int_1^2 (y+2\sqrt{y}) \sqrt{1+(1+y^{-1/2})^2} dx$
 (c) $S \approx 51.33$

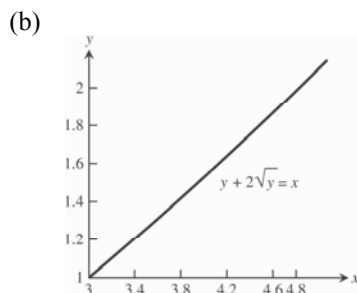

7. (a) $\frac{dx}{dy} = \tan y \Rightarrow \left(\frac{dx}{dy}\right)^2 = \tan^2 y$
 $\Rightarrow S = 2\pi \int_0^{\pi/3} \left(\int_0^y \tan t \, dt\right) \sqrt{1 + \tan^2 y} \, dy$
 $= 2\pi \int_0^{\pi/3} \left(\int_0^y \tan t \, dt\right) \sec y \, dy$
 (c) $S \approx 2.08$

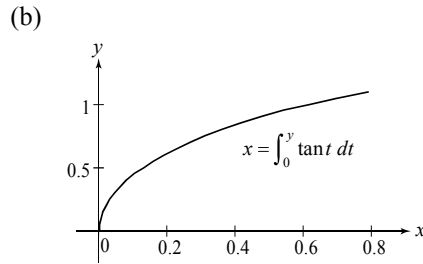

8. (a) $\frac{dy}{dx} = \sqrt{x^2 - 1} \Rightarrow \left(\frac{dy}{dx}\right)^2 = x^2 - 1$
 $\Rightarrow S = 2\pi \int_1^{\sqrt{5}} \left(\int_1^x \sqrt{t^2 - 1} \, dt\right) \sqrt{1 + (x^2 - 1)} \, dx$
 $= 2\pi \int_1^{\sqrt{5}} \left(\int_1^x \sqrt{t^2 - 1} \, dt\right) x \, dx$
 (c) $S \approx 8.55$

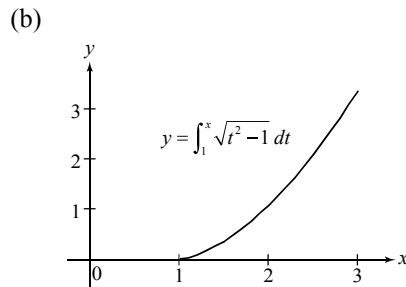

9. $y = \frac{x}{2} \Rightarrow \frac{dy}{dx} = \frac{1}{2}$; $S = \int_a^b 2\pi y \sqrt{1 + \left(\frac{dy}{dx}\right)^2} \, dx \Rightarrow S = \int_0^4 2\pi \left(\frac{x}{2}\right) \sqrt{1 + \frac{1}{4}} \, dx = \frac{\pi\sqrt{5}}{2} \int_0^4 x \, dx = \frac{\pi\sqrt{5}}{2} \left[\frac{x^2}{2}\right]_0^4 = 4\pi\sqrt{5}$;

Geometry formula: base circumference = $2\pi(2)$, slant height = $\sqrt{4^2 + 2^2} = 2\sqrt{5}$
 \Rightarrow Lateral surface area = $\frac{1}{2}(4\pi)(2\sqrt{5}) = 4\pi\sqrt{5}$ in agreement with the integral value

10. $y = \frac{x}{2} \Rightarrow x = 2y \Rightarrow \frac{dx}{dy} = 2$; $S = \int_c^d 2\pi x \sqrt{1 + \left(\frac{dx}{dy}\right)^2} \, dy = \int_0^2 2\pi \cdot 2y \sqrt{1 + 2^2} \, dy = 4\pi\sqrt{5} \int_0^2 y \, dy = 2\pi\sqrt{5} \left[y^2\right]_0^2$
 $= 2\pi\sqrt{5} \cdot 4 = 8\pi\sqrt{5}$; Geometry formula: base circumference = $2\pi(4)$, slant height = $\sqrt{4^2 + 2^2} = 2\sqrt{5}$
 \Rightarrow Lateral surface area = $\frac{1}{2}(8\pi)(2\sqrt{5}) = 8\pi\sqrt{5}$ in agreement with the integral value

11. $\frac{dx}{dy} = \frac{1}{2}$; $S = \int_a^b 2\pi y \sqrt{1 + \left(\frac{dy}{dx}\right)^2} \, dx = \int_1^3 2\pi \frac{(x+1)}{2} \sqrt{1 + \left(\frac{1}{2}\right)^2} \, dx = \frac{\pi\sqrt{5}}{2} \int_1^3 (x+1) \, dx = \frac{\pi\sqrt{5}}{2} \left[\frac{x^2}{2} + x\right]_1^3$
 $= \frac{\pi\sqrt{5}}{2} \left[\left(\frac{9}{2} + 3\right) - \left(\frac{1}{2} + 1\right)\right] = \frac{\pi\sqrt{5}}{2} (4 + 2) = 3\pi\sqrt{5}$; Geometry formula: $r_1 = \frac{1}{2} + \frac{1}{2} = 1$, $r_2 = \frac{3}{2} + \frac{1}{2} = 2$, slant height
 $= \sqrt{(2-1)^2 + (3-1)^2} = \sqrt{5} \Rightarrow$ Frustum surface area = $\pi(r_1 + r_2) \times$ slant height = $\pi(1+2)\sqrt{5} = 3\pi\sqrt{5}$ in agreement with the integral value

12. $y = \frac{x}{2} + \frac{1}{2} \Rightarrow x = 2y - 1 \Rightarrow \frac{dx}{dy} = 2$; $S = \int_c^d 2\pi x \sqrt{1 + \left(\frac{dx}{dy}\right)^2} \, dy = \int_1^2 2\pi (2y-1) \sqrt{1 + 4} \, dy = 2\pi\sqrt{5} \int_1^2 (2y-1) \, dy$
 $= 2\pi\sqrt{5} \left[y^2 - y\right]_1^2 = 2\pi\sqrt{5} [(4-2) - (1-1)] = 4\pi\sqrt{5}$; Geometry formula: $r_1 = 1$, $r_2 = 3$,
 slant height = $\sqrt{(2-1)^2 + (3-1)^2} = \sqrt{5} \Rightarrow$ Frustum surface area = $\pi(1+3)\sqrt{5} = 4\pi\sqrt{5}$ in agreement with the integral value

$$13. \frac{dy}{dx} = \frac{x^2}{3} \Rightarrow \left(\frac{dy}{dx}\right)^2 = \frac{x^4}{9} \Rightarrow S = \int_0^2 \frac{2\pi x^3}{9} \sqrt{1 + \frac{x^4}{9}} dx;$$

$$\left[u = 1 + \frac{x^4}{9} \Rightarrow du = \frac{4}{9} x^3 dx \Rightarrow \frac{1}{4} du = \frac{x^3}{9} dx; \right.$$

$$\left. x = 0 \Rightarrow u = 1, x = 2 \Rightarrow u = \frac{25}{9} \right] \rightarrow S = 2\pi \int_1^{25/9} u^{1/2} \cdot \frac{1}{4} du$$

$$= \frac{\pi}{2} \left[\frac{2}{3} u^{3/2} \right]_1^{25/9} = \frac{\pi}{3} \left(\frac{125}{27} - 1 \right) = \frac{\pi}{3} \left(\frac{125-27}{27} \right) = \frac{98\pi}{81}$$

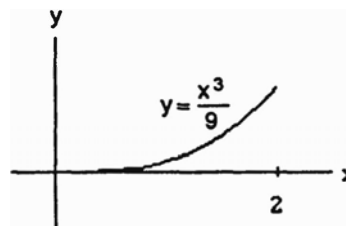

$$14. \frac{dy}{dx} = \frac{1}{2} x^{-1/2} \Rightarrow \left(\frac{dy}{dx}\right)^2 = \frac{1}{4x}$$

$$\Rightarrow S = \int_{3/4}^{15/4} 2\pi \sqrt{x} \sqrt{1 + \frac{1}{4x}} dx = 2\pi \int_{3/4}^{15/4} \sqrt{x + \frac{1}{4}} dx$$

$$= 2\pi \left[\frac{2}{3} \left(x + \frac{1}{4}\right)^{3/2} \right]_{3/4}^{15/4} = \frac{4\pi}{3} \left[\left(\frac{15}{4} + \frac{1}{4}\right)^{3/2} - \left(\frac{3}{4} + \frac{1}{4}\right)^{3/2} \right]$$

$$= \frac{4\pi}{3} \left[\left(\frac{4}{2}\right)^3 - 1 \right] = \frac{4\pi}{3} (8 - 1) = \frac{28\pi}{3}$$

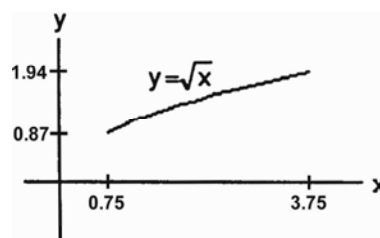

$$15. \frac{dy}{dx} = \frac{1}{2} \frac{(2-2x)}{\sqrt{2x-x^2}} = \frac{1-x}{\sqrt{2x-x^2}} \Rightarrow \left(\frac{dy}{dx}\right)^2 = \frac{(1-x)^2}{2x-x^2}$$

$$\Rightarrow S = \int_{0.5}^{1.5} 2\pi \sqrt{2x-x^2} \sqrt{1 + \frac{(1-x)^2}{2x-x^2}} dx$$

$$= 2\pi \int_{0.5}^{1.5} \sqrt{2x-x^2} \frac{\sqrt{2x-x^2+1-2x+x^2}}{\sqrt{2x-x^2}} dx$$

$$= 2\pi \int_{0.5}^{1.5} dx = 2\pi [x]_{0.5}^{1.5} = 2\pi$$

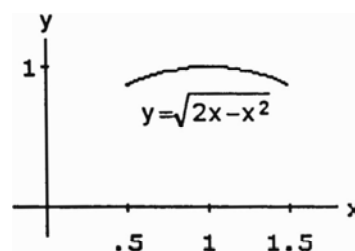

$$16. \frac{dy}{dx} = \frac{1}{2\sqrt{x+1}} \Rightarrow \left(\frac{dy}{dx}\right)^2 = \frac{1}{4(x+1)}$$

$$\Rightarrow S = \int_1^5 2\pi \sqrt{x+1} \sqrt{1 + \frac{1}{4(x+1)}} dx = 2\pi \int_1^5 \sqrt{(x+1) + \frac{1}{4}} dx$$

$$= 2\pi \int_1^5 \sqrt{x + \frac{5}{4}} dx = 2\pi \left[\frac{2}{3} \left(x + \frac{5}{4}\right)^{3/2} \right]_1^5$$

$$= \frac{4\pi}{3} \left[\left(5 + \frac{5}{4}\right)^{3/2} - \left(1 + \frac{5}{4}\right)^{3/2} \right] = \frac{4\pi}{3} \left[\left(\frac{25}{4}\right)^{3/2} - \left(\frac{9}{4}\right)^{3/2} \right]$$

$$= \frac{4\pi}{3} \left(\frac{5^3}{2^3} - \frac{3^3}{2^3} \right) = \frac{\pi}{6} (125 - 27) = \frac{98\pi}{6} = \frac{49\pi}{3}$$

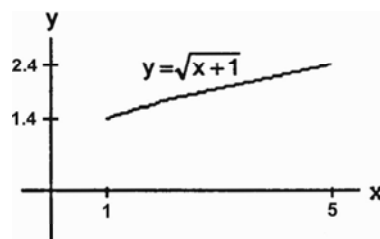

$$17. \frac{dx}{dy} = y^2 \Rightarrow \left(\frac{dx}{dy}\right)^2 = y^4 \Rightarrow S = \int_0^1 \frac{2\pi y^3}{3} \sqrt{1 + y^4} dy;$$

$$\left[u = 1 + y^4 \Rightarrow du = 4y^3 dy \Rightarrow \frac{1}{4} du = y^3 dy; \right.$$

$$\left. y = 0 \Rightarrow u = 1, y = 1 \Rightarrow u = 2 \right] \rightarrow S = \int_1^2 2\pi \left(\frac{1}{3}\right) u^{1/2} \left(\frac{1}{4} du\right)$$

$$= \frac{\pi}{6} \int_1^2 u^{1/2} du = \frac{\pi}{6} \left[\frac{2}{3} u^{3/2} \right]_1^2 = \frac{\pi}{9} (\sqrt{8} - 1)$$

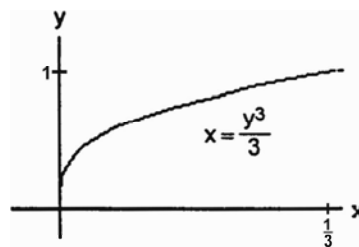

18. $x = \left(\frac{1}{3}y^{3/2} - y^{1/2}\right) \leq 0$, when $1 \leq y \leq 3$. To get positive area, we take $x = -\left(\frac{1}{3}y^{3/2} - y^{1/2}\right)$

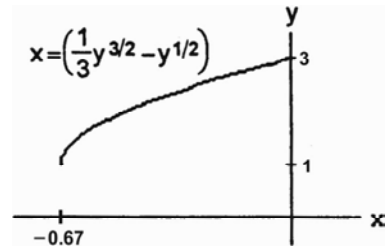

$$\begin{aligned} \Rightarrow \frac{dx}{dy} &= -\frac{1}{2}(y^{1/2} - y^{-1/2}) \Rightarrow \left(\frac{dx}{dy}\right)^2 = \frac{1}{4}(y - 2 + y^{-1}) \\ \Rightarrow S &= -\int_1^3 2\pi\left(\frac{1}{3}y^{3/2} - y^{1/2}\right)\sqrt{1 + \frac{1}{4}(y - 2 + y^{-1})} dy \\ &= -2\pi\int_1^3 \left(\frac{1}{3}y^{3/2} - y^{1/2}\right)\sqrt{\frac{1}{4}(y + 2 + y^{-1})} dy \\ &= -2\pi\int_1^3 \left(\frac{1}{3}y^{3/2} - y^{1/2}\right)\frac{\sqrt{(y^{1/2} + y^{-1/2})^2}}{2} dy = -\pi\int_1^3 y^{1/2}\left(\frac{1}{3}y - 1\right)\left(y^{1/2} + \frac{1}{y^{1/2}}\right) dy = -\pi\int_1^3 \left(\frac{1}{3}y - 1\right)(y + 1) dy \\ &= -\pi\int_1^3 \left(\frac{1}{3}y^2 - \frac{2}{3}y - 1\right) dy = -\pi\left[\frac{y^3}{9} - \frac{y^2}{3} - y\right]_1^3 = -\pi\left[\left(\frac{27}{9} - \frac{9}{3} - 3\right) - \left(\frac{1}{9} - \frac{1}{3} - 1\right)\right] = -\pi\left(-3 - \frac{1}{9} + \frac{1}{3} + 1\right) \\ &= -\frac{\pi}{9}(-18 - 1 + 3) = \frac{16\pi}{9} \end{aligned}$$

19. $\frac{dx}{dy} = \frac{-1}{\sqrt{4-y}} \Rightarrow \left(\frac{dx}{dy}\right)^2 = \frac{1}{4-y} \Rightarrow S = \int_0^{15/4} 2\pi \cdot 2\sqrt{4-y}\sqrt{1 + \frac{1}{4-y}} dy = 4\pi\int_0^{15/4} \sqrt{(4-y)+1} dy$

$$\begin{aligned} &= 4\pi\int_0^{15/4} \sqrt{5-y} dy = -4\pi\left[\frac{2}{3}(5-y)^{3/2}\right]_0^{15/4} = -\frac{8\pi}{3}\left[\left(5 - \frac{15}{4}\right)^{3/2} - 5^{3/2}\right] = -\frac{8\pi}{3}\left[\left(\frac{5}{4}\right)^{3/2} - 5^{3/2}\right] \\ &= \frac{8\pi}{3}\left(5\sqrt{5} - \frac{5\sqrt{5}}{8}\right) = \frac{8\pi}{3}\left(\frac{40\sqrt{5} - 5\sqrt{5}}{8}\right) = \frac{35\pi\sqrt{5}}{3} \end{aligned}$$

20. $\frac{dx}{dy} = \frac{1}{\sqrt{2y-1}} \Rightarrow \left(\frac{dx}{dy}\right)^2 = \frac{1}{2y-1} \Rightarrow S = \int_{5/8}^1 2\pi\sqrt{2y-1}\sqrt{1 + \frac{1}{2y-1}} dy = 2\pi\int_{5/8}^1 \sqrt{(2y-1)+1} dy = 2\pi\int_{5/8}^1 \sqrt{2y} dy$

$$\begin{aligned} &= 2\pi\sqrt{2}\left[\frac{2}{3}y^{3/2}\right]_{5/8}^1 = \frac{4\pi\sqrt{2}}{3}\left[1^{3/2} - \left(\frac{5}{8}\right)^{3/2}\right] = \frac{4\pi\sqrt{2}}{3}\left(1 - \frac{5\sqrt{5}}{8\sqrt{8}}\right) = \frac{4\pi\sqrt{2}}{3}\left(\frac{8\sqrt{2} - 5\sqrt{5}}{8\sqrt{2}}\right) = \frac{\pi}{12}(16\sqrt{2} - 5\sqrt{5}) \end{aligned}$$

21. $S = 2\pi\int_0^{\ln 2} \left(\frac{e^y + e^{-y}}{2}\right)\sqrt{1 + \left(\frac{e^y - e^{-y}}{2}\right)^2} dy = 2\pi\int_0^{\ln 2} \left(\frac{e^y + e^{-y}}{2}\right)\sqrt{1 + \frac{1}{4}(e^{2y} - 2 + e^{-2y})} dy$

$$\begin{aligned} &= 2\pi\int_0^{\ln 2} \left(\frac{e^y + e^{-y}}{2}\right)\sqrt{\left(\frac{e^y + e^{-y}}{2}\right)^2} dy = 2\pi\int_0^{\ln 2} \left(\frac{e^y + e^{-y}}{2}\right)^2 dy = \frac{\pi}{2}\int_0^{\ln 2} (e^{2y} + 2 + e^{-2y}) dy \\ &= \frac{\pi}{2}\left[\frac{1}{2}e^{2y} + 2y - \frac{1}{2}e^{-2y}\right]_0^{\ln 2} = \frac{\pi}{2}\left[\left(\frac{1}{2}e^{2\ln 2} + 2\ln 2 - \frac{1}{2}e^{-2\ln 2}\right) - \left(\frac{1}{2} + 0 - \frac{1}{2}\right)\right] \\ &= \frac{\pi}{2}\left(\frac{1}{2} \cdot 4 + 2\ln 2 - \frac{1}{2} \cdot \frac{1}{4}\right) = \frac{\pi}{2}\left(2 - \frac{1}{8} + 2\ln 2\right) = \pi\left(\frac{15}{16} + \ln 2\right) \end{aligned}$$

22. $y = \frac{1}{3}(x^2 + 2)^{3/2} \Rightarrow dy = x\sqrt{x^2 + 2} dx \Rightarrow ds = \sqrt{1 + (2x^2 + x^4)} dx \Rightarrow S = 2\pi\int_0^{\sqrt{2}} x\sqrt{1 + 2x^2 + x^4} dx$

$$\begin{aligned} &= 2\pi\int_0^{\sqrt{2}} x\sqrt{(x^2 + 1)^2} dx = 2\pi\int_0^{\sqrt{2}} x(x^2 + 1) dx = 2\pi\int_0^{\sqrt{2}} (x^3 + x) dx = 2\pi\left[\frac{x^4}{4} + \frac{x^2}{2}\right]_0^{\sqrt{2}} = 2\pi\left(\frac{4}{4} + \frac{2}{2}\right) = 4\pi \end{aligned}$$

$$\begin{aligned}
 23. \quad ds &= \sqrt{dx^2 + dy^2} = \sqrt{\left(y^3 - \frac{1}{4y^3}\right)^2 + 1} dy = \sqrt{\left(y^6 - \frac{1}{2} + \frac{1}{16y^6}\right) + 1} dy = \sqrt{\left(y^6 + \frac{1}{2} + \frac{1}{16y^6}\right)} dy \\
 &= \sqrt{\left(y^3 + \frac{1}{4y^3}\right)^2} dy = \left(y^3 + \frac{1}{4y^3}\right) dy; \quad S = \int_1^2 2\pi y ds = 2\pi \int_1^2 y \left(y^3 + \frac{1}{4y^3}\right) dy = 2\pi \int_1^2 \left(y^4 + \frac{1}{4}y^{-2}\right) dy \\
 &= 2\pi \left[\frac{y^5}{5} - \frac{1}{4}y^{-1}\right]_1^2 = 2\pi \left[\left(\frac{32}{5} - \frac{1}{8}\right) - \left(\frac{1}{5} - \frac{1}{4}\right)\right] = 2\pi \left(\frac{31}{5} + \frac{1}{8}\right) = \frac{2\pi}{40}(8 \cdot 31 + 5) = \frac{253\pi}{20}
 \end{aligned}$$

$$24. \quad y = \cos x \Rightarrow \frac{dy}{dx} = -\sin x \Rightarrow \left(\frac{dy}{dx}\right)^2 = \sin^2 x \Rightarrow S = 2\pi \int_{-\pi/2}^{\pi/2} (\cos x) \sqrt{1 + \sin^2 x} dx$$

$$\begin{aligned}
 25. \quad y &= \sqrt{a^2 - x^2} \Rightarrow \frac{dy}{dx} = \frac{1}{2}(a^2 - x^2)^{-1/2}(-2x) = \frac{-x}{\sqrt{a^2 - x^2}} \Rightarrow \left(\frac{dy}{dx}\right)^2 = \frac{x^2}{a^2 - x^2} \\
 \Rightarrow S &= 2\pi \int_{-a}^a \sqrt{a^2 - x^2} \sqrt{1 + \frac{x^2}{a^2 - x^2}} dx = 2\pi \int_{-a}^a \sqrt{(a^2 - x^2) + x^2} dx = 2\pi \int_{-a}^a a dx = 2\pi a[x]_{-a}^a \\
 &= 2\pi a[a - (-a)] = (2\pi a)(2a) = 4\pi a^2
 \end{aligned}$$

$$\begin{aligned}
 26. \quad y &= \frac{r}{h}x \Rightarrow \frac{dy}{dx} = \frac{r}{h} \Rightarrow \left(\frac{dy}{dx}\right)^2 = \frac{r^2}{h^2} \Rightarrow S = 2\pi \int_0^h \frac{r}{h}x \sqrt{1 + \frac{r^2}{h^2}} dx = 2\pi \int_0^h \frac{r}{h}x \sqrt{\frac{h^2 + r^2}{h^2}} dx = \frac{2\pi r}{h} \sqrt{\frac{h^2 + r^2}{h^2}} \int_0^h x dx \\
 &= \frac{2\pi r}{h^2} \sqrt{h^2 + r^2} \left[\frac{x^2}{2}\right]_0^h = \frac{2\pi r}{h^2} \sqrt{h^2 + r^2} \left(\frac{h^2}{2}\right) = \pi r \sqrt{h^2 + r^2}
 \end{aligned}$$

$$\begin{aligned}
 27. \quad \text{The area of the surface of one wok is } S &= \int_c^d 2\pi x \sqrt{1 + \left(\frac{dx}{dy}\right)^2} dy. \text{ Now, } x^2 + y^2 = 16^2 \Rightarrow x = \sqrt{16^2 - y^2} \\
 \Rightarrow \frac{dx}{dy} &= \frac{-y}{\sqrt{16^2 - y^2}} \Rightarrow \left(\frac{dx}{dy}\right)^2 = \frac{y^2}{16^2 - y^2}; \quad S = \int_{-16}^{-7} 2\pi \sqrt{16^2 - y^2} \sqrt{1 + \frac{y^2}{16^2 - y^2}} dy = \int_{-16}^{-7} 2\pi \sqrt{(16^2 - y^2) + y^2} dy \\
 &= 2\pi \int_{-16}^{-7} 16 dy = 32\pi \cdot 9 = 288\pi \approx 904.78 \text{ cm}^2. \text{ The enamel needed to cover one surface of one wok is} \\
 V &= S \cdot 0.5 \text{ mm} = S \cdot 0.05 \text{ cm} = (904.78)(0.05) \text{ cm}^3 = 45.24 \text{ cm}^3. \text{ For 5000 woks, we need} \\
 5000 \cdot V &= 5000 \cdot 45.24 \text{ cm}^3 = (5)(45.24) L = 226.2L \Rightarrow 226.2 \text{ liters of each color are needed.}
 \end{aligned}$$

$$\begin{aligned}
 28. \quad y &= \sqrt{r^2 - x^2} \Rightarrow \frac{dy}{dx} = -\frac{1}{2} \frac{2x}{\sqrt{r^2 - x^2}} = \frac{-x}{\sqrt{r^2 - x^2}} \Rightarrow \left(\frac{dx}{dy}\right)^2 = \frac{x^2}{r^2 - x^2}; \quad S = 2\pi \int_a^{a+h} \sqrt{r^2 - x^2} \sqrt{1 + \frac{x^2}{r^2 - x^2}} dx \\
 &= 2\pi \int_a^{a+h} \sqrt{(r^2 - x^2) + x^2} dx = 2\pi r \int_a^{a+h} dx = 2\pi rh, \text{ which is independent of } a.
 \end{aligned}$$

$$\begin{aligned}
 29. \quad y &= \sqrt{R^2 - x^2} \Rightarrow \frac{dy}{dx} = -\frac{1}{2} \frac{2x}{\sqrt{R^2 - x^2}} = \frac{-x}{\sqrt{R^2 - x^2}} \Rightarrow \left(\frac{dx}{dy}\right)^2 = \frac{x^2}{R^2 - x^2}; \quad S = 2\pi \int_a^{a+h} \sqrt{R^2 - x^2} \sqrt{1 + \frac{x^2}{R^2 - x^2}} dx \\
 &= 2\pi \int_a^{a+h} \sqrt{(R^2 - x^2) + x^2} dx = 2\pi R \int_a^{a+h} dx = 2\pi Rh
 \end{aligned}$$

30. (a) $x^2 + y^2 = 45^2 \Rightarrow x = \sqrt{45^2 - y^2} \Rightarrow \frac{dx}{dy} = \frac{-y}{\sqrt{45^2 - y^2}} \Rightarrow \left(\frac{dx}{dy}\right)^2 = \frac{y^2}{45^2 - y^2};$

$$S = \int_{-22.5}^{45} 2\pi\sqrt{45^2 - y^2} \sqrt{1 + \frac{y^2}{45^2 - y^2}} dy = 2\pi \int_{-22.5}^{45} \sqrt{(45^2 - y^2) + y^2} dy = 2\pi \cdot 45 \int_{-22.5}^{45} dy$$

$$= (2\pi)(45)(67.5) = 6075\pi \text{ square feet}$$

(b) 19,085 square feet

31. (a) An equation of the tangent line segment is (see figure) $y = f(m_k) + f'(m_k)(x - m_k)$. When

$x = x_{k-1}$ we have

$$r_1 = f(m_k) + f'(m_k)(x_{k-1} - m_k)$$

$$= f(m_k) + f'(m_k)\left(-\frac{\Delta x_k}{2}\right) = f(m_k) - f'(m_k) \frac{\Delta x_k}{2};$$

when $x = x_k$ we have

$$r_2 = f(m_k) + f'(m_k)(x_k - m_k)$$

$$= f(m_k) + f'(m_k) \frac{\Delta x_k}{2};$$

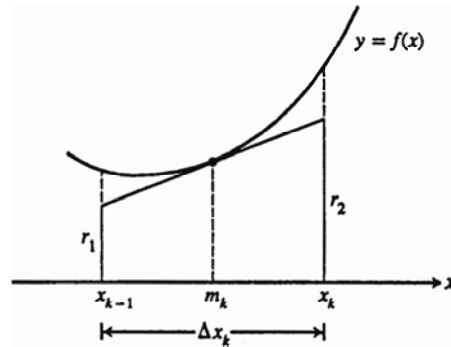

(b) $L_k^2 = (\Delta x_k)^2 + (r_2 - r_1)^2 = (\Delta x_k)^2 + \left[f'(m_k) \frac{\Delta x_k}{2} - \left(-f'(m_k) \frac{\Delta x_k}{2}\right) \right]^2 = (\Delta x_k)^2 + [f'(m_k) \Delta x_k]^2$

$$\Rightarrow L_k = \sqrt{(\Delta x_k)^2 + [f'(m_k) \Delta x_k]^2}, \text{ as claimed}$$

(c) From geometry it is a fact that the lateral surface area of the frustum obtained by revolving the tangent line segment about the x -axis is given by $\Delta S_k = \pi(r_1 + r_2)L_k = \pi[2f(m_k)]\sqrt{(\Delta x_k)^2 + [f'(m_k) \Delta x_k]^2}$ using parts (a) and (b) above. Thus, $\Delta S_k = 2\pi f(m_k)\sqrt{1 + [f'(m_k)]^2} \Delta x_k$.

(d) $S = \lim_{n \rightarrow \infty} \sum_{k=1}^n \Delta S_k = \lim_{n \rightarrow \infty} \sum_{k=1}^n 2\pi f(m_k)\sqrt{1 + [f'(m_k)]^2} \Delta x_k = \int_a^b 2\pi f(x)\sqrt{1 + [f'(x)]^2} dx$

32. $y = (1 - x^{2/3})^{3/2} \Rightarrow \frac{dy}{dx} = \frac{3}{2}(1 - x^{2/3})^{1/2} \left(-\frac{2}{3}x^{-1/3}\right) = -\frac{(1 - x^{2/3})^{1/2}}{x^{1/3}} \Rightarrow \left(\frac{dy}{dx}\right)^2 = \frac{1 - x^{2/3}}{x^{2/3}} = \frac{1}{x^{2/3}} - 1$

$$\Rightarrow S = 2 \int_0^1 2\pi (1 - x^{2/3})^{3/2} \sqrt{1 + \left(\frac{1}{x^{2/3}} - 1\right)} dx = 4\pi \int_0^1 (1 - x^{2/3})^{3/2} \sqrt{x^{-2/3}} dx = 4\pi \int_0^1 (1 - x^{2/3})^{3/2} x^{-1/3} dx;$$

$$[u = 1 - x^{2/3} \Rightarrow du = -\frac{2}{3}x^{-1/3} dx \Rightarrow -\frac{3}{2} du = x^{-1/3} dx; \quad x = 0 \Rightarrow u = 1, x = 1 \Rightarrow u = 0]$$

$$\rightarrow S = 4\pi \int_1^0 u^{3/2} \left(-\frac{3}{2} du\right) = -6\pi \left[\frac{2}{5} u^{5/2}\right]_1^0 = -6\pi \left(0 - \frac{2}{5}\right) = \frac{12\pi}{5}$$

6.5 WORK AND FLUID FORCES

1. The force required to stretch the spring from its natural length of 2 m to a length of 5 m is $F(x) = kx$.

The work done by F is $W = \int_0^3 F(x) dx = k \int_0^3 x dx = \frac{k}{2} [x^2]_0^3 = \frac{9k}{2}$. This work is equal to 1800 J

$$\Rightarrow \frac{9}{2}k = 1800 \Rightarrow k = 400 \text{ N/m}$$

2. (a) We find the force constant from Hooke's Law: $F = kx \Rightarrow k = \frac{F}{x} \Rightarrow k = \frac{800}{4} = 200$ lb/in.
- (b) The work done to stretch the spring 2 inches beyond its natural length is $W = \int_0^2 kx \, dx = 200 \int_0^2 x \, dx$
 $= 200 \left[\frac{x^2}{2} \right]_0^2 = 200(2 - 0) = 400$ in-lb = 33.3 ft-lb
- (c) We substitute $F = 1600$ into the equation $F = 200x$ to find $1600 = 200x \Rightarrow x = 8$ in.
3. We find the force constant from Hooke's law: $F = kx$. A force of 2 N stretches the spring to 0.02 m
 $\Rightarrow 2 = k \cdot (0.02) \Rightarrow k = 100 \frac{\text{N}}{\text{m}}$. The force of 4 N will stretch the rubber band y m, where $F = ky \Rightarrow y = \frac{F}{k}$
 $\Rightarrow y = \frac{4 \text{ N}}{100 \frac{\text{N}}{\text{m}}} \Rightarrow y = 0.04 \text{ m} = 4 \text{ cm}$. The work done to stretch the rubber band 0.04 m is $W = \int_0^{0.04} kx \, dx$
 $= 100 \int_0^{0.04} x \, dx = 100 \left[\frac{x^2}{2} \right]_0^{0.04} = \frac{(100)(0.04)^2}{2} = 0.08 \text{ J}$
4. We find the force constant from Hooke's law: $F = kx \Rightarrow k = \frac{F}{x} \Rightarrow k = \frac{90}{1} \Rightarrow k = 90 \frac{\text{N}}{\text{m}}$. The work done to stretch the spring 5 m beyond its natural length is $W = \int_0^5 kx \, dx = 90 \int_0^5 x \, dx = 90 \left[\frac{x^2}{2} \right]_0^5 = (90) \left(\frac{25}{2} \right) = 1125 \text{ J}$
5. (a) We find the spring's constant from Hooke's law: $F = kx \Rightarrow k = \frac{F}{x} = \frac{21,714}{8-5} = \frac{21,714}{3} \Rightarrow k = 7238 \frac{\text{lb}}{\text{in}}$
- (b) The work done to compress the assembly the first half inch is $W = \int_0^{0.5} kx \, dx = 7238 \int_0^{0.5} x \, dx$
 $= 7238 \left[\frac{x^2}{2} \right]_0^{0.5} = (7238) \frac{(0.5)^2}{2} = \frac{(7238)(0.25)}{2} \approx 905$ in-lb. The work done to compress the assembly the second half inch is:
 $W = \int_{0.5}^{1.0} kx \, dx = 7238 \int_{0.5}^{1.0} x \, dx = 7238 \left[\frac{x^2}{2} \right]_{0.5}^{1.0} = \frac{7238}{2} [1 - (0.5)^2] = \frac{(7238)(0.75)}{2} \approx 2714$ in-lb
6. First, we find the force constant from Hooke's law: $F = kx \Rightarrow k = \frac{F}{x} = \frac{150}{\left(\frac{1}{16}\right)} = 16 \cdot 150 = 2,400 \frac{\text{lb}}{\text{in}}$. If someone compresses the scale $x = \frac{1}{8}$ in, he/she must weigh $F = kx = 2,400 \left(\frac{1}{8}\right) = 300$ lb. The work done to compress the scale this far is $W = \int_0^{1/8} kx \, dx = 2400 \left[\frac{x^2}{2} \right]_0^{1/8} = \frac{2400}{2} \left(\frac{1}{64} \right) = 18.75 \text{ lb} \cdot \text{in.} = \frac{2.5}{16} \text{ ft-lb}$
7. The force required to haul up the rope is equal to the rope's weight, which varies steadily and is proportional to x , the length of the rope still hanging: $F(x) = 0.624x$. The work done is: $W = \int_0^{50} F(x) \, dx = \int_0^{50} 0.624x \, dx$
 $= 0.624 \left[\frac{x^2}{2} \right]_0^{50} = 780 \text{ J}$
8. The weight of sand decreases steadily by 72 lb over the 18 ft, at 4 lb/ft. So the weight of sand when the bag is x ft off the ground is $F(x) = 144 - 4x$. The work done is: $W = \int_a^b F(x) \, dx = \int_0^{18} (144 - 4x) \, dx$
 $= \left[144x - 2x^2 \right]_0^{18} = 1944 \text{ ft-lb}$

9. The force required to lift the cable is equal to the weight of the cable paid out: $F(x) = (4.5)(180 - x)$ where x is the position of the car off the first floor. The work done is: $W = \int_0^{180} F(x) dx = 4.5 \int_0^{180} (180 - x) dx = 4.5 \left[180x - \frac{x^2}{2} \right]_0^{180} = 4.5 \left(180^2 - \frac{180^2}{2} \right) = \frac{4.5 \cdot 180^2}{2} = 72,900 \text{ ft}\cdot\text{lb}$

10. Since the force is acting toward the origin, it acts opposite to the positive x -direction. Thus $F(x) = -\frac{k}{x^2}$.

The work done is $W = \int_a^b -\frac{k}{x^2} dx = k \int_a^b \frac{1}{x^2} dx = k \left[-\frac{1}{x} \right]_a^b = k \left(\frac{1}{b} - \frac{1}{a} \right) = \frac{k(a-b)}{ab}$

11. Let $r =$ the constant rate of leakage. Since the bucket is leaking at a constant rate and the bucket is rising at a constant rate, the amount of water in the bucket is proportional to $(20 - x)$, the distance the bucket is being raised. The leakage rate of the water is 0.8 lb/ft raised and the weight of the water in the bucket is

$F = 0.8(20 - x)$. So: $W = \int_0^{20} 0.8(20 - x) dx = 0.8 \left[20x - \frac{x^2}{2} \right]_0^{20} = 160 \text{ ft}\cdot\text{lb}$.

12. Let $r =$ the constant rate of leakage. Since the bucket is leaking at a constant rate and the bucket is rising at a constant rate, the amount of water in the bucket is proportional to $(20 - x)$, the distance the bucket is being raised. The leakage rate of the water is 2 lb/ft raised and the weight of the water in the bucket is $F = 2(20 - x)$.

So: $W = \int_0^{20} 2(20 - x) dx = 2 \left[20x - \frac{x^2}{2} \right]_0^{20} = 400 \text{ ft}\cdot\text{lb}$.

Note that since the force in Exercise 12 is 2.5 times the force in Exercise 11 at each elevation, the total work is also 2.5 times as great.

13. We will use the coordinate system given.

(a) The typical slab between the planes at y and $y + \Delta y$ has a volume of $\Delta V = (10)(12)\Delta y = 120\Delta y \text{ ft}^3$. The force F required to lift the slab is equal to its weight: $F = 62.4 \Delta V = 62.4 \cdot 120\Delta y \text{ lb}$. The distance through which F must act is about y ft, so the work done lifting the slab is about $\Delta W = \text{force} \times \text{distance} = 62.4 \cdot 120 \cdot y \cdot \Delta y \text{ ft}\cdot\text{lb}$. The work it takes to lift all the water is approximately

$$W \approx \sum_0^{20} \Delta W = \sum_0^{20} 62.4 \cdot 120y \cdot \Delta y \text{ ft}\cdot\text{lb}.$$

This is a Riemann sum for the function $62.4 \cdot 120y$ over the interval $0 \leq y \leq 20$. The work of pumping the tank empty is the limit of these sums:

$$W = \int_0^{20} 62.4 \cdot 120y dy = (62.4)(120) \left[\frac{y^2}{2} \right]_0^{20} = (62.4)(120) \left(\frac{400}{2} \right) = (62.4)(120)(200) = 1,497,600 \text{ ft}\cdot\text{lb}$$

(b) The time t it takes to empty the full tank with $\left(\frac{5}{11}\right)$ -hp motor is $t = \frac{W}{250 \frac{\text{ft}\cdot\text{lb}}{\text{sec}}} = \frac{1,497,600 \text{ ft}\cdot\text{lb}}{250 \frac{\text{ft}\cdot\text{lb}}{\text{sec}}} = 5990.4 \text{ sec} = 1.664 \text{ hr} \Rightarrow t \approx 1 \text{ hr and } 40 \text{ min}$

(c) Following all the steps of part (a), we find that the work it takes to lower the water level 10 ft is

$$W = \int_0^{10} 62.4 \cdot 120y dy = (62.4)(120) \left[\frac{y^2}{2} \right]_0^{10} = (62.4)(120) \left(\frac{100}{2} \right) = 374,400 \text{ ft}\cdot\text{lb} \text{ and the time is } t = \frac{W}{250 \frac{\text{ft}\cdot\text{lb}}{\text{sec}}} = 1497.6 \text{ sec} = 0.416 \text{ hr} \approx 25 \text{ min}$$

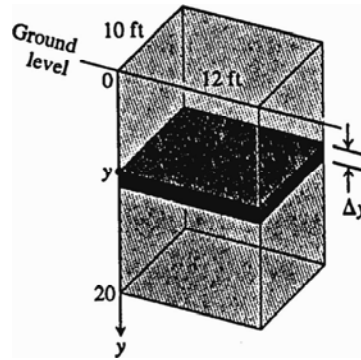

(d) In a location where water weighs $62.26 \frac{\text{lb}}{\text{ft}^3}$:

a) $W = (62.26)(24,000) = 1,494,240 \text{ ft}\cdot\text{lb}$.

b) $t = \frac{1,494,240}{250} = 5976.96 \text{ sec} \approx 1.660 \text{ hr} \Rightarrow t \approx 1 \text{ hr and } 40 \text{ min}$

In a location where water weighs $62.59 \frac{\text{lb}}{\text{ft}^3}$:

a) $W = (62.59)(24,000) = 1,502,160 \text{ ft}\cdot\text{lb}$

b) $t = \frac{1,502,160}{250} = 6008.64 \text{ sec} \approx 1.669 \text{ hr} \Rightarrow t \approx 1 \text{ hr and } 40.1 \text{ min}$

14. We will use the coordinate system given.

- (a) The typical slab between the planes at y and $y + \Delta y$ has a volume of $\Delta V = (20)(12) \Delta y = 240\Delta y \text{ ft}^3$. The force F required to lift the slab is equal to its weight:
 $F = 62.4\Delta V = 62.4 \cdot 240\Delta y \text{ lb}$. The distance through which F must act is about $y \text{ ft}$, so the work done lifting the slab is about $\Delta W = \text{force} \times \text{distance}$

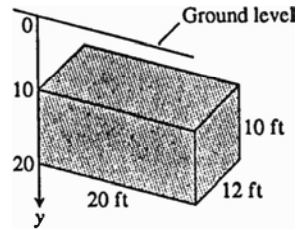

$= 62.4 \cdot 240 \cdot y \cdot \Delta y \text{ ft}\cdot\text{lb}$. The work it takes to lift all the water is approximately $W \approx \sum_{10}^{20} \Delta W$

$= \sum_{10}^{20} 62.4 \cdot 240 y \cdot \Delta y \text{ ft}\cdot\text{lb}$. This is a Riemann sum for the function $62.4 \cdot 240 y$ over the interval

$10 \leq y \leq 20$. The work it takes to empty the cistern is the limit of these sums:

$$W = \int_{10}^{20} 62.4 \cdot 240 y \, dy = (62.4)(240) \left[\frac{y^2}{2} \right]_{10}^{20} = (62.4)(240)(200 - 50) = (62.4)(240)(150) = 2,246,400 \text{ ft}\cdot\text{lb}$$

(b) $t = \frac{W}{275 \frac{\text{ft}\cdot\text{lb}}{\text{sec}}} = \frac{2,246,400 \text{ ft}\cdot\text{lb}}{275} \approx 8168.73 \text{ sec} \approx 2.27 \text{ hours} \approx 2 \text{ hr and } 16.1 \text{ min}$

- (c) Following all the steps of part (a), we find that the work it takes to empty the tank halfway is

$$W = \int_{10}^{15} 62.4 \cdot 240 y \, dy = (62.4)(240) \left[\frac{y^2}{2} \right]_{10}^{15} = (62.4)(240) \left(\frac{225}{2} - \frac{100}{2} \right) = (62.4)(240) \left(\frac{125}{2} \right) = 936,000 \text{ ft}\cdot\text{lb}$$

Then the time is $t = \frac{W}{275 \frac{\text{ft}\cdot\text{lb}}{\text{sec}}} = \frac{936,000}{275} \approx 3403.64 \text{ sec} \approx 56.7 \text{ min}$

(d) In a location where water weighs $62.26 \frac{\text{lb}}{\text{ft}^3}$:

a) $W = (62.26)(240)(150) = 2,241,360 \text{ ft}\cdot\text{lb}$.

b) $t = \frac{2,241,360}{275} = 8150.40 \text{ sec} = 2.264 \text{ hours} \approx 2 \text{ hr and } 15.8 \text{ min}$

c) $W = (62.26)(240) \left(\frac{125}{2} \right) = 933,900 \text{ ft}\cdot\text{lb}$; $t = \frac{933,900}{275} = 3396 \text{ sec} \approx 0.94 \text{ hours} \approx 56.6 \text{ min}$

In a location where water weighs $62.59 \frac{\text{lb}}{\text{ft}^3}$:

a) $W = (62.59)(240)(150) = 2,253,240 \text{ ft}\cdot\text{lb}$.

b) $t = \frac{2,253,240}{275} = 8193.60 \text{ sec} = 2.276 \text{ hours} \approx 2 \text{ hr and } 16.56 \text{ min}$

c) $W = (62.59)(240) \left(\frac{125}{2} \right) = 938,850 \text{ ft}\cdot\text{lb}$; $t = \frac{938,850}{275} \approx 3414 \text{ sec} \approx 0.95 \text{ hours} \approx 56.9 \text{ min}$

15. The slab is a disk of area $\pi x^2 = \pi \left(\frac{y}{2}\right)^2$, thickness Δy , and height below the top of the tank $(10 - y)$. So the work to pump the oil in this slab, ΔW , is $57(10 - y)\pi \left(\frac{y}{2}\right)^2$. The work to pump all the oil to top of the tank is

$$W = \int_0^{10} \frac{57\pi}{4} (10y^2 - y^3) dy = \frac{57\pi}{4} \left[\frac{10y^3}{3} - \frac{y^4}{4} \right]_0^{10} = 11,875\pi \text{ ft} \cdot \text{lb} \approx 37,306 \text{ ft} \cdot \text{lb}$$

16. Each slab of oil is to be pumped to a height of 14 ft. So the work to pump a slab is $(14 - y)(\pi) \left(\frac{y}{2}\right)^2$ and since the tank is half full and the volume of the original cone is $V = \frac{1}{3}\pi r^2 h = \frac{1}{3}\pi(5^2)(10) = \frac{250\pi}{3} \text{ ft}^3$, half the volume $= \frac{250\pi}{6} \text{ ft}^3$, and with half the volume the cone is filled to a height y , $\frac{250\pi}{6} = \frac{1}{3}\pi \frac{y^2}{4} y \Rightarrow y = \sqrt[3]{500}$ ft.

$$\text{So } W = \int_0^{\sqrt[3]{500}} \frac{57\pi}{4} (14y^2 - y^3) dy = \frac{57\pi}{4} \left[\frac{14y^3}{3} - \frac{y^4}{4} \right]_0^{\sqrt[3]{500}} \approx 60,042 \text{ ft} \cdot \text{lb}.$$

17. The typical slab between the planes at y and $y + \Delta y$ has a volume of $\Delta V = \pi(\text{radius})^2(\text{thickness}) = \pi \left(\frac{20}{2}\right)^2 \Delta y = \pi \cdot 100 \Delta y \text{ ft}^3$. The force F required to lift the slab is equal to its weight:

$$F = 51.2\Delta V = 51.2 \cdot 100\pi \Delta y \text{ lb} \Rightarrow F = 5120\pi \Delta y \text{ lb} \text{ The distance through which } F \text{ must act is about}$$

$$(30 - y) \text{ ft. The work it takes to lift all the kerosene is approximately } W \approx \sum_0^{30} \Delta W = \sum_0^{30} 5120\pi(30 - y)\Delta y \text{ ft} \cdot \text{lb}$$

which is a Riemann sum. The work to pump the tank dry is the limit of these sums:

$$W = \int_0^{30} 5120\pi(30 - y) dy = 5120\pi \left[30y - \frac{y^2}{2} \right]_0^{30} = 5120\pi \left(\frac{900}{2} \right) = (5120)(450\pi) \approx 7,238,229.48 \text{ ft} \cdot \text{lb}$$

18. (a) Follow all the steps of Example 5 but make the substitution of $64.5 \frac{\text{lb}}{\text{ft}^3}$ for $57 \frac{\text{lb}}{\text{ft}^3}$. Then,

$$\begin{aligned} W &= \int_0^8 \frac{64.5\pi}{4} (10 - y)y^2 dy = \frac{64.5\pi}{4} \left[\frac{10y^3}{3} - \frac{y^4}{4} \right]_0^8 = \frac{64.5\pi}{4} \left(\frac{10 \cdot 8^3}{3} - \frac{8^4}{4} \right) = \left(\frac{64.5\pi}{4} \right) (8^3) \left(\frac{10}{3} - 2 \right) = \frac{64.5\pi \cdot 8^3}{3} \\ &= 21.5\pi \cdot 8^3 \approx 34,582.65 \text{ ft} \cdot \text{lb} \end{aligned}$$

- (b) Exactly as done in Example 5 but change the distance through which F acts to distance $\approx (13 - y)$ ft.

$$\begin{aligned} \text{Then } W &= \int_0^8 \frac{57\pi}{4} (13 - y)y^2 dy = \frac{57\pi}{4} \left[\frac{13y^3}{3} - \frac{y^4}{4} \right]_0^8 = \frac{57\pi}{4} \left(\frac{13 \cdot 8^3}{3} - \frac{8^4}{4} \right) = \left(\frac{57\pi}{4} \right) (8^3) \left(\frac{13}{3} - 2 \right) = \frac{57\pi \cdot 8^3 \cdot 7}{3 \cdot 4} \\ &= (19\pi)(8^2)(7)(2) \approx 53,482.5 \text{ ft} \cdot \text{lb} \end{aligned}$$

19. The typical slab between the planes at y and $y + \Delta y$ has a volume of about $\Delta V = \pi(\text{radius})^2(\text{thickness}) = \pi(\sqrt{y})^2 \Delta y \text{ ft}^3$. The force $F(y)$ required to lift this slab is equal to its weight: $F(y) = 73 \cdot \Delta V$

$= 73\pi(\sqrt{y})^2 \Delta y = 73\pi y \Delta y \text{ lb}$. The distance through which $F(y)$ must act to lift the slab to the top of the reservoir is about $(4 - y)$ ft, so the work done is approximately $\Delta W \approx 73\pi y(4 - y)\Delta y \text{ ft} \cdot \text{lb}$. The work done

lifting all the slabs from $y = 0$ ft to $y = 4$ ft is approximately $W \approx \sum_{k=0}^n 73\pi y_k(4 - y_k)\Delta y \text{ ft} \cdot \text{lb}$. Taking the limit

of these Riemann sums as $n \rightarrow \infty$, we get $W = \int_0^4 73\pi y(4-y) dy = 73\pi \int_0^4 (4y - y^2) dy$
 $= 73\pi \left[2y^2 - \frac{1}{3}y^3 \right]_0^4 = 73\pi \left(32 - \frac{64}{3} \right) = \frac{2336\pi}{3} \text{ ft}\cdot\text{lb} \approx 2446.25 \text{ ft}\cdot\text{lb}.$

20. The typical slab between the planes at y and $y + \Delta y$ has volume of about $\Delta V = (\text{length})(\text{width})(\text{thickness})$
 $= \left(2\sqrt{25-y^2} \right) (10)\Delta y \text{ ft}^3$. The force $F(y)$ required to lift this slab is equal to its weight:

$F(y) = 53 \cdot \Delta V = 53 \left(2\sqrt{25-y^2} \right) (10) \Delta y = 1060\sqrt{25-y^2} \Delta y \text{ lb}$. The distance through which $F(y)$ must act to lift the slab to the level of 15 m above the top of the reservoir is about $(20-y)$ ft, so the work done is approximately $\Delta W \approx 1060\sqrt{25-y^2} (20-y)\Delta y \text{ ft}\cdot\text{lb}$. The work done lifting all the slabs from $y = -5$ ft to

$y = 5$ ft is approximately $W \approx \sum_{k=0}^n 1060\sqrt{25-y_k^2} (20-y_k) \Delta y \text{ ft}\cdot\text{lb}$. Taking the limit of these Riemann sums as

$n \rightarrow \infty$, we get $W = \int_{-5}^5 1060\sqrt{25-y^2} (20-y) dy = 1060 \int_{-5}^5 (20-y) \sqrt{25-y^2} dy$

$= 1060 \left[\int_{-5}^5 20\sqrt{25-y^2} dy - \int_{-5}^5 y\sqrt{25-y^2} dy \right]$. To evaluate the first integral, we use we can interpret

$\int_{-5}^5 \sqrt{25-y^2} dy$ as the area of the semicircle whose radius is 5, thus $\int_{-5}^5 20\sqrt{25-y^2} dy = 20 \int_{-5}^5 \sqrt{25-y^2} dy$

$= 20 \left[\frac{1}{2} \pi (5)^2 \right] = 250\pi$. To evaluate the second integral let $u = 25 - y^2 \Rightarrow du = -2y dy$; $y = -5 \Rightarrow u = 0$,

$y = 5 \Rightarrow u = 0$, thus $\int_{-5}^5 y\sqrt{25-y^2} dy = -\frac{1}{2} \int_0^0 \sqrt{u} du = 0$. Thus, $1060 \left[\int_{-5}^5 20\sqrt{25-y^2} dy -$

$\int_{-5}^5 y\sqrt{25-y^2} dy \right] = 1060(250\pi - 0) = 265000\pi \approx 832522 \text{ ft}\cdot\text{lb}$

21. The typical slab between the planes at y and $y + \Delta y$ has a volume of about $\Delta V = \pi (\text{radius})^2 (\text{thickness})$
 $= \pi \left(\sqrt{25-y^2} \right)^2 \Delta y \text{ m}^3$. The force $F(y)$ required to lift this slab is equal to its weight:

$F(y) = 9800 \cdot \Delta V = 9800\pi \left(\sqrt{25-y^2} \right)^2 \Delta y = 9800\pi (25-y^2) \Delta y \text{ N}$. The distance through which $F(y)$ must act to lift the slab to the level of 4 m above the top of the reservoir is about $(4-y)$ m, so the work done is approximately $\Delta W \approx 9800\pi (25-y^2) (4-y) \Delta y \text{ N}\cdot\text{m}$. The work done lifting all the slabs from $y = -5$ m to

$y = 0$ m is approximately $W \approx \sum_{-5}^0 9800\pi (25-y^2) (4-y) \Delta y \text{ N}\cdot\text{m}$. Taking the limit of these Riemann sums,

we get $W = \int_{-5}^0 9800\pi (25-y^2) (4-y) dy = 9800\pi \int_{-5}^0 (100 - 25y - 4y^2 + y^3) dy$

$= 9800\pi \left[100y - \frac{25}{2}y^2 - \frac{4}{3}y^3 + \frac{y^4}{4} \right]_{-5}^0 = -9800\pi \left(-500 - \frac{25 \cdot 25}{2} + \frac{4}{3} \cdot 125 + \frac{625}{4} \right) \approx 15,073,099.75 \text{ J}$

22. The typical slab between the planes at y and $y + \Delta y$ has a volume of about $\Delta V = \pi (\text{radius})^2 (\text{thickness})$
 $= \pi \left(\sqrt{100-y^2} \right)^2 \Delta y = \pi (100-y^2) \Delta y \text{ ft}^3$. The force is $F(y) = \frac{56 \text{ lb}}{\text{ft}^3} \cdot \Delta V = 56\pi (100-y^2) \Delta y \text{ lb}$. The

distance through which $F(y)$ must act to lift the slab to the level of 2 ft above the top of the tank is about $(12 - y)$ ft, so the work done is $\Delta W \approx 56\pi(100 - y^2)(12 - y)\Delta y$ lb·ft. The work done lifting all the slabs from $y = 0$ ft to $y = 10$ ft is approximately $W \approx \sum_0^{10} 56\pi(100 - y^2)(12 - y)\Delta y$ lb·ft. Taking the limit of these Riemann sums, we get $W = \int_0^{10} 56\pi(100 - y^2)(12 - y) dy = 56\pi \int_0^{10} (100 - y^2)(12 - y) dy$

$$= 56\pi \int_0^{10} (1200 - 100y - 12y^2 + y^3) dy = 56\pi \left[1200y - \frac{100y^2}{2} - \frac{12y^3}{3} + \frac{y^4}{4} \right]_0^{10}$$

$$= 56\pi \left(12,000 - \frac{10,000}{2} - 4 \cdot 1000 + \frac{10,000}{4} \right) = (56\pi) \left(12 - 5 - 4 + \frac{5}{2} \right) (1000) \approx 967,611 \text{ ft}\cdot\text{lb.}$$

It would cost $(0.5)(967,611) = 483,805\text{¢} = \4838.05 . Yes, you can afford to hire the firm.

23. $F = m \frac{dv}{dt} = mv \frac{dv}{dx}$ by the chain rule $\Rightarrow W = \int_{x_1}^{x_2} mv \frac{dv}{dx} dx = m \int_{x_1}^{x_2} \left(v \frac{dv}{dx} \right) dx = m \left[\frac{1}{2} v^2(x) \right]_{x_1}^{x_2}$

$$= \frac{1}{2} m \left[v^2(x_2) - v^2(x_1) \right] = \frac{1}{2} m v_2^2 - \frac{1}{2} m v_1^2, \text{ as claimed.}$$

24. weight = 2 oz = $\frac{2}{16}$ lb; mass = $\frac{\text{weight}}{32} = \frac{\frac{1}{8}}{32} = \frac{1}{256}$ slugs; $W = \left(\frac{1}{2}\right) \left(\frac{1}{256} \text{ slugs}\right) (160 \text{ ft/sec})^2 \approx 50 \text{ ft}\cdot\text{lb}$

25. $90 \text{ mph} = \frac{90 \text{ mi}}{1 \text{ hr}} \cdot \frac{1 \text{ hr}}{60 \text{ min}} \cdot \frac{1 \text{ min}}{60 \text{ sec}} \cdot \frac{5280 \text{ ft}}{1 \text{ mi}} = 132 \text{ ft/sec}$; $m = \frac{0.3125 \text{ lb}}{32 \text{ ft/sec}^2} = \frac{0.3125}{32}$ slugs;

$$W = \left(\frac{1}{2}\right) \left(\frac{0.3125 \text{ lb}}{32 \text{ ft/sec}^2}\right) (132 \text{ ft/sec})^2 \approx 85.1 \text{ ft}\cdot\text{lb}$$

26. weight = 1.6 oz = 0.1 lb $\Rightarrow m = \frac{0.1 \text{ lb}}{32 \text{ ft/sec}^2} = \frac{1}{320}$ slugs; $W = \left(\frac{1}{2}\right) \left(\frac{1}{320} \text{ slugs}\right) (280 \text{ ft/sec})^2 = 122.5 \text{ ft}\cdot\text{lb}$

27. $v_1 = 0 \text{ mph} = 0 \frac{\text{ft}}{\text{sec}}$, $v_2 = 153 \text{ mph} = 224.4 \frac{\text{ft}}{\text{sec}}$; $2 \text{ oz} = 0.125 \text{ lb} \Rightarrow m = \frac{0.125 \text{ lb}}{32 \text{ ft/sec}^2} = \frac{1}{256}$ slugs;

$$W = \int_{x_1}^{x_2} F(x) dx = \frac{1}{2} m v_2^2 - \frac{1}{2} m v_1^2 = \frac{1}{2} \left(\frac{1}{256}\right) (224.4)^2 - \frac{1}{2} \left(\frac{1}{256}\right) (0)^2 = 98.35 \text{ ft}\cdot\text{lb}$$

28. weight = 6.5 oz = $\frac{6.5}{16}$ lb $\Rightarrow m = \frac{6.5}{(16)(32)}$ slugs; $W = \left(\frac{1}{2}\right) \left(\frac{6.5}{(16)(32)} \text{ slugs}\right) (132 \text{ ft/sec})^2 \approx 110.6 \text{ ft}\cdot\text{lb}$

29. We imagine the milkshake divided into thin slabs by planes perpendicular to the y -axis at the points of a partition of the interval $[0, 7]$. The typical slab between the planes at y and $y + \Delta y$ has a volume of about $\Delta V = \pi(\text{radius})^2(\text{thickness}) = \pi \left(\frac{y+17.5}{14}\right)^2 \Delta y$ in³. The force $F(y)$ required to lift this slab is equal to its weight: $F(y) = \frac{4}{9} \Delta V = \frac{4\pi}{9} \left(\frac{y+17.5}{14}\right)^2 \Delta y$ oz. The distance through which $F(y)$ must act to lift this slab to the level of 1 inch above the top is about $(8 - y)$ in. The work done lifting the slab is about $\Delta W = \left(\frac{4\pi}{9}\right) \frac{(y+17.5)^2}{14^2} (8 - y) \Delta y$ in·oz. The work done lifting all the slabs from $y = 0$ to $y = 7$ is approximately

$W = \sum_0^7 \frac{4\pi}{9.14^2} (y + 17.5)^2 (8 - y) \Delta y$ in · oz which is a Riemann sum. The work is the limit of these sums as the norm of the partition goes to zero:

$$W = \int_0^7 \frac{4\pi}{9.14^2} (y + 17.5)^2 (8 - y) dy = \frac{4\pi}{9.14^2} \int_0^7 (2450 - 26.25y - 27y^2 - y^3) dy$$

$$= \frac{4\pi}{9.14^2} \left[-\frac{y^4}{4} - 9y^3 - \frac{26.25}{2} y^2 + 2450y \right]_0^7 = \frac{4\pi}{9.14^2} \left[-\frac{7^4}{4} - 9 \cdot 7^3 - \frac{26.25}{2} \cdot 7^2 + 2450 \cdot 7 \right] \approx 91.32 \text{ in} \cdot \text{oz}$$

30. We fill the pipe and the tank. To find the work required to fill the tank note that radius = 10 ft, then $\Delta V = \pi \cdot 100 \Delta y \text{ ft}^3$. The force required will be $F = 62.4 \cdot \Delta V = 62.4 \cdot 100\pi \Delta y = 6240\pi \Delta y \text{ lb}$. The distance through which F must act is y so the work done lifting the slab is about $\Delta W_1 = 6240\pi \cdot y \cdot \Delta y \text{ lb} \cdot \text{ft}$. The work it

takes to lift all the water into the tank is: $W_1 \approx \sum_{360}^{385} \Delta W_1 = \sum_{360}^{385} 6240\pi \cdot y \cdot \Delta y \text{ lb} \cdot \text{ft}$. Taking the limit we end up

$$\text{with } W_1 = \int_{360}^{385} 6240\pi y dy = 6240\pi \left[\frac{y^2}{2} \right]_{360}^{385} = \frac{6240\pi}{2} [385^2 - 360^2] \approx 182,557,949 \text{ ft} \cdot \text{lb}$$

To find the work required to fill the pipe, do as above, but take the radius to be $\frac{4}{2} \text{ in} = \frac{1}{6} \text{ ft}$. Then

$\Delta V = \pi \cdot \frac{1}{36} \Delta y \text{ ft}^3$ and $F = 62.4 \cdot \Delta V = \frac{62.4\pi}{36} \Delta y$. Also take different limits of summation and integration:

$$W_2 \approx \sum_0^{360} \Delta W_2 \Rightarrow W_2 = \int_0^{360} \frac{62.4}{36} \pi y dy = \frac{62.4\pi}{36} \left[\frac{y^2}{2} \right]_0^{360} = \left(\frac{62.4\pi}{36} \right) \left(\frac{360^2}{2} \right) \approx 352,864 \text{ ft} \cdot \text{lb}$$

The total work is $W = W_1 + W_2 \approx 182,557,949 + 352,864 \approx 182,910,813 \text{ ft} \cdot \text{lb}$. The time it takes to fill the tank

and the pipe is $\text{Time} = \frac{W}{1650} \approx \frac{182,910,813}{1650} \approx 110,855 \text{ sec} \approx 31 \text{ hr}$

31. $\text{Work} = \int_{6,370,000}^{35,780,000} \frac{1000 \text{ MG}}{r^2} dr = 1000 \text{ MG} \int_{6,370,000}^{35,780,000} \frac{dr}{r^2} = 1000 \text{ MG} \left[-\frac{1}{r} \right]_{6,370,000}^{35,780,000}$
 $= (1000) \left(5.975 \times 10^{24} \right) \left(6.672 \times 10^{-11} \right) \left(\frac{1}{6,370,000} - \frac{1}{35,780,000} \right) \approx 5.144 \times 10^{10} \text{ J}$

32. (a) Let ρ be the x -coordinate of the second electron. Then $r^2 = (\rho - 1)^2$

$$\Rightarrow W = \int_{-1}^0 F(\rho) d\rho = \int_{-1}^0 \frac{(23 \times 10^{-29})}{(\rho - 1)^2} d\rho = - \left[\frac{23 \times 10^{-29}}{\rho - 1} \right]_{-1}^0 = (23 \times 10^{-29}) \left(1 - \frac{1}{2} \right) = 11.5 \times 10^{-29}$$

- (b) $W = W_1 + W_2$ where W_1 is the work done against the field of the first electron and W_2 is the work done against the field of the second electron. Let ρ be the x -coordinate of the third electron. Then $r_1^2 = (\rho - 1)^2$ and $r_2^2 = (\rho + 1)^2$

$$\Rightarrow W_1 = \int_3^5 \frac{23 \times 10^{-29}}{r_1^2} d\rho = \int_3^5 \frac{23 \times 10^{-29}}{(\rho - 1)^2} d\rho = -23 \times 10^{-29} \left[\frac{1}{\rho - 1} \right]_3^5 = (-23 \times 10^{-29}) \left(\frac{1}{4} - \frac{1}{2} \right) = \frac{23}{4} \times 10^{-29}, \text{ and}$$

$$W_2 = \int_3^5 \frac{23 \times 10^{-29}}{r_2^2} d\rho = \int_3^5 \frac{23 \times 10^{-29}}{(\rho + 1)^2} d\rho = -23 \times 10^{-29} \left[\frac{1}{\rho + 1} \right]_3^5 = (-23 \times 10^{-29}) \left(\frac{1}{6} - \frac{1}{4} \right) = \frac{23 \times 10^{-29}}{12} (3 - 2)$$

$$= \frac{23}{12} \times 10^{-29}.$$

$$\text{Therefore } W = W_1 + W_2 = \left(\frac{23}{4} \times 10^{-29} \right) + \left(\frac{23}{12} \times 10^{-29} \right) = \frac{23}{3} \times 10^{-29} \approx 7.67 \times 10^{-29} \text{ J}$$

33. To find the width of the plate at a typical depth y , we first find an equation for the line of the plate's right-hand edge: $y = x - 5$. If we let x denote the width of the right-hand half of the triangle at depth y , then $x = 5 + y$ and the total width is $L(y) = 2x = 2(5 + y)$. The depth of the strip is $(-y)$. The force exerted by the water against

$$\begin{aligned} \text{one side of the plate is therefore } F &= \int_{-5}^{-2} w(-y) \cdot L(y) \, dy = \int_{-5}^{-2} 62.4 \cdot (-y) \cdot 2(5 + y) \, dy \\ &= 124.8 \int_{-5}^{-2} (-5y - y^2) \, dy = 124.8 \left[-\frac{5}{2}y^2 - \frac{1}{3}y^3 \right]_{-5}^{-2} = 124.8 \left[\left(-\frac{5}{2} \cdot 4 + \frac{1}{3} \cdot 8 \right) - \left(-\frac{5}{2} \cdot 25 + \frac{1}{3} \cdot 125 \right) \right] \\ &= (124.8) \left(\frac{105}{2} - \frac{117}{3} \right) = (124.8) \left(\frac{315 - 234}{6} \right) = 1684.8 \text{ lb} \end{aligned}$$

34. An equation for the line of the plate's right-hand edge is $y = x - 3 \Rightarrow x = y + 3$. Thus the total width is $L(y) = 2x = 2(y + 3)$. The depth of the strip is $(2 - y)$. The force exerted by the water is

$$\begin{aligned} F &= \int_{-3}^0 w(2 - y)L(y) \, dy = \int_{-3}^0 62.4 \cdot (2 - y) \cdot 2(3 + y) \, dy = 124.8 \int_{-3}^0 (6 - y - y^2) \, dy = 124.8 \left[6y - \frac{y^2}{2} - \frac{y^3}{3} \right]_{-3}^0 \\ &= (-124.8) \left(-18 - \frac{9}{2} + 9 \right) = (-124.8) \left(-\frac{27}{2} \right) = 1684.8 \text{ lb} \end{aligned}$$

35. (a) The width of the strip is $L(y) = 4$, the depth of the strip is $(10 - y) \Rightarrow F = \int_a^b w \cdot \left(\frac{\text{strip}}{\text{depth}} \right) F(y) \, dy$

$$= \int_0^3 62.4(10 - y)(4) \, dy = 249.6 \int_0^3 (10 - y) \, dy = 249.6 \left[10y - \frac{y^2}{2} \right]_0^3 = 249.6 \left(30 - \frac{9}{2} \right) = 6364.8 \text{ lb}$$

- (b) The width of the strip is $L(y) = 3$, the depth of the strip is $(10 - y) \Rightarrow F = \int_a^b w \cdot \left(\frac{\text{strip}}{\text{depth}} \right) F(y) \, dy$

$$= \int_0^4 62.4(10 - y)(3) \, dy = 187.2 \int_0^4 (10 - y) \, dy = 187.2 \left[10y - \frac{y^2}{2} \right]_0^4 = 187.2(40 - 8) = 5990.4 \text{ lb}$$

36. The width of the strip is $L(y) = 2\sqrt{25 - y^2}$, the depth of the strip is $(6 - y) \Rightarrow F = \int_a^b w \cdot \left(\frac{\text{strip}}{\text{depth}} \right) F(y) \, dy$

$$= \int_0^5 62.4(6 - y) \left(2\sqrt{25 - y^2} \right) \, dy = 124.8 \int_0^5 (6 - y)\sqrt{25 - y^2} \, dy = 124.8 \left[\int_0^5 6\sqrt{25 - y^2} \, dy - \int_0^5 y\sqrt{25 - y^2} \, dy \right]$$

To evaluate the first integral, we use we can interpret $\int_0^5 \sqrt{25 - y^2} \, dy$ as the area of a quarter circle whose radius is 5, thus $\int_0^5 6\sqrt{25 - y^2} \, dy = 6 \int_0^5 \sqrt{25 - y^2} \, dy = 6 \left[\frac{1}{4}\pi(5)^2 \right] = \frac{75\pi}{2}$. To evaluate the second integral let

$$\begin{aligned} u &= 25 - y^2 \Rightarrow du = -2y \, dy; \quad y = 0 \Rightarrow u = 25, \quad y = 5 \Rightarrow u = 0, \quad \text{thus } \int_0^5 y\sqrt{25 - y^2} \, dy = -\frac{1}{2} \int_{25}^0 \sqrt{u} \, du \\ &= \frac{1}{2} \int_0^{25} u^{1/2} \, du = \frac{1}{3} \left[u^{3/2} \right]_0^{25} = \frac{125}{3}. \quad \text{Thus, } 124.8 \left[\int_0^5 6\sqrt{25 - y^2} \, dy - \int_0^5 y\sqrt{25 - y^2} \, dy \right] = 124.8 \left(\frac{75\pi}{2} - \frac{125}{3} \right) \\ &\approx 9502.7 \text{ lb.} \end{aligned}$$

37. Using the coordinate system of Exercise 32, we find the equation for the line of the plate's right-hand edge to be $y = 2x - 4 \Rightarrow x = \frac{y+4}{2}$ and $L(y) = 2x = y + 4$. The depth of the strip is $(1 - y)$.

$$\begin{aligned} \text{(a) } F &= \int_{-4}^0 w(1 - y)L(y) \, dy = \int_{-4}^0 62.4 \cdot (1 - y)(y + 4) \, dy = 62.4 \int_{-4}^0 (4 - 3y - y^2) \, dy = 62.4 \left[4y - \frac{3y^2}{2} - \frac{y^3}{3} \right]_{-4}^0 \\ &= (-62.4) \left[(-4)(4) - \frac{(3)(16)}{2} + \frac{64}{3} \right] = (-62.4) \left(-16 - 24 + \frac{64}{3} \right) = \frac{(-62.4)(-120 + 64)}{3} = 1164.8 \text{ lb} \end{aligned}$$

$$\text{(b) } F = (-64.0) \left[(-4)(4) - \frac{(3)(16)}{2} + \frac{64}{3} \right] = \frac{(-64.0)(-120 + 64)}{3} \approx 1194.7 \text{ lb}$$

38. Using the coordinate system given, we find an equation for the line of the plate's right-hand edge to be $y = -2x + 4 \Rightarrow x = \frac{4-y}{2}$ and $L(y) = 2x = 4 - y$. The depth of the strip is $(1 - y)$

$$\begin{aligned} \Rightarrow F &= \int_0^1 w(1-y)(4-y) dy = 62.4 \int_0^1 (y^2 - 5y + 4) dy \\ &= 62.4 \left[\frac{y^3}{3} - \frac{5y^2}{2} + 4y \right]_0^1 = (62.4) \left(\frac{1}{3} - \frac{5}{2} + 4 \right) = (62.4) \left(\frac{2-15+24}{6} \right) \\ &= \frac{(62.4)(11)}{6} = 114.4 \text{ lb} \end{aligned}$$

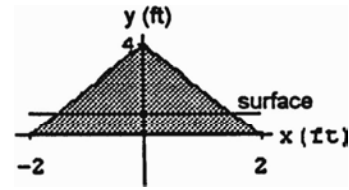

39. Using the coordinate system given in the accompanying figure, we see that the total width is $L(y) = 63$ and the depth of the strip

$$\begin{aligned} \text{is } (33.5 - y) \Rightarrow F &= \int_0^{33} w(33.5 - y)L(y) dy \\ &= \int_0^{33} \frac{64}{12^3} \cdot (33.5 - y) \cdot 63 dy = \left(\frac{64}{12^3} \right) (63) \int_0^{33} (33.5 - y) dy \\ &= \left(\frac{64}{12^3} \right) (63) \left[33.5y - \frac{y^2}{2} \right]_0^{33} = \left(\frac{64 \cdot 63}{12^3} \right) \left[(33.5)(33) - \frac{33^2}{2} \right] \\ &= \frac{(64)(63)(33)(67-33)}{(2)(12^3)} = 1309 \text{ lb} \end{aligned}$$

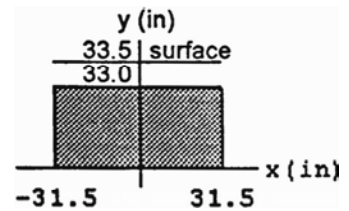

40. Using the coordinate system given in the accompanying figure, we see that the right-hand edge is $x = \sqrt{1 - y^2}$ so the total width is $L(y) = 2x = 2\sqrt{1 - y^2}$ and the depth of the strip is $(-y)$. The force exerted by the water is therefore

$$\begin{aligned} F &= \int_{-1}^0 w \cdot (-y) \cdot 2\sqrt{1 - y^2} dy \\ &= 62.4 \int_{-1}^0 \sqrt{1 - y^2} (-2y) dy = 62.4 \left[\frac{2}{3} (1 - y^2)^{3/2} \right]_{-1}^0 \\ &= (62.4) \left(\frac{2}{3} \right) (1 - 0) = 41.6 \text{ lb} \end{aligned}$$

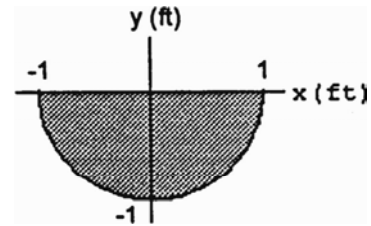

41. (a) $F = \left(62.4 \frac{\text{lb}}{\text{ft}^3} \right) (8 \text{ ft}) (25 \text{ ft}^2) = 12480 \text{ lb}$

(b) The width of the strip is $L(y) = 5$, the depth of the strip is $(8 - y) \Rightarrow F = \int_a^b w \cdot \left(\frac{\text{strip}}{\text{depth}} \right) F(y) dy$

$$= \int_0^5 62.4(8 - y)(5) dy = 312 \int_0^5 (8 - y) dy = 312 \left[8y - \frac{y^2}{2} \right]_0^5 = 312 \left(40 - \frac{25}{2} \right) = 8580 \text{ lb}$$

(c) The width of the strip is $L(y) = 5$, the depth of the strip is $(8 - y)$, the height of the strip is $\sqrt{2} dy$

$$\begin{aligned} \Rightarrow F &= \int_a^b w \cdot \left(\frac{\text{strip}}{\text{depth}} \right) F(y) dy = \int_0^{5/\sqrt{2}} 62.4(8 - y)(5)\sqrt{2} dy = 312\sqrt{2} \int_0^{5/\sqrt{2}} (8 - y) dy \\ &= 312\sqrt{2} \left[8y - \frac{y^2}{2} \right]_0^{5/\sqrt{2}} = 312\sqrt{2} \left(\frac{40}{\sqrt{2}} - \frac{25}{4} \right) = 9722.3 \end{aligned}$$

42. The width of the strip is $L(y) = \frac{3}{4}(2\sqrt{3} - y)$, the depth of the strip is $(6 - y)$, the height of the strip is $\frac{2}{\sqrt{3}} dy$

$$\Rightarrow F = \int_a^b w \cdot \left(\frac{\text{strip}}{\text{depth}}\right) F(y) dy = \int_0^{2\sqrt{3}} 62.4(6 - y) \cdot \frac{3}{4}(2\sqrt{3} - y) \cdot \frac{2}{\sqrt{3}} dy = \frac{93.6}{\sqrt{3}} \int_0^{2\sqrt{3}} (12\sqrt{3} - 6y - 2y\sqrt{3} + y^2) dy$$

$$= \frac{93.6}{\sqrt{3}} \left[12y\sqrt{3} - 3y^2 - y^2\sqrt{3} + \frac{y^3}{3} \right]_0^{2\sqrt{3}} = \frac{93.6}{\sqrt{3}} (72 - 36 - 12\sqrt{3} + 8\sqrt{3}) \approx 1571.04 \text{ lb}$$

43. The coordinate system is given in the text. The right-hand edge is $x = \sqrt{y}$ and the total width is $L(y) = 2x = 2\sqrt{y}$.

(a) The depth of the strip is $(2 - y)$ so the force exerted by the liquid on the gate is $F = \int_0^1 w(2 - y)L(y) dy$

$$= \int_0^1 50(2 - y) \cdot 2\sqrt{y} dy = 100 \int_0^1 (2 - y)\sqrt{y} dy = 100 \int_0^1 (2y^{1/2} - y^{3/2}) dy = 100 \left[\frac{4}{3}y^{3/2} - \frac{2}{5}y^{5/2} \right]_0^1$$

$$= 100 \left(\frac{4}{3} - \frac{2}{5} \right) = \left(\frac{100}{15} \right) (20 - 6) = 93.33 \text{ lb}$$

(b) We need to solve $160 = \int_0^1 w(H - y) \cdot 2\sqrt{y} dy$ for h . $160 = 100 \left(\frac{2H}{3} - \frac{2}{5} \right) \Rightarrow H = 3 \text{ ft}$.

44. Suppose that h is the maximum height. Using the coordinate system given in the text, we find an equation for the line of the end plate's right-hand edge is $y = \frac{5}{2}x \Rightarrow x = \frac{2}{5}y$. The total width is $L(y) = 2x = \frac{4}{5}y$ and the

depth of the typical horizontal strip at level y is $(h - y)$. Then the force is $F = \int_0^h w(h - y)L(y) dy = F_{\max}$,

where $F_{\max} = 6667 \text{ lb}$. Hence, $F_{\max} = w \int_0^h (h - y) \cdot \frac{4}{5}y dy = (62.4) \left(\frac{4}{5} \right) \int_0^h (hy - y^2) dy = (62.4) \left(\frac{4}{5} \right) \left[\frac{hy^2}{2} - \frac{y^3}{3} \right]_0^h$

$$= (62.4) \left(\frac{4}{5} \right) \left(\frac{h^3}{2} - \frac{h^3}{3} \right) = (62.4) \left(\frac{4}{5} \right) \left(\frac{1}{6} \right) h^3 = (10.4) \left(\frac{4}{5} \right) h^3 \Rightarrow h = \sqrt[3]{\left(\frac{5}{4} \right) \left(\frac{F_{\max}}{10.4} \right)} = \sqrt[3]{\left(\frac{5}{4} \right) \left(\frac{6667}{10.4} \right)} \approx 9.288 \text{ ft}$$

The volume of water which the tank can hold is $V = \frac{1}{2} (\text{Base})(\text{Height}) \cdot 30$, where Height = h and

$$\frac{1}{2} (\text{Base}) = \frac{2}{5}h \Rightarrow V = \left(\frac{2}{5}h^2 \right) (30) = 12h^2 \approx 12(9.288)^2 \approx 1035 \text{ ft}^3$$

45. The pressure at level y is $p(y) = w \cdot y \Rightarrow$ the average

pressure is $\bar{p} = \frac{1}{b} \int_0^b p(y) dy = \frac{1}{b} \int_0^b w \cdot y dy$

$$= \frac{1}{b} w \left[\frac{y^2}{2} \right]_0^b = \left(\frac{w}{b} \right) \left(\frac{b^2}{2} \right) = \frac{wb}{2}$$

This is the pressure at level $\frac{b}{2}$, which is the pressure at the middle of the plate.

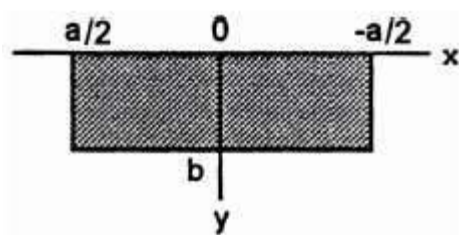

46. The force exerted by the fluid is $F = \int_0^b w(\text{depth})(\text{length}) dy = \int_0^b w \cdot y \cdot a dy = (w \cdot a) \int_0^b y dy = (w \cdot a) \left[\frac{y^2}{2} \right]_0^b$

$$= w \left(\frac{ab^2}{2} \right) = \left(\frac{wb}{2} \right) (ab) = \bar{p} \cdot \text{Area}, \text{ where } \bar{p} \text{ is the average value of the pressure.}$$

47. When the water reaches the top of the tank the force on the movable side is $\int_{-2}^0 (62.4)(2\sqrt{4-y^2})(-y)dy$

$$= (62.4)\int_{-2}^0 (4-y^2)^{1/2} (-y) dy = (62.4)\left[\frac{2}{3}(4-y^2)^{3/2}\right]_{-2}^0 = (62.4)\left(\frac{2}{3}\right)(4^{3/2}) = 332.8 \text{ ft}\cdot\text{lb.}$$

The force compressing the spring is $F = 100x$ so when the tank is full we have $332.8 = 100x \Rightarrow x \approx 3.33$ ft. Therefore the movable end does not reach the required 5 ft to allow drainage \Rightarrow the tank will overflow.

48. (a) Using the given coordinate system we see that the total width $L(y) = 3$ and the depth of the strip is $(3 - y)$.

$$\begin{aligned} \text{Thus, } F &= \int_0^3 w(3-y)L(y) dy = \int_0^3 (62.4)(3-y) \cdot 3 dy \\ &= (62.4)(3)\int_0^3 (3-y) dy = (62.4)(3)\left[3y - \frac{y^2}{2}\right]_0^3 \\ &= (62.4)(3)\left(9 - \frac{9}{2}\right) = (62.4)(3)\left(\frac{9}{2}\right) = 842.4 \text{ lb} \end{aligned}$$

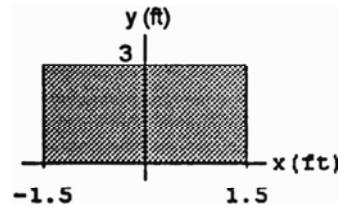

(b) Find a new water level Y such that $F_Y = (0.75)(842.4 \text{ lb}) = 631.8 \text{ lb}$. The new depth of the strip is $(Y - y)$

$$\begin{aligned} \text{and } Y \text{ is the new upper limit of integration. Thus, } F_Y &= \int_0^Y w(Y-y)L(y) dy = 62.4\int_0^Y (Y-y) \cdot 3 dy \\ &= (62.4)(3)\int_0^Y (Y-y) dy = (62.4)(3)\left[Yy - \frac{y^2}{2}\right]_0^Y = (62.4)(3)\left(Y^2 - \frac{Y^2}{2}\right) = (62.4)(3)\left(\frac{Y^2}{2}\right). \end{aligned}$$

$$Y = \sqrt{\frac{2F_Y}{(62.4)(3)}} = \sqrt{\frac{1263.6}{187.2}} = \sqrt{6.75} \approx 2.598 \text{ ft. So, } \Delta Y = 3 - Y \approx 3 - 2.598 \approx 0.402 \text{ ft} \approx 4.8 \text{ in}$$

6.6 MOMENTS AND CENTERS OF MASS

1. Since the plate is symmetric about the y -axis and its density is constant, the distribution of mass is symmetric about the y -axis and the center of mass lies on the y -axis. This means that $\bar{x} = 0$.

It remains to find $\bar{y} = \frac{M_x}{M}$. We model the distribution of mass with vertical strips. The typical strip has center of mass:

$$(\tilde{x}, \tilde{y}) = \left(x, \frac{x^2+4}{2}\right), \text{ length: } 4-x^2 \text{ width: } dx,$$

$$\text{area: } dA = (4-x^2) dx, \text{ mass: } dm = \delta dA = \delta(4-x^2) dx$$

The moment of the strip about the x -axis is $\tilde{y} dm = \left(\frac{x^2+4}{2}\right)\delta(4-x^2) dx = \frac{\delta}{2}(16-x^4) dx$. The moment of the

plate about the x -axis is $M_x = \int \tilde{y} dm = \int_{-2}^2 \frac{\delta}{2}(16-x^4) dx = \frac{\delta}{2}\left[16x - \frac{x^5}{5}\right]_{-2}^2 = \frac{\delta}{2}\left[\left(16 \cdot 2 - \frac{2^5}{5}\right) - \left(-16 \cdot 2 + \frac{2^5}{5}\right)\right]$

$$= \frac{\delta \cdot 2}{2}\left(32 - \frac{32}{5}\right) = \frac{128\delta}{5}. \text{ The mass of the plate is } M = \int \delta(4-x^2) dx = \delta\left[4x - \frac{x^3}{3}\right]_{-2}^2 = 2\delta\left(8 - \frac{8}{3}\right) = \frac{32\delta}{3}.$$

Therefore $\bar{y} = \frac{M_x}{M} = \frac{\left(\frac{128\delta}{5}\right)}{\left(\frac{32\delta}{3}\right)} = \frac{12}{5}$. The plate's center of mass is the point $(\bar{x}, \bar{y}) = \left(0, \frac{12}{5}\right)$.

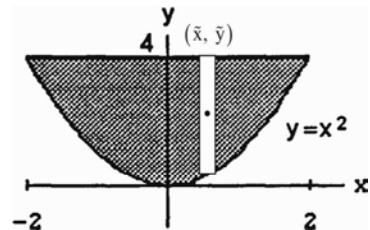

2. Applying the symmetry argument analogous to the one in Exercise 1, we find $\bar{x} = 0$. To find $\bar{y} = \frac{M_x}{M}$, we use the vertical strips technique. The typical strip has center of mass: $(\tilde{x}, \tilde{y}) = \left(x, \frac{25-x^2}{2}\right)$, length: $25 - x^2$, width: dx , area: $dA = (25 - x^2)dx$, mass: $dm = \delta dA = \delta(25 - x^2)dx$.

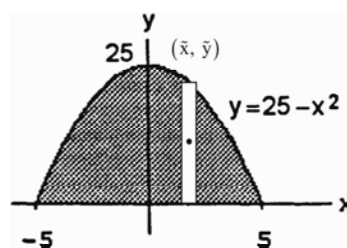

The moment of the strip about the x -axis is $\tilde{y} dm = \left(\frac{25-x^2}{2}\right)\delta(25-x^2)dx = \frac{\delta}{2}(25-x^2)^2 dx$.

The moment of the plate about the x -axis is $M_x = \int \tilde{y} dm = \int_{-5}^5 \frac{\delta}{2}(25-x^2)^2 dx = \frac{\delta}{2} \int_{-5}^5 (625 - 50x^2 + x^4) dx = \frac{\delta}{2} \left[625x - \frac{50}{3}x^3 + \frac{x^5}{5} \right]_{-5}^5 = 2 \cdot \frac{\delta}{2} \left(625 \cdot 5 - \frac{50}{3} \cdot 5^3 + \frac{5^5}{5} \right) = \delta \cdot 625 \left(5 - \frac{10}{3} + 1 \right) = \delta \cdot 625 \cdot \left(\frac{8}{3} \right)$. The mass of the plate is $M = \int dm = \int_{-5}^5 \delta(25-x^2) dx = \delta \left[25x - \frac{x^3}{3} \right]_{-5}^5 = 2\delta \left(5^3 - \frac{5^3}{3} \right) = \frac{4}{3}\delta \cdot 5^3$. Therefore $\bar{y} = \frac{M_x}{M} = \frac{\delta \cdot 5^4 \cdot \left(\frac{8}{3}\right)}{\delta \cdot 5^3 \cdot \left(\frac{4}{3}\right)} = 10$.

The plate's center of mass is the point $(\bar{x}, \bar{y}) = (0, 10)$.

3. Intersection points: $x - x^2 = -x \Rightarrow 2x - x^2 = 0 \Rightarrow x(2-x) = 0 \Rightarrow x = 0$ or $x = 2$. The typical vertical

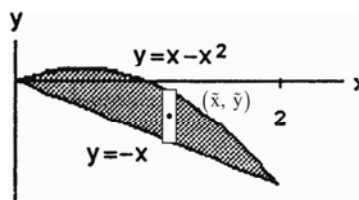

strip has center of mass: $(\tilde{x}, \tilde{y}) = \left(x, \frac{(x-x^2)+(-x)}{2}\right) = \left(x, -\frac{x^2}{2}\right)$, length: $(x - x^2) - (-x) = 2x - x^2$,

width: dx , area: $dA = (2x - x^2)dx$, mass: $dm = \delta dA$

$= \delta(2x - x^2)dx$. The moment of the strip about the x -axis is $\tilde{y} dm = \left(-\frac{x^2}{2}\right)\delta(2x - x^2)dx$; about the y -axis it is $\tilde{x} dm = x \cdot \delta(2x - x^2)dx$. Thus, $M_x = \int \tilde{y} dm = -\int_0^2 \left(\frac{\delta}{2}x^2\right)(2x - x^2)dx = -\frac{\delta}{2} \int_0^2 (2x^3 - x^4)dx$

$= -\frac{\delta}{2} \left[\frac{x^4}{2} - \frac{x^5}{5} \right]_0^2 = -\frac{\delta}{2} \left(2^4 - \frac{2^5}{5} \right) = -\frac{\delta}{2} \cdot 2^3 \left(1 - \frac{4}{5} \right) = -\frac{4\delta}{5}$; $M_y = \int \tilde{x} dm = \int_0^2 x \cdot \delta(2x - x^2)dx$

$= \delta \int_0^2 (2x^2 - x^3)dx = \delta \left[\frac{2}{3}x^3 - \frac{x^4}{4} \right]_0^2 = \delta \left(\frac{2}{3} \cdot 2^3 - \frac{2^4}{4} \right) = \frac{\delta \cdot 2^4}{12} = \frac{4\delta}{3}$; $M = \int dm = \int_0^2 \delta(2x - x^2)dx$

$= \delta \int_0^2 (2x - x^2)dx = \delta \left[x^2 - \frac{x^3}{3} \right]_0^2 = \delta \left(4 - \frac{8}{3} \right) = \frac{4\delta}{3}$. Therefore, $\bar{x} = \frac{M_y}{M} = \left(\frac{4\delta}{3}\right)\left(\frac{3}{4\delta}\right) = 1$ and $\bar{y} = \frac{M_x}{M}$

$= \left(-\frac{4\delta}{5}\right)\left(\frac{3}{4\delta}\right) = -\frac{3}{5} \Rightarrow (\bar{x}, \bar{y}) = \left(1, -\frac{3}{5}\right)$ is the center of mass.

4. Intersection points: $x^2 - 3 = -2x^2 \Rightarrow 3x^2 - 3 = 0 \Rightarrow 3(x-1)(x+1) = 0 \Rightarrow x = -1$ or $x = 1$. Applying the symmetry argument analogous to the one in Exercise 1, we find $\bar{x} = 0$. The typical vertical strip has center of mass:

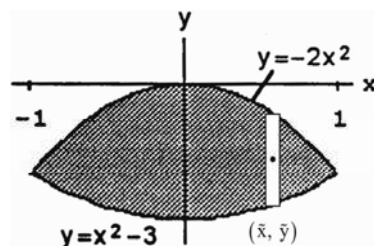

$(\tilde{x}, \tilde{y}) = \left(x, \frac{-2x^2+(x^2-3)}{2}\right) = \left(x, \frac{-x^2-3}{2}\right)$, length: $-2x^2 - (x^2 - 3)$

$= 3(1 - x^2)$, width: dx , area: $dA = 3(1 - x^2)dx$,

mass: $dm = \delta dA = 3\delta(1-x^2) dx$. The moment of the strip about the x -axis is

$$\tilde{y} dm = \frac{3}{2}\delta(-x^2-3)(1-x^2) dx = \frac{3}{2}\delta(x^4+3x^2-x^2-3) dx = \frac{3}{2}\delta(x^4+2x^2-3) dx;$$

$$M_x = \int \tilde{y} dm = \frac{3}{2}\delta \int_{-1}^1 (x^4+2x^2-3) dx = \frac{3}{2}\delta \left[\frac{x^5}{5} + \frac{2x^3}{3} - 3x \right]_{-1}^1 = \frac{3}{2}\delta \cdot 2 \left(\frac{1}{5} + \frac{2}{3} - 3 \right) = 3\delta \left(\frac{3+10-45}{15} \right) = -\frac{32\delta}{5};$$

$$M = \int dm = 3\delta \int_{-1}^1 (1-x^2) dx = 3\delta \left[x - \frac{x^3}{3} \right]_{-1}^1 = 3\delta \cdot 2 \left(1 - \frac{1}{3} \right) = 4\delta. \text{ Therefore, } \bar{y} = \frac{M_x}{M} = -\frac{\delta \cdot 32}{5 \cdot \delta \cdot 4} = -\frac{8}{5}$$

$\Rightarrow (\bar{x}, \bar{y}) = \left(0, -\frac{8}{5} \right)$ is the center of mass.

5. The typical *horizontal* strip has center of mass: $(\tilde{x}, \tilde{y}) = \left(\frac{y-y^3}{2}, y \right)$,

length: $y-y^3$, width: dy , area: $dA = (y-y^3) dy$,

mass: $dm = \delta dA = \delta(y-y^3) dy$. The moment of the strip about the

$$y\text{-axis is } \tilde{x} dm = \delta \left(\frac{y-y^3}{2} \right) (y-y^3) dy = \frac{\delta}{2} (y-y^3)^2 dy$$

$$= \frac{\delta}{2} (y^2-2y^4+y^6) dy; \text{ the moment about the } x\text{-axis is } \tilde{y} dm = \delta y (y-y^3) dy = \delta (y^2-y^4) dy. \text{ Thus,}$$

$$M_x = \int \tilde{y} dm = \delta \int_0^1 (y^2-y^4) dy = \delta \left[\frac{y^3}{3} - \frac{y^5}{5} \right]_0^1 = \delta \left(\frac{1}{3} - \frac{1}{5} \right) = \frac{2\delta}{15}; \quad M_y = \int \tilde{x} dm = \frac{\delta}{2} \int_0^1 (y^2-2y^4+y^6) dy$$

$$= \frac{\delta}{2} \left[\frac{y^3}{3} - \frac{2y^5}{5} + \frac{y^7}{7} \right]_0^1 = \frac{\delta}{2} \left(\frac{1}{3} - \frac{2}{5} + \frac{1}{7} \right) = \frac{\delta}{2} \left(\frac{35-42+15}{105} \right) = \frac{4\delta}{105}; \quad M = \int dm = \delta \int_0^1 (y-y^3) dy = \delta \left[\frac{y^2}{2} - \frac{y^4}{4} \right]_0^1$$

$= \delta \left(\frac{1}{2} - \frac{1}{4} \right) = \frac{\delta}{4}$. Therefore, $\bar{x} = \frac{M_y}{M} = \frac{(4\delta)}{(105)} \left(\frac{4}{\delta} \right) = \frac{16}{105}$ and $\bar{y} = \frac{M_x}{M} = \left(\frac{2\delta}{15} \right) \left(\frac{4}{\delta} \right) = \frac{8}{15} \Rightarrow (\bar{x}, \bar{y}) = \left(\frac{16}{105}, \frac{8}{15} \right)$ is the center of mass.

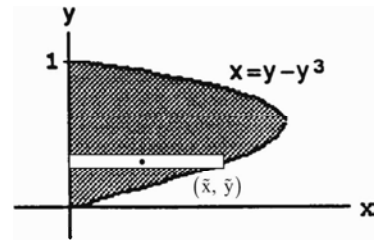

6. Intersection points: $y = y^2 - y \Rightarrow y^2 - 2y = 0$

$\Rightarrow y(y-2) = 0 \Rightarrow y = 0$ or $y = 2$ The typical *horizontal*

strip has center of mass: $(\tilde{x}, \tilde{y}) = \left(\frac{(y^2-y)+y}{2}, y \right) = \left(\frac{y^2}{2}, y \right)$,

length: $y - (y^2 - y) = 2y - y^2$, width: dy ,

area: $dA = (2y - y^2) dy$, mass: $dm = \delta dA = \delta(2y - y^2) dy$.

The moment about the y -axis is $\tilde{x} dm = \frac{\delta}{2} \cdot y^2 (2y - y^2) dy = \frac{\delta}{2} (2y^3 - y^4) dy$; the moment about the x -axis

$$\text{is } \tilde{y} dm = \delta y (2y - y^2) dy = \delta (2y^2 - y^3) dy. \text{ Thus, } M_x = \int \tilde{y} dm = \delta \int_0^2 (2y^2 - y^3) dy = \delta \left[\frac{2y^3}{3} - \frac{y^4}{4} \right]_0^2$$

$$= \delta \left(\frac{16}{3} - \frac{16}{4} \right) = \frac{16\delta}{12} (4-3) = \frac{4\delta}{3}; \quad M_y = \int \tilde{x} dm = \int_0^2 \frac{\delta}{2} (2y^3 - y^4) dy = \frac{\delta}{2} \left[\frac{y^4}{2} - \frac{y^5}{5} \right]_0^2 = \frac{\delta}{2} \left(8 - \frac{32}{5} \right)$$

$$= \frac{\delta}{2} \left(\frac{40-32}{5} \right) = \frac{4\delta}{5}; \quad M = \int dm = \int_0^2 \delta (2y - y^2) dy = \delta \left[y^2 - \frac{y^3}{3} \right]_0^2 = \delta \left(4 - \frac{8}{3} \right) = \frac{4\delta}{3}. \text{ Therefore,}$$

$\bar{x} = \frac{M_y}{M} = \left(\frac{4\delta}{5} \right) \left(\frac{3}{4\delta} \right) = \frac{3}{5}$ and $\bar{y} = \frac{M_x}{M} = \left(\frac{4\delta}{3} \right) \left(\frac{3}{4\delta} \right) = 1 \Rightarrow (\bar{x}, \bar{y}) = \left(\frac{3}{5}, 1 \right)$ is the center of mass.

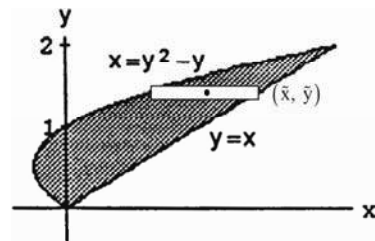

7. Applying the symmetry argument analogous to the one used in Exercise 1, we find $\bar{x} = 0$. The typical vertical strip has center of mass: $(\tilde{x}, \tilde{y}) = \left(x, \frac{\cos x}{2}\right)$, length: $\cos x$, width: dx , area: $dA = \cos x dx$, mass: $dm = \delta dA = \delta \cos x dx$. The moment of the strip about the x -axis is $\tilde{y} dm = \delta \cdot \frac{\cos x}{2} \cdot \cos x dx$

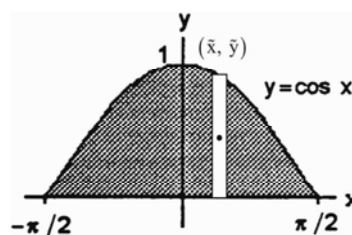

$$= \frac{\delta}{2} \cos^2 x dx = \frac{\delta}{2} \left(\frac{1+\cos 2x}{2}\right) dx = \frac{\delta}{4} (1 + \cos 2x) dx; \text{ thus,}$$

$$M_x = \int \tilde{y} dm = \int_{-\pi/2}^{\pi/2} \frac{\delta}{4} (1 + \cos 2x) dx = \frac{\delta}{4} \left[x + \frac{\sin 2x}{2} \right]_{-\pi/2}^{\pi/2} = \frac{\delta}{4} \left[\left(\frac{\pi}{2} + 0\right) - \left(-\frac{\pi}{2}\right) \right] = \frac{6\delta}{4}; \quad M = \int dm$$

$$= \delta \int_{-\pi/2}^{\pi/2} \cos x dx = \delta [\sin x]_{-\pi/2}^{\pi/2} = 2\delta. \text{ Therefore, } \bar{y} = \frac{M_x}{M} = \frac{6\delta}{4 \cdot 2\delta} = \frac{\pi}{8} \Rightarrow (\bar{x}, \bar{y}) = \left(0, \frac{\pi}{8}\right) \text{ is the center of mass.}$$

8. Applying the symmetry argument analogous to the one used in Exercise 1, we find $\bar{x} = 0$. The typical vertical strip has center of mass: $(\tilde{x}, \tilde{y}) = \left(x, \frac{\sec^2 x}{2}\right)$, length: $\sec^2 x$, width: dx ,

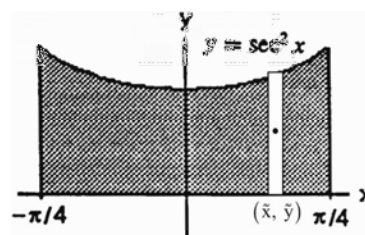

area: $dA = \sec^2 x dx$, mass: $dm = \delta dA = \delta \sec^2 x dx$. The moment about the x -axis is $\tilde{y} dm = \left(\frac{\sec^2 x}{2}\right) (\delta \sec^2 x) dx$

$$= \frac{\delta}{2} \sec^4 x dx. \quad M_x = \int_{-\pi/4}^{\pi/4} \tilde{y} dm = \frac{\delta}{2} \int_{-\pi/4}^{\pi/4} \sec^4 x dx = \frac{\delta}{2} \int_{-\pi/4}^{\pi/4} (\tan^2 x + 1) (\sec^2 x) dx$$

$$= \frac{\delta}{2} \int_{-\pi/4}^{\pi/4} (\tan x)^2 (\sec^2 x) dx + \frac{\delta}{2} \int_{-\pi/4}^{\pi/4} \sec^2 x dx = \frac{\delta}{2} \left[\frac{(\tan x)^3}{3} \right]_{-\pi/4}^{\pi/4} + \frac{\delta}{2} [\tan x]_{-\pi/4}^{\pi/4}$$

$$= \frac{\delta}{2} \left[\frac{1}{3} - \left(-\frac{1}{3}\right) \right] + \frac{\delta}{2} [1 - (-1)] = \frac{\delta}{3} + \delta = \frac{4\delta}{3}; \quad M = \int dm = \delta \int_{-\pi/4}^{\pi/4} \sec^2 x dx = \delta [\tan x]_{-\pi/4}^{\pi/4} = \delta [1 - (-1)] = 2\delta.$$

Therefore, $\bar{y} = \frac{M_x}{M} = \left(\frac{4\delta}{3}\right) \left(\frac{1}{2\delta}\right) = \frac{2}{3} \Rightarrow (\bar{x}, \bar{y}) = \left(0, \frac{2}{3}\right)$ is the center of mass.

9. $M_y = \int_1^2 x \left(\frac{1}{x}\right) dx = 1,$
- $$M_x = \int_1^2 \left(\frac{1}{2x}\right) \left(\frac{1}{x}\right) dx = \frac{1}{2} \int_1^2 \frac{1}{x^2} dx = \left[-\frac{1}{2x} \right]_1^2 = \frac{1}{4},$$
- $$M = \int_1^2 \frac{1}{x} dx = [\ln|x|]_1^2 = \ln 2 \Rightarrow \bar{X} = \frac{M_y}{M} = \frac{1}{\ln 2} \approx 1.44 \text{ and}$$
- $$\bar{y} = \frac{M_x}{M} = \frac{\left(\frac{1}{4}\right)}{\ln 2} \approx 0.36$$

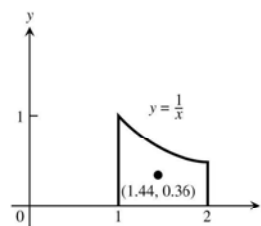

10. (a) Since the plate is symmetric about the line $x = y$ and its density is constant, the distribution of mass is symmetric about this line. This means that $\bar{x} = \bar{y}$. The typical vertical

strip has center of mass: $(\tilde{x}, \tilde{y}) = \left(x, \frac{\sqrt{9-x^2}}{2}\right)$,

length: $\sqrt{9-x^2}$ width: dx , area: $dA = \sqrt{9-x^2} dx$,

mass: $dm = \delta dA = \delta\sqrt{9-x^2} dx$. The moment about the

x -axis is $\tilde{y} dm = \delta \left(\frac{\sqrt{9-x^2}}{2}\right) \sqrt{9-x^2} dx = \frac{\delta}{2}(9-x^2) dx$

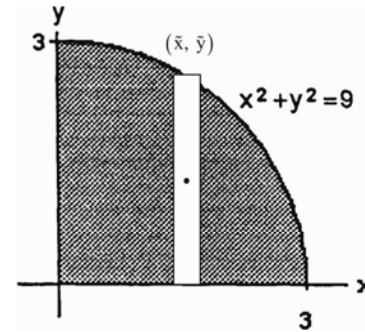

Thus, $M_x = \int \tilde{y} dm = \int_0^3 \frac{\delta}{2}(9-x^2) dx = \frac{\delta}{2} \left[9x - \frac{x^3}{3}\right]_0^3 = \frac{\delta}{2}(27-9) = 9\delta$; $M = \int dm = \int \delta dA = \delta \int dA$

$= \delta$ (Area of a quarter of a circle of radius 3) $= \delta \left(\frac{9\pi}{4}\right) = \frac{9\pi\delta}{4}$. Therefore, $\bar{y} = \frac{M_x}{M} = (9\delta) \left(\frac{4}{9\pi\delta}\right) = \frac{4}{\pi}$

$\Rightarrow (\bar{x}, \bar{y}) = \left(\frac{4}{\pi}, \frac{4}{\pi}\right)$ is the center of mass.

- (b) Applying the symmetry argument analogous to the one used in Exercise 1, we find that $\bar{x} = 0$. The typical vertical strip has the same parameters as in

part (a). Thus, $M_x = \int \tilde{y} dm = \int_{-3}^3 \frac{\delta}{2}(9-x^2) dx$

$= 2 \int_0^3 \frac{\delta}{2}(9-x^2) dx = 2(9\delta) = 18\delta$; $M = \int dm = \int \delta dA$

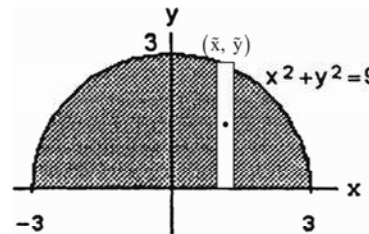

$= \delta \int dA = \delta$ (Area of a semi-circle of radius 3) $= \delta \left(\frac{9\pi}{2}\right) = \frac{9\pi\delta}{2}$. Therefore, $\bar{y} = \frac{M_x}{M} = (18\delta) \left(\frac{2}{9\pi\delta}\right) = \frac{4}{\pi}$, the

same \bar{y} as in part (a) $\Rightarrow (\bar{x}, \bar{y}) = \left(0, \frac{4}{\pi}\right)$ is the center of mass.

11. Since the plate is symmetric about the x -axis and its density is constant, the distribution of mass is symmetric about this line. This means that $\bar{y} = 0$. The typical vertical strip has center of

mass: $(\tilde{y}, \tilde{y}) = (x, 0)$, length: $\frac{1}{1+x^2} - \left(-\frac{1}{1+x^2}\right)$,

width: dx , area: $dA = \frac{2}{1+x^2} dx$, mass: $dm = \delta dA = \delta \left(\frac{2}{1+x^2}\right) dx$.

The moment about the y -axis is

$\tilde{x} dm = \delta x \left(\frac{2}{1+x^2}\right) dx = \delta \left(\frac{2x}{1+x^2}\right) dx = \frac{2\delta x}{1+x^2} dx$. Thus,

$M_y = \int_0^1 \frac{2\delta x}{1+x^2} dx = \delta [\ln(1+x^2)]_0^1 = \delta \ln 2$.

$M = \int dm = \int_0^1 \delta \left(\frac{2}{1+x^2}\right) dx = 2\delta [\arctan x]_0^1 = 2\delta(\arctan 1) = \frac{2\delta\pi}{4} = \frac{\delta\pi}{2}$. Therefore,

$\bar{x} = \frac{M_y}{M} = \frac{\delta \ln 2}{\delta\pi/2} = \frac{2\ln 2}{\pi} = \frac{\ln 4}{\pi} \Rightarrow (\bar{x}, \bar{y}) = \left(\frac{\ln 4}{\pi}, 0\right)$ is the center of mass.

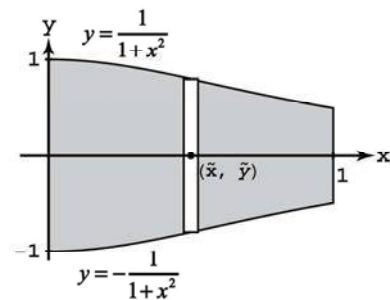

12. Since the plate is symmetric about the line $x = 1$ and its density is constant, the distribution of mass is symmetric about this line and the center of mass lies on it. This means that $\bar{x} = 1$. The typical vertical strip has center of mass:

$$(\tilde{x}, \tilde{y}) = \left(x, \frac{(2x-x^2)+(2x^2-4x)}{2} \right) = \left(x, \frac{x^2-2x}{2} \right),$$

length: $(2x-x^2) - (2x^2-4x) = -3x^2 + 6x = 3(2x-x^2)$

width: dx , area: $dA = 3(2x-x^2) dx$, mass: $dm = \delta dA$

$= 3\delta(2x-x^2) dx$. The moment about the x -axis is

$$\tilde{y} dm = \frac{3}{2} \delta (x^2 - 2x)(2x - x^2) dx = -\frac{3}{2} \delta (x^2 - 2x)^2 dx = -\frac{3}{2} \delta (x^4 - 4x^3 + 4x^2) dx. \text{ Thus, } M_x = \int \tilde{y} dm$$

$$= -\int_0^2 \frac{3}{2} \delta (x^4 - 4x^3 + 4x^2) dx = -\frac{3}{2} \delta \left[\frac{x^5}{5} - x^4 + \frac{4}{3} x^3 \right]_0^2 = -\frac{3}{2} \delta \left(\frac{2^5}{5} - 2^4 + \frac{4}{3} \cdot 2^3 \right) = -\frac{3}{2} \delta \cdot 2^4 \left(\frac{2}{5} - 1 + \frac{2}{3} \right)$$

$$= -\frac{3}{2} \delta \cdot 2^4 \left(\frac{6-15+10}{15} \right) = -\frac{8\delta}{5}; \quad M = \int dm = \int_0^2 3\delta(2x-x^2) dx = 3\delta \left[x^2 - \frac{x^3}{3} \right]_0^2 = 3\delta \left(4 - \frac{8}{3} \right) = 4\delta. \text{ Therefore,}$$

$$\bar{y} = \frac{M_x}{M} = \left(-\frac{8\delta}{5} \right) \left(\frac{1}{4\delta} \right) = -\frac{2}{5} \Rightarrow (\bar{x}, \bar{y}) = \left(1, -\frac{2}{5} \right) \text{ is the center of mass.}$$

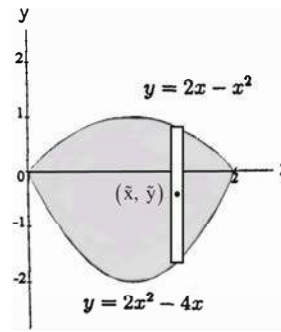

13. $M_y = \int_1^{16} x \left(\frac{1}{\sqrt{x}} \right) dx = \int_1^{16} x^{1/2} dx = \frac{2}{3} [x^{3/2}]_1^{16} = 42; \quad M_x = \int_1^{16} \left(\frac{1}{2\sqrt{x}} \right) \left(\frac{1}{\sqrt{x}} \right) dx = \frac{1}{2} \int_1^{16} \frac{1}{x} dx = \frac{1}{2} [\ln|x|]_1^{16} = \ln 4,$

$$M = \int_1^{16} \frac{1}{\sqrt{x}} dx = [2x^{1/2}]_1^{16} = 6 \Rightarrow \bar{x} = \frac{M_y}{M} = 7 \text{ and } \bar{y} = \frac{M_x}{M} = \frac{\ln 4}{6}$$

14. Applying the symmetry argument analogous to the one used in Exercise 1, we find that $\bar{y} = 0$. The typical vertical strip has center of mass:

$$(\tilde{x}, \tilde{y}) = \left(x, \frac{\frac{1}{x^3} - \frac{1}{x^3}}{2} \right) = (x, 0), \text{ length: } \frac{1}{x^3} - \left(-\frac{1}{x^3} \right) = \frac{2}{x^3}, \text{ width: } dx,$$

area: $dA = \frac{2}{x^3} dx$, mass: $dm = \delta dA = \frac{2\delta}{x^3} dx$. The moment about the y -axis is $\tilde{x} dm = x \cdot \frac{2\delta}{x^3} dx = \frac{2\delta}{x^2} dx$. Thus,

$$M_y = \int \tilde{x} dm = \int_1^a \frac{2\delta}{x^2} dx = 2\delta \left[-\frac{1}{x} \right]_1^a = 2\delta \left(-\frac{1}{a} + 1 \right) = \frac{2\delta(a-1)}{a}; \quad M = \int dm = \int_1^a \frac{2\delta}{x^3} dx = \delta \left[-\frac{1}{x^2} \right]_1^a = \delta \left(-\frac{1}{a^2} + 1 \right)$$

$$= \frac{\delta(a^2-1)}{a^2}. \text{ Therefore, } \bar{x} = \frac{M_y}{M} = \left(\frac{2\delta(a-1)}{a} \right) \left(\frac{a^2}{\delta(a^2-1)} \right) = \frac{2a}{a+1} \Rightarrow (\bar{x}, \bar{y}) = \left(\frac{2a}{a+1}, 0 \right). \text{ Also, } \lim_{a \rightarrow \infty} \bar{x} = 2.$$

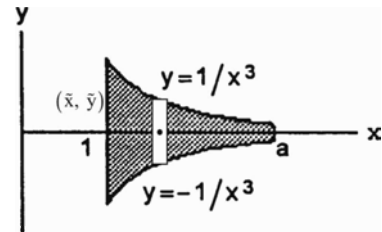

15. $M_x = \int \tilde{y} dm = \int_1^2 \left(\frac{\frac{2}{x^2}}{2} \right) \cdot \delta \cdot \left(\frac{2}{x^2} \right) dx = \int_1^2 \left(\frac{1}{x^2} \right) \left(x^2 \right) \left(\frac{2}{x^2} \right) dx$

$$= \int_1^2 \frac{2}{x^2} dx = 2 \int_1^2 x^{-2} dx = 2 \left[-x^{-1} \right]_1^2 = 2 \left[\left(-\frac{1}{2} \right) - (-1) \right] = 2 \left(\frac{1}{2} \right) = 1;$$

$$M_y = \int \tilde{x} dm = \int_1^2 x \cdot \delta \cdot \left(\frac{2}{x^2} \right) dx$$

$$= \int_1^2 x \left(x^2 \right) \left(\frac{2}{x^2} \right) dx = 2 \int_1^2 x dx = 2 \left[\frac{x^2}{2} \right]_1^2 = 2 \left(2 - \frac{1}{2} \right) = 4 - 1 = 3; \quad M = \int dm = \int_1^2 \delta \left(\frac{2}{x^2} \right) dx = \int_1^2 x^2 \left(\frac{2}{x^2} \right) dx$$

$$= 2 \int_1^2 dx = 2[x]_1^2 = 2(2-1) = 2. \text{ So } \bar{x} = \frac{M_y}{M} = \frac{3}{2} \text{ and } \bar{y} = \frac{M_x}{M} = \frac{1}{2} \Rightarrow (\bar{x}, \bar{y}) = \left(\frac{3}{2}, \frac{1}{2} \right) \text{ is the center of mass.}$$

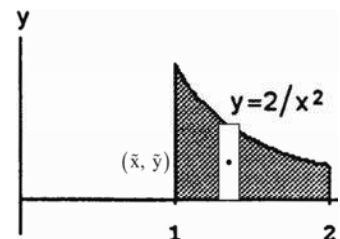

16. We use the *vertical strip* approach:

$$M_x = \int \tilde{y} \, dm = \int_0^1 \frac{(x+x^2)}{2} (x-x^2) \cdot \delta \, dx$$

$$= \frac{1}{2} \int_0^1 (x^2 - x^4) \cdot 12x \, dx = 6 \int_0^1 (x^3 - x^5) \, dx$$

$$= 6 \left[\frac{x^4}{4} - \frac{x^6}{6} \right]_0^1 = 6 \left(\frac{1}{4} - \frac{1}{6} \right) = \frac{6}{4} - 1 = \frac{1}{2};$$

$$M_y = \int \tilde{x} \, dm = \int_0^1 x(x-x^2) \cdot \delta \, dx = \int_0^1 (x^2 - x^3) \cdot 12x \, dx = 12 \int_0^1 (x^3 - x^4) \, dx = 12 \left[\frac{x^4}{4} - \frac{x^5}{5} \right]_0^1 = 12 \left(\frac{1}{4} - \frac{1}{5} \right) = \frac{12}{20} = \frac{3}{5};$$

$$M = \int dm = \int_0^1 (x-x^2) \cdot \delta \, dx = 12 \int_0^1 (x^2 - x^3) \, dx = 12 \left[\frac{x^3}{3} - \frac{x^4}{4} \right]_0^1 = 12 \left(\frac{1}{3} - \frac{1}{4} \right) = \frac{12}{12} = 1. \text{ So } \bar{x} = \frac{M_y}{M} = \frac{3}{5} \text{ and } \bar{y} = \frac{M_x}{M} = \frac{1}{2} \Rightarrow \left(\frac{3}{5}, \frac{1}{2} \right) \text{ is the center of mass.}$$

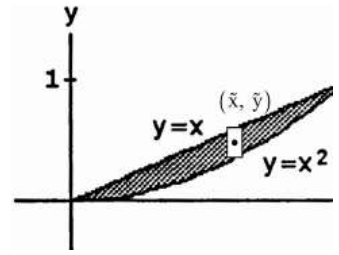

17. (a) We use the shell method: $V = \int_a^b 2\pi \left(\begin{smallmatrix} \text{shell} \\ \text{radius} \end{smallmatrix} \right) \left(\begin{smallmatrix} \text{shell} \\ \text{height} \end{smallmatrix} \right) dx = \int_1^4 2\pi x \left[\frac{4}{\sqrt{x}} - \left(-\frac{4}{\sqrt{x}} \right) \right] dx = 16\pi \int_1^4 \frac{x}{\sqrt{x}} dx$

$$= 16\pi \int_1^4 x^{1/2} dx = 16\pi \left[\frac{2}{3} x^{3/2} \right]_1^4 = 16\pi \left(\frac{2}{3} \cdot 8 - \frac{2}{3} \right) = \frac{32\pi}{3} (8-1) = \frac{224\pi}{3}$$

(b) Since the plate is symmetric about the x -axis and its density $\delta(x) = \frac{1}{x}$ is a function of x alone, the distribution of its mass is symmetric about the x -axis. This means that $\bar{y} = 0$. We use the vertical strip approach to find \bar{x} : $M_y = \int \tilde{x} \, dm = \int_1^4 x \cdot \left[\frac{4}{\sqrt{x}} - \left(-\frac{4}{\sqrt{x}} \right) \right] \cdot \delta \, dx = \int_1^4 x \cdot \frac{8}{\sqrt{x}} \cdot \frac{1}{x} dx = 8 \int_1^4 x^{-1/2} dx = 8 \left[2x^{1/2} \right]_1^4 = 8(2 \cdot 2 - 2) = 16$; $M = \int dm = \int_1^4 \left[\frac{4}{\sqrt{x}} - \left(-\frac{4}{\sqrt{x}} \right) \right] \cdot \delta \, dx = 8 \int_1^4 \left(\frac{1}{\sqrt{x}} \right) \left(\frac{1}{x} \right) dx = 8 \int_1^4 x^{-3/2} dx = 8 \left[-2x^{-1/2} \right]_1^4 = 8[-1 - (-2)] = 8$. So $\bar{x} = \frac{M_y}{M} = \frac{16}{8} = 2 \Rightarrow (\bar{x}, \bar{y}) = (2, 0)$ is the center of mass.

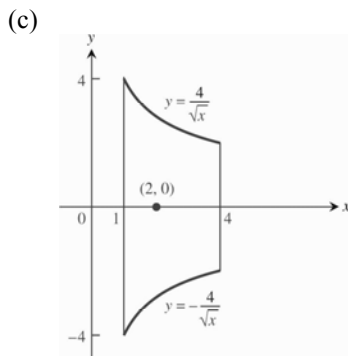

18. (a) We use the disk method: $V = \int_a^b \pi [R(x)]^2 dx = \int_1^4 \pi \left(\frac{4}{x^2} \right) dx = 4\pi \int_1^4 x^{-2} dx = 4\pi \left[-\frac{1}{x} \right]_1^4 = 4\pi \left[\frac{-1}{4} - (-1) \right] = \pi[-1+4] = 3\pi$

(b) We model the distribution of mass with vertical strips: $M_x = \int \tilde{y} \, dm = \int_1^4 \frac{(\frac{2}{x})}{2} \cdot \left(\frac{2}{x} \right) \cdot \delta \, dx = \int_1^4 \frac{2}{x^2} \cdot \sqrt{x} \, dx$

$$= 2 \int_1^4 x^{-3/2} dx = 2 \left[\frac{-2}{\sqrt{x}} \right]_1^4 = 2[-1 - (-2)] = 2$$
; $M_y = \int \tilde{x} \, dm = \int_1^4 x \cdot \frac{2}{x} \cdot \delta \, dx = 2 \int_1^4 x^{1/2} dx = 2 \left[\frac{2x^{3/2}}{3} \right]_1^4$

$$= 2 \left[\frac{16}{3} - \frac{2}{3} \right] = \frac{28}{3}$$
; $M = \int dm = \int_1^4 \frac{2}{x} \cdot \delta \, dx = 2 \int_1^4 \frac{\sqrt{x}}{x} dx = 2 \int_1^4 x^{-1/2} dx = 2 \left[2x^{1/2} \right]_1^4 = 2(4-2) = 4$.

So $\bar{x} = \frac{M_y}{M} = \frac{(\frac{28}{3})}{4} = \frac{7}{3}$ and $\bar{y} = \frac{M_x}{M} = \frac{2}{4} = \frac{1}{2} \Rightarrow (\bar{x}, \bar{y}) = \left(\frac{7}{3}, \frac{1}{2} \right)$ is the center of mass.

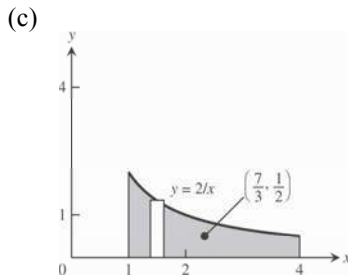

19. The mass of a horizontal strip is $dm = \delta dA = \delta L dy$, where L is the width of the triangle at a distance of y above its base on the x -axis as shown in the figure in the text. Also, by similar triangles we have $\frac{L}{b} = \frac{h-y}{h}$
- $$\Rightarrow L = \frac{b}{h}(h-y). \text{ Thus, } M_x = \int \tilde{y} dm = \int_0^h \delta y \left(\frac{b}{h}\right)(h-y) dy = \frac{\delta b}{h} \int_0^h (hy - y^2) dy = \frac{\delta b}{h} \left[\frac{hy^2}{2} - \frac{y^3}{3} \right]_0^h = \frac{\delta b}{h} \left(\frac{h^3}{2} - \frac{h^3}{3} \right)$$
- $$= \delta b h^2 \left(\frac{1}{2} - \frac{1}{3} \right) = \frac{\delta b h^2}{6}; \quad M = \int dm = \int_0^h \delta \left(\frac{b}{h}\right)(h-y) dy = \frac{\delta b}{h} \int_0^h (h-y) dy = \frac{\delta b}{h} \left[hy - \frac{y^2}{2} \right]_0^h = \frac{\delta b}{h} \left(h^2 - \frac{h^2}{2} \right) = \frac{\delta b h}{2}.$$
- So $\bar{y} = \frac{M_x}{M} = \left(\frac{\delta b h^2}{6} \right) \left(\frac{2}{\delta b h} \right) = \frac{h}{3} \Rightarrow$ the center of mass lies above the base of the triangle one-third of the way toward the opposite vertex. Similarly the other two sides of the triangle can be placed on the x -axis and the same results will occur. Therefore the centroid does lie at the intersection of the medians, as claimed.

20. From the symmetry about the y -axis it follows that $\bar{x} = 0$. It also follows that the line through the points $(0, 0)$ and $(0, 3)$ is a median
- $$\Rightarrow \bar{y} = \frac{1}{3}(3-0) = 1 \Rightarrow (\bar{x}, \bar{y}) = (0, 1).$$

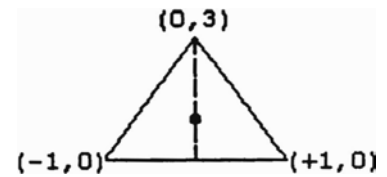

21. From the symmetry about the line $x = y$ it follows that $\bar{x} = \bar{y}$. It also follows that the line through the points $(0, 0)$ and $(\frac{1}{2}, \frac{1}{2})$ is a median
- $$\Rightarrow \bar{y} = \bar{x} = \frac{2}{3} \cdot \left(\frac{1}{2} - 0 \right) = \frac{1}{3} \Rightarrow (\bar{x}, \bar{y}) = \left(\frac{1}{3}, \frac{1}{3} \right).$$

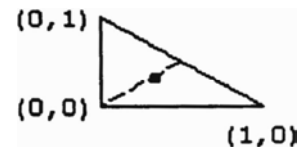

22. From the symmetry about the line $x = y$ it follows that $\bar{x} = \bar{y}$. It also follows that the line through the point $(0, 0)$ and $(\frac{a}{2}, \frac{a}{2})$ is a median
- $$\Rightarrow \bar{y} = \bar{x} = \frac{2}{3} \left(\frac{a}{2} - 0 \right) = \frac{1}{3} a \Rightarrow (\bar{x}, \bar{y}) = \left(\frac{a}{3}, \frac{a}{3} \right).$$

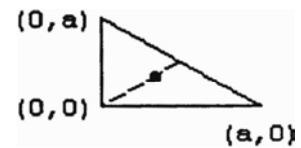

23. The point of intersection of the median from the vertex $(0, b)$ to the opposite side has coordinates $(0, \frac{a}{2}) \Rightarrow \bar{y} = (b-0) \cdot \frac{1}{3} = \frac{b}{3}$ and
- $$\bar{x} = \left(\frac{a}{2} - 0 \right) \cdot \frac{2}{3} = \frac{a}{3} \Rightarrow (\bar{x}, \bar{y}) = \left(\frac{a}{3}, \frac{b}{3} \right).$$

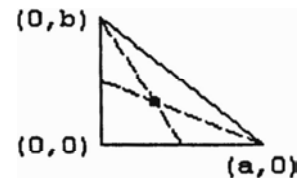

24. From the symmetry about the line $x = \frac{a}{2}$ it follows that $\bar{x} = \frac{a}{2}$. It also follows that the line through the points $(\frac{a}{2}, 0)$ and $(\frac{a}{2}, b)$ is a median $\Rightarrow \bar{y} = \frac{1}{3}(b-0) = \frac{b}{3} \Rightarrow (\bar{x}, \bar{y}) = (\frac{a}{2}, \frac{b}{3})$.

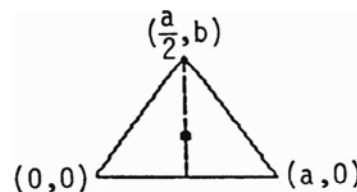

25. $y = x^{1/2} \Rightarrow dy = \frac{1}{2}x^{-1/2} dx \Rightarrow ds = \sqrt{(dx)^2 + (dy)^2} = \sqrt{1 + \frac{1}{4x}} dx$;
 $M_x = \delta \int_0^2 \sqrt{x} \sqrt{1 + \frac{1}{4x}} dx = \delta \int_0^2 \sqrt{x + \frac{1}{4}} dx = \frac{2\delta}{3} \left[\left(x + \frac{1}{4}\right)^{3/2} \right]_0^2$
 $= \frac{2\delta}{3} \left[\left(2 + \frac{1}{4}\right)^{3/2} - \left(\frac{1}{4}\right)^{3/2} \right] = \frac{2\delta}{3} \left[\left(\frac{9}{4}\right)^{3/2} - \left(\frac{1}{4}\right)^{3/2} \right] = \frac{2\delta}{3} \left(\frac{27}{8} - \frac{1}{8} \right) = \frac{13\delta}{6}$

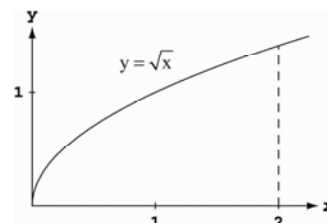

26. $y = x^3 \Rightarrow dy = 3x^2 dx \Rightarrow dx = \sqrt{(dx)^2 + (3x^2 dx)^2} = \sqrt{1 + 9x^4} dx$;
 $M_x = \delta \int_0^1 x^3 \sqrt{1 + 9x^4} dx$;
 $[u = 1 + 9x^4 \Rightarrow du = 36x^3 dx \Rightarrow \frac{1}{36} du = x^3 dx$;
 $x = 0 \Rightarrow u = 1, x = 1 \Rightarrow u = 10] \rightarrow M_x = \delta \int_1^{10} \frac{1}{36} u^{1/2} du = \frac{\delta}{36} \left[\frac{2}{3} u^{3/2} \right]_1^{10} = \frac{\delta}{54} (10^{3/2} - 1)$

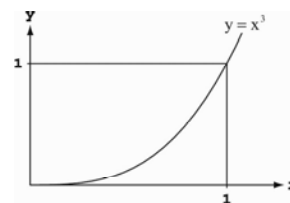

27. From Example 4 we have $M_x = \int_0^\pi a(a \sin \theta)(k \sin \theta) d\theta = a^2 k \int_0^\pi \sin^2 \theta d\theta = \frac{a^2 k}{2} \int_0^\pi (1 - \cos 2\theta) d\theta$
 $= \frac{a^2 k}{2} \left[\theta - \frac{\sin 2\theta}{2} \right]_0^\pi = \frac{a^2 k \pi}{2}$; $M_y = \int_0^\pi a(a \cos \theta)(k \sin \theta) d\theta = a^2 k \int_0^\pi \sin \theta \cos \theta d\theta = \frac{a^2 k}{2} \left[\sin^2 \theta \right]_0^\pi = 0$;
 $M = \int_0^\pi ak \sin \theta d\theta = ak [-\cos \theta]_0^\pi = 2ak$. Therefore, $\bar{x} = \frac{M_y}{M} = 0$ and $\bar{y} = \frac{M_x}{M} = \left(\frac{a^2 k \pi}{2} \right) \left(\frac{1}{2ak} \right) = \frac{a\pi}{4} \Rightarrow (0, \frac{a\pi}{4})$ is the center of mass.

28. $M_x = \int \tilde{y} dm = \int_0^\pi (a \sin \theta) \cdot \delta \cdot a d\theta = \int_0^\pi (a^2 \sin \theta)(1 + k |\cos \theta|) d\theta$

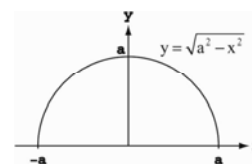

$$= a^2 \int_0^{\pi/2} (\sin \theta)(1 + k \cos \theta) d\theta + a^2 \int_{\pi/2}^\pi (\sin \theta)(1 - k \cos \theta) d\theta$$

$$= a^2 \int_0^{\pi/2} \sin \theta d\theta + a^2 k \int_0^{\pi/2} \sin \theta \cos \theta d\theta + a^2 \int_{\pi/2}^\pi \sin \theta d\theta - a^2 k \int_{\pi/2}^\pi \sin \theta \cos \theta d\theta$$

$$= a^2 [-\cos \theta]_0^{\pi/2} + a^2 k \left[\frac{\sin^2 \theta}{2} \right]_0^{\pi/2} + a^2 [-\cos \theta]_{\pi/2}^\pi - a^2 k \left[\frac{\sin^2 \theta}{2} \right]_{\pi/2}^\pi$$

$$= a^2 [0 - (-1)] + a^2 k \left(\frac{1}{2} - 0 \right) + a^2 [(-1) - 0] - a^2 k \left(0 - \frac{1}{2} \right) = a^2 + \frac{a^2 k}{2} + a^2 + \frac{a^2 k}{2} = 2a^2 + a^2 k = a^2(2 + k);$$

$$M_y = \int \tilde{x} dm = \int_0^\pi (a \cos \theta) \cdot \delta \cdot a d\theta = \int_0^\pi (a^2 \cos \theta)(1 + k |\cos \theta|) d\theta$$

$$= a^2 \int_0^{\pi/2} (\cos \theta)(1 + k \cos \theta) d\theta + a^2 \int_{\pi/2}^\pi (\cos \theta)(1 - k \cos \theta) d\theta$$

$$\begin{aligned}
 &= a^2 \int_0^{\pi/2} \cos \theta \, d\theta + a^2 k \int_0^{\pi/2} \left(\frac{1+\cos 2\theta}{2} \right) d\theta + a^2 \int_{\pi/2}^{\pi} \cos \theta \, d\theta - a^2 k \int_{\pi/2}^{\pi} \left(\frac{1+\cos 2\theta}{2} \right) d\theta \\
 &= a^2 \left[\sin \theta \right]_0^{\pi/2} + \frac{a^2 k}{2} \left[\theta + \frac{\sin 2\theta}{2} \right]_0^{\pi/2} + a^2 \left[\sin \theta \right]_{\pi/2}^{\pi} - \frac{a^2 k}{2} \left[\theta + \frac{\sin 2\theta}{2} \right]_{\pi/2}^{\pi} \\
 &= a^2 (1-0) + \frac{a^2 k}{2} \left[\left(\frac{\pi}{2} - 0 \right) - (0+0) \right] + a^2 (0-1) - \frac{a^2 k}{2} \left[(\pi+0) - \left(\frac{\pi}{2} + 0 \right) \right] = a^2 + \frac{a^2 k \pi}{4} - a^2 - \frac{a^2 k \pi}{4} = 0; \\
 M &= \int_0^{\pi} \delta \cdot a \, d\theta = a \int_0^{\pi} (1+k|\cos \theta|) \, d\theta = a \int_0^{\pi/2} (1+k \cos \theta) \, d\theta + a \int_{\pi/2}^{\pi} (1-k \cos \theta) \, d\theta \\
 &= a \left[\theta + k \sin \theta \right]_0^{\pi/2} + a \left[\theta - k \sin \theta \right]_{\pi/2}^{\pi} = \left[\left(\frac{\pi}{2} + k \right) - 0 \right] + a \left[(\pi+0) - \left(\frac{\pi}{2} - k \right) \right] = \frac{a\pi}{2} + ak + a \left(\frac{\pi}{2} + k \right) = a\pi + 2ak \\
 &= a(\pi + 2k). \text{ So } \bar{x} = \frac{M_y}{M} = 0 \text{ and } \bar{y} = \frac{M_x}{M} = \frac{a^2(2+k)}{a(\pi+2k)} = \frac{a(2+k)}{\pi+2k} \Rightarrow \left(0, \frac{2a+ka}{\pi+2k} \right) \text{ is the center of mass.}
 \end{aligned}$$

29. $f(x) = x + 6, \quad g(x) = x^2, \quad f(x) = g(x) \Rightarrow x + 6 = x^2$
 $\Rightarrow x^2 - x - 6 = 0 \Rightarrow x = 3, x = -2; \quad \delta = 1$

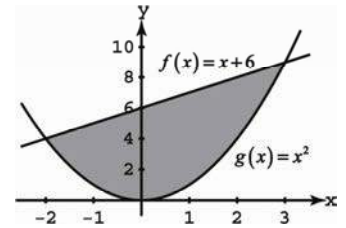

$$\begin{aligned}
 M &= \int_{-2}^3 [(x+6) - x^2] \, dx = \left[\frac{1}{2}x^2 + 6x - \frac{1}{3}x^3 \right]_{-2}^3 \\
 &= \left(\frac{9}{2} + 18 - 9 \right) - \left(2 - 12 + \frac{8}{3} \right) = \frac{125}{6} \\
 \bar{x} &= \frac{1}{125/6} \int_{-2}^3 [x(x+6) - x^2] \, dx = \frac{6}{125} \int_{-2}^3 [x^2 + 6x - x^3] \, dx = \frac{6}{125} \left[\frac{1}{3}x^3 + 3x^2 - \frac{1}{4}x^4 \right]_{-2}^3 \\
 &= \frac{6}{125} \left(9 + 27 - \frac{81}{4} \right) - \frac{6}{125} \left(-\frac{8}{3} + 12 - 4 \right) = \frac{1}{2};
 \end{aligned}$$

$$\begin{aligned}
 \bar{y} &= \frac{1}{125/6} \int_{-2}^3 \frac{1}{2} [(x+6)^2 - (x^2)^2] \, dx = \frac{3}{125} \int_{-2}^3 [x^2 + 12x + 36 - x^4] \, dx = \frac{3}{125} \left[\frac{1}{3}x^3 + 6x^2 + 36x - \frac{1}{5}x^5 \right]_{-2}^3 \\
 &= \frac{3}{125} \left(9 + 54 + 108 - \frac{243}{5} \right) - \frac{3}{125} \left(-\frac{8}{3} + 24 - 72 + \frac{32}{5} \right) = 4 \Rightarrow \left(\frac{1}{2}, 4 \right) \text{ is the center of mass.}
 \end{aligned}$$

30. $f(x) = 2, \quad g(x) = x^2(x+1), \quad f(x) = g(x) \Rightarrow 2 = x^2(x+1)$
 $\Rightarrow x^3 + x^2 - 2 = 0 \Rightarrow x = 1; \delta = 1$

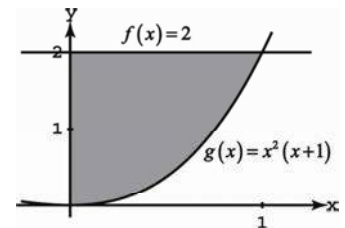

$$\begin{aligned}
 M &= \int_0^1 [2 - x^2(x+1)] \, dx = \int_0^1 [2 - x^3 - x^2] \, dx \\
 &= \left[2x - \frac{1}{4}x^4 - \frac{1}{3}x^3 \right]_0^1 = \left(2 - \frac{1}{4} - \frac{1}{3} \right) - 0 = \frac{17}{12}; \\
 \bar{x} &= \frac{1}{17/12} \int_0^1 x [2 - x^2(x+1)] \, dx = \frac{12}{17} \int_0^1 [2x - x^4 - x^3] \, dx \\
 &= \frac{12}{17} \left[x^2 - \frac{1}{5}x^5 - \frac{1}{4}x^4 \right]_0^1 = \frac{12}{17} \left(1 - \frac{1}{5} - \frac{1}{4} \right) - 0 = \frac{33}{85}; \\
 \bar{y} &= \frac{1}{17/12} \int_0^1 \frac{1}{2} [2^2 - (x^2(x+1))^2] \, dx = \frac{6}{17} \int_0^1 [4 - x^6 - 2x^5 - x^4] \, dx = \frac{6}{17} \left[4x - \frac{1}{7}x^7 - \frac{1}{3}x^6 - \frac{1}{5}x^5 \right]_0^1 \\
 &= \frac{6}{17} \left(4 - \frac{1}{7} - \frac{1}{3} - \frac{1}{5} \right) - 0 = \frac{698}{595} \Rightarrow \left(\frac{33}{85}, \frac{698}{595} \right) \text{ is the center of mass.}
 \end{aligned}$$

31. $f(x) = x^2, g(x) = x^2(x-1), f(x) = g(x)$
 $\Rightarrow x^2 = x^2(x-1) \Rightarrow x^3 - 2x^2 = 0 \Rightarrow x = 0, x = 2; \delta = 1$

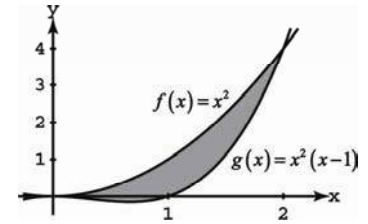

$$M = \int_0^2 [x^2 - x^2(x-1)] dx = \int_0^2 [2x^2 - x^3] dx$$

$$= \left[\frac{2}{3}x^3 - \frac{1}{4}x^4 \right]_0^2 = \left(\frac{16}{3} - 4 \right) - 0 = \frac{4}{3};$$

$$\bar{x} = \frac{1}{4/3} \int_0^2 x [x^2 - x^2(x-1)] dx = \frac{3}{4} \int_0^2 [2x^3 - x^4] dx$$

$$= \frac{3}{4} \left[\frac{1}{2}x^4 - \frac{1}{5}x^5 \right]_0^2 = \frac{3}{4} \left(8 - \frac{32}{5} \right) - 0 = \frac{6}{5};$$

$$\bar{y} = \frac{1}{4/3} \int_0^2 \frac{1}{2} \left[(x^2)^2 - (x^2(x-1))^2 \right] dx = \frac{3}{8} \int_0^2 [2x^5 - x^6] dx = \frac{3}{8} \left[\frac{1}{3}x^6 - \frac{1}{7}x^7 \right]_0^2 = \frac{3}{8} \left(\frac{64}{3} - \frac{128}{7} \right) - 0 = \frac{8}{7} \Rightarrow \left(\frac{6}{5}, \frac{8}{7} \right)$$
 is the center of mass.

32. $f(x) = 2 + \sin x, g(x) = 0, x = 0, x = 2\pi; \delta = 1;$

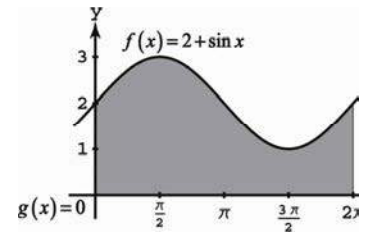

$$M = \int_0^{2\pi} [2 + \sin x] dx = [2x - \cos x]_0^{2\pi} = (4\pi - 1) - (0 - 1) = 4\pi;$$

$$\bar{x} = \frac{1}{4\pi} \int_0^{2\pi} x [2 + \sin x - 0] dx = \frac{1}{4\pi} \int_0^{2\pi} [2x + x \sin x] dx$$

$$= \frac{1}{4\pi} \int_0^{2\pi} 2x dx + \frac{1}{4\pi} \int_0^{2\pi} x \sin x dx = \frac{1}{4\pi} \left[x^2 \right]_0^{2\pi} + \frac{1}{4\pi} [\sin x - x \cos x]_0^{2\pi}$$

$$= \frac{1}{4\pi} (4\pi^2) - 0 + \frac{1}{4\pi} (0 - 2\pi) - 0 = \frac{2\pi-1}{2}; \quad \bar{y} = \frac{1}{4\pi} \int_0^{2\pi} \frac{1}{2} [(2 + \sin x)^2 - (0)^2] dx$$

$$= \frac{1}{8\pi} \left[\int_0^{2\pi} 4 + 4 \sin x + \sin^2 x \right] dx = \frac{1}{8\pi} \int_0^{2\pi} [4 + 4 \sin x] dx + \frac{1}{8\pi} \int_0^{2\pi} [\sin^2 x] dx$$

$$= \frac{1}{8\pi} \int_0^{2\pi} [4 + 4 \sin x] dx + \frac{1}{8\pi} \int_0^{2\pi} \left[\frac{1 - \cos 2x}{2} \right] dx = \frac{1}{8\pi} [4x - 4 \cos x]_0^{2\pi} + \frac{1}{16\pi} \int_0^{2\pi} dx - \frac{1}{16\pi} \int_0^{2\pi} \cos 2x dx$$

$$[u = 2x \Rightarrow du = 2dx, x = 0 \Rightarrow u = 0, x = 2\pi \Rightarrow u = 4\pi] \rightarrow \frac{1}{8\pi} [4x - 4 \cos x]_0^{2\pi} + \frac{1}{16\pi} [x]_0^{2\pi} - \frac{1}{32\pi} \int_0^{4\pi} \cos u du$$

$$= \frac{1}{8\pi} [4x - 4 \cos x]_0^{2\pi} + \frac{1}{16\pi} [x]_0^{2\pi} - \frac{1}{32\pi} [\sin u]_0^{4\pi} = \frac{1}{8\pi} (8\pi - 4) - \frac{1}{8\pi} (0 - 4) + \frac{1}{16\pi} (2\pi) - 0 - 0 = \frac{9}{8} \Rightarrow \left(\frac{2\pi-1}{2}, \frac{9}{8} \right)$$
 is the center of mass.

33. Consider the curve as an infinite number of line segments joined together. From the derivation of arc length we have that the length of a particular segment is $ds = \sqrt{(dx)^2 + (dy)^2}$. This implies that $M_x = \int \delta y ds, M_y = \int \delta x ds$ and $M = \int \delta ds$. If δ is constant, then $\bar{x} = \frac{M_y}{M} = \frac{\int x ds}{\int ds} = \frac{\int x ds}{\text{length}}$ and $\bar{y} = \frac{M_x}{M} = \frac{\int y ds}{\int ds} = \frac{\int y ds}{\text{length}}$.

34. Applying the symmetry argument analogous to the one used in Exercise 1, we find that $\bar{x} = 0$. The typical vertical

strip has center of mass: $(\tilde{x}, \tilde{y}) = \left(x, \frac{a+x^2}{2} \right)$, length: $a - \frac{x^2}{4p}$, width: dx , area: $dA = \left(a - \frac{x^2}{4p} \right) dx$,

mass: $dm = \delta dA = \delta \left(a - \frac{x^2}{4p} \right) dx$. Thus, $M_x = \int \tilde{y} dm = \int_{-2\sqrt{pa}}^{2\sqrt{pa}} \frac{1}{2} \left(a + \frac{x^2}{4p} \right) \left(a - \frac{x^2}{4p} \right) \delta dx$

$$= \frac{\delta}{2} \int_{-2\sqrt{pa}}^{2\sqrt{pa}} \left(a^2 - \frac{x^4}{16p^2} \right) dx = \frac{\delta}{2} \left[a^2 x - \frac{x^5}{80p^2} \right]_{-2\sqrt{pa}}^{2\sqrt{pa}} = 2 \cdot \frac{\delta}{2} \left[a^2 x - \frac{x^5}{80p^2} \right]_0^{2\sqrt{pa}} = \delta \left(2a^2 \sqrt{pa} - \frac{2^5 p^2 a^2 \sqrt{pa}}{80p^2} \right)$$

$$\begin{aligned}
 &= 2a^2 \delta \sqrt{pa} \left(1 - \frac{16}{80}\right) = 2a^2 \delta \sqrt{pa} \left(\frac{80-16}{80}\right) = 2a^2 \delta \sqrt{pa} \left(\frac{64}{80}\right) = \frac{8a^2 \delta \sqrt{pa}}{5}; \quad M = \int dm = \int_{-2\sqrt{pa}}^{2\sqrt{pa}} \delta \left(a - \frac{x^2}{4p}\right) dx \\
 &= \delta \left[ax - \frac{x^3}{12p} \right]_{-2\sqrt{pa}}^{2\sqrt{pa}} = 2 \cdot \delta \left[ax - \frac{x^3}{12p} \right]_0^{2\sqrt{pa}} = 2\delta \left(2a\sqrt{pa} - \frac{2^3 pa \sqrt{pa}}{12p} \right) = 4a\delta \sqrt{pa} \left(1 - \frac{4}{12}\right) = 4a\delta \sqrt{pa} \left(\frac{12-4}{12}\right) \\
 &= \frac{8a\delta \sqrt{pa}}{3}. \text{ So } \bar{y} = \frac{M_x}{M} = \left(\frac{8a^2 \delta \sqrt{pa}}{5}\right) \left(\frac{3}{8a\delta \sqrt{pa}}\right) = \frac{3}{5} a, \text{ as claimed}
 \end{aligned}$$

35. The centroid of the square is located at (2, 2). The volume is $V = (2\pi)(\bar{y})(A) = (2\pi)(2)(8) = 32\pi$ and the surface area is $S = (2\pi)(\bar{y})(L) = (2\pi)(2)(4\sqrt{8}) = 32\sqrt{2}\pi$ (where $\sqrt{8}$ is the length of a side).

36. The midpoint of the hypotenuse of the triangle is $\left(\frac{3}{2}, 3\right) \Rightarrow y = 2x$ is an equation of the median \Rightarrow the line $y = 2x$ contains the centroid. The point $\left(\frac{3}{2}, 3\right)$ is $\frac{3\sqrt{5}}{2}$ units from the origin \Rightarrow the x -coordinate of the centroid

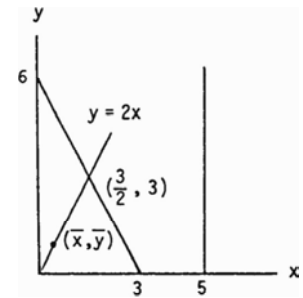

solves the equation $\sqrt{\left(x - \frac{3}{2}\right)^2 + (2x - 3)^2} = \frac{\sqrt{5}}{2}$

$$\Rightarrow \left(x^2 - 3x + \frac{9}{4}\right) + (4x^2 - 12x + 9) = \frac{5}{4}$$

$$\Rightarrow 5x^2 - 15x + 9 = -1 \Rightarrow x^2 - 3x + 2 = (x - 2)(x - 1) = 0 \Rightarrow \bar{x} = 1 \text{ since the centroid must lie inside the triangle}$$

$$\Rightarrow \bar{y} = 2. \text{ By the Theorem of Pappus, the volume is } V = (\text{distance traveled by the centroid})(\text{area of the region})$$

$$= 2\pi(5 - \bar{x}) \left[\frac{1}{2}(3)(6) \right] = (2\pi)(4)(9) = 72\pi$$

37. The centroid is located at (2, 0) $\Rightarrow V = (2\pi)(\bar{x})(A) = (2\pi)(2)(\pi) = 4\pi^2$

38. We create the cone by revolving the triangle with vertices (0, 0), (h, r) and (h, 0) about the x -axis (see the accompanying figure). Thus, the cone has height h and base radius r . By Theorem of Pappus, the lateral surface area swept out by the hypotenuse L is given by $S = 2\pi \bar{y} L = 2\pi \left(\frac{r}{2}\right) \sqrt{h^2 + r^2} = \pi r \sqrt{r^2 + h^2}$. To calculate the volume we need the position of the centroid of the triangle. From the diagram we see that the centroid lies on the

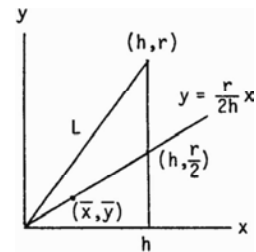

line $y = \frac{r}{2h}x$. The x -coordinate of the centroid solves the equation $\sqrt{(x-h)^2 + \left(\frac{r}{2h}x - \frac{r}{2}\right)^2} = \frac{1}{3} \sqrt{h^2 + \frac{r^2}{4}}$

$$\Rightarrow \left(\frac{4h^2+r^2}{4h^2}\right)x^2 - \left(\frac{4h^2+r^2}{2h}\right)x + \frac{r^2}{4} + \frac{2(r^2+4h^2)}{9} = 0 \Rightarrow x = \frac{2h}{3} \text{ or } \frac{4h}{3} \Rightarrow \bar{x} = \frac{2h}{3}, \text{ since the centroid must lie inside the}$$

$$\text{triangle } \Rightarrow \bar{y} = \frac{r}{2h} \bar{x} = \frac{r}{3}. \text{ By the Theorem of Pappus, } V = \left[2\pi \left(\frac{r}{3}\right) \right] \left(\frac{1}{2}hr\right) = \frac{1}{3} \pi r^2 h.$$

39. $S = 2\pi \bar{y} L \Rightarrow 4\pi a^2 = (2\pi \bar{y})(\pi a) \Rightarrow \bar{y} = \frac{2a}{\pi}$, and by symmetry $\bar{x} = 0$

40. $S = 2\pi \rho L \Rightarrow \left[2\pi \left(a - \frac{2a}{\pi}\right) \right] (\pi a) = 2\pi a^2 (\pi - 2)$

41. $V = 2\pi \bar{y} A \Rightarrow \frac{4}{3} \pi ab^2 = (2\pi \bar{y}) \left(\frac{\pi ab}{2}\right) \Rightarrow \bar{y} = \frac{4b}{3\pi}$ and by symmetry $\bar{x} = 0$

42. $V = 2\pi \rho A \Rightarrow V = \left[2\pi \left(a + \frac{4a}{3\pi} \right) \right] \left(\frac{\pi a^2}{2} \right) = \frac{\pi a^3 (3\pi + 4)}{3}$

43. $V = 2\pi \rho A = (2\pi)$ (area of the region) (distance from the centroid to the line $y = x - a$). We must find the distance from $\left(0, \frac{4a}{3\pi} \right)$ to $y = x - a$. The line containing the centroid and perpendicular to $y = x - a$ has slope -1 and contains the point $\left(0, \frac{4a}{3\pi} \right)$. This line is $y = -x + \frac{4a}{3\pi}$. The intersection of $y = x - a$ and $y = -x + \frac{4a}{3\pi}$ is the point $\left(\frac{4a+3a\pi}{6\pi}, \frac{4a-3a\pi}{6\pi} \right)$. Thus, the distance from the centroid to the line $y = x - a$ is

$$\sqrt{\left(\frac{4a+3a\pi}{6\pi} \right)^2 + \left(\frac{4a}{3\pi} - \frac{4a-3a\pi}{6\pi} \right)^2} = \frac{\sqrt{2}(4a+3a\pi)}{6\pi} \Rightarrow V = (2\pi) \left(\frac{\sqrt{2}(4a+3a\pi)}{6\pi} \right) \left(\frac{\pi a^2}{2} \right) = \frac{\sqrt{2}\pi a^3 (4+3\pi)}{6}$$

44. The line perpendicular to $y = x - a$ and passing through the centroid $\left(0, \frac{2a}{\pi} \right)$ has equation $y = -x + \frac{2a}{\pi}$. The intersection of the two perpendicular lines occurs when $x - a = -x + \frac{2a}{\pi} \Rightarrow x = \frac{2a+a\pi}{2\pi} \Rightarrow x = \frac{2a+a\pi}{2\pi}$

$$\Rightarrow y = \frac{2a-a\pi}{2\pi}. \text{ Thus the distance from the centroid to the line } y = x - a \text{ is } \sqrt{\left(\frac{2a+a\pi}{2} - 0 \right)^2 + \left(\frac{2a-a\pi}{2} - \frac{2a}{2} \right)^2} = \frac{a(2+\pi)}{\sqrt{2}\pi}. \text{ Therefore, by the Theorem of Pappus the surface area is } S = 2\pi \left[\frac{a(2+\pi)}{\sqrt{2}\pi} \right] (\pi a) = \sqrt{2}\pi a^2 (2+\pi).$$

45. If we revolve the region about the y -axis: $r = a, h = b \Rightarrow A = \frac{1}{2}ab, V = \frac{1}{3}\pi a^2 b$, and $\rho = \bar{x}$. By the Theorem of Pappus: $\frac{1}{3}\pi a^2 b = 2\pi \bar{x} \left(\frac{1}{2}ab \right) \Rightarrow \bar{x} = \frac{a}{3}$; If we revolve the region about the x -axis:

$r = b, h = a \Rightarrow A = \frac{1}{2}ab, V = \frac{1}{3}\pi b^2 a$, and $\rho = \bar{y}$. By the Theorem of Pappus:

$$\frac{1}{3}\pi b^2 a = 2\pi \bar{y} \left(\frac{1}{2}ab \right) \Rightarrow \bar{y} = \frac{b}{3} \Rightarrow \left(\frac{a}{3}, \frac{b}{3} \right) \text{ is the center of mass.}$$

46. Let $O(0, 0), P(a, c)$, and $Q(a, b)$ be the vertices of the given triangle. If we revolve the region about the x -axis: Let R be the point $R(a, 0)$. The volume is given by the volume of the outer cone, radius = $RP = c$, minus the volume of the inner cone, radius = $RQ = b$, thus $V = \frac{1}{3}\pi c^2 a - \frac{1}{3}\pi b^2 a = \frac{1}{3}\pi a(c^2 - b^2)$, the area is given by the area of triangle OPR minus area of triangle OQR , $A = \frac{1}{2}ac - \frac{1}{2}ab = \frac{1}{2}a(c - b)$, and $\rho = \bar{y}$. By the Theorem of Pappus: $\frac{1}{3}\pi a(c^2 - b^2) = 2\pi \bar{y} \left[\frac{1}{2}a(c - b) \right] \Rightarrow \bar{y} = \frac{c+b}{3}$; If we revolve the region about the y -axis: Let S and T be the points $S(0, c)$ and $T(0, b)$, respectively. Then the volume is the volume of the cylinder with radius $OR = a$ and height $RP = c$, minus the sum of the volumes of the cone with radius = $SP = a$ and height = $OS = c$ and the portion of the cylinder with height = $OT = b$ and radius = $TQ = a$ with a cone of height = $OT = b$ and radius = $TQ = a$ removed. Thus

$$V = \pi a^2 c - \left[\frac{1}{3}\pi a^2 c + \left(\pi a^2 b - \frac{1}{3}\pi a^2 b \right) \right] = \frac{2}{3}\pi a^2 c - \frac{2}{3}\pi a^2 b = \frac{2}{3}\pi a^2 (a - b). \text{ The area of the triangle is the same as before, } A = \frac{1}{2}ac - \frac{1}{2}ab = \frac{1}{2}a(c - b), \text{ and } \rho = \bar{x}. \text{ By the Theorem of Pappus:}$$

$$\frac{2}{3}\pi a^2 (a - b) = 2\pi \bar{x} \left[\frac{1}{2}a(c - b) \right] \Rightarrow \bar{x} = \frac{2a(a-b)}{3(c-b)} \Rightarrow \left(\frac{2a(a-b)}{3(c-b)}, \frac{c+b}{2} \right) \text{ is the center of mass.}$$

CHAPTER 6 PRACTICE EXERCISES

$$\begin{aligned}
 1. \quad A(x) &= \frac{\pi}{4}(\text{diameter})^2 = \frac{\pi}{4}(\sqrt{x} - x^2)^2 \\
 &= \frac{\pi}{4}(x - 2\sqrt{x} \cdot x^2 + x^4); \quad a = 0, b = 1 \\
 \Rightarrow V &= \int_a^b A(x) dx = \frac{\pi}{4} \int_0^1 [x - 2x^{5/2} + x^4] dx \\
 &= \frac{\pi}{4} \left[\frac{x^2}{2} - \frac{4}{7} x^{7/2} + \frac{x^5}{5} \right]_0^1 = \frac{\pi}{4} \left(\frac{1}{2} - \frac{4}{7} + \frac{1}{5} \right) \\
 &= \frac{\pi}{4 \cdot 70} (35 - 40 + 14) = \frac{9\pi}{280}
 \end{aligned}$$

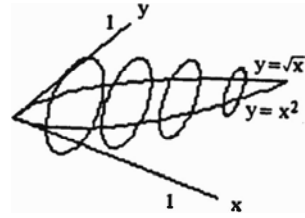

$$\begin{aligned}
 2. \quad A(x) &= \frac{1}{2}(\text{side})^2 \left(\sin \frac{\pi}{3} \right) = \frac{\sqrt{3}}{4} (2\sqrt{x} - x)^2 \\
 &= \frac{\sqrt{3}}{4} (4x - 4x\sqrt{x} + x^2); \quad a = 0, b = 4 \\
 \Rightarrow V &= \int_a^b A(x) dx = \frac{\sqrt{3}}{4} \int_0^4 (4x - 4x^{3/2} + x^2) dx \\
 &= \frac{\sqrt{3}}{4} \left[2x^2 - \frac{8}{5} x^{5/2} + \frac{x^3}{3} \right]_0^4 = \frac{\sqrt{3}}{4} \left(32 - \frac{8 \cdot 32}{5} + \frac{64}{3} \right) \\
 &= \frac{32\sqrt{3}}{4} \left(1 - \frac{8}{5} + \frac{2}{3} \right) = \frac{8\sqrt{3}}{15} (15 - 24 + 10) = \frac{8\sqrt{3}}{15}
 \end{aligned}$$

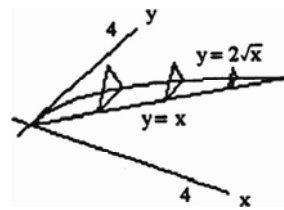

$$\begin{aligned}
 3. \quad A(x) &= \frac{\pi}{4}(\text{diameter})^2 = \frac{\pi}{4} (2 \sin x - 2 \cos x)^2 \\
 &= \frac{\pi}{4} (4 \sin^2 x - 4 \sin x \cos x + 4 \cos^2 x) = \pi (1 - \sin 2x); \\
 a &= \frac{\pi}{4}, b = \frac{5\pi}{4} \Rightarrow V = \int_a^b A(x) dx \\
 &= \pi \int_{\pi/4}^{5\pi/4} (1 - \sin 2x) dx = \pi \left[x + \frac{\cos 2x}{2} \right]_{\pi/4}^{5\pi/4} \\
 &= \pi \left[\left(\frac{5\pi}{4} + \frac{\cos 5\pi}{2} \right) - \left(\frac{\pi}{4} + \frac{\cos \pi}{2} \right) \right] = \pi^2
 \end{aligned}$$

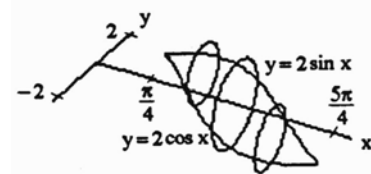

$$\begin{aligned}
 4. \quad A(x) &= (\text{edge})^2 = \left((\sqrt{6} - \sqrt{x})^2 - 0 \right)^2 = (\sqrt{6} - \sqrt{x})^4 = 36 - 24\sqrt{6}\sqrt{x} + 36x - 4\sqrt{6}x^{3/2} + x^2; \quad a = 0, b = 6 \Rightarrow V \\
 &= \int_a^b A(x) dx = \int_0^6 (36 - 24\sqrt{6}\sqrt{x} + 36x - 4\sqrt{6}x^{3/2} + x^2) dx = \left[36x - 24\sqrt{6} \cdot \frac{2}{3} x^{3/2} + 18x^2 - 4\sqrt{6} \cdot \frac{2}{5} x^{5/2} + \frac{x^3}{3} \right]_0^6 \\
 &= 216 - 16 \cdot \sqrt{6} \sqrt{6} \cdot 6 + 18 \cdot 6^2 - \frac{8}{5} \sqrt{6} \sqrt{6} \cdot 6^2 + \frac{6^3}{3} = 216 - 576 + 648 - \frac{1728}{5} + 72 = 360 - \frac{1728}{5} = \frac{1800 - 1728}{5} = \frac{72}{5}
 \end{aligned}$$

$$\begin{aligned}
 5. \quad A(x) &= \frac{\pi}{4}(\text{diameter})^2 = \frac{\pi}{4} \left(2\sqrt{x} - \frac{x^2}{4} \right)^2 = \frac{\pi}{4} \left(4x - x^{5/2} + \frac{x^4}{16} \right); \quad a = 0, b = 4 \Rightarrow V = \int_a^b A(x) dx \\
 &= \frac{\pi}{4} \int_0^4 \left(4x - x^{5/2} + \frac{x^4}{16} \right) dx = \frac{\pi}{4} \left[2x^2 - \frac{2}{7} x^{7/2} + \frac{x^5}{5 \cdot 16} \right]_0^4 = \frac{\pi}{4} \left(32 - 32 \cdot \frac{8}{7} + \frac{2}{5} \cdot 32 \right) = \frac{32\pi}{4} \left(1 - \frac{8}{7} + \frac{2}{5} \right) \\
 &= \frac{8\pi}{35} (35 - 40 + 14) = \frac{72\pi}{35}
 \end{aligned}$$

6. $A(x) = \frac{1}{2}(\text{edge})^2 \sin\left(\frac{\pi}{3}\right) = \frac{\sqrt{3}}{4} [2\sqrt{x} - (-2\sqrt{x})]^2$
 $= \frac{\sqrt{3}}{4} (4\sqrt{x})^2 = 4\sqrt{3}x; \quad a = 0, b = 1$
 $\Rightarrow V = \int_a^b A(x) dx = \int_0^1 4\sqrt{3}x dx = [2\sqrt{3}x^2]_0^1 = 2\sqrt{3}$

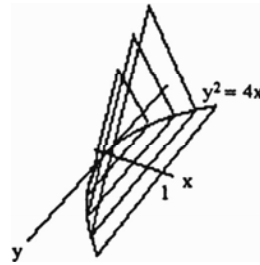

7. (a) *disk method:*
 $V = \int_a^b \pi [R(x)]^2 dx = \int_{-1}^1 \pi (3x^4)^2 dx$
 $= \pi \int_{-1}^1 9x^8 dx = \pi [x^9]_{-1}^1 = 2\pi$

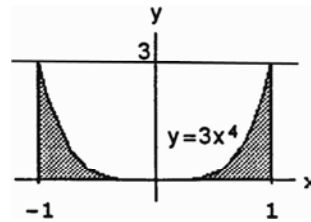

(b) *shell method:*
 $V = \int_a^b 2\pi \left(\frac{\text{shell radius}}{\text{radius}}\right) \left(\frac{\text{shell height}}{\text{height}}\right) dx = \int_0^1 2\pi x (3x^4) dx = 2\pi \cdot 3 \int_0^1 x^5 dx = 2\pi \cdot 3 \left[\frac{x^6}{6}\right]_0^1 = \pi$

Note: The lower limit of integration is 0 rather than -1.

(c) *shell method:*
 $V = \int_a^b 2\pi \left(\frac{\text{shell radius}}{\text{radius}}\right) \left(\frac{\text{shell height}}{\text{height}}\right) dx = 2\pi \int_{-1}^1 (1-x)(3x^4) dx = 2\pi \left[\frac{3x^3}{5} - \frac{x^6}{2}\right]_{-1}^1 = 2\pi \left[\left(\frac{3}{5} - \frac{1}{2}\right) - \left(-\frac{3}{5} - \frac{1}{2}\right)\right] = \frac{12\pi}{5}$

(d) *washer method:*
 $R(x) = 3, r(x) = 3 - 3x^4 = 3(1 - x^4) \Rightarrow V = \int_a^b \pi ([R(x)]^2 - [r(x)]^2) dx = \int_{-1}^1 \pi [9 - 9(1 - x^4)^2] dx$
 $= 9\pi \int_{-1}^1 [1 - (1 - 2x^4 + x^8)] dx = 9\pi \int_{-1}^1 (2x^4 - x^8) dx = 9\pi \left[\frac{2x^5}{5} - \frac{x^9}{9}\right]_{-1}^1 = 18\pi \left[\frac{2}{5} - \frac{1}{9}\right] = \frac{2\pi \cdot 13}{5} = \frac{26\pi}{5}$

8. (a) *washer method:*
 $R(x) = \frac{4}{x^3}, r(x) = \frac{1}{2} \Rightarrow V = \int_a^b \pi ([R(x)]^2 - [r(x)]^2) dx = \int_1^2 \pi \left[\left(\frac{4}{x^3}\right)^2 - \left(\frac{1}{2}\right)^2\right] dx = \pi \left[-\frac{16}{5}x^{-5} - \frac{x}{4}\right]_1^2$
 $= \pi \left[\left(-\frac{16}{5 \cdot 32} - \frac{1}{2}\right) - \left(-\frac{16}{5} - \frac{1}{4}\right)\right] = \pi \left(-\frac{1}{10} - \frac{1}{2} + \frac{16}{5} + \frac{1}{4}\right) = \frac{\pi}{20}(-2 - 10 + 64 + 5) = \frac{57\pi}{20}$

(b) *shell method:*
 $V = 2\pi \int_1^2 x \left(\frac{4}{x^3} - \frac{1}{2}\right) dx = 2\pi \left[-4x^{-1} - \frac{x^2}{4}\right]_1^2 = 2\pi \left[\left(-\frac{4}{2} - 1\right) - \left(-4 - \frac{1}{4}\right)\right] = 2\pi \left(\frac{5}{4}\right) = \frac{5\pi}{2}$

(c) *shell method:*
 $V = 2\pi \int_a^b \left(\frac{\text{shell radius}}{\text{radius}}\right) \left(\frac{\text{shell height}}{\text{height}}\right) dx = 2\pi \int_1^2 (2-x) \left(\frac{4}{x^3} - \frac{1}{2}\right) dx = 2\pi \int_1^2 \left(\frac{8}{x^3} - \frac{4}{x^2} - 1 + \frac{x}{2}\right) dx$
 $= 2\pi \left[-\frac{4}{x^2} + \frac{4}{x} - x + \frac{x^2}{4}\right]_1^2 = 2\pi \left[(-1 + 2 - 2 + 1) - (-4 + 4 - 1 + \frac{1}{4})\right] = \frac{3\pi}{2}$

(d) washer method:

$$\begin{aligned}
 V &= \int_a^b \pi \left([R(x)]^2 - [r(x)]^2 \right) dx \\
 &= \pi \int_1^2 \left[\left(\frac{7}{2} \right)^2 - \left(4 - \frac{4}{x^3} \right)^2 \right] dx \\
 &= \frac{49\pi}{4} - 16\pi \int_1^2 \left(1 - 2x^{-3} + x^{-6} \right) dx \\
 &= \frac{49\pi}{4} - 16\pi \left[x + x^{-2} - \frac{x^{-5}}{5} \right]_1^2 \\
 &= \frac{49\pi}{4} - 16\pi \left[\left(2 + \frac{1}{4} - \frac{1}{532} \right) - \left(1 + 1 - \frac{1}{5} \right) \right] = \frac{49\pi}{4} - 16\pi \left(\frac{1}{4} - \frac{1}{160} + \frac{1}{5} \right) = \frac{49\pi}{4} - \frac{16\pi}{160} (40 - 1 + 32) = \frac{49\pi}{4} - \frac{71\pi}{10} \\
 &= \frac{103\pi}{20}
 \end{aligned}$$

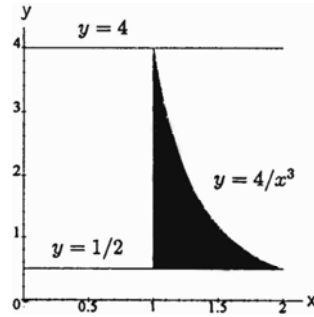

9. (a) disk method:

$$V = \pi \int_1^5 (\sqrt{x-1})^2 dx = \pi \int_1^5 (x-1) dx = \pi \left[\frac{x^2}{2} - x \right]_1^5 = \pi \left[\left(\frac{25}{2} - 5 \right) - \left(\frac{1}{2} - 1 \right) \right] = \pi \left(\frac{24}{2} - 4 \right) = 8\pi$$

(b) washer method:

$$\begin{aligned}
 R(y) &= 5, r(y) = y^2 + 1 \Rightarrow V = \int_c^d \pi \left([R(y)]^2 - [r(y)]^2 \right) dy = \pi \int_{-2}^2 \left[25 - (y^2 + 1)^2 \right] dy \\
 &= \pi \int_{-2}^2 (25 - y^4 - 2y^2 - 1) dy = \pi \int_{-2}^2 (24 - y^4 - 2y^2) dy = \pi \left[24y - \frac{y^5}{5} - \frac{2}{3}y^3 \right]_{-2}^2 \\
 &= 2\pi \left(24 \cdot 2 - \frac{32}{5} - \frac{2}{3} \cdot 8 \right) = 32\pi \left(3 - \frac{2}{5} - \frac{1}{3} \right) = \frac{32\pi}{15} (45 - 6 - 5) = \frac{1088\pi}{15}
 \end{aligned}$$

(c) disk method:

$$\begin{aligned}
 R(y) &= 5 - (y^2 + 1) = 4 - y^2 \\
 \Rightarrow V &= \int_c^d \pi [R(y)]^2 dy = \int_{-2}^2 \pi (4 - y^2)^2 dy \\
 &= \pi \int_{-2}^2 (16 - 8y^2 + y^4) dy = \pi \left[16y - \frac{8y^3}{3} + \frac{y^5}{5} \right]_{-2}^2 \\
 &= 2\pi \left(32 - \frac{64}{3} + \frac{32}{5} \right) = 64\pi \left(1 - \frac{2}{3} + \frac{1}{5} \right) \\
 &= \frac{64\pi}{15} (15 - 10 + 3) = \frac{512\pi}{15}
 \end{aligned}$$

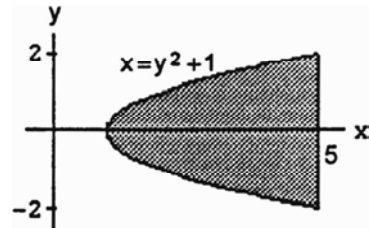

10. (a) shell method:

$$\begin{aligned}
 V &= \int_c^d 2\pi \left(\text{shell radius} \right) \left(\text{shell height} \right) dy \\
 &= \int_0^4 2\pi y \left(y - \frac{y^2}{4} \right) dy = 2\pi \int_0^4 \left(y^2 - \frac{y^3}{4} \right) dy \\
 &= 2\pi \left[\frac{y^3}{3} - \frac{y^4}{16} \right]_0^4 = 2\pi \left(\frac{64}{3} - \frac{64}{4} \right) = \frac{2\pi}{12} \cdot 64 = \frac{32\pi}{3}
 \end{aligned}$$

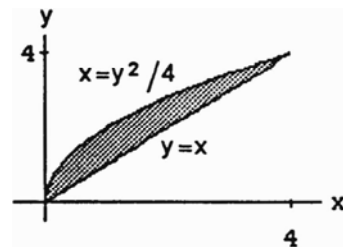

(b) *shell method:*

$$V = \int_a^b 2\pi \left(\begin{array}{c} \text{shell} \\ \text{radius} \end{array} \right) \left(\begin{array}{c} \text{shell} \\ \text{height} \end{array} \right) dx = \int_0^4 2\pi x(2\sqrt{x} - x) dx = 2\pi \int_0^4 (2x^{3/2} - x^2) dx = 2\pi \left[\frac{4}{5}x^{5/2} - \frac{x^3}{3} \right]_0^4$$

$$= 2\pi \left(\frac{4}{5} \cdot 32 - \frac{64}{3} \right) = \frac{128\pi}{15}$$

(c) *shell method:*

$$V = \int_a^b 2\pi \left(\begin{array}{c} \text{shell} \\ \text{radius} \end{array} \right) \left(\begin{array}{c} \text{shell} \\ \text{height} \end{array} \right) dx = \int_0^4 2\pi(4-x)(2\sqrt{x} - x) dx = 2\pi \int_0^4 (8x^{1/2} - 4x - 2x^{3/2} + x^2) dx$$

$$= 2\pi \left[\frac{16}{3}x^{3/2} - 2x^2 - \frac{4}{5}x^{5/2} + \frac{x^3}{3} \right]_0^4 = 2\pi \left(\frac{16}{3} \cdot 8 - 32 - \frac{4}{5} \cdot 32 + \frac{64}{3} \right) = 64\pi \left(\frac{4}{3} - 1 - \frac{4}{5} + \frac{2}{3} \right) = 64\pi \left(1 - \frac{4}{5} \right) = \frac{64\pi}{5}$$

(d) *shell method:*

$$V = \int_c^d 2\pi \left(\begin{array}{c} \text{shell} \\ \text{radius} \end{array} \right) \left(\begin{array}{c} \text{shell} \\ \text{height} \end{array} \right) dy = \int_0^4 2\pi(4-y) \left(y - \frac{y^2}{4} \right) dy = 2\pi \int_0^4 \left(4y - y^2 - y^2 + \frac{y^3}{4} \right) dy$$

$$= 2\pi \int_0^4 \left(4y - 2y^2 + \frac{y^3}{4} \right) dy = 2\pi \left[2y^2 - \frac{2}{3}y^3 + \frac{y^4}{16} \right]_0^4 = 2\pi \left(32 - \frac{2}{3} \cdot 64 + 16 \right) = 32\pi \left(2 - \frac{8}{3} + 1 \right) = \frac{32\pi}{3}$$

11. *disk method:*

$$R(x) = \tan x, a = 0, b = \frac{\pi}{3} \Rightarrow V = \pi \int_0^{\pi/3} \tan^2 x dx = \pi \int_0^{\pi/3} (\sec^2 x - 1) dx = \pi [\tan x - x]_0^{\pi/3} = \frac{\pi(3\sqrt{3} - \pi)}{3}$$

12. *disk method:*

$$V = \pi \int_0^{\pi} (2 - \sin x)^2 dx = \pi \int_0^{\pi} (4 - 4\sin x + \sin^2 x) dx = \pi \int_0^{\pi} \left(4 - 4\sin x + \frac{1 - \cos 2x}{2} \right) dx$$

$$= \pi \left[4x + 4\cos x + \frac{x}{2} - \frac{\sin 2x}{4} \right]_0^{\pi} = \pi \left[\left(4\pi - 4 + \frac{\pi}{2} - 0 \right) - (0 + 4 + 0 - 0) \right] = \pi \left(\frac{9\pi}{2} - 8 \right) = \frac{\pi}{2} (9\pi - 16)$$

13. (a) *disk method:*

$$V = \pi \int_0^2 (x^2 - 2x)^2 dx = \pi \int_0^2 (x^4 - 4x^3 + 4x^2) dx = \pi \left[\frac{x^5}{5} - x^4 + \frac{4}{3}x^3 \right]_0^2 = \pi \left(\frac{32}{5} - 16 + \frac{32}{3} \right)$$

$$= \frac{16\pi}{15} (6 - 15 + 10) = \frac{16\pi}{15}$$

(b) *washer method:*

$$V = \int_0^2 \pi \left[1^2 - (x^2 - 2x + 1)^2 \right] dx = \int_0^2 \pi dx - \int_0^2 \pi(x-1)^4 dx = 2\pi - \left[\pi \frac{(x-1)^5}{5} \right]_0^2 = 2\pi - \pi \cdot \frac{2}{5} = \frac{8\pi}{5}$$

(c) *shell method:*

$$V = \int_a^b 2\pi \left(\begin{array}{c} \text{shell} \\ \text{radius} \end{array} \right) \left(\begin{array}{c} \text{shell} \\ \text{height} \end{array} \right) dx = 2\pi \int_0^2 (2-x) \left[-(x^2 - 2x) \right] dx = 2\pi \int_0^2 (2-x)(2x - x^2) dx$$

$$= 2\pi \int_0^2 (4x - 2x^2 - 2x^2 + x^3) dx = 2\pi \int_0^2 (x^3 - 4x^2 + 4x) dx = 2\pi \left[\frac{x^4}{4} - \frac{4}{3}x^3 + 2x^2 \right]_0^2 = 2\pi \left(4 - \frac{32}{3} + 8 \right)$$

$$= \frac{2\pi}{3} (36 - 32) = \frac{8\pi}{3}$$

(d) *washer method:*

$$V = \pi \int_0^2 \left[2 - (x^2 - 2x) \right]^2 dx - \pi \int_0^2 2^2 dx = \pi \int_0^2 \left[4 - 4(x^2 - 2x) + (x^2 - 2x)^2 \right] dx - 8\pi$$

$$= \pi \int_0^2 (4 - 4x^2 + 8x + x^4 - 4x^3 + 4x^2) dx - 8\pi = \pi \int_0^2 (x^4 - 4x^3 + 8x + 4) dx - 8\pi$$

$$= \pi \left[\frac{x^5}{5} - x^4 + 4x^2 + 4x \right]_0^2 - 8\pi = \pi \left(\frac{32}{5} - 16 + 16 + 8 \right) - 8\pi = \frac{\pi}{5} (32 + 40) - 8\pi = \frac{72\pi}{5} - \frac{40\pi}{5} = \frac{32\pi}{5}$$

14. *disk method:*

$$V = 2\pi \int_0^{\pi/4} 4 \tan^2 x \, dx = 8\pi \int_0^{\pi/4} (\sec^2 x - 1) \, dx = 8\pi [\tan x - x]_0^{\pi/4} = 2\pi(4 - \pi)$$

15. The material removed from the sphere consists of a cylinder and two “caps.” From the diagram, the height of the cylinder is $2h$, where $h^2 + (\sqrt{3})^2 = 2^2$, i.e. $h = 1$. Thus

$$\begin{aligned} V_{\text{cyl}} &= (2h)\pi(\sqrt{3})^2 = 6\pi \text{ ft}^3. \text{ To get the volume of a cap,} \\ \text{use the disk method and } x^2 + y^2 &= 2^2: V_{\text{cap}} = \int_1^2 \pi x^2 \, dy \\ &= \int_1^2 \pi(4 - y^2) \, dy = \pi \left[4y - \frac{y^3}{3} \right]_1^2 = \pi \left[\left(8 - \frac{8}{3} \right) - \left(4 - \frac{1}{3} \right) \right] \\ &= \frac{5\pi}{3} \text{ ft}^3. \text{ Therefore, } V_{\text{removed}} = V_{\text{cyl}} + 2V_{\text{cap}} = 6\pi + \frac{10\pi}{3} \\ &= \frac{28\pi}{3} \text{ ft}^3. \end{aligned}$$

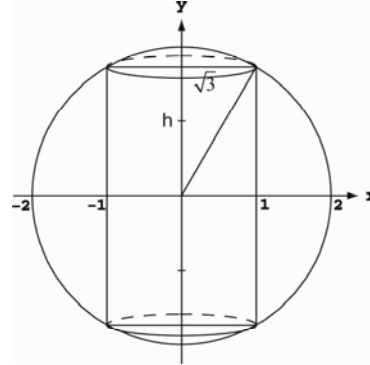

16. We rotate the region enclosed by the curve $y = \sqrt{12\left(1 - \frac{4x^2}{121}\right)}$ and the x -axis around the x -axis. To find the

$$\begin{aligned} \text{volume we use the } \textit{disk} \text{ method: } V &= \int_a^b \pi [R(x)]^2 \, dx = \int_{-11/2}^{11/2} \pi \left(\sqrt{12\left(1 - \frac{4x^2}{121}\right)} \right)^2 \, dx = \pi \int_{-11/2}^{11/2} 12\left(1 - \frac{4x^2}{121}\right) \, dx \\ &= 12\pi \int_{-11/2}^{11/2} \left(1 - \frac{4x^2}{121}\right) \, dx = 12\pi \left[x - \frac{4x^3}{363} \right]_{-11/2}^{11/2} = 24\pi \left[\frac{11}{2} - \left(\frac{4}{363} \right) \left(\frac{11}{2} \right)^3 \right] = 132\pi \left[1 - \left(\frac{4}{363} \right) \left(\frac{11^2}{4} \right) \right] = 132\pi \left(1 - \frac{1}{3} \right) \\ &= \frac{264\pi}{3} = 88\pi \approx 276 \text{ in}^3 \end{aligned}$$

$$\begin{aligned} 17. \quad y &= x^{1/2} - \frac{x^{3/2}}{3} \Rightarrow \frac{dy}{dx} = \frac{1}{2}x^{-1/2} - \frac{1}{2}x^{1/2} \Rightarrow \left(\frac{dy}{dx} \right)^2 = \frac{1}{4} \left(\frac{1}{x} - 2 + x \right) \Rightarrow L = \int_1^4 \sqrt{1 + \frac{1}{4} \left(\frac{1}{x} - 2 + x \right)} \, dx \\ &\Rightarrow L = \int_1^4 \sqrt{\frac{1}{4} \left(\frac{1}{x} + 2 + x \right)} \, dx = \int_1^4 \sqrt{\frac{1}{4} \left(x^{-1/2} + x^{1/2} \right)^2} \, dx = \int_1^4 \frac{1}{2} \left(x^{-1/2} + x^{1/2} \right) \, dx = \frac{1}{2} \left[2x^{1/2} + \frac{2}{3}x^{3/2} \right]_1^4 \\ &= \frac{1}{2} \left[\left(4 + \frac{2}{3} \cdot 8 \right) - \left(2 + \frac{2}{3} \right) \right] = \frac{1}{2} \left(2 + \frac{14}{3} \right) = \frac{10}{3} \end{aligned}$$

$$\begin{aligned} 18. \quad x &= y^{2/3} \Rightarrow \frac{dx}{dy} = \frac{2}{3}y^{-1/3} \Rightarrow \left(\frac{dx}{dy} \right)^2 = \frac{4y^{-2/3}}{9} \Rightarrow L = \int_1^8 \sqrt{1 + \left(\frac{dx}{dy} \right)^2} \, dy = \int_1^8 \sqrt{1 + \frac{4}{9y^{2/3}}} \, dy = \int_1^8 \frac{\sqrt{9y^{2/3} + 4}}{3y^{1/3}} \, dy \\ &= \frac{1}{3} \int_1^8 \sqrt{9y^{2/3} + 4} \left(y^{-1/3} \right) \, dy; \quad [u = 9y^{2/3} + 4 \Rightarrow du = 6y^{-1/3} \, dy; \quad y = 1 \Rightarrow u = 13, \quad y = 8 \Rightarrow u = 40] \\ &\rightarrow L = \frac{1}{18} \int_{13}^{40} u^{1/2} \, du = \frac{1}{18} \left[\frac{2}{3} u^{3/2} \right]_{13}^{40} = \frac{1}{27} \left[40^{3/2} - 13^{3/2} \right] \approx 7.634 \end{aligned}$$

$$\begin{aligned} 19. \quad y &= x^2 - \frac{\ln x}{8} \Rightarrow y' = 2x - \frac{1}{8x} \\ &\Rightarrow \sqrt{1 + (y')^2} = \sqrt{1 + \left(2x - \frac{1}{8x} \right)^2} = \sqrt{\frac{256x^4 + 32x^2 + 1}{64x^2}} = \sqrt{\frac{(16x^2 + 1)^2}{(8x)^2}} = \frac{16x^2 + 1}{8x} = 2x + \frac{1}{8x} \\ &\Rightarrow \text{Length} = \int_1^2 \sqrt{1 + (y')^2} \, dx = \int_1^2 \left(2x + \frac{1}{8x} \right) \, dx = \left(x^2 + \frac{1}{8} \ln x \right) \Big|_1^2 = \left(4 + \frac{1}{8} \ln 2 \right) - \left(1 + \frac{1}{8} \ln 1 \right) = 3 + \frac{1}{8} \ln 2 \end{aligned}$$

$$\begin{aligned}
 20. \quad x &= \frac{1}{12}y^3 + \frac{1}{y} \Rightarrow \frac{dx}{dy} = \frac{1}{4}y^2 - \frac{1}{y^2} \Rightarrow \left(\frac{dx}{dy}\right)^2 = \frac{1}{16}y^4 - \frac{1}{2} + \frac{1}{y^4} \Rightarrow L = \int_1^2 \sqrt{1 + \left(\frac{1}{16}y^4 - \frac{1}{2} + \frac{1}{y^4}\right)} dy \\
 &= \int_1^2 \sqrt{\frac{1}{16}y^4 + \frac{1}{2} + \frac{1}{y^4}} dy = \int_1^2 \sqrt{\left(\frac{1}{4}y^2 + \frac{1}{y^2}\right)^2} dy = \int_1^2 \left(\frac{1}{4}y^2 + \frac{1}{y^2}\right) dy = \left[\frac{1}{12}y^3 - \frac{1}{y}\right]_1^2 \\
 &= \left(\frac{8}{12} - \frac{1}{2}\right) - \left(\frac{1}{12} - 1\right) = \frac{7}{12} + \frac{1}{2} = \frac{13}{12}
 \end{aligned}$$

$$\begin{aligned}
 21. \quad S &= \int_a^b 2\pi y \sqrt{1 + \left(\frac{dy}{dx}\right)^2} dx; \quad \frac{dy}{dx} = \frac{1}{\sqrt{2x+1}} \Rightarrow \left(\frac{dy}{dx}\right)^2 = \frac{1}{2x+1} \Rightarrow S = \int_0^3 2\pi \sqrt{2x+1} \sqrt{1 + \frac{1}{2x+1}} dx \\
 &= 2\pi \int_0^3 \sqrt{2x+1} \sqrt{\frac{2x+2}{2x+1}} dx = 2\sqrt{2}\pi \int_0^3 \sqrt{x+1} dx = 2\sqrt{2}\pi \left[\frac{2}{3}(x+1)^{3/2}\right]_0^3 = 2\sqrt{2}\pi \cdot \frac{2}{3}(8-1) = \frac{28\pi\sqrt{2}}{3}
 \end{aligned}$$

$$\begin{aligned}
 22. \quad S &= \int_a^b 2\pi y \sqrt{1 + \left(\frac{dy}{dx}\right)^2} dx; \quad \frac{dy}{dx} = x^2 \Rightarrow \left(\frac{dy}{dx}\right)^2 = x^4 \Rightarrow S = \int_0^1 2\pi \cdot \frac{x^3}{3} \sqrt{1+x^4} dx = \frac{\pi}{6} \int_0^1 \sqrt{1+x^4} (4x^3) dx \\
 &= \frac{\pi}{6} \left[\frac{2}{3}(1+x^4)^{3/2}\right]_0^1 = \frac{\pi}{9}(2\sqrt{2}-1)
 \end{aligned}$$

$$\begin{aligned}
 23. \quad S &= \int_c^d 2\pi x \sqrt{1 + \left(\frac{dx}{dy}\right)^2} dy; \quad \frac{dx}{dy} = \frac{(\frac{1}{2})(4-2y)}{\sqrt{4y-y^2}} = \frac{2-y}{\sqrt{4y-y^2}} \Rightarrow 1 + \left(\frac{dx}{dy}\right)^2 = \frac{4y-y^2+4-4y+y^2}{4y-y^2} = \frac{4}{4y-y^2} \\
 \Rightarrow S &= \int_1^2 2\pi \sqrt{4y-y^2} \sqrt{\frac{4}{4y-y^2}} dy = 4\pi \int_1^2 dx = 4\pi
 \end{aligned}$$

$$\begin{aligned}
 24. \quad S &= \int_c^d 2\pi x \sqrt{1 + \left(\frac{dx}{dy}\right)^2} dy; \quad \frac{dx}{dy} = \frac{1}{2\sqrt{y}} \Rightarrow 1 + \left(\frac{dx}{dy}\right)^2 = 1 + \frac{1}{4y} = \frac{4y+1}{4y} \Rightarrow S = \int_2^6 2\pi \sqrt{y} \cdot \frac{\sqrt{4y+1}}{\sqrt{4y}} dy = \pi \int_2^6 \sqrt{4y+1} dy \\
 &= \frac{\pi}{4} \left[\frac{2}{3}(4y+1)^{3/2}\right]_2^6 = \frac{\pi}{6}(125-27) = \frac{\pi}{6}(98) = \frac{49\pi}{3}
 \end{aligned}$$

25. The equipment alone: the force required to lift the equipment is equal to its weight $\Rightarrow F_1(x) = 100 \text{ N}$. The work done is $W_1 = \int_a^b F_1(x) dx = \int_0^{40} 100 dx = [100x]_0^{40} = 4000 \text{ J}$; the rope alone: the force required to lift the rope is equal to the weight of the rope paid out at elevation $x \Rightarrow F_2(x) = 0.8(40-x)$. The work done is $W_2 = \int_a^b F_2(x) dx = \int_0^{40} 0.8(40-x) dx = 0.8 \left[40x - \frac{x^2}{2}\right]_0^{40} = 0.8 \left(40^2 - \frac{40^2}{2}\right) = \frac{(0.8)(1600)}{2} = 640 \text{ J}$; the total work is $W = W_1 + W_2 = 4000 + 640 = 4640 \text{ J}$

26. The force required to lift the water is equal to the water's weight, which varies steadily from $8 \cdot 800 \text{ lb}$ to $8 \cdot 400 \text{ lb}$ over the 4750 ft elevation. When the truck is $x \text{ ft}$ off the base of Mt. Washington, the water weight is $F(x) = 8 \cdot 800 \cdot \left(\frac{2 \cdot 4750 - x}{2 \cdot 4750}\right) = (6400) \left(1 - \frac{x}{9500}\right) \text{ lb}$. The work done is $W = \int_a^b F(x) dx = \int_0^{4750} 6400 \left(1 - \frac{x}{9500}\right) dx = 6400 \left[x - \frac{x^2}{2 \cdot 9500}\right]_0^{4750} = 6400 \left(4750 - \frac{4750^2}{4 \cdot 4750}\right) = \left(\frac{3}{4}\right)(6400)(4750) = 22,800,000 \text{ ft}\cdot\text{lb}$

27. Using a proportionality constant of 1, the work in lifting the weight of $w \text{ lb}$ from $r-a$ to a is $\int_{r-a}^a wt dt = w \left[\frac{t^2}{2}\right]_{r-a}^a = \frac{w}{2} (r^2 - (r-a)^2) = \frac{w}{2} (2ar - a^2)$.

28. Force constant: $F = kx \Rightarrow 200 = k(0.8) \Rightarrow k = 250 \text{ N/m}$; the 300 N force stretches the spring

$$x = \frac{F}{k} = \frac{300}{250} = 1.2 \text{ m}; \text{ the work required to stretch the spring that far is then } W = \int_0^{1.2} F(x) dx = \int_0^{1.2} 250x dx$$

$$= \int_0^{1.2} 250x dx = \left[125x^2 \right]_0^{1.2} = 125(1.2)^2 = 180 \text{ J}$$

29. We imagine the water divided into thin slabs by planes perpendicular to the y -axis at the points of a partition of the interval $[0, 8]$. The typical slab between the planes at y and $y + \Delta y$ has a volume of about

$$\Delta V = \pi(\text{radius})^2(\text{thickness}) = \pi\left(\frac{5}{4}y\right)^2 \Delta y = \frac{25\pi}{16} y^2 \Delta y \text{ ft}^3.$$

The force $F(y)$ required to lift this slab is equal to its weight: $F(y) = 62.4\Delta V$

$= \frac{(62.4)(25)}{16} \pi y^2 \Delta y \text{ lb}$. The distance through which $F(y)$ must act to lift this slab to the level 6 ft above the top is about $(6 + 8 - y)$ ft, so the work done lifting the slab is about $\Delta W = \frac{(62.4)(25)}{16} \pi y^2 (14 - y) \Delta y \text{ ft} \cdot \text{lb}$. The work done lifting all the slabs from $y = 0$ to $y = 8$ to the level 6 ft above the top is approximately

$$W \approx \sum_0^8 \frac{(62.4)(25)}{16} \pi y^2 (14 - y) \Delta y \text{ ft} \cdot \text{lb} \text{ so the work to pump the water is the limit of these Riemann sums as}$$

$$\text{the norm of the partition goes to zero: } W = \int_0^8 \frac{(62.4)(25)}{16} \pi y^2 (14 - y) dy = \frac{(62.4)(25)\pi}{16} \int_0^8 (14y^2 - y^3) dy$$

$$= (62.4) \left(\frac{25\pi}{16} \right) \left[\frac{14}{3} y^3 - \frac{y^4}{4} \right]_0^8 = (62.4) \left(\frac{25\pi}{16} \right) \left(\frac{14}{3} \cdot 8^3 - \frac{8^4}{4} \right) \approx 418,208.81 \text{ ft} \cdot \text{lb}$$

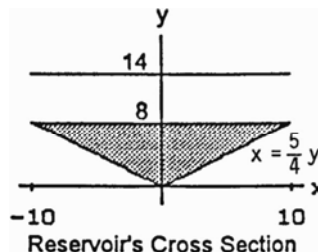

30. The same as in Exercise 29, but change the distance through which $F(y)$ must act to $(8 - y)$ rather than $(6 + 8 - y)$. Also change the upper limit of integration from 8 to 5. The integral is:

$$W = \int_0^5 \frac{(62.4)(25)\pi}{16} y^2 (8 - y) dy = (62.4) \left(\frac{25\pi}{16} \right) \int_0^5 (8y^2 - y^3) dy = (62.4) \left(\frac{25\pi}{16} \right) \left[\frac{8}{3} y^3 - \frac{y^4}{4} \right]_0^5$$

$$= (62.4) \left(\frac{25\pi}{16} \right) \left(\frac{8}{3} \cdot 5^3 - \frac{5^4}{4} \right) \approx 54,241.56 \text{ ft} \cdot \text{lb}$$

31. The tank's cross section looks like the figure in Exercise 29 with right edge given by $x = \frac{5}{10}y = \frac{y}{2}$. A typical horizontal slab has volume $\Delta V = \pi(\text{radius})^2(\text{thickness}) = \pi\left(\frac{y}{2}\right)^2 \Delta y = \frac{\pi}{4} y^2 \Delta y$. The force required to lift this slab is its weight: $F(y) = 60 \cdot \frac{\pi}{4} y^2 \Delta y$. The distance through which $F(y)$ must act is $(2 + 10 - y)$ ft, so the

$$\text{work to pump the liquid is } W = 60 \int_0^{10} \pi(12 - y) \left(\frac{y^2}{4} \right) dy = 15\pi \left[\frac{12y^3}{3} - \frac{y^4}{4} \right]_0^{10} = 22,500\pi \text{ ft} \cdot \text{lb}; \text{ the time needed}$$

$$\text{to empty the tank is } \frac{22,500\pi \text{ ft} \cdot \text{lb}}{275 \text{ ft} \cdot \text{lb}/\text{sec}} \approx 257 \text{ sec}$$

32. A typical horizontal slab has volume about $\Delta V = (20)(2x)\Delta y = (20)\left(2\sqrt{16 - y^2}\right)\Delta y$ and the force required to lift this slab is its weight $F(y) = (57)(20)\left(2\sqrt{16 - y^2}\right)\Delta y$. The distance through which $F(y)$ must act is $(6 + 4 - y)$ ft, so the work to pump the olive oil from the half-full tank is

$$\begin{aligned}
 W &= 57 \int_{-4}^0 (10-y)(20) \left(2\sqrt{16-y^2} \right) dy = 2880 \int_{-4}^0 10\sqrt{16-y^2} dy + 1140 \int_{-4}^0 (16-y^2)^{1/2} (-2y) dy \\
 &= 22,800 \cdot (\text{area of a quarter circle having radius 4}) + \frac{2}{3}(1140) \left[(16-y^2)^{3/2} \right]_{-4}^0 = (22,800)(4\pi) + 48,640 \\
 &= 335,153.25 \text{ ft}\cdot\text{lb}
 \end{aligned}$$

33. Intersection points: $3-x^2 = 2x^2 \Rightarrow 3x^2 - 3 = 0$
 $\Rightarrow 3(x-1)(x+1) = 0 \Rightarrow x = -1$ or $x = 1$. Symmetry suggests that $\bar{x} = 0$. The typical vertical strip has center of

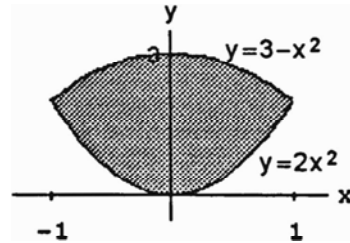

mass: $(\tilde{x}, \tilde{y}) = \left(x, \frac{2x^2 + (3-x^2)}{2} \right) = \left(x, \frac{x^2 + 3}{2} \right)$,

length: $(3-x^2) - 2x^2 = 3(1-x^2)$, width: dx ,

area: $dA = 3(1-x^2) dx$, and mass: $dm = \delta \cdot dA = 3\delta(1-x^2) dx \Rightarrow$ the moment about the x -axis is

$$\begin{aligned}
 \tilde{y} dm &= \frac{3}{2} \delta (x^2 + 3)(1-x^2) dx = \frac{3}{2} \delta (-x^4 - 2x^2 + 3) dx \Rightarrow M_x = \int \tilde{y} dm = \frac{3}{2} \delta \int_{-1}^1 (-x^4 - 2x^2 + 3) dx \\
 &= \frac{3}{2} \delta \left[-\frac{x^5}{5} - \frac{2x^3}{3} + 3x \right]_{-1}^1 = 3\delta \left(-\frac{1}{5} - \frac{2}{3} + 3 \right) = \frac{32\delta}{15} (-3 - 10 + 45) = \frac{32\delta}{5}; \quad M = \int dm = 3\delta \int_{-1}^1 (1-x^2) dx \\
 &= 3\delta \left[x - \frac{x^3}{3} \right]_{-1}^1 = 6\delta \left(1 - \frac{1}{3} \right) = 4\delta \Rightarrow \bar{y} = \frac{M_x}{M} = \frac{32\delta}{5 \cdot 4\delta} = \frac{8}{5}. \text{ Therefore, the centroid is } (\bar{x}, \bar{y}) = \left(0, \frac{8}{5} \right).
 \end{aligned}$$

34. Symmetry suggests that $\bar{x} = 0$. The typical vertical strip has center of mass: $(\tilde{x}, \tilde{y}) = \left(x, \frac{x^2}{2} \right)$, length: x^2 , width: dx ,

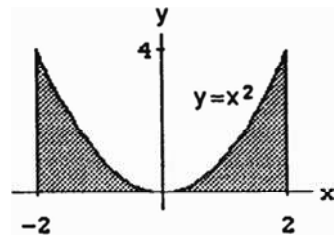

area: $dA = x^2 dx$, mass: $dm = \delta \cdot dA = \delta x^2 dx \Rightarrow$ the moment about the x -axis is $\tilde{y} dm = \frac{\delta}{2} x^2 \cdot x^2 dx$

$$= \frac{\delta}{2} x^4 dx \Rightarrow M_x = \int \tilde{y} dm = \frac{\delta}{2} \int_{-2}^2 x^4 dx = \frac{\delta}{10} [x^5]_{-2}^2$$

35. The typical vertical strip has: center of mass: (\tilde{x}, \tilde{y})

$= \left(x, \frac{4 + \frac{x^2}{4}}{2} \right)$, length: $4 - \frac{x^2}{4}$, width: dx ,

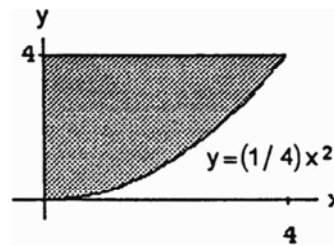

area: $dA = \left(4 - \frac{x^2}{4} \right) dx$, mass: $dm = \delta \cdot dA$

$= \delta \left(4 - \frac{x^2}{4} \right) dx \Rightarrow$ the moment about the x -axis is

$\tilde{y} dm = \delta \cdot \frac{\left(4 + \frac{x^2}{4} \right)}{2} \left(4 - \frac{x^2}{4} \right) dx = \frac{\delta}{2} \left(16 - \frac{x^4}{16} \right) dx$; moment about: $\tilde{x} dm = \delta \left(4 - \frac{x^2}{4} \right) \cdot x dx = \delta \left(4x - \frac{x^3}{4} \right) dx$.

Thus, $M_x = \int \tilde{y} dm = \frac{\delta}{2} \int_0^4 \left(16 - \frac{x^4}{16} \right) dx = \frac{\delta}{2} \left[16x - \frac{x^5}{5 \cdot 16} \right]_0^4 = \frac{\delta}{2} \left[64 - \frac{64}{5} \right] = \frac{128\delta}{5}$; $M_y = \int \tilde{x} dm$

$= \delta \int_0^4 \left(4x - \frac{x^3}{4} \right) dx = \delta \left[2x^2 - \frac{x^4}{16} \right]_0^4 = \delta(32 - 16) = 16\delta$; $M = \int dm = \delta \int_0^4 \left(4 - \frac{x^2}{4} \right) dx = \delta \left[4x - \frac{x^3}{12} \right]_0^4$

$= \delta \left(16 - \frac{64}{12} \right) = \frac{32\delta}{3} \Rightarrow \bar{x} = \frac{M_y}{M} = \frac{16 \cdot \delta \cdot 3}{32 \cdot \delta} = \frac{3}{2}$ and $\bar{y} = \frac{M_x}{M} = \frac{128 \cdot \delta \cdot 3}{5 \cdot 32 \cdot \delta} = \frac{12}{5}$. Centroid is $(\bar{x}, \bar{y}) = \left(\frac{3}{2}, \frac{12}{5} \right)$.

36. A typical horizontal strip has: center of mass:
 $(\tilde{x}, \tilde{y}) = \left(\frac{y^2+2y}{2}, y\right)$, length: $2y - y^2$, width: dy ,
 area: $dA = (2y - y^2) dy$, mass: $dm = \delta \cdot dA$
 $= \delta(2y - y^2) dy$; the moment about the x -axis
 is $\tilde{y} dm = \delta \cdot y \cdot (2y - y^2) dy = \delta(2y^2 - y^3) dy$;

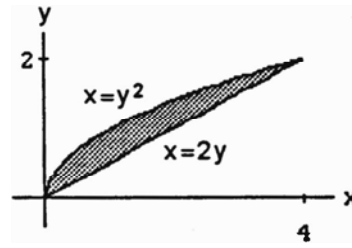

the moment about the y -axis is $\tilde{x} dm = \delta \cdot \frac{(y^2+2y)}{2} \cdot (2y - y^2) dy = \frac{\delta}{2}(4y^2 - y^4) dy \Rightarrow M_x = \int \tilde{y} dm$
 $= \delta \int_0^2 (2y^2 - y^3) dy = \delta \left[\frac{2}{3}y^3 - \frac{y^4}{4} \right]_0^2 = \delta \left(\frac{2}{3} \cdot 8 - \frac{16}{4} \right) = \delta \left(\frac{16}{3} - \frac{16}{4} \right) = \frac{\delta \cdot 16}{12} = \frac{4\delta}{3}$; $M_y = \int \tilde{x} dm$
 $= \frac{\delta}{2} \int_0^2 (4y^2 - y^4) dy = \frac{\delta}{2} \left[\frac{4}{3}y^3 - \frac{y^5}{5} \right]_0^2 = \frac{\delta}{2} \left(\frac{48}{3} - \frac{32}{5} \right) = \frac{32\delta}{15}$; $M = \int dm = \delta \int_0^2 (2y - y^2) dy = \delta \left[y^2 - \frac{y^3}{3} \right]_0^2$
 $= \delta \left(4 - \frac{8}{3} \right) = \frac{4\delta}{3} \Rightarrow \bar{x} = \frac{M_y}{M} = \frac{\delta \cdot 32 \cdot 3}{15 \cdot \delta \cdot 4} = \frac{8}{5}$ and $\bar{y} = \frac{M_x}{M} = \frac{4 \cdot \delta \cdot 3}{3 \cdot 4 \cdot \delta} = 1$. Therefore, the centroid is $(\bar{x}, \bar{y}) = \left(\frac{8}{5}, 1\right)$.

37. A typical horizontal strip has: center of mass:
 $(\tilde{x}, \tilde{y}) = \left(\frac{y^2+2y}{2}, y\right)$, length: $2y - y^2$, width: dy ,
 area: $dA = (2y - y^2) dy$, mass: $dm = \delta \cdot dA$
 $= (1+y)(2y - y^2) dy \Rightarrow$ the moment about the
 x -axis is $\tilde{y} dm = y(1+y)(2y - y^2) dy$

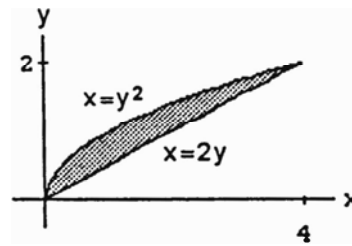

$= (2y^2 + 2y^3 - y^3 - y^4) dy = (2y^2 + y^3 - y^4) dy$; the moment about the y -axis is
 $\tilde{x} dm = \left(\frac{y^2+2y}{2}\right)(1+y)(2y - y^2) dy = \frac{1}{2}(4y^2 - y^4)(1+y) dy = \frac{1}{2}(4y^2 + 4y^3 - y^4 - y^5) dy \Rightarrow M_x = \int \tilde{y} dm$
 $= \int_0^2 (2y^2 + y^3 - y^4) dy = \left[\frac{2}{3}y^3 + \frac{y^4}{4} - \frac{y^5}{5} \right]_0^2 = \left(\frac{16}{3} + \frac{16}{4} - \frac{32}{5} \right) = 16 \left(\frac{1}{3} + \frac{1}{4} - \frac{2}{5} \right) = \frac{16}{60} (20 + 15 - 24) = \frac{4}{15} (11) = \frac{44}{15}$;
 $M_y = \int \tilde{x} dm = \int_0^2 \frac{1}{2} (4y^2 + 4y^3 - y^4 - y^5) dy = \frac{1}{2} \left[\frac{4}{3}y^3 + y^4 - \frac{y^5}{5} - \frac{y^6}{6} \right]_0^2 = \frac{1}{2} \left(\frac{4 \cdot 2^3}{3} + 2^4 - \frac{2^5}{5} - \frac{2^6}{6} \right)$
 $= 4 \left(\frac{4}{3} + 2 - \frac{4}{5} - \frac{8}{6} \right) = 4 \left(2 - \frac{4}{5} \right) = \frac{24}{5}$; $M = \int dm = \int_0^2 (1+y)(2y - y^2) dy = \int_0^2 (2y + y^2 - y^3) dy$
 $= \left[y^2 + \frac{y^3}{3} - \frac{y^4}{4} \right]_0^2 = \left(4 + \frac{8}{3} - \frac{16}{4} \right) = \frac{8}{3} \Rightarrow \bar{x} = \frac{M_y}{M} = \left(\frac{24}{5} \right) \left(\frac{3}{8} \right) = \frac{9}{5}$ and $\bar{y} = \frac{M_x}{M} = \left(\frac{44}{15} \right) \left(\frac{3}{8} \right) = \frac{44}{40} = \frac{11}{10}$. Therefore,
 the center of mass is $(\bar{x}, \bar{y}) = \left(\frac{9}{5}, \frac{11}{10}\right)$.

38. A typical vertical strip has: center of mass: $(\tilde{x}, \tilde{y}) = \left(x, \frac{3}{2x^{3/2}}\right)$, length: $\frac{3}{x^{3/2}}$, width: dx , area: $dA = \frac{3}{x^{3/2}} dx$,
 mass: $dm = \delta \cdot dA = \delta \cdot \frac{3}{x^{3/2}} dx \Rightarrow$ the moment about the x -axis is $\tilde{y} dm = \frac{3}{2x^{3/2}} \cdot \delta \cdot \frac{3}{x^{3/2}} dx = \frac{9\delta}{2x^3} dx$; the moment
 about the y -axis is $\tilde{x} dm = x \cdot \delta \cdot \frac{3}{x^{3/2}} dx = \frac{3\delta}{x^{1/2}} dx$.

$$(a) \quad M_x = \delta \int_1^9 \frac{1}{2} \left(\frac{9}{x^3} \right) dx = \frac{9\delta}{2} \left[-\frac{x^{-2}}{2} \right]_1^9 = \frac{20\delta}{9}; \quad M_y = \delta \int_1^9 x \left(\frac{3}{x^{3/2}} \right) dx = 3\delta \left[2x^{1/2} \right]_1^9 = 12\delta;$$

$$M = \delta \int_1^9 \frac{3}{x^{3/2}} dx = -6\delta \left[x^{-1/2} \right]_1^9 = 4\delta \Rightarrow \bar{x} = \frac{M_y}{M} = \frac{12\delta}{4\delta} = 3 \quad \text{and} \quad \bar{y} = \frac{M_x}{M} = \frac{\left(\frac{20\delta}{9}\right)}{4\delta} = \frac{5}{9}$$

$$(b) \quad M_x = \int_1^9 \frac{x}{2} \left(\frac{9}{x^3} \right) dx = \frac{9}{2} \left[-\frac{1}{x} \right]_1^9 = 4; \quad M_y = \int_1^9 x^2 \left(\frac{3}{x^{3/2}} \right) dx = \left[2x^{3/2} \right]_1^9 = 52; \quad M = \int_1^9 x \left(\frac{3}{x^{3/2}} \right) dx = 6 \left[x^{1/2} \right]_1^9 = 12 \Rightarrow \bar{x} = \frac{M_y}{M} = \frac{13}{3} \quad \text{and} \quad \bar{y} = \frac{M_x}{M} = \frac{1}{3}$$

$$39. \quad F = \int_a^b W \cdot \left(\frac{\text{strip}}{\text{depth}} \right) \cdot L(y) dy \Rightarrow F = 2 \int_0^2 (62.4)(2-y)(2y) dy = 249.6 \int_0^2 (2y - y^2) dy = 249.6 \left[y^2 - \frac{y^3}{3} \right]_0^2 = (249.6) \left(4 - \frac{8}{3} \right) = (249.6) \left(\frac{4}{3} \right) = 332.8 \text{ lb}$$

$$40. \quad F = \int_a^b W \cdot \left(\frac{\text{strip}}{\text{depth}} \right) \cdot L(y) dy \Rightarrow F = \int_0^{5/6} 75 \left(\frac{5}{6} - y \right) (2y + 4) dy = 75 \int_0^{5/6} \left(\frac{5}{3}y + \frac{10}{3} - 2y^2 - 4y \right) dy = 75 \int_0^{5/6} \left(\frac{10}{3}y - \frac{7}{3}y^2 - 2y^2 \right) dy = 75 \left[\frac{10}{3}y - \frac{7}{6}y^2 - \frac{2}{3}y^3 \right]_0^{5/6} = (75) \left[\left(\frac{50}{18} \right) - \left(\frac{7}{6} \right) \left(\frac{25}{36} \right) - \left(\frac{2}{3} \right) \left(\frac{125}{216} \right) \right] = (75) \left(\frac{25}{9} - \frac{175}{216} - \frac{250}{3 \cdot 216} \right) = \left(\frac{75}{9 \cdot 216} \right) (25 \cdot 216 - 175 \cdot 9 - 250 \cdot 3) = \frac{(75)(3075)}{9 \cdot 216} \approx 118.63 \text{ lb.}$$

$$41. \quad F = \int_a^b W \cdot \left(\frac{\text{strip}}{\text{depth}} \right) \cdot L(y) dy \Rightarrow F = 62.4 \int_0^4 (9-y) \left(2 \cdot \frac{\sqrt{y}}{2} \right) dy = 62.4 \int_0^4 (9y^{1/2} - 3y^{3/2}) dy = 62.4 \left[6y^{3/2} - \frac{2}{5}y^{5/2} \right]_0^4 = (62.4) \left(6 \cdot 8 - \frac{2}{5} \cdot 32 \right) = \left(\frac{62.4}{5} \right) (48 \cdot 5 - 64) = \frac{(62.4)(176)}{5} = 2196.48 \text{ lb}$$

42. Place the origin at the bottom of the tank. Then $F = \int_0^h W \cdot \left(\frac{\text{strip}}{\text{depth}} \right) \cdot L(y) dy$, h = the height of the mercury column, strip depth = $h - y$, $L(y) = 1 \Rightarrow F = \int_0^h 849(h-y) \cdot 1 dy = 849 \int_0^h (h-y) dy = 849 \left[hy - \frac{y^2}{2} \right]_0^h = 849 \left(h^2 - \frac{h^2}{2} \right) = \frac{849}{2} h^2$. Now solve $\frac{849}{2} h^2 = 40000$ to get $h \approx 9.707$ ft. The volume of the mercury is $s^2 h = 1^2 \cdot 9.707 = 9.707 \text{ ft}^3$.

CHAPTER 6 ADDITIONAL AND ADVANCED EXERCISES

$$1. \quad V = \pi \int_a^b [f(x)]^2 dx = b^2 - ab \Rightarrow \pi \int_a^x [f(t)]^2 dt = x^2 - ax \quad \text{for all } x > a \Rightarrow \pi [f(x)]^2 = 2x - a \Rightarrow f(x) = \sqrt{\frac{2x-a}{\pi}}$$

$$2. \quad V = \pi \int_0^a [f(x)]^2 dx = a^2 + a \Rightarrow \pi \int_a^x [f(t)]^2 dt = x^2 + x \quad \text{for all } x > a \Rightarrow \pi [f(x)]^2 = 2x + 1 \Rightarrow f(x) = \frac{\sqrt{2x+1}}{\pi}$$

$$3. \quad s(x) = Cx \Rightarrow \int_0^x \sqrt{1+[f'(t)]^2} dt = Cx \Rightarrow \sqrt{1+[f'(x)]^2} = C \Rightarrow f'(x) = \sqrt{C^2-1} \quad \text{for } C \geq 1 \Rightarrow f(x) = \int_0^x \sqrt{C^2-1} dt + k. \quad \text{Then } f(0) = a \Rightarrow a = 0 + k \Rightarrow f(x) = \int_0^x \sqrt{C^2-1} dt + a \Rightarrow f(x) = x\sqrt{C^2-1} + a, \quad \text{where } C \geq 1.$$

4. (a) The graph of $f(x) = \sin x$ traces out a path from $(0, 0)$ to $(\alpha, \sin \alpha)$ whose length is

$$L = \int_0^\alpha \sqrt{1 + \cos^2 \theta} d\theta. \text{ The line segment from } (0, 0) \text{ to } (\alpha, \sin \alpha) \text{ has length}$$

$\sqrt{(\alpha - 0)^2 + (\sin \alpha - 0)^2} = \sqrt{\alpha^2 + \sin^2 \alpha}$. Since the shortest distance between two points is the length of the straight line segment joining them, we have immediately that

$$\int_0^\alpha \sqrt{1 + \cos^2 \theta} d\theta > \sqrt{\alpha^2 + \sin^2 \alpha} \text{ if } 0 < \alpha \leq \frac{\pi}{2}.$$

- (b) In general, if $y = f(x)$ is continuously differentiable and $f(0) = 0$, then

$$\int_0^\alpha \sqrt{1 + [f'(t)]^2} dt > \sqrt{\alpha^2 + f^2(\alpha)} \text{ for } \alpha > 0.$$

5. We can find the centroid and then use Pappus' Theorem to calculate the volume. $f(x) = x$, $g(x) = x^2$,

$$f(x) = g(x) \Rightarrow x = x^2 \Rightarrow x^2 - x = 0 \Rightarrow x = 0, x = 1; \delta = 1; M = \int_0^1 (x - x^2) dx = \left[\frac{1}{2}x^2 - \frac{1}{3}x^3 \right]_0^1$$

$$= \left(\frac{1}{2} - \frac{1}{3} \right) - 0 = \frac{1}{6}; \bar{x} = \frac{1}{1/6} \int_0^1 x(x - x^2) dx = 6 \int_0^1 (x^2 - x^3) dx = 6 \left[\frac{1}{3}x^3 - \frac{1}{4}x^4 \right]_0^1 = 6 \left(\frac{1}{3} - \frac{1}{4} \right) - 0 = \frac{1}{2};$$

$$\bar{y} = \frac{1}{1/6} \int_0^1 \frac{1}{2} \left[x^2 - (x^2)^2 \right] dx = 3 \int_0^1 (x^2 - x^4) dx = 3 \left[\frac{1}{3}x^3 - \frac{1}{5}x^5 \right]_0^1 = 3 \left(\frac{1}{3} - \frac{1}{5} \right) - 0 = \frac{2}{3} \Rightarrow \text{The centroid is } \left(\frac{1}{2}, \frac{2}{3} \right).$$

ρ is the distance from $\left(\frac{1}{2}, \frac{2}{3} \right)$ to the axis of rotation, $y = x$. To calculate this distance we must find the point on $y = x$ that also lies on the line perpendicular to $y = x$ that passes through $\left(\frac{1}{2}, \frac{2}{3} \right)$. The equation of this line is $y - \frac{2}{3} = -1 \left(x - \frac{1}{2} \right) \Rightarrow x + y = \frac{9}{10}$. The point of intersection of the lines $x + y = \frac{9}{10}$ and $y = x$ is $\left(\frac{9}{20}, \frac{9}{20} \right)$.

$$\text{Thus, } \rho = \sqrt{\left(\frac{9}{10} - \frac{1}{2} \right)^2 + \left(\frac{9}{20} - \frac{2}{3} \right)^2} = \frac{1}{10\sqrt{2}}. \text{ Thus } V = 2\pi \left(\frac{1}{10\sqrt{2}} \right) \left(\frac{1}{6} \right) = \frac{\pi}{30\sqrt{2}}.$$

6. Since the slice is made at an angle of 45° , the volume of the wedge is half the volume of the cylinder of radius

$$\frac{1}{2} \text{ and height 1. Thus, } V = \frac{1}{2} \left[\pi \left(\frac{1}{2} \right)^2 (1) \right] = \frac{\pi}{8}.$$

$$7. y = 2\sqrt{x} \Rightarrow ds = \sqrt{\frac{1}{x} + 1} dx \Rightarrow A = \int_0^3 2\sqrt{x} \sqrt{\frac{1}{x} + 1} dx = \frac{4}{3} \left[(1+x)^{3/2} \right]_0^3 = \frac{28}{3}$$

8. This surface is a triangle having a base of $2\pi a$ and a height of $2\pi ak$. Therefore the surface area is

$$\frac{1}{2} (2\pi a)(2\pi ak) = 2\pi^2 a^2 k.$$

$$9. F = ma = t^2 \Rightarrow \frac{d^2}{dt^2} = a = \frac{t^2}{m} \Rightarrow v = \frac{dx}{dt} = \frac{t^3}{3m} + C; v = 0 \text{ when } t = 0 \Rightarrow C = 0 \Rightarrow \frac{dx}{dt} = \frac{t^2}{3m} \Rightarrow x = \frac{t^4}{12m} + C_1;$$

$x = 0$ when $t = 0 \Rightarrow C_1 = 0 \Rightarrow x = \frac{t^4}{12m}$. Then $x = h \Rightarrow t = (12mh)^{1/4}$. The work done is

$$W = \int F dx = \int_0^{(12mh)^{1/4}} F(t) \cdot \frac{dx}{dt} dt = \int_0^{(12mh)^{1/4}} t^2 \cdot \frac{t^3}{3m} dt = \frac{1}{3m} \left[\frac{t^6}{6} \right]_0^{(12mh)^{1/4}} = \left(\frac{1}{18m} \right) (12mh)^{6/4} = \frac{(12mh)^{3/2}}{18m}$$

$$= \frac{12mh \cdot \sqrt{12mh}}{18m} = \frac{2h}{3} \cdot 2\sqrt{3mh} = \frac{4h}{3} \sqrt{3mh}$$

10. Converting to pounds and feet, $2 \text{ lb/in} = \frac{2 \text{ lb}}{1 \text{ in}} \cdot \frac{12 \text{ in}}{1 \text{ ft}} = 24 \text{ lb/ft}$. Thus, $F = 24x \Rightarrow W = \int_0^{1/2} 24x \, dx = \left[12x^2 \right]_0^{1/2} = 3 \text{ ft} \cdot \text{lb}$. Since $W = \frac{1}{2}mv_0^2 - \frac{1}{2}mv_1^2$, where $W = 3 \text{ ft} \cdot \text{lb}$, $m = \left(\frac{1}{10} \text{ lb}\right) \left(\frac{1}{32 \text{ ft/sec}^2}\right) = \frac{1}{320}$ slugs, and $v_1 = 0 \text{ ft/sec}$, we have $3 = \left(\frac{1}{2}\right) \left(\frac{1}{320} v_0^2\right) \Rightarrow v_0^2 = 3 \cdot 640$. For the projectile height, $s = -16t^2 + v_0 t$ (since $s = 0$ at $t = 0$) $\Rightarrow \frac{ds}{dt} = v = -32t + v_0$. At the top of the ball's path, $v = 0 \Rightarrow t = \frac{v_0}{32}$ and the height is $s = -16 \left(\frac{v_0}{32}\right)^2 + v_0 \left(\frac{v_0}{32}\right) = \frac{v_0^2}{64} = \frac{3 \cdot 640}{64} = 30 \text{ ft}$.

11. From the symmetry of $y = 1 - x^n$, n even, about the y -axis for $-1 \leq x \leq 1$, we have $\bar{x} = 0$. To find $\bar{y} = \frac{M_x}{M}$, we use the vertical strips technique. The typical strip has center of mass: $(\tilde{x}, \tilde{y}) = \left(x, \frac{1-x^n}{2}\right)$, length: $1 - x^n$, width: dx , area: $dA = (1 - x^n) dx$, mass: $dm = 1 \cdot dA = (1 - x^n) dx$. The moment of the strip about the x -axis is $\tilde{y} dm = \frac{(1-x^n)^2}{2} dx \Rightarrow M_x = \int_{-1}^1 \frac{(1-x^n)^2}{2} dx = 2 \int_0^1 \frac{1}{2} (1 - 2x^n + x^{2n}) dx = \left[x - \frac{2x^{n+1}}{n+1} + \frac{x^{2n+1}}{2n+1} \right]_0^1 = 1 - \frac{2}{n+1} + \frac{1}{2n+1} = \frac{(n+1)(2n+1) - 2(2n+1) + (n+1)}{(n+1)(2n+1)} = \frac{2n^2 + 3n + 1 - 4n - 2 + n + 1}{(n+1)(2n+1)} = \frac{2n^2}{(n+1)(2n+1)}$. Also, $M = \int_{-1}^1 dA = \int_{-1}^1 (1 - x^n) dx = 2 \int_0^1 (1 - x^n) dx = 2 \left[x - \frac{x^{n+1}}{n+1} \right]_0^1 = 2 \left(1 - \frac{1}{n+1}\right) = \frac{2n}{n+1}$. Therefore, $\bar{y} = \frac{M_x}{M} = \frac{2n^2}{(n+1)(2n+1)} \cdot \frac{(n+1)}{2n} = \frac{n}{2n+1} \Rightarrow \left(0, \frac{n}{2n+1}\right)$ is the location of the centroid. As $n \rightarrow \infty$, $\bar{y} \rightarrow \frac{1}{2}$ so the limiting position of the centroid is $\left(0, \frac{1}{2}\right)$.

12. Align the telephone pole along the x -axis as shown in the accompanying figure. The slope of the top

length of pole is $\frac{\left(\frac{14.5}{8\pi} - \frac{9}{8\pi}\right)}{40} = \frac{1}{8\pi} \cdot \frac{1}{40} \cdot (14.5 - 9) = \frac{5.5}{8\pi \cdot 40} = \frac{11}{8\pi \cdot 80}$. Thus, $y = \frac{9}{8\pi} + \frac{11}{8\pi \cdot 80} x$ is an equation of the line

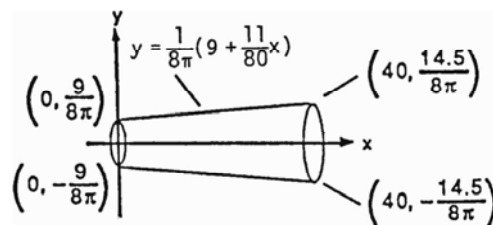

representing the top of the pole. Then

$$M_y = \int_a^b x \cdot \pi y^2 \, dx = \pi \int_0^{40} x \left[\frac{1}{8\pi} \left(9 + \frac{11}{80} x\right) \right]^2 dx = \frac{1}{64\pi} \int_0^{40} x \left(9 + \frac{11}{80} x\right)^2 dx;$$

$$M = \int_a^b \pi y^2 \, dx = \pi \int_0^{40} \left[\frac{1}{8\pi} \left(9 + \frac{11}{80} x\right) \right]^2 dx = \frac{1}{64\pi} \int_0^{40} \left(9 + \frac{11}{80} x\right)^2 dx. \text{ Thus, } \bar{x} = \frac{M_y}{M} \approx \frac{129,700}{5623.3} \approx 23.06 \text{ (using a calculator to compute the integrals).}$$

By symmetry about the x -axis, $\bar{y} = 0$ so the center of mass is about 23 ft from the top of the pole.

13. (a) Consider a single vertical strip with center of mass (\tilde{x}, \tilde{y}) . If the plate lies to the right of the line, then the moment of this strip about the line $x = b$ is $(\tilde{x} - b) dm = (\tilde{x} - b) \delta \, dA \Rightarrow$ the plate's first moment about $x = b$ is the integral $\int (x - b) \delta \, dA = \int \delta x \, dA - \int \delta b \, dA = M_y - b \delta A$.
- (b) If the plate lies to the left of the line, the moment of a vertical strip about the line $x = b$ is $(b - \tilde{x}) dm = (b - \tilde{x}) \delta \, dA \Rightarrow$ the plate's first moment about $x = b$ is $\int (b - x) \delta \, dA = \int b \delta \, dA - \int \delta x \, dA = b \delta A - M_y$.

14. (a) By symmetry of the plate about the x -axis, $\bar{y} = 0$. A typical vertical strip has center of mass: $(\tilde{x}, \tilde{y}) = (x, 0)$, length: $4\sqrt{ax}$, width: dx , area: $4\sqrt{ax} dx$, mass: $dm = \delta dA = kx \cdot 4\sqrt{ax} dx$, for some proportionality constant k . The moment of the strip about the y -axis is $M_y = \int \tilde{x} dm = \int_0^a 4kx^2\sqrt{ax} dx$
 $= 4k\sqrt{a} \int_0^a x^{5/2} dx = 4k\sqrt{a} \left[\frac{2}{7} x^{7/2} \right]_0^a = 4k a^{1/2} \cdot \frac{2}{7} a^{7/2} = \frac{8ka^4}{7}$. Also, $M = \int dm = \int_0^a 4kx\sqrt{ax} dx$
 $= 4k\sqrt{a} \int_0^a x^{3/2} dx = 4k\sqrt{a} \left[\frac{2}{5} x^{5/2} \right]_0^a = 4k a^{1/2} \cdot \frac{2}{5} a^{5/2} = \frac{8ka^3}{5}$. Thus, $\bar{x} = \frac{M_y}{M} = \frac{8ka^4}{7} \cdot \frac{5}{8ka^3} = \frac{5}{7}a$
 $\Rightarrow (\bar{x}, \bar{y}) = \left(\frac{5a}{7}, 0\right)$ is the center of mass.

(b) A typical horizontal strip has center of mass: $(\tilde{x}, \tilde{y}) = \left(\frac{\frac{y^2}{4a} + a}{2}, y\right) = \left(\frac{y^2 + 4a^2}{8a}, y\right)$, length: $a - \frac{y^2}{4a}$, width: dy , area: $\left(a - \frac{y^2}{4a}\right) dy$, mass: $dm = \delta dA = |y| \left(a - \frac{y^2}{4a}\right) dy$. Thus,
 $M_x = \int \tilde{y} dm = \int_{-2a}^{2a} y |y| \left(a - \frac{y^2}{4a}\right) dy = \int_{-2a}^0 -y^2 \left(a - \frac{y^2}{4a}\right) dy + \int_0^{2a} y^2 \left(a - \frac{y^2}{4a}\right) dy$
 $= \int_{-2a}^0 \left(-ay^2 + \frac{y^4}{4a}\right) dy + \int_0^{2a} \left(ay^2 - \frac{y^4}{4a}\right) dy = \left[-\frac{a}{3}y^3 + \frac{y^5}{20a}\right]_{-2a}^0 + \left[\frac{a}{3}y^3 - \frac{y^5}{20a}\right]_0^{2a} = -\frac{8a^4}{3} + \frac{32a^5}{20a} + \frac{8a^4}{3} - \frac{32a^5}{20a} = 0$;
 $M_y = \int \tilde{x} dm = \int_{-2a}^{2a} \left(\frac{y^2 + 4a^2}{8a}\right) |y| \left(a - \frac{y^2}{4a}\right) dy = \frac{1}{8a} \int_{-2a}^{2a} |y| (y^2 + 4a^2) \left(\frac{4a^2 - y^2}{4a}\right) dy = \frac{1}{32a^2} \int_{-2a}^{2a} |y| (16a^4 - y^4) dy$
 $= \frac{1}{32a^2} \int_{-2a}^0 (-16a^4 y + y^5) dy + \frac{1}{32a^2} \int_0^{2a} (16a^4 y - y^5) dy = \frac{1}{32a^2} \left[-8a^4 y^2 + \frac{y^6}{6}\right]_{-2a}^0 + \frac{1}{32a^2} \left[8a^4 y^2 - \frac{y^6}{6}\right]_0^{2a}$
 $= \frac{1}{32a^2} \left[8a^4 \cdot 4a^2 - \frac{64a^6}{6}\right] + \frac{1}{32a^2} \left[8a^4 \cdot 4a^2 - \frac{64a^6}{6}\right] = \frac{1}{16a^2} \left(32a^6 - \frac{32a^6}{3}\right) = \frac{1}{16a^2} \cdot \frac{2}{3} (32a^6) = \frac{4}{3} a^4$;
 $M = \int dm = \int_{-2a}^{2a} |y| \left(\frac{4a^2 - y^2}{4a}\right) dy = \frac{1}{4a} \int_{-2a}^{2a} |y| (4a^2 - y^2) dy = \frac{1}{4a} \int_{-2a}^0 (-4a^2 y + y^3) dy + \frac{1}{4a} \int_0^{2a} (4a^2 y - y^3) dy$
 $= \frac{1}{4a} \left[-2a^2 y^2 + \frac{y^4}{4}\right]_{-2a}^0 + \frac{1}{4a} \left[2a^2 y^2 - \frac{y^4}{4}\right]_0^{2a} = 2 \cdot \frac{1}{4a} \left(2a^2 \cdot 4a^2 - \frac{16a^4}{4}\right) = \frac{1}{2a} (8a^4 - 4a^4) = 2a^3$. Therefore,
 $\bar{x} = \frac{M_y}{M} = \left(\frac{4}{3}a^4\right) \left(\frac{1}{2a^3}\right) = \frac{2a}{3}$ and $\bar{y} = \frac{M_x}{M} = 0$ is the center of mass.

15. (a) On $[0, a]$ a typical vertical strip has center of mass: $(\tilde{x}, \tilde{y}) = \left(x, \frac{\sqrt{b^2 - x^2} + \sqrt{a^2 - x^2}}{2}\right)$, length: $\sqrt{b^2 - x^2} - \sqrt{a^2 - x^2}$, width: dx , area: $dA = \left(\sqrt{b^2 - x^2} - \sqrt{a^2 - x^2}\right) dx$, mass: $dm = \delta dA = \delta \left(\sqrt{b^2 - x^2} - \sqrt{a^2 - x^2}\right) dx$. On $[a, b]$ a typical vertical strip has center of mass: $(\tilde{x}, \tilde{y}) = \left(x, \frac{\sqrt{b^2 - x^2}}{2}\right)$, length: $\sqrt{b^2 - x^2}$, width: dx , area: $dA = \sqrt{b^2 - x^2} dx$, mass: $dm = \delta dA = \delta \sqrt{b^2 - x^2} dx$. Thus,
 $M_x = \int \tilde{y} dm = \int_0^a \frac{1}{2} \left(\sqrt{b^2 - x^2} + \sqrt{a^2 - x^2}\right) \delta \left(\sqrt{b^2 - x^2} - \sqrt{a^2 - x^2}\right) dx + \int_a^b \frac{1}{2} \sqrt{b^2 - x^2} \delta \sqrt{b^2 - x^2} dx$
 $= \frac{\delta}{2} \int_0^a \left[(b^2 - x^2) - (a^2 - x^2)\right] dx + \frac{\delta}{2} \int_a^b (b^2 - x^2) dx = \frac{\delta}{2} \int_0^a (b^2 - a^2) dx + \frac{\delta}{2} \int_a^b (b^2 - x^2) dx$
 $= \frac{\delta}{2} \left[(b^2 - a^2)x\right]_0^a + \frac{\delta}{2} \left[b^2 x - \frac{x^3}{3}\right]_a^b = \frac{\delta}{2} \left[(b^2 - a^2)a\right] + \frac{\delta}{2} \left[\left(b^3 - \frac{b^3}{3}\right) - \left(b^2 a - \frac{a^3}{3}\right)\right]$

$$\begin{aligned}
 &= \frac{\delta}{2}(ab^2 - a^3) + \frac{\delta}{2}\left(\frac{2}{3}b^3 - ab^2 + \frac{a^3}{3}\right) = \frac{\delta b^3}{3} - \frac{\delta a^3}{3} = \delta\left(\frac{b^3 - a^3}{3}\right); \\
 M_y &= \int \tilde{x} \, dm = \int_0^a x \delta(\sqrt{b^2 - x^2} - \sqrt{a^2 - x^2}) \, dx + \int_a^b x \delta \sqrt{b^2 - x^2} \, dx \\
 &= \delta \int_0^a x(b^2 - x^2)^{1/2} \, dx - \delta \int_0^a x(a^2 - x^2)^{1/2} \, dx + \delta \int_a^b x(b^2 - x^2)^{1/2} \, dx \\
 &= -\frac{\delta}{2} \left[\frac{2(b^2 - x^2)^{3/2}}{3} \right]_0^a + \frac{\delta}{2} \left[\frac{2(a^2 - x^2)^{3/2}}{3} \right]_0^a - \frac{\delta}{2} \left[\frac{2(b^2 - x^2)^{3/2}}{3} \right]_a^b \\
 &= -\frac{\delta}{3} \left[(b^2 - a^2)^{3/2} - (b^2)^{3/2} \right] + \frac{\delta}{3} \left[0 - (a^2)^{3/2} \right] - \frac{\delta}{3} \left[0 - (b^2 - a^2)^{3/2} \right] = \frac{\delta b^3}{3} - \frac{\delta a^3}{3} = \frac{\delta(b^3 - a^3)}{3} = M_x;
 \end{aligned}$$

We calculate the mass geometrically: $M = \delta A = \delta\left(\frac{\pi b^2}{4}\right) - \delta\left(\frac{\pi a^2}{4}\right) = \frac{\delta\pi}{4}(b^2 - a^2)$. Thus, $\bar{x} = \frac{M_y}{M}$
 $= \frac{\delta(b^3 - a^3)}{3} \cdot \frac{4}{\delta\pi(b^2 - a^2)} = \frac{4}{3\pi} \left(\frac{b^3 - a^3}{b^2 - a^2} \right) = \frac{4}{3\pi} \frac{(b-a)(a^2 + ab + b^2)}{(b-a)(b+a)} = \frac{4(a^2 + ab + b^2)}{3\pi(a+b)}$; likewise $\bar{y} = \frac{M_x}{M} = \frac{4(a^2 + ab + b^2)}{3\pi(a+b)}$.

- (b) $\lim_{b \rightarrow a} \frac{4}{3\pi} \left(\frac{a^2 + ab + b^2}{a+b} \right) = \left(\frac{4}{3\pi} \right) \left(\frac{a^2 + a^2 + a^2}{a+a} \right) = \left(\frac{4}{3\pi} \right) \left(\frac{3a^2}{2a} \right) = \frac{2a}{\pi} \Rightarrow (\bar{x}, \bar{y}) = \left(\frac{2a}{\pi}, \frac{2a}{\pi} \right)$ is the limiting position of the centroid as $b \rightarrow a$. This is the centroid of a circle of radius a (and we note the two circles coincide when $b = a$).

16. Since the area of the triangle is 36, the diagram may be labeled as shown at the right. The centroid of the triangle is $\left(\frac{a}{3}, \frac{24}{a}\right)$. The shaded portion is $144 - 36 = 108$. Write $(\underline{x}, \underline{y})$ for the centroid of the remaining region. The centroid of the whole square is obviously $(6, 6)$. Think of the square as a sheet of uniform density, so that the centroid of the square is the average of the centroids of the two regions,

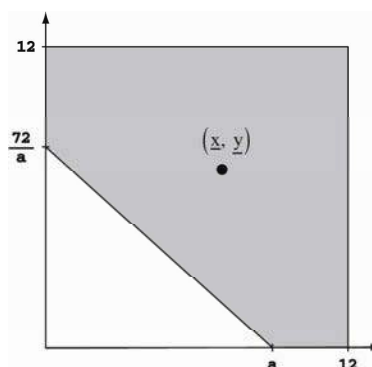

weighted by area: $6 = \frac{36\left(\frac{a}{3}\right) + 108(\underline{x})}{144}$ and

$$6 = \frac{36\left(\frac{24}{a}\right) + 108(\underline{y})}{144} \text{ which we solve to get } \underline{x} = 8 - \frac{a}{9}$$

and $\underline{y} = \frac{8(a-1)}{a}$. Set $\underline{x} = 7$ in. (Given). It follows that $a = 9$, whence $\underline{y} = \frac{64}{9} = 7\frac{1}{9}$ in. The distances of the centroid $(\underline{x}, \underline{y})$ from the other sides are easily computed. (Note that if we set $\underline{y} = 7$ in. above, we will find $\underline{x} = 7\frac{1}{9}$.)

17. The submerged triangular plate is depicted in the figure at the right. The hypotenuse of the triangle has slope $-1 \Rightarrow y - (-2) = -(x - 0) \Rightarrow x = -(y + 2)$ is an equation of the hypotenuse. Using a typical horizontal strip, the fluid pressure is

$$\begin{aligned} F &= \int (62.4) \cdot \left(\frac{\text{strip}}{\text{depth}}\right) \cdot \left(\frac{\text{strip}}{\text{length}}\right) dy \\ &= \int_{-6}^{-2} (62.4)(-y)[-y+2] dy \\ &= 62.4 \int_{-6}^{-2} (y^2 + 2y) dy = 62.4 \left[\frac{y^3}{3} + y^2 \right]_{-6}^{-2} \\ &= (62.4) \left[\left(-\frac{8}{3} + 4\right) - \left(-\frac{216}{3} + 36\right) \right] \\ &= (62.4) \left(\frac{208}{3} - 32 \right) = \frac{(62.4)(112)}{3} \approx 2329.6 \text{ lb} \end{aligned}$$

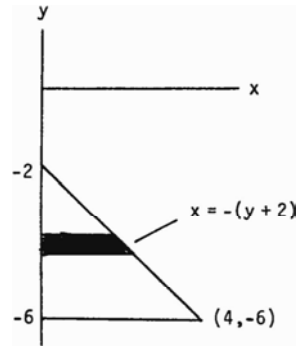

18. Consider a rectangular plate of length ℓ and width w . The length is parallel with the surface of the fluid of weight density ω . The force on one side of the plate is $F = \omega \int_{-w}^0 (-y)(\ell) dy = -\omega \ell \left[\frac{y^2}{2} \right]_{-w}^0 = \frac{\omega \ell w^2}{2}$.

The average force on one side of the plate is

$$\begin{aligned} F_{av} &= \frac{\omega}{w} \int_{-w}^0 (-y) dy = \frac{\omega}{w} \left[-\frac{y^2}{2} \right]_{-w}^0 = \frac{\omega w}{2}. \text{ Therefore the force } \frac{\omega \ell w^2}{2} = \left(\frac{\omega w}{2} \right) (\ell w) \\ &= (\text{the average pressure up and down}) \cdot (\text{the area of the plate}). \end{aligned}$$

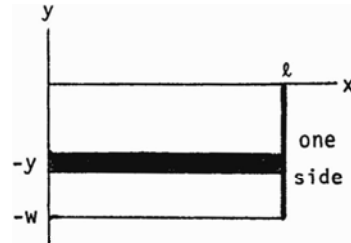

CHAPTER 7 INTEGRALS AND TRANSCENDENTAL FUNCTIONS

7.1 THE LOGARITHM DEFINED AS AN INTEGRAL

- $$\int_{-3}^{-2} \frac{1}{x} dx = [\ln|x|]_{-3}^{-2} = \ln 2 - \ln 3 = \ln \frac{2}{3}$$
- $$\int_{-1}^0 \frac{3}{3x-2} dx = [\ln|3x-2|]_{-1}^0 = \ln 2 - \ln 5 = \ln \frac{2}{5}$$
- $$\int \frac{2y}{y^2-25} dy = \ln|y^2-25| + C$$
- $$\int \frac{8r}{4r^2-5} dr = \ln|4r^2-5| + C$$
- Let $u = 6 + 3 \tan t \Rightarrow du = 3 \sec^2 t dt$; $\int \frac{3 \sec^2 t}{6+3 \tan t} dt = \int \frac{du}{u} = \ln|u| + C = \ln|6 + 3 \tan t| + C$
- Let $u = 2 + \sec y \Rightarrow du = \sec y \tan y dy$; $\int \frac{\sec y \tan y}{2+\sec y} dy = \int \frac{du}{u} = \ln|u| + C = \ln|2 + \sec y| + C$
- $\int \frac{dx}{2\sqrt{x}+2x} = \int \frac{dx}{2\sqrt{x}(1+\sqrt{x})}$; let $u = 1 + \sqrt{x} \Rightarrow du = \frac{1}{2\sqrt{x}} dx$;

$$\int \frac{dx}{2\sqrt{x}(1+\sqrt{x})} = \int \frac{du}{u} = \ln|u| + C = \ln|1 + \sqrt{x}| + C = \ln(1 + \sqrt{x}) + C$$
- Let $u = \sec x + \tan x \Rightarrow du = (\sec x \tan x + \sec^2 x) dx = (\sec x)(\tan x + \sec x) dx \Rightarrow \sec x dx = \frac{du}{u}$;

$$\int \frac{\sec x dx}{\sqrt{\ln(\sec x + \tan x)}} = \int \frac{du}{u \sqrt{\ln u}} = \int (\ln u)^{-1/2} \cdot \frac{1}{u} du = 2(\ln u)^{1/2} + C = 2\sqrt{\ln(\sec x + \tan x)} + C$$
- $$\int_{\ln 2}^{\ln 3} e^x dx = [e^x]_{\ln 2}^{\ln 3} = e^{\ln 3} - e^{\ln 2} = 3 - 2 = 1$$
- $$\int 8e^{(x+1)} dx = 8e^{(x+1)} + C$$
- $$\int_1^4 \frac{(\ln x)^3}{2x} dx = \frac{1}{2} \int_1^4 (\ln x)^3 \left(\frac{1}{x}\right) dx = \left[\frac{(\ln x)^4}{8}\right]_1^4 = \frac{(\ln 4)^4}{8} - \frac{(\ln 1)^4}{8} = \frac{(\ln 4)^4}{8}$$
- Let $u = \ln(\ln x) \Rightarrow du = \frac{1}{\ln x} \cdot \frac{1}{x} dx = \frac{1}{x \ln x} dx$; $\int \frac{\ln(\ln x)}{x \ln x} dx = \int \ln(\ln x) \frac{1}{x \ln x} dx = \int u du = \frac{u^2}{2} + C = \frac{(\ln(\ln x))^2}{2} + C$
- $$\int_{\ln 4}^{\ln 9} e^{x/2} dx = [2e^{x/2}]_{\ln 4}^{\ln 9} = 2[e^{(\ln 9)/2} - e^{(\ln 4)/2}] = 2(e^{\ln 3} - e^{\ln 2}) = 2(3 - 2) = 2$$
- Let $u = \ln(\cos x) \Rightarrow du = \frac{1}{\cos x} (-\sin x) dx = -\tan x dx \Rightarrow -du = \tan x dx$;

$$\int \tan x \ln(\cos x) dx = -\int u du = -\frac{u^2}{2} + C = -\frac{(\ln(\cos x))^2}{2} + C$$
- Let $u = r^{1/2} \Rightarrow du = \frac{1}{2} r^{-1/2} dr \Rightarrow 2 du = r^{-1/2} dr$;

$$\int \frac{e^{\sqrt{r}}}{\sqrt{r}} dr = \int e^{r^{1/2}} \cdot r^{-1/2} dr = 2 \int e^u du = 2e^u + C = 2e^{r^{1/2}} + C = 2e^{\sqrt{r}} + C$$

16. Let $u = -r^{1/2} \Rightarrow du = -\frac{1}{2}r^{-1/2}dr \Rightarrow -2du = r^{-1/2}dr$;

$$\int \frac{e^{-\sqrt{r}}}{\sqrt{r}} dr = \int e^{-r^{1/2}} \cdot r^{-1/2} dr = -2 \int e^u du = -2e^{-r^{1/2}} + C = -2e^{-\sqrt{r}} + C$$
17. Let $u = -t^2 \Rightarrow du = -2t dt \Rightarrow -du = 2t dt$; $\int 2te^{-t^2} dt = -\int e^u du = -e^u + C = -e^{-t^2} + C$
18. Let $u = \ln^2 x + 1 \Rightarrow du = 2 \ln x \cdot \frac{1}{x} dx = \frac{2 \ln x}{x} dx \Rightarrow \frac{1}{2} du = \frac{\ln x}{x} dx$;

$$\int \frac{\ln x}{x \sqrt{\ln^2 x + 1}} dx = \int \frac{1}{2\sqrt{u}} du = \sqrt{u} + C = \sqrt{\ln^2 x + 1} + C$$
19. Let $u = \frac{1}{x} \Rightarrow du = -\frac{1}{x^2} dx \Rightarrow -du = \frac{1}{x^2} dx$; $\int \frac{e^{1/x}}{x^2} dx = \int -e^u du = -e^u + C = -e^{1/x} + C$
20. Let $u = -x^{-2} \Rightarrow du = 2x^{-3} dx \Rightarrow \frac{1}{2} du = x^{-3} dx$;

$$\int \frac{e^{-1/x^2}}{x^3} dx = \int e^{-x^{-2}} \cdot x^{-3} dx = \frac{1}{2} \int e^u du = \frac{1}{2} e^u + C = \frac{1}{2} e^{-x^{-2}} + C = \frac{1}{2} e^{-1/x^2} + C$$
21. Let $u = \sec \pi t \Rightarrow du = \pi \sec \pi t \tan \pi t dt \Rightarrow \frac{du}{\pi} = \sec \pi t \tan \pi t dt$;

$$\int e^{\sec(\pi t)} \sec(\pi t) \tan(\pi t) dt = \frac{1}{\pi} \int e^u du = \frac{e^u}{\pi} + C = \frac{e^{\sec(\pi t)}}{\pi} + C$$
22. Let $u = \csc(\pi + t) \Rightarrow du = -\csc(\pi + t) \cot(\pi + t) dt$;

$$\int e^{\csc(\pi+t)} \csc(\pi+t) \cot(\pi+t) dt = -\int e^u du = -e^u + C = -e^{\csc(\pi+t)} + C$$
23. Let $u = e^v \Rightarrow du = e^v dv \Rightarrow 2 du = 2e^v dv$; $v = \ln \frac{\pi}{6} \Rightarrow u = \frac{\pi}{6}$, $v = \ln \frac{\pi}{2} \Rightarrow u = \frac{\pi}{2}$;

$$\int_{\ln(\pi/6)}^{\ln(\pi/2)} 2e^v \cos e^v dv = 2 \int_{\pi/6}^{\pi/2} \cos u du = [2 \sin u]_{\pi/6}^{\pi/2} = 2 \left[\sin\left(\frac{\pi}{2}\right) - \sin\left(\frac{\pi}{6}\right) \right] = 2 \left(1 - \frac{1}{2}\right) = 1$$
24. Let $u = e^{x^2} \Rightarrow du = 2xe^{x^2} dx$; $x = 0 \Rightarrow u = 1$, $x = \sqrt{\ln \pi} \Rightarrow u = e^{\ln \pi} = \pi$;

$$\int_0^{\sqrt{\ln \pi}} 2xe^{x^2} \cos(e^{x^2}) dx = \int_1^{\pi} \cos u du = [\sin u]_1^{\pi} = \sin(\pi) - \sin(1) = -\sin(1) \approx -0.84147$$
25. Let $u = 1 + e^r \Rightarrow du = e^r dr$; $\int \frac{e^r}{1+e^r} dr = \int \frac{1}{u} du = \ln|u| + C = \ln(1 + e^r) + C$
26. $\int \frac{1}{1+e^x} dx = \int \frac{e^{-x}}{e^{-x}+1} dx$; let $u = e^{-x} + 1 \Rightarrow du = -e^{-x} dx \Rightarrow -du = e^{-x} dx$;

$$\int \frac{e^{-x}}{e^{-x}+1} dx = -\int \frac{1}{u} du = -\ln|u| + C = -\ln(e^{-x} + 1) + C$$
27. $\int_0^1 2^{-\theta} d\theta = \int_0^1 \left(\frac{1}{2}\right)^{\theta} d\theta = \left[\frac{\left(\frac{1}{2}\right)^{\theta}}{\ln\left(\frac{1}{2}\right)} \right]_0^1 = \frac{\frac{1}{2}}{\ln\left(\frac{1}{2}\right)} - \frac{1}{\ln\left(\frac{1}{2}\right)} = -\frac{\frac{1}{2}}{\ln\left(\frac{1}{2}\right)} = \frac{-1}{2(\ln 1 - \ln 2)} = \frac{1}{2 \ln 2}$

28. $\int_{-2}^0 5^{-\theta} d\theta = \int_{-2}^0 \left(\frac{1}{5}\right)^\theta d\theta = \left[\frac{\left(\frac{1}{5}\right)^\theta}{\ln\left(\frac{1}{5}\right)} \right]_{-2}^0 = \frac{1}{\ln\left(\frac{1}{5}\right)} - \frac{\left(\frac{1}{5}\right)^{-2}}{\ln\left(\frac{1}{5}\right)} = \frac{1}{\ln\left(\frac{1}{5}\right)}(1-25) = \frac{-24}{\ln 1 - \ln 5} = \frac{24}{\ln 5}$

29. Let $u = x^2 \Rightarrow du = 2x dx \Rightarrow \frac{1}{2} du = x dx$; $x = 1 \Rightarrow u = 1$, $x = \sqrt{2} \Rightarrow u = 2$;
 $\int_1^{\sqrt{2}} x 2^{(x^2)} dx = \int_1^2 \left(\frac{1}{2}\right) 2^u du = \frac{1}{2} \left[\frac{2^u}{\ln 2} \right]_1^2 = \left(\frac{1}{2\ln 2}\right)(2^2 - 2^1) = \frac{1}{\ln 2}$

30. Let $u = x^{1/2} \Rightarrow du = \frac{1}{2} x^{-1/2} dx \Rightarrow 2 du = \frac{dx}{\sqrt{x}}$; $x = 1 \Rightarrow u = 1$, $x = 4 \Rightarrow u = 2$;
 $\int_1^4 \frac{2\sqrt{x}}{\sqrt{x}} dx = \int_1^4 2x^{1/2} \cdot x^{-1/2} dx = 2 \int_1^2 2^u du = \left[\frac{2^{(u+1)}}{\ln 2} \right]_1^2 = \left(\frac{1}{\ln 2}\right)(2^3 - 2^2) = \frac{4}{\ln 2}$

31. Let $u = \cos t \Rightarrow du = -\sin t dt \Rightarrow -du = \sin t dt$; $t = 0 \Rightarrow u = 1$, $t = \frac{\pi}{2} \Rightarrow u = 0$;
 $\int_0^{\pi/2} 7^{\cos t} \sin t dt = -\int_1^0 7^u du = \left[-\frac{7^u}{\ln 7} \right]_1^0 = \left(\frac{-1}{\ln 7}\right)(7^0 - 7) = \frac{6}{\ln 7}$

32. Let $u = \tan t \Rightarrow du = \sec^2 t dt$; $t = 0 \Rightarrow u = 0$, $t = \frac{\pi}{4} \Rightarrow u = 1$;
 $\int_0^{\pi/4} \left(\frac{1}{3}\right)^{\tan t} \sec^2 t dt = \int_0^1 \left(\frac{1}{3}\right)^u du = \left[\frac{\left(\frac{1}{3}\right)^u}{\ln\left(\frac{1}{3}\right)} \right]_0^1 = \left(-\frac{1}{\ln 3}\right) \left[\left(\frac{1}{3}\right)^1 - \left(\frac{1}{3}\right)^0 \right] = \frac{2}{3\ln 3}$

33. Let $u = x^{2x} \Rightarrow \ln u = 2x \ln x \Rightarrow \frac{1}{u} \frac{du}{dx} = 2 \ln x + (2x)\left(\frac{1}{x}\right) \Rightarrow \frac{du}{dx} = 2u(\ln x + 1) \Rightarrow \frac{1}{2} du = x^{2x}(1 + \ln x) dx$;
 $x = 2 \Rightarrow u = 2^4 = 16$, $x = 4 \Rightarrow u = 4^8 = 65,536$;
 $\int_2^4 x^{2x}(1 + \ln x) dx = \frac{1}{2} \int_{16}^{65,536} du = \frac{1}{2} [u]_{16}^{65,536} = \frac{1}{2}(65,536 - 16) = \frac{65,520}{2} = 32,760$

34. Let $u = \ln x \Rightarrow du = \frac{1}{x} dx$; $x = 1 \Rightarrow u = 0$, $x = 2 \Rightarrow u = \ln 2$;
 $\int_1^2 \frac{2^{\ln x}}{x} dx = \int_0^{\ln 2} 2^u du = \left[\frac{2^u}{\ln 2} \right]_0^{\ln 2} = \left(\frac{1}{\ln 2}\right)(2^{\ln 2} - 2^0) = \frac{2^{\ln 2} - 1}{\ln 2}$

35. $\int_0^3 (\sqrt{2} + 1)x^{\sqrt{2}} dx = \left[x^{(\sqrt{2}+1)} \right]_0^3 = 3^{(\sqrt{2}+1)}$ 36. $\int_1^e x^{(\ln 2)-1} dx = \left[\frac{\ln x}{\ln 2} \right]_1^e = \frac{e^{\ln 2} - 1^{\ln 2}}{\ln 2} = \frac{2-1}{\ln 2} = \frac{1}{\ln 2}$

37. $\int \frac{\log_{10} x}{x} dx = \int \left(\frac{\ln x}{\ln 10}\right)\left(\frac{1}{x}\right) dx$; $[u = \ln x \Rightarrow du = \frac{1}{x} dx]$
 $\rightarrow \int \left(\frac{\ln x}{\ln 10}\right)\left(\frac{1}{x}\right) dx = \frac{1}{\ln 10} \int u du = \left(\frac{1}{\ln 10}\right)\left(\frac{1}{2}u^2\right) + C = \frac{(\ln x)^2}{2\ln 10} + C$

38. $\int_1^4 \frac{\log_2 x}{x} dx = \int_1^4 \left(\frac{\ln x}{\ln 2}\right)\left(\frac{1}{x}\right) dx$; $[u = \ln x \Rightarrow du = \frac{1}{x} dx$; $x = 1 \Rightarrow u = 0$, $x = 4 \Rightarrow u = \ln 4]$
 $\rightarrow \int_1^4 \left(\frac{\ln x}{\ln 2}\right)\left(\frac{1}{x}\right) dx = \int_0^{\ln 4} \left(\frac{1}{\ln 2}\right)u du = \left(\frac{1}{\ln 2}\right)\left[\frac{1}{2}u^2\right]_0^{\ln 4} = \left(\frac{1}{\ln 2}\right)\left[\frac{1}{2}(\ln 4)^2\right] = \frac{(\ln 4)^2}{2\ln 2} = \frac{(\ln 4)^2}{\ln 4} = \ln 4$

$$39. \int_1^4 \frac{\ln 2 \log_2 x}{x} dx = \int_1^4 \left(\frac{\ln 2}{x}\right) \left(\frac{\ln x}{\ln 2}\right) dx = \int_1^4 \frac{\ln x}{x} dx = \left[\frac{1}{2}(\ln x)^2\right]_1^4 = \frac{1}{2}[(\ln 4)^2 - (\ln 1)^2] = \frac{1}{2}(\ln 4)^2 = \frac{1}{2}(2 \ln 2)^2 = 2(\ln 2)^2$$

$$40. \int_1^e \frac{2 \ln 10 (\log_{10} x)}{x} dx = \int_1^e \frac{(\ln 10)(2 \ln x)}{(\ln 10)} \left(\frac{1}{x}\right) dx = [(\ln x)^2]_1^e = (\ln e)^2 - (\ln 1)^2 = 1$$

$$41. \int_0^2 \frac{\log_2(x+2)}{x+2} dx = \frac{1}{\ln 2} \int_0^2 [\ln(x+2)] \left(\frac{1}{x+2}\right) dx = \left(\frac{1}{\ln 2}\right) \left[\frac{(\ln(x+2))^2}{2}\right]_0^2 = \left(\frac{1}{\ln 2}\right) \left[\frac{(\ln 4)^2}{2} - \frac{(\ln 2)^2}{2}\right] = \left(\frac{1}{\ln 2}\right) \left[\frac{4(\ln 2)^2}{2} - \frac{(\ln 2)^2}{2}\right] = \frac{3}{2} \ln 2$$

$$42. \int_{1/10}^{10} \frac{\log_{10}(10x)}{x} dx = \frac{10}{\ln 10} \int_{1/10}^{10} [\ln(10x)] \left(\frac{1}{10x}\right) dx = \left(\frac{10}{\ln 10}\right) \left[\frac{(\ln(10x))^2}{20}\right]_{1/10}^{10} = \left(\frac{10}{\ln 10}\right) \left[\frac{(\ln 100)^2}{20} - \frac{(\ln 1)^2}{20}\right] = \left(\frac{10}{\ln 10}\right) \left[\frac{4(\ln 10)^2}{20}\right] = 2 \ln 10$$

$$43. \int_0^9 \frac{2 \log_{10}(x+1)}{x+1} dx = \frac{2}{\ln 10} \int_0^9 \ln(x+1) \left(\frac{1}{x+1}\right) dx = \left(\frac{2}{\ln 10}\right) \left[\frac{(\ln(x+1))^2}{2}\right]_0^9 = \left(\frac{2}{\ln 10}\right) \left[\frac{(\ln 10)^2}{2} - \frac{(\ln 1)^2}{2}\right] = \ln 10$$

$$44. \int_2^3 \frac{2 \log_2(x-1)}{x-1} dx = \frac{2}{\ln 2} \int_2^3 \ln(x-1) \left(\frac{1}{x-1}\right) dx = \left(\frac{2}{\ln 2}\right) \left[\frac{(\ln(x-1))^2}{2}\right]_2^3 = \left(\frac{2}{\ln 2}\right) \left[\frac{(\ln 2)^2}{2} - \frac{(\ln 1)^2}{2}\right] = \ln 2$$

$$45. \int \frac{dx}{x \log_{10} x} = \int \left(\frac{\ln 10}{\ln x}\right) \left(\frac{1}{x}\right) dx = (\ln 10) \int \left(\frac{1}{\ln x}\right) \left(\frac{1}{x}\right) dx; \quad [u = \ln x \Rightarrow du = \frac{1}{x} dx]$$

$$\rightarrow (\ln 10) \int \left(\frac{1}{\ln x}\right) \left(\frac{1}{x}\right) dx = (\ln 10) \int \frac{1}{u} du = (\ln 10) \ln |u| + C = (\ln 10) \ln |\ln x| + C$$

$$46. \int \frac{dx}{x(\log_8 x)^2} = \int \frac{dx}{x \left(\frac{\ln x}{\ln 8}\right)^2} = (\ln 8)^2 \int \frac{(\ln x)^{-2}}{x} dx = (\ln 8)^2 \frac{(\ln x)^{-1}}{-1} + C = -\frac{(\ln 8)^2}{\ln x} + C$$

$$47. \frac{dy}{dt} = e^t \sin(e^t - 2) \Rightarrow y = \int e^t \sin(e^t - 2) dt;$$

$$\text{let } u = e^t - 2 \Rightarrow du = e^t dt \Rightarrow y = \int \sin u du = -\cos u + C = -\cos(e^t - 2) + C;$$

$$y(\ln 2) = 0 \Rightarrow -\cos(e^{\ln 2} - 2) + C = 0 \Rightarrow -\cos(2 - 2) + C = 0 \Rightarrow C = \cos 0 = 1; \text{ thus, } y = 1 - \cos(e^t - 2)$$

$$48. \frac{dy}{dt} = e^{-t} \sec^2(\pi e^{-t}) \Rightarrow y = \int e^{-t} \sec^2(\pi e^{-t}) dt;$$

$$\text{let } u = \pi e^{-t} \Rightarrow du = -\pi e^{-t} dt \Rightarrow -\frac{1}{\pi} du = e^{-t} dt \Rightarrow y = -\frac{1}{\pi} \int \sec^2 u du = -\frac{1}{\pi} \tan u + C = -\frac{1}{\pi} \tan(\pi e^{-t}) + C;$$

$$y(\ln 4) = \frac{2}{\pi} \Rightarrow -\frac{1}{\pi} \tan(\pi e^{-\ln 4}) + C = \frac{2}{\pi} \Rightarrow -\frac{1}{\pi} \tan\left(\pi \cdot \frac{1}{4}\right) + C = \frac{2}{\pi} \Rightarrow -\frac{1}{\pi}(1) + C = \frac{2}{\pi} \Rightarrow C = \frac{3}{\pi};$$

$$\text{thus, } y = \frac{3}{\pi} - \frac{1}{\pi} \tan(\pi e^{-t})$$

49. $\frac{d^2y}{dx^2} = 2e^{-x} \Rightarrow \frac{dy}{dx} = -2e^{-x} + C$; $x = 0$ and $\frac{dy}{dx} = 0 \Rightarrow 0 = -2e^0 + C \Rightarrow C = 2$; thus
 $\frac{dy}{dx} = -2e^{-x} + 2 \Rightarrow y = 2e^{-x} + 2x + C_1$;
 $x = 0$ and $y = 1 \Rightarrow 1 = 2e^0 + C_1 \Rightarrow C_1 = -1 \Rightarrow y = 2e^{-x} + 2x - 1 = 2(e^{-x} + x) - 1$
50. $\frac{d^2y}{dt^2} = 1 - e^{2t} \Rightarrow \frac{dy}{dt} = t - \frac{1}{2}e^{2t} + C$; $t = 1$ and $\frac{dy}{dt} = 0 \Rightarrow 0 = 1 - \frac{1}{2}e^2 + C \Rightarrow C = \frac{1}{2}e^2 - 1$; thus
 $\frac{dy}{dt} = t - \frac{1}{2}e^{2t} + \frac{1}{2}e^2 - 1 \Rightarrow y = \frac{1}{2}t^2 - \frac{1}{4}e^{2t} + \left(\frac{1}{2}e^2 - 1\right)t + C_1$;
 $t = 1$ and $y = -1 \Rightarrow -1 = \frac{1}{2} - \frac{1}{4}e^2 + \frac{1}{2}e^2 - 1 + C_1 \Rightarrow C_1 = -\frac{1}{2} - \frac{1}{4}e^2 \Rightarrow y = \frac{1}{2}t^2 - \frac{1}{4}e^{2t} + \left(\frac{1}{2}e^2 - 1\right)t - \left(\frac{1}{2} + \frac{1}{4}e^2\right)$
51. $\frac{dy}{dx} = 1 + \frac{1}{x}$ at $(1, 3) \Rightarrow y = x + \ln|x| + C$; $y = 3$ at $x = 1 \Rightarrow C = 2 \Rightarrow y = x + \ln|x| + 2$
52. $\frac{d^2y}{dx^2} = \sec^2 x \Rightarrow \frac{dy}{dx} = \tan x + C$ and $1 = \tan 0 + C \Rightarrow \frac{dy}{dx} = \tan x + 1 \Rightarrow y = \int (\tan x + 1) dx = \ln|\sec x| + x + C_1$ and
 $0 = \ln|\sec 0| + 0 + C_1 \Rightarrow C_1 = 0 \Rightarrow y = \ln|\sec x| + x$
53. $V = 2\pi \int_{1/2}^2 x \left(\frac{1}{x^2}\right) dx = 2\pi \int_{1/2}^2 \frac{1}{x} dx = 2\pi [\ln|x|]_{1/2}^2 = 2\pi (\ln 2 - \ln \frac{1}{2}) = 2\pi (2 \ln 2) = \pi \ln 2^4 = \pi \ln 16$
54. $V = \pi \int_0^3 \left(\frac{9x}{\sqrt{x^3+9}}\right)^2 dx = 27\pi \int_0^3 dx = 27\pi [\ln(x^3+9)]_0^3 = 27\pi (\ln 36 - \ln 9) = 27\pi (\ln 4 + \ln 9 - \ln 9)$
 $= 27\pi \ln 4 = 54\pi \ln 2$
55. $y = \frac{x^2}{8} - \ln x \Rightarrow 1 + (y')^2 = 1 + \left(\frac{x}{4} - \frac{1}{x}\right)^2 = 1 + \left(\frac{x^2-4}{4x}\right)^2 = \left(\frac{x^2+4}{4x}\right)^2$
 $\Rightarrow L = \int_4^8 \sqrt{1 + (y')^2} dx = \int_4^8 \frac{x^2+4}{4x} dx = \int_4^8 \left(\frac{x}{4} + \frac{1}{x}\right) dx = \left[\frac{x^2}{8} + \ln|x|\right]_4^8 = (8 + \ln 8) - (2 + \ln 4) = 6 + \ln 2$
56. $x = \left(\frac{y}{4}\right)^2 - 2 \ln\left(\frac{y}{4}\right) \Rightarrow \frac{dx}{dy} = \frac{y}{8} - \frac{2}{y} \Rightarrow 1 + \left(\frac{dx}{dy}\right)^2 = 1 + \left(\frac{y}{8} - \frac{2}{y}\right)^2 = 1 + \left(\frac{y^2-16}{8y}\right)^2 = \left(\frac{y^2+16}{8}\right)^2$
 $\Rightarrow L = \int_4^{12} \sqrt{1 + \left(\frac{dx}{dy}\right)^2} dy = \int_4^{12} \frac{y^2+16}{8y} dy = \int_4^{12} \left(\frac{y}{8} + \frac{2}{y}\right) dy = \left[\frac{y^2}{16} + 2 \ln y\right]_4^{12} = (9 + 2 \ln 12) - (1 + 2 \ln 4)$
 $= 8 + 2 \ln 3 = 8 + \ln 9$
57. (a) $L(x) = f(0) + f'(0) \cdot x$, and $f(x) = \ln(1+x) \Rightarrow f'(x)|_{x=0} = \frac{1}{1+x}|_{x=0} = 1 \Rightarrow L(x) = \ln 1 + 1 \cdot x \Rightarrow L(x) = x$
(b) Let $f(x) = \ln(x+1)$. Since $f''(x) = -\frac{1}{(x+1)^2} < 0$ on $[0, 0.1]$, the graph of f is concave down on this interval and the largest error in the linear approximation will occur when $x = 0.1$. This error is $0.1 - \ln(1.1) \approx 0.00469$ to five decimal places.

- (c) The approximation $y = x$ for $\ln(1 + x)$ is best for smaller positive values of x ; in particular for $0 \leq x \leq 0.1$ in the graph. As x increases, so does the error $x - \ln(1 + x)$. From the graph an upper bound for the error is $0.5 - \ln(1 + 0.5) \approx 0.095$; i.e., $|E(x)| \leq 0.095$ for $0 \leq x \leq 0.5$. Note from the graph that $0.1 - \ln(1 + 0.1) \approx 0.00469$ estimates the error in replacing $\ln(1 + x)$ by x over $0 \leq x \leq 0.1$. This is consistent with the estimate given in part (b) above.

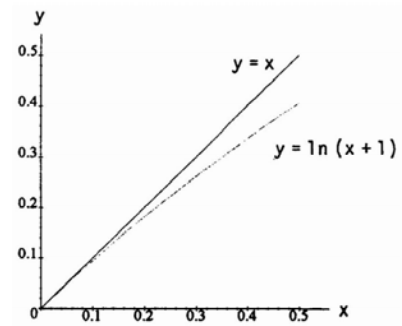

58. (a) $f(x) = e^x \Rightarrow f'(x) = e^x$; $L(x) = f(0) + f'(0)(x - 0) \Rightarrow L(x) = 1 + x$
 (b) $f(0) = 1$ and $L(0) = 1 \Rightarrow$ error $= 0$; $f(0.2) = e^{0.2} \approx 1.22140$ and $L(0.2) = 1.2 \Rightarrow$ error ≈ 0.02140
 (c) Since $y'' = e^x > 0$, the tangent line approximation always lies below the curve $y = e^x$. Thus $L(x) = x + 1$ never overestimates e^x .

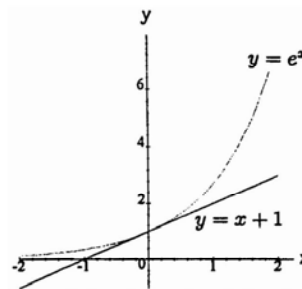

59. Note that $y = \ln x$ and $e^y = x$ are the same curve; $\int_1^a \ln x \, dx$ = area under the curve between 1 and a ;
 $\int_0^{\ln a} e^y \, dy$ = area to the left of the curve between 0 and $\ln a$. The sum of these areas is equal to the area of the rectangle $\Rightarrow \int_1^a \ln x \, dx + \int_0^{\ln a} e^y \, dy = a \ln a$.

60. (a) $y = e^x \Rightarrow y'' = e^x > 0$ for all $x \Rightarrow$ the graph of $y = e^x$ is always concave upward
 (b) area of the trapezoid $ABCD < \int_{\ln a}^{\ln b} e^x \, dx < \text{area of the trapezoid } AEF D \Rightarrow \frac{1}{2}(AB + CD)(\ln b - \ln a) < \int_{\ln a}^{\ln b} e^x \, dx < \left(\frac{e^{\ln a} + e^{\ln b}}{2}\right)(\ln b - \ln a)$. Now $\frac{1}{2}(AB + CD)$ is the height of the midpoint $M = e^{(\ln a + \ln b)/2}$ since the curve containing the points B and C is linear
 $\Rightarrow e^{(\ln a + \ln b)/2}(\ln b - \ln a) < \int_{\ln a}^{\ln b} e^x \, dx < \left(\frac{e^{\ln a} + e^{\ln b}}{2}\right)(\ln b - \ln a)$
 (c) $\int_{\ln a}^{\ln b} e^x \, dx = \left[e^x \right]_{\ln a}^{\ln b} = e^{\ln b} - e^{\ln a} = b - a$, so part (b) implies that
 $e^{(\ln a + \ln b)/2}(\ln b - \ln a) < b - a < \left(\frac{e^{\ln a} + e^{\ln b}}{2}\right)(\ln b - \ln a) \Rightarrow e^{(\ln a + \ln b)/2} < \frac{b - a}{\ln b - \ln a} < \frac{a + b}{2}$
 $\Rightarrow e^{\ln a/2} \cdot e^{\ln b/2} < \frac{b - a}{\ln b - \ln a} < \frac{a + b}{2} \Rightarrow \sqrt{e^{\ln a}} \sqrt{e^{\ln b}} < \frac{b - a}{\ln b - \ln a} < \frac{a + b}{2} \Rightarrow \sqrt{ab} < \frac{b - a}{\ln b - \ln a} < \frac{a + b}{2}$

61. $y = \ln kx \Rightarrow y = \ln x + \ln k$; thus the graph of $y = \ln kx$ is the graph of $y = \ln x$ shifted vertically by $\ln k$, $k > 0$.

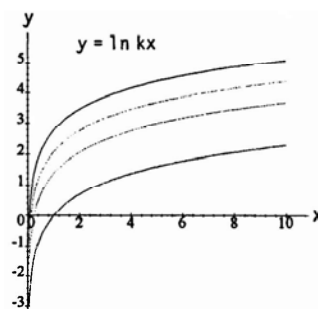

62. To turn the arches upside down we would use the formula $y = -\ln|\sin x| = \ln \frac{1}{|\sin x|}$.

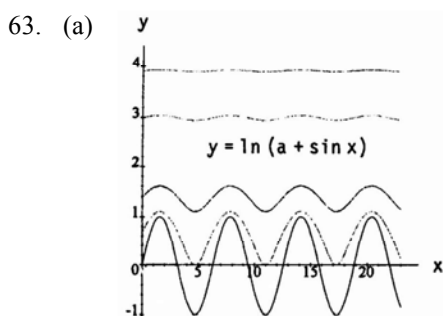
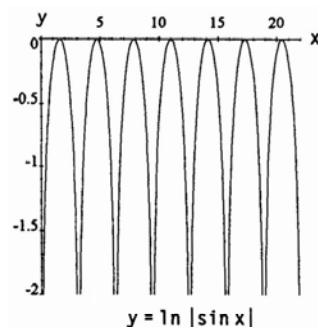

- (b) $y' = \frac{\cos x}{a + \sin x}$. Since $|\sin x|$ and $|\cos x|$ are less than or equal to 1, we have for $a > 1$, $\frac{-1}{a-1} \leq y' \leq \frac{1}{a-1}$ for all x . Thus, $\lim_{a \rightarrow +\infty} y' = 0$ for all $x \Rightarrow$ the graph of $y \rightarrow +\infty$ looks more and more horizontal as $a \rightarrow +\infty$.

64. (a) The graph of $y = \sqrt{x} - \ln x$ appears to be concave upward for all $x > 0$.

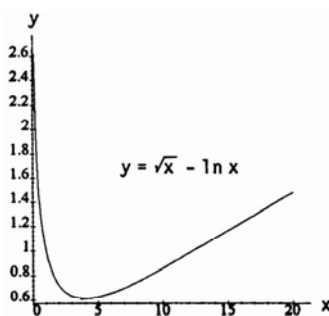

- (b) $y = \sqrt{x} - \ln x \Rightarrow y' = \frac{1}{2\sqrt{x}} - \frac{1}{x} \Rightarrow y'' = -\frac{1}{4x^{3/2}} + \frac{1}{x^2} = \frac{1}{x^2} \left(-\frac{\sqrt{x}}{4} + 1 \right) = 0 \Rightarrow \sqrt{x} = 4 \Rightarrow x = 16$
 Thus, $y'' > 0$ if $0 < x < 16$ and $y'' < 0$ if $x > 16$ so a point of inflection exists at $x = 16$. The graph of $y = \sqrt{x} - \ln x$ closely resembles a straight line for $x \geq 10$ and it is impossible to discuss the point of inflection visually from the graph.

65. From zooming in on the graph at the right, we estimate the third root to be $x \approx -0.76666$

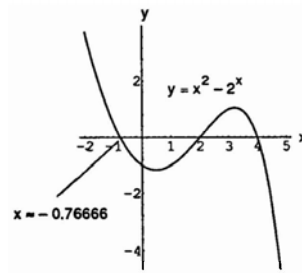

66. The functions $f(x) = x^{\ln 2}$ and $g(x) = 2^{\ln x}$ appear to have identical graphs for $x > 0$. This is no accident, because $x^{\ln 2} = e^{\ln 2 \cdot \ln x} = (e^{\ln 2})^{\ln x} = 2^{\ln x}$.

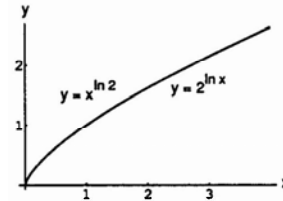

67. (a) The point of tangency is $(p, \ln p)$ and $m_{\text{tangent}} = \frac{1}{p}$ since $\frac{dy}{dx} = \frac{1}{x}$. The tangent line passes through $(0, 0) \Rightarrow$ the equation of the tangent line is $y = \frac{1}{p}x$. The tangent line also passes through $(p, \ln p) \Rightarrow \ln p = \frac{1}{p}p = 1 \Rightarrow p = e$, and the tangent line equation is $y = \frac{1}{e}x$.
- (b) $\frac{d^2y}{dx^2} = -\frac{1}{x^2}$ for $x \neq 0 \Rightarrow y = \ln x$ is concave downward over its domain. Therefore, $y = \ln x$ lies below the graph of $y = \frac{1}{e}x$ for all $x > 0, x \neq e$, and $\ln x < \frac{x}{e}$ for $x > 0, x \neq e$.
- (c) Multiplying by $e, e \ln x < x$ or $\ln x^e < x$.
- (d) Exponentiating both sides of $\ln x^e < x$, we have $e^{\ln x^e} < e^x$, or $x^e < e^x$ for all positive $x \neq e$.
- (e) Let $x = \pi$ to see that $\pi^e < e^\pi$. Therefore, e^π is bigger.

68. Using Newton's Method: $f(x) = \ln(x) - 1 \Rightarrow f'(x) = \frac{1}{x} \Rightarrow x_{n+1} = x_n - \frac{\ln(x_n) - 1}{\frac{1}{x_n}} \Rightarrow x_{n+1} = x_n[2 - \ln(x_n)]$.
Then $x_1 = 2, x_2 = 2.61370564, x_3 = 2.71624393$, and $x_5 = 2.71828183$. Many other methods may be used. For example, graph $y = \ln x - 1$ and determine the zero of y .

69. (a) $\log_3 8 = \frac{\ln 8}{\ln 3} \approx 1.89279$ (b) $\log_7 0.5 = \frac{\ln 0.5}{\ln 7} \approx -0.35621$
(c) $\log_{20} 17 = \frac{\ln 17}{\ln 20} \approx 0.94575$ (d) $\log_{0.5} 7 = \frac{\ln 7}{\ln 0.5} \approx -2.80735$
(e) $\ln x = (\log_{10} x)(\ln 10) = 2.3 \ln 10 \approx 5.29595$ (f) $\ln x = (\log_2 x)(\ln 2) = 1.4 \ln 2 \approx 0.97041$
(g) $\ln x = (\log_2 x)(\ln 2) = -1.5 \ln 2 \approx -1.03972$ (h) $\ln x = (\log_{10} x)(\ln 10) = -0.7 \ln 10 \approx -1.61181$

70. (a) $\frac{\ln 10}{\ln 2} \cdot \log_{10} x = \frac{\ln 10}{\ln 2} \cdot \frac{\ln x}{\ln 10} = \frac{\ln x}{\ln 2} = \log_2 x$ (b) $\frac{\ln a}{\ln b} \cdot \log_4 x = \frac{\ln a}{\ln b} \cdot \frac{\ln x}{\ln a} = \frac{\ln x}{\ln b} = \log_b x$

7.2 EXPONENTIAL CHANGE AND SEPARABLE DIFFERENTIAL EQUATIONS

1. (a) $y = e^{-x} \Rightarrow y' = -e^{-x} \Rightarrow 2y' + 3y = 2(-e^{-x}) + 3e^{-x} = e^{-x}$
 (b) $y = e^{-x} + e^{-3x/2} \Rightarrow y' = -e^{-x} - \frac{3}{2}e^{-3x/2} \Rightarrow 2y' + 3y = 2(-e^{-x} - \frac{3}{2}e^{-3x/2}) + 3(e^{-x} + e^{-3x/2}) = e^{-x}$
 (c) $y = e^{-x} + Ce^{-3x/2} \Rightarrow y' = -e^{-x} - \frac{3}{2}Ce^{-3x/2} \Rightarrow 2y' + 3y = 2(-e^{-x} - \frac{3}{2}Ce^{-3x/2}) + 3(e^{-x} + Ce^{-3x/2}) = e^{-x}$
2. (a) $y = -\frac{1}{x} \Rightarrow y' = \frac{1}{x^2} = \left(-\frac{1}{x}\right)^2 = y^2$
 (b) $y = -\frac{1}{x+3} \Rightarrow y' = \frac{1}{(x+3)^2} = \left[-\frac{1}{(x+3)}\right]^2 = y^2$
 (c) $y = \frac{1}{x+C} \Rightarrow y' = \frac{1}{(x+C)^2} = \left[-\frac{1}{(x+C)}\right]^2 = y^2$
3. $y = \frac{1}{x} \int_1^x \frac{e^t}{t} dt \Rightarrow y' = -\frac{1}{x^2} \int_1^x \frac{e^t}{t} dt + \left(\frac{1}{x}\right)\left(\frac{e^x}{x}\right) \Rightarrow x^2 y' = -\int_1^x \frac{e^t}{t} dt + e^x = -x\left(\frac{1}{x} \int_1^x \frac{e^t}{t} dt\right) + e^x = -xy + e^x$
 $\Rightarrow x^2 y' + xy = e^x$
4. $y = \frac{1}{\sqrt{1+x^4}} \int_1^x \sqrt{1+t^4} dt \Rightarrow y' = -\frac{1}{2} \left[\frac{4x^3}{(\sqrt{1+x^4})^3} \right] \int_1^x \sqrt{1+t^4} dt + \frac{1}{\sqrt{1+x}} (\sqrt{1+x^4})$
 $\Rightarrow y' = \left(\frac{-2x^3}{1+x^4}\right) \left(\frac{1}{\sqrt{1+x^4}} \int_1^x \sqrt{1+t^4} dt\right) + 1 \Rightarrow y' = \left(\frac{-2x^3}{1+x^4}\right) y + 1 \Rightarrow y' + \frac{2x^3}{1+x^4} \cdot y = 1$
5. $y = e^{-x} \tan^{-1}(2e^x) \Rightarrow y' = -e^{-x} \tan^{-1}(2e^x) + e^{-x} \left[\frac{1}{1+(2e^x)^2} \right] (2e^x) = -e^{-x} \tan^{-1}(2e^x) + \frac{2}{1+4e^{2x}}$
 $\Rightarrow y' = -y + \frac{2}{1+4e^{2x}} \Rightarrow y' + y = \frac{2}{1+4e^{2x}}; y(-\ln 2) = e^{-(-\ln 2)} \tan^{-1}(2e^{-\ln 2}) = 2 \tan^{-1} 1 = 2\left(\frac{\pi}{4}\right) = \frac{\pi}{2}$
6. $y = (x-2)e^{-x^2} \Rightarrow y' = e^{-x^2} + (-2xe^{-x^2})(x-2) \Rightarrow y' = e^{-x^2} - 2xy; y(2) = (2-2)e^{-2^2} = 0$
7. $y = \frac{\cos x}{x} \Rightarrow y' = \frac{-x \sin x - \cos x}{x^2} \Rightarrow y' = -\frac{\sin x}{x} - \frac{1}{x} \left(\frac{\cos x}{x}\right) \Rightarrow y' = -\frac{\sin x}{x} - \frac{y}{x} \Rightarrow xy' = -\sin x - y$
 $\Rightarrow xy' + y = -\sin x; y\left(\frac{\pi}{2}\right) = \frac{\cos(\pi/2)}{(\pi/2)} = 0$
8. $y = \frac{x}{\ln x} \Rightarrow y' = \frac{\ln x - x(\frac{1}{x})}{(\ln x)^2} \Rightarrow y' = \frac{1}{\ln x} - \frac{1}{(\ln x)^2} \Rightarrow x^2 y' = \frac{x^2}{\ln x} - \frac{x^2}{(\ln x)^2} \Rightarrow x^2 y' = xy - y^2; y(e) = \frac{e}{\ln e} = e.$
9. $2\sqrt{xy} \frac{dy}{dx} = 1 \Rightarrow 2x^{1/2} y^{1/2} dy = dx \Rightarrow 2y^{1/2} dy = x^{-1/2} dx \Rightarrow \int 2y^{1/2} dy = \int x^{-1/2} dx$
 $\Rightarrow 2\left(\frac{2}{3}y^{3/2}\right) = 2x^{1/2} + C_1 \Rightarrow \frac{2}{3}y^{3/2} - x^{1/2} = C, \text{ where } C = \frac{1}{2}C_1$
10. $\frac{dy}{dx} = x^2 \sqrt{y} \Rightarrow dy = x^2 y^{1/2} dx \Rightarrow y^{-1/2} dy = x^2 dx \Rightarrow \int y^{-1/2} dy = \int x^2 dx \Rightarrow 2y^{1/2} = \frac{x^3}{3} + C \Rightarrow 2y^{1/2} - \frac{1}{3}x^3 = C$

11. $\frac{dy}{dx} = e^{x-y} \Rightarrow dy = e^x e^{-y} dx \Rightarrow e^y dy = e^x dx \Rightarrow \int e^y dy = \int e^x dx \Rightarrow e^y = e^x + C \Rightarrow e^y - e^x = C$
12. $\frac{dy}{dx} = 3x^2 e^{-y} \Rightarrow dy = 3x^2 e^{-y} dx \Rightarrow e^y dy = 3x^2 dx \Rightarrow \int e^y dy = \int 3x^2 dx \Rightarrow e^y = x^3 + C \Rightarrow e^y - x^3 = C$
13. $\frac{dy}{dx} = \sqrt{y} \cos^2 \sqrt{y} \Rightarrow dy = (\sqrt{y} \cos^2 \sqrt{y}) dx \Rightarrow \frac{\sec^2 \sqrt{y}}{\sqrt{y}} dy = dx \Rightarrow \int \frac{\sec^2 \sqrt{y}}{\sqrt{y}} dy = \int dx$. In the integral on the left-hand side, substitute $u = \sqrt{y} \Rightarrow du = \frac{1}{2\sqrt{y}} dy \Rightarrow 2 du = \frac{1}{\sqrt{y}} dy$, and we have
 $\int \sec^2 u du = \int dx \Rightarrow 2 \tan u = x + C \Rightarrow -x + 2 \tan \sqrt{y} = C$
14. $\sqrt{2xy} \frac{dy}{dx} = 1 \Rightarrow dy = \frac{1}{\sqrt{2xy}} dx \Rightarrow \sqrt{2} \sqrt{y} dy = \frac{1}{\sqrt{x}} dx \Rightarrow \sqrt{2} y^{1/2} dy = x^{-1/2} dx \Rightarrow \sqrt{2} \int y^{1/2} dy = \int x^{-1/2} dx$
 $\Rightarrow \sqrt{2} \frac{y^{3/2}}{3/2} dy = \frac{x^{1/2}}{1/2} + C_1 \Rightarrow \sqrt{2} y^{3/2} = 3\sqrt{x} + \frac{3}{2} C_1 \Rightarrow \sqrt{2} (\sqrt{y})^3 - 3\sqrt{x} = C$, where $C = \frac{3}{2} C_1$
15. $\sqrt{x} \frac{dy}{dx} = e^{y+\sqrt{x}} \Rightarrow \frac{dy}{dx} = \frac{e^y e^{\sqrt{x}}}{\sqrt{x}} \Rightarrow dy = \frac{e^y e^{\sqrt{x}}}{\sqrt{x}} dx \Rightarrow e^{-y} dy = \frac{e^{\sqrt{x}}}{\sqrt{x}} dx \Rightarrow \int e^{-y} dy = \int \frac{e^{\sqrt{x}}}{\sqrt{x}} dx$. In the integral on the right-hand side, substitute $u = \sqrt{x} \Rightarrow du = \frac{1}{2\sqrt{x}} dx \Rightarrow 2 du = \frac{1}{\sqrt{x}} dx$, and we have
 $\int e^{-y} dy = 2 \int e^u du \Rightarrow -e^{-y} = 2e^u + C_1 \Rightarrow -e^{-y} = 2e^{\sqrt{x}} + C$, where $C = -C_1$
16. $(\sec x) \frac{dy}{dx} = e^{y+\sin x} \Rightarrow \frac{dy}{dx} = e^{y+\sin x} \cos x \Rightarrow dy = (e^y e^{\sin x} \cos x) dx \Rightarrow e^{-y} dy = e^{\sin x} \cos x dx$
 $\Rightarrow \int e^{-y} dy = \int e^{\sin x} \cos x dx \Rightarrow -e^{-y} = e^{\sin x} + C_1 \Rightarrow e^{-y} + e^{\sin x} = C$, where $C = -C_1$
17. $\frac{dy}{dx} = 2x\sqrt{1-y^2} \Rightarrow dy = 2x\sqrt{1-y^2} dx \Rightarrow \frac{dy}{\sqrt{1-y^2}} = 2x dx \Rightarrow \int \frac{dy}{\sqrt{1-y^2}} = \int 2x dx \Rightarrow \sin^{-1} y = x^2 + C$ since
 $|y| < 1 \Rightarrow y = \sin(x^2 + C)$
18. $\frac{dy}{dx} = \frac{e^{2x-y}}{e^{x+y}} \Rightarrow dy = \frac{e^{2x-y}}{e^{x+y}} dx \Rightarrow dy = \frac{e^{2x} e^{-y}}{e^x e^y} dx = \frac{e^x}{e^{2y}} dx \Rightarrow e^{2y} dy = e^x dx \Rightarrow \int e^{2y} dy = \int e^x dx \Rightarrow \frac{e^{2y}}{2} = e^x + C_1$
 $\Rightarrow e^{2y} - 2e^x = C$ where $C = 2C_1$
19. $y^2 \frac{dy}{dx} = 3x^2 y^3 - 6x^2 \Rightarrow y^2 dy = 3x^2 (y^3 - 2) dx \Rightarrow \frac{y^2}{y^3 - 2} dy = 3x^2 dx \Rightarrow \int \frac{y^2}{y^3 - 2} dy = \int 3x^2 dx$
 $\Rightarrow \frac{1}{3} \ln |y^3 - 2| = x^3 + C$
20. $\frac{dy}{dx} = xy + 3x - 2y - 6 = (y+3)(x-2) \Rightarrow \frac{1}{y+3} dy = (x-2) dx \Rightarrow \int \frac{1}{y+3} dy = \int (x-2) dx$
 $\Rightarrow \ln |y+3| = \frac{1}{2} x^2 - 2x + C$

21. $\frac{1}{x} \frac{dy}{dx} = ye^{x^2} + 2\sqrt{y}e^{x^2} = e^{x^2}(y + 2\sqrt{y}) \Rightarrow \frac{1}{y+2\sqrt{y}} dy = xe^{x^2} dx \Rightarrow \int \frac{1}{y+2\sqrt{y}} dy = \int xe^{x^2} dx$
 $\Rightarrow \int \frac{1}{\sqrt{y}(\sqrt{y}+2)} dy = \int xe^{x^2} dx \Rightarrow 2 \ln|\sqrt{y}+2| = \frac{1}{2}e^{x^2} + C \Rightarrow 4 \ln|\sqrt{y}+2| = e^{x^2} + C \Rightarrow 4 \ln(\sqrt{y}+2) = e^{x^2} + C$
22. $\frac{dy}{dx} = e^{x-y} + e^x + e^{-y} + 1 = (e^{-y} + 1)(e^x + 1) \Rightarrow \frac{1}{e^{-y}+1} dy = (e^x + 1) dx \Rightarrow \int \frac{1}{e^{-y}+1} dy = \int (e^x + 1) dx$
 $\Rightarrow \int \frac{e^y}{1+e^y} dy = \int (e^x + 1) dx \Rightarrow \ln|1+e^y| = e^x + x + C \Rightarrow \ln(1+e^y) = e^x + x + C$
23. (a) $y = y_0 e^{kt} \Rightarrow 0.99y_0 = y_0 e^{1000k} \Rightarrow k = \frac{\ln 0.99}{1000} \approx -0.00001$
 (b) $0.9 = e^{(-0.00001)t} \Rightarrow (-0.00001)t = \ln(0.9) \Rightarrow t = \frac{\ln(0.9)}{-0.00001} \approx 10,536$ years
 (c) $y = y_0 e^{(20,000)k} \approx y_0 e^{-0.2} = y_0(0.82) \Rightarrow 82\%$
24. (a) $\frac{dp}{dh} = kp \Rightarrow p = p_0 e^{kh}$ where $p_0 = 1013$; $90 = 1013e^{20k} \Rightarrow k = \frac{\ln(90) - \ln(1013)}{20} \approx -0.121$
 (b) $p = 1013e^{-6.05} \approx 2.389$ millibars
 (c) $900 = 1013e^{(-0.121)h} \Rightarrow -0.121h = \ln\left(\frac{900}{1013}\right) \Rightarrow h = \frac{\ln(1013) - \ln(900)}{0.121} \approx 0.9777$ km
25. $\frac{dy}{dt} = -0.6y \Rightarrow y = y_0 e^{-0.6t}$; $y_0 = 100 \Rightarrow y = 100e^{-0.6t} \Rightarrow y = 100e^{-0.6} \approx 54.88$ grams when $t = 1$ hr
26. $A = A_0 e^{kt} \Rightarrow 800 = 1000e^{10k} \Rightarrow k = \frac{\ln(0.8)}{10} \Rightarrow A = 1000e^{(\ln(0.8)/10)t}$, where A represents the amount of sugar that remains after time t . Thus after another 14 hrs, $A = 1000e^{(\ln(0.8)/10)24} \approx 585.35$ kg
27. $L(x) = L_0 e^{-kx} \Rightarrow \frac{L_0}{2} = L_0 e^{-18k} \Rightarrow \ln \frac{1}{2} = -18k \Rightarrow k = \frac{\ln 2}{18} \approx 0.0385 \Rightarrow L(x) = L_0 e^{-0.0385x}$; when the intensity is one-tenth of the surface value, $\frac{L_0}{10} = L_0 e^{-0.0385x} \Rightarrow \ln 10 = 0.0385x \Rightarrow x \approx 59.8$ ft
28. $V(t) = V_0 e^{-t/40} \Rightarrow 0.1V_0 = V_0 e^{-t/40}$ when the voltage is 10% of its original value $\Rightarrow t = -40 \ln(0.1) \approx 92.1$ sec
29. $y = y_0 e^{kt}$ and $y_0 = 1 \Rightarrow y = e^{kt} \Rightarrow$ at $y = 2$ and $t = 0.5$ we have $2 = e^{0.5k} \Rightarrow \ln 2 = 0.5k \Rightarrow k = \frac{\ln 2}{0.5} = \ln 4$.
 Therefore, $y = e^{(\ln 4)t} \Rightarrow y = e^{24 \ln 4} = 4^{24} = 2.81474978 \times 10^{14}$ at the end of 24 hrs
30. $y = y_0 e^{kt}$ and $y(3) = 10,000 \Rightarrow 10,000 = y_0 e^{3k}$; also $y(5) = 40,000 = y_0 e^{5k}$. Therefore $y_0 e^{5k} = 4y_0 e^{3k} \Rightarrow e^{5k} = 4e^{3k} \Rightarrow e^{2k} = 4 \Rightarrow k = \ln 2$. Thus, $y = y_0 e^{(\ln 2)t} \Rightarrow 10,000 = y_0 e^{3 \ln 2} = y_0 e^{\ln 8} \Rightarrow 10,000 = 8y_0 \Rightarrow y_0 = \frac{10,000}{8} = 1250$
31. (a) $10,000e^{k(1)} = 7500 \Rightarrow e^k = 0.75 \Rightarrow k = \ln 0.75$ and $y = 10,000e^{(\ln 0.75)t}$. Now $1000 = 10,000e^{(\ln 0.75)t} \Rightarrow \ln 0.1 = (\ln 0.75)t \Rightarrow t = \frac{\ln 0.1}{\ln 0.75} \approx 8.00$ years (to the nearest hundredth of a year)
 (b) $1 = 10,000e^{(\ln 0.75)t} \Rightarrow \ln 0.0001 = (\ln 0.75)t \Rightarrow t = \frac{\ln 0.0001}{\ln 0.75} \approx 32.02$ years (to the nearest hundredth of a year)

32. Let $z = r - ky$. Then $\frac{dz}{dt} = -k \frac{dy}{dt} = -k(r - ky) = -kz$. The equation $dz/dt = -kz$ has solution $z = ce^{-kt}$, so

$$r - ky = ce^{-kt} \text{ and } y = \frac{1}{k}(r - ce^{-kt}).$$

(a) Since $y(0) = y_0$, we have $y_0 = \frac{1}{k}(r - c)$ and thus $c = r - ky_0$. So

$$y = \frac{1}{k}(r - [r - ky_0]e^{-kt}) = \left(y_0 - \frac{r}{k}\right)e^{-kt} + \frac{r}{k}.$$

(b) Since $k > 0$, $\lim_{t \rightarrow \infty} \left[\left(y_0 - \frac{r}{k}\right)e^{-kt} + \frac{r}{k} \right] = \frac{r}{k}$.

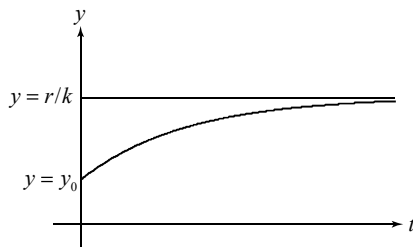

33. Let $y(t)$ be the population at time t , so $t(0) = 1147$ and we are interested in $t(20)$. If the population continues to decline at 39% per year, the population in 20 years would be $1147 \cdot (0.61)^{20} \approx 0.06 < 1$, so the species would be extinct.

34. (a) We will ignore leap years. There are $(60)(60)(24)(365) = 31,536,000$ seconds in a year. Thus, assuming exponential growth, $P = 314,419,198e^{kt}$, with t in years, and

$$314,419,199 = 314,419,198e^{12k/31,536,000} \Rightarrow k = \frac{31,536,000}{12} \ln \left(\frac{314,419,199}{314,419,198} \right) \approx 0.0083583.$$

(You don't really need to compute that logarithm: it will be very nearly equal to 1 over the denominator of the fraction.)

(b) In seven years, $P = 314,419,198e^{(0.0083583)(7)} \approx 333,664,000$. (We certainly can't estimate this population to better than six significant digits.)

35. $0.9P_0 = P_0e^k \Rightarrow k = \ln 0.9$; when the well's output falls to one-fifth of its present value $P = 0.2P_0$
 $\Rightarrow 0.2P_0 = P_0e^{(\ln 0.9)t} \Rightarrow 0.2 = e^{(\ln 0.9)t} \Rightarrow \ln(0.2) = (\ln 0.9)t \Rightarrow t = \frac{\ln 0.2}{\ln 0.9} \approx 15.28$ yr

36. (a) $\frac{dp}{dx} = -\frac{1}{100}p \Rightarrow \frac{dp}{p} = -\frac{1}{100}dx \Rightarrow \ln p = -\frac{1}{100}x + C \Rightarrow p = e^{(-0.01x+C)} = e^C e^{-0.01x} = C_1 e^{-0.01x}$;

$$p(100) = 20.09 \Rightarrow 20.09 = C_1 e^{(-0.01)(100)} \Rightarrow C_1 = 20.09e \approx 54.61 \Rightarrow p(x) = 54.61e^{-0.01x} \text{ (in dollars)}$$

(b) $p(10) = 54.61e^{(-0.01)(10)} = \49.41 , and $p(90) = 54.61e^{(-0.01)(90)} = \22.20

(c) $r(x) = xp(x) \Rightarrow r'(x) = p(x) + xp'(x)$;

$$p'(x) = -0.5461e^{-0.01x}$$

$$\Rightarrow r'(x) = (54.61 - .5461x)e^{-0.01x}. \text{ Thus,}$$

$$r'(x) = 0 \Rightarrow 54.61 = .5461x \Rightarrow x = 100. \text{ Since}$$

$r' > 0$ for any $x < 100$ and $r' < 0$ for $x > 100$,

then $r(x)$ must be a maximum at $x = 100$.

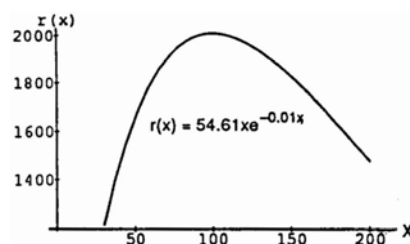

37. $A = A_0 e^{kt}$ and $A_0 = 10 \Rightarrow A = 10e^{kt}$, $5 = 10e^{k(24360)} \Rightarrow k = \frac{\ln(0.5)}{24360} \approx -0.000028454 \Rightarrow A = 10e^{-0.000028454t}$,
 then $0.2(10) = 10e^{-0.000028454t} \Rightarrow t = \frac{\ln 0.2}{-0.000028454} \approx 56563$ years
38. $A = A_0 e^{kt}$ and $\frac{1}{2}A_0 = A_0 e^{139k} \Rightarrow \frac{1}{2} = e^{139k} \Rightarrow k = \frac{\ln(0.5)}{139} \approx -0.00499$; then
 $0.05A_0 = A_0 e^{-0.00499t} \Rightarrow t = \frac{\ln 0.05}{-0.00499} \approx 600$ days
39. $y = y_0 e^{-kt} = y_0 e^{-(k)(3/k)} = y_0 e^{-3} = \frac{y_0}{e^3} < \frac{y_0}{20} = (0.05)(y_0) \Rightarrow$ after three mean lifetimes less than 5% remains
40. (a) $A = A_0 e^{-kt} \Rightarrow \frac{1}{2} = e^{-2.645k} \Rightarrow k = \frac{\ln 2}{2.645} \approx 0.262$
 (b) $\frac{1}{k} \approx 3.816$ years
 (c) $(0.05)A = A \exp\left(-\frac{\ln 2}{2.645}t\right) \Rightarrow -\ln 20 = \left(-\frac{\ln 2}{2.645}\right)t \Rightarrow t = \frac{2.645 \ln 20}{\ln 2} \approx 11.431$ years
41. $T - T_s = (T_0 - T_s)e^{-kt}$, $T_0 = 90^\circ\text{C}$, $T_s = 20^\circ\text{C}$, $T = 60^\circ\text{C} \Rightarrow 60 - 20 = 70e^{-10k} \Rightarrow \frac{4}{7} = e^{-10k}$
 $\Rightarrow k = \frac{\ln(\frac{4}{7})}{10} \approx 0.05596$
 (a) $35 - 20 = 70e^{-0.05596t} \Rightarrow t \approx 27.5$ min is the total time \Rightarrow it will take $27.5 - 10 = 17.5$ minutes longer to reach 35°C
 (b) $T - T_s = (T_0 - T_s)e^{-kt}$, $T_0 = 90^\circ\text{C}$, $T_s = -15^\circ\text{C} \Rightarrow 35 + 15 = 105e^{-0.05596t} \Rightarrow t \approx 13.26$ min
42. $T - 65^\circ = (T_0 - 65^\circ)e^{-kt} \Rightarrow 35^\circ - 65^\circ = (T_0 - 65^\circ)e^{-10k}$ and $50^\circ - 65^\circ = (T_0 - 65^\circ)e^{-20k}$. Solving
 $-30^\circ = (T_0 - 65^\circ)e^{-10k}$ and $-15^\circ = (T_0 - 65^\circ)e^{-20k}$ simultaneously $\Rightarrow (T_0 - 65^\circ)e^{-10k} = 2(T_0 - 65^\circ)e^{-20k}$
 $\Rightarrow e^{10k} = 2 \Rightarrow k = \frac{\ln 2}{10}$ and $-30^\circ = \frac{T_0 - 65^\circ}{e^{10k}} \Rightarrow -30^\circ \left[e^{10\left(\frac{\ln 2}{10}\right)} \right] = T_0 - 65^\circ \Rightarrow T_0 = 65^\circ - 30^\circ (e^{\ln 2})$
 $= 65^\circ - 60^\circ = 5^\circ$
43. $T - T_s = (T_0 - T_s)e^{-kt} \Rightarrow 39 - T_s = (46 - T_s)e^{-10k}$ and $33 - T_s = (46 - T_s)e^{-20k} \Rightarrow \frac{39 - T_s}{46 - T_s} = e^{-10k}$ and
 $\frac{33 - T_s}{46 - T_s} = e^{-20k} = \left(e^{-10k}\right)^2 \Rightarrow \frac{33 - T_s}{46 - T_s} = \left(\frac{39 - T_s}{46 - T_s}\right)^2 \Rightarrow (33 - T_s)(46 - T_s) = (39 - T_s)^2$
 $\Rightarrow 1518 - 79T_s + T_s^2 = 1521 - 78T_s + T_s^2 \Rightarrow -T_s = 3 \Rightarrow T_s = -3^\circ\text{C}$
44. Let x represent how far above room temperature the silver will be 15 min from now, y how far above room temperature the silver will be 120 min from now, and t_0 the time the silver will be 10°C above room temperature. We then have the following time-temperature table:
- | | | | | | |
|--------------|------------------|------------------|-----------|-----------|------------------|
| time in min. | 0 | 20 (Now) | 35 | 140 | t_0 |
| temperature | $T_s + 70^\circ$ | $T_s + 60^\circ$ | $T_s + x$ | $T_s + y$ | $T_s + 10^\circ$ |
- $T - T_s = (T_0 - T_s)e^{-kt} \Rightarrow (60 + T_s) - T_s = [(70 + T_s) - T_s]e^{-20k} \Rightarrow 60 = 70e^{-20k} \Rightarrow k = \left(-\frac{1}{20}\right)\ln\left(\frac{6}{7}\right) \approx 0.00771$
- (a) $T - T_s = (T_0 - T_s)e^{-0.00771t} \Rightarrow (T_s + x) - T_s = [(70 + T_s) - T_s]e^{-(0.00771)(35)} \Rightarrow x = 70e^{-0.26985} \approx 53.44^\circ\text{C}$

$$(b) \quad T - T_s = (T_0 - T_s)e^{-0.00771t} \Rightarrow (T_s + y) - T_s = [(70 + T_s) - T_s]e^{-(0.00771)(140)} \\ \Rightarrow y = 70e^{-1.0794} \approx 23.79^\circ\text{C}$$

$$(c) \quad T - T_s = (T_0 - T_s)e^{-0.00771t} \Rightarrow (T_s + 10) - T_s = [(70 + T_s) - T_s]e^{-(0.00771)t_0} \Rightarrow 10 = 70e^{-0.00771t_0} \\ \Rightarrow \ln\left(\frac{1}{7}\right) = -0.00771t_0 \Rightarrow t_0 = \left(-\frac{1}{0.00771}\right)\ln\left(\frac{1}{7}\right) = 252.39 \Rightarrow 252.39 - 20 \approx 232 \text{ minutes from now the} \\ \text{silver will be } 10^\circ\text{C above room temperature}$$

$$45. \text{ From Example 4, the half-life of carbon-14 is 5700 yr } \Rightarrow \frac{1}{2}c_0 = c_0e^{-k(5700)} \Rightarrow k = \frac{\ln 2}{5700} \approx 0.0001216 \\ \Rightarrow c = c_0e^{-0.0001216t} \Rightarrow (0.445)c_0 = c_0e^{-0.0001216t} \Rightarrow t = \frac{\ln(0.445)}{-0.0001216} \approx 6659 \text{ years}$$

46. From Exercise 45, $k \approx 0.0001216$ for carbon-14.

$$(a) \quad c = c_0e^{-0.0001216t} \Rightarrow (0.17)c_0 = c_0e^{-0.0001216t} \Rightarrow t \approx 14,571.44 \text{ years } \Rightarrow 12,571 \text{ BC}$$

$$(b) \quad (0.18)c_0 = c_0e^{-0.0001216t} \Rightarrow t \approx 14,101.41 \text{ years } \Rightarrow 12,101 \text{ BC}$$

$$(c) \quad (0.16)c_0 = c_0e^{-0.0001216t} \Rightarrow t \approx 15,069.98 \text{ years } \Rightarrow 13,070 \text{ BC}$$

$$47. \text{ From Exercise 45, } k \approx 0.0001216 \text{ for carbon-14 } \Rightarrow y = y_0e^{-0.0001216t}. \text{ When } t = 5000 \\ \Rightarrow y = y_0e^{-0.0001216(5000)} \approx 0.5444y_0 \Rightarrow \frac{y}{y_0} \approx 0.5444 \Rightarrow \text{approximately } 54.44\% \text{ remains}$$

$$48. \text{ From Exercise 45, } k \approx 0.0001216 \text{ for carbon-14. Thus, } c = c_0e^{-0.0001216t} \Rightarrow (0.995)c_0 = c_0e^{-0.0001216t} \\ \Rightarrow t = \frac{\ln(0.995)}{-0.0001216} \approx 41 \text{ years old}$$

$$49. \quad e^{-(\ln 2/5730)t} = 0.15 \Rightarrow -\frac{\ln 2}{5730}t = \ln(0.15) \Rightarrow t = -\frac{5730\ln(0.15)}{\ln 2} \approx 15,683 \text{ years}$$

$$50. (a) \quad e^{-(\ln 2/5730)(500)} \approx 0.94131, \text{ or about } 94\%.$$

$$(b) \text{ We'll assume that the error could be } 1\% \text{ of the original amount. If the percentage of carbon-14 remaining} \\ \text{were } 0.93131, \text{ the Ice Maiden's actual age would be } -\frac{5730\ln(0.93131)}{\ln 2} \approx 588 \text{ years.}$$

7.3 HYPERBOLIC FUNCTIONS

- $\sinh x = -\frac{3}{4} \Rightarrow \cosh x = \sqrt{1 + \sinh^2 x} = \sqrt{1 + \left(-\frac{3}{4}\right)^2} = \sqrt{1 + \frac{9}{16}} = \sqrt{\frac{25}{16}} = \frac{5}{4}$, $\tanh x = \frac{\sinh x}{\cosh x} = \frac{\left(-\frac{3}{4}\right)}{\left(\frac{5}{4}\right)} = -\frac{3}{5}$,
 $\coth x = \frac{1}{\tanh x} = -\frac{5}{3}$, $\operatorname{sech} x = \frac{1}{\cosh x} = \frac{4}{5}$, and $\operatorname{csch} x = \frac{1}{\sinh x} = -\frac{4}{3}$
- $\sinh x = \frac{4}{3} \Rightarrow \cosh x = \sqrt{1 + \sinh^2 x} = \sqrt{1 + \frac{16}{9}} = \sqrt{\frac{25}{9}} = \frac{5}{3}$, $\tanh x = \frac{\sinh x}{\cosh x} = \frac{\left(\frac{4}{3}\right)}{\left(\frac{5}{3}\right)} = \frac{4}{5}$, $\coth x = \frac{1}{\tanh x} = \frac{5}{4}$,
 $\operatorname{sech} x = \frac{1}{\cosh x} = \frac{3}{5}$, and $\operatorname{csch} x = \frac{1}{\sinh x} = \frac{3}{4}$
- $\cosh x = \frac{17}{15}, x > 0 \Rightarrow \sinh x = \sqrt{\cosh^2 x - 1} = \sqrt{\left(\frac{17}{15}\right)^2 - 1} = \sqrt{\frac{289}{225} - 1} = \sqrt{\frac{64}{225}} = \frac{8}{15}$, $\tanh x = \frac{\sinh x}{\cosh x} = \frac{\left(\frac{8}{15}\right)}{\left(\frac{17}{15}\right)} = \frac{8}{17}$,
 $\coth x = \frac{1}{\tanh x} = \frac{17}{8}$, $\operatorname{sech} x = \frac{1}{\cosh x} = \frac{15}{17}$, and $\operatorname{csch} x = \frac{1}{\sinh x} = \frac{15}{8}$
- $\cosh x = \frac{13}{5}, x > 0 \Rightarrow \sinh x = \sqrt{\cosh^2 x - 1} = \sqrt{\frac{169}{25} - 1} = \sqrt{\frac{144}{25}} = \frac{12}{5}$, $\tanh x = \frac{\sinh x}{\cosh x} = \frac{\left(\frac{12}{5}\right)}{\left(\frac{13}{5}\right)} = \frac{12}{13}$,
 $\coth x = \frac{1}{\tanh x} = \frac{13}{12}$, $\operatorname{sech} x = \frac{1}{\cosh x} = \frac{5}{13}$, and $\operatorname{csch} x = \frac{1}{\sinh x} = \frac{5}{12}$
- $2 \cosh(\ln x) = 2 \left(\frac{e^{\ln x} + e^{-\ln x}}{2} \right) = e^{\ln x} + \frac{1}{e^{\ln x}} = x + \frac{1}{x}$
- $\sinh(2 \ln x) = \frac{e^{2 \ln x} - e^{-2 \ln x}}{2} = \frac{e^{\ln x^2} - e^{-\ln x^2}}{2} = \frac{\left(x^2 - \frac{1}{x^2}\right)}{2} = \frac{x^4 - 1}{2x^2}$
- $\cosh 5x + \sinh 5x = \frac{e^{5x} + e^{-5x}}{2} + \frac{e^{5x} - e^{-5x}}{2} = e^{5x}$
- $\cosh 3x - \sinh 3x = \frac{e^{3x} + e^{-3x}}{2} - \frac{e^{3x} - e^{-3x}}{2} = e^{-3x}$
- $(\sinh x + \cosh x)^4 = \left(\frac{e^x - e^{-x}}{2} + \frac{e^x + e^{-x}}{2} \right)^4 = (e^x)^4 = e^{4x}$
- $\ln(\cosh x + \sinh x) + \ln(\cosh x - \sinh x) = \ln(\cosh^2 x - \sinh^2 x) = \ln 1 = 0$
- $\sinh 2x = \sinh(x+x) = \sinh x \cosh x + \cosh x \sinh x = 2 \sinh x \cosh x$
 - $\cosh 2x = \cosh(x+x) = \cosh x \cosh x + \sinh x \sinh x = \cosh^2 x + \sinh^2 x$
- $\cosh^2 x - \sinh^2 x = \left(\frac{e^x + e^{-x}}{2} \right)^2 - \left(\frac{e^x - e^{-x}}{2} \right)^2 = \frac{1}{4} \left[(e^x + e^{-x}) + (e^x - e^{-x}) \right] \left[(e^x + e^{-x}) - (e^x - e^{-x}) \right]$
 $= \frac{1}{4} (2e^x) (2e^{-x}) = \frac{1}{4} (4e^0) = \frac{1}{4} (4) = 1$
- $y = 6 \sinh \frac{x}{3} \Rightarrow \frac{dy}{dx} = 6 \left(\cosh \frac{x}{3} \right) \left(\frac{1}{3} \right) = 2 \cosh \frac{x}{3}$

$$14. y = \frac{1}{2} \sinh(2x+1) \Rightarrow \frac{dy}{dx} = \frac{1}{2} [\cosh(2x+1)](2) = \cosh(2x+1)$$

$$15. y = 2\sqrt{t} \tanh \sqrt{t} = 2t^{1/2} \tanh t^{1/2} \Rightarrow \frac{dy}{dt} = \left[\operatorname{sech}^2(t^{1/2}) \left(\frac{1}{2} t^{-1/2} \right) \right] (2t^{1/2}) + (\tanh t^{1/2}) (t^{-1/2}) = \operatorname{sech}^2 \sqrt{t} + \frac{\tanh \sqrt{t}}{\sqrt{t}}$$

$$16. y = t^2 \tanh \frac{1}{t} = t^2 \tanh t^{-1} \Rightarrow \frac{dy}{dt} = \left[\operatorname{sech}^2(t^{-1}) (-t^{-2}) \right] (t^2) + (2t) (\tanh t^{-1}) = -\operatorname{sech}^2 \frac{1}{t} + 2t \tanh \frac{1}{t}$$

$$17. y = \ln(\sinh z) \Rightarrow \frac{dy}{dz} = \frac{\cosh z}{\sinh z} = \coth z$$

$$18. y = \ln(\cosh z) \Rightarrow \frac{dy}{dz} = \frac{\sinh z}{\cosh z} = \tanh z$$

$$\begin{aligned} 19. y = (\operatorname{sech} \theta)(1 - \ln \operatorname{sech} \theta) &\Rightarrow \frac{dy}{d\theta} = \left(-\frac{-\operatorname{sech} \theta \tanh \theta}{\operatorname{sech} \theta} \right) (\operatorname{sech} \theta) + (-\operatorname{sech} \theta \tanh \theta) (1 - \ln \operatorname{sech} \theta) \\ &= \operatorname{sech} \theta \tanh \theta - (\operatorname{sech} \theta \tanh \theta) (1 - \ln \operatorname{sech} \theta) = (\operatorname{sech} \theta \tanh \theta) [1 - (1 - \ln \operatorname{sech} \theta)] \\ &= (\operatorname{sech} \theta \tanh \theta) (\ln \operatorname{sech} \theta) \end{aligned}$$

$$\begin{aligned} 20. y = (\operatorname{csch} \theta)(1 - \ln \operatorname{csch} \theta) &\Rightarrow \frac{dy}{d\theta} = (\operatorname{csch} \theta) \left(-\frac{-\operatorname{csch} \theta \coth \theta}{\operatorname{csch} \theta} \right) + (1 - \ln \operatorname{csch} \theta) (-\operatorname{csch} \theta \coth \theta) \\ &= \operatorname{csch} \theta \coth \theta - (1 - \ln \operatorname{csch} \theta) (\operatorname{csch} \theta \coth \theta) = (\operatorname{csch} \theta \coth \theta) (1 - 1 + \ln \operatorname{csch} \theta) \\ &= (\operatorname{csch} \theta \coth \theta) (\ln \operatorname{csch} \theta) \end{aligned}$$

$$\begin{aligned} 21. y = \ln \coth v - \frac{1}{2} \tanh^2 v &\Rightarrow \frac{dy}{dv} = \frac{\sinh v}{\cosh v} - \left(\frac{1}{2} \right) (2 \tanh v) (\operatorname{sech}^2 v) = \tanh v - (\tanh v) (\operatorname{sech}^2 v) \\ &= (\tanh v) (1 - \operatorname{sech}^2 v) = (\tanh v) (\tanh^2 v) = \tanh^3 v \end{aligned}$$

$$\begin{aligned} 22. y = \ln \sinh v - \frac{1}{2} \coth^2 v &\Rightarrow \frac{dy}{dv} = \frac{\cosh v}{\sinh v} - \left(\frac{1}{2} \right) (2 \coth v) (-\operatorname{csch}^2 v) = \coth v + (\coth v) (\operatorname{csch}^2 v) \\ &= (\coth v) (1 + \operatorname{csch}^2 v) = (\coth v) (\coth^2 v) = \coth^3 v \end{aligned}$$

$$23. y = (x^2 + 1) \operatorname{sech}(\ln x) = (x^2 + 1) \left(\frac{2}{e^{\ln x} + e^{-\ln x}} \right) = (x^2 + 1) \left(\frac{2}{x + x^{-1}} \right) = (x^2 + 1) \left(\frac{2x}{x^2 + 1} \right) = 2x \Rightarrow \frac{dy}{dx} = 2$$

$$24. y = (4x^2 - 1) \operatorname{csch}(\ln 2x) = (4x^2 - 1) \left(\frac{2}{e^{\ln 2x} - e^{-\ln 2x}} \right) = (4x^2 - 1) \left(\frac{2}{2x - (2x)^{-1}} \right) = (4x^2 - 1) \left(\frac{4x}{4x^2 - 1} \right) = 4x \Rightarrow \frac{dy}{dx} = 4$$

$$25. y = \sinh^{-1} \sqrt{x} = \sinh^{-1} (x^{1/2}) \Rightarrow \frac{dy}{dx} = \frac{\left(\frac{1}{2} \right) x^{-1/2}}{\sqrt{1 + (x^{1/2})^2}} = \frac{1}{2\sqrt{x}\sqrt{1+x}} = \frac{1}{2\sqrt{x(1+x)}}$$

$$26. y = \cosh^{-1} 2\sqrt{x+1} = \cosh^{-1} \left(2(x+1)^{1/2} \right) \Rightarrow \frac{dy}{dx} = \frac{(2) \left(\frac{1}{2} \right) (x+1)^{-1/2}}{\sqrt{[2(x+1)^{1/2}]^2 - 1}} = \frac{1}{\sqrt{x+1}\sqrt{4x+3}} = \frac{1}{\sqrt{4x^2+7x+3}}$$

$$27. y = (1 - \theta) \tanh^{-1} \theta \Rightarrow \frac{dy}{d\theta} = (1 - \theta) \left(\frac{1}{1 - \theta^2} \right) + (-1) \tanh^{-1} \theta = \frac{1}{1 + \theta} - \tanh^{-1} \theta$$

$$28. \quad y = (\theta^2 + 2\theta) \tanh^{-1}(\theta + 1) \Rightarrow \frac{dy}{d\theta} = (\theta^2 + 2\theta) \left[\frac{1}{1 - (\theta + 1)^2} \right] + (2\theta + 2) \tanh^{-1}(\theta + 1) \\ = \frac{\theta^2 + 2\theta}{-\theta^2 - 2\theta} + (2\theta + 2) \tanh^{-1}(\theta + 1) = (2\theta + 2) \tanh^{-1}(\theta + 1) - 1$$

$$29. \quad y = (1 - t) \coth^{-1} \sqrt{t} = (1 - t) \coth^{-1}(t^{1/2}) \Rightarrow \frac{dy}{dt} = (1 - t) \left[\frac{(\frac{1}{2})t^{-1/2}}{1 - (t^{1/2})^2} \right] + (-1) \coth^{-1}(t^{1/2}) = \frac{1}{2\sqrt{t}} - \coth^{-1} \sqrt{t}$$

$$30. \quad y = (1 - t^2) \coth^{-1} t \Rightarrow \frac{dy}{dt} = (1 - t^2) \left(\frac{1}{1 - t^2} \right) + (-2t) \coth^{-1} t = 1 - 2t \coth^{-1} t$$

$$31. \quad y = \cos^{-1} x - x \operatorname{sech}^{-1} x \Rightarrow \frac{dy}{dx} = \frac{-1}{\sqrt{1 - x^2}} - \left[x \left(\frac{-1}{x\sqrt{1 - x^2}} \right) + (1) \operatorname{sech}^{-1} x \right] = \frac{-1}{\sqrt{1 - x^2}} + \frac{1}{\sqrt{1 - x^2}} - \operatorname{sech}^{-1} x = -\operatorname{sech}^{-1} x$$

$$32. \quad y = \ln x + \sqrt{1 - x^2} \operatorname{sech}^{-1} x = \ln x + (1 - x^2)^{1/2} \operatorname{sech}^{-1} x \\ \Rightarrow \frac{dy}{dx} = \frac{1}{x} + (1 - x^2)^{1/2} \left(\frac{-1}{x\sqrt{1 - x^2}} \right) + \left(\frac{1}{2} \right) (1 - x^2)^{-1/2} (-2x) \operatorname{sech}^{-1} x = \frac{1}{x} - \frac{1}{x} - \frac{x}{\sqrt{1 - x^2}} \operatorname{sech}^{-1} x = \frac{-x}{\sqrt{1 - x^2}} \operatorname{sech}^{-1} x$$

$$33. \quad y = \operatorname{csch}^{-1} \left(\frac{1}{2} \right)^\theta \Rightarrow \frac{dy}{d\theta} = - \frac{\left[\ln \left(\frac{1}{2} \right) \right] \left(\frac{1}{2} \right)^\theta}{\left(\frac{1}{2} \right)^\theta \sqrt{1 + \left[\left(\frac{1}{2} \right)^\theta \right]^2}} = - \frac{\ln(1) - \ln(2)}{\sqrt{1 + \left(\frac{1}{2} \right)^{2\theta}}} = \frac{\ln 2}{\sqrt{1 + \left(\frac{1}{2} \right)^{2\theta}}}$$

$$34. \quad y = \operatorname{csch}^{-1} 2^\theta \Rightarrow \frac{dy}{d\theta} = - \frac{(\ln 2) 2^\theta}{2^\theta \sqrt{1 + (2^\theta)^2}} = \frac{-\ln 2}{\sqrt{1 + 2^{2\theta}}}$$

$$35. \quad y = \sinh^{-1}(\tan x) \Rightarrow \frac{dy}{dx} = \frac{\sec^2 x}{\sqrt{1 + (\tan x)^2}} = \frac{\sec^2 x}{\sqrt{\sec^2 x}} = \frac{\sec^2 x}{|\sec x|} = \frac{|\sec x| |\sec x|}{|\sec x|} = |\sec x|$$

$$36. \quad y = \cosh^{-1}(\sec x) \Rightarrow \frac{dy}{dx} = \frac{(\sec x)(\tan x)}{\sqrt{\sec^2 x - 1}} = \frac{(\sec x)(\tan x)}{\sqrt{\tan^2 x}} = \frac{(\sec x)(\tan x)}{|\tan x|} = \sec x, \quad 0 < x < \frac{\pi}{2}$$

$$37. \quad \text{(a) If } y = \tan^{-1}(\sinh x) + C, \text{ then } \frac{dy}{dx} = \frac{\cosh x}{1 + \sinh^2 x} = \frac{\cosh x}{\cosh^2 x} = \operatorname{sech} x, \text{ which verifies the formula}$$

$$\text{(b) If } y = \sin^{-1}(\tanh x) + C, \text{ then } \frac{dy}{dx} = \frac{\operatorname{sech}^2 x}{\sqrt{1 - \tanh^2 x}} = \frac{\operatorname{sech}^2 x}{\operatorname{sech} x} = \operatorname{sech} x, \text{ which verifies the formula}$$

$$38. \quad \text{If } y = \frac{x^2}{2} \operatorname{sech}^{-1} x - \frac{1}{2} \sqrt{1 - x^2} + C, \text{ then } \frac{dy}{dx} = x \operatorname{sech}^{-1} x + \frac{x^2}{2} \left(\frac{-1}{x\sqrt{1 - x^2}} \right) + \frac{2x}{4\sqrt{1 - x^2}} = x \operatorname{sech}^{-1} x, \text{ which verifies the formula}$$

$$39. \quad \text{If } y = \frac{x^2 - 1}{2} \coth^{-1} x + \frac{x}{2} + C, \text{ then } \frac{dy}{dx} = x \coth^{-1} x + \left(\frac{x^2 - 1}{2} \right) \left(\frac{1}{1 - x^2} \right) + \frac{1}{2} = x \coth^{-1} x, \text{ which verifies the formula}$$

40. If $y = x \tanh^{-1} x + \frac{1}{2} \ln(1-x^2) + C$, then $\frac{dy}{dx} = \tanh^{-1} x + x \left(\frac{1}{1-x^2} \right) + \frac{1}{2} \left(\frac{-2x}{1-x^2} \right) = \tanh^{-1} x$, which verifies the formula

$$41. \int \sinh 2x \, dx = \frac{1}{2} \int \sinh u \, du, \text{ where } u = 2x \text{ and } du = 2 \, dx \\ = \frac{\cosh u}{2} + C = \frac{\cosh 2x}{2} + C$$

$$42. \int \sinh \frac{x}{5} \, dx = 5 \int \sinh u \, du, \text{ where } u = \frac{x}{5} \text{ and } du = \frac{1}{5} \, dx \\ = 5 \cosh u + C = 5 \cosh \frac{x}{5} + C$$

$$43. \int 6 \cosh \left(\frac{x}{2} - \ln 3 \right) dx = 12 \int \cosh u \, du, \text{ where } u = \frac{x}{2} - \ln 3 \text{ and } du = \frac{1}{2} \, dx \\ = 12 \sinh u + C = 12 \sinh \left(\frac{x}{2} - \ln 3 \right) + C$$

$$44. \int 4 \cosh (3x - \ln 2) \, dx = \frac{4}{3} \int \cosh u \, du, \text{ where } u = 3x - \ln 2 \text{ and } du = 3 \, dx \\ = \frac{4}{3} \sinh u + C = \frac{4}{3} \sinh(3x - \ln 2) + C$$

$$45. \int \tanh \frac{x}{7} \, dx = 7 \int \frac{\sinh u}{\cosh u} \, du, \text{ where } u = \frac{x}{7} \text{ and } du = \frac{1}{7} \, dx \\ = 7 \ln |\cosh u| + C_1 = 7 \ln \left| \cosh \frac{x}{7} \right| + C_1 = 7 \ln \left| \frac{e^{x/7} + e^{-x/7}}{2} \right| + C_1 = 7 \ln \left| e^{x/7} + e^{-x/7} \right| - 7 \ln 2 + C_1 \\ = 7 \ln \left| e^{x/7} + e^{-x/7} \right| + C$$

$$46. \int \coth \frac{\theta}{\sqrt{3}} \, d\theta = \sqrt{3} \int \frac{\cosh u}{\sinh u} \, du, \text{ where } u = \frac{\theta}{\sqrt{3}} \text{ and } du = \frac{d\theta}{\sqrt{3}} \\ = \sqrt{3} \ln |\sinh u| + C_1 = \sqrt{3} \ln \left| \sinh \frac{\theta}{\sqrt{3}} \right| + C_1 = \sqrt{3} \ln \left| \frac{e^{\theta/\sqrt{3}} - e^{-\theta/\sqrt{3}}}{2} \right| + C_1 \\ = \sqrt{3} \ln \left| e^{\theta/\sqrt{3}} - e^{-\theta/\sqrt{3}} \right| - \sqrt{3} \ln 2 + C_1 = \sqrt{3} \ln \left| e^{\theta/\sqrt{3}} - e^{-\theta/\sqrt{3}} \right| + C$$

$$47. \int \operatorname{sech}^2 \left(x - \frac{1}{2} \right) dx = \int \operatorname{sech}^2 u \, du, \text{ where } u = \left(x - \frac{1}{2} \right) \text{ and } du = dx \\ = \tanh u + C = \tanh \left(x - \frac{1}{2} \right) + C$$

$$48. \int \operatorname{csch}^2 (5-x) \, dx = - \int \operatorname{csch}^2 u \, du, \text{ where } u = (5-x) \text{ and } du = -dx \\ = -(-\coth u) + C = \coth u + C = \coth (5-x) + C$$

$$49. \int \frac{\operatorname{sech} \sqrt{t} \tanh \sqrt{t}}{\sqrt{t}} \, dt = 2 \int \operatorname{sech} u \tanh u \, du, \text{ where } u = \sqrt{t} = t^{1/2} \text{ and } du = \frac{dt}{2\sqrt{t}} \\ = 2(-\operatorname{sech} u) + C = -2 \operatorname{sech} \sqrt{t} + C$$

$$50. \int \frac{\operatorname{csch}(\ln t) \coth(\ln t)}{t} \, dt = \int \operatorname{csch} u \coth u \, du, \text{ where } u = \ln t \text{ and } du = \frac{dt}{t} \\ = -\operatorname{csch} u + C = -\operatorname{csch}(\ln t) + C$$

51. $\int_{\ln 2}^{\ln 4} \coth x \, dx = \int_{\ln 2}^{\ln 4} \frac{\cosh x}{\sinh x} \, dx = \int_{3/4}^{15/8} \frac{1}{u} \, du$ where $u = \sinh x, du = \cosh x \, dx$;
 $x = \ln 2 \Rightarrow u = \sinh(\ln 2) = \frac{e^{\ln 2} - e^{-\ln 2}}{2} = \frac{2 - (\frac{1}{2})}{2} = \frac{3}{4}, x = \ln 4 \Rightarrow u = \sinh(\ln 4) = \frac{e^{\ln 4} - e^{-\ln 4}}{2} = \frac{4 - (\frac{1}{4})}{2} = \frac{15}{8}$
 $= [\ln |u|]_{3/4}^{15/8} = \ln \left| \frac{15}{8} \right| - \ln \left| \frac{3}{4} \right| = \ln \left| \frac{15}{8} \cdot \frac{4}{3} \right| = \ln \frac{5}{2}$
52. $\int_0^{\ln 2} \tanh 2x \, dx = \int_0^{\ln 2} \frac{\sinh 2x}{\cosh 2x} \, dx = \frac{1}{2} \int_1^{17/8} \frac{1}{u} \, du$ where $u = \cosh 2x, du = 2 \sinh(2x) \, dx$,
 $x = 0 \Rightarrow u = \cosh 0 = 1, x = \ln 2 \Rightarrow u = \cosh(2 \ln 2) = \cosh(\ln 4) = \frac{e^{\ln 4} + e^{-\ln 4}}{2} = \frac{4 + (\frac{1}{4})}{2} = \frac{17}{8}$
 $= \frac{1}{2} [\ln |u|]_1^{17/8} = \frac{1}{2} [\ln(\frac{17}{8}) - \ln 1] = \frac{1}{2} \ln \frac{17}{8}$
53. $\int_{-\ln 4}^{-\ln 2} 2e^\theta \cosh \theta \, d\theta = \int_{-\ln 4}^{-\ln 2} 2e^\theta \left(\frac{e^\theta + e^{-\theta}}{2} \right) d\theta = \int_{-\ln 4}^{-\ln 2} (e^{2\theta} + 1) d\theta = \left[\frac{e^{2\theta}}{2} + \theta \right]_{-\ln 4}^{-\ln 2}$
 $= \left(\frac{e^{-2 \ln 2}}{2} - \ln 2 \right) - \left(\frac{e^{-2 \ln 4}}{2} - \ln 4 \right) = \left(\frac{1}{8} - \ln 2 \right) - \left(\frac{1}{32} - \ln 4 \right) = \frac{3}{32} - \ln 2 + 2 \ln 2 = \frac{3}{32} + \ln 2$
54. $\int_0^{\ln 2} 4e^{-\theta} \sinh \theta \, d\theta = \int_0^{\ln 2} 4e^{-\theta} \left(\frac{e^\theta - e^{-\theta}}{2} \right) d\theta = 2 \int_0^{\ln 2} (1 - e^{-2\theta}) \, d\theta = 2 \left[\theta + \frac{e^{-2\theta}}{2} \right]_0^{\ln 2}$
 $= 2 \left[\left(\ln 2 + \frac{e^{-2 \ln 2}}{2} \right) - \left(0 + \frac{e^0}{2} \right) \right] = 2 \left(\ln 2 + \frac{1}{8} - \frac{1}{2} \right) = 2 \ln 2 + \frac{1}{4} - 1 = \ln 4 - \frac{3}{4}$
55. $\int_{-\pi/4}^{\pi/4} \cosh(\tan \theta) \sec^2 \theta \, d\theta = \int_{-1}^1 \cosh u \, du$ where $u = \tan \theta, du = \sec^2 \theta \, d\theta, x = -\frac{\pi}{4} \Rightarrow u = -1, x = \frac{\pi}{4} \Rightarrow u = 1$,
 $= [\sinh u]_{-1}^1 = \sinh(1) - \sinh(-1) = \left(\frac{e^1 - e^{-1}}{2} \right) - \left(\frac{e^{-1} - e^1}{2} \right) = \frac{e - e^{-1} - e^{-1} + e}{2} = e - e^{-1}$
56. $\int_0^{\pi/2} 2 \sinh(\sin \theta) \cos \theta \, d\theta = 2 \int_0^1 \sinh u \, du$ where $u = \sin \theta, du = \cos \theta \, d\theta, x = 0 \Rightarrow u = 0, x = \frac{\pi}{2} \Rightarrow u = 1$
 $= 2 [\cosh u]_0^1 = 2(\cosh 1 - \cosh 0) = 2 \left(\frac{e + e^{-1}}{2} - 1 \right) = e + e^{-1} - 2$
57. $\int_1^2 \frac{\cosh(\ln t)}{t} \, dt = \int_0^{\ln 2} \cosh u \, du$ where $u = \ln t, du = \frac{1}{t} \, dt, x = 1 \Rightarrow u = 0, x = 2 \Rightarrow u = \ln 2$
 $= [\sinh u]_0^{\ln 2} = \sinh(\ln 2) - \sinh(0) = \frac{e^{\ln 2} - e^{-\ln 2}}{2} - 0 = \frac{2 - \frac{1}{2}}{2} = \frac{3}{4}$
58. $\int_1^4 \frac{8 \cosh \sqrt{x}}{\sqrt{x}} \, dx = 16 \int_1^2 \cosh u \, du$ where $u = \sqrt{x} = x^{1/2}, du = \frac{1}{2} x^{-1/2} \, dx = \frac{dx}{2\sqrt{x}}, x = 1 \Rightarrow u = 1, x = 4 \Rightarrow u = 2$
 $= 16 [\sinh u]_1^2 = 16(\sinh 2 - \sinh 1) = 16 \left[\left(\frac{e^2 - e^{-2}}{2} \right) - \left(\frac{e - e^{-1}}{2} \right) \right] = 8(e^2 - e^{-2} - e + e^{-1})$
59. $\int_{-\ln 2}^0 \cosh^2 \left(\frac{x}{2} \right) dx = \int_{-\ln 2}^0 \frac{\cosh x + 1}{2} \, dx = \frac{1}{2} \int_{-\ln 2}^0 (\cosh x + 1) \, dx = \frac{1}{2} [\sinh x + x]_{-\ln 2}^0$
 $= \frac{1}{2} [(\sinh 0 + 0) - (\sinh(-\ln 2) - \ln 2)] = \frac{1}{2} [(0 + 0) - \left(\frac{e^{-\ln 2} - e^{\ln 2}}{2} - \ln 2 \right)] = \frac{1}{2} \left[-\frac{(\frac{1}{2}) - 2}{2} + \ln 2 \right] = \frac{1}{2} \left(1 - \frac{1}{4} + \ln 2 \right)$
 $= \frac{3}{8} + \frac{1}{2} \ln 2 = \frac{3}{8} + \ln \sqrt{2}$

60. $\int_0^{\ln 10} 4 \sinh^2\left(\frac{x}{2}\right) dx = \int_0^{\ln 10} 4\left(\frac{\cosh x - 1}{2}\right) dx = 2 \int_0^{\ln 10} (\cosh x - 1) dx = 2 [\sinh x - x]_0^{\ln 10}$
 $= 2[(\sinh(\ln 10) - \ln 10) - (\sinh 0 - 0)] = e^{\ln 10} - e^{-\ln 10} - 2 \ln 10 = 10 - \frac{1}{10} - 2 \ln 10 = 9.9 - 2 \ln 10$
61. $\sinh^{-1}\left(\frac{-5}{12}\right) = \ln\left(-\frac{5}{12} + \sqrt{\frac{25}{144} + 1}\right) = \ln\left(\frac{2}{3}\right)$ 62. $\cosh^{-1}\left(\frac{5}{3}\right) = \ln\left(\frac{5}{3} + \sqrt{\frac{25}{9} - 1}\right) = \ln 3$
63. $\tanh^{-1}\left(-\frac{1}{2}\right) = \frac{1}{2} \ln\left(\frac{1-(1/2)}{1+(1/2)}\right) = -\frac{\ln 3}{3}$ 64. $\coth^{-1}\left(\frac{5}{4}\right) = \frac{1}{2} \ln\left(\frac{(9/4)}{(1/4)}\right) = \frac{1}{2} \ln 9 = \ln 3$
65. $\operatorname{sech}^{-1}\left(\frac{3}{5}\right) = \ln\left(\frac{1+\sqrt{1-(9/25)}}{(3/5)}\right) = \ln 3$ 66. $\operatorname{csch}^{-1}\left(-\frac{1}{\sqrt{3}}\right) = \ln\left(-\sqrt{3} + \frac{\sqrt{4/3}}{(1/\sqrt{3})}\right) = \ln(-\sqrt{3} + 2)$
67. (a) $\int_0^{2\sqrt{3}} \frac{dx}{\sqrt{4+x^2}} = \left[\sinh^{-1} \frac{x}{2}\right]_0^{2\sqrt{3}} = \sinh^{-1} \sqrt{3} - \sinh^{-1} 0 = \sinh^{-1} \sqrt{3}$
 (b) $\sinh^{-1} \sqrt{3} = \ln(\sqrt{3} + \sqrt{3+1}) = \ln(\sqrt{3} + 2)$
68. (a) $\int_0^{1/3} \frac{6dx}{\sqrt{1+9x^2}} = 2 \int_0^1 \frac{dx}{\sqrt{a^2+u^2}}$, where $u = 3x, du = 3 dx, a = 1$
 $= \left[2 \sinh^{-1} u\right]_0^1 = 2(\sinh^{-1} 1 - \sinh^{-1} 0) = 2 \sinh^{-1} 1$
 (b) $2 \sinh^{-1} 1 = 2 \ln(1 + \sqrt{1^2 + 1}) = 2 \ln(1 + \sqrt{2})$
69. (a) $\int_{5/4}^2 \frac{1}{1-x^2} dx = \left[\coth^{-1} x\right]_{5/4}^2 = \coth^{-1} 2 - \coth^{-1} \frac{5}{4}$
 (b) $\coth^{-1} 2 - \coth^{-1} \frac{5}{4} = \frac{1}{2} \left[\ln 3 - \ln\left(\frac{9/4}{1/4}\right)\right] = \frac{1}{2} \ln \frac{1}{3}$
70. (a) $\int_0^{1/2} \frac{1}{1-x^2} dx = \left[\tanh^{-1} x\right]_0^{1/2} = \tanh^{-1} \frac{1}{2} - \tanh^{-1} 0 = \tanh^{-1} \frac{1}{2}$
 (b) $\tanh^{-1} \frac{1}{2} = \frac{1}{2} \ln\left(\frac{1+(1/2)}{1-(1/2)}\right) = \frac{1}{2} \ln 3$
71. (a) $\int_{1/5}^{3/13} \frac{dx}{x\sqrt{1-16x^2}} = \int_{4/5}^{12/13} \frac{du}{u\sqrt{a^2-u^2}}$, $u = 4x, du = 4 dx, a = 1$
 $= \left[-\operatorname{sech}^{-1} u\right]_{4/5}^{12/13} = -\operatorname{sech}^{-1} \frac{12}{13} + \operatorname{sech}^{-1} \frac{4}{5}$
 (b) $-\operatorname{sech}^{-1} \frac{12}{13} + \operatorname{sech}^{-1} \frac{4}{5} = -\ln\left(\frac{1+\sqrt{1-(12/13)^2}}{(12/13)}\right) + \ln\left(\frac{1+\sqrt{1-(4/5)^2}}{(4/5)}\right) = -\ln\left(\frac{13+\sqrt{169-144}}{12}\right) + \ln\left(\frac{5+\sqrt{25-16}}{4}\right)$
 $= \ln\left(\frac{5+3}{4}\right) - \ln\left(\frac{13+5}{12}\right) = \ln 2 - \ln \frac{3}{2} = \ln\left(2 \cdot \frac{2}{3}\right) = \ln \frac{4}{3}$
72. (a) $\int_1^2 \frac{dx}{x\sqrt{4+x^2}} = \left[-\frac{1}{2} \operatorname{csch}^{-1} \left|\frac{x}{2}\right|\right]_1^2 = -\frac{1}{2}(\operatorname{csch}^{-1} 1 - \operatorname{csch}^{-1} \frac{1}{2}) = \frac{1}{2}(\operatorname{csch}^{-1} \frac{1}{2} - \operatorname{csch}^{-1} 1)$
 (b) $\frac{1}{2}(\operatorname{csch}^{-1} \frac{1}{2} - \operatorname{csch}^{-1} 1) = \frac{1}{2} \left[\ln\left(2 + \frac{\sqrt{5/4}}{(1/2)}\right) - \ln(1 + \sqrt{2})\right] = \frac{1}{2} \ln\left(\frac{2+\sqrt{5}}{1+\sqrt{2}}\right)$

73. (a) $\int_0^\pi \frac{\cos x}{\sqrt{1+\sin^2 x}} dx = \int_0^0 \frac{1}{\sqrt{1+u^2}} du$ where $u = \sin x, du = \cos x dx$;
 $= \left[\sinh^{-1} u \right]_0^0 = \sinh^{-1} 0 - \sinh^{-1} 0 = 0$

(b) $\sinh^{-1} 0 - \sinh^{-1} 0 = \ln(0 + \sqrt{0+1}) - \ln(0 + \sqrt{0+1}) = 0$

74. (a) $\int_1^e \frac{dx}{x\sqrt{1+(\ln x)^2}} = \int_0^1 \frac{du}{\sqrt{a^2+u^2}}$, where $u = \ln x, du = \frac{1}{x} dx, a = 1$
 $= \left[\sinh^{-1} u \right]_0^1 = \sinh^{-1} 1 - \sinh^{-1} 0 = \sinh^{-1} 1$

(b) $\sinh^{-1} 1 - \sinh^{-1} 0 = \ln(1 + \sqrt{1^2+1}) - \ln(0 + \sqrt{0^2+1}) = \ln(1 + \sqrt{2})$

75. Let $E(x) = \frac{f(x)+f(-x)}{2}$ and $O(x) = \frac{f(x)-f(-x)}{2}$. Then $E(x) + O(x) = \frac{f(x)+f(-x)}{2} + \frac{f(x)-f(-x)}{2} = \frac{2f(x)}{2} = f(x)$.

Also, $E(-x) = \frac{f(-x)+f(-(-x))}{2} = \frac{f(-x)+f(x)}{2} = E(x) \Rightarrow E(x)$ is even, and $O(-x) = \frac{f(-x)-f(-(-x))}{2} = -\frac{f(x)-f(-x)}{2} = -O(x) \Rightarrow O(x)$ is odd. Consequently, $f(x)$ can be written as a sum of an even and an odd function. $f(x) = \frac{f(x)+f(-x)}{2}$ because $\frac{f(x)-f(-x)}{2} = 0$ if f is even, and $f(x) = \frac{f(x)-f(-x)}{2}$ because $\frac{f(x)+f(-x)}{2} = 0$ if f is odd. Thus, if f is even $f(x) = \frac{2f(x)}{2} + 0$ and if f is odd, $f(x) = 0 + \frac{2f(x)}{2}$

76. $y = \sinh^{-1} x \Rightarrow x = \sinh y \Rightarrow x = \frac{e^y - e^{-y}}{2} \Rightarrow 2x = e^y - \frac{1}{e^y} \Rightarrow 2xe^y = e^{2y} - 1 \Rightarrow e^{2y} - 2xe^y - 1 = 0$
 $\Rightarrow e^y = \frac{2x \pm \sqrt{4x^2+4}}{2} \Rightarrow e^y = x + \sqrt{x^2+1} \Rightarrow \sinh^{-1} x = y = \ln(x + \sqrt{x^2+1})$. Since $e^y > 0$, we cannot choose $e^y = x - \sqrt{x^2+1}$ because $x - \sqrt{x^2+1} < 0$.

77. (a) $v = \sqrt{\frac{mg}{k}} \tanh\left(\sqrt{\frac{gk}{m}} t\right) \Rightarrow \frac{dv}{dt} = \sqrt{\frac{mg}{k}} \left[\operatorname{sech}^2\left(\sqrt{\frac{gk}{m}} t\right) \right] \left(\sqrt{\frac{gk}{m}}\right) = g \operatorname{sech}^2\left(\sqrt{\frac{gk}{m}} t\right)$. Thus
 $m \frac{dv}{dt} = mg \operatorname{sech}^2\left(\sqrt{\frac{gk}{m}} t\right) = mg \left(1 - \tanh^2\left(\sqrt{\frac{gk}{m}} t\right)\right) = mg - kv^2$. Also, since $\tanh x = 0$ when $x = 0, v = 0$ when $t = 0$.

(b) $\lim_{t \rightarrow \infty} v = \lim_{t \rightarrow \infty} \sqrt{\frac{mg}{k}} \tanh\left(\sqrt{\frac{gk}{m}} t\right) = \sqrt{\frac{mg}{k}} \lim_{t \rightarrow \infty} \tanh\left(\sqrt{\frac{gk}{m}} t\right) = \sqrt{\frac{mg}{k}} (1) = \sqrt{\frac{mg}{k}}$

(c) $\sqrt{\frac{160}{0.005}} = \sqrt{\frac{160,000}{5}} = \frac{400}{\sqrt{5}} = 80\sqrt{5} \approx 178.89$ ft/sec

78. (a) $s(t) = a \cos kt + b \sin kt \Rightarrow \frac{ds}{dt} = -ak \sin kt + bk \cos kt \Rightarrow \frac{d^2s}{dt^2} = -ak^2 \cos kt - bk^2 \sin kt$
 $= -k^2(a \cos kt + b \sin kt) = -k^2 s(t) \Rightarrow$ acceleration is proportional to s . The negative constant $-k^2$ implies that the acceleration is directed toward the origin.

(b) $s(t) = a \cosh kt + b \sinh kt \Rightarrow \frac{ds}{dt} = ak \sinh kt + bk \cosh kt \Rightarrow \frac{d^2s}{dt^2} = ak^2 \cosh kt + bk^2 \sinh kt$
 $= k^2(a \cosh kt + b \sinh kt) = k^2 s(t) \Rightarrow$ acceleration is proportional to s . The positive constant k^2 implies that the acceleration is directed away from the origin.

$$79. V = \pi \int_0^2 (\cosh^2 x - \sinh^2 x) dx = \pi \int_0^2 1 dx = 2\pi$$

$$80. V = 2\pi \int_0^{\ln \sqrt{3}} \operatorname{sech}^2 x dx = 2\pi [\tanh x]_0^{\ln \sqrt{3}} = 2\pi \left[\frac{\sqrt{3} - (1/\sqrt{3})}{\sqrt{3} + (1/\sqrt{3})} \right] = \pi$$

$$81. y = \frac{1}{2} \cosh 2x \Rightarrow y' = \sinh 2x \Rightarrow L = \int_0^{\ln \sqrt{5}} \sqrt{1 + (\sinh 2x)^2} dx = \int_0^{\ln \sqrt{5}} \cosh 2x dx = \left[\frac{1}{2} \sinh 2x \right]_0^{\ln \sqrt{5}} \\ = \left[\frac{1}{2} \left(\frac{e^{2x} - e^{-2x}}{2} \right) \right]_0^{\ln \sqrt{5}} = \frac{1}{4} \left(5 - \frac{1}{5} \right) = \frac{6}{5}$$

$$82. (a) \lim_{x \rightarrow \infty} \tanh x = \lim_{x \rightarrow \infty} \frac{e^x - e^{-x}}{e^x + e^{-x}} = \lim_{x \rightarrow \infty} \frac{e^x - \frac{1}{e^x}}{e^x + \frac{1}{e^x}} = \lim_{x \rightarrow \infty} \left(\frac{e^x - \frac{1}{e^x}}{e^x} \right) \cdot \frac{\frac{1}{e^x}}{\frac{1}{e^x}} = \lim_{x \rightarrow \infty} \frac{1 - \frac{1}{e^{2x}}}{1 + \frac{1}{e^{2x}}} = \frac{1-0}{1+0} = 1$$

$$(b) \lim_{x \rightarrow -\infty} \tanh x = \lim_{x \rightarrow -\infty} \frac{e^x - e^{-x}}{e^x + e^{-x}} = \lim_{x \rightarrow -\infty} \frac{e^x - \frac{1}{e^x}}{e^x + \frac{1}{e^x}} = \lim_{x \rightarrow -\infty} \left(\frac{e^x - \frac{1}{e^x}}{e^x + \frac{1}{e^x}} \right) \cdot \frac{e^x}{e^x} = \lim_{x \rightarrow -\infty} \frac{e^{2x} - 1}{e^{2x} + 1} = \frac{0-1}{0+1} = -1$$

$$(c) \lim_{x \rightarrow \infty} \sinh x = \lim_{x \rightarrow \infty} \frac{e^x - e^{-x}}{2} = \lim_{x \rightarrow \infty} \frac{e^x - \frac{1}{e^x}}{2} = \lim_{x \rightarrow \infty} \left(\frac{e^x}{2} - \frac{1}{2e^x} \right) = \infty - 0 = \infty$$

$$(d) \lim_{x \rightarrow -\infty} \sinh x = \lim_{x \rightarrow -\infty} \frac{e^x - e^{-x}}{2} = \lim_{x \rightarrow -\infty} \left(\frac{e^x}{2} - \frac{e^{-x}}{2} \right) = 0 - \infty = -\infty$$

$$(e) \lim_{x \rightarrow \infty} \operatorname{sech} x = \lim_{x \rightarrow \infty} \frac{2}{e^x + e^{-x}} = \lim_{x \rightarrow \infty} \frac{2}{e^x + \frac{1}{e^x}} \cdot \frac{e^x}{e^x} = \lim_{x \rightarrow \infty} \frac{2e^x}{1 + \frac{1}{e^{2x}}} = \frac{0}{1+0} = 0$$

$$(f) \lim_{x \rightarrow \infty} \operatorname{coth} x = \lim_{x \rightarrow \infty} \frac{e^x + e^{-x}}{e^x - e^{-x}} = \lim_{x \rightarrow \infty} \frac{e^x + \frac{1}{e^x}}{e^x - \frac{1}{e^x}} = \lim_{x \rightarrow \infty} \left(\frac{e^x + \frac{1}{e^x}}{e^x - \frac{1}{e^x}} \right) \cdot \frac{\frac{1}{e^x}}{\frac{1}{e^x}} = \lim_{x \rightarrow \infty} \frac{1 + \frac{1}{e^{2x}}}{1 - \frac{1}{e^{2x}}} = \frac{1+0}{1-0} = 1$$

$$(g) \lim_{x \rightarrow 0^+} \operatorname{coth} x = \lim_{x \rightarrow 0^+} \frac{e^x + e^{-x}}{e^x - e^{-x}} = \lim_{x \rightarrow 0^+} \frac{e^x + \frac{1}{e^x}}{e^x - \frac{1}{e^x}} \cdot \frac{e^x}{e^x} = \lim_{x \rightarrow 0^+} \frac{e^{2x} + 1}{e^{2x} - 1} = +\infty$$

$$(h) \lim_{x \rightarrow 0^-} \operatorname{coth} x = \lim_{x \rightarrow 0^-} \frac{e^x + e^{-x}}{e^x - e^{-x}} = \lim_{x \rightarrow 0^-} \frac{e^x + \frac{1}{e^x}}{e^x - \frac{1}{e^x}} \cdot \frac{e^x}{e^x} = \lim_{x \rightarrow 0^-} \frac{e^{2x} + 1}{e^{2x} - 1} = -\infty$$

$$(i) \lim_{x \rightarrow -\infty} \operatorname{csch} x = \lim_{x \rightarrow -\infty} \frac{2}{e^x - e^{-x}} = \lim_{x \rightarrow -\infty} \frac{2}{e^x - \frac{1}{e^x}} \cdot \frac{e^x}{e^x} = \lim_{x \rightarrow -\infty} \frac{2e^x}{e^{2x} - 1} = \frac{0}{0-1} = 0$$

$$83. (a) y = \frac{H}{w} \cosh \left(\frac{w}{H} x \right) \Rightarrow \tan \phi = \frac{dy}{dx} = \left(\frac{H}{w} \right) \left[\frac{w}{H} \sinh \left(\frac{w}{H} x \right) \right] = \sinh \left(\frac{w}{H} x \right)$$

$$(b) \text{The tension at } P \text{ is given by } T \cos \phi = H \Rightarrow T = H \sec \phi = H \sqrt{1 + \tan^2 \phi} = H \sqrt{1 + \left(\sinh \frac{w}{H} x \right)^2} \\ = H \cosh \left(\frac{w}{H} x \right) = w \left(\frac{H}{w} \right) \cosh \left(\frac{w}{H} x \right) = wy$$

$$84. s = \frac{1}{a} \sinh ax \Rightarrow \sinh ax = as \Rightarrow ax = \sinh^{-1} as \Rightarrow x = \frac{1}{a} \sinh^{-1} as; \quad y = \frac{1}{a} \cosh ax = \frac{1}{a} \sqrt{\cosh^2 ax} \\ = \frac{1}{a} \sqrt{\sinh^2 ax + 1} = \frac{1}{a} \sqrt{a^2 s^2 + 1} = \sqrt{s^2 + \frac{1}{a^2}}$$

85. To find the length of the curve: $y = \frac{1}{a} \cosh ax \Rightarrow y' = \sinh ax \Rightarrow L = \int_0^b \sqrt{1 + (\sinh ax)^2} dx \Rightarrow L = \int_0^b \cosh ax dx$
 $= \left[\frac{1}{a} \sinh ax \right]_0^b = \frac{1}{a} \sinh ab$. The area under the curve is $A = \int_0^b \frac{1}{a} \cosh ax dx = \left[\frac{1}{a^2} \sinh ax \right]_0^b = \frac{1}{a^2} \sinh ab$
 $= \left(\frac{1}{a}\right)\left(\frac{1}{a} \sinh ab\right)$ which is the area of the rectangle of height $\frac{1}{a}$ and length L as claimed, and which is illustrated below.

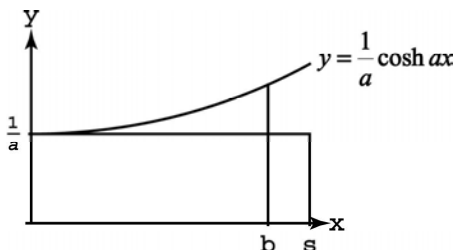

86. (a) Let the point located at $(\cosh u, 0)$ be called T . Then $A(u) =$ area of the triangle $\triangle OATP$ minus the area under the curve $y = \sqrt{x^2 - 1}$ from A to $T \Rightarrow A(u) = \frac{1}{2} \cosh u \sinh u - \int_1^{\cosh u} \sqrt{x^2 - 1} dx$.
 (b) $A(u) = \frac{1}{2} \cosh u \sinh u - \int_1^{\cosh u} \sqrt{x^2 - 1} dx \Rightarrow A'(u) = \frac{1}{2}(\cosh^2 u + \sinh^2 u) - (\sqrt{\cosh^2 u - 1})(\sinh u)$
 $= \frac{1}{2} \cosh^2 u + \frac{1}{2} \sinh^2 u - \sinh^2 u = \frac{1}{2}(\cosh^2 u - \sinh^2 u) = \left(\frac{1}{2}\right)(1) = \frac{1}{2}$
 (c) $A'(u) = \frac{1}{2} \Rightarrow A(u) = \frac{u}{2} + C$, and from part (a) we have $A(0) = 0 \Rightarrow C = 0 \Rightarrow A(u) = \frac{u}{2} \Rightarrow u = 2A$

7.4 RELATIVE RATES OF GROWTH

1. (a) slower, $\lim_{x \rightarrow \infty} \frac{x+3}{e^x} = \lim_{x \rightarrow \infty} \frac{1}{e^x} = 0$
 (b) slower, $\lim_{x \rightarrow \infty} \frac{x^3 + \sin^2 x}{e^x} = \lim_{x \rightarrow \infty} \frac{3x^2 + 2 \sin x \cos x}{e^x} = \lim_{x \rightarrow \infty} \frac{6x + 2 \cos 2x}{e^x} = \lim_{x \rightarrow \infty} \frac{6 - 4 \sin 2x}{e^x} = 0$ by the Sandwich Theorem because $\frac{2}{e^x} \leq \frac{6 - 4 \sin 2x}{e^x} \leq \frac{10}{e^x}$ for all reals, and $\lim_{x \rightarrow \infty} \frac{2}{e^x} = 0 = \lim_{x \rightarrow \infty} \frac{10}{e^x}$
 (c) slower, $\lim_{x \rightarrow \infty} \frac{\sqrt{x}}{e^x} = \lim_{x \rightarrow \infty} \frac{x^{1/2}}{e^x} = \lim_{x \rightarrow \infty} \frac{\left(\frac{1}{2}\right)x^{-1/2}}{e^x} = \lim_{x \rightarrow \infty} \frac{1}{2\sqrt{x}e^x} = 0$
 (d) faster, $\lim_{x \rightarrow \infty} \frac{4^x}{e^x} = \lim_{x \rightarrow \infty} \left(\frac{4}{e}\right)^x = \infty$ since $\frac{4}{e} > 1$
 (e) slower, $\lim_{x \rightarrow \infty} \frac{\left(\frac{3}{2}\right)^x}{e^x} = \lim_{x \rightarrow \infty} \left(\frac{3}{2e}\right)^x = 0$ since $\frac{3}{2e} < 1$
 (f) slower, $\lim_{x \rightarrow \infty} \frac{e^{x/2}}{e^x} = \lim_{x \rightarrow \infty} \frac{1}{e^{x/2}} = 0$
 (g) same, $\lim_{x \rightarrow \infty} \frac{\left(\frac{e^x}{2}\right)}{e^x} = \lim_{x \rightarrow \infty} \frac{1}{2} = \frac{1}{2}$
 (h) slower, $\lim_{x \rightarrow \infty} \frac{\log_{10} x}{e^x} = \lim_{x \rightarrow \infty} \frac{\ln x}{(\ln 10)e^x} = \lim_{x \rightarrow \infty} \frac{\frac{1}{x}}{(\ln 10)e^x} = \lim_{x \rightarrow \infty} \frac{1}{(\ln 10)xe^x} = 0$
2. (a) slower, $\lim_{x \rightarrow \infty} \frac{10x^4 + 30x + 1}{e^x} = \lim_{x \rightarrow \infty} \frac{40x^3 + 30}{e^x} = \lim_{x \rightarrow \infty} \frac{120x^2}{e^x} = \lim_{x \rightarrow \infty} \frac{240x}{e^x} = \lim_{x \rightarrow \infty} \frac{240}{e^x} = 0$
 (b) slower, $\lim_{x \rightarrow \infty} \frac{x \ln x - x}{e^x} = \lim_{x \rightarrow \infty} \frac{x(\ln x - 1)}{e^x} = \lim_{x \rightarrow \infty} \frac{\ln x - 1 + x\left(\frac{1}{x}\right)}{e^x} = \lim_{x \rightarrow \infty} \frac{\ln x - 1 + 1}{e^x} = \lim_{x \rightarrow \infty} \frac{\ln x}{e^x} = \lim_{x \rightarrow \infty} \frac{\left(\frac{1}{x}\right)}{e^x} = \lim_{x \rightarrow \infty} \frac{1}{xe^x} = 0$

$$(c) \text{ slower, } \lim_{x \rightarrow \infty} \frac{\sqrt{1+x^4}}{e^x} = \sqrt{\lim_{x \rightarrow \infty} \frac{1+x^4}{e^{2x}}} = \sqrt{\lim_{x \rightarrow \infty} \frac{4x^3}{2e^{2x}}} = \sqrt{\lim_{x \rightarrow \infty} \frac{12x^2}{4e^{2x}}} = \sqrt{\lim_{x \rightarrow \infty} \frac{24x}{8e^{2x}}} = \sqrt{\lim_{x \rightarrow \infty} \frac{24}{16e^{2x}}} = \sqrt{0} = 0$$

$$(d) \text{ slower, } \lim_{x \rightarrow \infty} \frac{\left(\frac{5}{2}\right)^x}{e^x} = \lim_{x \rightarrow \infty} \left(\frac{5}{2e}\right)^x = 0 \text{ since } \frac{5}{2e} < 1$$

$$(e) \text{ slower, } \lim_{x \rightarrow \infty} \frac{e^{-x}}{e^x} = \lim_{x \rightarrow \infty} \frac{1}{e^{2x}} = 0$$

$$(f) \text{ faster, } \lim_{x \rightarrow \infty} \frac{xe^x}{e^x} = \lim_{x \rightarrow \infty} x = \infty$$

$$(g) \text{ slower, since for all reals we have } -1 \leq \cos x \leq 1 \Rightarrow e^{-1} \leq e^{\cos x} \leq e^1 \Rightarrow \frac{e^{-1}}{e^x} \leq \frac{e^{\cos x}}{e^x} \leq \frac{e^1}{e^x} \text{ and also}$$

$$\lim_{x \rightarrow \infty} \frac{e^{-1}}{e^x} = 0 = \lim_{x \rightarrow \infty} \frac{e^1}{e^x}, \text{ so by the Sandwich Theorem we conclude that } \lim_{x \rightarrow \infty} \frac{e^{\cos x}}{e^x} = 0$$

$$(h) \text{ same, } \lim_{x \rightarrow \infty} \frac{e^{x-1}}{e^x} = \lim_{x \rightarrow \infty} \frac{1}{e^{(x-x+1)}} = \lim_{x \rightarrow \infty} \frac{1}{e} = \frac{1}{e}$$

$$3. (a) \text{ same, } \lim_{x \rightarrow \infty} \frac{x^2+4x}{x^2} = \lim_{x \rightarrow \infty} \frac{2x+4}{2x} = \lim_{x \rightarrow \infty} \frac{2}{2} = 1$$

$$(b) \text{ slower, } \lim_{x \rightarrow \infty} \frac{x^5-x^2}{x^2} = \lim_{x \rightarrow \infty} (x^3-1) = \infty$$

$$(c) \text{ same, } \lim_{x \rightarrow \infty} \frac{\sqrt{x^4+x^3}}{x^2} = \sqrt{\lim_{x \rightarrow \infty} \frac{x^4+x^3}{x^4}} = \sqrt{\lim_{x \rightarrow \infty} \left(1+\frac{1}{x}\right)} = \sqrt{1} = 1$$

$$(d) \text{ same, } \lim_{x \rightarrow \infty} \frac{(x+3)^2}{x^2} = \lim_{x \rightarrow \infty} \frac{2(x+3)}{2x} = \lim_{x \rightarrow \infty} \frac{2}{2} = 1$$

$$(e) \text{ slower, } \lim_{x \rightarrow \infty} \frac{x \ln x}{x^2} = \lim_{x \rightarrow \infty} \frac{\ln x}{x} = \lim_{x \rightarrow \infty} \left(\frac{1}{x}\right) = 0$$

$$(f) \text{ slower, } \lim_{x \rightarrow \infty} \frac{2^x}{x^2} = \lim_{x \rightarrow \infty} \frac{(\ln 2)2^x}{2x} = \lim_{x \rightarrow \infty} \frac{(\ln 2)^2 2^x}{2} = \infty$$

$$(g) \text{ slower, } \lim_{x \rightarrow \infty} \frac{x^3 e^{-x}}{x^2} = \lim_{x \rightarrow \infty} \frac{x}{e^x} \lim_{x \rightarrow \infty} \frac{1}{e^x} = 0$$

$$(h) \text{ same, } \lim_{x \rightarrow \infty} \frac{8x^2}{x^2} = \lim_{x \rightarrow \infty} 8 = 8$$

$$4. (a) \text{ same, } \lim_{x \rightarrow \infty} \frac{x^2+\sqrt{x}}{x^2} = \lim_{x \rightarrow \infty} \left(1+\frac{1}{x^{3/2}}\right) = 1$$

$$(b) \text{ same, } \lim_{x \rightarrow \infty} \frac{10x^2}{x^2} = \lim_{x \rightarrow \infty} 10 = 10$$

$$(c) \text{ slower, } \lim_{x \rightarrow \infty} \frac{x^2 e^{-x}}{x^2} = \lim_{x \rightarrow \infty} \frac{1}{e^x} = 0$$

$$(d) \text{ slower, } \lim_{x \rightarrow \infty} \frac{\log_{10} x^2}{x^2} = \lim_{x \rightarrow \infty} \frac{\left(\frac{\ln x^2}{\ln 10}\right)}{x^2} = \frac{1}{\ln 10} \lim_{x \rightarrow \infty} \frac{2 \ln x}{x^2} = \frac{2}{\ln 10} \lim_{x \rightarrow \infty} \frac{\left(\frac{1}{x}\right)}{2x} = \frac{1}{\ln 10} \lim_{x \rightarrow \infty} \frac{1}{x^2} = 0$$

$$(e) \text{ faster, } \lim_{x \rightarrow \infty} \frac{x^3-x^2}{x^2} = \lim_{x \rightarrow \infty} (x-1) = \infty$$

$$(f) \text{ slower, } \lim_{x \rightarrow \infty} \frac{\left(\frac{1}{10}\right)^x}{x^2} = \lim_{x \rightarrow \infty} \frac{1}{10^x x^2} = 0$$

$$(g) \text{ faster, } \lim_{x \rightarrow \infty} \frac{(1.1)^x}{x^2} = \lim_{x \rightarrow \infty} \frac{(\ln 1.1)(1.1)^x}{2x} = \lim_{x \rightarrow \infty} \frac{(\ln 1.1)^2 (1.1)^x}{2} = \infty$$

$$(h) \text{ same, } \lim_{x \rightarrow \infty} \frac{x^2+100x}{x^2} = \lim_{x \rightarrow \infty} \left(1+\frac{100}{x}\right) = 1$$

5. (a) same, $\lim_{x \rightarrow \infty} \frac{\log_3 x}{\ln x} = \lim_{x \rightarrow \infty} \frac{\left(\frac{\ln x}{\ln 3}\right)}{\ln x} = \lim_{x \rightarrow \infty} \frac{1}{\ln 3} = \frac{1}{\ln 3}$
- (b) same, $\lim_{x \rightarrow \infty} \frac{\ln 2x}{\ln x} = \lim_{x \rightarrow \infty} \frac{\left(\frac{2}{x}\right)}{\left(\frac{1}{x}\right)} = 1$
- (c) same, $\lim_{x \rightarrow \infty} \frac{\ln \sqrt{x}}{\ln x} = \lim_{x \rightarrow \infty} \frac{\left(\frac{1}{2}\right) \ln x}{\ln x} = \lim_{x \rightarrow \infty} \frac{1}{2} = \frac{1}{2}$
- (d) faster, $\lim_{x \rightarrow \infty} \frac{\sqrt{x}}{\ln x} = \lim_{x \rightarrow \infty} \frac{x^{1/2}}{\ln x} = \lim_{x \rightarrow \infty} \frac{\left(\frac{1}{2}\right)x^{-1/2}}{\left(\frac{1}{x}\right)} = \lim_{x \rightarrow \infty} \frac{x}{2\sqrt{x}} = \lim_{x \rightarrow \infty} \frac{\sqrt{x}}{2} = \infty$
- (e) faster, $\lim_{x \rightarrow \infty} \frac{x}{\ln x} = \lim_{x \rightarrow \infty} \frac{1}{\left(\frac{1}{x}\right)} = \lim_{x \rightarrow \infty} x = \infty$
- (f) same, $\lim_{x \rightarrow \infty} \frac{5 \ln x}{\ln x} = \lim_{x \rightarrow \infty} 5 = 5$
- (g) slower, $\lim_{x \rightarrow \infty} \frac{\left(\frac{1}{x}\right)}{\ln x} = \lim_{x \rightarrow \infty} \frac{1}{x \ln x} = 0$
- (h) faster, $\lim_{x \rightarrow \infty} \frac{e^x}{\ln x} = \lim_{x \rightarrow \infty} \frac{e^x}{\left(\frac{1}{x}\right)} = \lim_{x \rightarrow \infty} x e^x = \infty$
6. (a) same, $\lim_{x \rightarrow \infty} \frac{\log_2 x^2}{\ln x} = \lim_{x \rightarrow \infty} \frac{\left(\frac{\ln x^2}{\ln 2}\right)}{\ln x} = \frac{1}{\ln 2} \lim_{x \rightarrow \infty} \frac{\ln x^2}{\ln x} = \frac{1}{\ln 2} \lim_{x \rightarrow \infty} \frac{2 \ln x}{\ln x} = \frac{1}{\ln 2} \lim_{x \rightarrow \infty} 2 = \frac{2}{\ln 2}$
- (b) same, $\lim_{x \rightarrow \infty} \frac{\log_{10} 10x}{\ln x} = \lim_{x \rightarrow \infty} \frac{\left(\frac{\ln 10x}{\ln 10}\right)}{\ln x} = \frac{1}{\ln 10} \lim_{x \rightarrow \infty} \frac{\ln 10x}{\ln x} = \frac{1}{\ln 10} \lim_{x \rightarrow \infty} \frac{\left(\frac{10}{x}\right)}{\left(\frac{1}{x}\right)} = \frac{1}{\ln 10} \lim_{x \rightarrow \infty} 1 = \frac{1}{\ln 10}$
- (c) slower, $\lim_{x \rightarrow \infty} \frac{\left(\frac{1}{\sqrt{x}}\right)}{\ln x} = \lim_{x \rightarrow \infty} \frac{1}{(\sqrt{x})(\ln x)} = 0$
- (d) slower, $\lim_{x \rightarrow \infty} \frac{\left(\frac{1}{x^2}\right)}{\ln x} = \lim_{x \rightarrow \infty} \frac{1}{x^2 \ln x} = 0$
- (e) faster, $\lim_{x \rightarrow \infty} \frac{x-2 \ln x}{\ln x} = \lim_{x \rightarrow \infty} \left(\frac{x}{\ln x} - 2\right) = \left(\lim_{x \rightarrow \infty} \frac{x}{\ln x}\right) - 2 = \left(\lim_{x \rightarrow \infty} \frac{1}{\left(\frac{1}{x}\right)}\right) - 2 = \left(\lim_{x \rightarrow \infty} x\right) - 2 = \infty$
- (f) slower, $\lim_{x \rightarrow \infty} \frac{e^{-x}}{\ln x} = \lim_{x \rightarrow \infty} \frac{1}{e^x \ln x} = 0$
- (g) slower, $\lim_{x \rightarrow \infty} \frac{\ln(\ln x)}{\ln x} = \lim_{x \rightarrow \infty} \frac{\left(\frac{1/\ln x}{\ln x}\right)}{\left(\frac{1}{x}\right)} = \lim_{x \rightarrow \infty} \frac{1}{\ln x} = 0$
- (h) same, $\lim_{x \rightarrow \infty} \frac{\ln(2x+5)}{\ln x} = \lim_{x \rightarrow \infty} \frac{\left(\frac{2}{2x+5}\right)}{\left(\frac{1}{x}\right)} = \lim_{x \rightarrow \infty} \frac{2x}{2x+5} = \lim_{x \rightarrow \infty} \frac{2}{2} = \lim_{x \rightarrow \infty} 1 = 1$
7. $\lim_{x \rightarrow \infty} \frac{e^x}{e^{x/2}} = \lim_{x \rightarrow \infty} e^{x/2} = \infty \Rightarrow e^x$ grows faster than $e^{x/2}$; since for $x > e^e$ we have $\ln x > e$ and
- $$\lim_{x \rightarrow \infty} \frac{(\ln x)^x}{e^x} = \lim_{x \rightarrow \infty} \left(\frac{\ln x}{e}\right)^x = \infty \Rightarrow (\ln x)^x \text{ grows faster than } e^x; \text{ since } x > \ln x \text{ for all } x > 0 \text{ and}$$
- $$\lim_{x \rightarrow \infty} \frac{x^x}{(\ln x)^x} = \lim_{x \rightarrow \infty} \left(\frac{x}{\ln x}\right)^x = \infty \Rightarrow x^x \text{ grows faster than } (\ln x)^x. \text{ Therefore, slowest to fastest are:}$$
- $e^{x/2}, e^x, (\ln x)^x, x^x$ so the order is d, a, c, b

8. $\lim_{x \rightarrow \infty} \frac{(\ln 2)^x}{x^2} = \lim_{x \rightarrow \infty} \frac{(\ln(\ln 2))(\ln 2)^x}{2x} = \lim_{x \rightarrow \infty} \frac{(\ln(\ln 2))^2 (\ln 2)^x}{2} = \frac{(\ln(\ln 2))^2}{2} \lim_{x \rightarrow \infty} (\ln 2)^x = 0 \Rightarrow (\ln 2)^x$ grows slower than x^2 ; $\lim_{x \rightarrow \infty} \frac{x^2}{2^x} = \lim_{x \rightarrow \infty} \frac{2x}{(\ln 2)2^x} = \lim_{x \rightarrow \infty} \frac{2}{(\ln 2)2^x} = 0 \Rightarrow x^2$ grows slower than 2^x ; $\lim_{x \rightarrow \infty} \frac{2x}{e^x} = \lim_{x \rightarrow \infty} \left(\frac{2}{e}\right)^x = 0 \Rightarrow 2^x$ grows slower than e^x . Therefore, the slowest to the fastest is: $(\ln 2)^x$, x^2 , 2^x and e^x so the order is c , b , a , d
9. (a) false; $\lim_{x \rightarrow \infty} \frac{x}{x} = 1$
 (b) false; $\lim_{x \rightarrow \infty} \frac{x}{x+5} = \frac{1}{1} = 1$
 (c) true; $x < x+5 \Rightarrow \frac{x}{x+5} < 1$ if $x > 1$ (or sufficiently large)
 (d) true; $x < 2x \Rightarrow \frac{x}{2x} < 1$ if $x > 1$ (or sufficiently large)
 (e) true; $\lim_{x \rightarrow \infty} \frac{e^x}{e^{2x}} = \lim_{x \rightarrow \infty} \frac{1}{e^x} = 0$
 (f) true; $\frac{x+\ln x}{x} = 1 + \frac{\ln x}{x} < 1 + \frac{\sqrt{x}}{x} = 1 + \frac{1}{\sqrt{x}} < 2$ if $x > 1$ (or sufficiently large)
 (g) false; $\lim_{x \rightarrow \infty} \frac{\ln x}{\ln 2x} = \lim_{x \rightarrow \infty} \frac{\left(\frac{1}{x}\right)}{\left(\frac{2}{x}\right)} = \lim_{x \rightarrow \infty} \frac{1}{2} = \frac{1}{2}$
 (h) true; $\frac{\sqrt{x^2+5}}{x} < \frac{\sqrt{(x+5)^2}}{x} < \frac{x+5}{x} = 1 + \frac{5}{x} < 6$ if $x > 1$ (or sufficiently large)
10. (a) true; $\frac{\left(\frac{1}{x+3}\right)}{\left(\frac{1}{x}\right)} = \frac{x}{x+3} < 1$ if $x > 1$ (or sufficiently large)
 (b) true; $\frac{\left(\frac{1+\frac{1}{x^2}}{x}\right)}{\left(\frac{1}{x}\right)} = 1 + \frac{1}{x} < 2$ if $x > 1$ (or sufficiently large)
 (c) false; $\lim_{x \rightarrow \infty} \frac{\left(\frac{1}{x} - \frac{1}{x^2}\right)}{\left(\frac{1}{x}\right)} = \lim_{x \rightarrow \infty} \left(1 - \frac{1}{x}\right) = 1$
 (d) true; $2 + \cos x \leq 3 \Rightarrow \frac{2+\cos x}{2} \leq \frac{3}{2}$ if x is sufficiently large
 (e) true; $\frac{e^x+x}{e^x} = 1 + \frac{x}{e^x}$ and $\frac{x}{e^x} \rightarrow 0$ as $x \rightarrow \infty \Rightarrow 1 + \frac{x}{e^x} < 2$ if x is sufficiently large
 (f) true; $\lim_{x \rightarrow \infty} \frac{x \ln x}{x^2} = \lim_{x \rightarrow \infty} \frac{\ln x}{x} = \lim_{x \rightarrow \infty} \frac{\left(\frac{1}{x}\right)}{1} = 0$
 (g) true; $\frac{\ln(\ln x)}{\ln x} < \frac{\ln x}{\ln x} = 1$ if x is sufficiently large
 (h) false; $\lim_{x \rightarrow \infty} \frac{\ln x}{\ln(x^2+1)} = \lim_{x \rightarrow \infty} \frac{\left(\frac{1}{x}\right)}{\left(\frac{2x}{x^2+1}\right)} = \lim_{x \rightarrow \infty} \frac{x^2+1}{2x^2} = \lim_{x \rightarrow \infty} \left(\frac{1}{2} + \frac{1}{2x^2}\right) = \frac{1}{2}$
11. If $f(x)$ and $g(x)$ grow at the same rate, then $\lim_{x \rightarrow \infty} \frac{f(x)}{g(x)} = L \neq 0 \Rightarrow \lim_{x \rightarrow \infty} \frac{g(x)}{f(x)} = \frac{1}{L} \neq 0$. Then $\left| \frac{f(x)}{g(x)} - L \right| < 1$ if x is sufficiently large $\Rightarrow L - 1 < \frac{f(x)}{g(x)} < L + 1 \Rightarrow \frac{f(x)}{g(x)} \leq |L| + 1$ if x is sufficiently large $\Rightarrow f = O(g)$. Similarly, $\frac{g(x)}{f(x)} \leq \left| \frac{1}{L} \right| + 1 \Rightarrow g = O(f)$.
12. When the degree of f is less than the degree of g since in that case $\lim_{x \rightarrow \infty} \frac{f(x)}{g(x)} = 0$.

13. When the degree of f is less than or equal to the degree of g since $\lim_{x \rightarrow \infty} \frac{f(x)}{g(x)} = 0$ when the degree of f is smaller than the degree of g , and $\lim_{x \rightarrow \infty} \frac{f(x)}{g(x)} = \frac{a}{b}$ (the ratio of the leading coefficients) when the degrees are the same.

14. Polynomials of a greater degree grow at a greater rate than polynomials of a lesser degree. Polynomials of the same degree grow at the same rate.

15. $\lim_{x \rightarrow \infty} \frac{\ln(x+1)}{\ln x} = \lim_{x \rightarrow \infty} \frac{\left(\frac{1}{x+1}\right)}{\left(\frac{1}{x}\right)} = \lim_{x \rightarrow \infty} \frac{x}{x+1} = \lim_{x \rightarrow \infty} \frac{1}{1} = 1$ and $\lim_{x \rightarrow \infty} \frac{\ln(x+999)}{\ln x} = \lim_{x \rightarrow \infty} \frac{\left(\frac{1}{x+999}\right)}{\left(\frac{1}{x}\right)} = \lim_{x \rightarrow \infty} \frac{x}{x+999} = 1$

16. $\lim_{x \rightarrow \infty} \frac{\ln(x+a)}{\ln x} = \lim_{x \rightarrow \infty} \frac{\left(\frac{1}{x+a}\right)}{\left(\frac{1}{x}\right)} = \lim_{x \rightarrow \infty} \frac{x}{x+a} = \lim_{x \rightarrow \infty} \frac{1}{1} = 1$. Therefore, the relative rates are the same.

17. $\lim_{x \rightarrow \infty} \frac{\sqrt{10x+1}}{\sqrt{x}} = \sqrt{\lim_{x \rightarrow \infty} \frac{10x+1}{x}} = \sqrt{10}$ and $\lim_{x \rightarrow \infty} \frac{\sqrt{x+1}}{\sqrt{x}} = \sqrt{\lim_{x \rightarrow \infty} \frac{x+1}{x}} = \sqrt{1} = 1$. Since the growth rate is transitive, we conclude that $\sqrt{10x+1}$ and $\sqrt{x+1}$ have the same growth rate (that of \sqrt{x}).

18. $\lim_{x \rightarrow \infty} \frac{\sqrt{x^4+x}}{x^2} = \sqrt{\lim_{x \rightarrow \infty} \frac{x^4+x}{x^4}} = 1$ and $\lim_{x \rightarrow \infty} \frac{\sqrt{x^4-x^3}}{x^2} = \sqrt{\lim_{x \rightarrow \infty} \frac{x^4-x^3}{x^4}} = 1$. Since the growth rate is transitive, we conclude that $\sqrt{x^4+x}$ and $\sqrt{x^4-x^3}$ have the same growth rate (that of x^2).

19. $\lim_{x \rightarrow \infty} \frac{x^n}{e^x} = \lim_{x \rightarrow \infty} \frac{nx^{n-1}}{e^x} = \dots = \lim_{x \rightarrow \infty} \frac{n!}{e^x} = 0 \Rightarrow x^n = o(e^x)$ for any non-negative integer n

20. If $p(x) = a_n x^n + a_{n-1} x^{n-1} + \dots + a_1 x + a_0$, then

$\lim_{x \rightarrow \infty} \frac{p(x)}{e^x} = a_n \lim_{x \rightarrow \infty} \frac{x^n}{e^x} + a_{n-1} \lim_{x \rightarrow \infty} \frac{x^{n-1}}{e^x} + \dots + a_1 \lim_{x \rightarrow \infty} \frac{x}{e^x} + a_0 \lim_{x \rightarrow \infty} \frac{1}{e^x}$ where each limit is zero (from Exercise

19). Therefore, $\lim_{x \rightarrow \infty} \frac{p(x)}{e^x} = 0 \Rightarrow e^x$ grows faster than any polynomial.

21. (a) $\lim_{x \rightarrow \infty} \frac{x^{1/n}}{\ln x} = \lim_{x \rightarrow \infty} \frac{x(1-n)/n}{n\left(\frac{1}{x}\right)} = \left(\frac{1}{n}\right) \lim_{x \rightarrow \infty} x^{1/n} = \infty \Rightarrow \ln x = o(x^{1/n})$ for any positive integer n

(b) $\ln(e^{17,000,000}) = 17,000,000 < (e^{17 \times 10^6})^{1/10^6} = e^{17} \approx 24,154,952.75$

(c) $x \approx 3.430631121 \times 10^{15}$

(d) In the interval $[3.41 \times 10^{15}, 3.45 \times 10^{15}]$ we have $\ln x = 10 \ln(\ln x)$. The graphs cross at about 3.4306311×10^{15} .

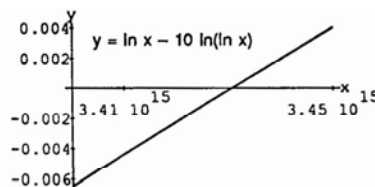

22. $\lim_{x \rightarrow \infty} \frac{\ln x}{a_n x^n + a_{n-1} x^{n-1} + \dots + a_1 x + a_0} = \frac{\lim_{x \rightarrow \infty} \left(\frac{\ln x}{x^n}\right)}{\lim_{x \rightarrow \infty} \left(a_n + \frac{a_{n-1}}{x} + \dots + \frac{a_1}{x^{n-1}} + \frac{a_0}{x^n}\right)} = \frac{\lim_{x \rightarrow \infty} \left[\frac{1/x}{nx^{n-1}}\right]}{a_n} = \lim_{x \rightarrow \infty} \frac{1}{(a_n)(nx^n)} = 0 \Rightarrow \ln x$ grows slower

than any non-constant polynomial ($n \geq 1$)

23. (a) $\lim_{n \rightarrow \infty} \frac{n \log_2 n}{n(\log_2 n)^2} = \lim_{n \rightarrow \infty} \frac{1}{\log_2 n} = 0 \Rightarrow n \log_2 n$
grows slower than $n(\log_2 n)^2$;

$$\lim_{n \rightarrow \infty} \frac{n \log_2 n}{n^{3/2}} = \lim_{n \rightarrow \infty} \frac{\left(\frac{\ln n}{\ln 2}\right)}{n^{1/2}} = \frac{1}{\ln 2} \lim_{n \rightarrow \infty} \frac{\left(\frac{1}{n}\right)}{\left(\frac{1}{2}\right)n^{-1/2}}$$

$$= \frac{2}{\ln 2} \lim_{n \rightarrow \infty} \frac{1}{n^{1/2}} = 0 \Rightarrow n \log_2 n \text{ grows slower}$$

than $n^{3/2}$. Therefore, $n \log_2 n$ grows at the slowest rate \Rightarrow the algorithm that takes $O(n \log_2 n)$ steps is the most efficient in the long run.

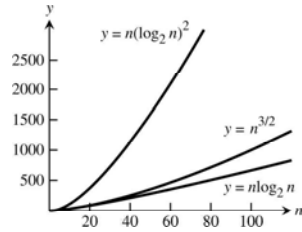

24. (a) $\lim_{n \rightarrow \infty} \frac{(\log_2 n)^2}{n} = \lim_{n \rightarrow \infty} \frac{\left(\frac{\ln n}{\ln 2}\right)^2}{n} = \lim_{n \rightarrow \infty} \frac{(\ln n)^2}{n(\ln 2)^2} = \lim_{n \rightarrow \infty} \frac{2(\ln n)\left(\frac{1}{n}\right)}{(\ln 2)^2} = \frac{2}{(\ln 2)^2} \lim_{n \rightarrow \infty} \frac{\ln n}{n} = \frac{2}{(\ln 2)^2} \lim_{n \rightarrow \infty} \frac{\left(\frac{1}{n}\right)}{1} = 0$

$$\Rightarrow (\log_2 n)^2 \text{ grows slower than } n; \lim_{n \rightarrow \infty} \frac{(\log_2 n)^2}{\sqrt{n} \log_2 n} = \lim_{n \rightarrow \infty} \frac{\log_2 n}{\sqrt{n}} = \lim_{n \rightarrow \infty} \frac{\left(\frac{\ln n}{\ln 2}\right)}{n^{1/2}} = \frac{1}{\ln 2} \lim_{n \rightarrow \infty} \frac{\ln n}{n^{1/2}}$$

$$= \frac{1}{\ln 2} \lim_{x \rightarrow \infty} \frac{\left(\frac{1}{x}\right)}{\left(\frac{1}{2}\right)x^{-1/2}} = \frac{2}{\ln 2} \lim_{x \rightarrow \infty} \frac{1}{x^{1/2}} = 0$$

$\Rightarrow (\log_2 n)^2$ grows slower than $\sqrt{n} \log_2 n$.

Therefore $(\log_2 n)^2$ grows at the slowest rate \Rightarrow the algorithm that takes $O((\log_2 n)^2)$ steps is the most efficient in the long run.

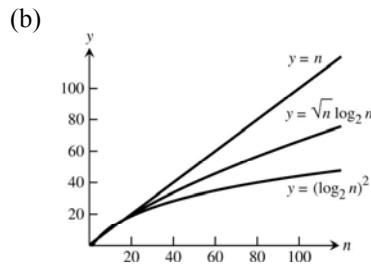

25. It could take one million steps for a sequential search, but at most 20 steps for a binary search because $2^{19} = 524,288 < 1,000,000 < 1,048,576 = 2^{20}$.

26. It could take 450,000 steps for a sequential search, but at most 19 steps for a binary search because $2^{18} = 262,144 < 450,000 < 524,288 = 2^{19}$.

CHAPTER 7 PRACTICE EXERCISES

1. $\int e^x \sin(e^x) dx = \int \sin u du$, where $u = e^x$ and $du = e^x dx$
 $= -\cos u + C = -\cos(e^x) + C$
2. $\int e^t \cos(3e^t - 2) dt = \frac{1}{3} \int \cos u du$, where $u = 3e^t - 2$ and $du = 3e^t dt$
 $= \frac{1}{3} \sin u + C = \frac{1}{3} \sin(3e^t - 2) + C$
3. $\int_0^\pi \tan\left(\frac{x}{3}\right) dx = \int_0^\pi \frac{\sin\left(\frac{x}{3}\right)}{\cos\left(\frac{x}{3}\right)} dx = -3 \int_1^{1/2} \frac{1}{u} du$, where $u = \cos\left(\frac{x}{3}\right)$, $du = -\frac{1}{3} \sin\left(\frac{x}{3}\right) dx$; $x = 0 \Rightarrow u = 1$, $x = \pi \Rightarrow u = \frac{1}{2}$
 $= -3 \left[\ln |u| \right]_1^{1/2} = -3 \left[\ln \left| \frac{1}{2} \right| - \ln |1| \right] = -3 \ln \frac{1}{2} = \ln 2^3 = \ln 8$
4. $\int_{1/6}^{1/4} 2 \cot \pi x dx = 2 \int_{1/6}^{1/4} \frac{\cos \pi x}{\sin \pi x} dx = \frac{2}{\pi} \int_{1/2}^{1/\sqrt{2}} \frac{1}{u} du$, where $u = \sin \pi x$, $du = \pi \cos \pi x dx$;
 $x = \frac{1}{6} \Rightarrow u = \frac{1}{2}$, $x = \frac{1}{4} \Rightarrow u = \frac{1}{\sqrt{2}}$
 $= \frac{2}{\pi} \left[\ln |u| \right]_{1/2}^{1/\sqrt{2}} = \frac{2}{\pi} \left[\ln \left| \frac{1}{\sqrt{2}} \right| - \ln \left| \frac{1}{2} \right| \right] = \frac{2}{\pi} \left[\ln 1 - \frac{1}{2} \ln 2 - \ln 1 + \ln 2 \right] = \frac{2}{\pi} \left[\frac{1}{2} \ln 2 \right] = \frac{\ln 2}{\pi}$
5. $\int_{-\pi/2}^{\pi/6} \frac{\cos t}{1 - \sin t} dt = -\int_2^{1/2} \frac{1}{u} du$, where $u = 1 - \sin t$, $du = -\cos t dt$; $t = -\frac{\pi}{2} \Rightarrow u = 2$, $t = \frac{\pi}{6} \Rightarrow u = \frac{1}{2}$
 $= -\left[\ln |u| \right]_2^{1/2} = -\left[\ln \left| \frac{1}{2} \right| - \ln |2| \right] = -\ln 1 + \ln 2 + \ln 2 = 2 \ln 2 = \ln 4$
6. $\int e^x \sec e^x dx = \int \sec u du$, where $u = e^x$ and $du = e^x dx$
 $= \ln |\sec u + \tan u| + C = \ln |\sec e^x + \tan e^x| + C$
7. $\int \frac{\ln(x-5)}{x-5} dx = \int u du$, where $u = \ln(x-5)$ and $du = \frac{1}{x-5} dx$
 $= \frac{u^2}{2} + C = \frac{[\ln(x-5)]^2}{2} + C$
8. $\int \frac{\cos(1 - \ln v)}{v} dv = -\int \cos u du$, where $u = 1 - \ln v$ and $du = -\frac{1}{v} dv$
 $= -\sin u + C = -\sin(1 - \ln v) + C$
9. $\int_1^7 \frac{3}{x} dx = 3 \int_1^7 \frac{1}{x} dx = 3 \left[\ln |x| \right]_1^7 = 3(\ln 7 - \ln 1) = 3 \ln 7$
10. $\int_1^{32} \frac{1}{5x} dx = \frac{1}{5} \int_1^{32} \frac{1}{x} dx = \frac{1}{5} \left[\ln |x| \right]_1^{32} = \frac{1}{5} (\ln 32 - \ln 1) = \frac{1}{5} \ln 32 = \ln \left(\sqrt[5]{32} \right) = \ln 2$

11. $\int_e^{e^2} \frac{1}{x\sqrt{\ln x}} dx = \int_e^{e^2} (\ln x)^{-1/2} \frac{1}{x} dx = \int_1^2 u^{-1/2} du$, where $u = \ln x, du = \frac{1}{x} dx; x = e \Rightarrow u = 1, x = e^2 \Rightarrow u = 2$
 $= 2 \left[u^{1/2} \right]_1^2 = 2(\sqrt{2} - 1) = 2\sqrt{2} - 2$
12. $\int_2^4 (1 + \ln t)(t \ln t) dt = \int_2^4 (t \ln t)(1 + \ln t) dt = \int_{2 \ln 2}^{4 \ln 4} u du$, where $u = t \ln t, du = \left((t) \left(\frac{1}{t} \right) + (\ln t)(1) \right) dt = (1 + \ln t) dt;$
 $t = 2 \Rightarrow u = 2 \ln 2, t = 4 \Rightarrow u = 4 \ln 4$
 $= \frac{1}{2} \left[u^2 \right]_{2 \ln 2}^{4 \ln 4} = \frac{1}{2} \left[(4 \ln 4)^2 - (2 \ln 2)^2 \right] = \frac{1}{2} \left[(8 \ln 2)^2 - (2 \ln 2)^2 \right] = \frac{(2 \ln 2)^2}{2} (16 - 1) = 30(\ln 2)^2$
13. $3^y = 2^{y+1} \Rightarrow \ln 3^y = \ln 2^{y+1} \Rightarrow y(\ln 3) = (y+1) \ln 2 \Rightarrow (\ln 3 - \ln 2)y = \ln 2 \Rightarrow \left(\ln \frac{3}{2} \right) y = \ln 2 \Rightarrow y = \frac{\ln 2}{\ln \left(\frac{3}{2} \right)}$
14. $4^{-y} = 3^{y+2} \Rightarrow \ln 4^{-y} = \ln 3^{y+2} \Rightarrow -y \ln 4 = (y+2) \ln 3 \Rightarrow -2 \ln 3 = (\ln 3 + \ln 4)y$
 $\Rightarrow (\ln 12)y = -2 \ln 3 \Rightarrow y = -\frac{\ln 9}{\ln 12}$
15. $9e^{2y} = x^2 \Rightarrow e^{2y} = \frac{x^2}{9} \Rightarrow \ln e^{2y} = \ln \left(\frac{x^2}{9} \right) \Rightarrow 2y(\ln e) = \ln \left(\frac{x^2}{9} \right) \Rightarrow y = \frac{1}{2} \ln \left(\frac{x^2}{9} \right) = \ln \sqrt{\frac{x^2}{9}} = \ln \left| \frac{x}{3} \right| = \ln |x| - \ln 3$
16. $3^y = 3 \ln x \Rightarrow \ln 3^y = \ln(3 \ln x) \Rightarrow y \ln 3 = \ln(3 \ln x) \Rightarrow y = \frac{\ln(3 \ln x)}{\ln 3} = \frac{\ln 3 + \ln(\ln x)}{\ln 3}$
17. $\ln(y-1) = x + \ln y \Rightarrow e^{\ln(y-1)} = e^{(x+\ln y)} = e^x e^{\ln y} \Rightarrow y-1 = ye^x \Rightarrow y - ye^x = 1 \Rightarrow y(1 - e^x) = 1 \Rightarrow y = \frac{1}{1 - e^x}$
18. $\ln(10 \ln y) = \ln 5x \Rightarrow e^{\ln(10 \ln y)} = e^{\ln 5x} \Rightarrow 10 \ln y = 5x \Rightarrow \ln y = \frac{x}{2} \Rightarrow e^{\ln y} = e^{x/2} \Rightarrow y = e^{x/2}$
19. (a) $\lim_{x \rightarrow \infty} \frac{\log_2 x}{\log_3 x} = \lim_{x \rightarrow \infty} \frac{\left(\frac{\ln x}{\ln 2} \right)}{\left(\frac{\ln x}{\ln 3} \right)} = \lim_{x \rightarrow \infty} \frac{\ln 3}{\ln 2} = \frac{\ln 3}{\ln 2} \Rightarrow$ same rate
- (b) $\lim_{x \rightarrow \infty} \frac{x}{x + \left(\frac{1}{x} \right)} = \lim_{x \rightarrow \infty} \frac{x^2}{x^2 + 1} = \lim_{x \rightarrow \infty} \frac{2x}{2x} = \lim_{x \rightarrow \infty} 1 = 1 \Rightarrow$ same rate
- (c) $\lim_{x \rightarrow \infty} \frac{\left(\frac{x}{100} \right)}{xe^{-x}} = \lim_{x \rightarrow \infty} \frac{xe^x}{100x} = \lim_{x \rightarrow \infty} \frac{e^x}{100} = \infty \Rightarrow$ faster
- (d) $\lim_{x \rightarrow \infty} \frac{x}{\tan^{-1} x} = \infty \Rightarrow$ faster
- (e) $\lim_{x \rightarrow \infty} \frac{\csc^{-1} x}{\left(\frac{1}{x} \right)} = \lim_{x \rightarrow \infty} \frac{\sin^{-1}(x^{-1})}{x^{-1}} = \lim_{x \rightarrow \infty} \frac{\left(\frac{-x^{-2}}{\sqrt{1 - (x^{-1})^2}} \right)}{-x^{-2}} = \lim_{x \rightarrow \infty} \frac{1}{\sqrt{1 - \left(\frac{1}{x^2} \right)}} = 1 \Rightarrow$ same rate
- (f) $\lim_{x \rightarrow \infty} \frac{\sinh x}{e^x} = \lim_{x \rightarrow \infty} \frac{(e^x - e^{-x})}{2e^x} = \lim_{x \rightarrow \infty} \frac{1 - e^{-2x}}{2} = \frac{1}{2} \Rightarrow$ same rate
20. (a) $\lim_{x \rightarrow \infty} \frac{3^{-x}}{2^{-x}} = \lim_{x \rightarrow \infty} \left(\frac{2}{3} \right)^x = 0 \Rightarrow$ slower
- (b) $\lim_{x \rightarrow \infty} \frac{\ln 2x}{\ln x^2} = \lim_{x \rightarrow \infty} \frac{\ln 2 + \ln x}{2(\ln x)} = \lim_{x \rightarrow \infty} \left(\frac{\ln 2}{2 \ln x} + \frac{1}{2} \right) = \frac{1}{2} \Rightarrow$ same rate
- (c) $\lim_{x \rightarrow \infty} \frac{10x^3 + 2x^2}{e^x} = \lim_{x \rightarrow \infty} \frac{30x^2 + 4x}{e^x} = \lim_{x \rightarrow \infty} \frac{60x + 4}{e^x} = \lim_{x \rightarrow \infty} \frac{60}{e^x} = 0 \Rightarrow$ slower

$$(d) \lim_{x \rightarrow \infty} \frac{\tan^{-1}\left(\frac{1}{x}\right)}{\left(\frac{1}{x}\right)} = \lim_{x \rightarrow \infty} \frac{\tan^{-1}(x^{-1})}{x^{-1}} = \lim_{x \rightarrow \infty} \frac{\left(\frac{-x^{-2}}{1+x^{-2}}\right)}{-x^{-2}} = \lim_{x \rightarrow \infty} \frac{1}{1+\frac{1}{x^2}} = 1 \Rightarrow \text{same rate}$$

$$(e) \lim_{x \rightarrow \infty} \frac{\sin^{-1}\left(\frac{1}{x}\right)}{\left(\frac{1}{x^2}\right)} = \lim_{x \rightarrow \infty} \frac{\sin^{-1}(x^{-1})}{x^{-2}} = \lim_{x \rightarrow \infty} \frac{\left(\frac{-x^{-2}}{\sqrt{1-(x^{-1})^2}}\right)}{-2x^{-3}} = \lim_{x \rightarrow \infty} \frac{x}{2\sqrt{1-\frac{1}{x^2}}} = \infty \Rightarrow \text{faster}$$

$$(f) \lim_{x \rightarrow \infty} \frac{\operatorname{sech} x}{e^{-x}} = \lim_{x \rightarrow \infty} \frac{\left(\frac{2}{e^x + e^{-x}}\right)}{e^{-x}} = \lim_{x \rightarrow \infty} \frac{2}{e^{-x}(e^x + e^{-x})} = \lim_{x \rightarrow \infty} \left(\frac{2}{1+e^{-2x}}\right) = 2 \Rightarrow \text{same rate}$$

$$21. (a) \frac{\left(\frac{1}{x^2} + \frac{1}{x^4}\right)}{\left(\frac{1}{x^2}\right)} = 1 + \frac{1}{x^2} \leq 2 \text{ for } x \text{ sufficiently large} \Rightarrow \text{true}$$

$$(b) \frac{\left(\frac{1}{x^2} + \frac{1}{x^4}\right)}{\left(\frac{1}{x^4}\right)} = x^2 + 1 > M \text{ for any positive integer } M \text{ whenever } x > \sqrt{M} \Rightarrow \text{false}$$

$$(c) \lim_{x \rightarrow \infty} \frac{x}{x + \ln x} = \lim_{x \rightarrow \infty} \frac{1}{1 + \frac{1}{x}} = 1 \Rightarrow \text{the same growth rate} \Rightarrow \text{false}$$

$$(d) \lim_{x \rightarrow \infty} \frac{\ln(\ln x)}{\ln x} = \lim_{x \rightarrow \infty} \frac{\left(\frac{1/\ln x}{\ln x}\right)}{\left(\frac{1}{x}\right)} = \lim_{x \rightarrow \infty} \frac{1}{\ln x} = 0 \Rightarrow \text{grows slower} \Rightarrow \text{true}$$

$$(e) \frac{\tan^{-1} x}{1} \leq \frac{\pi}{2} \text{ for all } x \Rightarrow \text{true}$$

$$(f) \frac{\cosh x}{e^x} = \frac{1}{2}(1 + e^{-2x}) \leq \frac{1}{2}(1 + 1) = 1 \text{ if } x > 0 \Rightarrow \text{true}$$

$$22. (a) \frac{\left(\frac{1}{x^4}\right)}{\left(\frac{1}{x^2} + \frac{1}{x^4}\right)} = \frac{1}{x^2 + 1} \leq 1 \text{ if } x > 0 \Rightarrow \text{true}$$

$$(b) \lim_{x \rightarrow \infty} \frac{\left(\frac{1}{x^4}\right)}{\left(\frac{1}{x^2} + \frac{1}{x^4}\right)} = \lim_{x \rightarrow \infty} \left(\frac{1}{x^2 + 1}\right) = 0 \Rightarrow \text{true}$$

$$(c) \lim_{x \rightarrow \infty} \frac{\ln x}{x+1} = \lim_{x \rightarrow \infty} \left(\frac{1/x}{1}\right) = 0 \Rightarrow \text{true}$$

$$(d) \frac{\ln 2x}{\ln x} = \frac{\ln 2}{\ln x} + 1 \leq 1 + 1 = 2 \text{ if } x \geq 2 \Rightarrow \text{true}$$

$$(e) \frac{\sec^{-1} x}{1} = \frac{\cos^{-1}\left(\frac{1}{x}\right)}{1} \leq \frac{\left(\frac{\pi}{2}\right)}{1} = \frac{\pi}{2} \text{ if } x > 1 \Rightarrow \text{true}$$

$$(f) \frac{\sinh x}{e^x} = \frac{1}{2}(1 - e^{-2x}) \leq \frac{1}{2} \text{ if } x > 0 \Rightarrow \text{true}$$

$$23. \frac{df}{dx} = e^x + 1 \Rightarrow \left(\frac{df^{-1}}{dx}\right)_{x=f(\ln 2)} = \frac{1}{\left(\frac{df}{dx}\right)_{x=\ln 2}} \Rightarrow \left(\frac{df^{-1}}{dx}\right)_{x=f(\ln 2)} = \frac{1}{(e^x + 1)_{x=\ln 2}} = \frac{1}{2+1} = \frac{1}{3}$$

24. $y = f(x) \Rightarrow y = 1 + \frac{1}{x} \Rightarrow \frac{1}{x} = y - 1 \Rightarrow x = \frac{1}{y-1} \Rightarrow f^{-1}(x) = \frac{1}{x-1}$; $f^{-1}(f(x)) = \frac{1}{(1+\frac{1}{x})-1} = \frac{1}{(\frac{1}{x})} = x$ and

$$f(f^{-1}(x)) = 1 + \frac{1}{(\frac{1}{x-1})} = 1 + (x-1) = x; \quad \left. \frac{df^{-1}}{dx} \right|_{f(x)} = \frac{-1}{(x-1)^2} \bigg|_{f(x)} = \frac{-1}{[(1+\frac{1}{x})-1]^2} = -x^2;$$

$$f'(x) = -\frac{1}{x^2} \Rightarrow \left. \frac{df^{-1}}{dx} \right|_{f(x)} = \frac{1}{f'(x)}$$

25. $y = \ln x \Rightarrow \frac{dy}{dx} = \frac{1}{x}$; $\frac{dy}{dt} = \frac{dy}{dx} \frac{dx}{dt} \Rightarrow \frac{dy}{dt} = \left(\frac{1}{x}\right)\sqrt{x} = \frac{1}{\sqrt{x}} \Rightarrow \left. \frac{dy}{dt} \right|_{e^2} = \frac{1}{e}$ m/sec

26. $y = 9e^{-x/3} \Rightarrow \frac{dy}{dx} = -3e^{-x/3}$; $\frac{dx}{dt} = \frac{(dy/dt)}{(dy/dx)} \Rightarrow \frac{dx}{dt} = \frac{(-\frac{1}{4})\sqrt{9-y}}{-3e^{-x/3}}$; $x = 9 \Rightarrow y = 9e^{-3} \Rightarrow \left. \frac{dx}{dt} \right|_{x=9} = \frac{(-\frac{1}{4})\sqrt{9-\frac{9}{e^3}}}{(-\frac{3}{e^3})}$
 $= \frac{1}{4}\sqrt{e^3}\sqrt{e^3-1} \approx 5$ ft/sec

27. $K = \ln(5x) - \ln(3x) = \ln 5 + \ln x - \ln 3 - \ln x = \ln 5 - \ln 3 = \ln \frac{5}{3}$

28. (a) No, there are two intersections: one at $x = 2$ and the other at $x = 4$

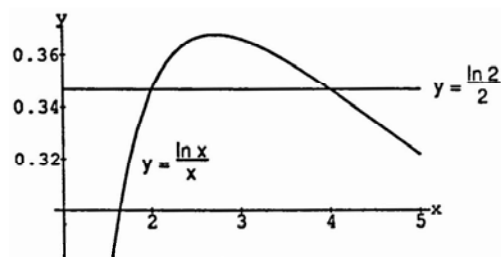

(b) Yes, because there is only one intersection

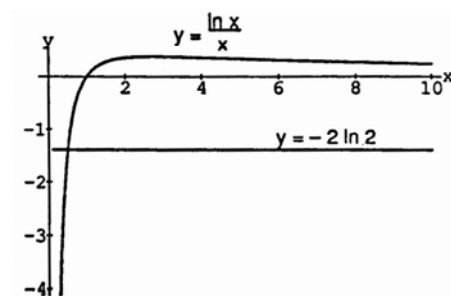

29. $\frac{\log_4 x}{\log_2 x} = \frac{(\frac{\ln x}{\ln 4})}{(\frac{\ln x}{\ln 2})} = \frac{\ln x}{\ln 4} \cdot \frac{\ln 2}{\ln x} = \frac{\ln 2}{\ln 4} = \frac{\ln 2}{2 \ln 2} = \frac{1}{2}$

30. (a) $f(x) = \frac{\ln 2}{\ln x}$, $g(x) = \frac{\ln x}{\ln 2}$

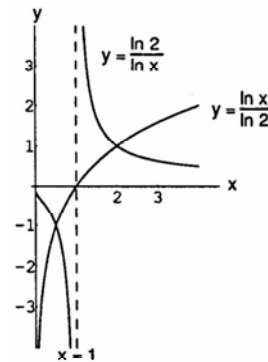

(b) f is negative when g is negative, positive when g is positive, and undefined when $g = 0$; the values of f decrease as those of g increase.

31. $\frac{dy}{dx} = \sqrt{y} \cos^2 \sqrt{y} \Rightarrow \frac{dy}{\sqrt{y} \cos^2 \sqrt{y}} = dx \Rightarrow 2 \tan \sqrt{y} = x + C \Rightarrow y = \left(\tan^{-1} \left(\frac{x+C}{2} \right) \right)^2$

32. $y' = \frac{3y(x+1)^2}{y-1} \Rightarrow \frac{(y-1)}{y} dy = 3(x+1)^2 dx \Rightarrow y - \ln y = (x+1)^3 + C$

33. $yy' = \sec(y^2) \sec^2 x \Rightarrow \frac{y dy}{\sec(y^2)} = \sec^2 x dx \Rightarrow \frac{\sin(y^2)}{2} = \tan x + C \Rightarrow \sin(y^2) = 2 \tan x + C_1$

34. $y \cos^2(x) dy + \sin x dx = 0 \Rightarrow y dy = -\frac{\sin x}{\cos^2(x)} dx \Rightarrow \frac{y^2}{2} = -\frac{1}{\cos(x)} + C \Rightarrow y = \pm \sqrt{\frac{-2}{\cos(x)} + C_1}$

35. $\frac{dy}{dx} = e^{-x-y-2} \Rightarrow e^y dy = e^{-(x+2)} dx \Rightarrow e^y = -e^{-(x+2)} + C$. We have $y(0) = -2$, so $e^{-2} = -e^{-2} + C \Rightarrow C = 2e^{-2}$ and $e^y = -e^{-(x+2)} + 2e^{-2} \Rightarrow y = \ln(-e^{-(x+2)} + 2e^{-2})$

36. $\frac{dy}{dx} = \frac{y \ln y}{1+x^2} \Rightarrow \frac{dy}{y \ln y} = \frac{dx}{1+x^2} \Rightarrow \ln(\ln y) = \tan^{-1}(x) + C \Rightarrow y = e^{e^{\tan^{-1}(x)+C}}$. We have $y(0) = e^2 \Rightarrow e^2 = e^{e^{\tan^{-1}(0)+C}} \Rightarrow e^{\tan^{-1}(0)+C} = 2 \Rightarrow \tan^{-1}(0) + C = \ln 2 \Rightarrow 0 + C = \ln 2 \Rightarrow C = \ln 2 \Rightarrow y = e^{e^{-1} x + \ln 2}$

37. $x dy - (y + \sqrt{y}) dx = 0 \Rightarrow \frac{dy}{(y + \sqrt{y})} = \frac{dx}{x} \Rightarrow 2 \ln(\sqrt{y} + 1) = \ln x + C$. We have $y(1) = 1 \Rightarrow 2 \ln(\sqrt{1} + 1) = \ln 1 + C \Rightarrow 2 \ln 2 = C = \ln 2^2 = \ln 4$. So $2 \ln(\sqrt{y} + 1) = \ln x + \ln 4 = \ln(4x) \Rightarrow \ln(\sqrt{y} + 1) = \frac{1}{2} \ln(4x) = \ln(4x)^{1/2} \Rightarrow e^{\ln(\sqrt{y} + 1)} = e^{\ln(4x)^{1/2}} \Rightarrow \sqrt{y} + 1 = 2\sqrt{x} \Rightarrow y = (2\sqrt{x} - 1)^2$

38. $y^{-2} \frac{dx}{dy} = \frac{e^x}{e^{2x+1}} \Rightarrow \frac{e^{2x+1}}{e^x} dx = \frac{dy}{y^{-2}} \Rightarrow \frac{y^3}{3} = e^x - e^{-x} + C$. We have $y(0) = 1 \Rightarrow \frac{(1)^3}{3} = e^0 - e^0 + C \Rightarrow C = \frac{1}{3}$. So $\frac{y^3}{3} = e^x - e^{-x} + \frac{1}{3} \Rightarrow y^3 = 3(e^x - e^{-x}) + 1 \Rightarrow y = \left[3(e^x - e^{-x}) + 1 \right]^{1/3}$

39. Since the half life is 5730 years and $A(t) = A_0 e^{kt}$ we have $\frac{A_0}{2} = A_0 e^{5730k} \Rightarrow \frac{1}{2} = e^{5730k} \Rightarrow \ln(0.5) = 5730k$

$$\Rightarrow k = \frac{\ln(0.5)}{5730}. \text{ With 10\% of the original carbon-14 remaining we have } 0.1A_0 = A_0 e^{\frac{\ln(0.5)}{5730}t} \Rightarrow 0.1 = e^{\frac{\ln(0.5)}{5730}t}$$

$$\Rightarrow \ln(0.1) = \frac{\ln(0.5)}{5730}t \Rightarrow t = \frac{(5730)\ln(0.1)}{\ln(0.5)} \approx 19,035 \text{ years (rounded to the nearest year).}$$

40. $T - T_s = (T_o - T_s)e^{-kt} \Rightarrow 180 - 40 = (220 - 40)e^{-k/4}$, time in hours, $\Rightarrow k = -4 \ln\left(\frac{7}{9}\right) = 4 \ln\left(\frac{9}{7}\right)$

$$\Rightarrow 70 - 40 = (220 - 40)e^{-4 \ln(9/7)t} \Rightarrow t = \frac{\ln 6}{4 \ln(\frac{9}{7})} \approx 1.78 \text{ hr} \approx 107 \text{ min, the total time} \Rightarrow \text{the time it took to cool}$$

from 180° F to 70° F was 107 - 15 = 92 min

CHAPTER 7 ADDITIONAL AND ADVANCED EXERCISES

1. $A(t) = \int_0^t e^{-x} dx = [-e^{-x}]_0^t = 1 - e^{-t}, V(t) = \pi \int_0^t e^{-2x} dx = [-\frac{\pi}{2} e^{-2x}]_0^t = \frac{\pi}{2}(1 - e^{-2t})$

(a) $\lim_{t \rightarrow \infty} A(t) = \lim_{t \rightarrow \infty} (1 - e^{-t}) = 1$

(b) $\lim_{t \rightarrow \infty} \frac{V(t)}{A(t)} = \lim_{t \rightarrow \infty} \frac{\frac{\pi}{2}(1 - e^{-2t})}{1 - e^{-t}} = \frac{\pi}{2}$

(c) $\lim_{t \rightarrow 0^+} \frac{V(t)}{A(t)} = \lim_{t \rightarrow 0^+} \frac{\frac{\pi}{2}(1 - e^{-2t})}{1 - e^{-t}} = \lim_{t \rightarrow 0^+} \frac{\frac{\pi}{2}(1 - e^{-t})(1 + e^{-t})}{(1 - e^{-t})} = \lim_{t \rightarrow 0^+} \frac{\pi}{2}(1 + e^{-t}) = \pi$

2. (a) $\lim_{a \rightarrow 0^+} \log_a 2 = \lim_{a \rightarrow 0^+} \frac{\ln 2}{\ln a} = 0;$

$$\lim_{a \rightarrow 1^-} \log_a 2 = \lim_{a \rightarrow 1^-} \frac{\ln 2}{\ln a} = -\infty;$$

$$\lim_{a \rightarrow 1^+} \log_a 2 = \lim_{a \rightarrow 1^+} \frac{\ln 2}{\ln a} = \infty;$$

$$\lim_{a \rightarrow \infty} \log_a 2 = \lim_{a \rightarrow \infty} \frac{\ln 2}{\ln a} = 0$$

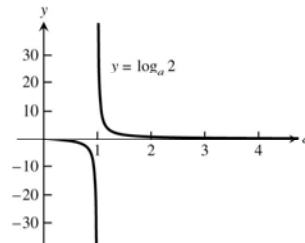

4. In the interval $\pi < x < 2\pi$ the function $\sin x < 0 \Rightarrow (\sin x)^{\sin x}$ is not defined for all values in that interval or its translation by 2π .

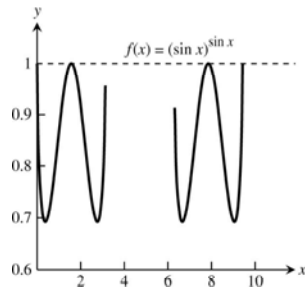

5. (a) $g(x) + h(x) = 0 \Rightarrow g(x) = -h(x);$ also $g(x) + h(x) = 0 \Rightarrow g(-x) + h(-x) = 0 \Rightarrow g(x) - h(x) = 0 \Rightarrow g(x) = h(x);$ therefore $-h(x) = h(x) \Rightarrow h(x) = 0 \Rightarrow g(x) = 0$

(b) $\frac{f(x)+f(-x)}{2} = \frac{[f_E(x)+f_O(x)]+[f_E(-x)+f_O(-x)]}{2} = \frac{f_E(x)+f_O(x)+f_E(x)-f_O(x)}{2} = f_E(x);$

$$\frac{f(x)-f(-x)}{2} = \frac{[f_E(x)+f_O(x)]-[f_E(-x)+f_O(-x)]}{2} = \frac{f_E(x)+f_O(x)-f_E(x)+f_O(x)}{2} = f_O(x)$$

(c) Part b \Rightarrow such a decomposition is unique.

6. (a) $g(0+0) = \frac{g(0)+g(0)}{1-g(0)g(0)} \Rightarrow [1-g^2(0)]g(0) = 2g(0) \Rightarrow g(0)-g^3(0) = 2g(0) \Rightarrow g^3(0)+g(0) = 0$
 $\Rightarrow g(0)[g^2(0)+1] = 0 \Rightarrow g(0) = 0$

(b) $g'(x) = \lim_{h \rightarrow 0} \frac{g(x+h)-g(x)}{h} = \lim_{h \rightarrow 0} \frac{\left[\frac{g(x)+g(h)}{1-g(x)g(h)}\right]-g(x)}{h} = \lim_{h \rightarrow 0} \frac{g(x)+g(h)-g(x)+g^2(x)g(h)}{h[1-g(x)g(h)]}$
 $= \lim_{h \rightarrow 0} \left[\frac{g(h)}{h}\right] \left[\frac{1+g^2(x)}{1-g(x)g(h)}\right] = 1 \cdot [1+g^2(x)] = 1+g^2(x) = 1+[g(x)]^2$

(c) $\frac{dy}{dx} = 1+y^2 \Rightarrow \frac{dy}{1+y^2} = dx \Rightarrow \tan^{-1} y = x+C \Rightarrow \tan^{-1}(g(x)) = x+C; g(0) = 0 \Rightarrow \tan^{-1} 0 = 0+C$
 $\Rightarrow C = 0 \Rightarrow \tan^{-1}(g(x)) = x \Rightarrow g(x) = \tan x$

7. $M = \int_0^1 \frac{2}{1+x^2} dx = 2 \left[\tan^{-1} x \right]_0^1 = \frac{\pi}{2}$ and $M_y = \int_0^1 \frac{2x}{1+x^2} dx = \left[\ln(1+x^2) \right]_0^1 = \ln 2 \Rightarrow \bar{x} = \frac{M_y}{M} = \frac{\ln 2}{\frac{\pi}{2}} = \frac{\ln 4}{\pi}; \bar{y} = 0$ by symmetry

8. (a) $V = \pi \int_{1/4}^4 \left(\frac{1}{2\sqrt{x}}\right)^2 dx = \frac{\pi}{4} \int_{1/4}^4 \frac{1}{x} dx = \frac{\pi}{4} [\ln|x|]_{1/4}^4 = \frac{\pi}{4} (\ln 4 - \ln \frac{1}{4}) = \frac{\pi}{4} \ln 16 = \frac{\pi}{4} \ln(2^4) = \pi \ln 2$

(b) $M_y = \int_{1/4}^4 x \left(\frac{1}{2\sqrt{x}}\right) dx = \frac{1}{2} \int_{1/4}^4 x^{1/2} dx = \left[\frac{1}{3} x^{3/2}\right]_{1/4}^4 = \left(\frac{8}{3} - \frac{1}{24}\right) = \frac{64-1}{24} = \frac{63}{24};$

$M_x = \int_{1/4}^4 \frac{1}{2} \left(\frac{1}{2\sqrt{x}}\right) \left(\frac{1}{2\sqrt{x}}\right) dx = \frac{1}{8} \int_{1/4}^4 \frac{1}{x} dx = \left[\frac{1}{8} \ln|x|\right]_{1/4}^4 = \frac{1}{8} \ln 16 = \frac{1}{2} \ln 2;$

$M = \int_{1/4}^4 \frac{1}{2\sqrt{x}} dx = \int_{1/4}^4 \frac{1}{2} x^{-1/2} dx = \left[x^{1/2}\right]_{1/4}^4 = 2 - \frac{1}{2} = \frac{3}{2};$ therefore, $\bar{x} = \frac{M_y}{M} = \left(\frac{63}{24}\right)\left(\frac{2}{3}\right) = \frac{21}{12} = \frac{7}{4}$ and

$\bar{y} = \frac{M_x}{M} = \left(\frac{1}{2} \ln 2\right)\left(\frac{2}{3}\right) = \frac{\ln 2}{3}$

9. $A(t) = A_0 e^{rt}; A(t) = 2A_0 \Rightarrow 2A_0 = A_0 e^{rt} \Rightarrow e^{rt} = 2 \Rightarrow rt = \ln 2 \Rightarrow t = \frac{\ln 2}{r} \Rightarrow t \approx \frac{7}{r} = \frac{70}{100r} = \frac{70}{(r\%)}$

10. In order to maximize the amount of sunlight, we need to maximize the angle θ formed by extending the two red line segments to their vertex. The angle between the two lines is given by $\theta = \pi - (\theta_1 + (\pi - \theta_2))$. From trig we

have $\tan \theta_1 = \frac{350}{450-x} \Rightarrow \theta_1 = \tan^{-1}\left(\frac{350}{450-x}\right)$ and $\tan(\pi - \theta_2) = \frac{200}{x} \Rightarrow (\pi - \theta_2) = \tan^{-1}\left(\frac{200}{x}\right)$

$\Rightarrow \theta = \pi - (\theta_1 + (\pi - \theta_2)) = \pi - \tan^{-1}\left(\frac{350}{450-x}\right) - \tan^{-1}\left(\frac{200}{x}\right)$

$\Rightarrow \frac{d\theta}{dx} = -\frac{1}{1+\left(\frac{350}{450-x}\right)^2} \cdot \frac{350}{(450-x)^2} - \frac{1}{1+\left(\frac{200}{x}\right)^2} \cdot \left(-\frac{200}{x^2}\right) = \frac{-350}{(450-x)^2+122500} + \frac{200}{x^2+40000}$

$\frac{d\theta}{dx} = 0 \Rightarrow \frac{-350}{(450-x)^2+122500} + \frac{200}{x^2+40000} = 0 \Rightarrow 200((450-x)^2+122500) = 350(x^2+40000)$

$\Rightarrow 3x^2 + 3600x - 1020000 = 0 \Rightarrow x = -600 \pm 100\sqrt{70}$. Since $x > 0$, consider only $x = -600 + 100\sqrt{70}$. Using the first derivative test, $\left.\frac{d\theta}{dx}\right|_{x=100} = \frac{9}{3500} > 0$ and $\left.\frac{d\theta}{dx}\right|_{x=400} = \frac{-9}{5000} < 0 \Rightarrow$ local max when

$x = -600 + 100\sqrt{70} \approx 236.67$ ft.

CHAPTER 8 TECHNIQUES OF INTEGRATION

8.1 USING BASIC INTEGRATION FORMULAS

1. $\int_0^1 \frac{16x}{8x^2+2} dx$

$$u = 8x^2 + 2 \quad du = 16x dx$$

$$u = 2 \text{ when } x = 0, \quad u = 10 \text{ when } x = 1$$

$$\begin{aligned} \int_0^1 \frac{16x}{8x^2+2} dx &= \int_2^{10} \frac{1}{u} du = \ln|u| \Big|_2^{10} \\ &= \ln 10 - \ln 2 = \ln 5 \end{aligned}$$

2. $\int \frac{x^2}{x^2+1} dx$

Use long division to write the integrand as $1 - \frac{1}{x^2+1}$.

$$\begin{aligned} \int \frac{x^2}{x^2+1} dx &= \int 1 dx - \int \frac{1}{x^2+1} dx \\ &= x - \tan^{-1} x + C \end{aligned}$$

3. $\int (\sec x - \tan x)^2 dx$

$$\begin{aligned} \text{Expand the integrand: } (\sec x - \tan x)^2 &= \sec^2 x - 2\sec x \tan x + \tan^2 x \\ &= \sec^2 x - 2\sec x \tan x + (\sec^2 x - 1) \\ &= 2\sec^2 x - 2\sec x \tan x - 1 \end{aligned}$$

$$\begin{aligned} \int (\sec x - \tan x)^2 dx &= 2 \int \sec^2 x dx - 2 \int \sec x \tan x dx - \int 1 dx \\ &= 2 \tan x - 2 \sec x - x + C \end{aligned}$$

We have used Formulas 8 and 10 from Table 8.1.

4. $\int_{\pi/4}^{\pi/3} \frac{1}{\cos^2 x \tan x} dx$

$$u = \tan x \quad du = \sec^2 x dx = \frac{1}{\cos^2 x} dx$$

$$u = 1 \text{ when } x = \pi/4, \quad u = \sqrt{3} \text{ when } x = \pi/3$$

$$\begin{aligned} \int_{\pi/4}^{\pi/3} \frac{1}{\cos^2 x \tan x} dx &= \int_1^{\sqrt{3}} \frac{1}{u} du = \ln|u| \Big|_1^{\sqrt{3}} \\ &= \ln \sqrt{3} - \ln 1 = \frac{1}{2} \ln 3 \end{aligned}$$

$$5. \int \frac{1-x}{\sqrt{1-x^2}} dx$$

Write as the sum of two integrals:

$$\int \frac{1-x}{\sqrt{1-x^2}} dx = \int \frac{1}{\sqrt{1-x^2}} dx - \int \frac{x}{\sqrt{1-x^2}} dx$$

For the first integral use Formula 18 in Table 8.1 with $a = 1$.

For the second:

$$u = 1-x^2 \quad du = -2x dx$$

$$\begin{aligned} \int \frac{x}{\sqrt{1-x^2}} dx &= -\frac{1}{2} \int \frac{1}{u^{1/2}} du \\ &= -\sqrt{u} = -\sqrt{1-x^2} \end{aligned}$$

$$\text{So } \int \frac{1-x}{\sqrt{1-x^2}} dx = \sin^{-1} x + \sqrt{1-x^2} + C$$

$$6. \int \frac{1}{x-\sqrt{x}} dx$$

$$u = \sqrt{x} - 1 \quad du = \frac{1}{2\sqrt{x}} dx$$

$$\begin{aligned} \int \frac{1}{x-\sqrt{x}} dx &= 2 \int \frac{1}{u} du \\ &= 2 \ln |u| + C = 2 \ln |\sqrt{x} - 1| + C \end{aligned}$$

$$7. \int \frac{e^{-\cot z}}{\sin^2 z} dz$$

$$u = -\cot z \quad du = -\csc^2 z dz = \frac{1}{\sin^2 z} dz$$

$$\begin{aligned} \int \frac{e^{-\cot z}}{\sin^2 z} dz &= \int e^{-u} du \\ &= e^{-u} + C = e^{-\cot z} + C \end{aligned}$$

$$8. \int \frac{2^{\ln z^3}}{16z} dz$$

$$u = \ln z^3 = 3 \ln z \quad du = \frac{3}{z} dz$$

Using Formula 5 in Table 8.1,

$$\begin{aligned} \int \frac{2^{\ln z^3}}{16z} dz &= \frac{1}{48} \int 2^u du \\ &= \frac{2^u}{48 \ln 2} + C = \frac{2^{\ln z^3}}{48 \ln 2} + C \end{aligned}$$

$$9. \int \frac{1}{e^z + e^{-z}} dz$$

Multiply the integrand by $\frac{e^z}{e^z}$.

$$\int \frac{1}{e^z + e^{-z}} dz = \int \frac{e^z}{e^{2z} + 1} dx$$

$$u = e^z \quad du = e^z dx$$

$$\begin{aligned} \int \frac{e^z}{e^{2z} + 1} dx &= \int \frac{1}{u^2 + 1} du \\ &= \tan^{-1} u + C = \tan^{-1} e^z + C \end{aligned}$$

$$10. \int_1^2 \frac{8}{x^2 - 2x + 2} dx$$

$$u = x - 1 \quad du = dx$$

$$u = 0 \text{ when } x = 1, \quad u = 1 \text{ when } x = 2$$

$$\begin{aligned} \int_1^2 \frac{8}{x^2 - 2x + 2} dx &= 8 \int_0^1 \frac{1}{u^2 + 1} du \\ &= 8 \tan^{-1} u \Big|_0^1 = 8 \left(\frac{\pi}{4} - 0 \right) = 2\pi \end{aligned}$$

$$11. \int_{-1}^0 \frac{4}{1 + (2x + 1)^2} dx$$

$$u = 2x + 1 \quad du = 2dx$$

$$u = -1 \text{ when } x = -1, \quad u = 1 \text{ when } x = 0$$

$$\begin{aligned} \int_{-1}^0 \frac{4}{1 + (2x + 1)^2} dx &= 2 \int_{-1}^1 \frac{1}{1 + u^2} du \\ &= 2 \tan^{-1} u \Big|_{-1}^1 = 2 \left(\frac{\pi}{4} - \left(-\frac{\pi}{4} \right) \right) = \pi \end{aligned}$$

$$12. \int_{-1}^3 \frac{4x^2 - 7}{2x + 3} dx$$

Use long division to write the integrand as $2x - 3 + \frac{2}{2x + 3}$.

$$\int_{-1}^3 \frac{4x^2 - 7}{2x + 3} dx = \int_{-1}^3 2x dx - \int_{-1}^3 3 dx + \int_{-1}^3 \frac{2}{2x + 3} dx$$

$$\int_{-1}^3 2x dx - \int_{-1}^3 3 dx = x^2 \Big|_{-1}^3 - 3x \Big|_{-1}^3 = 8 - 12 = -4$$

For the last integral,

$$u = 2x + 3 \quad du = 2 dx$$

$$u = 1 \text{ when } x = -1, \quad u = 9 \text{ when } x = 3$$

$$\int_{-1}^3 \frac{2}{2x+3} dx = \int_1^9 \frac{1}{u} du$$

$$= |\ln u|_1^9 = \ln 9 - \ln 1 = 2 \ln 3$$

$$\text{So } \int_{-1}^3 \frac{4x^2-7}{2x+3} dx = -4 + 2 \ln 3$$

$$13. \int \frac{1}{1-\sec t} dt$$

Multiply the integrand by $\frac{1+\sec t}{1+\sec t}$.

$$\frac{1}{1-\sec t} \cdot \frac{1+\sec t}{1+\sec t} = \frac{-1-\sec t}{\tan^2 t} = -\cot^2 t - \frac{\cos t}{\sin^2 t} = 1 - \csc^2 t - \frac{\cos t}{\sin^2 t}$$

$$\int \frac{1}{1-\sec t} dt = \int 1 dt - \int \csc^2 t dt - \int \frac{\cos t}{\sin^2 t} dt$$

$$= t + \cot t + \csc t + C$$

Here we have used Formula 9 in Table 8.1 for the second integral, and the substitution $u = \sin t$, $du = \cos t dt$

for the third integral, which gives it the form $\int \frac{1}{u^2} du = -\frac{1}{u} = -\frac{1}{\sin t}$.

$$14. \int \csc t \sin 3t dt$$

Write $\sin 3t$ as $\sin(2t+t)$ and expand.

$$\csc t \sin 3t = \frac{\cos 2t \sin t + (2 \sin t \cos t) \cos t}{\sin t}$$

$$= \cos 2t + 2 \cos^2 t = 2 \cos 2t + 1$$

$$\int \csc t \sin 3t dt = \int 2 \cos 2t dt + \int 1 dt$$

$$= \sin 2t + t + C$$

$$15. \int_0^{\pi/4} \frac{1+\sin \theta}{\cos^2 \theta} d\theta$$

Split into two integrals.

$$\int_0^{\pi/4} \frac{1+\sin \theta}{\cos^2 \theta} d\theta = \int_0^{\pi/4} \frac{1}{\cos^2 \theta} d\theta + \int_0^{\pi/4} \frac{\sin \theta}{\cos^2 \theta} d\theta$$

$$= \int_0^{\pi/4} \sec^2 \theta d\theta + \int_0^{\pi/4} \frac{\sin \theta}{\cos^2 \theta} d\theta$$

$$= [\tan \theta + \sec \theta]_0^{\pi/4} = (1 + \sqrt{2}) - (0 + 1) = \sqrt{2}$$

The second integral is evaluated with the substitution $u = \cos \theta$ $du = -\sin \theta d\theta$, which gives

$$\int \frac{\sin \theta}{\cos^2 \theta} d\theta = -\int \frac{1}{u^2} du = \frac{1}{u} = \frac{1}{\cos \theta}$$

$$16. \int \frac{1}{\sqrt{2\theta - \theta^2}} d\theta$$

Write the integrand as $\frac{1}{\sqrt{1 - (\theta - 1)^2}}$. With $u = \theta - 1$, $du = d\theta$,

$$\begin{aligned} \int \frac{1}{\sqrt{2\theta - \theta^2}} d\theta &= \int \frac{1}{\sqrt{1 - (\theta - 1)^2}} d\theta \\ &= \int \frac{1}{\sqrt{1 - u^2}} du = \sin^{-1} u + C = \sin^{-1}(\theta - 1) + C \end{aligned}$$

We have used Formula 18 in Table 8.1 with $a = 1$.

$$17. \int \frac{\ln y}{y + 4 \ln^2 y} dy$$

Write the integrand as $\frac{\ln y}{y} \cdot \frac{1}{1 + 4 \ln^2 y}$.

$$u = 1 + 4 \ln^2 y \quad du = \frac{8 \ln y}{y} dy$$

$$\begin{aligned} \int \frac{\ln y}{y + 4 \ln^2 y} dy &= \int \frac{\ln y}{y} \cdot \frac{1}{1 + 4 \ln^2 y} dy \\ &= \frac{1}{8} \int \frac{1}{u} du = \frac{1}{8} \ln |u| + C = \frac{1}{8} \ln(1 + 4 \ln^2 y) + C \end{aligned}$$

Note that the argument of the logarithm is positive, so we don't need absolute value bars.

$$18. \int \frac{2\sqrt{y}}{2\sqrt{y}} dy$$

$$u = \sqrt{y} \quad du = \frac{1}{2\sqrt{y}} dy$$

Using Formula 5 in Table 8.1,

$$\begin{aligned} \int \frac{2\sqrt{y}}{2\sqrt{y}} dy &= \int 2^u du \\ &= \frac{1}{\ln 2} 2^u + C = \frac{1}{\ln 2} 2\sqrt{y} + C \end{aligned}$$

$$19. \int \frac{1}{\sec \theta + \tan \theta} d\theta$$

Multiply the integrand by $\frac{\cos \theta}{\cos \theta}$.

$$\int \frac{1}{\sec \theta + \tan \theta} \cdot \frac{\cos \theta}{\cos \theta} d\theta = \int \frac{\cos \theta}{1 + \sin \theta} d\theta$$

$$u = 1 + \sin \theta \quad du = \cos \theta d\theta$$

$$\begin{aligned}\int \frac{\cos \theta}{1 + \sin \theta} d\theta &= \int \frac{1}{u} du = \ln|u| + C \\ &= \ln(1 + \sin \theta) + C\end{aligned}$$

We can discard the absolute value because $1 + \sin \theta$ is never negative.

$$20. \int \frac{1}{t\sqrt{3+t^2}} dt$$

Use Formula 5 in Table 7.10, with $a = \sqrt{3}$.

$$\int \frac{1}{t\sqrt{3+t^2}} dt = -\frac{1}{\sqrt{3}} \operatorname{csch}^{-1} \left| \frac{t}{\sqrt{3}} \right| + C$$

$$21. \int \frac{4t^3 - t^2 + 16t}{t^2 + 4} dt$$

Use long division to write the integrand as $4t - 1 + \frac{4}{t^2 + 4}$.

$$\begin{aligned}\int \frac{4t^3 - t^2 + 16t}{t^2 + 4} dt &= \int 4t dt - \int 1 dt + 4 \int \frac{1}{t^2 + 4} dt \\ &= 2t^2 - t + 2 \tan^{-1} \left(\frac{t}{2} \right) + C\end{aligned}$$

To evaluate the third integral we used Formula 19 in Table 8.1 with $a = 2$.

$$22. \int \frac{x + 2\sqrt{x-1}}{2x\sqrt{x-1}} dx$$

Split into two integrals.

$$\begin{aligned}\int \frac{x + 2\sqrt{x-1}}{2x\sqrt{x-1}} dx &= \int \frac{1}{2\sqrt{x-1}} dx + \int \frac{1}{x} dx \\ &= \sqrt{x-1} + \ln|x| + C\end{aligned}$$

For the first integral we used $u = \sqrt{x-1}$, $du = \frac{1}{2\sqrt{x-1}} dx$, $\int du = u + C$

$$23. \int_0^{\pi/2} \sqrt{1 - \cos \theta} d\theta$$

Multiply the integrand by $\frac{\sqrt{1 + \cos \theta}}{\sqrt{1 + \cos \theta}}$.

$$\int_0^{\pi/2} \sqrt{1 - \cos \theta} d\theta = \int_0^{\pi/2} \frac{\sqrt{1 - \cos^2 \theta}}{\sqrt{1 + \cos \theta}} d\theta = \int_0^{\pi/2} \frac{\sin \theta}{\sqrt{1 + \cos \theta}} d\theta.$$

(Note that when $0 \leq \theta \leq \pi/2$, $\sin \theta \geq 0$ so $\sqrt{\sin^2 \theta} = \sin \theta$.)

$$u = 1 + \cos \theta \quad du = -\sin \theta d\theta$$

$$u = 2 \text{ when } \theta = 0, \quad u = 1 \text{ when } \theta = \pi/2$$

$$\int_0^{\pi/2} \frac{\sin \theta}{\sqrt{1 + \cos \theta}} d\theta = -\int_2^1 \frac{1}{\sqrt{u}} du = \int_1^2 \frac{1}{\sqrt{u}} du = 2\sqrt{u} \Big|_1^2 = 2\sqrt{2} - 2$$

$$24. \int (\sec t + \cot t)^2 dt$$

Expand the integrand:

$$\begin{aligned} (\sec t + \cot t)^2 &= \sec^2 t + 2\sec t \cot t + \cot^2 t \\ &= \sec^2 t + 2\sec t \cot t + \csc^2 t - 1 \end{aligned}$$

$$\begin{aligned} \int (\sec t + \cot t)^2 dt &= \int \sec^2 t dt + 2 \int \csc t dt + \int \csc^2 t dt - \int 1 dt \\ &= \tan t - 2 \ln |\csc t + \cot t| - \cot t - t + C \end{aligned}$$

We have used Formulas 8, 9 and 15 from Table 8.1.

$$25. \int \frac{1}{\sqrt{e^{2y} - 1}} dy$$

Multiply the integrand by $\frac{e^y}{e^y}$.

$$\int \frac{1}{\sqrt{e^{2y} - 1}} dy = \int \frac{e^y}{e^y \sqrt{e^{2y} - 1}} dy; \quad u = e^y \quad du = e^y dy$$

$$\begin{aligned} \int \frac{e^y}{e^y \sqrt{e^{2y} - 1}} dy &= \int \frac{1}{u \sqrt{u^2 - 1}} du \\ &= \sec^{-1} |u| + C = \sec^{-1} e^y + C \end{aligned}$$

We have used Formula 20 in Table 8.1.

$$26. \int \frac{6}{\sqrt{y}(1+y)} dy$$

$$u = \sqrt{y} \quad du = \frac{1}{2\sqrt{y}} dy$$

$$\begin{aligned} \int \frac{6}{\sqrt{y}(1+y)} dy &= 12 \int \frac{1}{1+u^2} du \\ &= 12 \tan^{-1} \sqrt{y} + C \end{aligned}$$

$$27. \int \frac{2}{x\sqrt{1-4 \ln^2 x}} dx$$

$$u = 2 \ln x \quad du = \frac{2}{x} dx$$

$$\begin{aligned} \int \frac{2}{x\sqrt{1-4 \ln^2 x}} dx &= \int \frac{1}{\sqrt{1-u^2}} du \\ &= \sin^{-1} u + C = \sin^{-1} (2 \ln x) + C \end{aligned}$$

$$28. \int \frac{1}{(x-2)\sqrt{x^2-4x+3}} dx$$

$$u = x-2 \quad du = dx$$

$$\begin{aligned} \int \frac{1}{(x-2)\sqrt{x^2-4x+3}} dx &= \int \frac{1}{u\sqrt{u^2-1}} du \\ &= \sec^{-1}|u| + C = \sec^{-1}|x-2| + C \end{aligned}$$

We have used Formula 20 in Table 8.1 with $a=1$.

$$29. \int (\csc x - \sec x)(\sin x + \cos x) dx$$

Expand the integrand and separate into two integrals.

$$(\csc x - \sec x)(\sin x + \cos x) = 1 + \cot x - \tan x - 1 = \cot x - \tan x$$

$$\begin{aligned} \int (\csc x - \sec x)(\sin x + \cos x) dx &= \int \cot x dx - \int \tan x dx \\ &= \ln|\sin x| - \ln|\sec x| + C = \ln|\sin x| + \ln|\cos x| + C \end{aligned}$$

We have used Formulas 12 and 13 from Table 8.1.

$$30. \int 3 \sinh\left(\frac{x}{2} + \ln 5\right) dx$$

$$u = \frac{x}{2} + \ln 5 \quad du = \frac{1}{2} dx$$

$$\begin{aligned} \int 3 \sinh\left(\frac{x}{2} + \ln 5\right) dx &= 6 \int \sinh u du \\ &= 6 \cosh u + C = 6 \cosh\left(\frac{x}{2} + \ln 5\right) + C \end{aligned}$$

$$31. \int_{\sqrt{2}}^3 \frac{2x^3}{x^2-1} dx$$

Use long division to write the integrand as $2x + \frac{2x}{x^2-1}$.

$$\int_{\sqrt{2}}^3 \frac{2x^3}{x^2-1} dx = \int_{\sqrt{2}}^3 \left(2x + \frac{2x}{x^2-1}\right) dx = \int_{\sqrt{2}}^3 2x dx + \int_{\sqrt{2}}^3 \frac{2x}{x^2-1} dx$$

For the second integral we use $u = x^2$, $du = 2x dx$.

$$\begin{aligned} \int_{\sqrt{2}}^3 2x dx + \int_{\sqrt{2}}^3 \frac{2x}{x^2-1} dx &= x^2 \Big|_{\sqrt{2}}^3 + \ln|x^2-1| \Big|_{\sqrt{2}}^3 \\ &= (9-2) + (\ln 8 - \ln 1) \\ &= 7 + \ln 8 \approx 9.079 \end{aligned}$$

32. $\int_{-1}^1 \sqrt{1+x^2} \sin x \, dx$ is the integral of an odd function over an interval symmetric to 0, so its value is 0.

33. $\int_{-1}^0 \sqrt{\frac{1+y}{1-y}} \, dy$

Multiply the integrand by $\frac{\sqrt{1+y}}{\sqrt{1+y}}$ and split the indefinite integral into a sum.

$$\begin{aligned} \int \sqrt{\frac{1+y}{1-y}} \, dy &= \int \frac{1+y}{\sqrt{1-y^2}} \, dy = \int \frac{1}{\sqrt{1-y^2}} \, dy + \int \frac{y}{\sqrt{1-y^2}} \, dy \\ &= \sin^{-1} y - \sqrt{1-y^2} + C \end{aligned}$$

The first integral is Formula 18 in Section 8.1, and for the second we use the substitution $u = 1 - y^2$, $du = -2y \, dy$. So

$$\begin{aligned} \int_{-1}^0 \sqrt{\frac{1+y}{1-y}} \, dy &= \left[\sin^{-1} y - \sqrt{1-y^2} \right]_{-1}^0 \\ &= (0-1) - \left(-\frac{\pi}{2} - 0 \right) = \frac{\pi}{2} - 1 \end{aligned}$$

34. $\int e^{z+e^z} \, dz$

Write the integrand as $e^z e^{e^z}$ and use the substitution $u = e^z$, $du = e^z \, dz$.

$$\begin{aligned} \int e^{z+e^z} \, dz &= \int e^z e^{e^z} \, dz = \int e^u \, du \\ &= e^u + C = e^{e^z} + C \end{aligned}$$

35. $\int \frac{7}{(x-1)\sqrt{x^2-2x-48}} \, dx$

$$u = x-1, \quad du = dx; \quad x^2 - 2x - 48 = u^2 - 7^2$$

We use Formula 20 in Table 8.1.

$$\begin{aligned} \int \frac{7}{(x-1)\sqrt{x^2-2x-48}} \, dx &= \int \frac{7}{u\sqrt{u^2-7^2}} \, du \\ &= \frac{1}{7} \left(7 \sec^{-1} \left| \frac{u}{7} \right| \right) + C = \sec^{-1} \left| \frac{x-1}{7} \right| + C \end{aligned}$$

$$36. \int \frac{1}{(2x+1)\sqrt{4x+4x^2}} dx$$

$$u = 2x+1, \quad du = 2dx; \quad 4x+4x^2 = u^2 - 1^2$$

We use Formula 20 in Table 8.1.

$$\begin{aligned} \int \frac{1}{(2x+1)\sqrt{4x+4x^2}} dx &= \frac{1}{2} \int \frac{1}{u\sqrt{u^2-1^2}} du \\ &= \frac{1}{2} \sec^{-1}|u| + C = \frac{1}{2} \sec^{-1}|2x+1| + C \end{aligned}$$

$$37. \int \frac{2\theta^3 - 7\theta^2 + 7\theta}{2\theta - 5} d\theta$$

Use long division to write the integrand as $\theta^2 - \theta + 1 + \frac{5}{2\theta - 5}$.

$$\begin{aligned} \int \frac{2\theta^3 - 7\theta^2 + 7\theta}{2\theta - 5} d\theta &= \int \theta^2 d\theta - \int \theta d\theta + \int 1 d\theta + \int \frac{5}{2\theta - 5} d\theta \\ &= \frac{1}{3}\theta^3 - \frac{1}{2}\theta^2 + \theta + \frac{5}{2} \ln|2\theta - 5| + C \end{aligned}$$

In the last integral we have used the substitution $u = 2\theta - 5$, $du = 2d\theta$.

$$38. \int \frac{1}{\cos \theta - 1} d\theta$$

Multiply the integrand by $\frac{\cos \theta + 1}{\cos \theta + 1}$.

$$\frac{1}{\cos \theta - 1} \frac{\cos \theta + 1}{\cos \theta + 1} = \frac{\cos \theta + 1}{\cos^2 \theta - 1} = -\frac{1 + \cos \theta}{\sin^2 \theta} = -\csc^2 \theta - \csc \theta \cot \theta$$

$$\begin{aligned} \int (-\csc^2 \theta - \csc \theta \cot \theta) d\theta &= -\int \csc^2 \theta d\theta - \int \csc \theta \cot \theta d\theta \\ &= \cot \theta + \csc \theta + C \end{aligned}$$

We have used Formulas 9 and 11 from Table 8.1.

$$39. \int \frac{1}{1+e^x} dx$$

Use one step of long division to write the integrand as $1 - \frac{e^x}{1+e^x}$.

$$\int \frac{1}{1+e^x} dx = \int 1 dx - \int \frac{e^x}{1+e^x} dx = x - \ln(1+e^x) + C$$

For the second integral we have used the substitution $u = 1 + e^x$, $du = e^x dx$. Note that $1 + e^x$ is always positive.

$$40. \int \frac{\sqrt{x}}{1+x^3} dx$$

$$u = x^{3/2}, \quad du = \frac{3}{2} x^{1/2} dx$$

$$\begin{aligned} \int \frac{\sqrt{x}}{1+x^3} dx &= \frac{2}{3} \int \frac{1}{1+u^2} du \\ &= \frac{2}{3} \tan^{-1} u + C = \frac{2}{3} \tan^{-1} x^{3/2} + C \end{aligned}$$

$$\begin{aligned} 41. \text{ The area is } \int_{-\pi/4}^{\pi/4} (2 \cos x - \sec x) dx &= [2 \sin x - \ln |\sec x + \tan x|]_{-\pi/4}^{\pi/4} \\ &= (\sqrt{2} - \ln |\sqrt{2} + 1|) - (-\sqrt{2} - \ln |\sqrt{2} - 1|) \\ &= 2\sqrt{2} + \ln \left(\frac{\sqrt{2} - 1}{\sqrt{2} + 1} \right) = 2\sqrt{2} - \ln(3 + 2\sqrt{2}) \approx 1.066 \end{aligned}$$

$$42. \text{ The volume using the washer method is } \pi \int_{-\pi/4}^{\pi/4} (4 \cos^2 x - \sec^2 x) dx.$$

Split into two integrals; for the first write $4 \cos^2 x$ as $2(1 + \cos 2x)$ and for the second use Formula 8 in Table 8.1.

$$\begin{aligned} \pi \int_{-\pi/4}^{\pi/4} (4 \cos^2 x - \sec^2 x) dx &= \pi \int_{-\pi/4}^{\pi/4} 4 \cos^2 x dx - \pi \int_{-\pi/4}^{\pi/4} \sec^2 x dx \\ &= \pi \int_{-\pi/4}^{\pi/4} 2(1 + \cos 2x) dx - \pi \int_{-\pi/4}^{\pi/4} \sec^2 x dx \\ &= \pi [2x + \sin 2x]_{-\pi/4}^{\pi/4} - \pi \tan x \Big|_{-\pi/4}^{\pi/4} \\ &= \pi \left(\left(\frac{\pi}{2} + 1 \right) - \left(-\frac{\pi}{2} - 1 \right) \right) - \pi(1 - (-1)) = \pi^2 \end{aligned}$$

43. For $y = \ln(\cos x)$, $dy/dx = -\tan x$. The arc length is given by

$$\int_0^{\pi/3} \sqrt{1 + (-\tan x)^2} dx = \int_0^{\pi/3} \sec x dx \text{ since } \sec x \text{ is positive on the interval of integration.}$$

$$\begin{aligned} \int_0^{\pi/3} \sec x dx &= \ln |\sec x + \tan x| \Big|_0^{\pi/3} \\ &= \ln(2 + \sqrt{3}) - \ln(1 + 0) = \ln(2 + \sqrt{3}) \end{aligned}$$

44. For $y = \ln(\sec x)$, $dy/dx = \tan x$. The arc length is given by

$$\int_0^{\pi/4} \sqrt{1 + (\tan x)^2} dx = \int_0^{\pi/4} \sec x dx \text{ since } \sec x \text{ is positive on the interval of integration.}$$

$$\begin{aligned} \int_0^{\pi/4} \sec x dx &= \ln |\sec x + \tan x| \Big|_0^{\pi/4} \\ &= \ln(\sqrt{2} + 1) - \ln(1 + 0) = \ln(\sqrt{2} + 1) \end{aligned}$$

45. Since secant is an even function and the domain is symmetric to 0,
- $\bar{x} = 0$
- .

For the y-coordinate:

$$\begin{aligned}\bar{y} &= \frac{\frac{1}{2} \int_{-\pi/4}^{\pi/4} \sec^2 x \, dx}{\int_{-\pi/4}^{\pi/4} \sec x \, dx} = \frac{\frac{1}{2} \tan x \Big|_{-\pi/4}^{\pi/4}}{\ln|\sec x + \tan x| \Big|_{-\pi/4}^{\pi/4}} \\ &= \frac{1}{\left(\ln(\sqrt{2} + 1) - \ln(\sqrt{2} - 1)\right)} \\ &= \frac{1}{\ln\left(\frac{\sqrt{2} + 1}{\sqrt{2} - 1}\right)} = \frac{1}{\ln(3 + 2\sqrt{2})} \approx 0.567\end{aligned}$$

46. Since both cosecant and the domain are symmetric around
- $\pi/2$
- ,
- $\bar{x} = \pi/2$
- .

$$\begin{aligned}\bar{y} &= \frac{\frac{1}{2} \int_{\pi/6}^{5\pi/6} \csc^2 x \, dx}{\int_{\pi/6}^{5\pi/6} \csc x \, dx} = \frac{-\frac{1}{2} \cot x \Big|_{\pi/6}^{5\pi/6}}{-\ln|\csc x + \cot x| \Big|_{\pi/6}^{5\pi/6}} \\ &= \frac{-\frac{1}{2}(\sqrt{3} - (-\sqrt{3}))}{-\left(\ln(2 + \sqrt{3}) - \ln(2 - \sqrt{3})\right)} \\ &= \frac{\sqrt{3}}{\ln\left(\frac{2 + \sqrt{3}}{2 - \sqrt{3}}\right)} = \frac{\sqrt{3}}{\ln(7 + 4\sqrt{3})} \approx 0.658\end{aligned}$$

47. $\int (1 + 3x^3) e^{x^3} dx = x e^{x^3} + C$

48. $\int \frac{1}{1 + \sin^2 x} dx$

Multiply the integrand by $\frac{\sec^2 x}{\sec^2 x}$.

$$\int \frac{1}{1 + \sin^2 x} dx = \int \frac{\sec^2 x}{\sec^2 x + \tan^2 x} dx = \int \frac{\sec^2 x}{1 + 2 \tan^2 x} dx$$

$$u = \tan x, \quad du = \sec^2 x \, dx$$

$$\int \frac{\sec^2 x}{1 + 2 \tan^2 x} dx = \int \frac{1}{1 + 2u^2} du$$

$$v = \sqrt{2}u, \quad dv = \sqrt{2} \, du$$

$$\begin{aligned}\int \frac{1}{1 + 2u^2} du &= \frac{1}{\sqrt{2}} \int \frac{1}{1 + v^2} dv \\ &= \frac{1}{\sqrt{2}} \tan^{-1} v + C \\ &= \frac{1}{\sqrt{2}} \tan^{-1}(\sqrt{2} \tan x) + C\end{aligned}$$

$$49. \int x^7 \sqrt{x^4 + 1} dx$$

$$u = x^4 + 1, \quad du = 4x^3 dx; \quad x^7 dx = \frac{u-1}{4} du$$

$$\begin{aligned} \int x^7 \sqrt{x^4 + 1} dx &= \frac{1}{4} \int (u-1) \sqrt{u} du \\ &= \frac{1}{4} \int u^{3/2} du - \frac{1}{4} \int u^{1/2} du \\ &= \frac{1}{10} u^{5/2} - \frac{1}{6} u^{3/2} + C \\ &= \frac{1}{30} u^{3/2} (3u-5) + C = \frac{1}{30} (x^4 + 1)^{3/2} (3x^4 - 2) + C \end{aligned}$$

$$50. \int \left((x^2 - 1)(x+1) \right)^{-2/3} dx$$

The easiest substitution to use is probably $u = \frac{x-1}{x+1}$, $du = \frac{2}{(1+x)^2} dx$.

The integral can be written as

$$\begin{aligned} \int \frac{1}{\left(\frac{x-1}{x+1} \right)^{2/3} (x+1)^2} dx &= \frac{1}{2} \int u^{-2/3} du \\ &= \frac{3}{2} u^{1/3} + C = \frac{3}{2} \left(\frac{x-1}{x+1} \right)^{1/3} + C \end{aligned}$$

8.2 INTEGRATION BY PARTS

$$1. \quad u = x, \quad du = dx; \quad dv = \sin \frac{x}{2} dx, \quad v = -2 \cos \frac{x}{2};$$

$$\int x \sin \frac{x}{2} dx = -2x \cos \frac{x}{2} - \int (-2 \cos \frac{x}{2}) dx = -2x \cos \left(\frac{x}{2} \right) + 4 \sin \left(\frac{x}{2} \right) + C$$

$$2. \quad u = \theta, \quad du = d\theta; \quad dv = \cos \pi\theta d\theta, \quad v = \frac{1}{\pi} \sin \pi\theta;$$

$$\int \theta \cos \pi\theta d\theta = \frac{\theta}{\pi} \sin \pi\theta - \int \frac{1}{\pi} \sin \pi\theta d\theta = \frac{\theta}{\pi} \sin \pi\theta + \frac{1}{\pi^2} \cos \pi\theta + C$$

$$3. \quad \cos t$$

$$t^2 \xrightarrow{(+)} \sin t$$

$$2t \xrightarrow{(-)} -\cos t$$

$$2 \xrightarrow{(+)} -\sin t$$

$$0 \quad \int t^2 \cos t dt = t^2 \sin t + 2t \cos t - 2 \sin t + C$$

$$\begin{array}{r}
 4. \quad \sin x \\
 x^2 \xrightarrow{(+)} -\cos x \\
 2x \xrightarrow{(-)} -\sin x \\
 2 \xrightarrow{(+)} \cos x
 \end{array}$$

$$0 \quad \int x^2 \sin x \, dx = -x^2 \cos x + 2x \sin x + 2 \cos x + C$$

$$5. \quad u = \ln x, \, du = \frac{dx}{x}; \, dv = x \, dx, \, v = \frac{x^2}{2};$$

$$\int_1^2 x \ln x \, dx = \left[\frac{x^2}{2} \ln x \right]_1^2 - \int_1^2 \frac{x^2}{2} \frac{dx}{x} = 2 \ln 2 - \left[\frac{x^2}{4} \right]_1^2 = 2 \ln 2 - \frac{3}{4} = \ln 4 - \frac{3}{4}$$

$$6. \quad u = \ln x, \, du = \frac{dx}{x}; \, dv = x^3 \, dx, \, v = \frac{x^4}{4};$$

$$\int_1^e x^3 \ln x \, dx = \left[\frac{x^4}{4} \ln x \right]_1^e - \int_1^e \frac{x^4}{4} \frac{dx}{x} = \frac{e^4}{4} - \left[\frac{x^4}{16} \right]_1^e = \frac{3e^4 + 1}{16}$$

$$7. \quad u = x, \, du = dx; \, dv = e^x \, dx, \, v = e^x;$$

$$\int x e^x \, dx = x e^x - \int e^x \, dx = x e^x - e^x + C$$

$$8. \quad u = x, \, du = dx; \, dv = e^{3x} \, dx, \, v = \frac{1}{3} e^{3x};$$

$$\int x e^{3x} \, dx = \frac{x}{3} e^{3x} - \frac{1}{3} \int e^{3x} \, dx = \frac{x}{3} e^{3x} - \frac{1}{9} e^{3x} + C$$

$$\begin{array}{r}
 9. \quad e^{-x} \\
 x^2 \xrightarrow{(+)} -e^{-x} \\
 2x \xrightarrow{(-)} e^{-x} \\
 2 \xrightarrow{(+)} -e^{-x}
 \end{array}$$

$$0 \quad \int x^2 e^{-x} \, dx = -x^2 e^{-x} - 2x e^{-x} - 2e^{-x} + C$$

$$10. \quad e^{2x}$$

$$x^2 - 2x + 1 \xrightarrow{(+)} \frac{1}{2} e^{2x}$$

$$2x - 2 \xrightarrow{(-)} \frac{1}{4} e^{2x}$$

$$2 \xrightarrow{(+)} \frac{1}{8} e^{2x}$$

$$\begin{aligned}
 0 \quad \int (x^2 - 2x + 1) e^{2x} \, dx &= \frac{1}{2} (x^2 - 2x + 1) e^{2x} - \frac{1}{4} (2x - 2) e^{2x} + \frac{1}{4} e^{2x} + C \\
 &= \left(\frac{1}{2} x^2 - \frac{3}{2} x + \frac{5}{4} \right) e^{2x} + C
 \end{aligned}$$

$$11. \quad u = \tan^{-1} y, \, du = \frac{dy}{1+y^2}; \, dv = dy, \, v = y;$$

$$\int \tan^{-1} y \, dy = y \tan^{-1} y - \int \frac{y \, dy}{(1+y^2)} = y \tan^{-1} y - \frac{1}{2} \ln(1+y^2) + C = y \tan^{-1} y - \ln \sqrt{1+y^2} + C$$

12. $u = \sin^{-1} y$, $du = \frac{dy}{\sqrt{1-y^2}}$; $dv = dy$, $v = y$;

$$\int \sin^{-1} y \, dy = y \sin^{-1} y - \int \frac{y \, dy}{\sqrt{1-y^2}} = y \sin^{-1} y + \sqrt{1-y^2} + C$$

13. $u = x$, $du = dx$; $dv = \sec^2 x \, dx$, $v = \tan x$;

$$\int x \sec^2 x \, dx = x \tan x - \int \tan x \, dx = x \tan x + \ln |\cos x| + C$$

14. $\int 4x \sec^2 2x \, dx$; $[y = 2x, dy = 2dx] \rightarrow \int y \sec^2 y \, dy = y \tan y - \int \tan y \, dy = y \tan y - \ln |\sec y| + C$
 $= 2x \tan 2x - \ln |\sec 2x| + C$

15. e^x

$$x^3 \xrightarrow{(+)} e^x$$

$$3x^2 \xrightarrow{(-)} e^x$$

$$6x \xrightarrow{(+)} e^x$$

$$6 \xrightarrow{(-)} e^x$$

$$0 \quad \int x^3 e^x \, dx = x^3 e^x - 3x^2 e^x + 6x e^x - 6e^x + C = (x^3 - 3x^2 + 6x - 6) e^x + C$$

16. e^{-p}

$$p^4 \xrightarrow{(+)} -e^{-p}$$

$$4p^3 \xrightarrow{(-)} e^{-p}$$

$$12p^2 \xrightarrow{(+)} -e^{-p}$$

$$24p \xrightarrow{(-)} e^{-p}$$

$$24 \xrightarrow{(+)} -e^{-p}$$

$$0 \quad \int p^4 e^{-p} \, dp = -p^4 e^{-p} - 4p^3 e^{-p} - 12p^2 e^{-p} - 24p e^{-p} - 24e^{-p} + C$$

$$= (-p^4 - 4p^3 - 12p^2 - 24p - 24) e^{-p} + C$$

17. e^x

$$x^2 - 5x \xrightarrow{(+)} e^x$$

$$2x - 5 \xrightarrow{(-)} e^x$$

$$2 \xrightarrow{(+)} e^x$$

$$0 \quad \int (x^2 - 5x) e^x \, dx = (x^2 - 5x) e^x - (2x - 5) e^x + 2e^x + C = x^2 e^x - 7x e^x + 7e^x + C$$

$$= (x^2 - 7x + 7) e^x + C$$

$$\begin{array}{r}
 18. \quad e^r \\
 r^2 + r + 1 \xrightarrow{(+)} e^r \\
 2r + 1 \xrightarrow{(-)} e^r \\
 2 \xrightarrow{(+)} e^r \\
 0
 \end{array}
 \int (r^2 + r + 1) e^r dr = (r^2 + r + 1) e^r - (2r + 1) e^r + 2e^r + C$$

$$= \left[(r^2 + r + 1) - (2r + 1) + 2 \right] e^r + C = (r^2 - r + 2) e^r + C$$

$$\begin{array}{r}
 19. \quad e^x \\
 x^5 \xrightarrow{(+)} e^x \\
 5x^4 \xrightarrow{(-)} e^x \\
 20x^3 \xrightarrow{(+)} e^x \\
 60x^2 \xrightarrow{(-)} e^x \\
 120x \xrightarrow{(+)} e^x \\
 120 \xrightarrow{(-)} e^x \\
 0
 \end{array}
 \int x^5 e^x dx = x^5 e^x - 5x^4 e^x + 20x^3 e^x - 60x^2 e^x + 120x e^x - 120e^x + C$$

$$= (x^5 - 5x^4 + 20x^3 - 60x^2 + 120x - 120) e^x + C$$

$$\begin{array}{r}
 20. \quad e^{4t} \\
 t^2 \xrightarrow{(+)} \frac{1}{4} e^{4t} \\
 2t \xrightarrow{(-)} \frac{1}{16} e^{4t} \\
 2 \xrightarrow{(+)} \frac{1}{64} e^{4t} \\
 0
 \end{array}
 \int t^2 e^{4t} dt = \frac{t^2}{4} e^{4t} - \frac{2t}{16} e^{4t} + \frac{2}{64} e^{4t} + C = \frac{t^2}{4} e^{4t} - \frac{t}{8} e^{4t} + \frac{1}{32} e^{4t} + C$$

$$= \left(\frac{t^2}{4} - \frac{t}{8} + \frac{1}{32} \right) e^{4t} + C$$

$$\begin{aligned}
 21. \quad I &= \int e^\theta \sin \theta d\theta; [u = \sin \theta, du = \cos \theta d\theta; dv = e^\theta d\theta, v = e^\theta] \Rightarrow I \Rightarrow e^\theta \sin \theta - \int e^\theta \cos \theta d\theta; \\
 &[u = \cos \theta, du = -\sin \theta d\theta; dv = e^\theta d\theta, v = e^\theta] \Rightarrow I = e^\theta \sin \theta - (e^\theta \cos \theta + \int e^\theta \sin \theta d\theta) \\
 &= e^\theta \sin \theta - e^\theta \cos \theta - I + C' \Rightarrow 2I = (e^\theta \sin \theta - e^\theta \cos \theta) + C' \Rightarrow I = \frac{1}{2}(e^\theta \sin \theta - e^\theta \cos \theta) + C, \text{ where } C = \frac{C'}{2} \\
 &\text{is another arbitrary constant}
 \end{aligned}$$

$$\begin{aligned}
 22. \quad I &= \int e^{-y} \cos y dy; [u = \cos y, du = -\sin y dy; dv = e^{-y} dy, v = -e^{-y}] \\
 &\Rightarrow I = -e^{-y} \cos y - \int (-e^{-y})(-\sin y) dy = -e^{-y} \cos y - \int e^{-y} \sin y dy; \\
 &[u = \sin y, du = \cos y dy; dv = e^{-y} dy, v = -e^{-y}] \Rightarrow I = -e^{-y} \cos y - \left(-e^{-y} \sin y - \int (-e^{-y}) \cos y dy \right)
 \end{aligned}$$

$$= -e^{-y} \cos y + e^{-y} \sin y - I + C' \Rightarrow 2I = e^{-y} (\sin y - \cos y) + C' \Rightarrow I = \frac{1}{2} (e^{-y} \sin y - e^{-y} \cos y) + C, \text{ where } C = \frac{C'}{2} \text{ is another arbitrary constant}$$

23. $I = \int e^{2x} \cos 3x \, dx; [u = \cos 3x; \, du = -3 \sin 3x \, dx, \, dv = e^{2x} \, dx; \, v = \frac{1}{2} e^{2x}]$
 $\Rightarrow I = \frac{1}{2} e^{2x} \cos 3x + \frac{3}{2} \int e^{2x} \sin 3x \, dx; [u = \sin 3x, \, du = 3 \cos 3x, \, dv = e^{2x} \, dx; \, v = \frac{1}{2} e^{2x}]$
 $\Rightarrow I = \frac{1}{2} e^{2x} \cos 3x + \frac{3}{2} \left(\frac{1}{2} e^{2x} \sin 3x - \frac{3}{2} \int e^{2x} \cos 3x \, dx \right) = \frac{1}{2} e^{2x} \cos 3x + \frac{3}{4} e^{2x} \sin 3x - \frac{9}{4} I + C'$
 $\Rightarrow \frac{13}{4} I = \frac{1}{2} e^{2x} \cos 3x + \frac{3}{4} e^{2x} \sin 3x + C' \Rightarrow I = \frac{e^{2x}}{13} (3 \sin 3x + 2 \cos 3x) + C, \text{ where } C = \frac{4}{13} C'$

24. $\int e^{-2x} \sin 2x \, dx; [y = 2x, \, du = 2 \, dx] \rightarrow \frac{1}{2} \int e^{-y} \sin y \, dy = I; [u = \sin y, \, du = \cos y \, dy; \, dv = e^{-y} \, dy, \, v = -e^{-y}]$
 $\Rightarrow I = \frac{1}{2} (-e^{-y} \sin y + \int e^{-y} \cos y \, dy) [u = \cos y, \, du = -\sin y; \, dv = e^{-y} \, dy, \, v = -e^{-y}]$
 $\Rightarrow I = -\frac{1}{2} e^{-y} \sin y + \frac{1}{2} (-e^{-y} \cos y - \int (-e^{-y}) (-\sin y) \, dy) = -\frac{1}{2} e^{-y} (\sin y + \cos y) - I + C'$
 $\Rightarrow 2I = -\frac{1}{2} e^{-y} (\sin y + \cos y) + C' \Rightarrow I = -\frac{1}{4} e^{-y} (\sin y + \cos y) + C = -\frac{e^{-2x}}{4} (\sin 2x + \cos 2x) + C, \text{ where } C = \frac{C'}{2}$

25. $\int e^{\sqrt{3s+9}} \, ds; \left[\begin{array}{l} 3s+9 = x^2 \\ ds = \frac{2}{3} x \, dx \end{array} \right] \rightarrow \int e^x \cdot \frac{2}{3} x \, dx = \frac{2}{3} \int x e^x \, dx; [u = x, \, du = dx; \, dv = e^x \, dx, \, v = e^x];$
 $\frac{2}{3} \int x e^x \, dx = \frac{2}{3} (x e^x - \int e^x \, dx) = \frac{2}{3} (x e^x - e^x) + C = \frac{2}{3} (\sqrt{3s+9} e^{\sqrt{3s+9}} - e^{\sqrt{3s+9}}) + C$

26. $u = x, \, du = dx; \, dv = \sqrt{1-x} \, dx, \, v = -\frac{2}{3} \sqrt{(1-x)^3};$
 $\int_0^1 x \sqrt{1-x} \, dx = \left[-\frac{2}{3} x \sqrt{(1-x)^3} \right]_0^1 + \frac{2}{3} \int_0^1 \sqrt{(1-x)^3} \, dx = 0 + \frac{2}{3} \left[-\frac{2}{5} (1-x)^{5/2} \right]_0^1 = \frac{4}{15}$

27. $u = x, \, du = dx; \, dv = \tan^2 x \, dx, \, v = \int \tan^2 x \, dx = \int \frac{\sin^2 x}{\cos^2 x} \, dx = \int \frac{1-\cos^2 x}{\cos^2 x} \, dx = \int \frac{dx}{\cos^2 x} - \int dx = \tan x - x;$
 $\int_0^{\pi/3} x \tan^2 x \, dx = [x(\tan x - x)]_0^{\pi/3} - \int_0^{\pi/3} (\tan x - x) \, dx = \frac{\pi}{3} \left(\sqrt{3} - \frac{\pi}{3} \right) + \left[\ln |\cos x| + \frac{x^2}{2} \right]_0^{\pi/3}$
 $= \frac{\pi}{3} \left(\sqrt{3} - \frac{\pi}{3} \right) + \ln \frac{1}{2} + \frac{\pi^2}{18} = \frac{\pi\sqrt{3}}{3} - \ln 2 - \frac{\pi^2}{18}$

28. $u = \ln(x+x^2), \, du = \frac{(2x+1) \, dx}{x+x^2}; \, dv = dx, \, v = x; \int \ln(x+x^2) \, dx = x \ln(x+x^2) - \int \frac{2x+1}{x(x+1)} \cdot x \, dx$
 $= x \ln(x+x^2) - \int \frac{(2x+1) \, dx}{x+1} = x \ln(x+x^2) - \int \left(2 - \frac{1}{x+1} \right) dx = x \ln(x+x^2) - 2x + \ln|x+1| + C$

29. $\int \sin(\ln x) \, dx; \left[\begin{array}{l} u = \ln x \\ du = \frac{1}{x} \, dx \\ dx = e^u \, du \end{array} \right] \rightarrow \int (\sin u) e^u \, du. \text{ From Exercise 21, } \int (\sin u) e^u \, du = e^u \left(\frac{\sin u - \cos u}{2} \right) + C$
 $= \frac{1}{2} [-x \cos(\ln x) + x \sin(\ln x)] + C$

$$30. \int z(\ln z)^2 dz; \left[\begin{array}{l} u = \ln z \\ du = \frac{1}{z} dz \\ dz = e^u du \end{array} \right] \rightarrow \int e^u \cdot u^2 \cdot e^u du = \int e^{2u} \cdot u^2 du;$$

$$u^2 \xrightarrow{(+)} \frac{1}{2} e^{2u}$$

$$2u \xrightarrow{(-)} \frac{1}{4} e^{2u}$$

$$2 \xrightarrow{(+)} \frac{1}{8} e^{2u}$$

0

$$\int u^2 e^{2u} du = \frac{u^2}{2} e^{2u} - \frac{u}{2} e^{2u} + \frac{1}{4} e^{2u} + C = \frac{e^{2u}}{4} (2u^2 - 2u + 1) + C \\ = \frac{z^2}{4} [2(\ln z)^2 - 2 \ln z + 1] + C$$

$$31. \int x \sec x^2 dx \left[\text{Let } u = x^2, du = 2x dx \Rightarrow \frac{1}{2} du = x dx \right] \rightarrow \int x \sec x^2 dx = \frac{1}{2} \int \sec u du = \frac{1}{2} \ln |\sec u + \tan u| + C \\ = \frac{1}{2} \ln |\sec x^2 + \tan x^2| + C$$

$$32. \int \frac{\cos \sqrt{x}}{\sqrt{x}} dx \left[\text{Let } u = \sqrt{x}, du = \frac{1}{2\sqrt{x}} dx \Rightarrow 2du = \frac{1}{\sqrt{x}} dx \right] \rightarrow \int \frac{\cos \sqrt{x}}{\sqrt{x}} dx = 2 \int \cos u du = 2 \sin u + C = 2 \sin \sqrt{x} + C$$

$$33. \int x(\ln x)^2 dx; \left[\begin{array}{l} u = \ln x \\ du = \frac{1}{x} dx \\ dx = e^u du \end{array} \right] \rightarrow \int e^u \cdot u^2 \cdot e^u du = \int e^{2u} \cdot u^2 du;$$

$$u^2 \xrightarrow{(+)} \frac{1}{2} e^{2u}$$

$$2u \xrightarrow{(-)} \frac{1}{4} e^{2u}$$

$$2 \xrightarrow{(+)} \frac{1}{8} e^{2u}$$

0

$$\int u^2 e^{2u} du = \frac{u^2}{2} e^{2u} - \frac{u}{2} e^{2u} + \frac{1}{4} e^{2u} + C = \frac{e^{2u}}{4} (2u^2 - 2u + 1) + C \\ = \frac{x^2}{4} [2(\ln x)^2 - 2 \ln x + 1] + C = \frac{x^2}{2} (\ln x)^2 - \frac{x^2}{2} \ln x + \frac{x^2}{4} + C$$

$$34. \int \frac{1}{x(\ln x)^2} dx \left[\text{Let } u = \ln x, du = \frac{1}{x} dx \right] \rightarrow \int \frac{1}{x(\ln x)^2} dx = \int \frac{1}{u^2} du = -\frac{1}{u} + C = -\frac{1}{\ln x} + C$$

$$35. u = \ln x, du = \frac{1}{x} dx; dv = \frac{1}{x^2} dx, v = -\frac{1}{x}; \\ \int \frac{\ln x}{x^2} dx = -\frac{\ln x}{x} + \int \frac{1}{x^2} dx = -\frac{\ln x}{x} - \frac{1}{x} + C$$

$$36. \int \frac{(\ln x)^3}{x} dx \left[\text{Let } u = \ln x, du = \frac{1}{x} dx \right] \rightarrow \int \frac{(\ln x)^3}{x} dx = \int u^3 du = \frac{1}{4} u^4 + C = \frac{1}{4} (\ln x)^4 + C$$

37. $\int x^3 e^{x^4} dx$ [Let $u = x^4$, $du = 4x^3 dx \Rightarrow \frac{1}{4} du = x^3 dx$] $\rightarrow \int x^3 e^{x^4} dx = \frac{1}{4} \int e^u du = \frac{1}{4} e^u + C = \frac{1}{4} e^{x^4} + C$
38. $u = x^3$, $du = 3x^2 dx$; $dv = x^2 e^{x^3} dx$, $v = \frac{1}{3} e^{x^3}$;
 $\int x^5 e^{x^3} dx = \int x^3 e^{x^3} x^2 dx = \frac{1}{3} x^3 e^{x^3} - \frac{1}{3} \int e^{x^3} 3x^2 dx = \frac{1}{3} x^3 e^{x^3} - \frac{1}{3} e^{x^3} + C$
39. $u = x^2$, $du = 2x dx$; $dv = \sqrt{x^2+1} x dx$, $v = \frac{1}{3} (x^2+1)^{3/2}$;
 $\int x^3 \sqrt{x^2+1} dx = \frac{1}{3} x^2 (x^2+1)^{3/2} - \frac{1}{3} \int (x^2+1)^{3/2} 2x dx = \frac{1}{3} x^2 (x^2+1)^{3/2} - \frac{2}{15} (x^2+1)^{5/2} + C$
40. $\int x^2 \sin x^3 dx$ [Let $u = x^3$, $du = 3x^2 dx \Rightarrow \frac{1}{3} du = x^2 dx$] $\rightarrow \int x^2 \sin x^3 dx = \frac{1}{3} \int \sin u du = -\frac{1}{3} \cos u + C$
 $= -\frac{1}{3} \cos x^3 + C$
41. $u = \sin 3x$, $du = 3 \cos 3x dx$; $dv = \cos 2x dx$, $v = \frac{1}{2} \sin 2x$;
 $\int \sin 3x \cos 2x dx = \frac{1}{2} \sin 3x \sin 2x - \frac{3}{2} \int \cos 3x \sin 2x dx$
 $u = \cos 3x$, $du = -3 \sin 3x dx$; $dv = \sin 2x dx$, $v = -\frac{1}{2} \cos 2x$;
 $\int \sin 3x \cos 2x dx = \frac{1}{2} \sin 3x \sin 2x - \frac{3}{2} \left[-\frac{1}{2} \cos 3x \cos 2x - \frac{3}{2} \int \sin 3x \cos 2x dx \right]$
 $= \frac{1}{2} \sin 3x \sin 2x + \frac{3}{4} \cos 3x \cos 2x + \frac{9}{4} \int \sin 3x \cos 2x dx$
 $\Rightarrow -\frac{5}{4} \int \sin 3x \cos 2x dx = \frac{1}{2} \sin 3x \sin 2x + \frac{3}{4} \cos 3x \cos 2x$
 $\Rightarrow \int \sin 3x \cos 2x dx = -\frac{2}{5} \sin 3x \sin 2x - \frac{3}{5} \cos 3x \cos 2x + C$
42. $u = \sin 2x$, $du = 2 \cos 2x dx$; $dv = \cos 4x dx$, $v = \frac{1}{4} \sin 4x$;
 $\int \sin 2x \cos 4x dx = \frac{1}{4} \sin 2x \sin 4x - \frac{1}{2} \int \cos 2x \sin 4x dx$
 $u = \cos 2x$, $du = -2 \sin 2x dx$; $dv = \sin 4x dx$, $v = -\frac{1}{4} \cos 4x$;
 $\int \sin 2x \cos 4x dx = \frac{1}{4} \sin 2x \sin 4x - \frac{1}{2} \left[-\frac{1}{4} \cos 2x \cos 4x - \frac{1}{2} \int \sin 2x \cos 4x dx \right]$
 $= \frac{1}{4} \sin 2x \sin 4x + \frac{1}{8} \cos 2x \cos 4x + \frac{1}{4} \int \sin 2x \cos 4x dx$
 $\Rightarrow \frac{3}{4} \int \sin 2x \cos 4x dx = \frac{1}{4} \sin 2x \sin 4x + \frac{1}{8} \cos 2x \cos 4x$
 $\Rightarrow \int \sin 2x \cos 4x dx = \frac{1}{3} \sin 2x \sin 4x + \frac{1}{6} \cos 2x \cos 4x + C$
43. $\int \sqrt{x} \ln x dx$ [Let $u = \ln x$, $du = \frac{1}{x} dx$, $dv = \sqrt{x} dx$, $v = \frac{2}{3} x^{3/2}$]
 $\int \sqrt{x} \ln x dx = \frac{2}{3} x^{3/2} \ln x - \frac{2}{3} \int \sqrt{x} dx$
 $= \frac{2}{3} x^{3/2} \ln x - \frac{4}{9} x^{3/2} + C = \frac{2}{9} x^{3/2} (3 \ln x - 2) + C$

$$44. \int \frac{e^{\sqrt{x}}}{\sqrt{x}} dx \left[\text{Let } u = \sqrt{x}, du = \frac{1}{2\sqrt{x}} dx \Rightarrow 2du = \frac{1}{\sqrt{x}} dx \right] \rightarrow \int \frac{e^{\sqrt{x}}}{\sqrt{x}} dx = 2 \int e^u du = 2e^u + C = 2e^{\sqrt{x}} + C$$

$$45. \int \cos \sqrt{x} dx; \left[\begin{array}{l} y = \sqrt{x} \\ dy = \frac{1}{2\sqrt{x}} dx \\ dx = 2y dy \end{array} \right] \rightarrow \int \cos y \cdot 2y dy = \int 2y \cos y dy;$$

$$u = 2y, du = 2dy; dv = \cos y dy, v = \sin y;$$

$$\int 2y \cos y dy = 2y \sin y - \int 2 \sin y dy = 2y \sin y + 2 \cos y + C = 2\sqrt{x} \sin \sqrt{x} + 2 \cos \sqrt{x} + C$$

$$46. \int \sqrt{x} e^{\sqrt{x}} dx; \left[\begin{array}{l} y = \sqrt{x} \\ dy = \frac{1}{2\sqrt{x}} dx \\ dx = 2y dy \end{array} \right] \rightarrow \int y e^y \cdot 2y dy = \int 2y^2 e^y dy;$$

$$2y^2 \xrightarrow{(+)} e^y$$

$$4y \xrightarrow{(-)} e^y$$

$$4 \xrightarrow{(+)} e^y$$

$$0 \quad \int 2y^2 e^y dy = 2y^2 e^y - 4y e^y + 4e^y + C = 2x e^{\sqrt{x}} - 4\sqrt{x} e^{\sqrt{x}} + 4e^{\sqrt{x}} + C$$

$$47. \quad \sin 2\theta$$

$$\theta^2 \xrightarrow{(+)} -\frac{1}{2} \cos 2\theta$$

$$2\theta \xrightarrow{(-)} -\frac{1}{4} \sin 2\theta$$

$$2 \xrightarrow{(+)} \frac{1}{8} \cos 2\theta$$

$$0 \quad \int_0^{\pi/2} \theta^2 \sin 2\theta d\theta = \left[-\frac{\theta^2}{2} \cos 2\theta + \frac{\theta}{2} \sin 2\theta + \frac{1}{4} \cos 2\theta \right]_0^{\pi/2}$$

$$= \left[-\frac{\pi^2}{8} \cdot (-1) + \frac{\pi}{4} \cdot 0 + \frac{1}{4} \cdot (-1) \right] - \left[0 + 0 + \frac{1}{4} \cdot 1 \right] = \frac{\pi^2}{8} - \frac{1}{2} = \frac{\pi^2 - 4}{8}$$

$$48. \quad \cos 2x$$

$$x^3 \xrightarrow{(+)} \frac{1}{2} \sin 2x$$

$$3x^2 \xrightarrow{(-)} -\frac{1}{4} \cos 2x$$

$$6x \xrightarrow{(+)} -\frac{1}{8} \sin 2x$$

$$6 \xrightarrow{(-)} \frac{1}{16} \cos 2x$$

$$0 \quad \int_0^{\pi/2} x^3 \cos 2x dx = \left[\frac{x^3}{2} \sin 2x + \frac{3x^2}{4} \cos 2x - \frac{3x}{4} \sin 2x - \frac{3}{8} \cos 2x \right]_0^{\pi/2}$$

$$= \left[\frac{\pi^3}{16} \cdot 0 + \frac{3\pi^2}{16} \cdot (-1) - \frac{3\pi}{8} \cdot 0 - \frac{3}{8} \cdot (-1) \right] - \left[0 + 0 - 0 - \frac{3}{8} \cdot 1 \right] = -\frac{3\pi^2}{16} + \frac{3}{4} = \frac{3(4 - \pi^2)}{16}$$

$$49. \quad u = \sec^{-1} t, \quad du = \frac{dt}{t\sqrt{t^2-1}}; \quad dv = t \, dt, \quad v = \frac{t^2}{2};$$

$$\begin{aligned} \int_{2/\sqrt{3}}^2 t \sec^{-1} t \, dt &= \left[\frac{t^2}{2} \sec^{-1} t \right]_{2/\sqrt{3}}^2 - \int_{2/\sqrt{3}}^2 \left(\frac{t^2}{2} \right) \frac{dt}{t\sqrt{t^2-1}} = \left(2 \cdot \frac{\pi}{3} - \frac{2}{3} \cdot \frac{\pi}{6} \right) - \int_{2/\sqrt{3}}^2 \frac{t \, dt}{2\sqrt{t^2-1}} \\ &= \frac{5\pi}{9} - \left[\frac{1}{2} \sqrt{t^2-1} \right]_{2/\sqrt{3}}^2 = \frac{5\pi}{9} - \frac{1}{2} \left(\sqrt{3} - \sqrt{\frac{4}{3}-1} \right) = \frac{5\pi}{9} - \frac{1}{2} \left(\sqrt{3} - \frac{\sqrt{3}}{3} \right) = \frac{5\pi}{9} - \frac{\sqrt{3}}{3} = \frac{5\pi-3\sqrt{3}}{9} \end{aligned}$$

$$50. \quad u = \sin^{-1}(x^2), \quad du = \frac{2x \, dx}{\sqrt{1-x^4}}; \quad dv = 2x \, dx, \quad v = x^2;$$

$$\begin{aligned} \int_0^{1/\sqrt{2}} 2x \sin^{-1}(x^2) \, dx &= \left[x^2 \sin^{-1}(x^2) \right]_0^{1/\sqrt{2}} - \int_0^{1/\sqrt{2}} x^2 \cdot \frac{2x \, dx}{\sqrt{1-x^4}} = \left(\frac{1}{2} \right) \left(\frac{\pi}{6} \right) + \frac{1}{2} \int_0^{1/\sqrt{2}} (1-x^4)^{-1/2} (4x^3) \, dx \\ &= \frac{\pi}{12} + \left[\sqrt{1-x^4} \right]_0^{1/\sqrt{2}} = \frac{\pi}{12} + \sqrt{\frac{3}{4}} - 1 = \frac{\pi+6\sqrt{3}-12}{12} \end{aligned}$$

$$51. \quad \int x \tan^{-1} x \, dx \quad \left[\text{Let } u = \tan^{-1} x, \quad du = \frac{1}{1+x^2} dx, \quad dv = x \, dx, \quad v = \frac{x^2}{2} \right]$$

$$\begin{aligned} \int x \tan^{-1} x \, dx &= \frac{1}{2} x^2 \tan^{-1} x - \frac{1}{2} \int \frac{x^2}{1+x^2} \, dx \\ &= \frac{1}{2} x^2 \tan^{-1} x - \frac{1}{2} \int \left(1 - \frac{1}{1+x^2} \right) dx \\ &= \frac{1}{2} x^2 \tan^{-1} x - \frac{1}{2} x + \frac{1}{2} \tan^{-1} x + C \\ &= \frac{1}{2} (x^2 + 1) \tan^{-1} x - \frac{x}{2} + C \end{aligned}$$

$$52. \quad \int x^2 \tan^{-1} \left(\frac{x}{2} \right) dx \quad \left[\text{Let } u = \tan^{-1} \frac{x}{2}, \quad du = \frac{1/2}{1+(x/2)^2} dx, \quad dv = x^2 dx, \quad v = \frac{x^3}{3} \right]$$

$$\begin{aligned} \int x^2 \tan^{-1} \left(\frac{x}{2} \right) dx &= \frac{x^3}{3} \tan^{-1} \frac{x}{2} - \frac{1}{3} \int \frac{\frac{1}{2} x^3}{1+\frac{x^2}{4}} dx \\ &= \frac{x^3}{3} \tan^{-1} \frac{x}{2} - \frac{1}{3} \int \left(2x - \frac{2x}{1+\frac{x^2}{4}} \right) dx \\ &= \frac{x^3}{3} \tan^{-1} \frac{x}{2} - \frac{1}{3} x^2 + \frac{1}{3} \int \left(\frac{2x}{1+\frac{x^2}{4}} \right) dx \end{aligned}$$

In the remaining integral, let $w = 1 + \frac{x^2}{4}$, $dw = \frac{x}{2} dx$.

$$\frac{1}{3} \int \left(\frac{2x}{1 + \frac{x^2}{4}} \right) dx = \frac{1}{3} \int \frac{4}{w} dw = \frac{4}{3} \ln|w| = \frac{4}{3} \ln \left(1 + \frac{x^2}{4} \right)$$

Thus the original integral is equal to

$$\frac{x^3}{3} \tan^{-1} \frac{x}{2} - \frac{1}{3} x^2 + \frac{4}{3} \ln \left(1 + \frac{x^2}{4} \right) + C$$

53. (a) $u = x, du = dx; dv = \sin x dx, v = -\cos x;$

$$S_1 = \int_0^\pi x \sin x dx = [-x \cos x]_0^\pi + \int_0^\pi \cos x dx = \pi + [\sin x]_0^\pi = \pi$$

(b) $S_2 = -\int_0^{2\pi} x \sin x dx = -\left[-x \cos x \Big|_0^{2\pi} + \int_0^{2\pi} \cos x dx \right] = -\left[-3\pi + [\sin x]_0^{2\pi} \right] = 3\pi$

(c) $S_3 = \int_{2\pi}^{3\pi} x \sin x dx = [-x \cos x]_{2\pi}^{3\pi} + \int_{2\pi}^{3\pi} \cos x dx = 5\pi + [\sin x]_{2\pi}^{3\pi} = 5\pi$

(d) $S_{n+1} = (-1)^{n+1} \int_{n\pi}^{(n+1)\pi} x \sin x dx = (-1)^{n+1} \left[-x \cos x \Big|_{n\pi}^{(n+1)\pi} + [\sin x]_{n\pi}^{(n+1)\pi} \right]$
 $= (-1)^{n+1} \left[-(n+1)\pi(-1)^n + n\pi(-1)^{n+1} \right] + 0 = (2n+1)\pi$

54. (a) $u = x, du = dx; dv = \cos x dx, v = \sin x;$

$$S_1 = -\int_{\pi/2}^{3\pi/2} x \cos x dx = -\left[x \sin x \Big|_{\pi/2}^{3\pi/2} - \int_{\pi/2}^{3\pi/2} \sin x dx \right] = -\left(-\frac{3\pi}{2} - \frac{\pi}{2} \right) - [\cos x]_{\pi/2}^{3\pi/2} = 2\pi$$

(b) $S_2 = \int_{3\pi/2}^{5\pi/2} x \cos x dx = \left[x \sin x \Big|_{3\pi/2}^{5\pi/2} - \int_{3\pi/2}^{5\pi/2} \sin x dx \right] = \left[\frac{5\pi}{2} - \left(-\frac{3\pi}{2} \right) \right] - [\cos x]_{3\pi/2}^{5\pi/2} = 4\pi$

(c) $S_3 = -\int_{5\pi/2}^{7\pi/2} x \cos x dx = -\left[x \sin x \Big|_{5\pi/2}^{7\pi/2} - \int_{5\pi/2}^{7\pi/2} \sin x dx \right] = -\left(-\frac{7\pi}{2} - \frac{5\pi}{2} \right) - [\cos x]_{5\pi/2}^{7\pi/2} = 6\pi$

(d) $S_n = (-1)^n \int_{(2n-1)\pi/2}^{(2n+1)\pi/2} x \cos x dx = (-1)^n \left[x \sin x \Big|_{(2n-1)\pi/2}^{(2n+1)\pi/2} - \int_{(2n-1)\pi/2}^{(2n+1)\pi/2} \sin x dx \right]$
 $= (-1)^n \left[\frac{(2n+1)\pi}{2} (-1)^n - \frac{(2n-1)\pi}{2} (-1)^{n-1} \right] - [\cos x]_{(2n-1)\pi/2}^{(2n+1)\pi/2} = \frac{1}{2} (2n\pi + \pi + 2n\pi - \pi) = 2n\pi$

55. $V = \int_0^{\ln 2} 2\pi (\ln 2 - x) e^x dx$

$$= 2\pi \ln 2 \int_0^{\ln 2} e^x dx - 2\pi \int_0^{\ln 2} x e^x dx$$

$$= (2\pi \ln 2) \left[e^x \Big|_0^{\ln 2} \right] - 2\pi \left(\left[x e^x \right]_0^{\ln 2} - \int_0^{\ln 2} e^x dx \right)$$

$$= 2\pi \ln 2 - 2\pi \left(2 \ln 2 - \left[e^x \right]_0^{\ln 2} \right) = -2\pi \ln 2 + 2\pi$$

$$= 2\pi(1 - \ln 2)$$

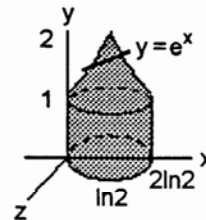

56. (a) $V = \int_0^1 2\pi x e^{-x} dx = 2\pi \left(\left[-x e^{-x} \right]_0^1 + \int_0^1 e^{-x} dx \right)$
 $= 2\pi \left(-\frac{1}{e} + \left[-e^{-x} \right]_0^1 \right) = 2\pi \left(-\frac{1}{e} - \frac{1}{e} + 1 \right) = 2\pi - \frac{4\pi}{e}$

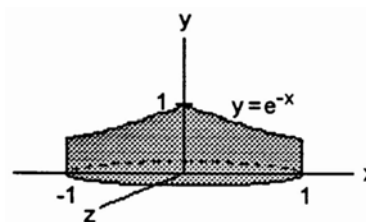

(b) $V = \int_0^1 2\pi(1-x)e^{-x} dx;$
 $u = 1-x, du = -dx; dv = e^{-x} dx, v = -e^{-x};$
 $V = 2\pi \left[\left[(1-x)(-e^{-x}) \right]_0^1 - \int_0^1 e^{-x} dx \right]$
 $= 2\pi \left[\left[0 - 1(-1) \right] + \left[e^{-x} \right]_0^1 \right] = 2\pi \left(1 + \frac{1}{e} - 1 \right) = \frac{2\pi}{e}$

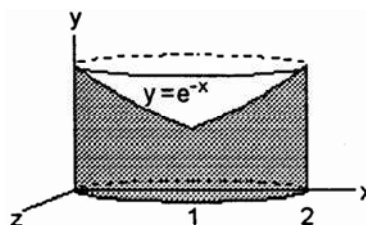

57. (a) $V = \int_0^{\pi/2} 2\pi x \cos x dx = 2\pi \left(\left[x \sin x \right]_0^{\pi/2} - \int_0^{\pi/2} \sin x dx \right)$
 $= 2\pi \left(\frac{\pi}{2} + \left[\cos x \right]_0^{\pi/2} \right) = 2\pi \left(\frac{\pi}{2} + 0 - 1 \right) = \pi(\pi - 2)$

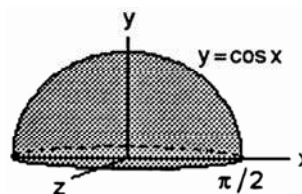

(b) $V = \int_0^{\pi/2} 2\pi \left(\frac{\pi}{2} - x \right) \cos x dx; u = \frac{\pi}{2} - x, du = -dx; dv = \cos x dx, v = \sin x;$
 $V = 2\pi \left[\left(\frac{\pi}{2} - x \right) \sin x \right]_0^{\pi/2} + 2\pi \int_0^{\pi/2} \sin x dx = 0 + 2\pi \left[-\cos x \right]_0^{\pi/2} = 2\pi(0 + 1) = 2\pi$

58. (a) $V = \int_0^{\pi} 2\pi x(x \sin x) dx;$
 $\begin{array}{r} \sin x \\ x^2 \xrightarrow{(+)} -\cos x \\ 2x \xrightarrow{(-)} -\sin x \\ 2 \xrightarrow{(+)} \cos x \\ 0 \end{array} \Rightarrow V = 2\pi \int_0^{\pi} x^2 \sin x dx = 2\pi \left[-x^2 \cos x + 2x \sin x + 2 \cos x \right]_0^{\pi} = 2\pi(\pi^2 - 4)$

(b) $V = \int_0^{\pi} 2\pi(\pi - x)x \sin x dx = 2\pi^2 \int_0^{\pi} x \sin x dx - 2\pi \int_0^{\pi} x^2 \sin x dx = 2\pi^2 \left[-x \cos x + \sin x \right]_0^{\pi} - (2\pi^3 - 8\pi)$
 $= 8\pi$

59. (a) $A = \int_1^e \ln x dx = \left[x \ln x \right]_1^e - \int_1^e dx$
 $= (e \ln e - 1 \ln 1) - \left[x \right]_1^e = e - (e - 1) = 1$

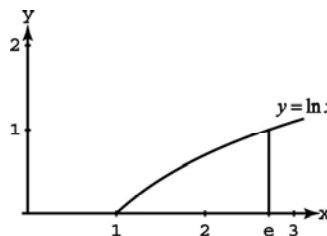

(b) $V = \int_1^e \pi(\ln x)^2 dx = \pi \left(\left[x(\ln x)^2 \right]_1^e - \int_1^e 2 \ln x dx \right)$
 $= \pi \left[\left(e(\ln e)^2 - 1(\ln 1)^2 \right) - \left(\left[2x \ln x \right]_1^e - \int_1^e 2 dx \right) \right]$
 $= \pi \left[e - \left((2e \ln e - 2(1) \ln 1) - \left[2x \right]_1^e \right) \right] = \pi \left[e - (2e - (2e - 2)) \right] = \pi(e - 2)$

$$(c) \quad V = \int_1^e 2\pi(x+2) \ln x \, dx = 2\pi \int_1^e (x+2) \ln x \, dx = 2\pi \left(\left[\left(\frac{1}{2}x^2 + 2x \right) \ln x \right]_1^e - \int_1^e \left(\frac{1}{2}x + 2 \right) dx \right)$$

$$= 2\pi \left(\left(\frac{1}{2}e^2 + 2e \right) \ln e - \left(\frac{1}{2} + 2 \right) \ln 1 - \left[\left(\frac{1}{4}x^2 + 2x \right) \right]_1^e \right) = 2\pi \left(\left(\frac{1}{2}e^2 + 2e \right) - \left(\left(\frac{1}{4}e^2 + 2e \right) - \frac{9}{4} \right) \right) = \frac{\pi}{2}(e^2 + 9)$$

$$(d) \quad M = \int_1^e \ln x \, dx = 1 \text{ (from part (a))}; \quad \bar{x} = \frac{1}{1} \int_1^e x \ln x \, dx = \left[\frac{1}{2}x^2 \ln x \right]_1^e - \int_1^e \frac{1}{2}x \, dx$$

$$= \left(\frac{1}{2}e^2 \ln e - \frac{1}{2}(1)^2 \ln 1 \right) - \left[\frac{1}{4}x^2 \right]_1^e = \frac{1}{2}e^2 - \left(\frac{1}{4}e^2 - \frac{1}{4}(1)^2 \right) = \frac{1}{4}(e^2 + 1);$$

$$\bar{y} = \frac{1}{1} \int_1^e \frac{1}{2}(\ln x)^2 \, dx = \frac{1}{2} \left(\left[x(\ln x)^2 \right]_1^e - \int_1^e 2 \ln x \, dx \right) = \frac{1}{2} \left(\left(e(\ln e)^2 - 1 \cdot (\ln 1)^2 \right) - \left([2x \ln x]_1^e - \int_1^e 2 \, dx \right) \right)$$

$$= \frac{1}{2} \left(e - \left(2e \ln e - 2(1) \ln 1 - [2x]_1^e \right) \right) = \frac{1}{2}(e - 2e + 2e - 2) = \frac{1}{2}(e - 2) \Rightarrow (\bar{x}, \bar{y}) = \left(\frac{e^2+1}{4}, \frac{e-2}{2} \right) \text{ is the centroid.}$$

$$60. (a) \quad A = \int_0^1 \tan^{-1} x \, dx = \left[x \tan^{-1} x \right]_0^1 - \int_0^1 \frac{x}{1+x^2} \, dx$$

$$= \left(\tan^{-1} 1 - 0 \right) - \frac{1}{2} \left[\ln(1+x^2) \right]_0^1$$

$$= \frac{\pi}{4} - \frac{1}{2}(\ln 2 - \ln 1) = \frac{\pi}{4} - \frac{1}{2} \ln 2$$

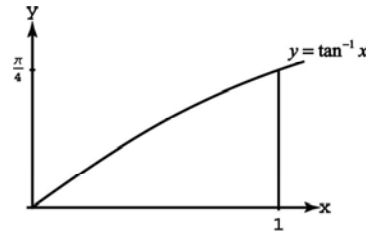

$$(b) \quad V = \int_0^1 2\pi x \tan^{-1} x \, dx = 2\pi \left(\left[\frac{x^2}{2} \tan^{-1} x \right]_0^1 - \frac{1}{2} \int_0^1 \frac{x^2}{1+x^2} \, dx \right) = 2\pi \left(\frac{1}{2} \tan^{-1} 1 - 0 - \frac{1}{2} \int_0^1 \left(1 - \frac{1}{1+x^2} \right) dx \right)$$

$$= 2\pi \left(\frac{\pi}{8} - \frac{1}{2} \left[x - \tan^{-1} x \right]_0^1 \right) = 2\pi \left(\frac{\pi}{8} - \frac{1}{2} (1 - \tan^{-1} 1 - (0 - 0)) \right) = 2\pi \left(\frac{\pi}{8} - \frac{1}{2} \left(1 - \frac{\pi}{4} \right) \right) = \frac{\pi(\pi-2)}{2}$$

$$61. \quad av(y) = \frac{1}{2\pi} \int_0^{2\pi} 2e^{-t} \cos t \, dt = \frac{1}{\pi} \left[e^{-t} \left(\frac{\sin t - \cos t}{2} \right) \right]_0^{2\pi}$$

(see Exercise 22) $\Rightarrow av(y) = \frac{1}{2\pi}(1 - e^{-2\pi})$

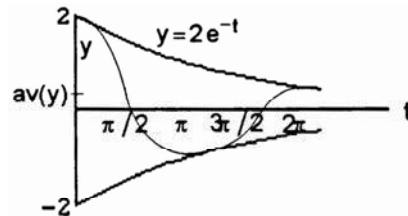

$$62. \quad av(y) = \frac{1}{2\pi} \int_0^{2\pi} 4e^{-t} (\sin t - \cos t) \, dt$$

$$= \frac{2}{\pi} \int_0^{2\pi} e^{-t} \sin t \, dt - \frac{2}{\pi} \int_0^{2\pi} e^{-t} \cos t \, dt$$

$$= \frac{2}{\pi} \left[e^{-t} \left(\frac{-\sin t - \cos t}{2} \right) - e^{-t} \left(\frac{\sin t - \cos t}{2} \right) \right]_0^{2\pi}$$

$$= \frac{2}{\pi} \left[-e^{-t} \sin t \right]_0^{2\pi} = 0$$

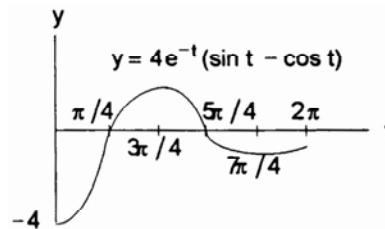

$$63. \quad I = \int x^n \cos x \, dx; [u = x^n, du = nx^{n-1} \, dx; dv = \cos x \, dx, v = \sin x]$$

$$\Rightarrow I = x^n \sin x - \int nx^{n-1} \sin x \, dx$$

$$64. \quad I = \int x^n \sin x \, dx; [u = x^n, du = nx^{n-1} \, dx; dv = \sin x \, dx, v = -\cos x]$$

$$\Rightarrow I = -x^n \cos x + \int nx^{n-1} \cos x \, dx$$

$$65. \quad I = \int x^n e^{ax} \, dx; [u = x^n, du = nx^{n-1} \, dx; dv = e^{ax} \, dx, v = \frac{1}{a} e^{ax}]$$

$$\Rightarrow I = \frac{x^n e^{ax}}{a} - \frac{n}{a} \int x^{n-1} e^{ax} \, dx, a \neq 0$$

$$66. \quad I = \int (\ln x)^n \, dx; [u = (\ln x)^n, du = \frac{n(\ln x)^{n-1}}{x} \, dx; dv = 1 \, dx, v = x]$$

$$\Rightarrow I = x(\ln x)^n - \int n(\ln x)^{n-1} \, dx$$

$$67. \quad u = (\ln x)^n, du = \frac{n}{x} (\ln x)^{n-1} \, dx, dv = x^m \, dx, v = \frac{x^{m+1}}{m+1}$$

$$uv = \frac{1}{m+1} x^{m+1} (\ln x)^{n-1} \quad \text{and} \quad \int v \, du = \frac{n}{m+1} \int x^m (\ln x)^{n-1} \, dx$$

68. First to show that $\int_0^{\pi/2} \cos^n x \, dx = \int_0^{\pi/2} \sin^n x \, dx$ note that $\cos x$ over the interval $[0, \pi/2]$ is the reflection of $\sin x$ over the same interval around the line $x = \pi/4$.

Each iteration of the reduction formula in Example 5 for the definite integral produces an expression like

$$\left. \frac{(\cos^{n-1} x)(\sin x)}{n} \right|_0^{\pi/2} + \frac{n-1}{n} \int_0^{\pi/2} \cos^{n-2} x \, dx$$

The evaluation on the left will be 0 as long as $n \geq 2$, and factors of the form $\frac{n}{n-1}$ accumulate in front of the integral on the right. When the initial n is even, the last iteration will have $n = 2$ and the remaining integral will be $\frac{n-1}{n} \cdot \frac{n-3}{n-2} \cdots \frac{1}{2} \int_0^{\pi/2} 1 \, dx = \frac{\pi}{2} \cdot \frac{1 \cdot 3 \cdots (n-1)}{2 \cdot 4 \cdots n}$. When the initial n is odd the last iteration will have

$n = 3$ and the remaining integral will be $\frac{n-1}{n} \cdot \frac{n-3}{n-2} \cdots \frac{2}{3} \int_0^{\pi/2} \cos x \, dx = 1 \cdot \frac{2 \cdot 4 \cdots (n-1)}{3 \cdots n}$.

$$69. \quad \int_a^b (x-a) f(x) \, dx; \left[u = x-a, du = dx; dv = f(x) \, dx, v = \int_b^x f(t) \, dt = -\int_x^b f(t) \, dt \right]$$

$$= \left[(x-a) \int_b^x f(t) \, dt \right]_a^b - \int_a^b \left(\int_b^x f(t) \, dt \right) dx = \left((b-a) \int_b^b f(t) \, dt - (a-a) \int_b^a f(t) \, dt \right) - \int_a^b \left(-\int_x^b f(t) \, dt \right) dx$$

$$= 0 + \int_a^b \left(\int_x^b f(t) \, dt \right) dx = \int_a^b \left(\int_x^b f(t) \, dt \right) dx$$

$$70. \quad \int \sqrt{1-x^2} \, dx; \left[u = \sqrt{1-x^2}, du = \frac{-x}{\sqrt{1-x^2}} \, dx; dv = dx, v = x \right]$$

$$= x\sqrt{1-x^2} - \int \frac{-x^2}{\sqrt{1-x^2}} \, dx = x\sqrt{1-x^2} - \int \frac{1-x^2-1}{\sqrt{1-x^2}} \, dx = x\sqrt{1-x^2} - \left(\int \frac{1-x^2}{\sqrt{1-x^2}} \, dx - \int \frac{1}{\sqrt{1-x^2}} \, dx \right)$$

$$= x\sqrt{1-x^2} - \int \sqrt{1-x^2} \, dx + \int \frac{1}{\sqrt{1-x^2}} \, dx$$

$$\begin{aligned} \Rightarrow \int \sqrt{1-x^2} dx &= x\sqrt{1-x^2} + \int \frac{1}{\sqrt{1-x^2}} dx - \int \sqrt{1-x^2} dx \Rightarrow 2 \int \sqrt{1-x^2} dx = x\sqrt{1-x^2} + \int \frac{1}{\sqrt{1-x^2}} dx \\ \Rightarrow \int \sqrt{1-x^2} dx &= \frac{x}{2}\sqrt{1-x^2} + \frac{1}{2} \int \frac{1}{\sqrt{1-x^2}} dx + C \end{aligned}$$

$$71. \int \sin^{-1} x dx = x \sin^{-1} x - \int \sin y dy = x \sin^{-1} x + \cos y + C = x \sin^{-1} x + \cos(\sin^{-1} x) + C$$

$$72. \int \tan^{-1} x dx = x \tan^{-1} x - \int \tan y dy = x \tan^{-1} x + \ln |\cos y| + C = x \tan^{-1} x + \ln |\cos(\tan^{-1} x)| + C$$

$$\begin{aligned} 73. \int \sec^{-1} x dx &= x \sec^{-1} x - \int \sec y dy = x \sec^{-1} x - \ln |\sec y + \tan y| + C \\ &= x \sec^{-1} x - \ln |\sec(\sec^{-1} x) + \tan(\sec^{-1} x)| + C = x \sec^{-1} x - \ln |x + \sqrt{x^2 - 1}| + C \end{aligned}$$

$$74. \int \log_2 x dx = x \log_2 x - \int 2^y dy = x \log_2 x - \frac{2^y}{\ln 2} + C = x \log_2 x - \frac{x}{\ln 2} + C$$

$$75. \text{Yes, } \cos^{-1} x \text{ is the angle whose cosine is } x \text{ which implies } \sin(\cos^{-1} x) = \sqrt{1-x^2}.$$

$$76. \text{Yes, } \tan^{-1} x \text{ is the angle whose tangent is } x \text{ which implies } \sec(\tan^{-1} x) = \sqrt{1+x^2}.$$

$$77. (a) \int \sinh^{-1} x dx = x \sinh^{-1} x - \int \sinh y dy = x \sinh^{-1} x - \cosh y + C = x \sinh^{-1} x - \cosh(\sinh^{-1} x) + C;$$

$$\text{check: } d \left[x \sinh^{-1} x - \cosh(\sinh^{-1} x) + C \right] = \left[\sinh^{-1} x + \frac{x}{\sqrt{1+x^2}} - \sinh(\sinh^{-1} x) \frac{1}{\sqrt{1+x^2}} \right] dx = \sinh^{-1} x dx$$

$$(b) \int \sinh^{-1} x dx = x \sinh^{-1} x - \int x \left(\frac{1}{\sqrt{1+x^2}} \right) dx = x \sinh^{-1} x - \frac{1}{2} \int (1+x^2)^{-1/2} 2x dx = x \sinh^{-1} x - (1+x^2)^{1/2} + C$$

$$\text{check: } d \left[x \sinh^{-1} x - (1+x^2)^{1/2} + C \right] = \left[\sinh^{-1} x + \frac{x}{\sqrt{1+x^2}} - \frac{x}{\sqrt{1+x^2}} \right] dx = \sinh^{-1} x dx$$

$$78. (a) \int \tanh^{-1} x dx = x \tanh^{-1} x - \int \tanh y dy = x \tanh^{-1} x - \ln |\cosh y| + C$$

$$= x \tanh^{-1} x - \ln |\cosh(\tanh^{-1} x)| + C;$$

$$\text{check: } d \left[x \tanh^{-1} x - \ln |\cosh(\tanh^{-1} x)| + C \right] = \left[\tanh^{-1} x + \frac{x}{1-x^2} - \frac{\sinh(\tanh^{-1} x)}{\cosh(\tanh^{-1} x)} \frac{1}{1-x^2} \right] dx$$

$$= \left[\tanh^{-1} x + \frac{x}{1-x^2} - \frac{x}{1-x^2} \right] dx = \tanh^{-1} x dx$$

$$(b) \int \tanh^{-1} x dx = x \tanh^{-1} x - \int \frac{x}{1-x^2} dx = x \tanh^{-1} x - \frac{1}{2} \int \frac{2x}{1-x^2} dx = x \tanh^{-1} x + \frac{1}{2} \ln |1-x^2| + C$$

$$\text{check: } d \left[x \tanh^{-1} x + \frac{1}{2} \ln |1-x^2| + C \right] = \left[\tanh^{-1} x + \frac{x}{1-x^2} - \frac{x}{1-x^2} \right] dx = \tanh^{-1} x dx$$

8.3 TRIGONOMETRIC INTEGRALS

1. $\int \cos 2x \, dx = \frac{1}{2} \int \cos 2x \cdot 2 \, dx = \frac{1}{2} \sin 2x + C$
2. $\int_0^{\pi} 3 \sin \frac{x}{3} \, dx = 9 \int_0^{\pi} \sin \frac{x}{3} \cdot \frac{1}{3} \, dx = 9 \left[-\cos \frac{x}{3} \right]_0^{\pi} = 9 \left(-\cos \frac{\pi}{3} + \cos 0 \right) = 9 \left(-\frac{1}{2} + 1 \right) = \frac{9}{2}$
3. $\int \cos^3 x \sin x \, dx = -\int \cos^3 x (-\sin x) \, dx = -\frac{1}{4} \cos^4 x + C$
4. $\int \sin^4 2x \cos 2x \, dx = \frac{1}{2} \int \sin^4 2x \cos 2x \cdot 2 \, dx = \frac{1}{10} \sin^5 2x + C$
5. $\int \sin^3 x \, dx = \int \sin^2 x \sin x \, dx = \int (1 - \cos^2 x) \sin x \, dx = \int \sin x \, dx - \int \cos^2 x \sin x \, dx = -\cos x + \frac{1}{3} \cos^3 x + C$
6. $\int \cos^3 4x \, dx = \int \cos^2 4x \cos 4x \, dx = \frac{1}{4} \int (1 - \sin^2 4x) \cos 4x \cdot 4 \, dx = \frac{1}{4} \int \cos 4x \cdot 4 \, dx - \frac{1}{4} \int \sin^2 4x \cos 4x \cdot 4 \, dx$
 $= \frac{1}{4} \sin 4x - \frac{1}{12} \sin^3 4x + C$
7. $\int \sin^5 x \, dx = \int (\sin^2 x)^2 \sin x \, dx = \int (1 - \cos^2 x)^2 \sin x \, dx = \int (1 - 2\cos^2 x + \cos^4 x) \sin x \, dx$
 $= \int \sin x \, dx - \int 2\cos^2 x \sin x \, dx + \int \cos^4 x \sin x \, dx = -\cos x + \frac{2}{3} \cos^3 x - \frac{1}{5} \cos^5 x + C$
8. $\int_0^{\pi} \sin^5 \left(\frac{x}{2} \right) \, dx$ (using Exercise 7) $= \int_0^{\pi} \sin \left(\frac{x}{2} \right) \, dx - \int_0^{\pi} 2 \cos^2 \left(\frac{x}{2} \right) \sin \left(\frac{x}{2} \right) \, dx + \int_0^{\pi} \cos^4 \left(\frac{x}{2} \right) \sin \left(\frac{x}{2} \right) \, dx$
 $= \left[-2 \cos \left(\frac{x}{2} \right) + \frac{4}{3} \cos^3 \left(\frac{x}{2} \right) - \frac{2}{5} \cos^5 \left(\frac{x}{2} \right) \right]_0^{\pi} = (0) - \left(-2 + \frac{4}{3} - \frac{2}{5} \right) = \frac{16}{15}$
9. $\int \cos^3 x \, dx = \int (\cos^2 x) \cos x \, dx = \int (1 - \sin^2 x) \cos x \, dx = \int \cos x \, dx - \int \sin^2 x \cos x \, dx = \sin x - \frac{1}{3} \sin^3 x + C$
10. $\int_0^{\pi/6} 3 \cos^5 3x \, dx = \int_0^{\pi/6} (\cos^2 3x)^2 \cos 3x \cdot 3 \, dx = \int_0^{\pi/6} (1 - \sin^2 3x)^2 \cos 3x \cdot 3 \, dx$
 $= \int_0^{\pi/6} (1 - 2\sin^2 3x + \sin^4 3x) \cos 3x \cdot 3 \, dx$
 $= \int_0^{\pi/6} \cos 3x \cdot 3 \, dx - 2 \int_0^{\pi/6} \sin^2 3x \cos 3x \cdot 3 \, dx + \int_0^{\pi/6} \sin^4 3x \cos 3x \cdot 3 \, dx = \left[\sin 3x - 2 \frac{\sin^3 3x}{3} + \frac{\sin^5 3x}{5} \right]_0^{\pi/6}$
 $= \left(1 - \frac{2}{3} + \frac{1}{5} \right) - (0) = \frac{8}{15}$
11. $\int \sin^3 x \cos^3 x \, dx = \int \sin^3 x \cos^2 x \cos x \, dx = \int \sin^3 x (1 - \sin^2 x) \cos x \, dx = \int \sin^3 x \cos x \, dx - \int \sin^5 x \cos x \, dx$
 $= \frac{1}{4} \sin^4 x - \frac{1}{6} \sin^6 x + C$

$$\begin{aligned}
20. \int_0^\pi 8 \sin^4 y \cos^2 y \, dy &= 8 \int_0^\pi \left(\frac{1-\cos 2y}{2}\right)^2 \left(\frac{1+\cos 2y}{2}\right) dy = \int_0^\pi dy - \int_0^\pi \cos 2y \, dy - \int_0^\pi \cos^2 2y \, dy + \int_0^\pi \cos^3 2y \, dy \\
&= \left[y - \frac{1}{2} \sin 2y \right]_0^\pi - \int_0^\pi \left(\frac{1+\cos 4y}{2}\right) dy + \int_0^\pi (1-\sin^2 2y) \cos 2y \, dy \\
&= \pi - \frac{1}{2} \int_0^\pi dy - \frac{1}{2} \int_0^\pi \cos 4y \, dy + \int_0^\pi \cos 2y \, dy - \int_0^\pi \sin^2 2y \cos 2y \, dy \\
&= \pi + \left[-\frac{1}{2} y - \frac{1}{8} \sin 4y + \frac{1}{2} \sin 2y - \frac{1}{2} \cdot \frac{\sin^3 2y}{3} \right]_0^\pi = \pi - \frac{\pi}{2} = \frac{\pi}{2}
\end{aligned}$$

$$21. \int 8 \cos^3 2\theta \sin 2\theta \, d\theta = 8 \left(-\frac{1}{2}\right) \frac{\cos^4 2\theta}{4} + C = -\cos^4 2\theta + C$$

$$\begin{aligned}
22. \int_0^{\pi/2} \sin^2 2\theta \cos^3 2\theta \, d\theta &= \int_0^{\pi/2} \sin^2 2\theta (1-\sin^2 2\theta) \cos 2\theta \, d\theta \\
&= \int_0^{\pi/2} \sin^2 2\theta \cos 2\theta \, d\theta - \int_0^{\pi/2} \sin^4 2\theta \cos 2\theta \, d\theta = \left[\frac{1}{2} \cdot \frac{\sin^3 2\theta}{3} - \frac{1}{2} \cdot \frac{\sin^5 2\theta}{5} \right]_0^{\pi/2} = 0
\end{aligned}$$

$$23. \int_0^{2\pi} \sqrt{\frac{1-\cos x}{2}} \, dx = \int_0^{2\pi} \left| \sin \frac{x}{2} \right| dx = \int_0^{2\pi} \sin \frac{x}{2} \, dx = \left[-2 \cos \frac{x}{2} \right]_0^{2\pi} = 2 + 2 = 4$$

$$24. \int_0^\pi \sqrt{1-\cos 2x} \, dx = \int_0^\pi \sqrt{2} |\sin x| \, dx = \int_0^\pi \sqrt{2} \sin x \, dx = \left[-\sqrt{2} \cos x \right]_0^\pi = \sqrt{2} + \sqrt{2} = 2\sqrt{2}$$

$$25. \int_0^\pi \sqrt{1-\sin^2 t} \, dt = \int_0^\pi |\cos t| \, dt = \int_0^{\pi/2} \cos t \, dt - \int_{\pi/2}^\pi \cos t \, dt = [\sin t]_0^{\pi/2} - [\sin t]_{\pi/2}^\pi = 1 - 0 - 0 + 1 = 2$$

$$26. \int_0^\pi \sqrt{1-\cos^2 \theta} \, d\theta = \int_0^\pi |\sin \theta| \, d\theta = \int_0^\pi \sin \theta \, d\theta = [-\cos \theta]_0^\pi = 1 + 1 = 2$$

$$\begin{aligned}
27. \int_{\pi/3}^{\pi/2} \frac{\sin^2 x}{\sqrt{1-\cos x}} \, dx &= \int_{\pi/3}^{\pi/2} \frac{\sin^2 x}{\sqrt{1-\cos x}} \frac{\sqrt{1+\cos x}}{\sqrt{1+\cos x}} \, dx = \int_{\pi/3}^{\pi/2} \frac{\sin^2 x \sqrt{1+\cos x}}{\sqrt{1-\cos^2 x}} \, dx = \int_{\pi/3}^{\pi/2} \frac{\sin^2 x \sqrt{1+\cos x}}{\sqrt{\sin^2 x}} \, dx \\
&= \int_{\pi/3}^{\pi/2} \sin x \sqrt{1+\cos x} \, dx = \left[-\frac{2}{3} (1+\cos x)^{3/2} \right]_{\pi/3}^{\pi/2} = -\frac{2}{3} \left(1+\cos\left(\frac{\pi}{2}\right)\right)^{3/2} + \frac{2}{3} \left(1+\cos\left(\frac{\pi}{3}\right)\right)^{3/2} = -\frac{2}{3} + \frac{2}{3} \left(\frac{3}{2}\right)^{3/2} \\
&= \sqrt{\frac{3}{2}} - \frac{2}{3}
\end{aligned}$$

$$\begin{aligned}
28. \int_0^{\pi/6} \sqrt{1+\sin x} \, dx &= \int_0^{\pi/6} \frac{\sqrt{1+\sin x}}{1} \frac{\sqrt{1-\sin x}}{\sqrt{1-\sin x}} \, dx = \int_0^{\pi/6} \frac{\sqrt{1-\sin^2 x}}{\sqrt{1-\sin x}} \, dx = \int_0^{\pi/6} \frac{\sqrt{\cos^2 x}}{\sqrt{1-\sin x}} \, dx = \int_0^{\pi/6} \frac{\cos x}{\sqrt{1-\sin x}} \, dx \\
&= \left[-2(1-\sin x)^{1/2} \right]_0^{\pi/6} = -2\sqrt{1-\sin\left(\frac{\pi}{6}\right)} + 2\sqrt{1-\sin 0} = -2\sqrt{\frac{1}{2}} + 2\sqrt{1} = 2 - \sqrt{2}
\end{aligned}$$

$$\begin{aligned}
29. \int_{5\pi/6}^\pi \frac{\cos^4 x}{\sqrt{1-\sin x}} \, dx &= \int_{5\pi/6}^\pi \frac{\cos^4 x}{\sqrt{1-\sin x}} \frac{\sqrt{1+\sin x}}{\sqrt{1+\sin x}} \, dx = \int_{5\pi/6}^\pi \frac{\cos^4 x \sqrt{1+\sin x}}{\sqrt{1-\sin^2 x}} \, dx = \int_{5\pi/6}^\pi \frac{\cos^4 x \sqrt{1+\sin x}}{\sqrt{\cos^2 x}} \, dx \\
&= \int_{5\pi/6}^\pi \frac{\cos^4 x \sqrt{1+\sin x}}{-\cos x} \, dx = -\int_{5\pi/6}^\pi \cos^3 x \sqrt{1+\sin x} \, dx = -\int_{5\pi/6}^\pi \cos x (1-\sin^2 x) \sqrt{1+\sin x} \, dx \\
&= -\int_{5\pi/6}^\pi \cos x \sqrt{1+\sin x} \, dx + \int_{5\pi/6}^\pi \cos x \sin^2 x \sqrt{1+\sin x} \, dx;
\end{aligned}$$

- $$\begin{aligned} & \left[\text{Let } u = 1 + \sin x \Rightarrow u - 1 = \sin x \Rightarrow du = \cos x \, dx, x = \frac{5\pi}{6} \Rightarrow u = 1 + \sin\left(\frac{5\pi}{6}\right) = \frac{3}{2}, x = \pi \Rightarrow u = 1 + \sin \pi = 1 \right] \\ & = \left[-\frac{2}{3}(1 + \sin x)^{3/2} \right]_{5\pi/6}^{\pi} + \int_{3/2}^1 (u-1)^2 \sqrt{u} \, du = \left[-\frac{2}{3}(1 + \sin x)^{3/2} \right]_{5\pi/6}^{\pi} + \int_{3/2}^1 (u^{5/2} - 2u^{3/2} + \sqrt{u}) \, du \\ & = \left(-\frac{2}{3}(1 + \sin \pi)^{3/2} + \frac{2}{3}\left(1 + \sin\left(\frac{5\pi}{6}\right)\right)^{3/2} \right) + \left[\frac{2}{7}u^{7/2} - \frac{4}{5}u^{5/2} + \frac{2}{3}u^{3/2} \right]_{3/2}^1 \\ & = \left(-\frac{2}{3} + \frac{2}{3}\left(\frac{3}{2}\right)^{3/2} \right) + \left(\frac{2}{7} - \frac{4}{5} + \frac{2}{3} \right) - \left(\frac{2}{7}\left(\frac{3}{2}\right)^{7/2} - \frac{4}{5}\left(\frac{3}{2}\right)^{5/2} + \frac{2}{3}\left(\frac{3}{2}\right)^{3/2} \right) = \frac{4}{5}\left(\frac{3}{2}\right)^{5/2} - \frac{2}{7}\left(\frac{3}{2}\right)^{7/2} - \frac{18}{35} \end{aligned}$$
30.
$$\begin{aligned} \int_{\pi/2}^{7\pi/12} \sqrt{1 - \sin 2x} \, dx &= \int_{\pi/2}^{7\pi/12} \frac{\sqrt{1 - \sin 2x} \sqrt{1 + \sin 2x}}{\sqrt{1 + \sin 2x}} \, dx = \int_{\pi/2}^{7\pi/12} \frac{\sqrt{1 - \sin^2 2x}}{\sqrt{1 + \sin 2x}} \, dx = \int_{\pi/2}^{7\pi/12} \frac{\sqrt{\cos^2 2x}}{\sqrt{1 + \sin 2x}} \, dx \\ &= \int_{\pi/2}^{7\pi/12} \frac{-\cos 2x}{\sqrt{1 + \sin 2x}} \, dx = \left[-\sqrt{1 + \sin 2x} \right]_{\pi/2}^{7\pi/12} = -\sqrt{1 + \sin 2\left(\frac{7\pi}{12}\right)} + \sqrt{1 + \sin 2\left(\frac{\pi}{2}\right)} = -\sqrt{\frac{1}{2}} + 1 = 1 - \frac{1}{\sqrt{2}} = \frac{\sqrt{2}-1}{\sqrt{2}} \end{aligned}$$
31.
$$\int_0^{\pi/2} \theta \sqrt{1 - \cos 2\theta} \, d\theta = \int_0^{\pi/2} \theta \sqrt{2} |\sin \theta| \, d\theta = \sqrt{2} \int_0^{\pi/2} \theta \sin \theta \, d\theta = \sqrt{2} [-\theta \cos \theta + \sin \theta]_0^{\pi/2} = \sqrt{2}(1) = \sqrt{2}$$
32.
$$\begin{aligned} \int_{-\pi}^{\pi} (1 - \cos^2 t)^{3/2} \, dt &= \int_{-\pi}^{\pi} (\sin^2 t)^{3/2} \, dt = \int_{-\pi}^{\pi} |\sin^3 t| \, dt = -\int_{-\pi}^0 \sin^3 t \, dt + \int_0^{\pi} \sin^3 t \, dt \\ &= -\int_{-\pi}^0 (1 - \cos^2 t) \sin t \, dt + \int_0^{\pi} (1 - \cos^2 t) \sin t \, dt \\ &= -\int_{-\pi}^0 \sin t \, dt + \int_{-\pi}^0 \cos^2 t \sin t \, dt + \int_0^{\pi} \sin t \, dt - \int_0^{\pi} \cos^2 t \sin t \, dt \\ &= \left[\cos t - \frac{\cos^3 t}{3} \right]_{-\pi}^0 + \left[-\cos t + \frac{\cos^3 t}{3} \right]_0^{\pi} = \left(1 - \frac{1}{3} + 1 - \frac{1}{3}\right) + \left(1 - \frac{1}{3} + 1 - \frac{1}{3}\right) = \frac{8}{3} \end{aligned}$$
33.
$$\int \sec^2 x \tan x \, dx = \int \tan x \sec^2 x \, dx = \frac{1}{2} \tan^2 x + C$$
34.
$$\begin{aligned} \int \sec x \tan^2 x \, dx &= \int \sec x \tan x \tan x \, dx; u = \tan x, du = \sec^2 x \, dx, dv = \sec x \tan x \, dx, v = \sec x; \\ &= \sec x \tan x - \int \sec^3 x \, dx = \sec x \tan x - \int \sec^2 x \sec x \, dx = \sec x \tan x - \int (\tan^2 x + 1) \sec x \, dx \\ &= \sec x \tan x - \left(\int \tan^2 x \sec x \, dx + \int \sec x \, dx \right) = \sec x \tan x - \ln |\sec x + \tan x| - \int \tan^2 x \sec x \, dx \\ &\Rightarrow \int \sec x \tan^2 x \, dx = \sec x \tan x - \ln |\sec x + \tan x| - \int \tan^2 x \sec x \, dx \\ &\Rightarrow 2 \int \tan^2 x \sec x \, dx = \sec x \tan x - \ln |\sec x + \tan x| \\ &\Rightarrow \int \tan^2 x \sec x \, dx = \frac{1}{2} \sec x \tan x - \frac{1}{2} \ln |\sec x + \tan x| + C \end{aligned}$$
35.
$$\int \sec^3 x \tan x \, dx = \int \sec^2 x \sec x \tan x \, dx = \frac{1}{3} \sec^3 x + C$$
36.
$$\begin{aligned} \int \sec^3 x \tan^3 x \, dx &= \int \sec^2 x \tan^2 x \sec x \tan x \, dx = \int \sec^2 x (\sec^2 x - 1) \sec x \tan x \, dx \\ &= \int \sec^4 x \sec x \tan x \, dx - \int \sec^2 x \sec x \tan x \, dx = \frac{1}{5} \sec^5 x - \frac{1}{3} \sec^3 x + C \end{aligned}$$
37.
$$\int \sec^2 x \tan^2 x \, dx = \int \tan^2 x \sec^2 x \, dx = \frac{1}{3} \tan^3 x + C$$

38. $\int \sec^4 x \tan^2 x \, dx = \int \sec^2 x \tan^2 x \sec^2 x \, dx = \int (\tan^2 x + 1) \tan^2 x \sec^2 x \, dx$
 $= \int \tan^4 x \sec^2 x \, dx + \int \tan^2 x \sec^2 x \, dx = \frac{1}{5} \tan^5 x + \frac{1}{3} \tan^3 x + C$
39. $\int_{-\pi/3}^0 2 \sec^3 x \, dx$; $u = \sec x$, $du = \sec x \tan x \, dx$, $dv = \sec^2 x \, dx$, $v = \tan x$;
 $\int_{-\pi/3}^0 2 \sec^3 x \, dx = [2 \sec x \tan x]_{-\pi/3}^0 - 2 \int_{-\pi/3}^0 \sec x \tan^2 x \, dx = 2 \cdot 1 \cdot 0 - 2 \cdot 2 \cdot (-\sqrt{3}) - 2 \int_{-\pi/3}^0 \sec x (\sec^2 x - 1) \, dx$
 $= 4\sqrt{3} - 2 \int_{-\pi/3}^0 \sec^3 x \, dx + 2 \int_{-\pi/3}^0 \sec x \, dx$;
 $2 \int_{-\pi/3}^0 2 \sec^3 x \, dx = 4\sqrt{3} + [2 \ln |\sec x + \tan x|]_{-\pi/3}^0 \Rightarrow 2 \int_{-\pi/3}^0 2 \sec^3 x \, dx = 4\sqrt{3} + 2 \ln |1 + 0| - 2 \ln |2 - \sqrt{3}|$
 $= 4\sqrt{3} - 2 \ln (2 - \sqrt{3}) \Rightarrow \int_{-\pi/3}^0 2 \sec^3 x \, dx = 2\sqrt{3} - \ln (2 - \sqrt{3})$
40. $\int e^x \sec^3(e^x) \, dx$; $u = \sec(e^x)$, $du = \sec(e^x) \tan(e^x) e^x \, dx$, $dv = \sec^2(e^x) e^x \, dx$, $v = \tan(e^x)$;
 $\int e^x \sec^3(e^x) \, dx = \sec(e^x) \tan(e^x) - \int \sec(e^x) \tan^2(e^x) e^x \, dx$
 $= \sec(e^x) \tan(e^x) - \int \sec(e^x) (\sec^2(e^x) - 1) e^x \, dx$
 $= \sec(e^x) \tan(e^x) - \int \sec^3(e^x) e^x \, dx + \int \sec(e^x) e^x \, dx$
 $2 \int e^x \sec^3(e^x) \, dx = \sec(e^x) \tan(e^x) + \ln |\sec(e^x) + \tan(e^x)| + C$
 $\int e^x \sec^3(e^x) \, dx = \frac{1}{2} [\sec(e^x) \tan(e^x) + \ln |\sec(e^x) + \tan(e^x)|] + C$
41. $\int \sec^4 \theta \, d\theta = \int (1 + \tan^2 \theta) \sec^2 \theta \, d\theta = \int \sec^2 \theta \, d\theta + \int \tan^2 \theta \sec^2 \theta \, d\theta = \tan \theta + \frac{1}{3} \tan^3 \theta + C$
 $= \tan \theta + \frac{1}{3} \tan \theta (\sec^2 \theta - 1) + C = \frac{1}{3} \tan \theta \sec^2 \theta + \frac{2}{3} \tan \theta + C$
42. $\int 3 \sec^4(3x) \, dx = \int (1 + \tan^2(3x)) \sec^2(3x) 3 \, dx = \int \sec^2(3x) 3 \, dx + \int \tan^2(3x) \sec^2(3x) 3 \, dx$
 $= \tan(3x) + \frac{1}{3} \tan^3(3x) + C$
43. $\int_{\pi/4}^{\pi/2} \csc^4 \theta \, d\theta = \int_{\pi/4}^{\pi/2} (1 + \cot^2 \theta) \csc^2 \theta \, d\theta = \int_{\pi/4}^{\pi/2} \csc^2 \theta \, d\theta + \int_{\pi/4}^{\pi/2} \cot^2 \theta \csc^2 \theta \, d\theta = \left[-\cot \theta - \frac{\cot^3 \theta}{3} \right]_{\pi/4}^{\pi/2}$
 $= (0) - \left(-1 - \frac{1}{3} \right) = \frac{4}{3}$
44. $\int \sec^6 x \, dx = \int \sec^4 x \sec^2 x \, dx = \int (\tan^2 x + 1)^2 \sec^2 x \, dx = \int (\tan^4 x + 2 \tan^2 x + 1) \sec^2 x \, dx$
 $= \int \tan^4 x \sec^2 x \, dx + 2 \int \tan^2 x \sec^2 x \, dx + \int \sec^2 x \, dx = \frac{1}{5} \tan^5 x + \frac{2}{3} \tan^3 x + \tan x + C$
45. $\int 4 \tan^3 x \, dx = 4 \int (\sec^2 x - 1) \tan x \, dx = 4 \int \sec^2 x \tan x \, dx - 4 \int \tan x \, dx = 4 \frac{\tan^2 x}{2} - 4 \ln |\sec x| + C$
 $= 2 \tan^2 x - 4 \ln |\sec x| + C = 2 \tan^2 x - 2 \ln |\sec^2 x| + C = 2 \tan^2 x - 2 \ln (1 + \tan^2 x) + C$

46. $\int_{-\pi/4}^{\pi/4} 6 \tan^4 x \, dx = 6 \int_{-\pi/4}^{\pi/4} (\sec^2 x - 1) \tan^2 x \, dx = 6 \int_{-\pi/4}^{\pi/4} \sec^2 x \tan^2 x \, dx - 6 \int_{-\pi/4}^{\pi/4} \tan^2 x \, dx$
 $= 6 \int_{-\pi/4}^{\pi/4} \sec^2 x \tan^2 x \, dx - 6 \int_{-\pi/4}^{\pi/4} (\sec^2 x - 1) \, dx = \left[6 \frac{\tan^3 x}{3} \right]_{-\pi/4}^{\pi/4} - 6 \int_{-\pi/4}^{\pi/4} \sec^2 x \, dx + 6 \int_{-\pi/4}^{\pi/4} dx$
 $= 2(1 - (-1)) - [6 \tan x]_{-\pi/4}^{\pi/4} + [6x]_{-\pi/4}^{\pi/4} = 4 - 6(1 - (-1)) + \frac{3\pi}{2} + \frac{3\pi}{2} = 3\pi - 8$
47. $\int \tan^5 x \, dx = \int \tan^4 x \tan x \, dx = \int (\sec^2 x - 1)^2 \tan x \, dx = \int (\sec^4 x - 2\sec^2 x + 1) \tan x \, dx$
 $= \int \sec^4 x \tan x \, dx - 2 \int \sec^2 x \tan x \, dx + \int \tan x \, dx$
 $= \int \sec^3 x \sec x \tan x \, dx - 2 \int \sec x \sec x \tan x \, dx + \int \tan x \, dx = \frac{1}{4} \sec^4 x - \sec^2 x + \ln |\sec x| + C$
 $= \frac{1}{4} (\tan^2 x + 1)^2 - (\tan^2 x + 1) + \ln |\sec x| + C = \frac{1}{4} \tan^4 x - \frac{1}{2} \tan^2 x + \ln |\sec x| + C$
48. $\int \cot^6 2x \, dx = \int \cot^4 2x \cot^2 2x \, dx = \int \cot^4 2x (\csc^2 2x - 1) \, dx = \int \cot^4 2x \csc^2 2x \, dx - \int \cot^4 2x \, dx$
 $= \int \cot^4 2x \csc^2 2x \, dx - \int \cot^2 2x \cot^2 2x \, dx = \int \cot^4 2x \csc^2 2x \, dx - \int \cot^2 2x (\csc^2 2x - 1) \, dx$
 $= \int \cot^4 2x \csc^2 2x \, dx - \int \cot^2 2x \csc^2 2x \, dx + \int \cot^2 2x \, dx$
 $= \int \cot^4 2x \csc^2 2x \, dx - \int \cot^2 2x \csc^2 2x \, dx + \int (\csc^2 2x - 1) \, dx$
 $= \int \cot^4 2x \csc^2 2x \, dx - \int \cot^2 2x \csc^2 2x \, dx + \int \csc^2 2x \, dx - \int dx = -\frac{1}{10} \cot^5 2x + \frac{1}{6} \cot^3 2x - \frac{1}{2} \cot 2x - x + C$
49. $\int_{\pi/6}^{\pi/3} \cot^3 x \, dx = \int_{\pi/6}^{\pi/3} (\csc^2 x - 1) \cot x \, dx = \int_{\pi/6}^{\pi/3} \csc^2 x \cot x \, dx - \int_{\pi/6}^{\pi/3} \cot x \, dx = \left[-\frac{\cot^2 x}{2} + \ln |\csc x| \right]_{\pi/6}^{\pi/3}$
 $= -\frac{1}{2} \left(\frac{1}{3} - 3 \right) + \left(\ln \frac{2}{\sqrt{3}} - \ln 2 \right) = \frac{4}{3} - \ln \sqrt{3}$
50. $\int 8 \cot^4 t \, dt = 8 \int (\csc^2 t - 1) \cot^2 t \, dt = 8 \int \csc^2 t \cot^2 t \, dt - 8 \int \cot^2 t \, dt = -\frac{8}{3} \cot^3 t - 8 \int (\csc^2 t - 1) \, dt$
 $= -\frac{8}{3} \cot^3 t + 8 \cot t + 8t + C$
51. $\int \sin 3x \cos 2x \, dx = \frac{1}{2} \int (\sin x + \sin 5x) \, dx = -\frac{1}{2} \cos x - \frac{1}{10} \cos 5x + C$
52. $\int \sin 2x \cos 3x \, dx = \frac{1}{2} \int (\sin(-x) + \sin 5x) \, dx = \frac{1}{2} \int (-\sin x + \sin 5x) \, dx = \frac{1}{2} \cos x - \frac{1}{10} \cos 5x + C$
53. $\int_{-\pi}^{\pi} \sin 3x \sin 3x \, dx = \frac{1}{2} \int_{-\pi}^{\pi} (\cos 0 - \cos 6x) \, dx = \frac{1}{2} \int_{-\pi}^{\pi} dx - \frac{1}{2} \int_{-\pi}^{\pi} \cos 6x \, dx = \frac{1}{2} \left[x - \frac{1}{12} \sin 6x \right]_{-\pi}^{\pi}$
 $= \frac{\pi}{2} + \frac{\pi}{2} - 0 = \pi$
54. $\int_0^{\pi/2} \sin x \cos x \, dx = \frac{1}{2} \int_0^{\pi/2} (\sin 0 + \sin 2x) \, dx = \frac{1}{2} \int_0^{\pi/2} \sin 2x \, dx = -\frac{1}{4} [\cos 2x]_0^{\pi/2} = -\frac{1}{4} (-1 - 1) = \frac{1}{2}$
55. $\int \cos 3x \cos 4x \, dx = \frac{1}{2} \int (\cos(-x) + \cos 7x) \, dx = \frac{1}{2} \int (\cos x + \cos 7x) \, dx = \frac{1}{2} \sin x + \frac{1}{14} \sin 7x + C$

$$56. \int_{-\pi/2}^{\pi/2} \cos 7x \cos x \, dx = \frac{1}{2} \int_{-\pi/2}^{\pi/2} (\cos 6x + \cos 8x) \, dx = \frac{1}{2} \left[\frac{1}{6} \sin 6x + \frac{1}{8} \sin 8x \right]_{-\pi/2}^{\pi/2} = 0$$

$$\begin{aligned} 57. \int \sin^2 \theta \cos 3\theta \, d\theta &= \int \frac{1-\cos 2\theta}{2} \cos 3\theta \, d\theta = \frac{1}{2} \int \cos 3\theta \, d\theta - \frac{1}{2} \int \cos 2\theta \cos 3\theta \, d\theta \\ &= \frac{1}{2} \int \cos 3\theta \, d\theta - \frac{1}{2} \int \frac{1}{2} (\cos(2-3)\theta + \cos(2+3)\theta) \, d\theta = \frac{1}{2} \int \cos 3\theta \, d\theta - \frac{1}{4} \int (\cos(-\theta) + \cos 5\theta) \, d\theta \\ &= \frac{1}{2} \int \cos 3\theta \, d\theta - \frac{1}{4} \int \cos \theta \, d\theta - \frac{1}{4} \int \cos 5\theta \, d\theta = \frac{1}{6} \sin 3\theta - \frac{1}{4} \sin \theta - \frac{1}{20} \sin 5\theta + C \end{aligned}$$

$$\begin{aligned} 58. \int \cos^2 2\theta \sin \theta \, d\theta &= \int (2\cos^2 \theta - 1)^2 \sin \theta \, d\theta = \int (4\cos^4 \theta - 4\cos^2 \theta + 1) \sin \theta \, d\theta \\ &= \int 4\cos^4 \theta \sin \theta \, d\theta - \int 4\cos^2 \theta \sin \theta \, d\theta + \int \sin \theta \, d\theta = -\frac{4}{5} \cos^5 \theta + \frac{4}{3} \cos^3 \theta - \cos \theta + C \end{aligned}$$

$$59. \int \cos^3 \theta \sin 2\theta \, d\theta = \int \cos^3 \theta (2\sin \theta \cos \theta) \, d\theta = 2 \int \cos^4 \theta \sin \theta \, d\theta = -\frac{2}{5} \cos^5 \theta + C$$

$$\begin{aligned} 60. \int \sin^3 \theta \cos 2\theta \, d\theta &= \int \sin^2 \theta \cos 2\theta \sin \theta \, d\theta = \int (1-\cos^2 \theta)(2\cos^2 \theta - 1) \sin \theta \, d\theta \\ &= \int (-2\cos^4 \theta + 3\cos^2 \theta - 1) \sin \theta \, d\theta = -2 \int \cos^4 \theta \sin \theta \, d\theta + 3 \int \cos^2 \theta \sin \theta \, d\theta - \int \sin \theta \, d\theta \\ &= \frac{2}{5} \cos^5 \theta - \cos^3 \theta + \cos \theta + C \end{aligned}$$

$$\begin{aligned} 61. \int \sin \theta \cos \theta \cos 3\theta \, d\theta &= \frac{1}{2} \int 2\sin \theta \cos \theta \cos 3\theta \, d\theta = \frac{1}{2} \int \sin 2\theta \cos 3\theta \, d\theta \\ &= \frac{1}{2} \int \frac{1}{2} (\sin(2-3)\theta + \sin(2+3)\theta) \, d\theta = \frac{1}{4} \int (\sin(-\theta) + \sin 5\theta) \, d\theta = \frac{1}{4} \int (-\sin \theta + \sin 5\theta) \, d\theta \\ &= \frac{1}{4} \cos \theta - \frac{1}{20} \cos 5\theta + C \end{aligned}$$

$$\begin{aligned} 62. \int \sin \theta \sin 2\theta \sin 3\theta \, d\theta &= \int \frac{1}{2} (\cos(1-2)\theta - \cos(1+2)\theta) \sin 3\theta \, d\theta = \frac{1}{2} \int (\cos(-\theta) - \cos 3\theta) \sin 3\theta \, d\theta \\ &= \frac{1}{2} \int \sin 3\theta \cos \theta \, d\theta - \frac{1}{2} \int \sin 3\theta \cos 3\theta \, d\theta = \frac{1}{2} \int \frac{1}{2} (\sin(3-1)\theta + \sin(3+1)\theta) \, d\theta - \frac{1}{4} \int 2\sin 3\theta \cos 3\theta \, d\theta \\ &= \frac{1}{4} \int (\sin 2\theta + \sin 4\theta) \, d\theta - \frac{1}{4} \int \sin 6\theta \, d\theta = -\frac{1}{8} \cos 2\theta - \frac{1}{16} \cos 4\theta + \frac{1}{24} \cos 6\theta + C \end{aligned}$$

$$\begin{aligned} 63. \int \frac{\sec^3 x}{\tan x} \, dx &= \int \frac{\sec^2 x \sec x}{\tan x} \, dx = \int \frac{(\tan^2 x + 1) \sec x}{\tan x} \, dx = \int \frac{\tan^2 x \sec x}{\tan x} \, dx + \int \frac{\sec x}{\tan x} \, dx = \int \tan x \sec x \, dx + \int \csc x \, dx \\ &= \sec x - \ln |\csc x + \cot x| + C \end{aligned}$$

$$\begin{aligned} 64. \int \frac{\sin^3 x}{\cos^4 x} \, dx &= \int \frac{\sin^2 x \sin x}{\cos^4 x} \, dx = \int \frac{(1-\cos^2 x) \sin x}{\cos^4 x} \, dx = \int \frac{\sin x}{\cos^4 x} \, dx - \int \frac{\cos^2 x \sin x}{\cos^4 x} \, dx = \int \sec^3 x \tan x \, dx - \int \sec x \tan x \, dx \\ &= \int \sec^2 x \sec x \tan x \, dx - \int \sec x \tan x \, dx = \frac{1}{3} \sec^3 x - \sec x + C \end{aligned}$$

$$\begin{aligned} 65. \int \frac{\tan^2 x}{\csc x} \, dx &= \int \frac{\sin^2 x}{\cos^2 x} \sin x \, dx = \int \frac{(1-\cos^2 x)}{\cos^2 x} \sin x \, dx = \int \frac{1}{\cos^2 x} \sin x \, dx - \int \frac{\cos x \sin x}{\cos^2 x} \, dx \\ &= \int \sec x \tan x \, dx - \int \sin x \, dx = \sec x + \cos x + C \end{aligned}$$

$$66. \int \frac{\cot x}{\cos^2 x} \, dx = \int \frac{\cos x}{\sin x} \cdot \frac{1}{\cos^2 x} \, dx = \int \frac{2}{2\sin x \cos x} \, dx = \int \frac{2}{\sin 2x} \, dx = \int \csc 2x \, dx = -\ln |\csc 2x + \cot 2x| + C$$

$$67. \int x \sin^2 x \, dx = \int x \frac{1 - \cos 2x}{2} \, dx = \frac{1}{2} \int x \, dx - \frac{1}{2} \int x \cos 2x \, dx \quad \left[u = x, du = dx, dv = \cos 2x \, dx, v = \frac{1}{2} \sin 2x \right]$$

$$= \frac{1}{4} x^2 - \frac{1}{2} \left[\frac{1}{2} x \sin 2x - \int \frac{1}{2} \sin 2x \, dx \right] = \frac{1}{4} x^2 - \frac{1}{4} x \sin 2x - \frac{1}{8} \cos 2x + C$$

$$68. \int x \cos^3 x \, dx = \int x \cos^2 x \cos x \, dx = \int x (1 - \sin^2 x) \cos x \, dx = \int x \cos x \, dx - \int x \sin^2 x \cos x \, dx;$$

$$\int x \cos x \, dx = x \sin x - \int \sin x \, dx = x \sin x + \cos x; \quad \left[u = x, du = dx, dv = \cos x \, dx, v = \sin x \right]$$

$$\int x \sin^2 x \cos x \, dx = \frac{1}{3} x \sin^3 x - \int \frac{1}{3} \sin^3 x \, dx; \quad \left[u = x, du = dx, dv = \sin^2 x \cos x \, dx, v = \frac{1}{3} \sin^3 x \right]$$

$$= \frac{1}{3} x \sin^3 x - \frac{1}{3} \int (1 - \cos^2 x) \sin x \, dx = \frac{1}{3} x \sin^3 x - \frac{1}{3} \int \sin x \, dx + \frac{1}{3} \int \cos^2 x \sin x \, dx$$

$$= \frac{1}{3} x \sin^3 x + \frac{1}{3} \cos x - \frac{1}{9} \cos^3 x;$$

$$\Rightarrow \int x \cos x \, dx - \int x \sin^2 x \cos x \, dx = (x \sin x + \cos x) - \left(\frac{1}{3} x \sin^3 x + \frac{1}{3} \cos x - \frac{1}{9} \cos^3 x \right) + C$$

$$= x \sin x - \frac{1}{3} x \sin^3 x + \frac{2}{3} \cos x + \frac{1}{9} \cos^3 x + C$$

$$69. y = \ln(\sec x); y' = \frac{\sec x \tan x}{\sec x} = \tan x; (y')^2 = \tan^2 x; \int_0^{\pi/4} \sqrt{1 + \tan^2 x} \, dx = \int_0^{\pi/4} |\sec x| \, dx$$

$$= \left[\ln |\sec x + \tan x| \right]_0^{\pi/4} = \ln(\sqrt{2} + 1) - \ln(0 + 1) = \ln(\sqrt{2} + 1)$$

$$70. M = \int_{-\pi/4}^{\pi/4} \sec x \, dx = \left[\ln |\sec x + \tan x| \right]_{-\pi/4}^{\pi/4} = \ln(\sqrt{2} + 1) - \ln|\sqrt{2} - 1| = \ln \frac{\sqrt{2} + 1}{\sqrt{2} - 1};$$

$$\bar{y} = \frac{1}{\ln \frac{\sqrt{2} + 1}{\sqrt{2} - 1}} \int_{-\pi/4}^{\pi/4} \frac{\sec^2 x}{2} \, dx = \frac{1}{2 \ln \frac{\sqrt{2} + 1}{\sqrt{2} - 1}} \left[\tan x \right]_{-\pi/4}^{\pi/4} = \frac{1}{2 \ln \frac{\sqrt{2} + 1}{\sqrt{2} - 1}} (1 - (-1)) = \frac{1}{\ln \frac{\sqrt{2} + 1}{\sqrt{2} - 1}} \Rightarrow (\bar{x}, \bar{y}) = \left(0, \left(\ln \frac{\sqrt{2} + 1}{\sqrt{2} - 1} \right)^{-1} \right)$$

$$71. V = \pi \int_0^{\pi} \sin^2 x \, dx = \pi \int_0^{\pi} \frac{1 - \cos 2x}{2} \, dx = \frac{\pi}{2} \int_0^{\pi} dx - \frac{\pi}{2} \int_0^{\pi} \cos 2x \, dx = \frac{\pi}{2} [x]_0^{\pi} - \frac{\pi}{4} [\sin 2x]_0^{\pi}$$

$$= \frac{\pi}{2} (\pi - 0) - \frac{\pi}{4} (0 - 0) = \frac{\pi^2}{2}$$

$$72. A = \int_0^{\pi} \sqrt{1 + \cos 4x} \, dx = \int_0^{\pi} \sqrt{2} |\cos 2x| \, dx = \sqrt{2} \int_0^{\pi/4} \cos 2x \, dx - \sqrt{2} \int_{\pi/4}^{3\pi/4} \cos 2x \, dx + \sqrt{2} \int_{3\pi/4}^{\pi} \cos 2x \, dx$$

$$= \frac{\sqrt{2}}{2} [\sin 2x]_0^{\pi/4} - \frac{\sqrt{2}}{2} [\sin 2x]_{\pi/4}^{3\pi/4} + \frac{\sqrt{2}}{2} [\sin 2x]_{3\pi/4}^{\pi} = \frac{\sqrt{2}}{2} (1 - 0) - \frac{\sqrt{2}}{2} (-1 - 1) + \frac{\sqrt{2}}{2} (0 + 1) = \sqrt{2} + \sqrt{2} = 2\sqrt{2}$$

$$73. M = \int_0^{2\pi} (x + \cos x) \, dx = \left[\frac{1}{2} x^2 + \sin x \right]_0^{2\pi} = \left(\frac{1}{2} (2\pi)^2 + \sin(2\pi) \right) - \left(\frac{1}{2} (0)^2 + \sin(0) \right) = 2\pi^2;$$

$$\bar{x} = \frac{1}{2\pi^2} \int_0^{2\pi} x(x + \cos x) \, dx = \frac{1}{2\pi^2} \int_0^{2\pi} (x^2 + x \cos x) \, dx = \frac{1}{2\pi^2} \int_0^{2\pi} x^2 \, dx + \frac{1}{2\pi^2} \int_0^{2\pi} x \cos x \, dx$$

$$\left[u = x, du = dx, dv = \cos x \, dx, v = \sin x \right]$$

$$= \frac{1}{6\pi^2} \left[x^3 \right]_0^{2\pi} + \frac{1}{2\pi^2} \left([x \sin x]_0^{2\pi} - \int_0^{2\pi} \sin x \, dx \right) = \frac{1}{6\pi^2} (8\pi^3 - 0) + \frac{1}{2\pi^2} \left(2\pi \sin 2\pi - 0 - \int_0^{2\pi} \sin x \, dx \right)$$

$$= \frac{4\pi}{3} + \frac{1}{2\pi^2} [\cos x]_0^{2\pi} = \frac{4\pi}{3} + \frac{1}{2\pi^2} (\cos 2\pi - \cos 0) = \frac{4\pi}{3} + 0 = \frac{4\pi}{3}; \quad \bar{y} = \frac{1}{2\pi^2} \int_0^{2\pi} \frac{1}{2} (x + \cos x)^2 \, dx$$

$$= \frac{1}{4\pi^2} \int_0^{2\pi} (x^2 + 2x \cos x + \cos^2 x) \, dx = \frac{1}{4\pi^2} \int_0^{2\pi} x^2 \, dx + \frac{1}{2\pi^2} \int_0^{2\pi} x \cos x \, dx + \frac{1}{4\pi^2} \int_0^{2\pi} \cos^2 x \, dx$$

$$\begin{aligned}
 &= \frac{1}{12\pi^2} \left[x^3 \right]_0^{2\pi} + \frac{1}{2\pi^2} [x \sin x + \cos x]_0^{2\pi} + \frac{1}{4\pi^2} \int_0^{2\pi} \frac{\cos 2x+1}{2} dx = \frac{2\pi}{3} + 0 + \frac{1}{8\pi^2} \int_0^{2\pi} \cos 2x dx + \frac{1}{8\pi^2} \int_0^{2\pi} dx \\
 &= \frac{2\pi}{3} + \frac{1}{16\pi^2} [\sin 2x]_0^{2\pi} + \frac{1}{8\pi^2} [x]_0^{2\pi} = \frac{2\pi}{3} + 0 + \frac{1}{4\pi} = \frac{8\pi^2+3}{12\pi} \Rightarrow \text{The centroid is } \left(\frac{4\pi}{3}, \frac{8\pi^2+3}{12\pi} \right).
 \end{aligned}$$

74. $V = \int_0^{\pi/3} \pi (\sin x + \sec x)^2 dx = \pi \int_0^{\pi/3} (\sin^2 x + 2 \sin x \sec x + \sec^2 x) dx$
 $= \pi \int_0^{\pi/3} \sin^2 x dx + \pi \int_0^{\pi/3} 2 \tan x dx + \pi \int_0^{\pi/3} \sec^2 x dx = \pi \int_0^{\pi/3} \frac{1-\cos 2x}{2} dx + 2\pi [\ln |\sec x|]_0^{\pi/3} + \pi [\tan x]_0^{\pi/3}$
 $= \frac{\pi}{2} \int_0^{\pi/3} dx - \frac{\pi}{2} \int_0^{\pi/3} \cos 2x dx + 2\pi (\ln |\sec \frac{\pi}{3}| - \ln |\sec 0|) + \pi (\tan \frac{\pi}{3} - \tan 0)$
 $= \frac{\pi}{2} [x]_0^{\pi/3} - \frac{\pi}{4} [\sin 2x]_0^{\pi/3} + 2\pi \ln 2 + \pi\sqrt{3} = \frac{\pi}{2} \left(\frac{\pi}{3} - 0 \right) - \frac{\pi}{4} (\sin 2(\frac{\pi}{3}) - \sin 2(0)) + 2\pi \ln 2 + \pi\sqrt{3}$
 $= \frac{\pi^2}{6} - \frac{\pi\sqrt{3}}{8} + 2\pi \ln 2 + \pi\sqrt{3} = \frac{\pi(4\pi+21\sqrt{3}-48 \ln 2)}{24}$

8.4 TRIGONOMETRIC SUBSTITUTIONS

1. $x = 3 \tan \theta, -\frac{\pi}{2} < \theta < \frac{\pi}{2}, dx = \frac{3 d\theta}{\cos^2 \theta}, 9 + x^2 = 9(1 + \tan^2 \theta) = 9 \sec^2 \theta \Rightarrow \frac{1}{\sqrt{9+x^2}} = \frac{1}{3|\sec \theta|} = \frac{|\cos \theta|}{3} = \frac{\cos \theta}{3};$

because $\cos \theta > 0$ when $-\frac{\pi}{2} < \theta < \frac{\pi}{2};$

$$\int \frac{dx}{\sqrt{9+x^2}} = 3 \int \frac{\cos \theta d\theta}{3 \cos^2 \theta} = \int \frac{d\theta}{\cos \theta} = \ln |\sec \theta + \tan \theta| + C' = \ln \left| \frac{\sqrt{9+x^2}}{3} + \frac{x}{3} \right| + C' = \ln \left| \sqrt{9+x^2} + x \right| + C$$

2. $\int \frac{3 dx}{\sqrt{1+9x^2}}; [3x = u, 3 dx = du] \rightarrow \int \frac{du}{\sqrt{1+u^2}}; u = \tan t, -\frac{\pi}{2} < t < \frac{\pi}{2}, du = \frac{dt}{\cos^2 t}, \sqrt{1+u^2} = |\sec t| = \sec t;$
 $\int \frac{du}{\sqrt{1+u^2}} = \int \frac{dt}{\cos^2 t (\sec t)} = \int \sec t dt = \ln |\sec t + \tan t| + C = \ln \left| \sqrt{u^2+1} + u \right| + C = \ln \left| \sqrt{1+9x^2} + 3x \right| + C$

3. $\int_{-2}^2 \frac{dx}{(4+x^2)} = \left[\frac{1}{2} \tan^{-1} \frac{x}{2} \right]_{-2}^2 = \frac{1}{2} \tan^{-1} 1 - \frac{1}{2} \tan^{-1} (-1) = \left(\frac{1}{2} \right) \left(\frac{\pi}{4} \right) - \left(\frac{1}{2} \right) \left(-\frac{\pi}{4} \right) = \frac{\pi}{4}$

4. $\int_0^2 \frac{dx}{8+2x^2} = \frac{1}{2} \int_0^2 \frac{dx}{4+x^2} = \frac{1}{2} \left[\frac{1}{2} \tan^{-1} \frac{x}{2} \right]_0^2 = \frac{1}{2} \left(\frac{1}{2} \tan^{-1} 1 - \frac{1}{2} \tan^{-1} 0 \right) = \left(\frac{1}{2} \right) \left(\frac{1}{2} \right) \left(\frac{\pi}{4} \right) - 0 = \frac{\pi}{16}$

5. $\int_0^{3/2} \frac{dx}{\sqrt{9-x^2}} = \left[\sin^{-1} \frac{x}{3} \right]_0^{3/2} = \sin^{-1} \frac{1}{2} - \sin^{-1} 0 = \frac{\pi}{6} - 0 = \frac{\pi}{6}$

6. $\int_0^{1/\sqrt{2}} \frac{2 dx}{\sqrt{1-4x^2}}; [t = 2x, dt = 2 dx] \rightarrow \int_0^{1/\sqrt{2}} \frac{dt}{\sqrt{1-t^2}} = \left[\sin^{-1} t \right]_0^{1/\sqrt{2}} = \sin^{-1} \frac{1}{\sqrt{2}} - \sin^{-1} 0 = \frac{\pi}{4} - 0 = \frac{\pi}{4}$

7. $t = 5 \sin \theta, -\frac{\pi}{2} < \theta < \frac{\pi}{2}, dt = 5 \cos \theta d\theta, \sqrt{25-t^2} = 5 \cos \theta;$
 $\int \sqrt{25-t^2} dt = \int (5 \cos \theta)(5 \cos \theta) d\theta = 25 \int \cos^2 \theta d\theta = 25 \int \frac{1+\cos 2\theta}{2} d\theta = 25 \left(\frac{\theta}{2} + \frac{\sin 2\theta}{4} \right) + C$
 $= \frac{25}{2} (\theta + \sin \theta \cos \theta) + C = \frac{25}{2} \left[\sin^{-1} \left(\frac{t}{5} \right) + \left(\frac{t}{5} \right) \left(\frac{\sqrt{25-t^2}}{5} \right) \right] + C = \frac{25}{2} \sin^{-1} \left(\frac{t}{5} \right) + \frac{t\sqrt{25-t^2}}{2} + C$

8. $t = \frac{1}{3} \sin \theta, -\frac{\pi}{2} < \theta < \frac{\pi}{2}, dt = \frac{1}{3} \cos \theta d\theta, \sqrt{1-9t^2} = \cos \theta;$
 $\int \sqrt{1-9t^2} dt = \frac{1}{3} \int (\cos \theta)(\cos \theta) d\theta = \frac{1}{3} \int \cos^2 \theta d\theta = \frac{1}{6}(\theta + \sin \theta \cos \theta) + C = \frac{1}{6} \left[\sin^{-1}(3t) + 3t\sqrt{1-9t^2} \right] + C$
9. $x = \frac{7}{2} \sec \theta, 0 < \theta < \frac{\pi}{2}, dx = \frac{7}{2} \sec \theta \tan \theta d\theta, \sqrt{4x^2-49} = \sqrt{49 \sec^2 \theta - 49} = 7 \tan \theta;$
 $\int \frac{dx}{\sqrt{4x^2-49}} = \int \frac{(\frac{7}{2} \sec \theta \tan \theta) d\theta}{7 \tan \theta} = \frac{1}{2} \int \sec \theta d\theta = \frac{1}{2} \ln |\sec \theta + \tan \theta| + C = \frac{1}{2} \ln \left| \frac{2x}{7} + \frac{\sqrt{4x^2-49}}{7} \right| + C$
10. $x = \frac{3}{5} \sec \theta, 0 < \theta < \frac{\pi}{2}, dx = \frac{3}{5} \sec \theta \tan \theta d\theta, \sqrt{25x^2-9} = \sqrt{9 \sec^2 \theta - 9} = 3 \tan \theta;$
 $\int \frac{5 dx}{\sqrt{25x^2-9}} = \int \frac{5(\frac{3}{5} \sec \theta \tan \theta) d\theta}{3 \tan \theta} = \int \sec \theta d\theta = \ln |\sec \theta + \tan \theta| + C = \ln \left| \frac{5x}{3} + \frac{\sqrt{25x^2-9}}{3} \right| + C$
11. $y = 7 \sec \theta, 0 < \theta < \frac{\pi}{2}, dy = 7 \sec \theta \tan \theta d\theta, \sqrt{y^2-49} = 7 \tan \theta;$
 $\int \frac{\sqrt{y^2-49}}{y} dy = \int \frac{(7 \tan \theta)(7 \sec \theta \tan \theta) d\theta}{7 \sec \theta} = 7 \int \tan^2 \theta d\theta = 7 \int (\sec^2 \theta - 1) d\theta = 7(\tan \theta - \theta) + C$
 $= 7 \left[\frac{\sqrt{y^2-49}}{7} - \sec^{-1} \left(\frac{y}{7} \right) \right] + C$
12. $y = 5 \sec \theta, 0 < \theta < \frac{\pi}{2}, dy = 5 \sec \theta \tan \theta d\theta, \sqrt{y^2-25} = 5 \tan \theta;$
 $\int \frac{\sqrt{y^2-25}}{y^3} dy = \int \frac{(5 \tan \theta)(5 \sec \theta \tan \theta) d\theta}{125 \sec^3 \theta} = \frac{1}{5} \int \tan^2 \theta \cos^2 \theta d\theta = \frac{1}{5} \int \sin^2 \theta d\theta = \frac{1}{10} \int (1 - \cos 2\theta) d\theta$
 $= \frac{1}{10}(\theta - \sin \theta \cos \theta) + C = \frac{1}{10} \left[\sec^{-1} \left(\frac{y}{5} \right) - \left(\frac{\sqrt{y^2-25}}{y} \right) \left(\frac{5}{y} \right) \right] + C = \left[\frac{\sec^{-1} \left(\frac{y}{5} \right)}{10} - \frac{\sqrt{y^2-25}}{2y^2} \right] + C$
13. $x = \sec \theta, 0 < \theta < \frac{\pi}{2}, dx = \sec \theta \tan \theta d\theta, \sqrt{x^2-1} = \tan \theta;$
 $\int \frac{dx}{x^2 \sqrt{x^2-1}} = \int \frac{\sec \theta \tan \theta d\theta}{\sec^2 \theta \tan \theta} = \int \frac{d\theta}{\sec \theta} = \sin \theta + C = \frac{\sqrt{x^2-1}}{x} + C$
14. $x = \sec \theta, 0 < \theta < \frac{\pi}{2}, dx = \sec \theta \tan \theta d\theta, \sqrt{x^2-1} = \tan \theta;$
 $\int \frac{2 dx}{x^3 \sqrt{x^2-1}} = \int \frac{2 \tan \theta \sec \theta d\theta}{\sec^3 \theta \tan \theta} = 2 \int \cos^2 \theta d\theta = 2 \int \left(\frac{1+\cos 2\theta}{2} \right) d\theta = \theta + \sin \theta \cos \theta + C$
 $= \theta + \tan \theta \cos^2 \theta + C = \sec^{-1} x + \sqrt{x^2-1} \left(\frac{1}{x} \right)^2 + C = \sec^{-1} x + \frac{\sqrt{x^2-1}}{x^2} + C$
15. $u = 9-x^2 \Rightarrow du = -2x dx \Rightarrow -\frac{1}{2} du = x dx;$
 $\int \frac{x dx}{\sqrt{9-x^2}} = -\frac{1}{2} \int \frac{1}{\sqrt{u}} du = -\sqrt{u} + C = -\sqrt{9-x^2} + C$

16. $x = 2 \tan \theta$, $-\frac{\pi}{2} < \theta < \frac{\pi}{2}$, $dx = 2 \sec^2 \theta d\theta$, $4 + x^2 = 4 \sec^2 \theta$;

$$\int \frac{x^2 dx}{4+x^2} = \int \frac{(4 \tan^2 \theta)(2 \sec^2 \theta) d\theta}{4 \sec^2 \theta} = \int 2 \tan^2 \theta d\theta = 2 \left(\int \sec^2 \theta - 1 \right) d\theta = 2 \int \sec^2 \theta d\theta - 2 \int d\theta$$

$$= 2 \tan \theta - 2\theta + C = x - 2 \tan^{-1} \left(\frac{x}{2} \right) + C$$

17. $x = 2 \tan \theta$, $-\frac{\pi}{2} < \theta < \frac{\pi}{2}$, $dx = \frac{2 d\theta}{\cos^2 \theta}$, $\sqrt{x^2 + 4} = \frac{2}{\cos \theta}$;

$$\int \frac{x^3 dx}{\sqrt{x^2+4}} = \int \frac{(8 \tan^3 \theta)(\cos \theta) d\theta}{\cos^2 \theta} = 8 \int \frac{\sin^3 \theta d\theta}{\cos^4 \theta} = 8 \int \frac{(\cos^2 \theta - 1)(-\sin \theta) d\theta}{\cos^4 \theta}; [t = \cos \theta, dt = -\sin \theta d\theta]$$

$$\rightarrow 8 \int \frac{t^2 - 1}{t^4} dt = 8 \int \left(\frac{1}{t^2} - \frac{1}{t^4} \right) dt = 8 \left(-\frac{1}{t} + \frac{1}{3t^3} \right) + C = 8 \left(-\sec^3 \theta + \frac{\sec \theta}{3} \right) + C = 8 \left(-\frac{\sqrt{x^2+4}}{2} + \frac{(x^2+4)^{3/2}}{8 \cdot 3} \right) + C$$

$$= \frac{1}{3} (x^2 + 4)^{3/2} - 4\sqrt{x^2 + 4} + C = \frac{1}{3} (x^2 - 8) \sqrt{x^2 + 4} + C$$

18. $x = \tan \theta$, $-\frac{\pi}{2} < \theta < \frac{\pi}{2}$, $dx = \sec^2 \theta d\theta$, $\sqrt{x^2 + 1} = \sec \theta$;

$$\int \frac{dx}{x^2 \sqrt{x^2+1}} = \int \frac{\sec^2 \theta d\theta}{\tan^2 \theta \sec \theta} = \int \frac{\cos \theta d\theta}{\sin^2 \theta} = -\frac{1}{\sin \theta} + C = \frac{-\sqrt{x^2+1}}{x} + C$$

19. $w = 2 \sin \theta$, $-\frac{\pi}{2} < \theta < \frac{\pi}{2}$, $dw = 2 \cos \theta d\theta$, $\sqrt{4 - w^2} = 2 \cos \theta$;

$$\int \frac{8 dw}{w^2 \sqrt{4-w^2}} = \int \frac{8 \cdot 2 \cos \theta d\theta}{4 \sin^2 \theta \cdot 2 \cos \theta} = 2 \int \frac{d\theta}{\sin^2 \theta} = -2 \cot \theta + C = \frac{-2\sqrt{4-w^2}}{w} + C$$

20. $w = 3 \sin \theta$, $-\frac{\pi}{2} < \theta < \frac{\pi}{2}$, $dw = 3 \cos \theta d\theta$, $\sqrt{9 - w^2} = 3 \cos \theta$;

$$\int \frac{\sqrt{9-w^2}}{w^2} dw = \int \frac{3 \cos \theta \cdot 3 \cos \theta d\theta}{9 \sin^2 \theta} = \int \cot^2 \theta d\theta = \int \left(\frac{1 - \sin^2 \theta}{\sin^2 \theta} \right) d\theta = \int (\csc^2 \theta - 1) d\theta$$

$$= -\cot \theta - \theta + C = -\frac{\sqrt{9-w^2}}{w} - \sin^{-1} \left(\frac{w}{3} \right) + C$$

21. $\int \sqrt{\frac{x+1}{1-x}} dx$ Multiply the integrand by $\sqrt{\frac{1+x}{1+x}}$.

$$\int \sqrt{\frac{x+1}{1-x}} dx = \int \frac{x+1}{\sqrt{1-x^2}} dx \quad \text{where } -1 < x < 1$$

$x = \sin \theta$, $dx = \cos \theta d\theta$, $-\frac{\pi}{2} < \theta < \frac{\pi}{2}$ so that $\cos \theta > 0$ and $\sqrt{1-x^2} = \cos \theta$.

$$\int \frac{x+1}{\sqrt{1-x^2}} dx = \int \frac{\sin \theta + 1}{\cos \theta} \cos \theta d\theta$$

$$= \int (\sin \theta + 1) d\theta = \theta - \cos \theta + C$$

$$= \sin^{-1} x - \sqrt{1-x^2} + C$$

22. $u = x^2 - 4 \Rightarrow du = 2x dx \Rightarrow \frac{1}{2} du = x dx;$

$$\int x\sqrt{x^2 - 4} dx = \frac{1}{2} \int \sqrt{u} du = \frac{1}{3} u^{3/2} + C = \frac{1}{3} (x^2 - 4)^{3/2} + C$$

23. $x = \sin \theta, 0 \leq \theta \leq \frac{\pi}{3}, dx = \cos \theta d\theta, (1 - x^2)^{3/2} = \cos^3 \theta;$

$$\int_0^{\sqrt{3}/2} \frac{4x^2 dx}{(1-x^2)^{3/2}} = \int_0^{\pi/3} \frac{4\sin^2 \theta \cos \theta d\theta}{\cos^3 \theta} = 4 \int_0^{\pi/3} \left(\frac{1 - \cos^2 \theta}{\cos^2 \theta} \right) d\theta = 4 \int_0^{\pi/3} (\sec^2 \theta - 1) d\theta = 4 [\tan \theta - \theta]_0^{\pi/3} = 4\sqrt{3} - \frac{4\pi}{3}$$

24. $x = 2 \sin \theta, 0 \leq \theta \leq \frac{\pi}{6}, dx = 2 \cos \theta d\theta, (4 - x^2)^{3/2} = 8 \cos^3 \theta;$

$$\int_0^1 \frac{dx}{(4-x^2)^{3/2}} = \int_0^{\pi/6} \frac{2 \cos \theta d\theta}{8 \cos^3 \theta} = \frac{1}{4} \int_0^{\pi/6} \frac{d\theta}{\cos^2 \theta} = \frac{1}{4} [\tan \theta]_0^{\pi/6} = \frac{\sqrt{3}}{12} = \frac{1}{4\sqrt{3}}$$

25. $x = \sec \theta, 0 < \theta < \frac{\pi}{2}, dx = \sec \theta \tan \theta d\theta, (x^2 - 1)^{3/2} = \tan^3 \theta;$

$$\int \frac{dx}{(x^2 - 1)^{3/2}} = \int \frac{\sec \theta \tan \theta d\theta}{\tan^3 \theta} = \int \frac{\cos \theta d\theta}{\sin^2 \theta} = -\frac{1}{\sin \theta} + C = -\frac{x}{\sqrt{x^2 - 1}} + C$$

26. $x = \sec \theta, 0 < \theta < \frac{\pi}{2}, dx = \sec \theta \tan \theta d\theta, (x^2 - 1)^{5/2} = \tan^5 \theta;$

$$\int \frac{x^2 dx}{(x^2 - 1)^{5/2}} = \int \frac{\sec^2 \theta \sec \theta \tan \theta d\theta}{\tan^5 \theta} = \int \frac{\cos \theta}{\sin^4 \theta} d\theta = -\frac{1}{3 \sin^3 \theta} + C = -\frac{x}{3(x^2 - 1)^{3/2}} + C$$

27. $x = \sin \theta, -\frac{\pi}{2} < \theta < \frac{\pi}{2}, dx = \cos \theta d\theta, (1 - x^2)^{3/2} = \cos^3 \theta;$

$$\int \frac{(1-x^2)^{3/2} dx}{x^6} = \int \frac{\cos^3 \theta \cos \theta d\theta}{\sin^6 \theta} = \int \cot^4 \theta \csc^2 \theta d\theta = -\frac{\cot^5 \theta}{5} + C = -\frac{1}{5} \left(\frac{\sqrt{1-x^2}}{x} \right)^5 + C$$

28. $x = \sin \theta, -\frac{\pi}{2} < \theta < \frac{\pi}{2}, dx = \cos \theta d\theta, (1 - x^2)^{1/2} = \cos \theta;$

$$\int \frac{(1-x^2)^{1/2} dx}{x^4} = \int \frac{\cos \theta \cos \theta d\theta}{\sin^4 \theta} = \int \cot^2 \theta \csc^2 \theta d\theta = -\frac{\cot^3 \theta}{3} + C = -\frac{1}{3} \left(\frac{\sqrt{1-x^2}}{x} \right)^3 + C$$

29. $x = \frac{1}{2} \tan \theta, -\frac{\pi}{2} < \theta < \frac{\pi}{2}, dx = \frac{1}{2} \sec^2 \theta d\theta, (4x^2 + 1)^2 = \sec^4 \theta;$

$$\int \frac{8dx}{(4x^2 + 1)^2} = \int \frac{8 \left(\frac{1}{2} \sec^2 \theta \right) d\theta}{\sec^4 \theta} = 4 \int \cos^2 \theta d\theta = 2(\theta + \sin \theta \cos \theta) + C = 2 \tan^{-1} 2x + \frac{4}{4x^2 + 1} + C$$

30. $t = \frac{1}{3} \tan \theta, -\frac{\pi}{2} < \theta < \frac{\pi}{2}, dt = \frac{1}{3} \sec^2 \theta d\theta, 9t^2 + 1 = \sec^2 \theta;$

$$\int \frac{6dt}{(9t^2 + 1)^2} = \int \frac{6 \left(\frac{1}{3} \sec^2 \theta \right) d\theta}{\sec^4 \theta} = 2 \int \cos^2 \theta d\theta = \theta + \sin \theta \cos \theta + C = \tan^{-1} 3t + \frac{3t}{9t^2 + 1} + C$$

31. $u = x^2 - 1 \Rightarrow du = 2x dx \Rightarrow \frac{1}{2} du = x dx$;

$$\int \frac{x^3}{x^2-1} dx = \int \left(x + \frac{x}{x^2-1} \right) dx = \int x dx + \int \frac{x}{x^2-1} dx = \frac{1}{2} x^2 + \frac{1}{2} \int \frac{1}{u} du = \frac{1}{2} x^2 + \frac{1}{2} \ln |u| + C = \frac{1}{2} x^2 + \frac{1}{2} \ln |x^2 - 1| + C$$
32. $u = 25 + 4x^2 \Rightarrow du = 8x dx \Rightarrow \frac{1}{8} du = x dx$;

$$\int \frac{x}{25+4x^2} dx = \frac{1}{8} \int \frac{1}{u} du = \frac{1}{8} \ln |u| + C = \frac{1}{8} \ln (25 + 4x^2) + C$$
33. $v = \sin \theta, -\frac{\pi}{2} < \theta < \frac{\pi}{2}, dv = \cos \theta d\theta, (1-v^2)^{5/2} = \cos^5 \theta$;

$$\int \frac{v^2 dv}{(1-v^2)^{5/2}} = \int \frac{\sin^2 \theta \cos \theta d\theta}{\cos^5 \theta} = \int \tan^2 \theta \sec^2 \theta d\theta = \frac{\tan^3 \theta}{3} + C = \frac{1}{3} \left(\frac{v}{\sqrt{1-v^2}} \right)^3 + C$$
34. $r = \sin \theta, -\frac{\pi}{2} < \theta < \frac{\pi}{2}; dr = \cos \theta d\theta, (1-r^2)^{5/2} = \cos^5 \theta$;

$$\int \frac{(1-r^2)^{5/2} dr}{r^8} = \int \frac{\cos^5 \theta \cdot \cos \theta d\theta}{\sin^8 \theta} = \int \cot^6 \theta \csc^2 \theta d\theta = -\frac{\cot^7 \theta}{7} + C = -\frac{1}{7} \left[\frac{\sqrt{1-r^2}}{r} \right]^7 + C$$
35. Let $e^t = 3 \tan \theta, t = \ln(3 \tan \theta), \tan^{-1} \left(\frac{1}{3} \right) \leq \theta \leq \tan^{-1} \left(\frac{4}{3} \right), dt = \frac{\sec^2 \theta}{\tan \theta} d\theta, \sqrt{e^{2t} + 9} = \sqrt{9 \tan^2 \theta + 9} = 3 \sec \theta$;

$$\int_0^{\ln 4} \frac{e^t dt}{\sqrt{e^{2t} + 9}} = \int_{\tan^{-1}(1/3)}^{\tan^{-1}(4/3)} \frac{3 \tan \theta \cdot \sec^2 \theta d\theta}{\tan \theta \cdot 3 \sec \theta} = \int_{\tan^{-1}(1/3)}^{\tan^{-1}(4/3)} \sec \theta d\theta = \left[\ln |\sec \theta + \tan \theta| \right]_{\tan^{-1}(1/3)}^{\tan^{-1}(4/3)}$$

$$= \ln \left(\frac{5}{3} + \frac{4}{3} \right) - \ln \left(\frac{\sqrt{10}}{3} + \frac{1}{3} \right) = \ln 9 - \ln (1 + \sqrt{10})$$
36. Let $e^t = \tan \theta, t = \ln(\tan \theta), \tan^{-1} \left(\frac{3}{4} \right) \leq \theta \leq \tan^{-1} \left(\frac{4}{3} \right), dt = \frac{\sec^2 \theta}{\tan \theta} d\theta, 1 + e^{2t} = 1 + \tan^2 \theta = \sec^2 \theta$;

$$\int_{\ln(3/4)}^{\ln(4/3)} \frac{e^t dt}{(1+e^{2t})^{3/2}} = \int_{\tan^{-1}(3/4)}^{\tan^{-1}(4/3)} \frac{(\tan \theta) \left(\frac{\sec^2 \theta}{\tan \theta} \right) d\theta}{\sec^3 \theta} = \int_{\tan^{-1}(3/4)}^{\tan^{-1}(4/3)} \cos \theta d\theta = \left[\sin \theta \right]_{\tan^{-1}(3/4)}^{\tan^{-1}(4/3)} = \frac{4}{5} - \frac{3}{5} = \frac{1}{5}$$
37. $\int_{1/12}^{1/4} \frac{2 dt}{\sqrt{t+4t\sqrt{t}}}$; $\left[u = 2\sqrt{t}, du = \frac{1}{\sqrt{t}} dt \right] \rightarrow \int_{1/\sqrt{3}}^1 \frac{2 du}{\sqrt{3} \sqrt{1+u^2}}$; $u = \tan \theta, \frac{\pi}{6} \leq \theta \leq \frac{\pi}{4}, du = \sec^2 \theta d\theta, 1+u^2 = \sec^2 \theta$;

$$\int_{1/\sqrt{3}}^1 \frac{2 du}{\sqrt{3} \sqrt{1+u^2}} = \int_{\pi/6}^{\pi/4} \frac{2 \sec^2 \theta d\theta}{\sqrt{3} \sec^2 \theta} = \left[2\theta \right]_{\pi/6}^{\pi/4} = 2 \left(\frac{\pi}{4} - \frac{\pi}{6} \right) = \frac{\pi}{6}$$
38. $y = e^{\tan \theta}, 0 \leq \theta \leq \frac{\pi}{4}, dy = e^{\tan \theta} \sec^2 \theta d\theta, \sqrt{1+(\ln y)^2} = \sqrt{1+\tan^2 \theta} = \sec \theta$;

$$\int_1^e \frac{dy}{y \sqrt{1+(\ln y)^2}} = \int_0^{\pi/4} \frac{e^{\tan \theta} \sec^2 \theta}{e^{\tan \theta} \sec \theta} d\theta = \int_0^{\pi/4} \sec \theta d\theta = \left[\ln |\sec \theta + \tan \theta| \right]_0^{\pi/4} = \ln (1 + \sqrt{2})$$
39. $x = \sec \theta, 0 < \theta < \frac{\pi}{2}, dx = \sec \theta \tan \theta d\theta, \sqrt{x^2 - 1} = \sqrt{\sec^2 \theta - 1} = \tan \theta$;

$$\int \frac{dx}{x \sqrt{x^2 - 1}} = \int \frac{\sec \theta \tan \theta d\theta}{\sec \theta \tan \theta} = \theta + C = \sec^{-1} x + C$$

40. $x = \tan \theta, dx = \sec^2 \theta d\theta, 1 + x^2 = \sec^2 \theta;$

$$\int \frac{dx}{x^2+1} = \int \frac{\sec^2 \theta d\theta}{\sec^2 \theta} = \theta + C = \tan^{-1} x + C$$

41. $x = \sec \theta, dx = \sec \theta \tan \theta d\theta, \sqrt{x^2-1} = \sqrt{\sec^2 \theta-1} = \tan \theta;$

$$\int \frac{x dx}{\sqrt{x^2-1}} = \int \frac{\sec \theta \sec \theta \tan \theta d\theta}{\tan \theta} = \int \sec^2 \theta d\theta = \tan \theta + C = \sqrt{x^2-1} + C$$

42. $x = \sin \theta, dx = \cos \theta d\theta, -\frac{\pi}{2} < \theta < \frac{\pi}{2}, \sqrt{1-x^2} = \sqrt{1-\sin^2 \theta} = \cos \theta;$

$$\int \frac{dx}{\sqrt{1-x^2}} = \int \frac{\cos \theta d\theta}{\cos \theta} = \theta + C = \sin^{-1} x + C$$

43. Let $x^2 = \tan \theta, 0 \leq \theta < \frac{\pi}{2}, 2x dx = \sec^2 \theta d\theta \Rightarrow x dx = \frac{1}{2} \sec^2 \theta d\theta; \sqrt{1+x^4} = \sqrt{1+\tan^2 \theta} = \sec \theta$

$$\int \frac{x}{\sqrt{1+x^4}} dx = \frac{1}{2} \int \frac{\sec^2 \theta d\theta}{\sec \theta} = \frac{1}{2} \int \sec \theta d\theta = \frac{1}{2} \ln |\sec \theta + \tan \theta| + C = \frac{1}{2} \ln \left| \sqrt{1+x^4} + x^2 \right| + C$$

44. Let $\ln x = \sin \theta, -\frac{\pi}{2} \leq \theta < 0$ or $0 < \theta \leq \frac{\pi}{2}, \frac{1}{x} dx = \cos \theta d\theta, \sqrt{1-(\ln x)^2} = \cos \theta$

$$\int \frac{\sqrt{1-(\ln x)^2}}{x \ln x} dx = \int \frac{\cos^2 \theta d\theta}{\sin \theta} = \int \frac{1-\sin^2 \theta}{\sin \theta} d\theta = \int \csc \theta d\theta - \int \sin \theta d\theta = -\ln |\csc \theta + \cot \theta| + \cos \theta + C$$

$$= -\ln \left| \frac{1}{\ln x} + \frac{\sqrt{1-(\ln x)^2}}{\ln x} \right| + \sqrt{1-(\ln x)^2} + C = -\ln \left| \frac{1+\sqrt{1-(\ln x)^2}}{\ln x} \right| + \sqrt{1-(\ln x)^2} + C$$

45. Let $u = \sqrt{x} \Rightarrow x = u^2 \Rightarrow dx = 2u du \Rightarrow \int \sqrt{\frac{4-x}{x}} dx = \int \sqrt{\frac{4-u^2}{u^2}} 2u du = 2 \int \sqrt{4-u^2} du;$

$$u = 2 \sin \theta, du = 2 \cos \theta d\theta, 0 < \theta \leq \frac{\pi}{2}, \sqrt{4-u^2} = 2 \cos \theta$$

$$2 \int \sqrt{4-u^2} du = 2 \int (2 \cos \theta)(2 \cos \theta) d\theta = 8 \int \cos^2 \theta d\theta = 8 \int \frac{1+\cos 2\theta}{2} d\theta = 4 \int d\theta + 4 \int \cos 2\theta d\theta$$

$$= 4\theta + 2 \sin 2\theta + C = 4\theta + 4 \sin \theta \cos \theta + C = 4 \sin^{-1} \left(\frac{u}{2} \right) + 4 \left(\frac{u}{2} \right) \left(\frac{\sqrt{4-u^2}}{2} \right) + C = 4 \sin^{-1} \left(\frac{\sqrt{x}}{2} \right) + \sqrt{x} \sqrt{4-x} + C$$

$$= 4 \sin^{-1} \left(\frac{\sqrt{x}}{2} \right) + \sqrt{4x-x^2} + C$$

46. Let $u = x^{3/2} \Rightarrow x = u^{2/3} \Rightarrow dx = \frac{2}{3} u^{-1/3} du$

$$\int \sqrt{\frac{x}{1-x^3}} dx = \int \sqrt{\frac{u^{2/3}}{1-(u^{2/3})^3}} \left(\frac{2}{3} u^{-1/3} \right) du = \int \frac{u^{1/3}}{\sqrt{1-u^2}} \left(\frac{2}{3u^{1/3}} \right) du = \frac{2}{3} \int \frac{1}{\sqrt{1-u^2}} du = \frac{2}{3} \sin^{-1} u + C = \frac{2}{3} \sin^{-1} \left(x^{3/2} \right) + C$$

47. Let $u = \sqrt{x} \Rightarrow x = u^2 \Rightarrow dx = 2u du \Rightarrow \int \sqrt{x} \sqrt{1-x} dx = \int u \sqrt{1-u^2} 2u du = 2 \int u^2 \sqrt{1-u^2} du;$

$$u = \sin \theta, du = \cos \theta d\theta, -\frac{\pi}{2} < \theta \leq \frac{\pi}{2}, \sqrt{1-u^2} = \cos \theta$$

$$2 \int u^2 \sqrt{1-u^2} du = 2 \int \sin^2 \theta \cos \theta \cos \theta d\theta = 2 \int \sin^2 \theta \cos^2 \theta d\theta = \frac{1}{2} \int \sin^2 2\theta d\theta = \frac{1}{2} \int \frac{1-\cos 4\theta}{2} d\theta$$

$$= \frac{1}{4} \int d\theta - \frac{1}{4} \int \cos 4\theta d\theta = \frac{1}{4} \theta - \frac{1}{16} \sin 4\theta + C = \frac{1}{4} \theta - \frac{1}{8} \sin 2\theta \cos 2\theta + C = \frac{1}{4} \theta - \frac{1}{4} \sin \theta \cos \theta (2 \cos^2 \theta - 1) + C$$

$$\begin{aligned}
&= \frac{1}{4}\theta - \frac{1}{2}\sin\theta\cos^3\theta + \frac{1}{4}\sin\theta\cos\theta + C = \frac{1}{4}\sin^{-1}u - \frac{1}{2}u(1-u^2)^{3/2} - \frac{1}{4}u\sqrt{1-u^2} + C \\
&= \frac{1}{4}\sin^{-1}\sqrt{x} - \frac{1}{2}\sqrt{x}(1-x)^{3/2} - \frac{1}{4}\sqrt{x}\sqrt{1-x} + C
\end{aligned}$$

48. Let $w = \sqrt{x-1} \Rightarrow w^2 = x-1 \Rightarrow 2w dw = dx \Rightarrow \int \frac{\sqrt{x-2}}{\sqrt{x-1}} dx = \int \frac{\sqrt{w^2-1}}{w} 2w dw = 2 \int \sqrt{w^2-1} dw$
 $w = \sec\theta, dx = \sec\theta \tan\theta d\theta, 0 < \theta < \frac{\pi}{2}, \sqrt{w^2-1} = \tan\theta$
 $2 \int \sqrt{w^2-1} dw = 2 \int \tan\theta \sec\theta \tan\theta d\theta; u = \tan\theta, du = \sec^2\theta d\theta, dv = \sec\theta \tan\theta d\theta, v = \sec\theta$
 $2 \int \tan\theta \sec\theta \tan\theta d\theta = 2 \sec\theta \tan\theta - 2 \int \sec^3\theta d\theta = 2 \sec\theta \tan\theta - 2 \int \sec^2\theta \sec\theta d\theta$
 $= 2 \sec\theta \tan\theta - 2 \int (\tan^2\theta + 1) \sec\theta d\theta = 2 \sec\theta \tan\theta - 2 \left(\int \tan^2\theta \sec\theta d\theta + \int \sec\theta d\theta \right)$
 $= 2 \sec\theta \tan\theta - 2 \ln|\sec\theta + \tan\theta| - 2 \int \tan^2\theta \sec\theta d\theta$
 $\Rightarrow 2 \int \tan^2\theta \sec\theta d\theta = \sec\theta \tan\theta - \ln|\sec\theta + \tan\theta| + C = w\sqrt{w^2-1} - \ln\left|w + \sqrt{w^2-1}\right| + C$
 $= \sqrt{x-1}\sqrt{x-2} - \ln|\sqrt{x-1} + \sqrt{x-2}| + C$

49. $x \frac{dy}{dx} = \sqrt{x^2-4}; dy = \sqrt{x^2-4} \frac{dx}{x}; y = \int \frac{\sqrt{x^2-4}}{x} dx;$
 $x = 2\sec\theta, 0 < \theta < \frac{\pi}{2}, dx = 2\sec\theta \tan\theta d\theta, \sqrt{x^2-4} = 2\tan\theta$
 $\rightarrow y = \int \frac{(2\tan\theta)(2\sec\theta \tan\theta d\theta)}{2\sec\theta} = 2 \int \tan^2\theta d\theta = 2 \int (\sec^2\theta - 1) d\theta = 2(\tan\theta - \theta) + C$
 $= 2 \left[\frac{\sqrt{x^2-4}}{2} - \sec^{-1}\left(\frac{x}{2}\right) \right] + C; x = 2 \text{ and } y = 0 \Rightarrow 0 = 0 + C \Rightarrow C = 0 \Rightarrow y = 2 \left[\frac{\sqrt{x^2-4}}{2} - \sec^{-1}\frac{x}{2} \right]$

50. $\sqrt{x^2-9} \frac{dy}{dx} = 1, dy = \frac{dx}{\sqrt{x^2-9}}; y = \int \frac{dx}{\sqrt{x^2-9}}; x = 3\sec\theta, 0 < \theta < \frac{\pi}{2}, dx = 3\sec\theta \tan\theta d\theta, \sqrt{x^2-9} = 3\tan\theta$
 $\rightarrow y = \int \frac{3\sec\theta \tan\theta d\theta}{3\tan\theta} = \int \sec\theta d\theta = \ln|\sec\theta + \tan\theta| + C = \ln\left|\frac{x}{3} + \frac{\sqrt{x^2-9}}{3}\right| + C; x = 5 \text{ and } y = \ln 3$
 $\Rightarrow \ln 3 = \ln 3 + C \Rightarrow C = 0 \Rightarrow y = \ln\left|\frac{x}{3} + \frac{\sqrt{x^2-9}}{3}\right|$

51. $(x^2+4) \frac{dy}{dx} = 3, dy = \frac{3dx}{x^2+4}; y = 3 \int \frac{dx}{x^2+4} = \frac{3}{2} \tan^{-1}\frac{x}{2} + C; x = 2 \text{ and } y = 0 \Rightarrow 0 = \frac{3}{2} \tan^{-1}1 + C \Rightarrow C = -\frac{3\pi}{8}$
 $\Rightarrow y = \frac{3}{2} \tan^{-1}\left(\frac{x}{2}\right) - \frac{3\pi}{8}$

52. $(x^2+1)^2 \frac{dy}{dx} = \sqrt{x^2+1}, dy = \frac{dx}{(x^2+1)^{3/2}}; x = \tan\theta, dx = \sec^2\theta d\theta, (x^2+1)^{3/2} = \sec^3\theta;$
 $y = \int \frac{\sec^2\theta d\theta}{\sec^3\theta} = \int \cos\theta d\theta = \sin\theta + C = \tan\theta \cos\theta + C = \frac{\tan\theta}{\sec\theta} + C = \frac{x}{\sqrt{x^2+1}} + C; x = 0 \text{ and } y = 1$
 $\Rightarrow 1 = 0 + C \Rightarrow C = 1 \Rightarrow y = \frac{x}{\sqrt{x^2+1}} + 1$

53. $A = \int_0^3 \frac{\sqrt{9-x^2}}{3} dx; x = 3 \sin \theta, 0 \leq \theta \leq \frac{\pi}{2}, dx = 3 \cos \theta d\theta, \sqrt{9-x^2} = \sqrt{9-9 \sin^2 \theta} = 3 \cos \theta;$

$$A = \int_0^{\pi/2} \frac{3 \cos \theta \cdot 3 \cos \theta d\theta}{3} = 3 \int_0^{\pi/2} \cos^2 \theta d\theta = \frac{3}{2} [\theta + \sin \theta \cos \theta]_0^{\pi/2} = \frac{3\pi}{4}$$

54. $\frac{x^2}{a^2} + \frac{y^2}{b^2} = 1 \Rightarrow y = \pm b \sqrt{1 - \frac{x^2}{a^2}}; A = 4 \int_0^a b \sqrt{1 - \frac{x^2}{a^2}} dx = 4b \int_0^a \sqrt{1 - \frac{x^2}{a^2}} dx$

$$\left[x = a \sin \theta, -\frac{\pi}{2} \leq \theta \leq \frac{\pi}{2}, dx = a \cos \theta d\theta, \sqrt{1 - \frac{x^2}{a^2}} = \cos \theta, x = 0 = a \sin \theta \Rightarrow \theta = 0, x = a = a \sin \theta \Rightarrow \theta = \frac{\pi}{2} \right]$$

$$4b \int_0^a \sqrt{1 - \frac{x^2}{a^2}} dx = 4b \int_0^{\pi/2} \cos \theta (a \cos \theta) d\theta = 4ab \int_0^{\pi/2} \cos^2 \theta d\theta = 4ab \int_0^{\pi/2} \frac{1 + \cos 2\theta}{2} d\theta$$

$$= 2ab \int_0^{\pi/2} d\theta + 2ab \int_0^{\pi/2} \cos 2\theta d\theta = 2ab [\theta]_0^{\pi/2} + ab [\sin 2\theta]_0^{\pi/2} = 2ab \left(\frac{\pi}{2} - 0 \right) + ab (\sin \pi - \sin 0) = \pi ab$$

55. (a) $A = \int_0^{1/2} \sin^{-1} x dx \left[u = \sin^{-1} x, du = \frac{1}{\sqrt{1-x^2}} dx, dv = dx, v = x \right]$

$$= \left[x \sin^{-1} x \right]_0^{1/2} - \int_0^{1/2} \frac{x}{\sqrt{1-x^2}} dx = \left(\frac{1}{2} \sin^{-1} \frac{1}{2} - 0 \right) + \left[\sqrt{1-x^2} \right]_0^{1/2} = \frac{\pi + 6\sqrt{3} - 12}{12}$$

(b) $M = \int_0^{1/2} \sin^{-1} x dx = \frac{\pi + 6\sqrt{3} - 12}{12};$

$$\bar{x} = \frac{1}{\frac{\pi + 6\sqrt{3} - 12}{12}} \int_0^{1/2} x \sin^{-1} x dx = \frac{12}{\pi + 6\sqrt{3} - 12} \int_0^{1/2} x \sin^{-1} x dx \left[u = \sin^{-1} x, du = \frac{1}{\sqrt{1-x^2}} dx, dv = x dx, v = \frac{1}{2} x^2 \right]$$

$$= \frac{12}{\pi + 6\sqrt{3} - 12} \left(\left[\frac{1}{2} x^2 \sin^{-1} x \right]_0^{1/2} - \frac{1}{2} \int_0^{1/2} \frac{x^2}{\sqrt{1-x^2}} dx \right)$$

$$\left[x = \sin \theta, -\frac{\pi}{2} < \theta < \frac{\pi}{2}, dx = \cos \theta d\theta, \sqrt{1-x^2} = \cos \theta, x = 0 = \sin \theta \Rightarrow \theta = 0, x = \frac{1}{2} = \sin \theta \Rightarrow \theta = \frac{\pi}{6} \right]$$

$$= \frac{12}{\pi + 6\sqrt{3} - 12} \left(\left(\frac{1}{2} \left(\frac{1}{2} \right)^2 \sin^{-1} \left(\frac{1}{2} \right) - 0 \right) - \frac{1}{2} \int_0^{\pi/6} \frac{\sin^2 \theta}{\cos \theta} \cos \theta d\theta \right) = \frac{12}{\pi + 6\sqrt{3} - 12} \left(\frac{\pi}{48} - \frac{1}{2} \int_0^{\pi/6} \sin^2 \theta d\theta \right)$$

$$= \frac{12}{\pi + 6\sqrt{3} - 12} \left(\frac{\pi}{48} - \frac{1}{2} \int_0^{\pi/6} \frac{1 - \cos 2\theta}{2} d\theta \right) = \frac{12}{\pi + 6\sqrt{3} - 12} \left(\frac{\pi}{48} - \frac{1}{4} \int_0^{\pi/6} d\theta + \frac{1}{4} \int_0^{\pi/6} \cos 2\theta d\theta \right)$$

$$= \frac{12}{\pi + 6\sqrt{3} - 12} \left(\frac{\pi}{48} + \left[-\frac{\theta}{4} + \frac{1}{8} \sin 2\theta \right]_0^{\pi/6} \right) = \frac{3\sqrt{3} - \pi}{4(\pi + 6\sqrt{3} - 12)};$$

$$\bar{y} = \frac{1}{\frac{\pi + 6\sqrt{3} - 12}{12}} \int_0^{1/2} \frac{1}{2} (\sin^{-1} x)^2 dx \left[u = (\sin^{-1} x)^2, du = \frac{2 \sin^{-1} x}{\sqrt{1-x^2}} dx, dv = dx, v = x \right]$$

$$= \frac{6}{\pi + 6\sqrt{3} - 12} \left(\left[x (\sin^{-1} x)^2 \right]_0^{1/2} - \int_0^{1/2} \frac{2x \sin^{-1} x}{\sqrt{1-x^2}} dx \right) \left[u = \sin^{-1} x, du = \frac{1}{\sqrt{1-x^2}} dx, dv = \frac{2x}{\sqrt{1-x^2}} dx, v = -2\sqrt{1-x^2} \right]$$

$$= \frac{6}{\pi + 6\sqrt{3} - 12} \left(\left(\frac{1}{2} (\sin^{-1} \left(\frac{1}{2} \right))^2 - 0 \right) + \left[2\sqrt{1-x^2} \sin^{-1} x \right]_0^{1/2} - \int_0^{1/2} \frac{2\sqrt{1-x^2}}{\sqrt{1-x^2}} dx \right)$$

$$= \frac{6}{\pi + 6\sqrt{3} - 12} \left(\frac{\pi^2}{72} + \left(2\sqrt{1 - \left(\frac{1}{2} \right)^2} \sin^{-1} \left(\frac{1}{2} \right) - 0 \right) - [2x]_0^{1/2} \right) = \frac{6}{\pi + 6\sqrt{3} - 12} \left(\frac{\pi}{72} + \frac{\pi\sqrt{3}}{6} - 1 \right) = \frac{\pi^2 + 12\pi\sqrt{3} - 72}{12(\pi + 6\sqrt{3} - 12)}$$

$$\begin{aligned}
 56. \quad V &= \int_0^1 \pi \left(\sqrt{x \tan^{-1} x} \right)^2 dx = \pi \int_0^1 x \tan^{-1} x dx \quad \left[u = \tan^{-1} x, du = \frac{1}{1+x^2} dx, dv = x dx, v = \frac{1}{2} x^2 \right] \\
 &= \pi \left(\left[\frac{1}{2} x^2 \tan^{-1} x \right]_0^1 - \frac{1}{2} \int_0^1 \frac{x^2}{1+x^2} dx \right) = \pi \left(\left(\frac{1}{2} \tan^{-1} 1 - 0 \right) - \frac{1}{2} \int_0^1 \left(1 - \frac{1}{1+x^2} \right) dx \right) = \pi \left(\frac{\pi}{8} - \frac{1}{2} \int_0^1 \left(1 - \frac{1}{1+x^2} \right) dx \right) \\
 &= \pi \left(\frac{\pi}{8} - \frac{1}{2} \int_0^1 dx + \frac{1}{2} \int_0^1 \frac{1}{1+x^2} dx \right) = \pi \left(\frac{\pi}{8} + \left[-\frac{1}{2} x + \frac{1}{2} \tan^{-1} x \right]_0^1 \right) = \pi \left(\frac{\pi}{8} + \left(-\frac{1}{2} + \frac{1}{2} \tan^{-1} 1 + 0 - 0 \right) \right) = \frac{\pi(\pi-2)}{4}
 \end{aligned}$$

$$\begin{aligned}
 57. \quad (a) \quad &\text{Integration by parts: } u = x^2, du = 2x dx, dv = x\sqrt{1-x^2} dx, v = -\frac{1}{3}(1-x^2)^{3/2} \\
 &\int x^3 \sqrt{1-x^2} dx = -\frac{1}{3} x^2 (1-x^2)^{3/2} + \frac{1}{3} \int (1-x^2)^{3/2} 2x dx = -\frac{1}{3} x^2 (1-x^2)^{3/2} - \frac{2}{15} (1-x^2)^{5/2} + C \\
 (b) \quad &\text{Substitution: } u = 1-x^2 \Rightarrow x^2 = 1-u \Rightarrow du = -2x dx \Rightarrow -\frac{1}{2} du = x dx \\
 &\int x^3 \sqrt{1-x^2} dx = \int x^2 \sqrt{1-x^2} x dx = -\frac{1}{2} \int (1-u) \sqrt{u} du = -\frac{1}{2} \int (\sqrt{u} - u^{3/2}) du = -\frac{1}{3} u^{3/2} + \frac{1}{5} u^{5/2} + C \\
 &= -\frac{1}{3} (1-x^2)^{3/2} + \frac{1}{5} (1-x^2)^{5/2} + C \\
 (c) \quad &\text{Trig substitution: } x = \sin \theta, -\frac{\pi}{2} \leq \theta \leq \frac{\pi}{2}, dx = \cos \theta d\theta, \sqrt{1-x^2} = \cos \theta \\
 &\int x^3 \sqrt{1-x^2} dx = \int \sin^3 \theta \cos \theta \cos \theta d\theta = \int \sin^2 \theta \cos^2 \theta \sin \theta d\theta = \int (1-\cos^2 \theta) \cos^2 \theta \sin \theta d\theta \\
 &= \int \cos^2 \theta \sin \theta d\theta - \int \cos^4 \theta \sin \theta d\theta = -\frac{1}{3} \cos^3 \theta + \frac{1}{5} \cos^5 \theta + C = -\frac{1}{3} (1-x^2)^{3/2} + \frac{1}{5} (1-x^2)^{5/2} + C
 \end{aligned}$$

58. (a) The slope of the line tangent to $y = f(x)$ is given by $f'(x)$. Consider the triangle whose hypotenuse is the 30 ft rope, the length of the base is x and height $h = \sqrt{900-x^2}$. The slope of the tangent line is also $-\frac{\sqrt{900-x^2}}{x}$, thus $f'(x) = -\frac{\sqrt{900-x^2}}{x}$.

$$\begin{aligned}
 (b) \quad f(x) &= \int -\frac{\sqrt{900-x^2}}{x} dx \quad \left[x = 30 \sin \theta, 0 < \theta \leq \frac{\pi}{2}, dx = 30 \cos \theta d\theta, \sqrt{900-x^2} = 30 \cos \theta \right] \\
 &= -\int \frac{30 \cos \theta}{30 \sin \theta} 30 \cos \theta d\theta = -30 \int \frac{\cos^2 \theta}{\sin \theta} d\theta = -30 \int \frac{(1-\sin^2 \theta)}{\sin \theta} d\theta = -30 \int \csc \theta d\theta + 30 \int \sin \theta d\theta \\
 &= 30 \ln |\csc \theta + \cot \theta| - 30 \cos \theta + C = 30 \ln \left| \frac{30}{x} + \frac{\sqrt{900-x^2}}{x} \right| - \sqrt{900-x^2} + C; \\
 f(30) &= 0 \Rightarrow 0 = 30 \ln \left| \frac{30}{30} + \frac{\sqrt{900-30^2}}{30} \right| - \sqrt{900-30^2} + C = C \Rightarrow f(x) = 30 \ln \left| \frac{30}{x} + \frac{\sqrt{900-x^2}}{x} \right| - \sqrt{900-x^2}
 \end{aligned}$$

8.5 INTEGRATION OF RATIONAL FUNCTIONS BY PARTIAL FRACTIONS

$$\begin{aligned}
 1. \quad \frac{5x-13}{(x-3)(x-2)} &= \frac{A}{x-3} + \frac{B}{x-2} \Rightarrow 5x-13 = A(x-2) + B(x-3) = (A+B)x - (2A+3B) \\
 \Rightarrow \left. \begin{aligned} A+B &= 5 \\ 2A+3B &= 13 \end{aligned} \right\} &\Rightarrow -B = (10-13) \Rightarrow B = 3 \Rightarrow A = 2; \text{ thus, } \frac{5x-13}{(x-3)(x-2)} = \frac{2}{x-3} + \frac{3}{x-2}
 \end{aligned}$$

2. $\frac{5x-7}{x^2-3x+2} = \frac{5x-7}{(x-2)(x-1)} = \frac{A}{x-2} + \frac{B}{x-1} \Rightarrow 5x-7 = A(x-1) + B(x-2) = (A+B)x - (A+2B)$
 $\Rightarrow \left. \begin{aligned} A+B &= 5 \\ A+2B &= 7 \end{aligned} \right\} \Rightarrow B=2 \Rightarrow A=3$; thus, $\frac{5x-7}{x^2-3x+2} = \frac{3}{x-2} + \frac{2}{x-1}$
3. $\frac{x+4}{(x+1)^2} = \frac{A}{x+1} + \frac{B}{(x+1)^2} \Rightarrow x+4 = A(x+1) + B = Ax + (A+B) \Rightarrow \left. \begin{aligned} A &= 1 \\ A+B &= 4 \end{aligned} \right\} \Rightarrow A=1 \text{ and } B=3$; thus,
 $\frac{x+4}{(x+1)^2} = \frac{1}{x+1} + \frac{3}{(x+1)^2}$
4. $\frac{2x+2}{x^2-2x+1} = \frac{2x+2}{(x-1)^2} = \frac{A}{x-1} + \frac{B}{(x-1)^2} \Rightarrow 2x+2 = A(x-1) + B = Ax + (-A+B) \Rightarrow \left. \begin{aligned} A &= 2 \\ -A+B &= 2 \end{aligned} \right\}$
 $\Rightarrow A=2 \text{ and } B=4$; thus, $\frac{2x+2}{x^2-2x+1} = \frac{2}{x-1} + \frac{4}{(x-1)^2}$
5. $\frac{z+1}{z^2(z-1)} = \frac{A}{z} + \frac{B}{z^2} + \frac{C}{z-1} \Rightarrow z+1 = Az(z-1) + B(z-1) + Cz^2 \Rightarrow z+1 = (A+C)z^2 + (-A+B)z - B \Rightarrow \left. \begin{aligned} A+C &= 0 \\ -A+B &= 1 \\ -B &= 1 \end{aligned} \right\}$
 $\Rightarrow B=-1 \Rightarrow A=-2 \Rightarrow C=2$; thus, $\frac{z+1}{z^2(z-1)} = \frac{-2}{z} + \frac{-1}{z^2} + \frac{2}{z-1}$
6. $\frac{z}{z^3-z^2-6z} = \frac{1}{z^2-z-6} = \frac{1}{(z-3)(z+2)} = \frac{A}{z-3} + \frac{B}{z+2} \Rightarrow 1 = A(z+2) + B(z-3) = (A+B)z + (2A-3B) \Rightarrow \left. \begin{aligned} A+B &= 0 \\ 2A-3B &= 1 \end{aligned} \right\}$
 $\Rightarrow -5B=1 \Rightarrow B=-\frac{1}{5} \Rightarrow A=\frac{1}{5}$; thus, $\frac{z}{z^3-z^2-6z} = \frac{\frac{1}{5}}{z-3} + \frac{-\frac{1}{5}}{z+2}$
7. $\frac{t^2+8}{t^2-5t+6} = 1 + \frac{5t+2}{t^2-5t+6}$ (after long division); $\frac{5t+2}{t^2-5t+6} = \frac{5t+2}{(t-3)(t-2)} = \frac{A}{t-3} + \frac{B}{t-2} \Rightarrow 5t+2 = A(t-2) + B(t-3)$
 $= (A+B)t + (-2A-3B) \Rightarrow \left. \begin{aligned} A+B &= 5 \\ -2A-3B &= 2 \end{aligned} \right\} \Rightarrow -B=(10+2)=12 \Rightarrow B=-12 \Rightarrow A=17$; thus,
 $\frac{t^2+8}{t^2-5t+6} = 1 + \frac{17}{t-3} + \frac{-12}{t-2}$
8. $\frac{t^4+9}{t^4+9t^2} = 1 + \frac{-9t^2+9}{t^4+9t^2} = 1 + \frac{-9t^2+9}{t^2(t^2+9)}$ (after long division); $\frac{-9t^2+9}{t^2(t^2+9)} = \frac{A}{t} + \frac{B}{t^2} + \frac{Ct+D}{t^2+9}$
 $\Rightarrow -9t^2+9 = At(t^2+9) + B(t^2+9) + (Ct+D)t^2 = (A+C)t^3 + (B+D)t^2 + 9At + 9B$
 $\Rightarrow \left. \begin{aligned} A+C &= 0 \\ B+D &= -9 \\ 9A &= 0 \\ 9B &= 9 \end{aligned} \right\} \Rightarrow A=0 \Rightarrow C=0; B=1 \Rightarrow D=-10$; thus, $\frac{t^4+9}{t^4+9t^2} = 1 + \frac{1}{t^2} + \frac{-10}{t^2+9}$
9. $\frac{1}{1-x^2} = \frac{A}{1-x} + \frac{B}{1+x} \Rightarrow 1 = A(1+x) + B(1-x)$; $x=1 \Rightarrow A=\frac{1}{2}$; $x=-1 \Rightarrow B=\frac{1}{2}$;
 $\int \frac{dx}{1-x^2} = \frac{1}{2} \int \frac{dx}{1-x} + \frac{1}{2} \int \frac{dx}{1+x} = \frac{1}{2} [\ln|1+x| - \ln|1-x|] + C$

10. $\frac{1}{x^2+2x} = \frac{A}{x} + \frac{B}{x+2} \Rightarrow 1 = A(x+2) + Bx; x=0 \Rightarrow A = \frac{1}{2}; x=-2 \Rightarrow B = -\frac{1}{2};$
 $\int \frac{dx}{x^2+2x} = \frac{1}{2} \int \frac{dx}{x} - \frac{1}{2} \int \frac{dx}{x+2} = \frac{1}{2} [\ln|x| - \ln|x+2|] + C$
11. $\frac{x+4}{x^2+5x-6} = \frac{A}{x+6} + \frac{B}{x-1} \Rightarrow x+4 = A(x-1) + B(x+6); x=1 \Rightarrow B = \frac{5}{7}; x=-6 \Rightarrow A = \frac{-2}{-7} = \frac{2}{7};$
 $\int \frac{x+4}{x^2+5x-6} dx = \frac{2}{7} \int \frac{dx}{x+6} + \frac{5}{7} \int \frac{dx}{x-1} = \frac{2}{7} \ln|x+6| + \frac{5}{7} \ln|x-1| + C = \frac{1}{7} \ln|(x+6)^2(x-1)^5| + C$
12. $\frac{2x+1}{x^2-7x+12} = \frac{A}{x-4} + \frac{B}{x-3} \Rightarrow 2x+1 = A(x-3) + B(x-4); x=3 \Rightarrow B = \frac{7}{-1} = -7; x=4 \Rightarrow A = \frac{9}{1} = 9;$
 $\int \frac{2x+1}{x^2-7x+12} dx = 9 \int \frac{dx}{x-4} - 7 \int \frac{dx}{x-3} = 9 \ln|x-4| - 7 \ln|x-3| + C = \ln \left| \frac{(x-4)^9}{(x-3)^7} \right| + C$
13. $\frac{y}{y^2-2y-3} = \frac{A}{y-3} + \frac{B}{y+1} \Rightarrow y = A(y+1) + B(y-3); y=-1 \Rightarrow B = \frac{-1}{-4} = \frac{1}{4}; y=3 \Rightarrow A = \frac{3}{4};$
 $\int_4^8 \frac{y dy}{y^2-2y-3} = \frac{3}{4} \int_4^8 \frac{dy}{y-3} + \frac{1}{4} \int_4^8 \frac{dy}{y+1} = \left[\frac{3}{4} \ln|y-3| + \frac{1}{4} \ln|y+1| \right]_4^8 = \left(\frac{3}{4} \ln 5 + \frac{1}{4} \ln 9 \right) - \left(\frac{3}{4} \ln 1 + \frac{1}{4} \ln 5 \right)$
 $= \frac{1}{2} \ln 5 + \frac{1}{2} \ln 3 = \frac{\ln 15}{2}$
14. $\frac{y+4}{y^2+y} = \frac{A}{y} + \frac{B}{y+1} \Rightarrow y+4 = A(y+1) + By; y=0 \Rightarrow A = 4; y=-1 \Rightarrow B = \frac{3}{-1} = -3;$
 $\int_{1/2}^1 \frac{y+4}{y^2+y} dy = 4 \int_{1/2}^1 \frac{dy}{y} - 3 \int_{1/2}^1 \frac{dy}{y+1} = [4 \ln|y| - 3 \ln|y+1|]_{1/2}^1 = (4 \ln 1 - 3 \ln 2) - (4 \ln \frac{1}{2} - 3 \ln \frac{3}{2})$
 $= \ln \frac{1}{8} - \ln \frac{1}{16} + \ln \frac{27}{8} = \ln \left(\frac{27}{8} \cdot \frac{1}{8} \cdot 16 \right) = \ln \frac{27}{4}$
15. $\frac{1}{t^3+t^2-2t} = \frac{A}{t} + \frac{B}{t+2} + \frac{C}{t-1} \Rightarrow 1 = A(t+2)(t-1) + Bt(t-1) + Ct(t+2); t=0 \Rightarrow A = -\frac{1}{2}; t=-2 \Rightarrow B = \frac{1}{6};$
 $t=1 \Rightarrow C = \frac{1}{3}; \int \frac{dt}{t^3+t^2-2t} = -\frac{1}{2} \int \frac{dt}{t} + \frac{1}{6} \int \frac{dt}{t+2} + \frac{1}{3} \int \frac{dt}{t-1} = -\frac{1}{2} \ln|t| + \frac{1}{6} \ln|t+2| + \frac{1}{3} \ln|t-1| + C$
16. $\frac{x+3}{2x^3-8x} = \frac{A}{x} + \frac{B}{x+2} + \frac{C}{x-2} \Rightarrow \frac{1}{2}(x+3) = A(x+2)(x-2) + Bx(x-2) + Cx(x+2); x=0 \Rightarrow A = \frac{3}{-8}; x=-2 \Rightarrow B = \frac{1}{16};$
 $x=2 \Rightarrow C = \frac{5}{16}; \int \frac{x+3}{2x^3-8x} dx = -\frac{3}{8} \int \frac{dx}{x} + \frac{1}{16} \int \frac{dx}{x+2} + \frac{5}{16} \int \frac{dx}{x-2} = -\frac{3}{8} \ln|x| + \frac{1}{16} \ln|x+2| + \frac{5}{16} \ln|x-2| + C$
 $= \frac{1}{16} \ln \left| \frac{(x-2)^5(x+2)}{x^6} \right| + C$
17. $\frac{x^3}{x^2+2x+1} = (x-2) + \frac{3x+2}{(x+1)^2}$ (after long division); $\frac{3x+2}{(x+1)^2} = \frac{A}{x+1} + \frac{B}{(x+1)^2} \Rightarrow 3x+2 = A(x+1) + B = Ax + (A+B)$
 $\Rightarrow A=3, A+B=2 \Rightarrow A=3, B=-1; \int_0^1 \frac{x^3 dx}{x^2+2x+1} = \int_0^1 (x-2) dx + 3 \int_0^1 \frac{dx}{x+1} - \int_0^1 \frac{dx}{(x+1)^2}$
 $= \left[\frac{x^2}{2} - 2x + 3 \ln|x+1| + \frac{1}{x+1} \right]_0^1 = \left(\frac{1}{2} - 2 + 3 \ln 2 + \frac{1}{2} \right) - (1) = 3 \ln 2 - 2$

$$18. \frac{x^3}{x^2-2x+1} = (x+2) + \frac{3x-2}{(x-1)^2} \text{ (after long division); } \frac{3x-2}{(x-1)^2} = \frac{A}{x-1} + \frac{B}{(x-1)^2} \Rightarrow 3x-2 = A(x-1) + B = Ax + (-A+B)$$

$$\Rightarrow A = 3, -A + B = -2 \Rightarrow A = 3, B = 1; \int_{-1}^0 \frac{x^3 dx}{x^2-2x+1} = \int_{-1}^0 (x+2) dx + 3 \int_{-1}^0 \frac{dx}{x-1} + \int_{-1}^0 \frac{dx}{(x-1)^2}$$

$$= \left[\frac{x^2}{2} + 2x + 3 \ln|x-1| - \frac{1}{x-1} \right]_{-1}^0 = \left(0 + 0 + 3 \ln 1 - \frac{1}{(-1)} \right) - \left(\frac{1}{2} - 2 + 3 \ln 2 - \frac{1}{(-2)} \right) = 2 - 3 \ln 2$$

$$19. \frac{1}{(x^2-1)^2} = \frac{A}{x+1} + \frac{B}{x-1} + \frac{C}{(x+1)^2} + \frac{D}{(x-1)^2} \Rightarrow 1 = A(x+1)(x-1)^2 + B(x-1)(x+1)^2 + C(x-1)^2 + D(x+1)^2;$$

$$x = -1 \Rightarrow C = \frac{1}{4}; \quad x = 1 \Rightarrow D = \frac{1}{4}; \quad \text{coefficient of } x^3 = A + B \Rightarrow A + B = 0; \quad \text{constant} = A - B + C + D$$

$$\Rightarrow A - B + C + D = 1 \Rightarrow A - B = \frac{1}{2}; \quad \text{thus, } A = \frac{1}{4} \Rightarrow B = -\frac{1}{4};$$

$$\int \frac{dx}{(x^2-1)^2} = \frac{1}{4} \int \frac{dx}{x+1} - \frac{1}{4} \int \frac{dx}{x-1} + \frac{1}{4} \int \frac{dx}{(x+1)^2} + \frac{1}{4} \int \frac{dx}{(x-1)^2} = \frac{1}{4} \ln \left| \frac{x+1}{x-1} \right| - \frac{x}{2(x^2-1)} + C$$

$$20. \frac{x^2}{(x-1)(x^2+2x+1)} = \frac{A}{x-1} + \frac{B}{x+1} + \frac{C}{(x+1)^2} \Rightarrow x^2 = A(x+1)^2 + B(x-1)(x+1) + C(x-1); \quad x = -1 \Rightarrow C = -\frac{1}{2};$$

$$x = 1 \Rightarrow A = \frac{1}{4}; \quad \text{coefficient of } x^2 = A + B \Rightarrow A + B = 1 \Rightarrow B = \frac{3}{4}; \quad \int \frac{x^2 dx}{(x-1)(x^2+2x+1)}$$

$$= \frac{1}{4} \int \frac{dx}{x-1} + \frac{3}{4} \int \frac{dx}{x+1} - \frac{1}{2} \int \frac{dx}{(x+1)^2} = \frac{1}{4} \ln|x-1| + \frac{3}{4} \ln|x+1| + \frac{1}{2(x+1)} + C = \frac{\ln|(x-1)(x+1)^3|}{4} + \frac{1}{2(x+1)} + C$$

$$21. \frac{1}{(x+1)(x^2+1)} = \frac{A}{x+1} + \frac{Bx+C}{x^2+1} \Rightarrow 1 = A(x^2+1) + (Bx+C)(x+1); \quad x = -1 \Rightarrow A = \frac{1}{2}; \quad \text{coefficient of } x^2 = A + B$$

$$\Rightarrow A + B = 0 \Rightarrow B = -\frac{1}{2}; \quad \text{constant} = A + C \Rightarrow A + C = 1 \Rightarrow C = \frac{1}{2}; \quad \int_0^1 \frac{dx}{(x+1)(x^2+1)} = \frac{1}{2} \int_0^1 \frac{dx}{x+1} + \frac{1}{2} \int_0^1 \frac{(-x+1)}{x^2+1} dx$$

$$= \left[\frac{1}{2} \ln|x+1| - \frac{1}{4} \ln(x^2+1) + \frac{1}{2} \tan^{-1} x \right]_0^1 = \left(\frac{1}{2} \ln 2 - \frac{1}{4} \ln 2 + \frac{1}{2} \tan^{-1} 1 \right) - \left(\frac{1}{2} \ln 1 - \frac{1}{4} \ln 1 + \frac{1}{2} \tan^{-1} 0 \right)$$

$$= \frac{1}{4} \ln 2 + \frac{1}{2} \left(\frac{\pi}{4} \right) = \frac{(\pi + 2 \ln 2)}{8}$$

$$22. \frac{3t^2+t+4}{t^3+t} = \frac{A}{t} + \frac{Bt+C}{t^2+1} \Rightarrow 3t^2+t+4 = A(t^2+1) + (Bt+C)t; \quad t = 0 \Rightarrow A = 4; \quad \text{coefficient of } t^2 = A + B \Rightarrow A + B = 3$$

$$\Rightarrow B = -1; \quad \text{coefficient of } t = C \Rightarrow C = 1; \quad \int_1^{\sqrt{3}} \frac{3t^2+t+4}{t^3+t} dt = 4 \int_1^{\sqrt{3}} \frac{dt}{t} + \int_1^{\sqrt{3}} \frac{(-t+1)}{t^2+1} dt$$

$$= \left[4 \ln|t| - \frac{1}{2} \ln(t^2+1) + \tan^{-1} t \right]_1^{\sqrt{3}} = \left(4 \ln \sqrt{3} - \frac{1}{2} \ln 4 + \tan^{-1} \sqrt{3} \right) - \left(4 \ln 1 - \frac{1}{2} \ln 2 + \tan^{-1} 1 \right)$$

$$= 2 \ln 3 - \ln 2 + \frac{\pi}{3} + \frac{1}{2} \ln 2 - \frac{\pi}{4} = 2 \ln 3 - \frac{1}{2} \ln 2 + \frac{\pi}{12} = \ln \left(\frac{9}{\sqrt{2}} \right) + \frac{\pi}{12}$$

$$23. \frac{y^2+2y+1}{(y^2+1)^2} = \frac{Ay+B}{y^2+1} + \frac{Cy+D}{(y^2+1)^2} \Rightarrow y^2+2y+1 = (Ay+B)(y^2+1) + Cy+D = Ay^3 + By^2 + (A+C)y + (B+D)$$

$$\Rightarrow A = 0, B = 1; \quad A + C = 2 \Rightarrow C = 2; \quad B + D = 1 \Rightarrow D = 0; \quad \int \frac{y^2+2y+1}{(y^2+1)^2} dy = \int \frac{1}{y^2+1} dy + 2 \int \frac{y}{(y^2+1)^2} dy$$

$$= \tan^{-1} y - \frac{1}{y^2+1} + C$$

$$24. \frac{8x^2+8x+2}{(4x^2+1)^2} = \frac{Ax+B}{4x^2+1} + \frac{Cx+D}{(4x^2+1)^2} \Rightarrow 8x^2+8x+2 = (Ax+B)(4x^2+1) + Cx+D = 4Ax^3+4Bx^2+(A+C)x+(B+D);$$

$$A=0, B=2; A+C=8 \Rightarrow C=8; B+D=2 \Rightarrow D=0; \int \frac{8x^2+8x+2}{(4x^2+1)^2} dx = 2 \int \frac{dx}{4x^2+1} + 8 \int \frac{x dx}{(4x^2+1)^2}$$

$$= \tan^{-1} 2x - \frac{1}{4x^2+1} + C$$

$$25. \frac{2s+2}{(s^2+1)(s-1)^3} = \frac{As+B}{s^2+1} + \frac{C}{s-1} + \frac{D}{(s-1)^2} + \frac{E}{(s-1)^3}$$

$$\Rightarrow 2s+2 = (As+B)(s-1)^3 + C(s^2+1)(s-1)^2 + D(s^2+1)(s-1) + E(s^2+1)$$

$$= As^4 + (-3A+B)s^3 + (3A-3B)s^2 + (-A+3B)s - B + C(s^4-2s^3+2s^2-2s+1) + D(s^3-s^2+s-1) + E(s^2+1)$$

$$= (A+C)s^4 + (-3A+B-2C+D)s^3 + (3A-3B+2C-D+E)s^2 + (-A+3B-2C+D)s + (-B+C-D+E)$$

$$\left. \begin{array}{l} A+C=0 \\ -3A+B-2C+D=0 \\ \Rightarrow 3A-3B+2C-D+E=0 \\ -A+3B-2C+D=2 \\ -B+C-D+E=2 \end{array} \right\} \text{ summing all equations } \Rightarrow 2E=4 \Rightarrow E=2;$$

summing eqs (2) and (3) $\Rightarrow -2B+2=0 \Rightarrow B=1$; summing eqs (3) and (4) $\Rightarrow 2A+2=2 \Rightarrow A=0$;

$C=0$ from eq (1); then $-1+0-D+2=2$ from eq (5) $\Rightarrow D=-1$;

$$\int \frac{2s+2}{(s^2+1)(s-1)^3} ds = \int \frac{ds}{s^2+1} - \int \frac{ds}{(s-1)^2} + 2 \int \frac{ds}{(s-1)^3} = -(s-1)^{-2} + (s-1)^{-1} + \tan^{-1} s + C$$

$$26. \frac{s^4+81}{s(s^2+9)^2} = \frac{A}{s} + \frac{Bs+C}{s^2+9} + \frac{Ds+E}{(s^2+9)^2} \Rightarrow s^4+81 = A(s^2+9)^2 + (Bs+C)s(s^2+9) + (Ds+E)s$$

$$= A(s^4+18s^2+81) + (Bs^4+Cs^3+9Bs^2+9Cs) + Ds^2+Es$$

$$= (A+B)s^4 + Cs^3 + (18A+9B+D)s^2 + (9C+E)s + 81A \Rightarrow 81A=81 \text{ or } A=1; A+B=1 \Rightarrow B=0; C=0;$$

$$9C+E=0 \Rightarrow E=0; 18A+9B+D=0 \Rightarrow D=-18; \int \frac{s^4+81}{s(s^2+9)^2} ds = \int \frac{ds}{s} - 18 \int \frac{s ds}{(s^2+9)^2} = \ln |s| + \frac{9}{s^2+9} + C$$

$$27. \frac{x^2-x+2}{x^3-1} = \frac{A}{x-1} + \frac{Bx+C}{x^2+x+1} \Rightarrow x^2-x+2 = A(x^2+x+1) + (Bx+C)(x-1) = (A+B)x^2 + (A-B+C)x + (A-C)$$

$$\Rightarrow A+B=1, A-B+C=-1, A-C=2 \Rightarrow \text{adding eq(2) and eq(3)} \Rightarrow 2A-B=1, \text{ add this equation to eq (1)}$$

$$\Rightarrow 3A=2 \Rightarrow A=\frac{2}{3} \Rightarrow B=1-A=\frac{1}{3} \Rightarrow C=-1-A+B=-\frac{4}{3}; \int \frac{x^2-x+2}{x^3-1} dx = \int \left(\frac{2/3}{x-1} + \frac{(1/3)x-4/3}{x^2+x+1} \right) dx$$

$$= \frac{2}{3} \int \frac{1}{x-1} dx + \frac{1}{3} \int \frac{x-4}{(x+\frac{1}{2})^2 + \frac{3}{4}} dx \left[u = x + \frac{1}{2} \Rightarrow u - \frac{1}{2} = x \Rightarrow du = dx \right]$$

$$= \frac{2}{3} \int \frac{1}{x-1} dx + \frac{1}{3} \int \frac{u-\frac{9}{2}}{u^2+\frac{3}{4}} du = \frac{2}{3} \int \frac{1}{x-1} dx + \frac{1}{3} \int \frac{u}{u^2+\frac{3}{4}} du - \frac{3}{2} \int \frac{1}{u^2+\frac{3}{4}} du$$

$$= \frac{2}{3} \ln|x-1| + \frac{1}{6} \ln \left| \left(x + \frac{1}{2}\right)^2 + \frac{3}{4} \right| - \frac{3}{\sqrt{3}} \tan^{-1} \left(\frac{x+\frac{1}{2}}{\sqrt{3}/2} \right) + C = \frac{2}{3} \ln|x-1| + \frac{1}{6} \ln|x^2+x+1| - \sqrt{3} \tan^{-1} \left(\frac{2x+1}{\sqrt{3}} \right) + C$$

28. $\frac{1}{x^4+x} = \frac{A}{x} + \frac{B}{x+1} + \frac{Cx+D}{x^2-x+1} \Rightarrow 1 = A(x+1)(x^2-x+1) + Bx(x^2-x+1) + (Cx+D)x(x+1)$
 $= (A+B+C)x^3 + (-B+C+D)x^2 + (B+D)x + A \Rightarrow A=1, B+D=0 \Rightarrow D=-B, -B+C+D=0$
 $\Rightarrow -2B+C=0 \Rightarrow C=2B, A+B+C=0 \Rightarrow 1+B+2B=0 \Rightarrow B=-\frac{1}{3} \Rightarrow C=-\frac{2}{3} \Rightarrow D=\frac{1}{3};$
 $\int \frac{1}{x^4+x} dx = \int \left(\frac{1}{x} - \frac{1/3}{x+1} + \frac{(-2/3)x+1/3}{x^2-x+1} \right) dx = \int \frac{1}{x} dx - \frac{1}{3} \int \frac{1}{x+1} dx - \frac{1}{3} \int \frac{2x-1}{x^2-x+1} dx$
 $= \ln|x| - \frac{1}{3} \ln|x+1| - \frac{1}{3} \ln|x^2-x+1| + C$
29. $\frac{x^2}{x^4-1} = \frac{A}{x+1} + \frac{B}{x-1} + \frac{Cx+D}{x^2+1} \Rightarrow x^2 = A(x-1)(x^2+1) + B(x+1)(x^2+1) + (Cx+D)(x-1)(x+1)$
 $= (A+B+C)x^3 + (-A+B+D)x^2 + (A+B-C)x - A+B-D \Rightarrow A+B+C=0, -A+B+D=1,$
 $A+B-C=0, -A+B-D=0 \Rightarrow$ adding eq (1) to eq (3) gives $2A+2B=0$, adding eq (2) to eq (4) gives
 $-2A+2B=1$, adding these two equations gives $4B=1 \Rightarrow B=\frac{1}{4}$, using $2A+2B=0 \Rightarrow A=-\frac{1}{4}$, using
 $-A+B-D=0 \Rightarrow D=\frac{1}{2}$, and using $A+B-C=0 \Rightarrow C=0; \int \frac{x^2}{x^4-1} dx = \int \left(\frac{-1/4}{x+1} + \frac{1/4}{x-1} + \frac{1/2}{x^2+1} \right) dx$
 $= -\frac{1}{4} \int \frac{1}{x+1} dx + \frac{1}{4} \int \frac{1}{x-1} dx + \frac{1}{2} \int \frac{1}{x^2+1} dx = -\frac{1}{4} \ln|x+1| + \frac{1}{4} \ln|x-1| + \frac{1}{2} \tan^{-1} x + C = \frac{1}{4} \ln \left| \frac{x-1}{x+1} \right| + \frac{1}{2} \tan^{-1} x + C$
30. $\frac{x^2+x}{x^4-3x^2-4} = \frac{A}{x-2} + \frac{B}{x+2} + \frac{Cx+D}{x^2+1} \Rightarrow x^2+x = A(x+2)(x^2+1) + B(x-2)(x^2+1) + (Cx+D)(x-2)(x+2)$
 $= (A+B+C)x^3 + (2A-2B+D)x^2 + (A+B-4C)x + 2A-2B-4D \Rightarrow A+B+C=0, 2A-2B+D=1,$
 $A+B-4C=1, 2A-2B-4D=0 \Rightarrow$ subtracting eq (1) from eq (3) gives $-5C=1 \Rightarrow C=-\frac{1}{5}$, subtracting
eq (2) from eq (4) gives $-5D=-1 \Rightarrow D=\frac{1}{5}$, substituting for C in eq (1) gives $A+B=\frac{1}{5}$, and substituting
for D in eq (4) gives $2A-2B=\frac{4}{5} \Rightarrow A-B=\frac{2}{5}$, adding this equation to the previous equation gives
 $2A=\frac{3}{5} \Rightarrow A=\frac{3}{10} \Rightarrow B=-\frac{1}{10}; \int \frac{x^2+x}{x^4-3x^2-4} dx = \int \left(\frac{3/10}{x-2} - \frac{1/10}{x+2} + \frac{(-1/5)x+1/5}{x^2+1} \right) dx$
 $= \frac{3}{10} \int \frac{1}{x-2} dx - \frac{1}{10} \int \frac{1}{x+2} dx - \frac{1}{5} \int \frac{x}{x^2+1} dx + \frac{1}{5} \int \frac{1}{x^2+1} dx = \frac{3}{10} \ln|x-2| - \frac{1}{10} \ln|x+2| - \frac{1}{10} \ln|x^2+1| + \frac{1}{5} \tan^{-1} x + C$
31. $\frac{2\theta^3+5\theta^2+8\theta+4}{(\theta^2+2\theta+2)^2} = \frac{A\theta+B}{\theta^2+2\theta+2} + \frac{C\theta+D}{(\theta^2+2\theta+2)^2} \Rightarrow 2\theta^3+5\theta^2+8\theta+4 = (A\theta+B)(\theta^2+2\theta+2) + C\theta+D$
 $= A\theta^3 + (2A+B)\theta^2 + (2A+2B+C)\theta + (2B+D) \Rightarrow A=2; 2A+B=5 \Rightarrow B=1; 2A+2B+C=8 \Rightarrow C=2;$
 $2B+D=4 \Rightarrow D=2; \int \frac{2\theta^3+5\theta^2+8\theta+4}{(\theta^2+2\theta+2)^2} d\theta = \int \frac{2\theta+1}{\theta^2+2\theta+2} d\theta + \int \frac{2\theta+2}{(\theta^2+2\theta+2)^2} d\theta$
 $= \int \frac{(2\theta+2)d\theta}{\theta^2+2\theta+2} - \int \frac{d\theta}{\theta^2+2\theta+2} + \int \frac{(2\theta+2)d\theta}{(\theta^2+2\theta+2)^2} = \ln(\theta^2+2\theta+2) - \int \frac{d\theta}{(\theta+1)^2+1} - \frac{1}{\theta^2+2\theta+2}$
 $= \ln(\theta^2+2\theta+2) - \tan^{-1}(\theta+1) - \frac{1}{\theta^2+2\theta+2} + C$
32. $\frac{\theta^4-4\theta^3+2\theta^2-3\theta+1}{(\theta^2+1)^3} = \frac{A\theta+B}{\theta^2+1} + \frac{C\theta+D}{(\theta^2+1)^2} + \frac{E\theta+F}{(\theta^2+1)^3}$
 $\Rightarrow \theta^4-4\theta^3+2\theta^2-3\theta+1 = (A\theta+B)(\theta^2+1)^2 + (C\theta+D)(\theta^2+1) + E\theta+F$
 $= (A\theta+B)(\theta^4+2\theta^2+1) + (C\theta^3+D\theta^2+C\theta+D) + E\theta+F$

$$\begin{aligned}
&= (A\theta^5 + B\theta^4 + 2A\theta^3 + 2B\theta^2 + A\theta + B) + (C\theta^3 + D\theta^2 + C\theta + D) + E\theta + F \\
&= A\theta^5 + B\theta^4 + (2A+C)\theta^3 + (2B+D)\theta^2 + (A+C+E)\theta + (B+D+F) \Rightarrow A=0; B=1; \\
&2A+C=-4 \Rightarrow C=-4; 2B+D=2 \Rightarrow D=0; A+C+E=-3 \Rightarrow E=1; B+D+F=1 \Rightarrow F=0; \\
&\int \frac{\theta^4 - 4\theta^3 + 2\theta^2 - 3\theta + 1}{(\theta^2 + 1)^3} d\theta = \int \frac{d\theta}{\theta^2 + 1} - 4 \int \frac{\theta d\theta}{(\theta^2 + 1)^2} + \int \frac{\theta d\theta}{(\theta^2 + 1)^3} = \tan^{-1} \theta + 2(\theta^2 + 1)^{-1} - \frac{1}{4}(\theta^2 + 1)^{-2} + C
\end{aligned}$$

$$33. \frac{2x^3 - 2x^2 + 1}{x^2 - x} = 2x + \frac{1}{x^2 - x} = 2x + \frac{1}{x(x-1)}; \frac{1}{x(x-1)} = \frac{A}{x} + \frac{B}{x-1} \Rightarrow 1 = A(x-1) + Bx; x=0 \Rightarrow A=-1; x=1 \Rightarrow B=1;$$

$$\int \frac{2x^3 - 2x^2 + 1}{x^2 - x} = \int 2x dx - \int \frac{dx}{x} + \int \frac{dx}{x-1} = x^2 - \ln|x| + \ln|x-1| + C = x^2 + \ln\left|\frac{x-1}{x}\right| + C$$

$$34. \frac{x^4}{x^2 - 1} = (x^2 + 1) + \frac{1}{x^2 - 1} = (x^2 + 1) + \frac{1}{(x+1)(x-1)}; \frac{1}{(x+1)(x-1)} = \frac{A}{x+1} + \frac{B}{x-1} \Rightarrow 1 = A(x-1) + B(x+1);$$

$$\begin{aligned}
x=-1 \Rightarrow A=-\frac{1}{2}; x=1 \Rightarrow B=\frac{1}{2}; \int \frac{x^4}{x^2 - 1} dx &= \int (x^2 + 1) dx - \frac{1}{2} \int \frac{dx}{x+1} + \frac{1}{2} \int \frac{dx}{x-1} \\
&= \frac{1}{3}x^3 + x - \frac{1}{2} \ln|x+1| + \frac{1}{2} \ln|x-1| + C = \frac{x^3}{3} + x + \frac{1}{2} \ln\left|\frac{x-1}{x+1}\right| + C
\end{aligned}$$

$$35. \frac{9x^3 - 3x + 1}{x^3 - x^2} = 9 + \frac{9x^2 - 3x + 1}{x^2(x-1)} \text{ (after long division); } \frac{9x^2 - 3x + 1}{x^2(x-1)} = \frac{A}{x} + \frac{B}{x^2} + \frac{C}{x-1}$$

$$\Rightarrow 9x^2 - 3x + 1 = Ax(x-1) + B(x-1) + Cx^2; x=1 \Rightarrow C=7; x=0 \Rightarrow B=-1; A+C=9 \Rightarrow A=2;$$

$$\int \frac{9x^3 - 3x + 1}{x^3 - x^2} dx = \int 9 dx + 2 \int \frac{dx}{x} - \int \frac{dx}{x^2} + 7 \int \frac{dx}{x-1} = 9x + 2 \ln|x| + \frac{1}{x} + 7 \ln|x-1| + C$$

$$36. \frac{16x^3}{4x^2 - 4x + 1} = (4x + 4) + \frac{12x - 4}{4x^2 - 4x + 1}; \frac{12x - 4}{(2x-1)^2} = \frac{A}{2x-1} + \frac{B}{(2x-1)^2} \Rightarrow 12x - 4 = A(2x-1) + B$$

$$\begin{aligned}
\Rightarrow A=6; -A+B=-4 \Rightarrow B=2; \int \frac{16x^3}{4x^2 - 4x + 1} dx &= 4 \int (x+1) dx + 6 \int \frac{dx}{2x-1} + 2 \int \frac{dx}{(2x-1)^2} \\
&= 2(x+1)^2 + 3 \ln|2x-1| - \frac{1}{2x-1} + C_1 = 2x^2 + 4x + 3 \ln|2x-1| - (2x-1)^{-1} + C, \text{ where } C = 2 + C_1
\end{aligned}$$

$$37. \frac{y^4 + y^2 - 1}{y^3 + y} = y - \frac{1}{y(y^2 + 1)}; \frac{1}{y(y^2 + 1)} = \frac{A}{y} + \frac{By + C}{y^2 + 1} \Rightarrow 1 = A(y^2 + 1) + (By + C)y = (A+B)y^2 + Cy + A$$

$$\Rightarrow A=1; A+B=0 \Rightarrow B=-1; C=0; \int \frac{y^4 + y^2 - 1}{y^3 + y} dy = \int y dy - \int \frac{dy}{y} + \int \frac{y dy}{y^2 + 1} = \frac{y^2}{2} - \ln|y| + \frac{1}{2} \ln(1 + y^2) + C$$

$$38. \frac{2y^4}{y^3 - y^2 + y - 1} = 2y + 2 + \frac{2}{y^3 - y^2 + y - 1}; \frac{2}{y^3 - y^2 + y - 1} = \frac{2}{(y^2 + 1)(y - 1)} = \frac{A}{y-1} + \frac{By + C}{y^2 + 1}$$

$$\begin{aligned}
\Rightarrow 2 &= A(y^2 + 1) + (By + C)(y - 1) = (Ay^2 + A) + (By^2 + Cy - By - C) = (A+B)y^2 + (-B+C)y + (A-C) \\
\Rightarrow A+B &= 0, -B+C=0 \text{ or } C=B, A-C=A-B=2 \Rightarrow A=1, B=-1, C=-1;
\end{aligned}$$

$$\begin{aligned}
\int \frac{2y^4}{y^3 - y^2 + y - 1} dy &= 2 \int (y+1) dy + \int \frac{dy}{y-1} - \int \frac{y}{y^2 + 1} dy - \int \frac{dy}{y^2 + 1} = (y+1)^2 + \ln|y-1| - \frac{1}{2} \ln(y^2 + 1) - \tan^{-1} y + C_1 \\
&= y^2 + 2y + \ln|y-1| - \frac{1}{2} \ln(y^2 + 1) - \tan^{-1} y + C, \text{ where } C = C_1 + 1
\end{aligned}$$

$$39. \int \frac{e^t dt}{e^{2t} + 3e^t + 2}; [e^t = y, e^t dt = dy] \rightarrow \int \frac{dy}{y^2 + 3y + 2} = \int \frac{dy}{y+1} - \int \frac{dy}{y+2} = \ln\left|\frac{y+1}{y+2}\right| + C = \ln\left(\frac{e^t + 1}{e^t + 2}\right) + C$$

$$40. \int \frac{e^{4t} + 2e^{2t} - e^t}{e^{2t} + 1} dt = \int \frac{e^{3t} + 2e^t - 1}{e^{2t} + 1} e^t dt; [y = e^t, dy = e^t dt] \rightarrow \int \frac{y^3 + 2y - 1}{y^2 + 1} dy = \int \left(y + \frac{y-1}{y^2+1} \right) dy = \frac{y^2}{2} + \int \frac{y}{y^2+1} dy - \int \frac{dy}{y^2+1}$$

$$= \frac{y^2}{2} + \frac{1}{2} \ln(y^2 + 1) - \tan^{-1} y + C = \frac{1}{2} e^{2t} + \frac{1}{2} \ln(e^{2t} + 1) - \tan^{-1}(e^t) + C$$

$$41. \int \frac{\cos y dy}{\sin^2 y + \sin y - 6}; [\sin y = t, \cos y dy = dt] \rightarrow \int \frac{dt}{t^2 + t - 6} = \frac{1}{5} \int \left(\frac{1}{t-2} - \frac{1}{t+3} \right) dt = \frac{1}{5} \ln \left| \frac{t-2}{t+3} \right| + C = \frac{1}{5} \ln \left| \frac{\sin y - 2}{\sin y + 3} \right| + C$$

$$42. \int \frac{\sin \theta d\theta}{\cos^2 \theta + \cos \theta - 2}; [\cos \theta = y, -\sin \theta d\theta = dy] \rightarrow -\int \frac{dy}{y^2 + y - 2} = \frac{1}{3} \int \frac{dy}{y+2} - \frac{1}{3} \int \frac{dy}{y-1} = \frac{1}{3} \ln \left| \frac{y+2}{y-1} \right| + C = \frac{1}{3} \ln \left| \frac{\cos \theta + 2}{\cos \theta - 1} \right| + C$$

$$= -\frac{1}{3} \ln \left| \frac{\cos \theta - 1}{\cos \theta + 2} \right| + C$$

$$43. \int \frac{(x-2)^2 \tan^{-1}(2x) - 12x^3 - 3x}{(4x^2+1)(x-2)^2} dx = \int \frac{\tan^{-1}(2x)}{4x^2+1} dx - 3 \int \frac{x}{(x-2)^2} dx = \frac{1}{2} \int \tan^{-1}(2x) \frac{2dx}{4x^2+1} - 3 \int \frac{dx}{x-2} - 6 \int \frac{dx}{(x-2)^2}$$

$$= \frac{1}{4} (\tan^{-1} 2x)^2 - 3 \ln |x-2| + \frac{6}{x-2} + C$$

$$44. \int \frac{(x+1)^2 \tan^{-1}(3x) + 9x^3 + x}{(9x^2+1)(x+1)^2} dx = \int \frac{\tan^{-1}(3x)}{9x^2+1} dx + \int \frac{x}{(x+1)^2} dx = \frac{1}{3} \int \tan^{-1}(3x) \frac{3dx}{9x^2+1} + \int \frac{dx}{x+1} - \int \frac{dx}{(x+1)^2}$$

$$= \frac{1}{6} (\tan^{-1} 3x)^2 + \ln |x+1| + \frac{1}{x+1} + C$$

$$45. \int \frac{1}{x^{3/2} - \sqrt{x}} dx = \int \frac{1}{\sqrt{x}(x-1)} dx; \left[\text{Let } u = \sqrt{x} \Rightarrow du = \frac{1}{2\sqrt{x}} dx \Rightarrow 2du = \frac{1}{\sqrt{x}} dx \right] \rightarrow \int \frac{2}{u^2-1} du;$$

$$\frac{2}{u^2-1} = \frac{A}{u+1} + \frac{B}{u-1} \Rightarrow 2 = A(u-1) + B(u+1) = (A+B)u - A + B \Rightarrow A+B=0, -A+B=2 \Rightarrow B=1 \Rightarrow A=-1;$$

$$\int \frac{2}{u^2-1} du = \int \left(\frac{-1}{u+1} + \frac{1}{u-1} \right) du = -\int \frac{1}{u+1} du + \int \frac{1}{u-1} du = -\ln |u+1| + \ln |u-1| + C = \ln \left| \frac{\sqrt{x}-1}{\sqrt{x}+1} \right| + C$$

$$46. \int \frac{1}{(x^{1/3}-1)\sqrt{x}} dx; [\text{Let } x = u^6 \Rightarrow dx = 6u^5 du] \rightarrow \int \frac{1}{(u^2-1)u^3} 6u^5 du = \int \frac{6u^2}{u^2-1} du = \int \left(6 + \frac{6}{u^2-1} \right) du = 6 \int du + \int \frac{6}{u^2-1} du;$$

$$\frac{6}{u^2-1} = \frac{A}{u+1} + \frac{B}{u-1} \Rightarrow 6 = A(u-1) + B(u+1) = (A+B)u - A + B \Rightarrow A+B=0, -A+B=6 \Rightarrow B=3 \Rightarrow A=-3;$$

$$6 \int du + \int \frac{6}{u^2-1} du = 6u + \int \left(\frac{-3}{u+1} + \frac{3}{u-1} \right) du = 6u - 3 \int \frac{1}{u+1} du + 3 \int \frac{1}{u-1} du = 6u - 3 \ln |u+1| + 3 \ln |u-1| + C$$

$$= 6x^{1/6} + 3 \ln \left| \frac{x^{1/6}-1}{x^{1/6}+1} \right| + C$$

$$47. \int \frac{\sqrt{x+1}}{x} dx; [\text{Let } x+1 = u^2 \Rightarrow dx = 2u du] \rightarrow \int \frac{u}{u^2-1} 2u du = \int \frac{2u^2}{u^2-1} du = \int \left(2 + \frac{2}{u^2-1} \right) du = 2 \int du + \int \frac{2}{u^2-1} du;$$

$$\frac{2}{u^2-1} = \frac{A}{u+1} + \frac{B}{u-1} \Rightarrow 2 = A(u-1) + B(u+1) = (A+B)u - A + B \Rightarrow A+B=0, -A+B=2 \Rightarrow B=1 \Rightarrow A=-1;$$

$$2 \int du + \int \frac{2}{u^2-1} du = 2u + \int \left(\frac{-1}{u+1} + \frac{1}{u-1} \right) du = 2u - \int \frac{1}{u+1} du + \int \frac{1}{u-1} du = 2u - \ln |u+1| + \ln |u-1| + C$$

$$= 2\sqrt{x+1} + \ln \left| \frac{\sqrt{x+1}-1}{\sqrt{x+1}+1} \right| + C$$

48. $\int \frac{1}{x\sqrt{x+9}} dx$; [Let $x+9 = u^2 \Rightarrow dx = 2u du$] $\rightarrow \int \frac{1}{(u^2-9)u} 2u du = \int \frac{2}{u^2-9} du$; $\frac{2}{u^2-9} = \frac{A}{u-3} + \frac{B}{u+3}$
 $\Rightarrow 2 = A(u+3) + B(u-3) = (A+B)u + 3A-3B \Rightarrow A+B=0, 3A-3B=2 \Rightarrow A=\frac{1}{3} \Rightarrow B=-\frac{1}{3}$;
 $\int \frac{2}{u^2-9} du = \int \left(\frac{1/3}{u-3} - \frac{1/3}{u+3} \right) du = \frac{1}{3} \int \frac{1}{u-3} du - \frac{1}{3} \int \frac{1}{u+3} du = \frac{1}{3} \ln |u-3| - \frac{1}{3} \ln |u+3| + C = \frac{1}{3} \ln \left| \frac{\sqrt{x+9}-3}{\sqrt{x+9}+3} \right| + C$
49. $\int \frac{1}{x(x^4+1)} dx = \int \frac{x^3}{x^4(x^4+1)} dx$; [Let $u = x^4 \Rightarrow du = 4x^3 dx$] $\rightarrow \frac{1}{4} \int \frac{1}{u(u+1)} du$; $\frac{1}{u(u+1)} = \frac{A}{u} + \frac{B}{u+1}$
 $\Rightarrow 1 = A(u+1) + Bu = (A+B)u + A \Rightarrow A=1 \Rightarrow B=-1$;
 $\frac{1}{4} \int \frac{1}{u(u+1)} du = \frac{1}{4} \int \left(\frac{1}{u} - \frac{1}{u+1} \right) du = \frac{1}{4} \int \frac{1}{u} du - \frac{1}{4} \int \frac{1}{u+1} du = \frac{1}{4} \ln |u| - \frac{1}{4} \ln |u+1| + C = \frac{1}{4} \ln \left(\frac{x^4}{x^4+1} \right) + C$
50. $\int \frac{1}{x^6(x^5+4)} dx = \int \frac{x^4}{x^{10}(x^5+4)} dx$; [Let $u = x^5 \Rightarrow du = 5x^4 dx$] $\rightarrow \frac{1}{5} \int \frac{1}{u^2(u+4)} du$; $\frac{1}{u^2(u+4)} = \frac{A}{u} + \frac{B}{u^2} + \frac{C}{u+4}$
 $\Rightarrow 1 = Au(u+4) + B(u+4) + Cu^2 = (A+C)u^2 + (4A+B)u + 4B \Rightarrow A+C=0, 4A+B=0, 4B=1 \Rightarrow B=\frac{1}{4}$
 $\Rightarrow A=-\frac{1}{16} \Rightarrow C=\frac{1}{16}$; $\frac{1}{5} \int \frac{1}{u^2(u+4)} du = \frac{1}{5} \int \left(-\frac{1/16}{u} + \frac{1/4}{u^2} + \frac{1/16}{u+4} \right) du = -\frac{1}{80} \int \frac{1}{u} du + \frac{1}{20} \int \frac{1}{u^2} du + \frac{1}{80} \int \frac{1}{u+4} du$
 $= -\frac{1}{80} \ln |u| - \frac{1}{20u} + \frac{1}{80} \ln |u+4| + C = -\frac{1}{80} \ln |x^5| - \frac{1}{20x^5} + \frac{1}{80} \ln |x^5+4| + C = \frac{1}{80} \ln \left| \frac{x^5+4}{x^5} \right| - \frac{1}{20x^5} + C$
51. $(t^2 - 3t + 2) \frac{dx}{dt} = 1$; $x = \int \frac{dt}{t^2 - 3t + 2} = \int \frac{dt}{t-2} - \int \frac{dt}{t-1} = \ln \left| \frac{t-2}{t-1} \right| + C$; $\frac{t-2}{t-1} = Ce^x$; $t=3$ and $x=0 \Rightarrow \frac{1}{2} = C$
 $\Rightarrow \frac{t-2}{t-1} = \frac{1}{2} e^x \Rightarrow x = \ln \left| 2 \left(\frac{t-2}{t-1} \right) \right| = \ln |t-2| - \ln |t-1| + \ln 2$
52. $(3t^4 + 4t^2 + 1) \frac{dx}{dt} = 2\sqrt{3}$; $x = 2\sqrt{3} \int \frac{dt}{3t^4 + 4t^2 + 1} = \sqrt{3} \int \frac{dt}{t^2 + \frac{1}{3}} - \sqrt{3} \int \frac{dt}{t^2 + 1} = 3 \tan^{-1}(\sqrt{3}t) - \sqrt{3} \tan^{-1} t + C$; $t=1$ and
 $x = \frac{-\pi\sqrt{3}}{4} \Rightarrow -\frac{\sqrt{3}\pi}{4} = \pi - \frac{\sqrt{3}}{4}\pi + C \Rightarrow C = -\pi \Rightarrow x = 3 \tan^{-1}(\sqrt{3}t) - \sqrt{3} \tan^{-1} t - \pi$
53. $(t^2 + 2t) \frac{dx}{dt} = 2x + 2$; $\frac{1}{2} \int \frac{dx}{x+1} = \int \frac{dt}{t^2 + 2t} \Rightarrow \frac{1}{2} \ln |x+1| = \frac{1}{2} \int \frac{dt}{t} - \frac{1}{2} \int \frac{dt}{t+2} \Rightarrow \ln |x+1| = \ln \left| \frac{t}{t+2} \right| + C$; $t=1$ and
 $x=1 \Rightarrow \ln 2 = \ln \frac{1}{3} + C \Rightarrow C = \ln 2 + \ln 3 = \ln 6 \Rightarrow \ln |x+1| = \ln 6 \left| \frac{t}{t+2} \right| \Rightarrow x+1 = \frac{6t}{t+2} \Rightarrow x = \frac{6t}{t+2} - 1, t > 0$
54. $(t+1) \frac{dx}{dt} = x^2 + 1 \Rightarrow \int \frac{dx}{x^2+1} = \int \frac{dt}{t+1} \Rightarrow \tan^{-1} x = \ln |t+1| + C$; $t=0$ and $x=0 \Rightarrow \tan^{-1} 0 = \ln |1| + C$
 $\Rightarrow C = \tan^{-1} 0 = 0 \Rightarrow \tan^{-1} x = \ln |t+1| \Rightarrow x = \tan(\ln(t+1)), t > -1$
55. $V = \pi \int_{0.5}^{2.5} y^2 dx = \pi \int_{0.5}^{2.5} \frac{9}{3x-x^2} dx = 3\pi \left(\int_{0.5}^{2.5} \left(-\frac{1}{x-3} + \frac{1}{x} \right) dx \right) = \left[3\pi \ln \left| \frac{x}{x-3} \right| \right]_{0.5}^{2.5} = 3\pi \ln 25$
56. $V = 2\pi \int_0^1 xy dx = 2\pi \int_0^1 \frac{2x}{(x+1)(2-x)} dx = 4\pi \int_0^1 \left[-\frac{1}{3} \left(\frac{1}{x+1} \right) + \frac{2}{3} \left(\frac{1}{2-x} \right) \right] dx = \left[-\frac{4\pi}{3} (\ln |x+1| + 2 \ln |2-x|) \right]_0^1 = \frac{4\pi}{3} (\ln 2)$

$$\begin{aligned}
 57. \quad A &= \int_0^{\sqrt{3}} \tan^{-1} x \, dx = \left[x \tan^{-1} x \right]_0^{\sqrt{3}} - \int_0^{\sqrt{3}} \frac{x}{1+x^2} \, dx \\
 &= \frac{\pi\sqrt{3}}{3} - \left[\frac{1}{2} \ln(x^2 + 1) \right]_0^{\sqrt{3}} = \frac{\pi\sqrt{3}}{3} - \ln 2; \\
 \bar{x} &= \frac{1}{A} \int_0^{\sqrt{3}} x \tan^{-1} x \, dx = \frac{1}{A} \left(\left[\frac{1}{2} x^2 \tan^{-1} x \right]_0^{\sqrt{3}} - \frac{1}{2} \int_0^{\sqrt{3}} \frac{x^2}{1+x^2} \, dx \right) \\
 &= \frac{1}{A} \left[\frac{\pi}{2} - \left[\frac{1}{2} (x - \tan^{-1} x) \right]_0^{\sqrt{3}} \right] = \frac{1}{A} \left(\frac{\pi}{2} - \frac{\sqrt{3}}{2} + \frac{\pi}{6} \right) = \frac{1}{A} \left(\frac{2\pi}{3} - \frac{\sqrt{3}}{2} \right) \cong 1.10
 \end{aligned}$$

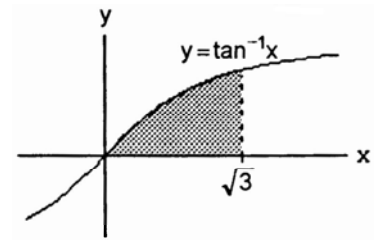

$$\begin{aligned}
 58. \quad A &= \int_3^5 \frac{4x^2+13x-9}{x^3+2x^2-3x} \, dx = 3 \int_3^5 \frac{dx}{x} - \int_3^5 \frac{dx}{x+3} + 2 \int_3^5 \frac{dx}{x-1} = [3 \ln|x| - \ln|x+3| + 2 \ln|x-1|]_3^5 = \ln \frac{125}{9}; \\
 \bar{x} &= \frac{1}{A} \int_3^5 \frac{x(4x^2+13x-9)}{x^3+2x^2-3x} \, dx = \frac{1}{A} \left([4x]_3^5 + 3 \int_3^5 \frac{dx}{x+3} + 2 \int_3^5 \frac{dx}{x-1} \right) = \frac{1}{A} (8 + 11 \ln 2 - 3 \ln 6) \cong 3.90
 \end{aligned}$$

$$\begin{aligned}
 59. \quad (a) \quad \frac{dx}{dt} &= kx(N-x) \Rightarrow \int \frac{dx}{x(N-x)} = \int k \, dt \Rightarrow \frac{1}{N} \int \frac{dx}{x} + \frac{1}{N} \int \frac{dx}{N-x} = \int k \, dt \Rightarrow \frac{1}{N} \ln \left| \frac{x}{N-x} \right| = kt + C; \\
 k &= \frac{1}{250}, N = 1000, t = 0 \text{ and } x = 2 \Rightarrow \frac{1}{1000} \ln \left| \frac{2}{998} \right| = C \Rightarrow \frac{1}{1000} \ln \left| \frac{x}{1000-x} \right| = \frac{t}{250} + \frac{1}{1000} \ln \left(\frac{1}{499} \right) \\
 &\Rightarrow \ln \left| \frac{499x}{1000-x} \right| = 4t \Rightarrow \frac{499x}{1000-x} = e^{4t} \Rightarrow 499x = e^{4t}(1000-x) \Rightarrow (499 + e^{4t})x = 1000e^{4t} \Rightarrow x = \frac{1000e^{4t}}{499 + e^{4t}} \\
 (b) \quad x &= \frac{1}{2}N = 500 \Rightarrow 500 = \frac{1000e^{4t}}{499 + e^{4t}} \Rightarrow 500 \cdot 499 + 500e^{4t} = 1000e^{4t} \Rightarrow e^{4t} = 499 \Rightarrow t = \frac{1}{4} \ln 499 \approx 1.55 \text{ days}
 \end{aligned}$$

$$\begin{aligned}
 60. \quad \frac{dx}{dt} &= k(a-x)(b-x) \Rightarrow \frac{dx}{(a-x)(b-x)} = k \, dt \\
 (a) \quad a &= b: \int \frac{dx}{(a-x)^2} = \int k \, dt \Rightarrow \frac{1}{a-x} = kt + C; t = 0 \text{ and } x = 0 \Rightarrow \frac{1}{a} = C \Rightarrow \frac{1}{a-x} = kt + \frac{1}{a} \\
 &\Rightarrow \frac{1}{a-x} = \frac{akt+1}{a} \Rightarrow a-x = \frac{a}{akt+1} \Rightarrow x = a - \frac{a}{akt+1} = \frac{a^2kt}{akt+1} \\
 (b) \quad a &\neq b: \int \frac{dx}{(a-x)(b-x)} = \int k \, dt \Rightarrow \frac{1}{b-a} \int \frac{dx}{a-x} - \frac{1}{b-a} \int \frac{dx}{b-x} = \int k \, dt \Rightarrow \frac{1}{b-a} \ln \left| \frac{b-x}{a-x} \right| = kt + C; t = 0 \text{ and} \\
 x = 0 &\Rightarrow \frac{1}{b-a} \ln \frac{b}{a} = C \Rightarrow \ln \left| \frac{b-x}{a-x} \right| = (b-a)kt + \ln \left(\frac{b}{a} \right) \Rightarrow \frac{b-x}{a-x} = \frac{b}{a} e^{(b-a)kt} \Rightarrow x = \frac{ab[1 - e^{(b-a)kt}]}{a - be^{(b-a)kt}}
 \end{aligned}$$

8.6 INTEGRAL TABLES AND COMPUTER ALGEBRA SYSTEMS

1. $\int \frac{dx}{x\sqrt{x-3}} = \frac{2}{\sqrt{3}} \tan^{-1} \sqrt{\frac{x-3}{3}} + C$
(We used FORMULA 13(a) with $a = 1, b = 3$)
2. $\int \frac{dx}{x\sqrt{x+4}} = \frac{1}{\sqrt{4}} \ln \left| \frac{\sqrt{x+4}-\sqrt{4}}{\sqrt{x+4}+\sqrt{4}} \right| + C = \frac{1}{2} \ln \left| \frac{\sqrt{x+4}-2}{\sqrt{x+4}+2} \right| + C$
(We used FORMULA 13(b) with $a = 1, b = 4$)

$$\begin{aligned}
 3. \quad \int \frac{x \, dx}{\sqrt{x-2}} &= \int \frac{(x-2) \, dx}{\sqrt{x-2}} + 2 \int \frac{dx}{\sqrt{x-2}} = \int (\sqrt{x-2})^1 \, dx + 2 \int (\sqrt{x-2})^{-1} \, dx \\
 &= \left(\frac{2}{1}\right) \frac{(\sqrt{x-2})^3}{3} + 2 \left(\frac{2}{1}\right) \frac{(\sqrt{x-2})^1}{1} = \sqrt{x-2} \left[\frac{2(x-2)}{3} + 4 \right] + C \\
 &\quad \text{(We used FORMULA 11 with } a=1, b=-2, n=1 \text{ and } a=1, b=-2, n=-1)
 \end{aligned}$$

$$\begin{aligned}
 4. \quad \int \frac{x \, dx}{(2x+3)^{3/2}} &= \frac{1}{2} \int \frac{(2x+3) \, dx}{(2x+3)^{3/2}} - \frac{3}{2} \int \frac{dx}{(2x+3)^{3/2}} = \frac{1}{2} \int \frac{dx}{\sqrt{2x+3}} - \frac{3}{2} \int \frac{dx}{(\sqrt{2x+3})^3} \\
 &= \frac{1}{2} \int (\sqrt{2x+3})^{-1} \, dx - \frac{3}{2} \int (\sqrt{2x+3})^{-3} \, dx = \left(\frac{1}{2}\right) \left(\frac{2}{2}\right) \frac{(\sqrt{2x+3})^1}{1} - \left(\frac{3}{2}\right) \left(\frac{2}{2}\right) \frac{(\sqrt{2x+3})^{-1}}{(-1)} + C \\
 &= \frac{1}{2\sqrt{2x+3}} (2x+3+3) + C = \frac{(x+3)}{\sqrt{2x+3}} + C \\
 &\quad \text{(We used FORMULA 11 with } a=2, b=3, n=-1 \text{ and } a=2, b=3, n=-3)
 \end{aligned}$$

$$\begin{aligned}
 5. \quad \int x\sqrt{2x-3} \, dx &= \frac{1}{2} \int (2x-3)\sqrt{2x-3} \, dx + \frac{3}{2} \int \sqrt{2x-3} \, dx = \frac{1}{2} \int (\sqrt{2x-3})^3 \, dx + \frac{3}{2} \int (\sqrt{2x-3})^1 \, dx \\
 &= \left(\frac{1}{2}\right) \left(\frac{2}{2}\right) \frac{(\sqrt{2x-3})^5}{5} + \left(\frac{3}{2}\right) \left(\frac{2}{2}\right) \frac{(\sqrt{2x-3})^3}{3} + C = \frac{(2x-3)^{3/2}}{2} \left[\frac{2x-3}{5} + 1 \right] + C = \frac{(2x-3)^{3/2}(x+1)}{5} + C \\
 &\quad \text{(We used FORMULA 11 with } a=2, b=-3, n=3 \text{ and } a=2, b=-3, n=1)
 \end{aligned}$$

$$\begin{aligned}
 6. \quad \int x(7x+5)^{3/2} \, dx &= \frac{1}{7} \int (7x+5)(7x+5)^{3/2} \, dx - \frac{5}{7} \int (7x+5)^{3/2} \, dx = \frac{1}{7} \int (\sqrt{7x+5})^5 \, dx - \frac{5}{7} \int (\sqrt{7x+5})^3 \, dx \\
 &= \left(\frac{1}{7}\right) \left(\frac{2}{7}\right) \frac{(\sqrt{7x+5})^7}{7} - \left(\frac{5}{7}\right) \left(\frac{2}{7}\right) \frac{(\sqrt{7x+5})^5}{5} + C = \frac{(7x+5)^{5/2}}{49} \left[\frac{2(7x+5)}{7} - 2 \right] + C = \frac{(7x+5)^{5/2}}{49} \left(\frac{14x-4}{7} \right) + C \\
 &\quad \text{(We used FORMULA 11 with } a=7, b=5, n=5 \text{ and } a=7, b=5, n=3)
 \end{aligned}$$

$$\begin{aligned}
 7. \quad \int \frac{\sqrt{9-4x}}{x^2} \, dx &= -\frac{\sqrt{9-4x}}{x} + \frac{(-4)}{2} \int \frac{dx}{x\sqrt{9-4x}} + C \\
 &\quad \text{(We used FORMULA 14 with } a=-4, b=9) \\
 &= -\frac{\sqrt{9-4x}}{x} - 2 \left(\frac{1}{\sqrt{9}}\right) \ln \left| \frac{\sqrt{9-4x}-\sqrt{9}}{\sqrt{9-4x}+\sqrt{9}} \right| + C \\
 &\quad \text{(We used FORMULA 13(b) with } a=-4, b=9) \\
 &= -\frac{\sqrt{9-4x}}{x} - \frac{2}{3} \ln \left| \frac{\sqrt{9-4x}-3}{\sqrt{9-4x}+3} \right| + C
 \end{aligned}$$

$$\begin{aligned}
 8. \quad \int \frac{dx}{x^2\sqrt{4x-9}} &= -\frac{\sqrt{4x-9}}{(-9)x} + \frac{4}{18} \int \frac{dx}{x\sqrt{4x-9}} + C \\
 &\quad \text{(We used FORMULA 15 with } a=4, b=-9) \\
 &= \frac{\sqrt{4x-9}}{9x} + \left(\frac{2}{9}\right) \left(\frac{2}{\sqrt{9}}\right) \tan^{-1} \sqrt{\frac{4x-9}{9}} + C \\
 &\quad \text{(We used FORMULA 13(a) with } a=4, b=9) \\
 &= \frac{\sqrt{4x-9}}{9x} + \frac{4}{27} \tan^{-1} \sqrt{\frac{4x-9}{9}} + C
 \end{aligned}$$

9. $\int x\sqrt{4x-x^2} dx = \int x\sqrt{2 \cdot 2x-x^2} dx = \frac{(x+2)(2x-3) \cdot \sqrt{2 \cdot 2x-x^2}}{6} + \frac{2^3}{2} \sin^{-1}\left(\frac{x-2}{2}\right) + C$
 $= \frac{(x+2)(2x-6)\sqrt{4x-x^2}}{6} + 4 \sin^{-1}\left(\frac{x-2}{2}\right) + C = \frac{(x+2)(x-3)\sqrt{4x-x^2}}{3} + 4 \sin^{-1}\left(\frac{x-2}{2}\right) + C$
 (We used FORMULA 51 with $a = 2$)
10. $\int \frac{\sqrt{x-x^2}}{x} dx = \int \frac{\sqrt{2 \cdot \frac{1}{2}x-x^2}}{x} dx = \sqrt{2 \cdot \frac{1}{2}x-x^2} + \frac{1}{2} \sin^{-1}\left(\frac{x-\frac{1}{2}}{\frac{1}{2}}\right) + C = \sqrt{x-x^2} + \frac{1}{2} \sin^{-1}(2x-1) + C$
 (We used FORMULA 52 with $a = \frac{1}{2}$)
11. $\int \frac{dx}{x\sqrt{7+x^2}} = \int \frac{dx}{x\sqrt{(\sqrt{7})^2+x^2}} = -\frac{1}{\sqrt{7}} \ln \left| \frac{\sqrt{7} + \sqrt{(\sqrt{7})^2+x^2}}{x} \right| + C = -\frac{1}{\sqrt{7}} \ln \left| \frac{\sqrt{7} + \sqrt{7+x^2}}{x} \right| + C$
 (We used FORMULA 26 with $a = \sqrt{7}$)
12. $\int \frac{dx}{x\sqrt{7-x^2}} = \int \frac{dx}{x\sqrt{(\sqrt{7})^2-x^2}} = -\frac{1}{\sqrt{7}} \ln \left| \frac{\sqrt{7} + \sqrt{(\sqrt{7})^2-x^2}}{x} \right| + C = -\frac{1}{\sqrt{7}} \ln \left| \frac{\sqrt{7} + \sqrt{7-x^2}}{x} \right| + C$
 (We used FORMULA 34 with $a = \sqrt{7}$)
13. $\int \frac{\sqrt{4-x^2}}{x} dx = \int \frac{\sqrt{2^2-x^2}}{x} dx = \sqrt{2^2-x^2} - 2 \ln \left| \frac{2+\sqrt{2^2-x^2}}{x} \right| + C = \sqrt{4-x^2} - 2 \ln \left| \frac{2+\sqrt{4-x^2}}{x} \right| + C$
 (We used FORMULA 31 with $a = 2$)
14. $\int \frac{\sqrt{x^2-4}}{x} dx = \int \frac{\sqrt{x^2-2^2}}{x} dx = \sqrt{x^2-2^2} - 2 \sec^{-1} \left| \frac{x}{2} \right| + C = \sqrt{x^2-4} - 2 \sec^{-1} \left| \frac{x}{2} \right| + C$
 (We used FORMULA 42 with $a = 2$)
15. $\int e^{2t} \cos 3t dt = \frac{e^{2t}}{2^2+3^2} (2 \cos 3t + 3 \sin 3t) + C = \frac{e^{2t}}{13} (2 \cos 3t + 3 \sin 3t) + C$
 (We used FORMULA 108 with $a = 2, b = 3$)
16. $\int e^{-3t} \sin 4t dt = \frac{e^{-3t}}{(-3)^2+4^2} (-3 \sin 4t - 4 \cos 4t) + C = \frac{e^{-3t}}{25} (-3 \sin 4t - 4 \cos 4t) + C$
 (We used FORMULA 107 with $a = -3, b = 4$)
17. $\int x \cos^{-1} x dx = \int x^1 \cos^{-1} x dx = \frac{x^{1+1}}{1+1} \cos^{-1} x + \frac{1}{1+1} \int \frac{x^{1+1} dx}{\sqrt{1-x^2}} = \frac{x^2}{2} \cos^{-1} x + \frac{1}{2} \int \frac{x^2 dx}{\sqrt{1-x^2}}$
 (We used FORMULA 100 with $a = 1, n = 1$)
 $= \frac{x^2}{2} \cos^{-1} x + \frac{1}{2} \left(\frac{1}{2} \sin^{-1} x \right) - \frac{1}{2} \left(\frac{1}{2} x \sqrt{1-x^2} \right) + C = \frac{x^2}{2} \cos^{-1} x + \frac{1}{4} \sin^{-1} x - \frac{1}{4} x \sqrt{1-x^2} + C$
 (We used FORMULA 33 with $a = 1$)
18. $\int x \tan^{-1} x dx = \int x^1 \tan^{-1}(1x) dx = \frac{x^{1+1}}{1+1} \tan^{-1}(1x) - \frac{1}{1+1} \int \frac{x^{1+1} dx}{1+(1)^2 x^2} = \frac{x^2}{2} \tan^{-1} x - \frac{1}{2} \int \frac{x^2 dx}{1+x^2}$
 (We used FORMULA 101 with $a = 1, n = 1$)

$$\begin{aligned}
 &= \frac{x^2}{2} \tan^{-1} x - \frac{1}{2} \int \left(1 - \frac{1}{1+x^2}\right) dx \quad (\text{after long division}) \\
 &= \frac{x^2}{2} \tan^{-1} x - \frac{1}{2} \int dx + \frac{1}{2} \int \frac{1}{1+x^2} dx = \frac{x^2}{2} \tan^{-1} x - \frac{1}{2} x + \frac{1}{2} \tan^{-1} x + C = \frac{1}{2} \left((x^2 + 1) \tan^{-1} x - x \right) + C
 \end{aligned}$$

19. $\int x^2 \tan^{-1} x \, dx = \frac{x^{2+1}}{2+1} \tan^{-1} x - \frac{1}{2+1} \int \frac{x^{2+1}}{1+x^2} dx = \frac{x^3}{3} \tan^{-1} x - \frac{1}{3} \int \frac{x^3}{1+x^2} dx$
 (We used FORMULA 101 with $a = 1, n = 2$)
 $\int \frac{x^3}{1+x^2} dx = \int x \, dx - \int \frac{x \, dx}{1+x^2} = \frac{x^2}{2} - \frac{1}{2} \ln(1+x^2) + C \Rightarrow \int x^2 \tan^{-1} x \, dx = \frac{x^3}{3} \tan^{-1} x - \frac{x^2}{6} + \frac{1}{6} \ln(1+x^2) + C$
20. $\int \frac{\tan^{-1} x}{x^2} dx = \int x^{-2} \tan^{-1} x \, dx = \frac{x^{(-2+1)}}{(-2+1)} \tan^{-1} x - \frac{1}{(-2+1)} \int \frac{x^{(-2+1)}}{1+x^2} dx = \frac{x^{-1}}{(-1)} \tan^{-1} x + \int \frac{x^{-1}}{1+x^2} dx$
 (We used FORMULA 101 with $a = 1, n = -2$)
 $\int \frac{x^{-1} dx}{1+x^2} = \int \frac{dx}{x(1+x^2)} = \int \frac{dx}{x} - \int \frac{x \, dx}{1+x^2} = \ln|x| - \frac{1}{2} \ln(1+x^2) + C \Rightarrow \int \frac{\tan^{-1} x}{x^2} dx = -\frac{1}{x} \tan^{-1} x + \ln|x| - \frac{1}{2} \ln(1+x^2) + C$
21. $\int \sin 3x \cos 2x \, dx = -\frac{\cos 5x}{10} - \frac{\cos x}{2} + C$
 (We used FORMULA 62(a) with $a = 3, b = 2$)
22. $\int \sin 2x \cos 3x \, dx = -\frac{\cos 5x}{10} + \frac{\cos x}{2} + C$
 (We used FORMULA 62(a) with $a = 2, b = 3$)
23. $\int 8 \sin 4t \sin \frac{t}{2} \, dx = \frac{8}{7} \sin\left(\frac{7t}{2}\right) - \frac{8}{9} \sin\left(\frac{9t}{2}\right) + C = 8 \left[\frac{\sin\left(\frac{7t}{2}\right)}{7} - \frac{\sin\left(\frac{9t}{2}\right)}{9} \right] + C$
 (We used FORMULA 62(b) with $a = 4, b = \frac{1}{2}$)
24. $\int \sin \frac{t}{3} \sin \frac{t}{6} \, dt = 3 \sin\left(\frac{t}{6}\right) - \sin\left(\frac{t}{2}\right) + C$
 (We used FORMULA 62(b) with $a = \frac{1}{3}, b = \frac{1}{6}$)
25. $\int \cos \frac{\theta}{3} \cos \frac{\theta}{4} \, d\theta = 6 \sin\left(\frac{\theta}{12}\right) + \frac{6}{7} \sin\left(\frac{7\theta}{12}\right) + C$
 (We used FORMULA 62(c) with $a = \frac{1}{3}, b = \frac{1}{4}$)
26. $\int \cos \frac{\theta}{2} \cos 7\theta \, d\theta = \frac{1}{13} \sin\left(\frac{13\theta}{2}\right) + \frac{1}{15} \sin\left(\frac{15\theta}{2}\right) + C = \frac{\sin\left(\frac{13\theta}{2}\right)}{13} + \frac{\sin\left(\frac{15\theta}{2}\right)}{15} + C$
 (We used FORMULA 62(c) with $a = \frac{1}{2}, b = 7$)
27. $\int \frac{x^3+x+1}{(x^2+1)^2} dx = \int \frac{x \, dx}{x^2+1} + \int \frac{dx}{(x^2+1)^2} = \frac{1}{2} \int \frac{2x \, dx}{x^2+1} + \int \frac{dx}{(x^2+1)^2} = \frac{1}{2} \ln(x^2+1) + \frac{x}{2(1+x^2)} + \frac{1}{2} \tan^{-1} x + C$
 (For the second integral we used FORMULA 17 with $a = 1$)

$$\begin{aligned}
 28. \int \frac{x^2+6x}{(x^2+3)^2} dx &= \int \frac{dx}{x^2+3} + \int \frac{6x dx}{(x^2+3)^2} - \int \frac{3 dx}{(x^2+3)^2} = \int \frac{dx}{x^2+(\sqrt{3})^2} + 3 \int \frac{2x dx}{(x^2+3)^2} - 3 \int \frac{dx}{[x^2+(\sqrt{3})^2]^2} \\
 &= \frac{1}{\sqrt{3}} \tan^{-1}\left(\frac{x}{\sqrt{3}}\right) - \frac{3}{x^2+3} - 3 \left(\frac{x}{2(\sqrt{3})^2((\sqrt{3})^2+x^2)} + \frac{1}{2(\sqrt{3})^3} \tan^{-1}\left(\frac{x}{\sqrt{3}}\right) \right) + C
 \end{aligned}$$

(For the first integral we used FORMULA 16 with $a = \sqrt{3}$; for the third integral we used FORMULA 17 with $a = \sqrt{3}$)

$$= \frac{1}{2\sqrt{3}} \tan^{-1}\left(\frac{x}{\sqrt{3}}\right) - \frac{3}{x^2+3} - \frac{x}{2(x^2+3)} + C$$

$$29. \int \sin^{-1} \sqrt{x} dx; \begin{cases} u = \sqrt{x} \\ x = u^2 \\ dx = 2u du \end{cases} \rightarrow 2 \int u^1 \sin^{-1} u du = 2 \left(\frac{u^{1+1}}{1+1} \sin^{-1} u - \frac{1}{1+1} \int \frac{u^{1+1}}{\sqrt{1-u^2}} du \right) = u^2 \sin^{-1} u - \int \frac{u^2 du}{\sqrt{1-u^2}}$$

(We used FORMULA 99 with $a = 1, n = 1$)

$$= u^2 \sin^{-1} u - \left(\frac{1}{2} \sin^{-1} u - \frac{1}{2} u \sqrt{1-u^2} \right) + C = \left(u^2 - \frac{1}{2} \right) \sin^{-1} u + \frac{1}{2} u \sqrt{1-u^2} + C$$

(We used FORMULA 33 with $a = 1$)

$$= \left(x - \frac{1}{2} \right) \sin^{-1} \sqrt{x} + \frac{1}{2} \sqrt{x-x^2} + C$$

$$30. \int \frac{\cos^{-1} \sqrt{x}}{\sqrt{x}} dx; \begin{cases} u = \sqrt{x} \\ x = u^2 \\ dx = 2u du \end{cases} \rightarrow \int \frac{\cos^{-1} u}{u} \cdot 2u du = 2 \int \cos^{-1} u du = 2 \left(u \cos^{-1} u - \frac{1}{1} \sqrt{1-u^2} \right) + C$$

(We used FORMULA 97 with $a = 1$)

$$= 2 \left(\sqrt{x} \cos^{-1} \sqrt{x} - \sqrt{1-x} \right) + C$$

$$31. \int \frac{\sqrt{x}}{\sqrt{1-x}} dx; \begin{cases} u = \sqrt{x} \\ x = u^2 \\ dx = 2u du \end{cases} \rightarrow \int \frac{u \cdot 2u}{\sqrt{1-u^2}} du = 2 \int \frac{u^2}{\sqrt{1-u^2}} du = 2 \left(\frac{1}{2} \sin^{-1} u - \frac{1}{2} u \sqrt{1-u^2} \right) + C = \sin^{-1} u - u \sqrt{1-u^2} + C$$

(We used FORMULA 33 with $a = 1$)

$$= \sin^{-1} \sqrt{x} - \sqrt{x} \sqrt{1-x} + C = \sin^{-1} \sqrt{x} - \sqrt{x-x^2} + C$$

$$32. \int \frac{\sqrt{2-x}}{\sqrt{x}} dx; \begin{cases} u = \sqrt{x} \\ x = u^2 \\ dx = 2u du \end{cases} \rightarrow \int \frac{\sqrt{2-u^2}}{u} \cdot 2u du = 2 \int \sqrt{(\sqrt{2})^2 - u^2} du = 2 \left[\frac{u}{2} \sqrt{(\sqrt{2})^2 - u^2} + \frac{(\sqrt{2})^2}{2} \sin^{-1} \left(\frac{u}{\sqrt{2}} \right) \right] + C$$

(We used FORMULA 29 with $a = \sqrt{2}$)

$$= u \sqrt{2-u^2} + 2 \sin^{-1} \left(\frac{u}{\sqrt{2}} \right) + C = \sqrt{2x-x^2} + 2 \sin^{-1} \sqrt{\frac{x}{2}} + C$$

$$33. \int (\cot t)\sqrt{1-\sin^2 t} dt = \int \frac{\sqrt{1-\sin^2 t}(\cos t)dt}{\sin t}; \left[\begin{array}{l} u = \sin t \\ du = \cos t dt \end{array} \right] \rightarrow \int \frac{\sqrt{1-u^2} du}{u} = \sqrt{1-u^2} - \ln \left| \frac{1+\sqrt{1-u^2}}{u} \right| + C$$

(We used FORMULA 31 with $a = 1$)

$$= \sqrt{1-\sin^2 t} - \ln \left| \frac{1+\sqrt{1-\sin^2 t}}{\sin t} \right| + C$$

$$34. \int \frac{dt}{(\tan t)\sqrt{4-\sin^2 t}} = \int \frac{\cos t dt}{(\sin t)\sqrt{4-\sin^2 t}}; [u = \sin t, du = \cos t dt] \rightarrow \int \frac{du}{u\sqrt{4-u^2}} = -\frac{1}{2} \ln \left| \frac{2+\sqrt{4-u^2}}{u} \right| + C$$

(We used FORMULA 34 with $a = 2$)

$$= -\frac{1}{2} \ln \left| \frac{2+\sqrt{4-\sin^2 t}}{\sin t} \right| + C$$

$$35. \int \frac{dy}{y\sqrt{3+(\ln y)^2}}; \left[\begin{array}{l} u = \ln y \\ y = e^u \\ dy = e^u du \end{array} \right] \rightarrow \int \frac{e^u du}{e^u \sqrt{3+u^2}} = \int \frac{du}{\sqrt{3+u^2}} = \ln \left| u + \sqrt{3+u^2} \right| + C = \ln \left| \ln y + \sqrt{3+(\ln y)^2} \right| + C$$

(We used FORMULA 20 with $a = \sqrt{3}$)

$$36. \int \tan^{-1} \sqrt{y} dy; \left[\begin{array}{l} t = \sqrt{y} \\ y = t^2 \\ dy = 2t dt \end{array} \right] \rightarrow 2 \int t \tan^{-1} t dt = 2 \left[\frac{t^2}{2} \tan^{-1} t - \frac{1}{2} \int \frac{t^2}{1+t^2} dt \right] = t^2 \tan^{-1} t - \int \frac{t^2}{1+t^2} dt$$

(We used FORMULA 101 with $n = 1, a = 1$)

$$= t^2 \tan^{-1} t - \int \frac{t^2+1}{t^2+1} dt + \int \frac{dt}{1+t^2} = t^2 \tan^{-1} t - t + \tan^{-1} t + C = y \tan^{-1} \sqrt{y} + \tan^{-1} \sqrt{y} - \sqrt{y} + C$$

$$37. \int \frac{1}{\sqrt{x^2+2x+5}} dx = \int \frac{1}{\sqrt{(x+1)^2+4}} dx; [t = x+1, dt = dx] \rightarrow \int \frac{1}{\sqrt{t^2+4}} dt = \ln \left| t + \sqrt{t^2+4} \right| + C$$

(We used FORMULA 20 with $a = 2$)

$$= \ln \left| (x+1) + \sqrt{(x+1)^2+4} \right| + C = \ln \left| (x+1) + \sqrt{x^2+2x+5} \right| + C$$

$$38. \int \frac{x^2}{\sqrt{x^2-4x+5}} dx = \int \frac{x^2}{\sqrt{(x-2)^2+1}} dx; \left[\begin{array}{l} t = x-2 \\ dt = dx \end{array} \right] \rightarrow \int \frac{(t+2)^2}{\sqrt{t^2+1}} dt = \int \frac{t^2+4t+2}{\sqrt{t^2+1}} dt = \int \frac{t^2}{\sqrt{t^2+1}} dt + \int \frac{4t}{\sqrt{t^2+1}} dt + \int \frac{4}{\sqrt{t^2+1}} dt$$

(We used FORMULA 25 with $a = 1$) (We used FORMULA 20 with $a = 1$)

$$= \left[-\frac{1}{2} \ln \left| t + \sqrt{t^2+1} \right| + \frac{t\sqrt{t^2+1}}{2} \right] + 4\sqrt{t^2+1} + \left[4 \ln \left| t + \sqrt{t^2+1} \right| \right] + C$$

$$= -\frac{1}{2} \ln \left| (x-2) + \sqrt{(x-2)^2+1} \right| + \frac{(x-2)\sqrt{(x-2)^2+1}}{2} + 4\sqrt{(x-2)^2+1} + 4 \ln \left| (x-2) + \sqrt{(x-2)^2+1} \right| + C$$

$$= \frac{7}{2} \ln \left| (x-2) + \sqrt{x^2-4x+5} \right| + \frac{(x+6)\sqrt{x^2-4x+5}}{2} + C$$

$$39. \int \sqrt{5-4x-x^2} dx = \int \sqrt{9-(x+2)^2} dx; [t = x+2, dt = dx] \rightarrow \int \sqrt{9-t^2} dt = \frac{t}{2} \sqrt{9-t^2} + \frac{3^2}{2} \sin^{-1}\left(\frac{t}{3}\right) + C$$

(We used FORMULA 29 with $a = 3$)

$$= \frac{x+2}{2} \sqrt{9-(x+2)^2} + \frac{9}{2} \sin^{-1}\left(\frac{x+2}{3}\right) + C = \frac{x+2}{2} \sqrt{5-4x-x^2} + \frac{9}{2} \sin^{-1}\left(\frac{x+2}{3}\right) + C$$

$$40. \int x^2 \sqrt{2x-x^2} dx = \int x^2 \sqrt{1-(x-1)^2} dx; [t = x-1, dt = dx] \rightarrow \int (t+1)^2 \sqrt{1-t^2} dt = \int (t^2 + 2t + 1) \sqrt{1-t^2} dt$$

$$= \int t^2 \sqrt{1-t^2} dt + \int 2t \sqrt{1-t^2} dt + \int \sqrt{1-t^2} dt$$

(We used FORMULA 30 with $a = 1$) (We used FORMULA 29 with $a = 1$)

$$= \left[\frac{1^4}{8} \sin^{-1}\left(\frac{t}{1}\right) - \frac{1}{8} t \sqrt{1-t^2} (1^2 - 2t^2) \right] - \frac{2}{3} (1-t^2)^{3/2} + \left[\frac{t}{2} \sqrt{1-t^2} + \frac{1^2}{2} \sin^{-1}\left(\frac{t}{1}\right) \right] + C$$

$$= \frac{1}{8} \sin^{-1}(x-1) - \frac{1}{8} (x-1) \sqrt{1-(x-1)^2} (1^2 - 2(x-1)^2) - \frac{2}{3} (1-(x-1)^2)^{3/2} + \frac{x-1}{2} \sqrt{1-(x-1)^2} + \frac{1}{2} \sin^{-1}(x-1) + C$$

$$= \frac{5}{8} \sin^{-1}(x-1) - \frac{2}{3} (2x-x^2)^{3/2} + \frac{x-1}{8} \sqrt{2x-x^2} (2x^2 - 4x + 5) + C$$

$$41. \int \sin^5 2x dx = -\frac{\sin^4 2x \cos 2x}{5 \cdot 2} + \frac{5-1}{5} \int \sin^3 2x dx = -\frac{\sin^4 2x \cos 2x}{10} + \frac{4}{5} \left[-\frac{\sin^2 2x \cos 2x}{3 \cdot 2} + \frac{3-1}{3} \int \sin 2x dx \right]$$

(We used FORMULA 60 with $a = 2, n = 5$ and $a = 2, n = 3$)

$$= -\frac{\sin^4 2x \cos 2x}{10} - \frac{2}{15} \sin^2 2x \cos 2x + \frac{8}{15} \left(-\frac{1}{2}\right) \cos 2x + C = -\frac{\sin^4 2x \cos 2x}{10} - \frac{2 \sin^2 2x \cos 2x}{15} - \frac{4 \cos 2x}{15} + C$$

$$42. \int 8 \cos^4 2\pi t dt = 8 \left(\frac{\cos^3 2\pi t \sin 2\pi t}{4 \cdot 2\pi} + \frac{4-1}{4} \int \cos^2 2\pi t dt \right)$$

(We used FORMULA 61 with $a = 2\pi, n = 4$)

$$= \frac{\cos^3 2\pi t \sin 2\pi t}{\pi} + 6 \left[\frac{t}{2} + \frac{\sin(2 \cdot 2\pi t)}{4 \cdot 2\pi} \right] + C$$

(We used FORMULA 59 with $a = 2\pi$)

$$= \frac{\cos^3 2\pi t \sin 2\pi t}{\pi} + 3t + \frac{3 \sin 4\pi t}{4\pi} + C = \frac{\cos^3 2\pi t \sin 2\pi t}{\pi} + \frac{3 \cos 2\pi t \sin 2\pi t}{2\pi} + 3t + C$$

$$43. \int \sin^2 2\theta \cos^3 2\theta d\theta = \frac{\sin^3 2\theta \cos^2 2\theta}{2(2+3)} + \frac{3-1}{3+2} \int \sin^2 2\theta \cos 2\theta d\theta$$

(We used FORMULA 69 with $a = 2, m = 3, n = 2$)

$$= \frac{\sin^3 2\theta \cos^2 2\theta}{10} + \frac{2}{5} \int \sin^2 2\theta \cos 2\theta d\theta = \frac{\sin^3 2\theta \cos^2 2\theta}{10} + \frac{2}{5} \left[\frac{1}{2} \int \sin^2 2\theta (\cos 2\theta) 2d\theta \right] = \frac{\sin^3 2\theta \cos^2 2\theta}{10} + \frac{\sin^3 2\theta}{15} + C$$

$$44. \int 2 \sin^2 t \sec^4 t dt = \int 2 \sin^2 t \cos^{-4} t dt = 2 \left(-\frac{\sin t \cos^{-3} t}{2-4} + \frac{2-1}{2-4} \int \cos^{-4} t dt \right)$$

(We used FORMULA 68 with $a = 1, n = 2, m = -4$)

$$= \sin t \cos^{-3} t - \int \cos^{-4} t dt = \sin t \cos^{-3} t - \int \sec^4 t dt = \sin t \cos^{-3} t - \left(\frac{\sec^2 t \tan t}{4-1} + \frac{4-2}{4-1} \int \sec^2 t dt \right)$$

(We used FORMULA 92 with $a = 1, n = 4$)

$$= \sin t \cos^{-3} t - \left(\frac{\sec^2 t \tan t}{3} \right) - \frac{2}{3} \tan t + C = \frac{2}{3} \sec^2 t \tan t - \frac{2}{3} \tan t + C = \frac{2}{3} \tan t (\sec^2 t - 1) + C = \frac{2}{3} \tan^3 t + C$$

An easy way to find the integral using substitution:

$$\int 2 \sin^2 t \cos^{-4} t dt = \int 2 \tan^2 t \sec^2 t dt = 2 \int (\tan t)^2 \sec^2 t dt = \frac{2}{3} \tan^3 t + C$$

$$45. \int 4 \tan^3 2x \, dx = 4 \left(\frac{\tan^2 2x}{2 \cdot 2} - \int \tan 2x \, dx \right) = \tan^2 2x - 4 \int \tan 2x \, dx$$

(We used FORMULA 86 with $n = 3, a = 2$)

$$= \tan^2 2x - \frac{4}{2} \ln |\sec 2x| + C = \tan^2 2x - 2 \ln |\sec 2x| + C$$

$$46. \int 8 \cot^4 t \, dt = 8 \left(-\frac{\cot^3 t}{3} - \int \cot^2 t \, dt \right)$$

(We used FORMULA 87 with $a = 1, n = 4$)

$$= 8 \left(-\frac{1}{3} \cot^3 t + \cot t + t \right) + C$$

(We used FORMULA 85 with $a = 1$)

$$47. \int 2 \sec^3 \pi x \, dx = 2 \left[\frac{\sec \pi x \tan \pi x}{\pi(3-1)} + \frac{3-2}{3-1} \int \sec \pi x \, dx \right]$$

(We used FORMULA 92 with $n = 3, a = \pi$)

$$= \frac{1}{\pi} \sec \pi x \tan \pi x + \frac{1}{\pi} \ln |\sec \pi x + \tan \pi x| + C$$

(We used FORMULA 88 with $a = \pi$)

$$48. \int 3 \sec^4 3x \, dx = 3 \left[\frac{\sec^2 3x \tan 3x}{3(4-1)} + \frac{4-2}{4-1} \int \sec^2 3x \, dx \right]$$

(We used FORMULA 92 with $n = 4, a = 3$)

$$= \frac{\sec^2 3x \tan 3x}{3} + \frac{2}{3} \tan 3x + C$$

(We used FORMULA 90 with $a = 3$)

$$49. \int \csc^5 x \, dx = -\frac{\csc^3 x \cot x}{5-1} + \frac{5-2}{5-1} \int \csc^3 x \, dx = -\frac{\csc^3 x \cot x}{4} + \frac{3}{4} \left(-\frac{\csc x \cot x}{3-1} + \frac{3-2}{3-1} \int \csc x \, dx \right)$$

(We used FORMULA 93 with $n = 5, a = 1$ and $n = 3, a = 1$)

$$= -\frac{1}{4} \csc^3 x \cot x - \frac{3}{8} \csc x \cot x - \frac{3}{8} \ln |\csc x + \cot x| + C$$

(We used FORMULA 89 with $a = 1$)

$$50. \int 16x^3 (\ln x)^2 \, dx = 16 \left[\frac{x^4 (\ln x)^2}{4} - \frac{2}{4} \int x^3 \ln x \, dx \right] = 16 \left[\frac{x^4 (\ln x)^2}{4} - \frac{1}{2} \left[\frac{x^4 (\ln x)}{4} - \frac{1}{4} \int x^3 \, dx \right] \right]$$

(We used FORMULA 110 with $a = 1, n = 3, m = 2$ and $a = 1, n = 3, m = 1$)

$$= 16 \left(\frac{x^4 (\ln x)^2}{4} - \frac{x^4 (\ln x)}{8} + \frac{x^4}{32} \right) + C = 4x^4 (\ln x)^2 - 2x^4 \ln x + \frac{x^4}{2} + C$$

$$51. \int e^t \sec^3 (e^t - 1) \, dt; \left[x = e^t - 1, dx = e^t \, dt \right] \rightarrow \int \sec^3 x \, dx = \frac{\sec x \tan x}{3-1} + \frac{3-2}{3-1} \int \sec x \, dx$$

(We used FORMULA 92 with $a = 1, n = 3$)

$$= \frac{\sec x \tan x}{2} + \frac{1}{2} \ln |\sec x + \tan x| + C = \frac{1}{2} \left[\sec (e^t - 1) \tan (e^t - 1) + \ln |\sec (e^t - 1) + \tan (e^t - 1)| \right] + C$$

$$52. \int \frac{\csc^3 \sqrt{\theta}}{\sqrt{\theta}} d\theta; \begin{cases} t = \sqrt{\theta} \\ \theta = t^2 \\ d\theta = 2t dt \end{cases} \rightarrow 2 \int \csc^3 t dt = 2 \left[-\frac{\csc t \cot t}{3-1} + \frac{3-2}{3-1} \int \csc t dt \right] = 2 \left[-\frac{\csc t \cot t}{2} - \frac{1}{2} \ln |\csc t + \cot t| \right] + C$$

(We used FORMULA 93 with $a = 1, n = 3$)

$$= -\csc \sqrt{\theta} \cot \sqrt{\theta} - \ln |\csc \sqrt{\theta} + \cot \sqrt{\theta}| + C$$

$$53. \int_0^1 2\sqrt{x^2+1} dx; [x = \tan t, dx = \sec^2 t dt] \rightarrow 2 \int_0^{\pi/4} \sec t \cdot \sec^2 t dt = 2 \int_0^{\pi/4} \sec^3 t dt$$

$$= 2 \left[\left[\frac{\sec t \cdot \tan t}{3-1} \right]_0^{\pi/4} + \frac{3-2}{3-1} \int_0^{\pi/4} \sec t dt \right]$$

(We used FORMULA 92 with $n = 3, a = 1$)

$$= \left[\sec t \cdot \tan t + \ln |\sec t + \tan t| \right]_0^{\pi/4} = \sqrt{2} + \ln(\sqrt{2} + 1)$$

$$54. \int_0^{\sqrt{3}/2} \frac{dy}{(1-y^2)^{5/2}}; [y = \sin x, dy = \cos x dx] \rightarrow \int_0^{\pi/3} \frac{\cos x dx}{\cos^5 x} = \int_0^{\pi/3} \sec^4 x dx = \left[\frac{\sec^2 x \tan x}{4-1} \right]_0^{\pi/3} + \frac{4-2}{4-1} \int_0^{\pi/3} \sec^2 x dx$$

(We used FORMULA 92 with $a = 1, n = 4$)

$$= \left[\frac{\sec^2 x \tan x}{3} + \frac{2}{3} \tan x \right]_0^{\pi/3} = \left(\frac{4}{3} \right) \sqrt{3} + \left(\frac{2}{3} \right) \sqrt{3} = 2\sqrt{3}$$

$$55. \int_1^2 \frac{(r^2-1)^{3/2}}{r} dr; [r = \sec \theta, dr = \sec \theta \tan \theta d\theta] \rightarrow \int_0^{\pi/3} \frac{\tan^3 \theta}{\sec \theta} (\sec \theta \tan \theta) d\theta = \int_0^{\pi/3} \tan^4 \theta d\theta$$

$$= \left[\frac{\tan^3 \theta}{4-1} \right]_0^{\pi/3} - \int_0^{\pi/3} \tan^2 \theta d\theta = \left[\frac{\tan^3 \theta}{3} - \tan \theta + \theta \right]_0^{\pi/3} = \frac{3\sqrt{3}}{3} - \sqrt{3} + \frac{\pi}{3} = \frac{\pi}{3}$$

(We used FORMULA 86 with $a = 1, n = 4$ and FORMULA 84 with $a = 1$)

$$56. \int_0^{1/\sqrt{3}} \frac{dt}{(t^2+1)^{7/2}}; [t = \tan \theta, dt = \sec^2 \theta d\theta] \rightarrow \int_0^{\pi/6} \frac{\sec^2 \theta d\theta}{\sec^7 \theta} = \int_0^{\pi/6} \cos^5 \theta d\theta$$

$$= \left[\frac{\cos^4 \theta \sin \theta}{5} \right]_0^{\pi/6} + \left(\frac{5-1}{5} \right) \int_0^{\pi/6} \cos^3 \theta d\theta = \left[\frac{\cos^4 \theta \sin \theta}{5} \right]_0^{\pi/6} + \frac{4}{5} \left[\frac{\cos^2 \theta \sin \theta}{3} \right]_0^{\pi/6} + \left(\frac{3-1}{3} \right) \int_0^{\pi/6} \cos \theta d\theta$$

$$= \left[\frac{\cos^4 \theta \sin \theta}{5} + \frac{4}{15} \cos^2 \theta \sin \theta + \frac{8}{15} \sin \theta \right]_0^{\pi/6}$$

(We used FORMULA 61 with $a = 1, n = 5$ and $a = 1, n = 3$)

$$= \frac{\left(\frac{\sqrt{3}}{2}\right)^4 \left(\frac{1}{2}\right)}{5} + \left(\frac{4}{15}\right) \left(\frac{\sqrt{3}}{2}\right)^2 \left(\frac{1}{2}\right) + \left(\frac{8}{15}\right) \left(\frac{1}{2}\right) = \frac{9}{160} + \frac{1}{10} + \frac{4}{15} = \frac{3 \cdot 9 + 48 + 32 \cdot 4}{480} = \frac{203}{480}$$

$$57. S = \int_0^{\sqrt{2}} 2\pi y \sqrt{1+(y')^2} dx$$

$$= 2\pi \int_0^{\sqrt{2}} \sqrt{x^2+2} \sqrt{1+\frac{x^2}{x^2+2}} dx$$

$$= 2\sqrt{2}\pi \int_0^{\sqrt{2}} \sqrt{x^2+1} dx$$

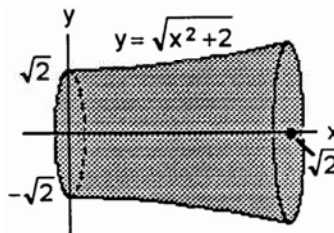

$$= 2\sqrt{2}\pi \left[\frac{x\sqrt{x^2+1}}{2} + \frac{1}{2} \ln \left| x + \sqrt{x^2+1} \right| \right]_0^{\sqrt{2}}$$

(We used FORMULA 21 with $a = 1$)

$$= \sqrt{2}\pi \left[\sqrt{6} + \ln(\sqrt{2} + \sqrt{3}) \right] = 2\pi\sqrt{3} + \pi\sqrt{2} \ln(\sqrt{2} + \sqrt{3})$$

58. $L = \int_0^{\sqrt{3}/2} \sqrt{1+(2x)^2} dx = 2 \int_0^{\sqrt{3}/2} \sqrt{\frac{1}{4} + x^2} dx = 2 \left[\frac{x}{2} \sqrt{\frac{1}{4} + x^2} + \left(\frac{1}{4}\right) \left(\frac{1}{2}\right) \ln \left(x + \sqrt{\frac{1}{4} + x^2} \right) \right]_0^{\sqrt{3}/2}$

(We used FORMULA 2 with $a = \frac{1}{2}$)

$$= \left[\frac{x}{2} \sqrt{1+4x^2} + \frac{1}{4} \ln \left(x + \frac{1}{2} \sqrt{1+4x^2} \right) \right]_0^{\sqrt{3}/2} = \frac{\sqrt{3}}{4} \sqrt{1+4\left(\frac{3}{4}\right)} + \frac{1}{4} \ln \left(\frac{\sqrt{3}}{2} + \frac{1}{2} \sqrt{1+4\left(\frac{3}{4}\right)} \right) - \frac{1}{4} \ln \frac{1}{2}$$

$$= \frac{\sqrt{3}}{4} (2) + \frac{1}{4} \ln \left(\frac{\sqrt{3}}{2} + 1 \right) + \frac{1}{4} \ln 2 = \frac{\sqrt{3}}{2} + \frac{1}{4} \ln(\sqrt{3} + 2)$$

59. $A = \int_0^3 \frac{dx}{\sqrt{x+1}} = \left[2\sqrt{x+1} \right]_0^3 = 2;$

$$\bar{x} = \frac{1}{A} \int_0^3 \frac{x dx}{\sqrt{x+1}} = \frac{1}{A} \int_0^3 \sqrt{x+1} dx - \frac{1}{A} \int_0^3 \frac{dx}{\sqrt{x+1}}$$

$$= \frac{1}{2} \cdot \frac{2}{3} \left[(x+1)^{3/2} \right]_0^3 - 1 = \frac{4}{3};$$

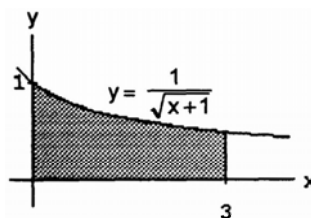

(We used FORMULA 11 with $a = 1, b = 1, n = 1$ and $a = 1, b = 1, n = -1$)

$$\bar{y} = \frac{1}{2A} \int_0^3 \frac{dx}{x+1} = \frac{1}{4} \left[\ln(x+1) \right]_0^3 = \frac{1}{4} \ln 4 = \frac{1}{2} \ln 2 = \ln \sqrt{2}$$

60. $M_y = \int_0^3 x \left(\frac{36}{2x+3} \right) dx = 18 \int_0^3 \frac{2x+3}{2x+3} dx - 54 \int_0^3 \frac{dx}{2x+3} = \left[18x - 27 \ln |2x+3| \right]_0^3 = 18 \cdot 3 - 27 \ln 9 - (-27 \ln 3)$

$$= 54 - 27 \cdot 2 \ln 3 + 27 \ln 3 = 54 - 27 \ln 3$$

61. $S = 2\pi \int_{-1}^1 x^2 \sqrt{1+4x^2} dx; [u = 2x, du = 2 dx]$

$$\rightarrow \frac{\pi}{4} \int_{-2}^2 u^2 \sqrt{1+u^2} du$$

$$= \frac{\pi}{4} \left[\frac{u}{8} (1+2u^2) \sqrt{1+u^2} - \frac{1}{8} \ln \left(u + \sqrt{1+u^2} \right) \right]_{-2}^2$$

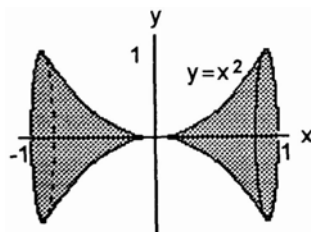

(We used FORMULA 22 with $a = 1$)

$$= \frac{\pi}{4} \left[\frac{2}{8} (1+2 \cdot 4) \sqrt{1+4} - \frac{1}{8} \ln(2 + \sqrt{1+4}) + \frac{2}{8} (1+2 \cdot 4) \sqrt{1+4} + \frac{1}{8} \ln(-2 + \sqrt{1+4}) \right]$$

$$= \frac{\pi}{4} \left[\frac{9}{2} \sqrt{5} - \frac{1}{8} \ln \left(\frac{2+\sqrt{5}}{-2+\sqrt{5}} \right) \right] \approx 7.62$$

62. (a) The volume of the filled part equals the length of the tank times the area of the shaded region shown in the accompanying figure. Consider a layer of gasoline of thickness dy located at height y where $-r < y < -r + d$. The width of this layer is $2\sqrt{r^2 - y^2}$. Therefore,

$$A = 2 \int_{-r}^{-r+d} \sqrt{r^2 - y^2} dy \text{ and}$$

$$V = L \cdot A = 2L \int_{-r}^{-r+d} \sqrt{r^2 - y^2} dy$$

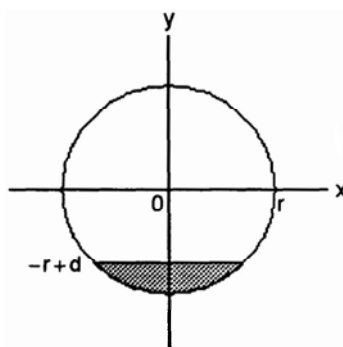

$$(b) \quad 2L \int_{-r}^{-r+d} \sqrt{r^2 - y^2} dy = 2L \left[\frac{y\sqrt{r^2 - y^2}}{2} + \frac{r^2}{2} \sin^{-1} \frac{y}{r} \right]_{-r}^{-r+d}$$

(We used FORMULA 29 with $a = r$)

$$= 2L \left[\frac{(d-r)}{2} \sqrt{2rd - d^2} + \frac{r^2}{2} \sin^{-1} \left(\frac{d-r}{r} \right) + \frac{r^2}{2} \left(\frac{\pi}{2} \right) \right] = 2L \left[\left(\frac{d-r}{2} \right) \sqrt{2rd - d^2} + \left(\frac{r^2}{2} \right) \left(\sin^{-1} \left(\frac{d-r}{r} \right) + \frac{\pi}{2} \right) \right]$$

63. The integrand $f(x) = \sqrt{x - x^2}$ is nonnegative, so the integral is maximized by integrating over the function's entire domain, which runs from $x = 0$ to $x = 1$

$$\Rightarrow \int_0^1 \sqrt{x - x^2} dx = \int_0^1 \sqrt{2 \cdot \frac{1}{2} x - x^2} dx = \left[\frac{(x-\frac{1}{2})}{2} \sqrt{2 \cdot \frac{1}{2} x - x^2} + \frac{(\frac{1}{2})^2}{2} \sin^{-1} \left(\frac{x-\frac{1}{2}}{\frac{1}{2}} \right) \right]_0^1$$

(We used FORMULA 48 with $a = \frac{1}{2}$)

$$= \left[\frac{(x-\frac{1}{2})}{2} \sqrt{x - x^2} + \frac{1}{8} \sin^{-1} (2x - 1) \right]_0^1 = \frac{1}{8} \cdot \frac{\pi}{2} - \frac{1}{8} \left(-\frac{\pi}{2} \right) = \frac{\pi}{8}$$

64. The integrand is maximized by integrating $g(x) = x\sqrt{2x - x^2}$ over the largest domain on which g is nonnegative, namely $[0, 2]$

$$\Rightarrow \int_0^2 x\sqrt{2x - x^2} dx = \left[\frac{(x+1)(2x-3)\sqrt{2x-x^2}}{6} + \frac{1}{2} \sin^{-1} (x-1) \right]_0^2$$

(We used FORMULA 51 with $a = 1$)

$$= \frac{1}{2} \cdot \frac{\pi}{2} - \frac{1}{2} \left(-\frac{\pi}{2} \right) = \frac{\pi}{2}$$

CAS EXPLORATIONS

65. Example CAS commands:

Maple:

$$q1 := \text{Int}(x \cdot \ln(x), x); \quad \# (a)$$

$$q1 = \text{value}(q1);$$

$$q2 := \text{Int}(x^2 \cdot \ln(x), x); \quad \# (b)$$

$$q2 = \text{value}(q2);$$

$$q3 := \text{Int}(x^3 \cdot \ln(x), x); \quad \# (c)$$

```

q3 = value( q3 );
q4 := Int( x^4*ln(x), x );           # (d)
q4 = value( q4 );
q5 := Int( x^n*ln(x), x );           # (e)
q6 = value( q5 );
q7 := simplify(q6) assuming n::integer;
q5 = collect( factor(q7), ln(x) );

```

66. Example CAS commands:

Maple:

```

q1 := Int( ln(x)/x, x );             # (a)
q1 = value( q1 );
q2 := Int( ln(x)/x^2, x );           # (b)
q2 = value( q2 );
q3 := Int( ln(x)/x^3, x );           # (c)
q3 = value( q3 );
q4 := Int( ln(x)/x^4, x );           # (d)
q4 = value( q4 );
q5 := Int( ln(x)/x^n, x );           # (e)
q6 := value( q5 );
q7 := simplify(q6) assuming n::integer;
q5 = collect( factor(q7), ln(x) );

```

67. Example CAS commands:

Maple:

```

q := Int( sin(x)^n/sin(x)^n+cos(x)^n, x=0..Pi/2 ); # (a)
q = value( q );
q1 := eval( q, n=1 );                 # (b)
q1 = value( q1 );
for N in [1,2,3,5,7] do
  q1 := eval( q, n=N );
  print( q1 = evalf(q1) );
end do;
qq1 := PDEtools[dchange]( x=Pi/2-u, q, [u] ); # (c)
qq2 := subs( u=x, qq1 );
qq3 := q + q = q + qq2;
qq4 := combine( qq3 );

```

```
qq5 := value( qq4 );
simplify( qq5/2 );
```

65-67. Example CAS commands:

Mathematica: (functions may vary)

In Mathematica, the natural log is denoted by Log rather than Ln, Log base 10 is Log[x, 10]

Mathematica does not include an arbitrary constant when computing an indefinite integral,

```
Clear[x, f, n]
```

```
f[x_]:=Log[x]/x^n
```

```
Integrate[f[x], x]
```

For exercise 67, Mathematica cannot evaluate the integral with arbitrary n . It does evaluate the integral (value is $\pi/4$ in each case) for small values of n , but for large values of n , it identifies this integral as Indeterminate

65. (e) $\int x^n \ln x \, dx = \frac{x^{n+1} \ln x}{n+1} - \frac{1}{n+1} \int x^n \, dx, n \neq -1$
 (We used FORMULA 110 with $a = 1, m = 1$)
 $= \frac{x^{n+1} \ln x}{n+1} - \frac{x^{n+1}}{(n+1)^2} + C = \frac{x^{n+1}}{n+1} \left(\ln x - \frac{1}{n+1} \right) + C$

66. (e) $\int x^{-n} \ln x \, dx = \frac{x^{-n+1} \ln x}{-n+1} - \frac{1}{(-n+1)} \int x^{-n} \, dx, n \neq 1$
 (We used FORMULA 110 with $a = 1, m = 1, n = -n$)
 $= \frac{x^{1-n} \ln x}{1-n} - \frac{1}{1-n} \left(\frac{x^{1-n}}{1-n} \right) + C = \frac{x^{1-n}}{1-n} \left(\ln x - \frac{1}{1-n} \right) + C$

67. (a) Neither MAPLE nor MATHEMATICA can find this integral for arbitrary n .

(b) MAPLE and MATHEMATICA get stuck at about $n = 5$.

(c) Let $x = \frac{\pi}{2} - u \Rightarrow dx = -du$; $x = 0 \Rightarrow u = \frac{\pi}{2}$, $x = \frac{\pi}{2} \Rightarrow u = 0$;

$$I = \int_0^{\pi/2} \frac{\sin^n x \, dx}{\sin^n x + \cos^n x} = \int_{\pi/2}^0 \frac{-\sin^n(\frac{\pi}{2}-u) \, du}{\sin^n(\frac{\pi}{2}-u) + \cos^n(\frac{\pi}{2}-u)} = \int_0^{\pi/2} \frac{\cos^n u \, du}{\cos^n u + \sin^n u} = \int_0^{\pi/2} \frac{\cos^n x \, dx}{\cos^n x + \sin^n x}$$

$$\Rightarrow I + I = \int_0^{\pi/2} \left(\frac{\sin^n x + \cos^n x}{\sin^n x + \cos^n x} \right) dx = \int_0^{\pi/2} dx = \frac{\pi}{2} \Rightarrow I = \frac{\pi}{4}$$

8.7 NUMERICAL INTEGRATION

1. $\int_1^2 x \, dx$

I. (a) For $n = 4$, $\Delta x = \frac{b-a}{n} = \frac{2-1}{4} = \frac{1}{4} \Rightarrow \frac{\Delta x}{2} = \frac{1}{8}$;

$\sum mf(x_i) = 12 \Rightarrow T = \frac{1}{8}(12) = \frac{3}{2}$;

$f(x) = x \Rightarrow f'(x) = 1 \Rightarrow f'' = 0$

$\Rightarrow M = 0 \Rightarrow |E_T| = 0$

(b) $\int_1^2 x \, dx = \left[\frac{x^2}{2} \right]_1^2 = 2 - \frac{1}{2} = \frac{3}{2}$

$\Rightarrow |E_T| = \int_1^2 x \, dx - T = 0$

(c) $\frac{|E_T|}{\text{True Value}} \times 100 = 0\%$

II. (a) For $n = 4$, $\Delta x = \frac{b-a}{n} = \frac{2-1}{4} = \frac{1}{4} \Rightarrow \frac{\Delta x}{3} = \frac{1}{12}$;

$\sum mf(x_i) = 18 \Rightarrow S = \frac{1}{12}(18) = \frac{3}{2}$;

$f^{(4)}(x) = 0 \Rightarrow M = 0 \Rightarrow |E_S| = 0$

(b) $\int_1^2 x \, dx = \frac{3}{2} \Rightarrow |E_S| = \int_1^2 x \, dx - S = \frac{3}{2} - \frac{3}{2} = 0$

(c) $\frac{|E_S|}{\text{True Value}} \times 100 = 0\%$

	x_i	$f(x_i)$	m	$mf(x_i)$
x_0	1	1	1	1
x_1	5/4	5/4	2	5/2
x_2	3/2	3/2	2	3
x_3	7/4	7/4	2	7/2
x_4	2	2	1	2

	x_i	$f(x_i)$	m	$mf(x_i)$
x_0	1	1	1	1
x_1	5/4	5/4	4	5
x_2	3/2	3/2	2	3
x_3	7/4	7/4	4	7
x_4	2	2	1	2

2. $\int_1^3 (2x-1) \, dx$

I. (a) For $n = 4$, $\Delta x = \frac{b-a}{n} = \frac{3-1}{4} = \frac{2}{4} = \frac{1}{2}$

$\Rightarrow \frac{\Delta x}{2} = \frac{1}{4}$;

$\sum mf(x_i) = 24 \Rightarrow T = \frac{1}{4}(24) = 6$;

$f(x) = 2x-1 \Rightarrow f'(x) = 2 \Rightarrow f'' = 0$

$\Rightarrow M = 0 \Rightarrow |E_T| = 0$

(b) $\int_1^3 (2x-1) \, dx = \left[x^2 - x \right]_1^3 = (9-3) - (1-1) = 6 \Rightarrow |E_T| = \int_1^3 (2x-1) \, dx - T = 6 - 6 = 0$

(c) $\frac{|E_S|}{\text{True Value}} \times 100 = 0\%$

	x_i	$f(x_i)$	m	$mf(x_i)$
x_0	1	1	1	1
x_1	3/2	2	2	4
x_2	2	3	2	6
x_3	5/2	4	2	8
x_4	3	5	1	5

II. (a) For $n = 4$, $\Delta x = \frac{b-a}{n} = \frac{3-1}{4} = \frac{2}{4} = \frac{1}{2} \Rightarrow \frac{\Delta x}{3} = \frac{1}{6}$;

$\sum mf(x_i) = 36 \Rightarrow S = \frac{1}{6}(36) = 6$;

$f^{(4)}(x) = 0 \Rightarrow M = 0 \Rightarrow |E_S| = 0$

(b) $\int_1^3 (2x-1) \, dx = 6 \Rightarrow |E_S| = \int_1^3 (2x-1) \, dx - S = 6 - 6 = 0$

(c) $\frac{|E_S|}{\text{True Value}} \times 100 = 0\%$

	x_i	$f(x_i)$	m	$mf(x_i)$
x_0	1	1	1	1
x_1	3/2	2	4	8
x_2	2	3	2	6
x_3	5/2	4	4	16
x_4	3	5	1	5

3. $\int_{-1}^1 (x^2 + 1) dx$

- I. (a) For $n = 4$, $\Delta x = \frac{b-a}{n} = \frac{1-(-1)}{4} = \frac{2}{4} = \frac{1}{2} \Rightarrow \frac{\Delta x}{2} = \frac{1}{4}$;
 $\sum mf(x_i) = 11 \Rightarrow T = \frac{1}{4}(11) = 2.75$;
 $f(x) = x^2 + 1 \Rightarrow f'(x) = 2x \Rightarrow f''(x) = 2$
 $\Rightarrow M = 2 \Rightarrow |E_T| \leq \frac{1-(-1)}{12} \left(\frac{1}{2}\right)^2 (2) = \frac{1}{12}$ or
 0.08333

	x_i	$f(x_i)$	m	$mf(x_i)$
x_0	-1	2	1	2
x_1	-1/2	5/4	2	5/2
x_2	0	1	2	2
x_3	1/2	5/4	2	5/2
x_4	1	2	1	2

(b) $\int_{-1}^1 (x^2 + 1) dx = \left[\frac{x^3}{3} + x \right]_{-1}^1 = \left(\frac{1}{3} + 1\right) - \left(-\frac{1}{3} - 1\right) = \frac{8}{3} \Rightarrow E_T = \int_{-1}^1 (x^2 + 1) dx - T = \frac{8}{3} - \frac{11}{4} = -\frac{1}{12}$
 $\Rightarrow |E_T| = \left| -\frac{1}{12} \right| \approx 0.08333$

(c) $\frac{|E_T|}{\text{True Value}} \times 100 = \left(\frac{\frac{1}{12}}{\frac{8}{3}}\right) \times 100 \approx 3\%$

- II. (a) For $n = 4$, $\Delta x = \frac{b-a}{n} = \frac{1-(-1)}{4} = \frac{2}{4} = \frac{1}{2} \Rightarrow \frac{\Delta x}{3} = \frac{1}{6}$;
 $\sum mf(x_i) = 16 \Rightarrow S = \frac{1}{6}(16) = \frac{8}{3} = 2.66667$;
 $f^3(x) = 0 \Rightarrow f(4)(x) = 0 \Rightarrow M = 0$
 $\Rightarrow |E_S| = 0$

	x_i	$f(x_i)$	m	$mf(x_i)$
x_0	-1	2	1	2
x_1	-1/2	5/4	4	5
x_2	0	1	2	2
x_3	1/2	5/4	4	5
x_4	1	2	1	2

(b) $\int_{-1}^1 (x^2 + 1) dx = \left[\frac{x^3}{3} + x \right]_{-1}^1 = \frac{8}{3}$
 $\Rightarrow |E_S| = \int_{-1}^1 (x^2 + 1) dx - S = \frac{8}{3} - \frac{8}{3} = 0$

(c) $\frac{|E_S|}{\text{True Value}} \times 100 = 0\%$

4. $\int_{-2}^0 (x^2 - 1) dx$

- I. (a) For $n = 4$, $\Delta x = \frac{b-a}{n} = \frac{0-(-2)}{4} = \frac{2}{4} = \frac{1}{2}$
 $\Rightarrow \frac{\Delta x}{2} = \frac{1}{4}$; $\sum mf(x_i) = 3 \Rightarrow T = \frac{1}{4}(3) = \frac{3}{4}$;
 $f(x) = x^2 - 1 \Rightarrow f'(x) = 2x \Rightarrow f''(x) = 2$
 $\Rightarrow M = 2 \Rightarrow |E_T| \leq \frac{0-(-2)}{12} \left(\frac{1}{2}\right)^2 (2) = \frac{1}{12}$
 ≈ 0.08333

	x_i	$f(x_i)$	m	$mf(x_i)$
x_0	-2	3	1	3
x_1	-3/2	5/4	2	5/2
x_2	-1	0	2	0
x_3	-1/2	-3/4	2	-3/2
x_4	0	-1	1	-1

(b) $\int_{-2}^0 (x^2 - 1) dx = \left[\frac{x^3}{3} - x \right]_{-2}^0 = 0 - \left(-\frac{8}{3} + 2\right) = \frac{2}{3} \Rightarrow E_T = \int_{-2}^0 (x^2 - 1) dx - T = \frac{2}{3} - \frac{3}{4} = -\frac{1}{12} \Rightarrow |E_T| = \frac{1}{12}$

(c) $\frac{|E_T|}{\text{True Value}} \times 100 = \left(\frac{\frac{1}{12}}{\frac{2}{3}}\right) \times 100 \approx 13\%$

- II. (a) For $n = 4$, $\Delta x = \frac{b-a}{n} = \frac{0-(-2)}{4} = \frac{2}{4} = \frac{1}{2} \Rightarrow \frac{\Delta x}{3} = \frac{1}{6}$;
 $\sum mf(x_i) = 4 \Rightarrow S = \frac{1}{6}(4) = \frac{2}{3}$; $f^{(3)}(x) = 0$
 $\Rightarrow f^{(4)}(x) = 0 \Rightarrow M = 0 \Rightarrow |E_s| = 0$
 (b) $\int_{-2}^0 (x^2 - 1) dx = \frac{2}{3} \Rightarrow |E_s| = \int_{-2}^0 (x^2 - 1) dx - S$
 $= \frac{2}{3} - \frac{2}{3} = 0$
 (c) $\frac{|E_s|}{\text{True Value}} \times 100 = 0\%$

	x_i	$f(x_i)$	m	$mf(x_i)$	
	x_0	-2	3	1	3
	x_1	-3/2	5/4	4	5
	x_2	-1	0	2	0
	x_3	-1/2	-3/4	4	-3
	x_4	0	-1	1	-1

5. $\int_0^2 (t^3 + t) dt$

- I. (a) For $n = 4$, $\Delta x = \frac{b-a}{n} = \frac{2-0}{4} = \frac{2}{4} = \frac{1}{2} \Rightarrow \frac{\Delta x}{2} = \frac{1}{4}$;
 $\sum mf(t_i) = 25 \Rightarrow T = \frac{1}{4}(25) = \frac{25}{4}$;
 $f(t) = t^3 + t \Rightarrow f'(t) = 3t^2 + 1 \Rightarrow f''(t) = 6t$
 $\Rightarrow M = 12 = f''(2) \Rightarrow |E_T| \leq \frac{2-0}{12} \left(\frac{1}{2}\right)^2 (12) = \frac{1}{2}$

	t_i	$f(t_i)$	m	$mf(t_i)$	
	t_0	0	0	1	0
	t_1	1/2	5/8	2	5/4
	t_2	1	2	2	4
	t_3	3/2	39/8	2	39/4
	t_4	2	10	1	10

(b) $\int_0^2 (t^3 + t) dt = \left[\frac{t^4}{4} + \frac{t^2}{2} \right]_0^2 = \left(\frac{2^4}{4} + \frac{2^2}{2} \right) - 0 = 6 \Rightarrow |E_T| = \int_0^2 (t^3 + t) dt - T = 6 - \frac{25}{4} = -\frac{1}{4} \Rightarrow |E_T| = \frac{1}{4}$

(c) $\frac{|E_T|}{\text{True Value}} \times 100 = \frac{|\frac{-1}{4}|}{6} \times 100 \approx 4\%$

- II. (a) For $n = 4$, $\Delta x = \frac{b-a}{n} = \frac{2-0}{4} = \frac{2}{4} = \frac{1}{2} \Rightarrow \frac{\Delta x}{3} = \frac{1}{6}$;
 $\sum mf(t_i) = 36 \Rightarrow S = \frac{1}{6}(36) = 6$;
 $f^{(3)}(t) = 6 \Rightarrow f^{(4)}(t) = 0 \Rightarrow M = 0 \Rightarrow |E_s| = 0$

	t_i	$f(t_i)$	m	$mf(t_i)$	
	t_0	0	0	1	0
	t_1	1/2	5/8	4	5/2
	t_2	1	2	2	4
	t_3	3/2	39/8	4	39/2
	t_4	2	10	1	10

(b) $\int_0^2 (t^3 + t) dt = 6 \Rightarrow |E_s| = \int_0^2 (t^3 + t) dt - S$
 $= 6 - 6 = 0$

(c) $\frac{|E_s|}{\text{True Value}} \times 100 = 0\%$

6. $\int_{-1}^1 (t^3 + 1) dt$

- I. (a) For $n = 4$, $\Delta x = \frac{b-a}{n} = \frac{1-(-1)}{4} = \frac{2}{4} = \frac{1}{2} \Rightarrow \frac{\Delta x}{2} = \frac{1}{4}$;
 $\sum mf(t_i) = 8 \Rightarrow T = \frac{1}{4}(8) = 2$;
 $f(t) = t^3 + 1 \Rightarrow f'(t) = 3t^2 \Rightarrow f''(t) = 6t$
 $\Rightarrow M = 6 = f''(1) \Rightarrow |E_T| \leq \frac{1-(-1)}{12} \left(\frac{1}{2}\right)^2 (6) = \frac{1}{4}$

	t_i	$f(t_i)$	m	$mf(t_i)$	
	t_0	-1	0	1	0
	t_1	-1/2	7/8	2	7/4
	t_2	0	1	2	2
	t_3	1/2	9/8	2	9/4
	t_4	1	2	1	2

(b) $\int_{-1}^1 (t^3 + 1) dt = \left[\frac{t^4}{4} + t \right]_{-1}^1 = \left(\frac{1^4}{4} + 1 \right) - \left(\frac{(-1)^4}{4} + (-1) \right) = 2 \Rightarrow |E_T| = \int_{-1}^1 (t^3 + 1) dt - T = 2 - 2 = 0$

(c) $\frac{|E_T|}{\text{True Value}} \times 100 = 0\%$

- II. (a) For $n = 4$, $\Delta x = \frac{b-a}{n} = \frac{1-(-1)}{4} = \frac{2}{4} = \frac{1}{2} \Rightarrow \frac{\Delta x}{3} = \frac{1}{6}$;
 $\sum mf(t_i) = 12 \Rightarrow S = \frac{1}{6}(12) = 2$;
 $f^{(3)}(t) = 6 \Rightarrow f^{(4)}(t) = 0 \Rightarrow M = 0 \Rightarrow |E_S| = 0$
- (b) $\int_{-1}^1 (t^3 + 1) dt = 2 \Rightarrow |E_S| = \int_{-1}^1 (t^3 + 1) dt - S$
 $= 2 - 2 = 0$
- (c) $\frac{|E_S|}{\text{True Value}} \times 100 = 0\%$

	t_i	$f(t_i)$	m	$mf(t_i)$
	t_0	-1	0	0
	t_1	-1/2	7/8	4
	t_2	0	1	2
	t_3	1/2	9/8	4
	t_4	1	2	1

7. $\int_1^2 \frac{1}{s^2} ds$

- I. (a) For $n = 4$, $\Delta x = \frac{b-a}{n} = \frac{2-1}{4} = \frac{1}{4} \Rightarrow \frac{\Delta x}{2} = \frac{1}{8}$;
 $\sum mf(s_i) = \frac{179,573}{44,100} \Rightarrow T = \frac{1}{8} \left(\frac{179,573}{44,100} \right) = \frac{179,573}{352,800}$
 ≈ 0.50899 ; $f(s) = \frac{1}{s^2} \Rightarrow f'(s) = -\frac{2}{s^3}$
 $\Rightarrow f''(s) = \frac{6}{s^4} \Rightarrow M = 6 = f''(1)$
 $\Rightarrow |E_T| \leq \frac{2-1}{12} \left(\frac{1}{4} \right)^2 (6) = \frac{1}{32} = 0.03125$

	s_i	$f(s_i)$	m	$mf(s_i)$
	s_0	1	1	1
	s_1	5/4	16/25	2
	s_2	3/2	4/9	2
	s_3	7/4	16/49	2
	s_4	2	1/4	1

- (b) $\int_1^2 \frac{1}{s^2} ds = \int_1^2 s^{-2} ds = \left[-\frac{1}{s} \right]_1^2 = -\frac{1}{2} - \left(-\frac{1}{1} \right) = \frac{1}{2} \Rightarrow E_T = \int_1^2 \frac{1}{s^2} ds - T = \frac{1}{2} - 0.50899 = -0.00899$
 $\Rightarrow |E_T| = 0.00899$
- (c) $\frac{|E_T|}{\text{True Value}} \times 100 = \frac{0.00899}{0.5} \times 100 \approx 2\%$

- II. (a) For $n = 4$, $\Delta x = \frac{b-a}{n} = \frac{2-1}{4} = \frac{1}{4} \Rightarrow \frac{\Delta x}{3} = \frac{1}{12}$;
 $\sum mf(s_i) = \frac{264,821}{44,100} \Rightarrow S = \frac{1}{12} \left(\frac{264,821}{44,100} \right)$
 $= \frac{264,821}{529,200} \approx 0.50042$;
 $f^{(3)}(s) = -\frac{24}{s^5} \Rightarrow f^{(4)}(s) = \frac{120}{s^6} \Rightarrow M = 120$
 $\Rightarrow |E_S| \leq \frac{2-1}{180} \left(\frac{1}{4} \right)^4 (120) = \frac{1}{384} \approx 0.00260$

	s_i	$f(s_i)$	m	$mf(s_i)$
	s_0	1	1	1
	s_1	5/4	16/25	4
	s_2	3/2	4/9	2
	s_3	7/4	16/49	4
	s_4	2	1/4	1

- (b) $\int_1^2 \frac{1}{s^2} ds = \frac{1}{2} \Rightarrow E_S = \int_1^2 \frac{1}{s^2} ds - S = \frac{1}{2} - 0.50042 = -0.00042 \Rightarrow |E_S| = 0.00042$
- (c) $\frac{|E_S|}{\text{True Value}} \times 100 = \frac{0.0004}{0.5} \times 100 \approx 0.08\%$

8. $\int_2^4 \frac{1}{(s-1)^2} ds$

- I. (a) For $n = 4$, $\Delta x = \frac{b-a}{n} = \frac{4-2}{4} = \frac{1}{2} \Rightarrow \frac{\Delta x}{2} = \frac{1}{4}$;
 $\sum mf(s_i) = \frac{1269}{450} \Rightarrow T = \frac{1}{4} \left(\frac{1269}{450} \right) = \frac{1269}{1800} = 0.70500$;
 $f(s) = (s-1)^{-2} \Rightarrow f'(s) = \frac{-2}{(s-1)^3} \Rightarrow f''(s) = \frac{6}{(s-1)^4}$
 $\Rightarrow |E_T| \leq \frac{4-2}{12} \left(\frac{1}{2} \right)^2 (6) = \frac{1}{4} = 0.25 \Rightarrow M = 6$

	s_i	$f(s_i)$	m	$mf(s_i)$
	s_0	2	1	1
	s_1	5/2	4/9	2
	s_2	3	1/4	2
	s_3	7/2	4/25	2
	s_4	4	1/9	1

(b) $\int_2^4 \frac{1}{(s-1)^2} ds = \left[\frac{-1}{(s-1)} \right]_2^4 = \left(\frac{-1}{4-1} \right) - \left(\frac{-1}{2-1} \right) = \frac{2}{3} \Rightarrow E_T = \int_2^4 \frac{1}{(s-1)^2} ds - T = \frac{2}{3} - 0.705 \approx -0.03833$
 $\Rightarrow |E_T| \approx 0.03833$

(c) $\frac{|E_T|}{\text{True Value}} \times 100 = \frac{0.03833}{\left(\frac{2}{3}\right)} \times 100 \approx 6\%$

II. (a) For $n = 4$, $\Delta x = \frac{b-a}{n} = \frac{4-2}{4} = \frac{1}{2} \Rightarrow \frac{\Delta x}{3} = \frac{1}{6}$;

$\sum mf(s_i) = \frac{1813}{450} \Rightarrow S = \frac{1}{6} \left(\frac{1813}{450} \right)$
 $= \frac{1813}{2700} \approx 0.67148$; $f^{(3)}(s) = \frac{-24}{(s-1)^5}$
 $\Rightarrow f^{(4)}(s) = \frac{120}{(s-1)^6} \Rightarrow M = 120$
 $\Rightarrow |E_s| \leq \frac{4-2}{180} \left(\frac{1}{2} \right)^4 (120) = \frac{1}{12} \approx 0.08333$

	s_i	$f(s_i)$	m	$mf(s_i)$
	s_0	2	1	1
	s_1	5/2	4	16/9
	s_2	3	2	1/2
	s_3	7/2	4	16/25
	s_4	4	1	1/9

(b) $\int_2^4 \frac{1}{(s-1)^2} ds = \frac{2}{3} \Rightarrow E_s = \int_2^4 \frac{1}{(s-1)^2} ds - S \approx \frac{2}{3} - 0.67148 = -0.00481 \Rightarrow |E_s| \approx 0.00481$

(c) $\frac{|E_s|}{\text{True Value}} \times 100 = \frac{0.00481}{\left(\frac{2}{3}\right)} \times 100 \approx 1\%$

9. $\int_0^\pi \sin t dt$

I. (a) For $n = 4$, $\Delta x = \frac{b-a}{n} = \frac{\pi-0}{4} = \frac{\pi}{4} \Rightarrow \frac{\Delta x}{2} = \frac{\pi}{8}$;

$\sum mf(t_i) = 2 + 2\sqrt{2} \approx 4.8284$;
 $\Rightarrow T = \frac{\pi}{8} (2 + 2\sqrt{2}) \approx 1.89612$; $f(t) = \sin t$
 $\Rightarrow f'(t) = \cos t \Rightarrow f''(t) = -\sin t \Rightarrow M = 1$
 $\Rightarrow |E_T| \leq \frac{\pi-0}{12} \left(\frac{\pi}{4} \right)^2 (1) = \frac{\pi^3}{192} \approx 0.16149$

	t_i	$f(t_i)$	m	$mf(t_i)$
	t_0	0	1	0
	t_1	$\pi/4$	2	$\sqrt{2}$
	t_2	$\pi/2$	2	2
	t_3	$3\pi/4$	2	$\sqrt{2}$
	t_4	π	1	0

(b) $\int_0^\pi \sin t dt = [-\cos t]_0^\pi = (-\cos \pi) - (-\cos 0) = 2 \Rightarrow |E_T| = \left| \int_0^\pi \sin t dt - T \right| \approx 2 - 1.89612 = 0.10388$

(c) $\frac{|E_T|}{\text{True Value}} \times 100 = \frac{0.10388}{2} \times 100 \approx 5\%$

II. (a) For $n = 4$, $\Delta x = \frac{b-a}{n} = \frac{\pi-0}{4} = \frac{\pi}{4} \Rightarrow \frac{\Delta x}{3} = \frac{\pi}{12}$;

$\sum mf(t_i) = 2 + 4\sqrt{2} \approx 7.6569 \Rightarrow S = \frac{\pi}{12} (2 + 4\sqrt{2})$
 ≈ 2.00456 ; $f^{(3)}(t) = -\cos t \Rightarrow f^{(4)}(t) = \sin t$
 $\Rightarrow M = 1 \Rightarrow |E_s| \leq \frac{\pi-0}{180} \left(\frac{\pi}{4} \right)^4 (1) \approx 0.00664$

	t_i	$f(t_i)$	m	$mf(t_i)$
	t_0	0	1	0
	t_1	$\pi/4$	4	$2\sqrt{2}$
	t_2	$\pi/2$	2	2
	t_3	$3\pi/4$	4	$2\sqrt{2}$
	t_4	π	1	0

(b) $\int_0^\pi \sin t dt = 2 \Rightarrow E_s = \int_0^\pi \sin t dt - S \approx 2 - 2.00456$
 $= -0.00456 \Rightarrow |E_s| \approx 0.00456$

(c) $\frac{|E_s|}{\text{True Value}} \times 100 = \frac{0.00456}{2} \times 100 \approx 0\%$

10. $\int_0^1 \sin \pi t dt$

I. (a) For $n = 4$, $\Delta x = \frac{b-a}{n} = \frac{1-0}{4} = \frac{1}{4} \Rightarrow \frac{\Delta x}{2} = \frac{1}{8}$;
 $\sum mf(t_i) = 2 + 2\sqrt{2} \approx 4.828$
 $\Rightarrow T = \frac{1}{8}(2 + 2\sqrt{2}) \approx 0.60355$; $f(t) = \sin \pi t$
 $\Rightarrow f'(t) = \pi \cos \pi t \Rightarrow f''(t) = -\pi^2 \sin \pi t$
 $\Rightarrow M = \pi^2 \Rightarrow |E_T| \leq \frac{1-0}{12} \left(\frac{1}{4}\right)^2 (\pi^2) \approx 0.05140$

	t_i	$f(t_i)$	m	$mf(t_i)$
	t_0	0	1	0
	t_1	$1/4$	2	$\sqrt{2}$
	t_2	$1/2$	2	2
	t_3	$3/4$	2	$\sqrt{2}$
	t_4	1	1	0

(b) $\int_0^1 \sin \pi t dt = \left[-\frac{1}{\pi} \cos \pi t\right]_0^1 = \left(-\frac{1}{\pi} \cos \pi\right) - \left(-\frac{1}{\pi} \cos 0\right) = \frac{2}{\pi} \approx 0.63662 \Rightarrow |E_T| = \int_0^1 \sin \pi t dt - T$
 $\approx \frac{2}{\pi} - 0.60355 = 0.03307$

(c) $\frac{|E_T|}{\text{True Value}} \times 100 = \frac{0.03307}{\left(\frac{2}{\pi}\right)} \times 100 \approx 5\%$

II. (a) For $n = 4$, $\Delta x = \frac{b-a}{n} = \frac{1-0}{4} = \frac{1}{4} \Rightarrow \frac{\Delta x}{3} = \frac{1}{12}$;
 $\sum mf(t_i) = 2 + 4\sqrt{2} \approx 7.65685$
 $\Rightarrow S = \frac{1}{12}(2 + 4\sqrt{2}) \approx 0.63807$;
 $f^{(3)}(t) = -\pi^3 \cos \pi t \Rightarrow f^{(4)}(t) = \pi^4 \sin \pi t$
 $\Rightarrow M = \pi^4 \Rightarrow |E_S| \leq \frac{1-0}{180} \left(\frac{1}{4}\right)^4 (\pi^4) \approx 0.00211$

	t_i	$f(t_i)$	m	$mf(t_i)$
	t_0	0	1	0
	t_1	$1/4$	4	$2\sqrt{2}$
	t_2	$1/2$	2	2
	t_3	$3/4$	4	$2\sqrt{2}$
	t_4	1	1	0

(b) $\int_0^1 \sin \pi t dt = \frac{2}{\pi} \approx 0.63662 \Rightarrow E_S = \int_0^1 \sin \pi t dt - S \approx \frac{2}{\pi} - 0.63807 = -0.00145 \Rightarrow |E_S| \approx 0.00145$

(c) $\frac{|E_S|}{\text{True Value}} \times 100 = \frac{0.00145}{\left(\frac{2}{\pi}\right)} \times 100 \approx 0\%$

11. (a) $M = 0$ (see Exercise 1): Then $n = 1 \Rightarrow \Delta x = 1 \Rightarrow |E_T| = \frac{1}{12}(1)^2(0) = 0 < 10^{-4}$

(b) $M = 0$ (see Exercise 1): Then $n = 2$ (n must be even) $\Rightarrow \Delta x = \frac{1}{2} \Rightarrow |E_S| = \frac{1}{180}\left(\frac{1}{2}\right)^4(0) = 0 < 10^{-4}$

12. (a) $M = 0$ (see Exercise 2): Then $n = 1 \Rightarrow \Delta x = 2 \Rightarrow |E_T| = \frac{2}{12}(2)^2(0) = 0 < 10^{-4}$

(b) $M = 0$ (see Exercise 2): Then $n = 2$ (n must be even) $\Rightarrow \Delta x = 1 \Rightarrow |E_S| = \frac{2}{180}(1)^4(0) < 10^{-4}$

13. (a) $M = 2$ (see Exercise 3): Then $\Delta x = \frac{2}{n} \Rightarrow |E_T| \leq \frac{2}{12}\left(\frac{2}{n}\right)^2(2) = \frac{4}{3n^2} < 10^{-4} \Rightarrow n^2 > \frac{4}{3}(10^4) \Rightarrow n > \sqrt{\frac{4}{3}(10^4)}$
 $\Rightarrow n > 115.4$, so let $n = 116$

(b) $M = 0$ (see Exercise 3): Then $n = 2$ (n must be even) $\Rightarrow \Delta x = 1 \Rightarrow |E_S| = \frac{2}{180}(1)^4(0) = 0 < 10^{-4}$

14. (a) $M = 2$ (see Exercise 4): Then $\Delta x = \frac{2}{n} \Rightarrow |E_T| \leq \frac{2}{12}\left(\frac{2}{n}\right)^2(2) = \frac{4}{3n^2} < 10^{-4} \Rightarrow n^2 > \frac{4}{3}(10^4) \Rightarrow n > \sqrt{\frac{4}{3}(10^4)}$
 $\Rightarrow n > 115.4$, so let $n = 116$

(b) $M = 0$ (see Exercise 4): Then $n = 2$ (n must be even) $\Rightarrow \Delta x = 1 \Rightarrow |E_S| = \frac{2}{180}(1)^4(0) = 0 < 10^{-4}$

15. (a) $M = 12$ (see Exercise 5): Then $\Delta x = \frac{2}{n} \Rightarrow |E_T| \leq \frac{2}{12} \left(\frac{2}{n}\right)^2 (12) = \frac{8}{n^2} < 10^{-4} \Rightarrow n^2 > 8(10^4) \Rightarrow n > \sqrt{8(10^4)}$
 $\Rightarrow n > 282.8$, so let $n = 283$
- (b) $M = 0$ (see Exercise 5): Then $n = 2$ (n must be even) $\Rightarrow \Delta x = 1 \Rightarrow |E_s| = \frac{2}{180} (1)^4 (0) = 0 < 10^{-4}$
16. (a) $M = 6$ (see Exercise 6): Then $\Delta x = \frac{2}{n} \Rightarrow |E_T| \leq \frac{2}{12} \left(\frac{2}{n}\right)^2 (6) = \frac{4}{n^2} < 10^{-4} \Rightarrow n^2 > 4(10^4) \Rightarrow n > \sqrt{4(10^4)}$
 $= 200$, so let $n = 201$
- (b) $M = 0$ (Exercise 6): Then $n = 2$ (n must be even) $\Rightarrow \Delta x = 1 \Rightarrow |E_s| = \frac{2}{180} (1)^4 (0) = 0 < 10^{-4}$
17. (a) $M = 6$ (see Exercise 7): Then $\Delta x = \frac{1}{n} \Rightarrow |E_T| \leq \frac{1}{12} \left(\frac{1}{n}\right)^2 (6) = \frac{1}{2n^2} < 10^{-4} \Rightarrow n^2 > \frac{1}{2}(10^4) \Rightarrow n > \sqrt{\frac{1}{2}(10^4)}$
 $\Rightarrow n > 70.7$, so let $n = 71$
- (b) $M = 120$ (see Exercise 7): Then $\Delta x = \frac{1}{n} \Rightarrow |E_s| = \frac{1}{180} \left(\frac{1}{n}\right)^4 (120) = \frac{2}{3n^4} < 10^{-4} \Rightarrow n^4 > \frac{2}{3}(10^4)$
 $\Rightarrow n > \sqrt[4]{\frac{2}{3}(10^4)} \Rightarrow n = 9.04$, so let $n = 10$ (n must be even)
18. (a) $M = 6$ (see Exercise 8): Then $\Delta x = \frac{2}{n} \Rightarrow |E_T| \leq \frac{2}{12} \left(\frac{2}{n}\right)^2 (6) = \frac{4}{n^2} < 10^{-4} \Rightarrow n^2 > 4(10^4) \Rightarrow n > \sqrt{4(10^4)}$
 $\Rightarrow n > 200$, so let $n = 201$
- (b) $M = 120$ (see Exercise 8): Then $\Delta x = \frac{2}{n} \Rightarrow |E_s| \leq \frac{2}{180} \left(\frac{2}{n}\right)^4 (120) = \frac{64}{3n^4} < 10^{-4} \Rightarrow n^4 > \frac{64}{3}(10^4)$
 $\Rightarrow n > \sqrt[4]{\frac{64}{3}(10^4)} \Rightarrow n > 21.5$, so let $n = 22$ (n must be even)
19. (a) $f(x) = \sqrt{x+1} \Rightarrow f'(x) = \frac{1}{2}(x+1)^{-1/2} \Rightarrow f''(x) = -\frac{1}{4}(x+1)^{-3/2} = -\frac{1}{4(\sqrt{x+1})^3} \Rightarrow M = \frac{1}{4(\sqrt{1})^3} = \frac{1}{4}$.
- Then $\Delta x = \frac{3}{n} \Rightarrow |E_T| \leq \frac{3}{12} \left(\frac{3}{n}\right)^2 \left(\frac{1}{4}\right) = \frac{9}{16n^2} < 10^{-4} \Rightarrow n^2 > \frac{9}{16}(10^4) \Rightarrow n > \sqrt{\frac{9}{16}(10^4)} \Rightarrow n > 75$, so let
 $n = 76$
- (b) $f^{(3)}(x) = \frac{3}{8}(x+1)^{-5/2} \Rightarrow f^{(4)}(x) = -\frac{15}{16}(x+1)^{-7/2} = -\frac{15}{16(\sqrt{x+1})^7} \Rightarrow M = \frac{15}{16(\sqrt{1})^7} = \frac{15}{16}$. Then
- $\Delta x = \frac{3}{n} \Rightarrow |E_s| \leq \frac{3}{180} \left(\frac{3}{n}\right)^4 \left(\frac{15}{16}\right) = \frac{3^5(15)}{16(180)n^4} < 10^{-4} \Rightarrow n^4 > \frac{3^5(15)(10^4)}{16(180)} \Rightarrow n > \sqrt[4]{\frac{3^5(15)(10^4)}{16(180)}} \Rightarrow n > 10.6$, so let
 $n = 12$ (n must be even)
20. (a) $f(x) = \frac{1}{\sqrt{x+1}} \Rightarrow f'(x) = -\frac{1}{2}(x+1)^{-3/2} \Rightarrow f''(x) = \frac{3}{4}(x+1)^{-5/2} = \frac{3}{4(\sqrt{x+1})^5} \Rightarrow M = \frac{3}{4(\sqrt{1})^5} = \frac{3}{4}$. Then
- $\Delta x = \frac{3}{n} \Rightarrow |E_T| \leq \frac{3}{12} \left(\frac{3}{n}\right)^2 \left(\frac{3}{4}\right) = \frac{3^4}{48n^2} < 10^{-4} \Rightarrow n^2 > \frac{3^4(10^4)}{48} \Rightarrow n > \sqrt{\frac{3^4(10^4)}{48}} \Rightarrow n > 129.9$, so let $n = 130$
- (b) $f^{(3)}(x) = -\frac{15}{8}(x+1)^{-7/2} \Rightarrow f^{(4)}(x) = \frac{105}{16}(x+1)^{-9/2} = \frac{105}{16(\sqrt{x+1})^9} \Rightarrow M = \frac{105}{16(\sqrt{1})^9} = \frac{105}{16}$. Then
- $\Delta x = \frac{3}{n} \Rightarrow |E_s| \leq \frac{3}{180} \left(\frac{3}{n}\right)^4 \left(\frac{105}{16}\right) = \frac{3^5(105)}{16(180)n^4} < 10^{-4} \Rightarrow n^4 > \frac{3^5(105)(10^4)}{16(180)} \Rightarrow n > \sqrt[4]{\frac{3^5(105)(10^4)}{16(180)}} \Rightarrow n > 17.25$,
so let $n = 18$ (n must be even)

21. (a) $f(x) = \sin(x+1) \Rightarrow f'(x) = \cos(x+1) \Rightarrow f''(x) = -\sin(x+1) \Rightarrow M = 1$. Then

$$\Delta x = \frac{2}{n} \Rightarrow |E_T| \leq \frac{2}{12} \left(\frac{2}{n}\right)^2 (1) = \frac{8}{12n^2} < 10^{-4} \Rightarrow n^2 > \frac{8(10^4)}{12} \Rightarrow n > \sqrt{\frac{8(10^4)}{12}} \Rightarrow n > 81.6, \text{ so let } n = 82$$

(b) $f^{(3)}(x) = -\cos(x+1) \Rightarrow f^{(4)}(x) = \sin(x+1) \Rightarrow M = 1$. Then $\Delta x = \frac{2}{n} \Rightarrow |E_s| \leq \frac{2}{180} \left(\frac{2}{n}\right)^4 (1)$
 $= \frac{32}{180n^4} < 10^{-4} \Rightarrow n^4 > \frac{32(10^4)}{180} \Rightarrow n > \sqrt[4]{\frac{32(10^4)}{180}} \Rightarrow n > 6.49$, so let $n = 8$ (n must be even)

22. (a) $f(x) = \cos(x+\pi) \Rightarrow f'(x) = -\sin(x+\pi) \Rightarrow f''(x) = -\cos(x+\pi) \Rightarrow M = 1$. Then

$$\Delta x = \frac{2}{n} \Rightarrow |E_T| \leq \frac{2}{12} \left(\frac{2}{n}\right)^2 (1) = \frac{8}{12n^2} < 10^{-4} \Rightarrow n^2 > \frac{8(10^4)}{12} \Rightarrow n > \sqrt{\frac{8(10^4)}{12}} \Rightarrow n > 81.6, \text{ so let } n = 82$$

(b) $f^{(3)}(x) = \sin(x+\pi) \Rightarrow f^{(4)}(x) = \cos(x+\pi) \Rightarrow M = 1$. Then $\Delta x = \frac{2}{n} \Rightarrow |E_s| \leq \frac{2}{180} \left(\frac{2}{n}\right)^4 (1)$
 $= \frac{32}{180n^4} < 10^{-4} \Rightarrow n^4 > \frac{32(10^4)}{180} \Rightarrow n > \sqrt[4]{\frac{32(10^4)}{180}} \Rightarrow n > 6.49$, so let $n = 8$ (n must be even)

23. $\frac{5}{2}(6.0 + 2(8.2) + 2(9.1) + \dots + 2(12.7) + 13.0)(30) = 15,990 \text{ ft}^3$.

24. Use the conversion 30 mph = 44 fps (ft per sec) since time is measured in seconds. The distance traveled as the car accelerates from, say, 40 mph = 58.67 fps to 50 mph = 73.33 fps in $(4.5 - 3.2) = 1.3$ sec is the area of the trapezoid (see figure) associated with that time interval: $\frac{1}{2}(58.67 + 73.33)(1.3) = 85.8$ ft. The total distance traveled by the Ford Mustang Cobra is the sum of all these eleven trapezoids (using $\frac{\Delta t}{2}$ and the table below):

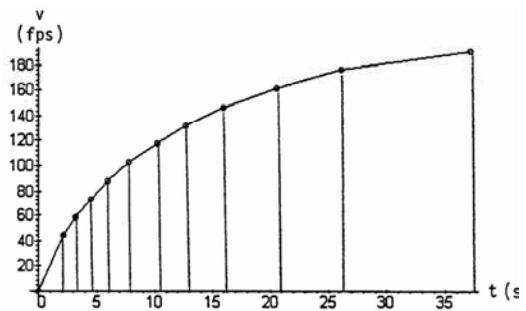

v(mph)	0	30	40	50	60	70	80	90	100	110	120	130
v(fps)	0	44	58.67	73.33	88	102.67	117.33	132	146.67	161.33	176	190.67
t(sec)	0	2.2	3.2	4.5	5.9	7.8	10.2	12.7	16	20.6	26.2	37.1
$\Delta t/2$	0	1.1	0.5	0.65	0.7	0.95	1.2	1.25	1.65	2.3	2.8	5.45

$$s = (44)(1.1) + (102.67)(0.5) + (132)(0.65) + (161.33)(0.7) + (190.67)(0.95) + (220)(1.2) + (249.33)(1.25) + (278.67)(1.65) + (308)(2.3) + (337.33)(2.8) + (366.67)(5.45) = 5166.346 \text{ ft} \approx 0.9785 \text{ mi}$$

25. Using Simpson's Rule, $\Delta x = 1 \Rightarrow \frac{\Delta x}{3} = \frac{1}{3}$;

$$\sum my_i = 33.6 \Rightarrow \text{Cross Section Area} \approx \frac{1}{3}(33.6)$$

$= 11.2 \text{ ft}^2$. Let x be the length of the tank. Then the Volume $V = (\text{Cross Sectional Area}) x = 11.2x$.

Now 5000 lb gasoline at 42 lb/ft³

$$\Rightarrow V = \frac{5000}{42} = 119.05 \text{ ft}^3$$

$$\Rightarrow 119.05 = 11.2x \Rightarrow x \approx 10.63 \text{ ft}$$

	x_i	y_i	m	my_i
	x_0	0	1.5	1.5
	x_1	1	1.6	6.4
	x_2	2	1.8	3.6
	x_3	3	1.9	7.6
	x_4	4	2.0	4.0
	x_5	5	2.1	8.4
	x_6	6	2.1	2.1

26. $\frac{24}{2}[0.019 + 2(0.020) + 2(0.021) + \dots + 2(0.031) + 0.035] = 4.2 L$

27. (a) $|E_s| \leq \frac{b-a}{180} (\Delta x^4) M$; $n = 4 \Rightarrow \Delta x = \frac{\pi-0}{4} = \frac{\pi}{8}$; $|f^{(4)}| \leq 1 \Rightarrow M = 1 \Rightarrow |E_s| \leq \frac{(\frac{\pi}{2}-0)}{180} (\frac{\pi}{8})^4 (1) \approx 0.00021$

(b) $\Delta x = \frac{\pi}{8} \Rightarrow \frac{\Delta x}{3} = \frac{\pi}{24}$;
 $\sum mf(x_i) = 10.47208705$
 $\Rightarrow S = \frac{\pi}{24}(10.47208705) \approx 1.37079$

(c) $\approx \left(\frac{0.00021}{1.37079}\right) \times 100 \approx 0.015\%$

	x_i	$f(x_i)$	m	$mf(x_i)$
x_0	0	1	1	1
x_1	$\pi/8$	0.974495358	4	3.897981432
x_2	$\pi/4$	0.900316316	2	1.800632632
x_3	$3\pi/8$	0.784213303	4	3.136853212
x_4	$\pi/2$	0.636619772	1	0.636619772

28. (a) $\Delta x = \frac{b-a}{n} = \frac{1-0}{10} = 0.1 \Rightarrow \text{erf}(1) = \frac{2}{\sqrt{\pi}} \left(\frac{0.1}{3}\right) (y_0 + 4y_1 + 2y_2 + 4y_3 + \dots + 4y_9 + y_{10})$
 $= \frac{2}{30\sqrt{\pi}} (e^0 + 4e^{-0.01} + 2e^{-0.04} + 4e^{-0.09} + \dots + 4e^{-0.81} + e^{-1}) \approx 0.843$

(b) $|E_s| \leq \frac{1-0}{180} (0.1)^4 (12) \approx 6.7 \times 10^{-6}$

29. $T = \frac{\Delta x}{2} (y_0 + 2y_1 + 2y_2 + 2y_3 + \dots + 2y_{n-1} + y_n)$ where $\Delta x = \frac{b-a}{n}$ and f is continuous on $[a, b]$. So $T = \frac{b-a}{n} \frac{(y_0 + y_1 + y_1 + y_2 + y_2 + \dots + y_{n-1} + y_{n-1} + y_n)}{2} = \frac{b-a}{n} \left(\frac{f(x_0) + f(x_1)}{2} + \frac{f(x_1) + f(x_2)}{2} + \dots + \frac{f(x_{n-1}) + f(x_n)}{2} \right)$. Since f is continuous on each interval $[x_{k-1}, x_k]$, and $\frac{f(x_{k-1}) + f(x_k)}{2}$ is always between $f(x_{k-1})$ and $f(x_k)$, there is a point c_k in $[x_{k-1}, x_k]$ with $f(c_k) = \frac{f(x_{k-1}) + f(x_k)}{2}$; this is a consequence of the Intermediate Value Theorem. Thus our sum is $\sum_{k=1}^n \left(\frac{b-a}{n}\right) f(c_k)$ which has the form $\sum_{k=1}^n \Delta x_k f(c_k)$ with $\Delta x_k = \frac{b-a}{n}$ for all k . This a Riemann Sum for f on $[a, b]$.

30. $S = \frac{\Delta x}{3} (y_0 + 4y_1 + 2y_2 + 4y_3 + \dots + 2y_{n-2} + 4y_{n-1} + y_n)$ where n is even, $\Delta x = \frac{b-a}{n}$ and f is continuous on $[a, b]$. So $S = \frac{b-a}{n} \left(\frac{y_0 + 4y_1 + y_2}{3} + \frac{y_2 + 4y_3 + y_4}{3} + \frac{y_4 + 4y_5 + y_6}{3} + \dots + \frac{y_{n-2} + 4y_{n-1} + y_n}{3} \right)$
 $= \frac{b-a}{\frac{n}{2}} \left(\frac{f(x_0) + 4f(x_1) + f(x_2)}{6} + \frac{f(x_2) + 4f(x_3) + f(x_4)}{6} + \frac{f(x_4) + 4f(x_5) + f(x_6)}{6} + \dots + \frac{f(x_{n-2}) + 4f(x_{n-1}) + f(x_n)}{6} \right)$
 $\frac{f(x_{2k}) + 4f(x_{2k+1}) + f(x_{2k+2})}{6}$ is the average of the six values of the continuous function on the interval $[x_{2k}, x_{2k+2}]$, so it is between the minimum and maximum of f on this interval. By the Extreme Value Theorem for continuous functions, f takes on its maximum and minimum in this interval, so there are x_a and x_b with $x_{2k} \leq x_a, x_b \leq x_{2k+2}$ and $f(x_a) \leq \frac{f(x_{2k}) + 4f(x_{2k+1}) + f(x_{2k+2})}{6} \leq f(x_b)$.
 By the Intermediate Value Theorem, there is c_k in $[x_{2k}, x_{2k+2}]$ with $f(c_k) = \frac{f(x_{2k}) + 4f(x_{2k+1}) + f(x_{2k+2})}{6}$.
 So our sum has the form $\sum_{k=1}^{n/2} \Delta x_k f(c_k)$ with $\Delta x_k = \frac{b-a}{(n/2)}$, a Riemann sum for f on $[a, b]$.

31. (a) $a = 1, e = \frac{1}{2} \Rightarrow \text{Length} = 4 \int_0^{\pi/2} \sqrt{1 - \frac{1}{4} \cos^2 t} dt$
 $= 2 \int_0^{\pi/2} \sqrt{4 - \cos^2 t} dt = \int_0^{\pi/2} f(t) dt$; use the Trapezoid Rule with $n = 10$
 $\Rightarrow \Delta t = \frac{b-a}{n} = \frac{(\frac{\pi}{2}) - 0}{10} = \frac{\pi}{20}$.
 $\int_0^{\pi/2} \sqrt{4 - \cos^2 t} dt \approx \sum_{n=0}^{10} mf(x_n) = 37.3686183$
 $\Rightarrow T = \frac{\Delta t}{2} (37.3686183) = \frac{\pi}{40} (37.3686183)$
 $= 2.934924419$
 $\Rightarrow \text{Length} = 2(2.934924419) \approx 5.870$

(b) $|f''(t)| < 1 \Rightarrow M = 1$
 $\Rightarrow |E_T| \leq \frac{b-a}{12} (\Delta t^2 M) \leq \frac{(\frac{\pi}{2}) - 0}{12} \left(\frac{\pi}{20}\right)^2 1 \leq 0.0032$

	x_i	$f(x_i)$	m	$mf(x_i)$
	x_0	0	1	1.732050808
	x_1	$\pi/20$	2	3.478201686
	x_2	$\pi/10$	2	3.518801786
	x_3	$3\pi/20$	2	3.581121262
	x_4	$\pi/5$	2	3.658136959
	x_5	$\pi/4$	2	3.741657387
	x_6	$3\pi/10$	2	3.823353762
	x_7	$7\pi/20$	2	3.895583461
	x_8	$2\pi/5$	2	3.951965839
	x_9	$9\pi/20$	2	3.987745357
	x_{10}	$\pi/2$	1	2

32. $\Delta x = \frac{\pi - 0}{8} = \frac{\pi}{8} \Rightarrow \frac{\Delta x}{3} = \frac{\pi}{24}$;
 $\sum mf(x_i) = 29.184807792$
 $\Rightarrow S = \frac{\pi}{24} (29.18480779) \approx 3.82028$

	x_i	$f(x_i)$	m	$mf(x_i)$
	x_0	0	1	1.414213562
	x_1	$\pi/8$	4	5.445810706
	x_2	$\pi/4$	2	2.449489743
	x_3	$3\pi/8$	4	4.282889883
	x_4	$\pi/2$	2	2
	x_5	$5\pi/8$	4	4.282889883
	x_6	$3\pi/4$	2	2.449489743
	x_7	$7\pi/8$	4	5.445810706
	x_8	π	1	1.414213562

33. The length of the curve $y = \sin\left(\frac{3\pi}{20}x\right)$ from 0 to 20 is: $L = \int_0^{20} \sqrt{1 + \left(\frac{dy}{dx}\right)^2} dx$; $\frac{dy}{dx} = \frac{3\pi}{20} \cos\left(\frac{3\pi}{20}x\right)$
 $\Rightarrow \left(\frac{dy}{dx}\right)^2 = \frac{9\pi^2}{400} \cos^2\left(\frac{3\pi}{20}x\right) \Rightarrow L = \int_0^{20} \sqrt{1 + \frac{9\pi^2}{400} \cos^2\left(\frac{3\pi}{20}x\right)} dx$. Using numerical integration we find
 $L \approx 21.07$ in

34. First, we'll find the length of the cosine curve: $L = \int_{-25}^{25} \sqrt{1 + \left(\frac{dy}{dx}\right)^2} dx$; $\frac{dy}{dx} = -\frac{25\pi}{50} \sin\left(\frac{\pi x}{50}\right)$
 $\Rightarrow \left(\frac{dy}{dx}\right)^2 = \frac{\pi^2}{4} \sin^2\left(\frac{\pi x}{50}\right) \Rightarrow L = \int_{-25}^{25} \sqrt{1 + \frac{\pi^2}{4} \sin^2\left(\frac{\pi x}{50}\right)} dx$. Using a numerical integrator we find $L \approx 73.1848$ ft.
 Surface area is: $A = \text{length} \cdot \text{width} \approx (73.1848)(300) = 21,955.44$ ft. $\text{Cost} = 2.35A = (2.35)(21,955.44) =$
 $\$51,595.28$. Answers may vary slightly, depending on the numerical integration used.

35. $y = \sin x \Rightarrow \frac{dy}{dx} = \cos x \Rightarrow \left(\frac{dy}{dx}\right)^2 = \cos^2 x \Rightarrow S = \int_0^\pi 2\pi(\sin x)\sqrt{1 + \cos^2 x} dx$; a numerical integration gives $S \approx 14.4$
36. $y = \frac{x^2}{4} \Rightarrow \frac{dy}{dx} = \frac{x}{2} \Rightarrow \left(\frac{dy}{dx}\right)^2 = \frac{x^2}{4} \Rightarrow S = \int_0^2 2\pi\left(\frac{x^2}{4}\right)\sqrt{1 + \frac{x^2}{4}} dx$; a numerical integration gives $S \approx 5.28$
37. A calculator or computer numerical integrator yields $\sin^{-1} 0.6 \approx 0.643501109$.
38. A calculator or computer numerical integrator yields $\pi \approx 3.1415929$.
39. The amount of medication absorbed over a 12-hr period is given by $\int_0^{12} (6 - \ln(2t^2 - 3t + 3)) dt$. A numerical integrator yields a value of 28.684 for this integral, so the amount of medication absorbed over a 12-hr period is approximately 28.7 milligrams.
40. The average concentration of antihistamine over a 6-hr period is given by $\frac{1}{6} \int_0^1 (12.5 - 4 \ln(t^2 - 3t + 4)) dt$. A numerical integrator yields a value of 6.078 for this integral, so the average concentration is approximately 6.1 grams per liter.

8.8 IMPROPER INTEGRALS

- $\int_0^\infty \frac{dx}{x^2+1} = \lim_{b \rightarrow \infty} \int_0^b \frac{dx}{x^2+1} = \lim_{b \rightarrow \infty} \left[\tan^{-1} x \right]_0^b = \lim_{b \rightarrow \infty} (\tan^{-1} b - \tan^{-1} 0) = \frac{\pi}{2} - 0 = \frac{\pi}{2}$
- $\int_1^\infty \frac{dx}{x^{1.001}} = \lim_{b \rightarrow \infty} \int_1^b \frac{dx}{x^{1.001}} = \lim_{b \rightarrow \infty} \left[-1000x^{-0.001} \right]_1^b = \lim_{b \rightarrow \infty} \left(\frac{-1000}{b^{0.001}} + 1000 \right) = 1000$
- $\int_0^1 \frac{dx}{\sqrt{x}} = \lim_{b \rightarrow 0^+} \int_b^1 x^{-1/2} dx = \lim_{b \rightarrow 0^+} \left[2x^{1/2} \right]_b^1 = \lim_{b \rightarrow 0^+} (2 - 2\sqrt{b}) = 2 - 0 = 2$
- $\int_0^4 \frac{dx}{\sqrt{4-x}} = \lim_{b \rightarrow 4^-} \int_0^b (4-x)^{-1/2} dx = \lim_{b \rightarrow 4^-} \left[-2\sqrt{4-b} - (-2\sqrt{4}) \right] = 0 + 4 = 4$
- $\int_{-1}^1 \frac{dx}{x^{2/3}} = \int_{-1}^0 \frac{dx}{x^{2/3}} + \int_0^1 \frac{dx}{x^{2/3}} = \lim_{b \rightarrow 0^-} \left[3x^{1/3} \right]_{-1}^b + \lim_{c \rightarrow 0^+} \left[3x^{1/3} \right]_c^1 = \lim_{b \rightarrow 0^-} \left[3b^{1/3} - 3(-1)^{1/3} \right] + \lim_{c \rightarrow 0^+} \left[3(1)^{1/3} - 3c^{1/3} \right] = (0+3) + (3-0) = 6$
- $\int_{-8}^1 \frac{dx}{x^{1/3}} = \int_{-8}^0 \frac{dx}{x^{1/3}} + \int_0^1 \frac{dx}{x^{1/3}} = \lim_{b \rightarrow 0^-} \left[\frac{3}{2}x^{2/3} \right]_{-8}^b + \lim_{c \rightarrow 0^+} \left[\frac{3}{2}x^{2/3} \right]_c^1 = \lim_{b \rightarrow 0^-} \left[\frac{3}{2}b^{2/3} - \frac{3}{2}(-8)^{2/3} \right] + \lim_{c \rightarrow 0^+} \left[\frac{3}{2}(1)^{2/3} - \frac{3}{2}c^{2/3} \right] = \left[0 - \frac{3}{2}(4) \right] + \left(\frac{3}{2} - 0 \right) = -\frac{9}{2}$

7. $\int_0^1 \frac{dx}{\sqrt{1-x^2}} = \lim_{b \rightarrow 1^-} \left[\sin^{-1} x \right]_0^b = \lim_{b \rightarrow 1^-} (\sin^{-1} b - \sin^{-1} 0) = \frac{\pi}{2} - 0 = \frac{\pi}{2}$
8. $\int_0^1 \frac{dr}{r^{0.999}} = \lim_{b \rightarrow 0^+} \left[1000r^{0.001} \right]_b^1 = \lim_{b \rightarrow 0^+} (1000 - 1000b^{0.001}) = 1000 - 0 = 1000$
9. $\int_{-\infty}^{-2} \frac{2 dx}{x^2-1} = \int_{-\infty}^{-2} \frac{dx}{x-1} - \int_{-\infty}^{-2} \frac{dx}{x+1} = \lim_{b \rightarrow -\infty} \left[\ln|x-1| \right]_b^{-2} - \lim_{b \rightarrow -\infty} \left[\ln|x+1| \right]_b^{-2} = \lim_{b \rightarrow -\infty} \left[\ln \left| \frac{x-1}{x+1} \right| \right]_b^{-2}$
 $= \lim_{b \rightarrow -\infty} \left(\ln \left| \frac{-3}{-1} \right| - \ln \left| \frac{b-1}{b+1} \right| \right) = \ln 3 - \ln \left(\lim_{b \rightarrow -\infty} \frac{b-1}{b+1} \right) = \ln 3 - \ln 1 = \ln 3$
10. $\int_{-\infty}^2 \frac{2 dx}{x^2+4} = \lim_{b \rightarrow -\infty} \left[\tan^{-1} \frac{x}{2} \right]_b^2 = \lim_{b \rightarrow -\infty} \left(\tan^{-1} 1 - \tan^{-1} \frac{b}{2} \right) = \frac{\pi}{4} - \left(-\frac{\pi}{2} \right) = \frac{3\pi}{4}$
11. $\int_2^{\infty} \frac{2 dv}{v^2-v} = \lim_{b \rightarrow \infty} \left[2 \ln \left| \frac{v-1}{v} \right| \right]_2^b = \lim_{b \rightarrow \infty} \left(2 \ln \left| \frac{b-1}{b} \right| - 2 \ln \left| \frac{2-1}{2} \right| \right) = 2 \ln(1) - 2 \ln \left(\frac{1}{2} \right) = 0 + 2 \ln 2 = \ln 4$
12. $\int_2^{\infty} \frac{2 dt}{t^2-1} = \lim_{b \rightarrow \infty} \left[\ln \left| \frac{t-1}{t+1} \right| \right]_2^b = \lim_{b \rightarrow \infty} \left(\ln \left| \frac{b-1}{b+1} \right| - \ln \left| \frac{2-1}{2+1} \right| \right) = \ln(1) - \ln \left(\frac{1}{3} \right) = 0 + \ln 3 = \ln 3$
13. $\int_{-\infty}^{\infty} \frac{2x dx}{(x^2+1)^2} = \int_{-\infty}^0 \frac{2x dx}{(x^2+1)^2} + \int_0^{\infty} \frac{2x dx}{(x^2+1)^2}; \left[\begin{array}{l} u = x^2 + 1 \\ du = 2x dx \end{array} \right] \rightarrow \int_{\infty}^1 \frac{du}{u^2} + \int_1^{\infty} \frac{du}{u^2} = \lim_{b \rightarrow \infty} \left[-\frac{1}{u} \right]_b^1 + \lim_{c \rightarrow \infty} \left[-\frac{1}{u} \right]_1^c$
 $= \lim_{b \rightarrow \infty} \left(-1 + \frac{1}{b} \right) + \lim_{c \rightarrow \infty} \left[-\frac{1}{c} - (-1) \right] = (-1 + 0) + (0 + 1) = 0$
14. $\int_{-\infty}^{\infty} \frac{x dx}{(x^2+4)^{3/2}} = \int_{-\infty}^0 \frac{x dx}{(x^2+4)^{3/2}} + \int_0^{\infty} \frac{x dx}{(x^2+4)^{3/2}}; \left[\begin{array}{l} u = x^2 + 4 \\ du = 2x dx \end{array} \right] \rightarrow \int_{\infty}^4 \frac{du}{2u^{3/2}} + \int_4^{\infty} \frac{du}{2u^{3/2}} = \lim_{b \rightarrow \infty} \left[-\frac{1}{\sqrt{u}} \right]_b^4 + \lim_{c \rightarrow \infty} \left[-\frac{1}{\sqrt{u}} \right]_4^c$
 $= \lim_{b \rightarrow \infty} \left(-\frac{1}{2} + \frac{1}{\sqrt{b}} \right) + \lim_{c \rightarrow \infty} \left(-\frac{1}{\sqrt{c}} + \frac{1}{2} \right) = \left(-\frac{1}{2} + 0 \right) + \left(0 + \frac{1}{2} \right) = 0$
15. $\int_0^1 \frac{\theta+1}{\sqrt{\theta^2+2\theta}} d\theta; \left[\begin{array}{l} u = \theta^2 + 2\theta \\ du = 2(\theta+1)d\theta \end{array} \right] \rightarrow \int_0^3 \frac{du}{2\sqrt{u}} = \lim_{b \rightarrow 0^+} \int_b^3 \frac{du}{2\sqrt{u}} = \lim_{b \rightarrow 0^+} \left[\sqrt{u} \right]_b^3 = \lim_{b \rightarrow 0^+} (\sqrt{3} - \sqrt{b}) = \sqrt{3} - 0 = \sqrt{3}$
16. $\int_0^2 \frac{s+1}{\sqrt{4-s^2}} ds = \frac{1}{2} \int_0^2 \frac{2s ds}{\sqrt{4-s^2}} + \int_0^2 \frac{ds}{\sqrt{4-s^2}}; \left[\begin{array}{l} u = 4 - s^2 \\ du = -2s ds \end{array} \right] \rightarrow -\frac{1}{2} \int_4^0 \frac{du}{\sqrt{u}} + \lim_{c \rightarrow 2^-} \int_0^c \frac{ds}{\sqrt{4-s^2}}$
 $= \lim_{b \rightarrow 0^+} \int_b^4 \frac{du}{2\sqrt{u}} + \lim_{c \rightarrow 2^-} \int_0^c \frac{ds}{\sqrt{4-s^2}} = \lim_{b \rightarrow 0^+} \left[\sqrt{u} \right]_b^4 + \lim_{c \rightarrow 2^-} \left[\sin^{-1} \frac{s}{2} \right]_0^c = \lim_{b \rightarrow 0^+} (2 - \sqrt{b}) + \lim_{c \rightarrow 2^-} \left(\sin^{-1} \frac{c}{2} - \sin^{-1} 0 \right)$
 $= (2 - 0) + \left(\frac{\pi}{2} - 0 \right) = \frac{4+\pi}{2}$
17. $\int_0^{\infty} \frac{dx}{(1+x)\sqrt{x}}; \left[\begin{array}{l} u = \sqrt{x} \\ du = \frac{dx}{2\sqrt{x}} \end{array} \right] \rightarrow \int_0^{\infty} \frac{2 du}{u^2+1} = \lim_{b \rightarrow \infty} \int_0^b \frac{2 du}{u^2+1} = \lim_{b \rightarrow \infty} \left[2 \tan^{-1} u \right]_0^b = \lim_{b \rightarrow \infty} (2 \tan^{-1} b - 2 \tan^{-1} 0)$
 $= 2 \left(\frac{\pi}{2} \right) - 2(0) = \pi$

$$\begin{aligned}
 18. \int_1^{\infty} \frac{dx}{x\sqrt{x^2-1}} &= \int_1^2 \frac{dx}{x\sqrt{x^2-1}} + \int_2^{\infty} \frac{dx}{x\sqrt{x^2-1}} = \lim_{b \rightarrow 1^+} \int_b^2 \frac{dx}{x\sqrt{x^2-1}} + \lim_{c \rightarrow \infty} \int_2^c \frac{dx}{x\sqrt{x^2-1}} = \lim_{b \rightarrow 1^+} \left[\sec^{-1} |x| \right]_b^2 + \lim_{c \rightarrow \infty} \left[\sec^{-1} |x| \right]_2^c \\
 &= \lim_{b \rightarrow 1^+} (\sec^{-1} 2 - \sec^{-1} b) + \lim_{c \rightarrow \infty} (\sec^{-1} c - \sec^{-1} 2) = \left(\frac{\pi}{3} - 0\right) + \left(\frac{\pi}{2} - \frac{\pi}{3}\right) = \frac{\pi}{2}
 \end{aligned}$$

$$\begin{aligned}
 19. \int_0^{\infty} \frac{dv}{(1+v^2)(1+\tan^{-1} v)} &= \lim_{b \rightarrow \infty} \left[\ln |1 + \tan^{-1} v| \right]_0^b = \lim_{b \rightarrow \infty} \left[\ln |1 + \tan^{-1} b| - \ln |1 + \tan^{-1} 0| \right] = \ln \left(1 + \frac{\pi}{2}\right) - \ln(1+0) \\
 &= \ln \left(1 + \frac{\pi}{2}\right)
 \end{aligned}$$

$$20. \int_0^{\infty} \frac{16 \tan^{-1} x}{1+x^2} dx = \lim_{b \rightarrow \infty} \left[8(\tan^{-1} x)^2 \right]_0^b = \lim_{b \rightarrow \infty} \left[8(\tan^{-1} b)^2 - 8(\tan^{-1} 0)^2 \right] = 8\left(\frac{\pi}{2}\right)^2 - 8(0) = 2\pi^2$$

$$\begin{aligned}
 21. \int_{-\infty}^0 \theta e^{\theta} d\theta &= \lim_{b \rightarrow -\infty} \left[\theta e^{\theta} - e^{\theta} \right]_b^0 = \lim_{b \rightarrow -\infty} \left[(0 \cdot e^0 - e^0) - (be^b - e^b) \right] = -1 - \lim_{b \rightarrow -\infty} \left(\frac{b-1}{e^{-b}} \right) = -1 - \lim_{b \rightarrow -\infty} \left(\frac{1}{-e^{-b}} \right) \\
 & \hspace{15em} \text{(l'Hôpital's rule for } \frac{\infty}{\infty} \text{ form)} \\
 &= -1 - 0 = -1
 \end{aligned}$$

$$\begin{aligned}
 22. \int_0^{\infty} 2e^{-\theta} \sin \theta d\theta &= \lim_{b \rightarrow \infty} \int_0^b 2e^{-\theta} \sin \theta d\theta = \lim_{b \rightarrow \infty} 2 \left[\frac{e^{-\theta}}{1+1} (-\sin \theta - \cos \theta) \right]_0^b \quad (\text{Formula 107 with } a = -1, b = 1) \\
 &= \lim_{b \rightarrow \infty} \left[\frac{-2(\sin b + \cos b)}{2e^b} + \frac{2(\sin 0 + \cos 0)}{2e^0} \right] = 0 + \frac{2(0+1)}{2} = 1
 \end{aligned}$$

$$23. \int_{-\infty}^0 e^{-|x|} dx = \int_{-\infty}^0 e^x dx = \lim_{b \rightarrow -\infty} \left[e^x \right]_b^0 = \lim_{b \rightarrow -\infty} (1 - e^b) = (1 - 0) = 1$$

$$\begin{aligned}
 24. \int_{-\infty}^{\infty} 2xe^{-x^2} dx &= \int_{-\infty}^0 2xe^{-x^2} dx + \int_0^{\infty} 2xe^{-x^2} dx = \lim_{b \rightarrow -\infty} \left[-e^{-x^2} \right]_b^0 + \lim_{c \rightarrow \infty} \left[-e^{-x^2} \right]_0^c \\
 &= \lim_{b \rightarrow -\infty} \left[-1 - (-e^{-b^2}) \right] + \lim_{c \rightarrow \infty} \left[-e^{-c^2} - (-1) \right] = (-1 - 0) + (0 + 1) = 0
 \end{aligned}$$

$$\begin{aligned}
 25. \int_0^1 x \ln x dx &= \lim_{b \rightarrow 0^+} \left[\frac{x^2}{2} \ln x - \frac{x^2}{4} \right]_b^1 = \lim_{b \rightarrow 0^+} \left[\left(\frac{1}{2} \ln 1 - \frac{1}{4} \right) - \left(\frac{b^2}{2} \ln b - \frac{b^2}{4} \right) \right] = -\frac{1}{4} - \lim_{b \rightarrow 0^+} \frac{\ln b}{\left(\frac{2}{b^2}\right)} + 0 \\
 &= -\frac{1}{4} - \lim_{b \rightarrow 0^+} \frac{\left(\frac{1}{b}\right)}{\left(-\frac{4}{b^3}\right)} = -\frac{1}{4} + \lim_{b \rightarrow 0^+} \left(\frac{b^2}{4}\right) = -\frac{1}{4} + 0 = -\frac{1}{4}
 \end{aligned}$$

$$\begin{aligned}
 26. \int_0^1 (-\ln x) dx &= \lim_{b \rightarrow 0^+} [x - x \ln x]_b^1 = \lim_{b \rightarrow 0^+} [(1 - 1 \ln 1) - (b - b \ln b)] = 1 - 0 + \lim_{b \rightarrow 0^+} \frac{\ln b}{\left(\frac{1}{b}\right)} = 1 + \lim_{b \rightarrow 0^+} \frac{\left(\frac{1}{b}\right)}{\left(-\frac{1}{b^2}\right)} \\
 &= 1 - \lim_{b \rightarrow 0^+} b = 1 - 0 = 1
 \end{aligned}$$

$$27. \int_0^2 \frac{ds}{\sqrt{4-s^2}} = \lim_{b \rightarrow 2^-} \left[\sin^{-1} \frac{s}{2} \right]_0^b = \lim_{b \rightarrow 2^-} \left[\sin^{-1} \frac{b}{2} - \sin^{-1} 0 \right] = \frac{\pi}{2} - 0 = \frac{\pi}{2}$$

$$28. \int_0^1 \frac{4r \, dr}{\sqrt{1-r^4}} = \lim_{b \rightarrow 1^-} \left[2 \sin^{-1}(r^2) \right]_0^b = \lim_{b \rightarrow 1^-} \left[2 \sin^{-1}(b^2) - 2 \sin^{-1} 0 \right] = 2 \cdot \frac{\pi}{2} - 0 = \pi$$

$$29. \int_1^2 \frac{ds}{s\sqrt{s^2-1}} = \lim_{b \rightarrow 1^+} \left[\sec^{-1} s \right]_b^2 = \lim_{b \rightarrow 1^+} \left[\sec^{-1} 2 - \sec^{-1} b \right] = \frac{\pi}{3} - 0 = \frac{\pi}{3}$$

$$30. \int_2^4 \frac{dt}{t\sqrt{t^2-4}} = \lim_{b \rightarrow 2^+} \left[\frac{1}{2} \sec^{-1} \frac{t}{2} \right]_b^4 = \lim_{b \rightarrow 2^+} \left[\left(\frac{1}{2} \sec^{-1} \frac{4}{2} \right) - \frac{1}{2} \sec^{-1} \left(\frac{b}{2} \right) \right] = \frac{1}{2} \left(\frac{\pi}{3} \right) - \frac{1}{2} \cdot 0 = \frac{\pi}{6}$$

$$31. \int_{-1}^4 \frac{dx}{\sqrt{|x|}} = \lim_{b \rightarrow 0^-} \int_{-1}^b \frac{dx}{\sqrt{-x}} + \lim_{c \rightarrow 0^+} \int_c^4 \frac{dx}{\sqrt{x}} = \lim_{b \rightarrow 0^-} \left[-2\sqrt{-x} \right]_{-1}^b + \lim_{c \rightarrow 0^+} \left[2\sqrt{x} \right]_c^4 \\ = \lim_{b \rightarrow 0^-} \left[(-2\sqrt{-b}) - (-2\sqrt{-(-1)}) \right] + \lim_{c \rightarrow 0^+} \left[2\sqrt{4} - 2\sqrt{c} \right] = 0 + 2 + 2 \cdot 2 - 0 = 6$$

$$32. \int_0^2 \frac{dx}{\sqrt{|x-1|}} = \int_0^1 \frac{dx}{\sqrt{1-x}} + \int_1^2 \frac{dx}{\sqrt{x-1}} = \lim_{b \rightarrow 1^-} \left[-2\sqrt{1-x} \right]_0^b + \lim_{c \rightarrow 1^+} \left[2\sqrt{x-1} \right]_c^2 \\ = \lim_{b \rightarrow 1^-} \left[(-2\sqrt{1-b}) - (-2\sqrt{1-0}) \right] + \lim_{c \rightarrow 1^+} \left[2\sqrt{2-1} - (2\sqrt{c-1}) \right] = 0 + 2 + 2 - 0 = 4$$

$$33. \int_{-1}^{\infty} \frac{d\theta}{\theta^2+5\theta+6} = \lim_{b \rightarrow \infty} \left[\ln \left| \frac{\theta+2}{\theta+3} \right| \right]_{-1}^b = \lim_{b \rightarrow \infty} \left[\ln \left| \frac{b+2}{b+3} \right| - \ln \left| \frac{-1+2}{-1+3} \right| \right] = 0 - \ln \left(\frac{1}{2} \right) = \ln 2$$

$$34. \int_0^{\infty} \frac{dx}{(x+1)(x^2+1)} = \lim_{b \rightarrow \infty} \left[\frac{1}{2} \ln|x+1| - \frac{1}{4} \ln(x^2+1) + \frac{1}{2} \tan^{-1} x \right]_0^b = \lim_{b \rightarrow \infty} \left[\frac{1}{2} \ln \left(\frac{x+1}{\sqrt{x^2+1}} \right) + \frac{1}{2} \tan^{-1} x \right]_0^b \\ = \lim_{b \rightarrow \infty} \left[\left(\frac{1}{2} \ln \left(\frac{b+1}{\sqrt{b^2+1}} \right) + \frac{1}{2} \tan^{-1} b \right) - \left(\frac{1}{2} \ln \frac{1}{\sqrt{1}} + \frac{1}{2} \tan^{-1} 0 \right) \right] = \frac{1}{2} \ln 1 + \frac{1}{2} \cdot \frac{\pi}{2} - \frac{1}{2} \ln 1 - \frac{1}{2} \cdot 0 = \frac{\pi}{4}$$

$$35. \int_0^{\pi/2} \tan \theta \, d\theta = \lim_{b \rightarrow (\pi/2)^-} \left[-\ln|\cos \theta| \right]_0^b = \lim_{b \rightarrow (\pi/2)^-} \left[-\ln|\cos b| + \ln 1 \right] = \lim_{b \rightarrow (\pi/2)^-} \left[-\ln|\cos b| \right] = +\infty, \text{ the integral diverges}$$

$$36. \int_0^{\pi/2} \cot \theta \, d\theta = \lim_{b \rightarrow 0^+} \left[\ln|\sin \theta| \right]_b^{\pi/2} = \lim_{b \rightarrow 0^+} \left[\ln 1 - \ln|\sin b| \right] = -\lim_{b \rightarrow 0^+} \left[\ln|\sin b| \right] = +\infty, \text{ the integral diverges}$$

$$37. \int_0^1 \frac{\ln x}{x^2} \, dx$$

$$\int_{1/3}^1 \frac{\ln x}{x^2} \, dx \text{ is bounded, so convergence is determined by } \int_0^{1/3} \frac{\ln x}{x^2} \, dx.$$

On $(0, 1/3]$, $\ln x < -1$ and $\frac{\ln x}{x^2} < -\frac{1}{x^2}$. Since $\int_0^{1/3} -\frac{1}{x^2} \, dx$ diverges to $-\infty$, so does $\int_0^{1/3} \frac{\ln x}{x^2} \, dx$ and

hence $\int_0^1 \frac{\ln x}{x^2} \, dx$ diverges.

38. Since $\int \frac{1}{x \ln x} dx = \ln(\ln x)$, $\int_1^2 \frac{1}{x \ln x} dx = \lim_{a \rightarrow 1^+} (\ln(\ln 2) - \ln(\ln a)) = \infty$; the integral diverges. (In this case we don't need a comparison test.)
39. $\int_0^{\ln 2} x^{-2} e^{-1/x} dx$; $[\frac{1}{x} = y] \rightarrow \int_{\infty}^{1/\ln 2} \frac{y^2 e^{-y} dy}{-y^3} = \int_{1/\ln 2}^{\infty} e^{-y} dy = \lim_{b \rightarrow \infty} [-e^{-y}]_{1/\ln 2}^b = \lim_{b \rightarrow \infty} [-e^{-b} - (-e^{-1/\ln 2})]$
 $= 0 + e^{-1/\ln 2} = e^{-1/\ln 2}$, so the integral converges.
40. $\int_0^1 \frac{e^{-\sqrt{x}}}{\sqrt{x}} dx$; $[y = \sqrt{x}] \rightarrow 2 \int_0^1 e^{-y} dy = 2 - \frac{2}{e}$, so the integral converges.
41. $\int_0^{\pi} \frac{dt}{\sqrt{t+\sin t}}$. Since for $0 \leq t \leq \pi$, $0 \leq \frac{1}{\sqrt{t+\sin t}} \leq \frac{1}{\sqrt{t}}$ and $\int_0^{\pi} \frac{dt}{\sqrt{t}}$ converges, then the original integral converges as well by the Direct Comparison Test.
42. $\int_0^1 \frac{dt}{t-\sin t}$; Let $f(t) = \frac{1}{t-\sin t}$ and $g(t) = \frac{1}{t^3}$, then $\lim_{t \rightarrow 0} \frac{f(t)}{g(t)} = \lim_{t \rightarrow 0} \frac{t^3}{t-\sin t} = \lim_{t \rightarrow 0} \frac{3t^2}{1-\cos t} = \lim_{t \rightarrow 0} \frac{6t}{\sin t} = \lim_{t \rightarrow 0} \frac{6}{\cos t} = 6$.
 Now, $\int_0^1 \frac{dt}{t^3} = \lim_{b \rightarrow 0^+} \left[-\frac{1}{2t^2} \right]_b^1 = \lim_{b \rightarrow 0^+} \left[-\frac{1}{2} - \left(-\frac{1}{2b^2} \right) \right] = +\infty$, which diverges $\Rightarrow \int_0^1 \frac{dt}{t-\sin t}$ diverges by the Limit Comparison Test.
43. $\int_0^2 \frac{dx}{1-x^2} = \int_0^1 \frac{dx}{1-x^2} + \int_1^2 \frac{dx}{1-x^2}$ and $\int_0^1 \frac{dx}{1-x^2} = \lim_{b \rightarrow 1^-} \left[\frac{1}{2} \ln \left| \frac{1+x}{1-x} \right| \right]_0^b = \lim_{b \rightarrow 1^-} \left[\frac{1}{2} \ln \left| \frac{1+b}{1-b} \right| - 0 \right] = \infty$, which diverges
 $\Rightarrow \int_0^2 \frac{dx}{1-x^2}$ diverges as well.
44. $\int_0^2 \frac{dx}{1-x} = \int_0^1 \frac{dx}{1-x} + \int_1^2 \frac{dx}{1-x}$ and $\int_0^1 \frac{dx}{1-x} = \lim_{b \rightarrow 1^-} [-\ln(1-x)]_0^b = \lim_{b \rightarrow 1^-} [-\ln(1-b) - 0] = \infty$, which diverges
 $\Rightarrow \int_0^2 \frac{dx}{1-x}$ diverges as well.
45. $\int_{-1}^1 \ln|x| dx = \int_{-1}^0 \ln(-x) dx + \int_0^1 \ln x dx$; $\int_0^1 \ln x dx = \lim_{b \rightarrow 0^+} [x \ln x - x]_b^1 = \lim_{b \rightarrow 0^+} [(1 \cdot 0 - 1) - (b \ln b - b)]$
 $= -1 - 0 = -1$; $\int_{-1}^0 \ln(-x) dx = -1 \Rightarrow \int_{-1}^1 \ln|x| dx = -2$ converges.
46. $\int_{-1}^1 (-x \ln|x|) dx = \int_{-1}^0 [-x \ln(-x)] dx + \int_0^1 (-x \ln x) dx = \lim_{b \rightarrow 0^+} \left[\frac{x^2}{2} \ln x - \frac{x^2}{4} \right]_b^1 - \lim_{c \rightarrow 0^+} \left[\frac{x^2}{2} \ln x - \frac{x^2}{4} \right]_c^1$
 $= \lim_{b \rightarrow 0^+} \left[\left(\frac{1}{2} \ln 1 - \frac{1}{4} \right) - \left(\frac{b^2}{2} \ln b - \frac{b^2}{4} \right) \right] - \lim_{c \rightarrow 0^+} \left[\left(\frac{1}{2} \ln 1 - \frac{1}{4} \right) - \left(\frac{c^2}{2} \ln c - \frac{c^2}{4} \right) \right] = -\frac{1}{4} - 0 + \frac{1}{4} + 0 = 0 \Rightarrow$ the integral converges (see Exercise 25 for the limit calculations).
47. $\int_1^{\infty} \frac{dx}{1+x^3}$; $0 \leq \frac{1}{x^3+1} \leq \frac{1}{x^3}$ for $1 \leq x < \infty$ and $\int_1^{\infty} \frac{dx}{x^3}$ converges $\Rightarrow \int_1^{\infty} \frac{dx}{1+x^3}$ converges by the Direct Comparison Test.

48. $\int_4^{\infty} \frac{dx}{\sqrt{x-1}}$; $\lim_{x \rightarrow \infty} \frac{\left(\frac{1}{\sqrt{x-1}}\right)}{\left(\frac{1}{\sqrt{x}}\right)} = \lim_{x \rightarrow \infty} \frac{\sqrt{x}}{\sqrt{x-1}} = \lim_{x \rightarrow \infty} \frac{1}{1-\frac{1}{\sqrt{x}}} = \frac{1}{1-0} = 1$ and $\int_4^{\infty} \frac{dx}{\sqrt{x}} = \lim_{b \rightarrow \infty} \left[2\sqrt{x}\right]_4^b = \infty$, which diverges
 $\Rightarrow \int_4^{\infty} \frac{dx}{\sqrt{x-1}}$ diverges by the Limit Comparison Test.
49. $\int_2^{\infty} \frac{dv}{\sqrt{v-1}}$; $\lim_{v \rightarrow \infty} \frac{\left(\frac{1}{\sqrt{v-1}}\right)}{\left(\frac{1}{\sqrt{v}}\right)} = \lim_{v \rightarrow \infty} \frac{\sqrt{v}}{\sqrt{v-1}} = \lim_{v \rightarrow \infty} \frac{1}{\sqrt{1-\frac{1}{v}}} = \frac{1}{\sqrt{1-0}} = 1$ and $\int_2^{\infty} \frac{dv}{\sqrt{v}} = \lim_{b \rightarrow \infty} \left[2\sqrt{v}\right]_2^b = \infty$, which diverges
 $\Rightarrow \int_2^{\infty} \frac{dv}{\sqrt{v-1}}$ diverges by the Limit Comparison Test.
50. $\int_0^{\infty} \frac{d\theta}{1+e^{\theta}}$; $0 \leq \frac{1}{1+e^{\theta}} \leq \frac{1}{e^{\theta}}$ for $0 \leq \theta < \infty$ and $\int_0^{\infty} \frac{d\theta}{e^{\theta}} = \lim_{b \rightarrow \infty} \left[-e^{-\theta}\right]_0^b = \lim_{b \rightarrow \infty} (-e^{-b} + 1) = 1 \Rightarrow \int_0^{\infty} \frac{d\theta}{e^{\theta}}$ converges
 $\Rightarrow \int_0^{\infty} \frac{d\theta}{1+e^{\theta}}$ by the Direct Comparison Test.
51. $\int_0^{\infty} \frac{dx}{\sqrt{x^6+1}} = \int_0^1 \frac{dx}{\sqrt{x^6+1}} + \int_1^{\infty} \frac{dx}{\sqrt{x^6+1}} < \int_0^1 \frac{dx}{\sqrt{x^6+1}} + \int_1^{\infty} \frac{dx}{x^3}$ and $\int_1^{\infty} \frac{dx}{x^3} = \lim_{b \rightarrow \infty} \left[-\frac{1}{2x^2}\right]_1^b = \lim_{b \rightarrow \infty} \left(-\frac{1}{2b^2} + \frac{1}{2}\right) = \frac{1}{2}$
 $\Rightarrow \int_0^{\infty} \frac{dx}{\sqrt{x^6+1}}$ converges by the Direct Comparison Test.
52. $\int_2^{\infty} \frac{dx}{\sqrt{x^2-1}}$; $\lim_{x \rightarrow \infty} \frac{\left(\frac{1}{\sqrt{x^2-1}}\right)}{\left(\frac{1}{x}\right)} = \lim_{x \rightarrow \infty} \frac{x}{\sqrt{x^2-1}} = \lim_{x \rightarrow \infty} \frac{1}{\sqrt{1-\frac{1}{x^2}}} = 1$; $\int_2^{\infty} \frac{1}{x} dx = \lim_{b \rightarrow \infty} [\ln b]_2^b = \infty$, which diverges
 $\Rightarrow \int_2^{\infty} \frac{dx}{\sqrt{x^2-1}}$ diverges by the Limit Comparison Test.
53. $\int_1^{\infty} \frac{\sqrt{x+1}}{x^2} dx$; $\lim_{x \rightarrow \infty} \frac{\left(\frac{\sqrt{x}}{x^2}\right)}{\left(\frac{\sqrt{x+1}}{x^2}\right)} = \lim_{x \rightarrow \infty} \frac{\sqrt{x}}{\sqrt{x+1}} = \lim_{x \rightarrow \infty} \frac{1}{\sqrt{1+\frac{1}{x}}} = 1$; $\int_1^{\infty} \frac{\sqrt{x}}{x^2} dx = \int_1^{\infty} \frac{dx}{x^{3/2}} = \lim_{b \rightarrow \infty} \left[-2x^{-1/2}\right]_1^b = \lim_{b \rightarrow \infty} \left(\frac{-2}{\sqrt{b}} + 2\right)$
 $= 2 \Rightarrow \int_1^{\infty} \frac{\sqrt{x+1}}{x^2} dx$ converges by the Limit Comparison Test.
54. $\int_2^{\infty} \frac{x dx}{\sqrt{x^4-1}}$; $\lim_{x \rightarrow \infty} \frac{\left(\frac{x}{\sqrt{x^4-1}}\right)}{\left(\frac{x}{\sqrt{x^4}}\right)} = \lim_{x \rightarrow \infty} \frac{\sqrt{x^4}}{\sqrt{x^4-1}} = \lim_{x \rightarrow \infty} \frac{1}{\sqrt{1-\frac{1}{x^4}}} = 1$; $\int_2^{\infty} \frac{x dx}{\sqrt{x^4}} = \int_2^{\infty} \frac{dx}{x} = \lim_{x \rightarrow \infty} [\ln x]_2^b = \infty$, which diverges
 $\Rightarrow \int_2^{\infty} \frac{x dx}{\sqrt{x^4-1}}$ diverges by the Limit Comparison Test.
55. $\int_{\pi}^{\infty} \frac{2+\cos x}{x} dx$; $0 < \frac{1}{x} \leq \frac{2+\cos x}{x}$ for $x \geq \pi$ and $\int_{\pi}^{\infty} \frac{dx}{x} = \lim_{b \rightarrow \infty} [\ln x]_{\pi}^b = \infty$, which diverges $\Rightarrow \int_{\pi}^{\infty} \frac{2+\cos x}{x} dx$ diverges by the Direct Comparison Test.

56. $\int_{\pi}^{\infty} \frac{1+\sin x}{x^2} dx$; $0 \leq \frac{1+\sin x}{x^2} \leq \frac{2}{x^2}$ for $x \geq \pi$ and $\int_{\pi}^{\infty} \frac{2}{x^2} dx = \lim_{b \rightarrow \infty} \left[-\frac{2}{x} \right]_{\pi}^b = \lim_{b \rightarrow \infty} \left(-\frac{2}{b} + \frac{2}{\pi} \right) = \frac{2}{\pi} \Rightarrow \int_{\pi}^{\infty} \frac{2}{x^2} dx$ converges $\Rightarrow \int_{\pi}^{\infty} \frac{1+\sin x}{x^2} dx$ converges by the Direct Comparison Test.
57. $\int_4^{\infty} \frac{2 dt}{t^{3/2}-1}$; $\lim_{t \rightarrow \infty} \frac{t^{3/2}}{t^{3/2}-1} = 1$ and $\int_4^{\infty} \frac{2 dt}{t^{3/2}} = \lim_{b \rightarrow \infty} \left[-4t^{-1/2} \right]_4^b = \lim_{b \rightarrow \infty} \left(\frac{-4}{\sqrt{b}} + 2 \right) = 2 \Rightarrow \int_4^{\infty} \frac{2 dt}{t^{3/2}}$ converges $\Rightarrow \int_4^{\infty} \frac{2 dt}{t^{3/2}-1}$ converges by the Limit Comparison Test.
58. $\int_2^{\infty} \frac{dx}{\ln x}$; $0 < \frac{1}{x} < \frac{1}{\ln x}$ for $x > 2$ and $\int_2^{\infty} \frac{dx}{x}$ diverges $\Rightarrow \int_2^{\infty} \frac{dx}{\ln x}$ diverges by the Direct Comparison Test.
59. $\int_1^{\infty} \frac{e^x}{x} dx$; $0 < \frac{1}{x} < \frac{e^x}{x}$ for $x > 1$ and $\int_1^{\infty} \frac{dx}{x}$ diverges $\Rightarrow \int_1^{\infty} \frac{e^x dx}{x}$ diverges by the Direct Comparison Test.
60. $\int_e^{\infty} \ln(\ln x) dx$; $[x = e^y] \rightarrow \int_e^{\infty} (\ln y)e^y dy$; $0 < \ln y < (\ln y)e^y$ for $y \geq e$ and $\int_e^{\infty} \ln y dy = \lim_{b \rightarrow \infty} [y \ln y - y]_e^b = \infty$, which diverges $\Rightarrow \int_e^{\infty} (\ln y)e^y dy$ diverges $\Rightarrow \int_e^{\infty} \ln(\ln x) dx$ diverges by the Direct Comparison Test.
61. $\int_1^{\infty} \frac{dx}{\sqrt{e^x-x}}$; $\lim_{x \rightarrow \infty} \frac{\left(\frac{1}{\sqrt{e^x-x}}\right)}{\left(\frac{1}{\sqrt{e^x}}\right)} = \lim_{x \rightarrow \infty} \frac{\sqrt{e^x}}{\sqrt{e^x-x}} = \lim_{x \rightarrow \infty} \frac{1}{\sqrt{1-\frac{x}{e^x}}} = \frac{1}{\sqrt{1-0}} = 1$; $\int_1^{\infty} \frac{dx}{\sqrt{e^x}} = \int_1^{\infty} e^{-x/2} dx = \lim_{b \rightarrow \infty} \left[-2e^{-x/2} \right]_1^b$
 $= \lim_{b \rightarrow \infty} \left(-2e^{-b/2} + 2e^{-1/2} \right) = \frac{2}{\sqrt{e}} \Rightarrow \int_1^{\infty} e^{-x/2} dx$ converges $\Rightarrow \int_1^{\infty} \frac{dx}{\sqrt{e^x-x}}$ converges by the Limit Comparison Test.
62. $\int_1^{\infty} \frac{dx}{e^x-2^x}$; $\lim_{x \rightarrow \infty} \frac{\left(\frac{1}{e^x-2^x}\right)}{\left(\frac{1}{e^x}\right)} = \lim_{x \rightarrow \infty} \frac{e^x}{e^x-2^x} = \lim_{x \rightarrow \infty} \frac{1}{1-\left(\frac{2}{e}\right)^x} = \frac{1}{1-0} = 1$ and $\int_1^{\infty} \frac{dx}{e^x} = \lim_{b \rightarrow \infty} \left[-e^{-x} \right]_1^b = \lim_{b \rightarrow \infty} \left(-e^{-b} + e^{-1} \right) = \frac{1}{e}$
 $\Rightarrow \int_1^{\infty} \frac{dx}{e^x}$ converges $\Rightarrow \int_1^{\infty} \frac{dx}{e^x-2^x}$ converges by the Limit Comparison Test.
63. $\int_{-\infty}^{\infty} \frac{dx}{\sqrt{x^4+1}} = 2 \int_0^{\infty} \frac{dx}{\sqrt{x^4+1}}$; $\int_0^{\infty} \frac{dx}{\sqrt{x^4+1}} = \int_0^1 \frac{dx}{\sqrt{x^4+1}} + \int_1^{\infty} \frac{dx}{\sqrt{x^4+1}} < \int_0^1 \frac{dx}{\sqrt{x^4+1}} + \int_1^{\infty} \frac{dx}{x^2}$ and $\int_1^{\infty} \frac{dx}{x^2} = \lim_{b \rightarrow \infty} \left[-\frac{1}{x} \right]_1^b$
 $= \lim_{b \rightarrow \infty} \left(-\frac{1}{b} + 1 \right) = 1 \Rightarrow \int_{-\infty}^{\infty} \frac{dx}{\sqrt{x^4+1}}$ converges by the Direct Comparison Test.
64. $\int_{-\infty}^{\infty} \frac{dx}{e^x+e^{-x}} = 2 \int_0^{\infty} \frac{dx}{e^x+e^{-x}}$; $0 < \frac{1}{e^x+e^{-x}} < \frac{1}{e^x}$ for $x > 0$; $\int_0^{\infty} \frac{dx}{e^x}$ converges $\Rightarrow 2 \int_0^{\infty} \frac{dx}{e^x+e^{-x}}$ converges by the Direct Comparison Test.
65. (a) $\int_1^2 \frac{dx}{x(\ln x)^p}$; $[t = \ln x] \rightarrow \int_0^{\ln 2} \frac{dt}{t^p} = \lim_{b \rightarrow 0^+} \left[\frac{1}{-p+1} t^{1-p} \right]_b^{\ln 2} = \lim_{b \rightarrow 0^+} \left[\frac{b^{1-p}}{p-1} + \frac{1}{1-p} (\ln 2)^{1-p} \right] \Rightarrow$ the integral converges for $p < 1$ and diverges for $p \geq 1$

(b) $\int_2^{\infty} \frac{dx}{x(\ln x)^p}$; $[t = \ln x] \rightarrow \int_{\ln 2}^{\infty} \frac{dt}{t^p}$ and this integral is essentially the same as in Exercise 65(a): it converges for $p > 1$ and diverges for $p \leq 1$

66. $\int_0^{\infty} \frac{2x}{x^2+1} dx = \lim_{b \rightarrow \infty} \left[\ln(x^2+1) \right]_0^b = \lim_{b \rightarrow \infty} \left[\ln(b^2+1) - 0 \right] = \lim_{b \rightarrow \infty} \ln(b^2+1) = \infty \Rightarrow$ the integral $\int_{-\infty}^{\infty} \frac{2x}{x^2+1} dx$ diverges. But $\lim_{b \rightarrow \infty} \int_{-\infty}^b \frac{2x}{x^2+1} dx = \lim_{b \rightarrow \infty} \left[\ln(x^2+1) \right]_{-b}^b = \lim_{b \rightarrow \infty} \left[\ln(b^2+1) - \ln(b^2+1) \right] = \lim_{b \rightarrow \infty} \ln\left(\frac{b^2+1}{b^2+1}\right) = \lim_{b \rightarrow \infty} (\ln 1) = 0$

67. $A = \int_0^{\infty} e^{-x} dx = \lim_{b \rightarrow \infty} \left[-e^{-x} \right]_0^b$
 $= \lim_{b \rightarrow \infty} \left[(-e^{-b}) - (-e^{-0}) \right] = 0 + 1 = 1$

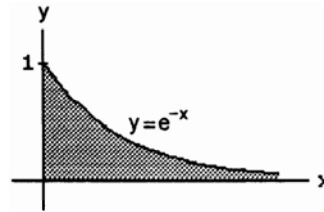

68. $\bar{x} = \frac{1}{A} \int_0^{\infty} x e^{-x} dx = \lim_{b \rightarrow \infty} \left[-x e^{-x} - e^{-x} \right]_0^b = \lim_{b \rightarrow \infty} \left[(-b e^{-b} - e^{-b}) - (-0 \cdot e^{-0} - e^{-0}) \right] = 0 + 1 = 1;$
 $\bar{y} = \frac{1}{2A} \int_0^{\infty} (e^{-x})^2 dx = \frac{1}{2} \int_0^{\infty} e^{-2x} dx = \lim_{b \rightarrow \infty} \frac{1}{2} \left[-\frac{1}{2} e^{-2x} \right]_0^b = \lim_{b \rightarrow \infty} \left[\frac{1}{2} \left(-\frac{1}{2} e^{-2b} \right) - \frac{1}{2} \left(-\frac{1}{2} e^{-2 \cdot 0} \right) \right] = 0 + \frac{1}{4} = \frac{1}{4}$

69. $V = \int_0^{\infty} 2\pi x e^{-x} dx = 2\pi \int_0^{\infty} x e^{-x} dx = 2\pi \lim_{b \rightarrow \infty} \left[-x e^{-x} - e^{-x} \right]_0^b = 2\pi \lim_{b \rightarrow \infty} \left[(-b e^{-b} - e^{-b}) - 1 \right] = 2\pi$

70. $V = \int_0^{\infty} \pi (e^{-x})^2 dx = \pi \int_0^{\infty} e^{-2x} dx = \pi \lim_{b \rightarrow \infty} \left[-\frac{1}{2} e^{-2x} \right]_0^b = \pi \lim_{b \rightarrow \infty} \left(-\frac{1}{2} e^{-2b} + \frac{1}{2} \right) = \frac{\pi}{2}$

71. $A = \int_0^{\pi/2} (\sec x - \tan x) dx = \lim_{b \rightarrow (\pi/2)^-} \left[\ln |\sec x + \tan x| - \ln |\sec x| \right]_0^b = \lim_{b \rightarrow (\pi/2)^-} \left[\ln \left| 1 + \frac{\tan b}{\sec b} \right| - \ln |1 + 0| \right]$
 $= \lim_{b \rightarrow (\pi/2)^-} \ln |1 + \sin b| = \ln 2$

72. (a) $V \int_0^{\pi/2} \pi \sec^2 x dx - \int_0^{\pi/2} \pi \tan^2 x dx = \pi \int_0^{\pi/2} (\sec^2 x - \tan^2 x) dx = \int_0^{\pi/2} \pi \left[\sec^2 x - (\sec^2 x - 1) \right] dx$
 $= \pi \int_0^{\pi/2} dx = \frac{\pi^2}{2}$

(b) $S_{\text{outer}} = \int_0^{\pi/2} 2\pi \sec x \sqrt{1 + \sec^2 x \tan^2 x} dx \geq \int_0^{\pi/2} 2\pi \sec x (\sec x \tan x) dx = \pi \lim_{b \rightarrow (\pi/2)^-} \left[\tan^2 x \right]_0^b =$
 $\pi \lim_{b \rightarrow (\pi/2)^-} \left[(\tan^2 b) - 0 \right] = \pi \lim_{b \rightarrow (\pi/2)^-} \left[\tan^2 b \right] = \infty \Rightarrow S_{\text{outer}} \text{ diverges; } S_{\text{inner}} = \int_0^{\pi/2} 2\pi \tan x \sqrt{1 + \sec^4 x} dx \geq$
 $\int_0^{\pi/2} 2\pi \tan x \sec^2 x dx = \pi \lim_{b \rightarrow (\pi/2)^-} \left[\tan^2 x \right]_0^b = \pi \lim_{b \rightarrow (\pi/2)^-} \left[(\tan^2 b) - 0 \right] = \pi \lim_{b \rightarrow (\pi/2)^-} \left[\tan^2 b \right] = \infty \Rightarrow S_{\text{inner}}$
 diverges

$$73. \text{ (a) } \int_0^1 \frac{1}{\sqrt{t}(1+t)} dt$$

With $u = \sqrt{t}$ and $du = \frac{1}{2\sqrt{t}} dt$ the limits of integration are unchanged.

$$\begin{aligned} \int_0^1 \frac{1}{\sqrt{t}(1+t)} dt &= \int_0^1 \frac{2}{1+u^2} du \\ &= 2 \lim_{a \rightarrow 0^+} \left(\tan^{-1} 1 - \tan^{-1} a \right) \\ &= 2 \cdot \frac{\pi}{4} = \frac{\pi}{2} \end{aligned}$$

$$\text{(b) } \int_0^\infty \frac{1}{\sqrt{t}(1+t)} dt$$

With $u = \sqrt{t}$ and $du = \frac{1}{2\sqrt{t}} dt$ the limits of integration are unchanged. We split the integral into two integrals, the first of which was evaluated in (a).

$$\begin{aligned} \int_0^\infty \frac{1}{\sqrt{t}(1+t)} dt &= \int_0^1 \frac{2}{1+u^2} du + \int_1^\infty \frac{2}{1+u^2} du \\ &= \frac{\pi}{2} + 2 \lim_{b \rightarrow \infty} \left(\tan^{-1} b - \tan^{-1} 1 \right) \\ &= \frac{\pi}{2} + 2 \left(\frac{\pi}{2} - \frac{\pi}{4} \right) = \pi \end{aligned}$$

74. Let c be any number in $(3, \infty)$.

$$\int_3^\infty \frac{1}{x\sqrt{x^2-9}} dx = \int_3^c \frac{1}{x\sqrt{x^2-9}} dx + \int_c^\infty \frac{1}{x\sqrt{x^2-9}} dx \text{ provided both integrals on the right converge.}$$

Formula 20 in Table 8.1 gives $\int \frac{1}{x\sqrt{x^2-9}} dx = \frac{1}{3} \sec^{-1} \left| \frac{x}{3} \right|$. (The definition of the inverse secant is given in Section 3.9.) Both integrals do converge:

$$\int_3^c \frac{1}{x\sqrt{x^2-9}} dx = \lim_{a \rightarrow 3^+} \left(\frac{1}{3} \sec^{-1} \left| \frac{c}{3} \right| - \frac{1}{3} \sec^{-1} \left| \frac{a}{3} \right| \right) = \frac{1}{3} \sec^{-1} \frac{c}{3}$$

$$\int_c^\infty \frac{1}{x\sqrt{x^2-9}} dx = \lim_{b \rightarrow \infty} \left(\frac{1}{3} \sec^{-1} \left| \frac{b}{3} \right| - \frac{1}{3} \sec^{-1} \left| \frac{c}{3} \right| \right) = \frac{\pi}{6} - \frac{1}{3} \sec^{-1} \frac{c}{3}$$

$$\text{Thus } \int_3^\infty \frac{1}{x\sqrt{x^2-9}} dx = \frac{\pi}{6}.$$

75. (a) $\int_3^\infty e^{-3x} dx = \lim_{b \rightarrow \infty} \left[-\frac{1}{3} e^{-3x} \right]_3^b = \lim_{b \rightarrow \infty} \left[\left(-\frac{1}{3} e^{-3b} \right) - \left(-\frac{1}{3} e^{-3 \cdot 3} \right) \right] = 0 + \frac{1}{3} \cdot e^{-9} = \frac{1}{3} e^{-9} \approx 0.0000411$
 < 0.000042 . Since $e^{-x^2} \leq e^{-3x}$ for $x > 3$, then $\int_3^\infty e^{-x^2} dx < 0.000042$ and therefore $\int_0^\infty e^{-x^2} dx$ can be replaced by $\int_0^3 e^{-x^2} dx$ without introducing an error greater than 0.000042.

(b) $\int_0^3 e^{-x^2} dx \approx 0.88621$

76. (a) $V = \int_1^\infty \pi \left(\frac{1}{x} \right)^2 dx = \pi \lim_{b \rightarrow \infty} \left[-\frac{1}{x} \right]_1^b = \pi \lim_{b \rightarrow \infty} \left[\left(-\frac{1}{b} \right) - \left(-\frac{1}{1} \right) \right] = \pi(0+1) = \pi$

(b) When you take the limit to ∞ , you are no longer modeling the real world which is finite. The comparison step in the modeling process discussed in Section 4.2 relating the mathematical world to the real world fails to hold.

77. (a)

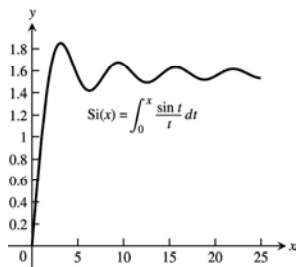

(b) `> int((sin(t))/t, t = 0.. infinity);` (answer is $\frac{\pi}{2}$)

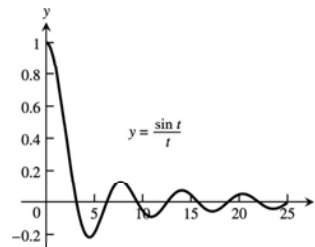

78. (a)

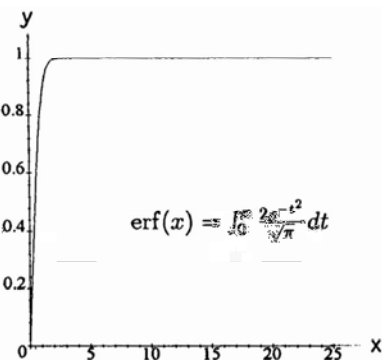

(b) `> f:=2*exp(-t^2)/sqrt(Pi);`
`> int(f, t=0..infinity);` (answer is 1)

79. (a) $f(x) = \frac{1}{\sqrt{2\pi}} e^{-x^2/2}$
 f is increasing on $(-\infty, 0]$,
 f is decreasing on $[0, \infty)$,
 f has a local maximum at $(0, f(0)) = \left(0, \frac{1}{\sqrt{2\pi}} \right)$

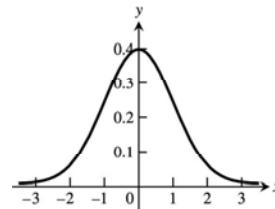

(b) Maple commands:
`>f:=exp(-x^2/2)(sqrt(2*pi));`
`>int(f, x = -1..1);` ≈ 0.683
`>int(f, x = -2..2);` ≈ 0.954
`>int(f, x = -3..3);` ≈ 0.997

- (c) Part (b) suggests that as n increases, the integral approaches 1. We can take $\int_{-n}^n f(x) dx$ as close to 1 as we want by choosing $n > 1$ large enough. Also, we can make $\int_n^\infty f(x) dx$ and $\int_{-\infty}^{-n} f(x) dx$ as small as we want by choosing n large enough. This is because $0 < f(x) < e^{-x/2}$ for $x > 1$. (Likewise, $0 < f(x) < e^{x/2}$ for $x < -1$.) Thus, $\int_n^\infty f(x) dx < \int_n^\infty e^{-x/2} dx$.

$$\int_n^\infty e^{-x/2} dx = \lim_{c \rightarrow \infty} \int_n^c e^{-x/2} dx = \lim_{c \rightarrow \infty} \left[-2e^{-x/2} \right]_n^c = \lim_{c \rightarrow \infty} \left[-2e^{-c/2} + 2e^{-n/2} \right] = 2e^{-n/2}$$

As $n \rightarrow \infty$, $2e^{-n/2} \rightarrow 0$, for large enough n , $\int_n^\infty f(x) dx$ is as small as we want.

Likewise for large enough n , $\int_{-\infty}^{-n} f(x) dx$ is as small as we want.

80. (a) The statement is true since $\int_{-\infty}^b f(x) dx = \int_{-\infty}^a f(x) dx + \int_a^b f(x) dx$, $\int_b^\infty f(x) dx = \int_a^\infty f(x) dx - \int_a^b f(x) dx$ and $\int_a^b f(x) dx$ exists since $f(x)$ is integrable on every interval $[a, b]$.
- (b) $\int_{-\infty}^a f(x) dx + \int_a^\infty f(x) dx = \int_{-\infty}^a f(x) dx + \int_a^b f(x) dx - \int_a^b f(x) dx + \int_a^\infty f(x) dx$
 $= \int_{-\infty}^b f(x) dx + \int_b^a f(x) dx + \int_a^\infty f(x) dx = \int_{-\infty}^b f(x) dx + \int_b^\infty f(x) dx$

81. Example CAS commands:

Maple:

```
f := (x,p) -> x^p*ln(x);
domain := 0..exp(1);
fn_list := [seq( f(x,p), p=-2..2 )];
plot( fn_list, x=domain, y=-50..10, color=[red,blue,green,cyan,pink], linestyle=[1,3,4,7,9],
      thickness=[3,4,1,2,0], legend=["p= -2", "p= -1", "p= 0", "p= 1", "p= 2"], title="#81 (Section 8.8)");
q1 := Int( f(x,p), x=domain );
q2 := value( q1 );
q3 := simplify( q2 ) assuming p>-1;
q4 := simplify( q2 ) assuming p<-1;
q5 := value( eval( q1, p=-1 ) );
i1 := q1 = piecewise( p<-1, q4, p=-1, q5, p>-1, q3 );
```

82. Example CAS commands:

Maple:

```
f := (x,p) -> x^p*ln(x);
domain := exp(1)..infinity;
fn_list := [seq( f(x,p), p=-2..2 )];
plot( fn_list, x=exp(1)..10, y=0..100, color=[red,blue,green,cyan,pink], linestyle=[1,3,4,7,9],
      thickness=[3,4,1,2,0], legend=["p= -2", "p= -1", "p= 0", "p= 1", "p= 2"], title="#82 (Section 8.8)");
```

```

q6 := Int( f(x,p), x=domain );
q7 := value( q6 );
q8 := simplify( q7 ) assuming p>-1;
q9 := simplify( q7 ) assuming p<-1;
q10 := value( eval( q6, p=-1 ) );
i2 := q6 = piecewise( p<-1, q9, p=-1, q10, p>-1, q8 );

```

83. Example CAS commands:

Maple:

```

f := (x,p) -> x^p*ln(x);
domain := 0..infinity;
fn_list := [seq( f(x,p), p=-2..2 )];
plot( fn_list, x=0..10, y=-50..50, color=[red,blue,green,cyan,pink], linestyle=[1,3,4,7,9],
      thickness=[3,4,1,2,0], legend=["p= -2","p = -1","p = 0","p = 1","p = 2"], title="#83 (Section 8.8)" );
q11 := Int( f(x,p), x=domain );
q11 = lhs(i1+i2);
`` = rhs(i1+i2);
`` = piecewise( p<-1, q4+q9, p=-1, q5+q10, p>-1, q3+q8 );
`` = piecewise( p<-1, -infinity, p=-1, undefined, p>-1, infinity );

```

84. Example CAS commands:

Maple:

```

f := (x,p) -> x^p*ln(abs(x));
domain := -infinity..infinity;
fn_list := [seq( f(x,p), p=-2..2 )];
plot( fn_list, x=4..4, y=-20..10, color=[red,blue,green,cyan,pink], linestyle=[1,3,4,7,9],
      legend=["p= -2","p = -1","p = 0","p = 1","p = 2"], title="#84 (Section 8.8)" );
q12 := Int( f(x,p), x=domain );
q12p := Int( f(x,p), x=0..infinity );
q12n := Int( f(x,p), x=-infinity..0 );
q12 = q12p + q12n;
`` = simplify( q12p+q12n );

```

81-84. Example CAS commands:

Mathematica: (functions and domains may vary)

```

Clear[x, f, p]
f[x_]:= x^P Log[Abs[x]]
int = Integrate[f[x], {x, e, 100}]
int /. p -> 2.5

```

In order to plot the function, a value for p must be selected.

$$p = 3;$$

$$\text{Plot}[f[x], \{x, 2.72, 10\}]$$

85. Maple gives $\int_0^{2/\pi} \sin\left(\frac{1}{x}\right) dx = \frac{1}{\pi} \left(2 - \pi \cdot \text{Ci}\left(\frac{\pi}{2}\right) \right) \approx 0.16462$, where Ci is the cosine integral function defined

$$\text{by } \text{Ci}(t) = -\int_t^\infty \frac{\cos x}{x} dx.$$

86. Maple gives $\int_0^{2/\pi} x \sin\left(\frac{1}{x}\right) dx = \frac{2}{\pi^2} + \frac{1}{2} \text{Si}\left(\frac{\pi}{2}\right) - \frac{\pi}{4} \approx 0.10276$, where Si is the sine integral function defined by

$$\text{Si}(t) = \int_0^t \frac{\sin x}{x} dx.$$

8.9 PROBABILITY

1. $\int_4^8 \frac{1}{18} x dx = \frac{4}{3} \neq 1$; not a probability density.

2. $\int_0^2 \frac{1}{2} (2-x) dx = 1$; a probability density.

3. $\int_0^{\ln(1+\ln 2)/\ln 2} 2^x dx = \frac{2^x}{\ln 2} \Big|_0^{\ln(1+\ln 2)/\ln 2}$
 $= \left(\frac{1+\ln 2}{\ln 2} - \frac{1}{\ln 2} \right) = 1$

This is a probability density.

4. $x-1$ is not nonnegative on $[0, 1+\sqrt{3}]$, so not a probability density.

5. $\int_1^\infty \frac{1}{x^2} dx = 1$; a probability density.

6. $\int_0^\infty \frac{8}{\pi(4+x^2)} dx = \lim_{b \rightarrow \infty} \left(\frac{4}{\pi} \tan^{-1}\left(\frac{x}{2}\right) \Big|_0^b \right)$
 $= \frac{4}{\pi} \cdot \frac{\pi}{2} = 2$

This is not a probability density.

7. $\int_0^{\pi/4} 2 \cos 2x dx = 1$; a probability density.

8. $\int_0^e \frac{1}{x} dx$ diverges; not a probability density.
9. (a) The probability that a tire lasts between 25,000 and 32,000 miles
 (b) The probability that a tire lasts more than 30,000 miles
 (c) The probability that a tire lasts less than 20,000 miles
 (d) The probability that a tire lasts less than 15,000 miles
10. (a) $\int_{\pi}^{3\pi/2} \frac{1}{2\pi} dx + \int_{\pi/2}^{\pi} \frac{1}{2\pi} dx = 0.5$
 (b) $\int_2^{2\pi} \frac{1}{2\pi} dx = 1 - \frac{1}{\pi} \approx 0.682$
11. $\int_1^3 xe^{-x} dx = -(x+1)e^{-x} \Big|_1^3 = -4e^{-3} + 2e^{-1} \approx 0.537$
12. $\int_2^{15} \frac{\ln x}{x^2} dx = -\frac{\ln x + 1}{x} \Big|_2^{15} = -\frac{\ln 15}{15} - \frac{1}{15} + \frac{\ln 2}{2} + \frac{1}{2} \approx 0.599$
13. $\int_0^1 \frac{3}{2} x(2-x) dx = -\frac{1}{2} x^2(x-3) \Big|_{1/2}^1 = \frac{11}{16} \approx 0.688$
14. Using software to evaluate the Sine Integral we find $\int_{\frac{200}{1059}}^{\infty} \frac{\sin^2 \pi x}{\pi x^2} dx \approx 1.00004780741$ so the given function is very nearly a probability density over the given interval. Again using software we find that
- $$\int_{\frac{200}{1059}}^{\pi/6} \frac{\sin^2 \pi x}{\pi x^2} dx \approx 0.6732.$$
15. $\int_4^9 \frac{2}{x^3} dx = \frac{65}{1296} \approx 0.0502$
16. $\int_{\pi/6}^{\pi/4} \sin x dx = -\cos x \Big|_{\pi/6}^{\pi/4} = -\frac{\sqrt{2}}{2} + \frac{\sqrt{3}}{2} \approx 0.159$
17. $\int_3^c \frac{1}{6} x dx = \frac{1}{12} c^2 - \frac{3}{4}$. Solving $\frac{1}{12} c^2 - \frac{3}{4} = 1$, we find $c = \sqrt{21}$.
18. $\int_c^{c+1} \frac{1}{x} dx = \ln(c+1) - \ln c = \ln\left(\frac{c+1}{c}\right)$. Solving $\ln\left(\frac{c+1}{c}\right) = 1$, we find $\frac{c+1}{c} = e$ and thus $c = \frac{1}{e-1}$.
19. $\int_0^c 4e^{-2x} dx = -2e^{-2c} + 2$. Solving $-2e^{-2c} + 2 = 1$, we find $c = \frac{1}{2} \ln 2$.

$$20. \int_0^5 cx\sqrt{25-x^2} dx = -\frac{1}{3}c(25-x^2)^{3/2} \Big|_0^5 = \frac{125}{3}c, \text{ so } c = \frac{3}{125}.$$

21. We will assume that the given function is to be a probability density over the whole real line.

$$\int_{-\infty}^{\infty} \frac{c}{1+x^2} dx = c\pi \text{ so we take } c = \frac{1}{\pi}. \text{ Then } \int_1^2 \frac{1}{\pi(1+x^2)} dx = \frac{\tan^{-1} x}{\pi} \Big|_1^2 = \frac{\tan^{-1} 2}{\pi} - \frac{1}{4} \approx 0.10242.$$

$$22. \int_0^1 c\sqrt{x}(1-x) dx = c\left(\frac{2}{3}x^{3/2} - \frac{2}{5}x^{5/2}\right) \Big|_0^1 = \frac{4}{15}c, \text{ so } c = \frac{15}{4}. \text{ Then } \int_{1/4}^{1/2} \frac{15}{4}\sqrt{x}(1-x) dx = \frac{7}{16}\sqrt{2} - \frac{17}{64} \approx 0.353$$

$$23. \int_0^{\infty} e^{-cx} dx = \frac{1}{c} \lim_{b \rightarrow \infty} (-e^{-bcx} + 1) = \frac{1}{c}. \text{ Thus multiplying } e^{-cx} \text{ by } c \text{ produces a probability density on } [0, \infty).$$

$$24. \text{Var}(X) = \int_{-\infty}^{\infty} (X - \mu)^2 f(X) dX \\ = \int_{-\infty}^{\infty} X^2 f(X) dX + \int_{-\infty}^{\infty} (-2X\mu) f(X) dX + \int_{-\infty}^{\infty} \mu^2 f(X) dX$$

$$\int_{-\infty}^{\infty} (-2X\mu) f(X) dX = -2\mu \int_{-\infty}^{\infty} X f(X) dX = -2\mu^2$$

$$\int_{-\infty}^{\infty} \mu^2 f(X) dX = \mu^2 \int_{-\infty}^{\infty} f(X) dX = \mu^2(1) = \mu^2$$

$$\text{Thus } \text{Var}(X) = \int_{-\infty}^{\infty} X^2 f(X) dX - \mu^2.$$

$$25. \text{mean} = \int_0^4 x\left(\frac{1}{8}x\right) dx = \frac{8}{3}$$

To find the median we need to solve $\int_0^c \frac{1}{8}x dx = \frac{1}{16}c^2 = \frac{1}{2}$ for c . Thus the median is $\sqrt{8}$.

$$26. \text{mean} = \int_0^3 x\left(\frac{1}{9}x^2\right) dx = \frac{9}{4}$$

To find the median we need to solve $\int_0^c \frac{1}{9}x^2 dx = \frac{1}{27}c^3 = \frac{1}{2}$ for c . Thus the median is $\frac{3}{2}2^{2/3} \approx 2.381$.

$$27. \text{mean} = \int_1^{\infty} x\left(\frac{2}{x^3}\right) dx = \lim_{b \rightarrow \infty} \left(-\frac{2}{x}\right) \Big|_1^b = 2$$

To find the median we need to solve $\int_1^c \frac{2}{x^3} dx = -\frac{1}{c^2} + 1 = \frac{1}{2}$ for c . Thus the median is $\sqrt{2}$.

$$28. \text{mean} = \int_1^e x\left(\frac{1}{x}\right) dx = e - 1 \approx 1.718$$

To find the median we need to solve $\int_1^c \frac{1}{x} dx = \ln c = \frac{1}{2}$ for c . Thus the median is $\sqrt{e} \approx 1.649$.

29. The exponential density with mean 1 is e^{-X} . The probability that the food is digested in less than 30 minutes is $\int_0^{1/2} e^{-X} dX = -e^{-1/2} + 1 \approx 0.3935$.
30. The exponential density with mean 4 is $(1/4)e^{-X/4}$. The probability that a flower is pollinated within 5 minutes is $\int_0^5 (1/4)e^{-X/4} dX = -e^{-5/4} + 1 \approx 0.7135$. Out of 1000 flowers we would expect 713 or 714 to be pollinated within 5 minutes.
31. The exponential density with mean 1200 is $(1/1200)e^{-X/1200}$.
- (a) The probability that a bulb will last less than 1000 hours is $\int_0^{1000} (1/1200)e^{-X/1200} dX = -e^{-5/6} + 1 \approx 0.5654$.
- (b) By Example 9 the median lifetime is $1200 \ln 2 \approx 831.8$ so the expected time until half the bulbs in a batch fail is 832 hr.
32. To find the density, solve $\int_0^3 (1/c)e^{-X/c} dX = -e^{-3/c} + 1 = \frac{1}{3}$. Then $c = \frac{3}{\ln(3/2)} \approx 7.3989$, so the mean lifetime of the components is 7.4 years. The probability of failure within 1 year is $\int_0^1 \frac{\ln(3/2)}{3} e^{-\frac{X \ln(3/2)}{3}} dX = -\left(\frac{2}{3}\right)^{1/3} + 1 \approx 0.1264$.
33. To find the density, solve $\int_0^2 (1/c)e^{-X/c} dX = -e^{-2/c} + 1 = \frac{2}{5}$; $c = \frac{2}{\ln(5/3)}$. The probability that a hydra dies within 6 months, or half a year, is $\int_0^{1/2} \frac{\ln(5/3)}{2} e^{-\frac{X \ln(5/3)}{2}} dX = -\left(\frac{3}{5}\right)^{1/4} + 1 \approx 0.1199$, so we would expect $(0.12)(500) = 60$ hydra to die within the first six months.
34. To find the density, solve $\int_0^{50} (1/c)e^{-X/c} dX = -e^{-50/c} + 1 = \frac{3}{10}$; $c = \frac{50}{\ln(10/7)}$. The probability that a high-risk driver is involved in an accident in the first 80 days is $\int_0^{80} \frac{\ln(10/7)}{50} e^{-\frac{X \ln(10/7)}{50}} dX = -\left(\frac{7}{10}\right)^{8/5} + 1 \approx 0.4349$, so we would expect 43 or 44 out of 100 high-risk drivers to be involved in an accident in the first 80 days.
35. Using seconds as the time unit, the density is $(1/30)e^{-X/30}$.
- (a) $\int_0^{15} (1/30)e^{-X/30} dX = -e^{-1/2} + 1 \approx 0.393$
- (b) $\int_{60}^{\infty} (1/30)e^{-X/30} dX = e^{-2} \approx 0.135$
- (c) In a continuous distribution the probability of a particular number is 0.
- (d) The probability that a single customer waits less than 3 minutes is $-e^{-6} + 1 \approx 0.997521$. The probability that at least one customer out of 200 waits longer than 3 minutes is $1 - (0.997521)^{200} \approx 0.391 < 0.5$, so the most likely outcome is that all 200 are served within 3 minutes.

36. For parts (a) and (b) the density is $(1/16)e^{-X/16}$. For parts (c) and (d) the density is $(1/32)e^{-X/32}$.

$$(a) \int_{10}^{30} (1/16)e^{-X/16} dX = -e^{-15/8} + e^{-5/8} \approx 0.382$$

$$(b) \int_{25}^{\infty} (1/16)e^{-X/16} dX = e^{-25/16} \approx 0.210$$

$$(c) \int_{35}^{50} (1/32)e^{-X/32} dX = -e^{-25/16} + e^{-35/32} \approx 0.125$$

$$(d) \int_0^{20} (1/32)e^{-X/32} dX = -e^{-5/8} + 1 \approx 0.465$$

37. The expected payout per printer is $200 \int_0^1 (1/2)e^{-X/2} dX + 100 \int_1^2 (1/2)e^{-X/2} dX \approx \102.56 . Thus the expected refund total for 100 machines is \$10,256.

38. To find the density, solve $\int_0^2 \frac{1}{c} e^{-X/c} dX = -e^{-2/c} + 1 = \frac{1}{2}$, which gives $c = \frac{2}{\ln(2)}$. The probability of failure in the first year is $\int_0^1 \frac{\ln 2}{2} e^{-\frac{X \ln 2}{2}} dX = -\frac{\sqrt{2}}{2} + 1 \approx 0.293$. We expect $(150)(0.293) = 43.934$ or about 44 copiers to fail during the first year.

For Exercises 39–52, the density function is $f(X) = \frac{1}{\sigma\sqrt{2\pi}} e^{-\frac{1}{2}\left(\frac{X-\mu}{\sigma}\right)^2}$ with μ and σ as given in the solution.

39. $\mu = 162$, $\sigma = 28$

$$\int_{165}^{193} f(X) dX \approx 0.323; \text{ about 323 children}$$

$$\int_{148}^{167} f(X) dX \approx 0.262; \text{ about 262 children}$$

40. $\mu = 20.11$, $\sigma = 4.7$

$$\int_{17}^{\infty} f(X) dX = \frac{1}{2} + \int_{17}^{\mu} f(X) dX \approx 0.74593$$

41. $\mu = 55$, $\sigma = 4$

$$\int_0^{60} f(X) dX \approx 0.89435$$

42. $\mu = 22,000$, $\sigma = 4000$

$$(a) \int_{18,000}^{\infty} f(X) dX = \frac{1}{2} + \int_{18,000}^{\mu} f(X) dX \approx 0.84134; (4000)(0.84134) \approx 3365 \text{ tires}$$

(b) We want to find L such that $\int_L^{\infty} f(X) dX = 0.9$. A CAS gives $L \approx 16,874$, so 90% of tires will have a lifetime of at least 16,874 miles.

43. $\mu = 65.5$, $\sigma = 2.5$

$$(a) \int_{68}^{\infty} f(X) dX = \frac{1}{2} - \int_{\mu}^{68} f(X) dX \approx 0.159, \text{ or } 16\%.$$

$$(b) \int_{61}^{64} f(X) dX \approx 0.23832$$

44. $\mu = 81, \sigma = 7$

$\int_{75}^{85} f(X) dX \approx 0.520$; one would expect 52 of the babies to live to between 75 and 85.

45. $\mu = 266, \sigma = 16$; $(36)(7) = 252, (40)(7) = 280$

$\int_{252}^{280} f(X) dX \approx 0.6184$; we would expect 618 of the women to have pregnancies lasting between 36 and 40 weeks.

46. $\mu = 1400, \sigma = 100$

(a) $\int_{1325}^{1450} f(X) dX \approx 0.46484$

(b) $\int_{1480}^{\infty} f(X) dX = \frac{1}{2} - \int_{\mu}^{1480} f(X) dX \approx 0.21186$

$(500)(0.21186) \approx 106$; we would expect about 106 males to have a brain weight exceeding 1480 gm.

47. $\mu = 80, \sigma = 12$

$\int_0^{70} f(X) dX \approx 0.20233$

$(300)(0.20233) \approx 61$; about 61 adults.

48. $\mu = 4.4, \sigma = 0.2$

$\int_{4.3}^{4.45} f(X) dX \approx 0.29017$

49. $\mu = 35, \sigma = 9$

$\int_{40}^{\infty} f(X) dX = \frac{1}{2} - \int_{\mu}^{40} f(X) dX \approx 0.28926$

About 289 shafts would need more than 45 grams of added weight.

50. $\mu = 200, \sigma = 30$

$\int_{260}^{\infty} f(X) dX = \frac{1}{2} - \int_{\mu}^{260} f(X) dX \approx 0.02275$

$\int_0^{170} f(X) dX \approx 0.15866$

$0.02275 + 0.15866 = 0.18141$ or about 18%

51. $\mu = (0.8)(2500) = 2000, \sigma = (0.4)(50) = 20$

(a) $\int_{1960}^{\infty} f(X) dX = \frac{1}{2} + \int_{1960}^{\mu} f(X) dX \approx 0.977$

(b) $\int_0^{1980} f(X) dX \approx 0.159$

(c) $\int_{1940}^{2020} f(X) dX \approx 0.840$

52. $\mu = (0.5)(400) = 200, \sigma = \frac{20}{2} = 10$

To improve the approximation to the binomial distribution we will modify the interval of integration. We give the true binomial values for comparison.

(a) $\int_{189.5}^{209.5} f(X) dX \approx 0.68208$; correct to 5 places

(b) $\int_0^{169.5} f(X) dX \approx 0.00114$; true value ≈ 0.00112

(c) $\int_{220.5}^{\infty} f(X) dX = \frac{1}{2} - \int_{\mu}^{220.5} f(X) dX \approx 0.02018$; true value ≈ 0.02012

(d) The value is very close to 0, in fact about 10^{-24} .

53. (a) and (b)

Outcome	X
HHHH	0
THHH	1
HTHH	1
HHTH	1
HHHT	1
TTHH	2
THTH	2
THHT	2
HTTH	2
HTHT	2
HHTT	2
TTTH	3
TTHT	3
THTT	3
HTTT	3
TTTT	4

(c)

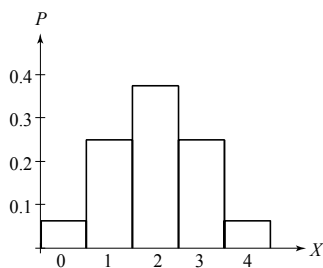

The probability of at least 2 heads is $\frac{1}{16}(1 + 4 + 6) = \frac{11}{16}$.

54. (a) The first die is listed first in each pair, the second die second.

$1 + 1 = 2$	$2 + 1 = 3$	$3 + 1 = 4$	$4 + 1 = 5$	$5 + 1 = 6$	$6 + 1 = 7$
$1 + 2 = 3$	$2 + 2 = 4$	$3 + 2 = 5$	$4 + 2 = 6$	$5 + 2 = 7$	$6 + 2 = 8$
$1 + 3 = 4$	$2 + 3 = 5$	$3 + 3 = 6$	$4 + 3 = 7$	$5 + 3 = 8$	$6 + 3 = 9$
$1 + 4 = 5$	$2 + 4 = 6$	$3 + 4 = 7$	$4 + 4 = 8$	$5 + 4 = 9$	$6 + 4 = 10$
$1 + 5 = 6$	$2 + 5 = 7$	$3 + 5 = 8$	$4 + 5 = 9$	$5 + 5 = 10$	$6 + 5 = 11$
$1 + 6 = 7$	$2 + 6 = 8$	$3 + 6 = 9$	$4 + 6 = 10$	$5 + 6 = 11$	$6 + 6 = 12$

(b)

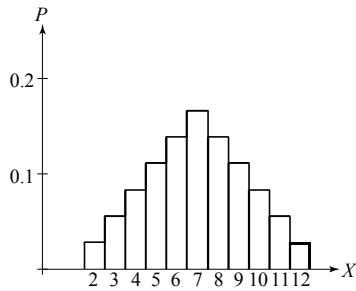

(c) $P(8) = \frac{5}{36}$

(d) $P(X \leq 5) = \frac{1+2+3+4}{36} = \frac{5}{18}$

$$P(X > 9) = \frac{3+2+1}{36} = \frac{1}{6}$$

55. (a) {LLL, LLD, LDL, DLL, LLU, LUL, ULL, LDD, DLD, DDL, LUU, ULU, UUL, DDU, DUD, UDD, DUU, UDU, UUD, LUD, LDU, ULD, UDL, DLU, DUL, DDD, UUU}

(b) We will assume that the three answers are equally likely, though other assumptions might be reasonable. The plots for the X = number of Ls, the number of Us and the number of Ds are identical.

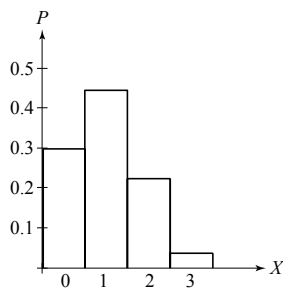

(c) $P(\text{at least two L}) = \frac{1+3+3}{27} = \frac{7}{27} \approx 0.26$

(d) $P(\text{no more than one D}) = 1 - P(\text{at least two D})$
 $= 1 - \frac{7}{27} = \frac{20}{27} \approx 0.74$

56. The probability that both systems fail is 0.0148. Since the two systems have the same performance distribution, the failure probability for a single system is $\sqrt{0.0148} = 0.121655$. The success probability for a single system is $1 - \sqrt{0.0148}$ so the probability that both succeed is $(1 - \sqrt{0.0148})^2 = 0.771489$. The probability that one fails and one succeeds is $1 - 0.0148 - 0.771489 = 0.213711$. Since the events “main fails, backup succeeds” and “main succeeds, backup fails” have the same probability, the probability that only the main fails is $0.213711 / 2 = 0.106856$. Thus the probability that the main fails, either along with the backup or by itself, is $0.0148 + 0.106856 = 0.121656$.

CHAPTER 8 PRACTICE EXERCISES

1. $u = \ln(x+1), du = \frac{dx}{x+1}; dv = dx, v = x;$

$$\int \ln(x+1) dx = x \ln(x+1) - \int \frac{x}{x+1} dx = x \ln(x+1) - \int dx + \int \frac{dx}{x+1} = x \ln(x+1) - x + \ln(x+1) + C_1$$

$$= (x+1) \ln(x+1) - x + C_1 = (x+1) \ln(x+1) - (x+1) + C, \text{ where } C = C_1 + 1$$

2. $u = \ln x, du = \frac{dx}{x}; dv = x^2 dx, v = \frac{1}{3}x^3;$

$$\int x^2 \ln x dx = \frac{1}{3}x^3 \ln x - \int \frac{1}{3}x^3 \left(\frac{1}{x}\right) dx = \frac{x^3}{3} \ln x - \frac{x^3}{9} + C$$

3. $u = \tan^{-1} 3x, du = \frac{3 dx}{1+9x^2}; dv = dx, v = x;$

$$\int \tan^{-1} 3x dx = x \tan^{-1} 3x - \int \frac{3x dx}{1+9x^2}; \left[\begin{array}{l} y = 1+9x^2 \\ dy = 18x dx \end{array} \right] \rightarrow x \tan^{-1} 3x - \frac{1}{6} \int \frac{dy}{y} = x \tan^{-1} (3x) - \frac{1}{6} \ln (1+9x^2) + C$$

4. $u = \cos^{-1} \left(\frac{x}{2}\right), du = \frac{-dx}{\sqrt{4-x^2}}; dv = dx, v = x;$

$$\int \cos^{-1} \left(\frac{x}{2}\right) dx = x \cos^{-1} \left(\frac{x}{2}\right) + \int \frac{x dx}{\sqrt{4-x^2}}; \left[\begin{array}{l} y = 4-x^2 \\ dy = -2x dx \end{array} \right] \rightarrow x \cos^{-1} \left(\frac{x}{2}\right) - \frac{1}{2} \int \frac{dy}{\sqrt{y}} = x \cos^{-1} \left(\frac{x}{2}\right) - \sqrt{4-x^2} + C$$

$$= x \cos^{-1} \left(\frac{x}{2}\right) - 2\sqrt{1-\left(\frac{x}{2}\right)^2} + C$$

5. e^x

$$(x+1)^2 \xrightarrow{(+)} e^x$$

$$2(x+1) \xrightarrow{(-)} e^x$$

$$2 \xrightarrow{(+)} e^x$$

$$0 \Rightarrow \int (x+1)^2 e^x dx = \left[(x+1)^2 - 2(x+1) + 2 \right] e^x + C$$

6. $\sin(1-x)$

$$x^2 \xrightarrow{(+)} \cos(1-x)$$

$$2x \xrightarrow{(-)} -\sin(1-x)$$

$$2 \xrightarrow{(+)} -\cos(1-x)$$

$$0 \Rightarrow \int x^2 \sin(1-x) dx = x^2 \cos(1-x) + 2x \sin(1-x) - 2 \cos(1-x) + C$$

7. $u = \cos 2x, du = -2 \sin 2x dx; dv = e^x dx, v = e^x;$

$$I = \int e^x \cos 2x dx = e^x \cos 2x + 2 \int e^x \sin 2x dx;$$

$$u = \sin 2x, du = 2 \cos 2x dx; dv = e^x dx, v = e^x;$$

$$I = e^x \cos 2x + 2 \left[e^x \sin 2x - 2 \int e^x \cos 2x dx \right] = e^x \cos 2x + 2e^x \sin 2x - 4I \Rightarrow I = \frac{e^x \cos 2x}{5} + \frac{2e^x \sin 2x}{5} + C$$

8. $\int x \sin x \cos x dx$

$$u = x, du = dx, dv = \sin x \cos x dx, v = \frac{1}{2} \sin^2 x$$

$$u = \cos 3x, du = -3 \sin 3x dx; dv = e^{-2x} dx, v = -\frac{1}{2} e^{-2x};$$

$$\int x \sin x \cos x dx = uv - \int v du = \frac{x}{2} \sin^2 x - \frac{1}{2} \int \sin^2 x dx$$

$$= \frac{x}{2} \sin^2 x - \frac{1}{4} \int (1 - \cos 2x) dx$$

$$= \frac{x}{2} \sin^2 x - \frac{1}{4} x + \frac{1}{8} \sin 2x + C$$

9. $\int \frac{x dx}{x^2 - 3x + 2} = \int \frac{2 dx}{x-2} - \int \frac{dx}{x-1} = 2 \ln |x-2| - \ln |x-1| + C$

10. $\int \frac{x dx}{x^2 + 4x + 3} = \frac{3}{2} \int \frac{dx}{x+3} - \frac{1}{2} \int \frac{dx}{x+1} = \frac{3}{2} \ln |x+3| - \frac{1}{2} \ln |x+1| + C$

11. $\int \frac{dx}{x(x+1)^2} = \int \left(\frac{1}{x} - \frac{1}{x+1} + \frac{-1}{(x+1)^2} \right) dx = \ln |x| - \ln |x+1| + \frac{1}{x+1} + C$

12. $\int \frac{x+1}{x^2(x-1)} dx = \int \left(\frac{2}{x-1} - \frac{2}{x} - \frac{1}{x^2} \right) dx = 2 \ln \left| \frac{x-1}{x} \right| + \frac{1}{x} + C = -2 \ln |x| + \frac{1}{x} + 2 \ln |x-1| + C$

13. $\int \frac{\sin \theta d\theta}{\cos^2 \theta + \cos \theta - 2}; [\cos \theta = y] \rightarrow -\int \frac{dy}{y^2 + y - 2} = -\frac{1}{3} \int \frac{dy}{y-1} + \frac{1}{3} \int \frac{dy}{y+2} = \frac{1}{3} \ln \left| \frac{y+2}{y-1} \right| + C = \frac{1}{3} \ln \left| \frac{\cos \theta + 2}{\cos \theta - 1} \right| + C$
 $= -\frac{1}{3} \ln \left| \frac{\cos \theta - 1}{\cos \theta + 2} \right| + C$

14. $\int \frac{\cos \theta d\theta}{\sin^2 \theta + \sin \theta - 6}; [\sin \theta = x] \rightarrow \int \frac{dx}{x^2 + x - 6} = \frac{1}{5} \int \frac{dx}{x-2} - \frac{1}{5} \int \frac{dx}{x+3} = \frac{1}{5} \ln \left| \frac{\sin \theta - 2}{\sin \theta + 3} \right| + C$

15. $\int \frac{3x^2 + 4x + 4}{x^3 + x} dx = \int \frac{4}{x} dx - \int \frac{x-4}{x^2+1} dx = 4 \ln |x| - \frac{1}{2} \ln (x^2 + 1) + 4 \tan^{-1} x + C$

16. $\int \frac{4x dx}{x^3 + 4x} = \int \frac{4 dx}{x^2 + 4} = 2 \tan^{-1} \left(\frac{x}{2} \right) + C$

17. $\int \frac{(v+3)dv}{2v^3 - 8v} = \frac{1}{2} \int \left(-\frac{3}{4v} + \frac{5}{8(v-2)} + \frac{1}{8(v+2)} \right) dv = -\frac{3}{8} \ln |v| + \frac{5}{16} \ln |v-2| + \frac{1}{16} \ln |v+2| + C = \frac{1}{16} \ln \left| \frac{(v-2)^5 (v+2)}{v} \right| + C$

$$18. \int \frac{(3v-7) dv}{(v-1)(v-2)(v-3)} = \int \frac{(-2)dv}{v-1} + \int \frac{dv}{v-2} + \int \frac{dv}{v-3} = \ln \left| \frac{(v-2)(v-3)}{(v-1)^2} \right| + C$$

$$19. \int \frac{dt}{t^4+4t^2+3} = \frac{1}{2} \int \frac{dt}{t^2+1} - \frac{1}{2} \int \frac{dt}{t^2+3} = \frac{1}{2} \tan^{-1} t - \frac{1}{2\sqrt{3}} \tan^{-1} \left(\frac{t}{\sqrt{3}} \right) + C = \frac{1}{2} \tan^{-1} t - \frac{\sqrt{3}}{6} \tan^{-1} \frac{t}{\sqrt{3}} + C$$

$$20. \int \frac{t dt}{t^4-t^2-2} = \frac{1}{3} \int \frac{t dt}{t^2-2} - \frac{1}{3} \int \frac{t dt}{t^2+1} = \frac{1}{6} \ln |t^2-2| - \frac{1}{6} \ln (t^2+1) + C$$

$$21. \int \frac{x^3+x^2}{x^2+x-2} dx = \int \left(x + \frac{2x}{x^2+x-2} \right) dx = \int x dx + \frac{2}{3} \int \frac{dx}{x-1} + \frac{4}{3} \int \frac{dx}{x+2} = \frac{x^2}{2} + \frac{4}{3} \ln |x+2| + \frac{2}{3} \ln |x-1| + C$$

$$22. \int \frac{x^3+1}{x^3-x} dx = \int \left(1 + \frac{x+1}{x^3-x} \right) dx = \int \left[1 + \frac{1}{x(x-1)} \right] dx = \int dx + \int \frac{dx}{x-1} - \int \frac{dx}{x} = x + \ln |x-1| - \ln |x| + C$$

$$23. \int \frac{x^3+4x^2}{x^2+4x+3} dx = \int \left(x - \frac{3x}{x^2+4x+3} \right) dx = \int x dx + \frac{3}{2} \int \frac{dx}{x+1} - \frac{9}{2} \int \frac{dx}{x+3} = \frac{x^2}{2} - \frac{9}{2} \ln |x+3| + \frac{3}{2} \ln |x+1| + C$$

$$24. \int \frac{2x^3+x^2-21x+24}{x^2+2x-8} dx = \int \left[(2x-3) + \frac{x}{x^2+2x-8} \right] dx = \int (2x-3) dx + \frac{1}{3} \int \frac{dx}{x-2} + \frac{2}{3} \int \frac{dx}{x+4} \\ = x^2 - 3x + \frac{2}{3} \ln |x+4| + \frac{1}{3} \ln |x-2| + C$$

$$25. \int \frac{dx}{x(3\sqrt{x+1})}; \begin{cases} u = \sqrt{x+1} \\ du = \frac{dx}{2\sqrt{x+1}} \\ dx = 2u du \end{cases} \rightarrow \frac{2}{3} \int \frac{u du}{(u^2-1)u} = \frac{1}{3} \int \frac{du}{u-1} - \frac{1}{3} \int \frac{du}{u+1} = \frac{1}{3} \ln |u-1| - \frac{1}{3} \ln |u+1| + C = \frac{1}{3} \ln \left| \frac{\sqrt{x+1}-1}{\sqrt{x+1}+1} \right| + C$$

$$26. \int \frac{dx}{x(1+\sqrt[3]{x})}; \begin{cases} u = \sqrt[3]{x} \\ du = \frac{dx}{3x^{2/3}} \\ dx = 3u^2 du \end{cases} \rightarrow \int \frac{3u^2 du}{u^3(1+u)} = 3 \int \frac{du}{u(1+u)} = 3 \ln \left| \frac{u}{u+1} \right| + C = 3 \ln \left| \frac{\sqrt[3]{x}}{1+\sqrt[3]{x}} \right| + C$$

$$27. \int \frac{ds}{e^s-1}; \begin{cases} u = e^s - 1 \\ du = e^s ds \\ ds = \frac{du}{u+1} \end{cases} \rightarrow \int \frac{du}{u(u+1)} = -\int \frac{du}{u+1} + \int \frac{du}{u} = \ln \left| \frac{u}{u+1} \right| + C = \ln \left| \frac{e^s-1}{e^s} \right| + C = \ln |1 - e^{-s}| + C$$

$$28. \int \frac{ds}{\sqrt{e^s+1}}; \begin{cases} u = \sqrt{e^s+1} \\ du = \frac{e^s ds}{2\sqrt{e^s+1}} \\ ds = \frac{2u du}{u^2-1} \end{cases} \rightarrow \int \frac{2u du}{u(u^2-1)} = 2 \int \frac{du}{(u+1)(u-1)} = \int \frac{du}{u-1} - \int \frac{du}{u+1} = \ln \left| \frac{u-1}{u+1} \right| + C = \ln \left| \frac{\sqrt{e^s+1}-1}{\sqrt{e^s+1}+1} \right| + C$$

$$29. (a) \int \frac{y dy}{\sqrt{16-y^2}} = -\frac{1}{2} \int \frac{-2y dy}{\sqrt{16-y^2}} = -\sqrt{16-y^2} + C$$

$$(b) \int \frac{y dy}{\sqrt{16-y^2}}; [y = 4 \sin x] \rightarrow 4 \int \frac{\sin x \cos x dx}{\cos x} = -4 \cos x + C = -\frac{4\sqrt{16-y^2}}{4} + C = -\sqrt{16-y^2} + C$$

$$30. (a) \int \frac{x dx}{\sqrt{4+x^2}} = \frac{1}{2} \int \frac{2x dx}{\sqrt{4+x^2}} = \sqrt{4+x^2} + C$$

$$(b) \int \frac{x dx}{\sqrt{4+x^2}}; [x = 2 \tan y] \rightarrow \int \frac{2 \tan y \cdot 2 \sec^2 y dy}{2 \sec y} = 2 \int \sec y \tan y dy = 2 \sec y + C = \sqrt{4+x^2} + C$$

$$31. (a) \int \frac{x dx}{4-x^2} = -\frac{1}{2} \int \frac{(-2x) dx}{4-x^2} = -\frac{1}{2} \ln |4-x^2| + C$$

$$(b) \int \frac{x dx}{4-x^2}; [x = 2 \sin \theta] \rightarrow \int \frac{2 \sin \theta \cdot 2 \cos \theta d\theta}{4 \cos^2 \theta} = \int \tan \theta d\theta = -\ln |\cos \theta| + C = -\ln \left(\frac{\sqrt{4-x^2}}{2} \right) + C \\ = -\frac{1}{2} \ln |4-x^2| + C$$

$$32. (a) \int \frac{t dt}{\sqrt{4t^2-1}} = \frac{1}{8} \int \frac{8t dt}{\sqrt{4t^2-1}} = \frac{1}{4} \sqrt{4t^2-1} + C$$

$$(b) \int \frac{t dt}{\sqrt{4t^2-1}}; [t = \frac{1}{2} \sec \theta] \rightarrow \int \frac{\frac{1}{2} \sec \theta \tan \theta \cdot \frac{1}{2} \sec \theta d\theta}{\tan \theta} = \frac{1}{4} \int \sec^2 \theta d\theta = \frac{\tan \theta}{4} + C = \frac{\sqrt{4t^2-1}}{4} + C$$

$$33. \int \frac{x dx}{9-x^2}; \left[\begin{array}{l} u = 9-x^2 \\ du = -2x dx \end{array} \right] \rightarrow -\frac{1}{2} \int \frac{du}{u} = -\frac{1}{2} \ln |u| + C = \ln \frac{1}{\sqrt{u}} + C = \ln \frac{1}{\sqrt{9-x^2}} + C$$

$$34. \int \frac{dx}{x(9-x^2)} = \frac{1}{9} \int \frac{dx}{x} + \frac{1}{18} \int \frac{dx}{3-x} - \frac{1}{18} \int \frac{dx}{3+x} = \frac{1}{9} \ln |x| - \frac{1}{18} \ln |3-x| - \frac{1}{18} \ln |3+x| + C = \frac{1}{9} \ln |x| - \frac{1}{18} \ln |9-x^2| + C$$

$$35. \int \frac{dx}{9-x^2} = \frac{1}{6} \int \frac{dx}{3-x} + \frac{1}{6} \int \frac{dx}{3+x} = -\frac{1}{6} \ln |3-x| + \frac{1}{6} \ln |3+x| + C = \frac{1}{6} \ln \left| \frac{x+3}{x-3} \right| + C$$

$$36. \int \frac{dx}{\sqrt{9-x^2}}; \left[\begin{array}{l} x = \sin \theta \\ dx = \cos \theta d\theta \end{array} \right] \rightarrow \int \frac{\cos \theta d\theta}{\sqrt{9-\sin^2 \theta}} = \int \frac{\cos \theta d\theta}{3 \cos \theta} = \int d\theta = \theta + C = \sin^{-1} \frac{x}{3} + C$$

$$37. \int \sin^3 x \cos^4 x dx = \int \cos^4 x (1-\cos^2 x) \sin x dx = \int \cos^4 x \sin x dx - \int \cos^6 x \sin x dx = -\frac{\cos^5 x}{5} + \frac{\cos^7 x}{7} + C$$

$$38. \int \cos^5 x \sin^5 x dx = \int \sin^5 x \cos^4 x \cos x dx = \int \sin^5 x (1-\sin^2 x)^2 \cos x dx \\ = \int \sin^5 x \cos x dx - 2 \int \sin^7 x \cos x dx + \int \sin^9 x \cos x dx = \frac{\sin^6 x}{6} - \frac{2 \sin^8 x}{8} + \frac{\sin^{10} x}{10} + C$$

$$39. \int \tan^4 x \sec^2 x dx = \frac{\tan^5 x}{5} + C$$

$$40. \int \tan^3 x \sec^3 x dx = \int (\sec^2 x - 1) \sec^2 x \cdot \sec x \cdot \tan x dx = \int \sec^4 x \cdot \sec x \cdot \tan x dx - \int \sec^2 x \cdot \sec x \cdot \tan x dx \\ = \frac{\sec^5 x}{5} - \frac{\sec^3 x}{3} + C$$

$$41. \int \sin 5\theta \cos 6\theta d\theta = \frac{1}{2} \int (\sin(-\theta) + \sin(11\theta)) d\theta = \frac{1}{2} \int \sin(-\theta) d\theta + \frac{1}{2} \int \sin(11\theta) d\theta = \frac{1}{2} \cos(-\theta) - \frac{1}{22} \cos 11\theta + C \\ = \frac{1}{2} \cos \theta - \frac{1}{22} \cos 11\theta + C$$

42. $\int \sec^2 \theta \sin^3 \theta d\theta = \int \frac{\sin \theta (1 - \cos^2 \theta)}{\cos^2 \theta} = \int \frac{\sin \theta}{\cos^2 \theta} d\theta - \int \sin \theta d\theta = \cos^{-1} \theta - (-\cos \theta) + C = \sec \theta + \cos \theta + C$

43. $\int \sqrt{1 + \cos\left(\frac{t}{2}\right)} dt = \int \sqrt{2} \left| \cos \frac{t}{4} \right| dt = 4\sqrt{2} \left| \sin \frac{t}{4} \right| + C$

44. $\int e^t \sqrt{\tan^2 e^t + 1} dt = \int \left| \sec e^t \right| e^t dt = \ln \left| \sec e^t + \tan e^t \right| + C$

45. $|E_S| \leq \frac{3-1}{180} (\Delta x)^4 M$ where $\Delta x = \frac{3-1}{n} = \frac{2}{n}$; $f(x) = \frac{1}{x} = x^{-1} \Rightarrow f'(x) = -x^{-2} \Rightarrow f''(x) = 2x^{-3} \Rightarrow f'''(x) = -6x^{-4} \Rightarrow f^{(4)}(x) = 24x^{-5}$ which is decreasing on $[1, 3] \Rightarrow$ maximum of $f^{(4)}(x)$ on $[1, 3]$ is $f^{(4)}(1) = 24 \Rightarrow M = 24$. Then $|E_S| \leq 0.0001 \Rightarrow \left(\frac{3-1}{180}\right) \left(\frac{2}{n}\right)^4 (24) \leq 0.0001 \Rightarrow \left(\frac{768}{180}\right) \left(\frac{1}{n^4}\right) \leq 0.0001 \Rightarrow \frac{1}{n^4} \leq (0.0001) \left(\frac{180}{768}\right) \Rightarrow n^4 \geq 10,000 \left(\frac{768}{180}\right) \Rightarrow n \geq 14.37 \Rightarrow n \geq 16$ (n must be even)

46. $|E_T| \leq \frac{1-0}{12} (\Delta x)^2 M$ where $\Delta x = \frac{1-0}{n} = \frac{1}{n}$; $0 \leq f''(x) \leq 8 \Rightarrow M = 8$. Then $|E_T| \leq 10^{-3} \Rightarrow \frac{1}{12} \left(\frac{1}{n}\right)^2 (8) \leq 10^{-3} \Rightarrow \frac{2}{3n^2} \leq 10^{-3} \Rightarrow \frac{3n^2}{2} \geq 1000 \Rightarrow n^2 \geq \frac{2000}{3} \Rightarrow n \geq 25.82 \Rightarrow n \geq 26$

47. $\Delta x = \frac{b-a}{n} = \frac{\pi-0}{6} = \frac{\pi}{6} \Rightarrow \frac{\Delta x}{2} = \frac{\pi}{12}$;
 $\sum_{i=0}^6 mf(x_i) = 12 \Rightarrow T = \left(\frac{\pi}{12}\right)(12) = \pi$;

	x_i	$f(x_i)$	m	$mf(x_i)$
x_0	0	0	1	0
x_1	$\pi/6$	1/2	2	1
x_2	$\pi/3$	3/2	2	3
x_3	$\pi/2$	2	2	4
x_4	$2\pi/3$	3/2	2	3
x_5	$5\pi/6$	1/2	2	1
x_6	π	0	1	0

$\sum_{i=0}^6 mf(x_i) = 18$ and $\frac{\Delta x}{3} = \frac{\pi}{18}$
 $\Rightarrow S = \left(\frac{\pi}{18}\right)(18) = \pi$.

	x_i	$f(x_i)$	m	$mf(x_i)$
x_0	0	0	1	0
x_1	$\pi/6$	1/2	4	2
x_2	$\pi/3$	3/2	2	3
x_3	$\pi/2$	2	4	8
x_4	$2\pi/3$	3/2	2	3
x_5	$5\pi/6$	1/2	4	2
x_6	π	0	1	0

$$48. |f^{(4)}(x)| \leq 3 \Rightarrow M = 3; \Delta x = \frac{2-1}{n} = \frac{1}{n}. \text{ Hence } |E_s| \leq 10^{-5} \Rightarrow \left(\frac{2-1}{180}\right)\left(\frac{1}{n}\right)^4 (3) \leq 10^{-5} \Rightarrow \frac{1}{60n^4} \leq 10^{-5} \Rightarrow n^4 \geq \frac{10^5}{60} \\ \Rightarrow n \geq 6.38 \Rightarrow n \geq 8 \text{ (} n \text{ must be even)}$$

$$49. y_{av} = \frac{1}{365-0} \int_0^{365} \left[37 \sin\left(\frac{2\pi}{365}(x-101)\right) + 25 \right] dx = \frac{1}{365} \left[-37 \left(\frac{365}{2\pi} \cos\left(\frac{2\pi}{365}(x-101)\right) + 25x \right) \right]_0^{365} \\ = \frac{1}{365} \left[\left(-37 \left(\frac{365}{2\pi} \cos\left[\frac{2\pi}{365}(365-101)\right] + 25(365) \right) - \left(-37 \left(\frac{365}{2\pi} \cos\left[\frac{2\pi}{365}(0-101)\right] + 25(0) \right) \right) \right] \\ = -\frac{37}{2\pi} \cos\left(\frac{2\pi}{365}(264)\right) + 25 + \frac{37}{2\pi} \cos\left(\frac{2\pi}{365}(-101)\right) = -\frac{37}{2\pi} \left(\cos\left(\frac{2\pi}{365}(264)\right) - \cos\left(\frac{2\pi}{365}(-101)\right) \right) + 25 \\ \approx -\frac{37}{2\pi} (0.16705 - 0.16705) + 25 = 25^\circ F$$

$$50. av(C_v) = \frac{1}{675-20} \int_{20}^{675} \left[8.27 + 10^{-5} (26T - 1.87T^2) \right] dT = \frac{1}{655} \left[8.27T + \frac{13}{10^5} T^2 - \frac{0.62333}{10^5} T^3 \right]_{20}^{675} \\ \approx \frac{1}{655} [(5582.25 + 59.23125 - 1917.03194) - (165.4 + 0.052 - 0.04987)] \approx 5.434; \\ 8.27 + 10^{-5} (26T - 1.87T^2) = 5.434 \Rightarrow 1.87T^2 - 26T - 283,600 = 0 \Rightarrow T \approx \frac{26 + \sqrt{676 + 4(1.87)(283,600)}}{2(1.87)} \approx 396.45^\circ C$$

$$51. \text{ (a) Each interval is } 5 \text{ min} = \frac{1}{12} \text{ hour. } \frac{1}{24} [2.5 + 2(2.4) + 2(2.3) + \dots + 2(2.4) + 2.3] = \frac{29}{12} \approx 2.42 \text{ gal} \\ \text{ (b) (60 mph) } \left(\frac{12}{29} \text{ hours/gal} \right) \approx 24.83 \text{ mi/gal}$$

$$52. \text{ Using the Simpson's rule, } \Delta x = 15 \Rightarrow \frac{\Delta x}{3} = 5; \\ \sum mf(x_i) = 1211.8 \Rightarrow \text{Area} \approx (1211.8)(5) = 6059 \text{ ft}^2; \\ \text{The cost is } \text{Area} \cdot (\$2.10/\text{ft}^2) \approx (6059 \text{ ft}^2)(\$2.10/\text{ft}^2) \\ = \$12,723.90 \Rightarrow \text{the job cannot be done for } \$11,000.$$

	x_i	$f(x_i)$	m	$mf(x_i)$
	x_0	0	1	0
	x_1	15	4	144
	x_2	30	2	108
	x_3	45	4	204
	x_4	60	2	99
	x_5	75	4	216
	x_6	90	2	128.8
	x_7	105	4	270
	x_8	120	1	42

$$53. \int_0^3 \frac{dx}{\sqrt{9-x^2}} = \lim_{b \rightarrow 3^-} \int_0^b \frac{dx}{\sqrt{9-x^2}} = \lim_{b \rightarrow 3^-} \left[\sin^{-1}\left(\frac{x}{3}\right) \right]_0^b = \lim_{b \rightarrow 3^-} \left[\sin^{-1}\left(\frac{b}{3}\right) - \sin^{-1}\left(\frac{0}{3}\right) \right] = \frac{\pi}{2} - 0 = \frac{\pi}{2}$$

$$54. \int_0^1 \ln x \, dx = \lim_{b \rightarrow 0^+} [x \ln x - x]_b^1 = \lim_{b \rightarrow 0^+} [(1 \cdot \ln 1 - 1) - (b \ln b - b)] = -1 - \lim_{b \rightarrow 0^+} \frac{\ln b}{\left(\frac{1}{b}\right)} = -1 - \lim_{b \rightarrow 0^+} \left(\frac{\frac{1}{b}}{\left(-\frac{1}{b^2}\right)} \right) = -1 + 0 = -1$$

$$55. \int_{-1}^1 \frac{dy}{y^{2/3}} = \int_{-1}^0 \frac{dy}{y^{2/3}} + \int_0^1 \frac{dy}{y^{2/3}} = 2 \int_0^1 \frac{dy}{y^{2/3}} = 2 \cdot 3 \lim_{b \rightarrow 0^+} \left[y^{1/3} \right]_b^1 = 6 \lim_{b \rightarrow 0^+} [1 - b^{1/3}] = 6$$

56. $\int_{-2}^{\infty} \frac{d\theta}{(\theta+1)^{3/5}} = \int_{-2}^{-1} \frac{d\theta}{(\theta+1)^{3/5}} + \int_{-1}^2 \frac{d\theta}{(\theta+1)^{3/5}} + \int_2^{\infty} \frac{d\theta}{(\theta+1)^{3/5}}$ converges if each integral converges, but $\lim_{\theta \rightarrow \infty} \frac{\theta^{3/5}}{(\theta+1)^{3/5}} = 1$
 and $\int_2^{\infty} \frac{d\theta}{\theta^{3/5}}$ diverges $\Rightarrow \int_{-2}^{\infty} \frac{d\theta}{(\theta+1)^{3/5}}$ diverges

57. $\int_3^{\infty} \frac{2 du}{u^2-2u} = \int_3^{\infty} \frac{du}{u-2} - \int_3^{\infty} \frac{du}{u} = \lim_{b \rightarrow \infty} \left[\ln \left| \frac{u-2}{u} \right| \right]_3^b = \lim_{b \rightarrow \infty} \left[\ln \left| \frac{b-2}{b} \right| - \ln \left| \frac{3-2}{3} \right| \right] = 0 - \ln \left(\frac{1}{3} \right) = \ln 3$

58. $\int_1^{\infty} \frac{3v-1}{4v^3-v^2} dv = \int_1^{\infty} \left(\frac{1}{v} + \frac{1}{v^2} - \frac{4}{4v-1} \right) dv = \lim_{b \rightarrow \infty} \left[\ln v - \frac{1}{v} - \ln(4v-1) \right]_1^b = \lim_{b \rightarrow \infty} \left[\ln \left(\frac{b}{4b-1} \right) - \frac{1}{b} - (\ln 1 - 1 - \ln 3) \right]$
 $= \ln \frac{1}{4} + 1 + \ln 3 = 1 + \ln \frac{3}{4}$

59. $\int_0^{\infty} x^2 e^{-x} dx = \lim_{b \rightarrow \infty} \left[-x^2 e^{-x} - 2x e^{-x} - 2e^{-x} \right]_0^b = \lim_{b \rightarrow \infty} \left[\left(-b^2 e^{-b} - 2b e^{-b} - 2e^{-b} \right) - (-2) \right] = 0 + 2 = 2$

60. $\int_{-\infty}^0 x e^{3x} dx = \lim_{b \rightarrow -\infty} \left[\frac{x}{3} e^{3x} - \frac{1}{9} e^{3x} \right]_b^0 = \lim_{b \rightarrow -\infty} \left[-\frac{1}{9} - \left(\frac{b}{3} e^{3b} - \frac{1}{9} e^{3b} \right) \right] = -\frac{1}{9} - 0 = -\frac{1}{9}$

61. $\int_{-\infty}^{\infty} \frac{dx}{4x^2+9} = 2 \int_0^{\infty} \frac{dx}{4x^2+9} = \frac{1}{2} \int_0^{\infty} \frac{dx}{x^2+\frac{9}{4}} = \frac{1}{2} \lim_{b \rightarrow \infty} \left[\frac{2}{3} \tan^{-1} \left(\frac{2x}{3} \right) \right]_0^b = \frac{1}{2} \lim_{b \rightarrow \infty} \left[\frac{2}{3} \tan^{-1} \left(\frac{2b}{3} \right) - \frac{2}{3} \tan^{-1}(0) \right]$
 $= \frac{1}{2} \left[\left(\frac{2}{3} \cdot \frac{\pi}{2} \right) - 0 \right] = \frac{\pi}{6}$

62. $\int_{-\infty}^{\infty} \frac{4dx}{x^2+16} = 2 \int_0^{\infty} \frac{4dx}{x^2+16} = 2 \lim_{b \rightarrow \infty} \left[\tan^{-1} \left(\frac{x}{4} \right) \right]_0^b = 2 \lim_{b \rightarrow \infty} \left[\tan^{-1} \left(\frac{b}{4} \right) - \tan^{-1}(0) \right] = 2 \left[\left(\frac{\pi}{2} \right) - 0 \right] = \pi$

63. $\lim_{\theta \rightarrow \infty} \frac{\theta}{\sqrt{\theta^2+1}} = 1$ and $\int_6^{\infty} \frac{d\theta}{\theta}$ diverges $\Rightarrow \int_6^{\infty} \frac{d\theta}{\sqrt{\theta^2+1}}$ diverges

64. $I = \int_0^{\infty} e^{-u} \cos u du = \lim_{b \rightarrow \infty} \left[-e^{-u} \cos u \right]_0^b - \int_0^{\infty} e^{-u} \sin u du = 1 + \lim_{b \rightarrow \infty} \left[e^{-u} \sin u \right]_0^b - \int_0^{\infty} (e^{-u}) \cos u du$
 $\Rightarrow I = 1 + 0 - I \Rightarrow 2I = 1 \Rightarrow I = \frac{1}{2}$ converges

65. $\int_1^{\infty} \frac{\ln z}{z} dz = \int_1^e \frac{\ln z}{z} dz + \int_e^{\infty} \frac{\ln z}{z} dz = \left[\frac{(\ln z)^2}{2} \right]_1^e + \lim_{b \rightarrow \infty} \left[\frac{(\ln z)^2}{2} \right]_e^b = \left(\frac{1^2}{2} - 0 \right) + \lim_{b \rightarrow \infty} \left[\frac{(\ln b)^2}{2} - \frac{1}{2} \right] = \infty \Rightarrow$ diverges

66. $0 < \frac{e^{-t}}{\sqrt{t}} \leq e^{-t}$ for $t \geq 1$ and $\int_1^{\infty} e^{-t} dt$ converges $\Rightarrow \int_1^{\infty} \frac{e^{-t}}{\sqrt{t}} dt$ converges

67. $\int_{-\infty}^{\infty} \frac{2 dx}{e^x+e^{-x}} = 2 \int_0^{\infty} \frac{2 dx}{e^x+e^{-x}} < \int_0^{\infty} \frac{4 dx}{e^x}$ converges $\Rightarrow \int_{-\infty}^{\infty} \frac{2 dx}{e^x+e^{-x}}$ converges

$$68. \int_{-\infty}^{\infty} \frac{dx}{x^2(1+e^x)} = \int_{-\infty}^{-1} \frac{dx}{x^2(1+e^x)} + \int_{-1}^0 \frac{dx}{x^2(1+e^x)} + \int_0^1 \frac{dx}{x^2(1+e^x)} + \int_1^{\infty} \frac{dx}{x^2(1+e^x)};$$

$$\lim_{x \rightarrow 0} \left[\frac{\left(\frac{1}{x^2}\right)}{\frac{1}{x^2(1+e^x)}} \right] = \lim_{x \rightarrow 0} \frac{x^2(1+e^x)}{x^2} = \lim_{x \rightarrow 0} (1+e^x) = 2 \text{ and } \int_0^1 \frac{dx}{x^2} \text{ diverges} \Rightarrow \int_0^1 \frac{dx}{x^2(1+e^x)} \text{ diverges} \Rightarrow \int_{-\infty}^{\infty} \frac{dx}{x^2(1+e^x)}$$

diverges

$$69. \int \frac{x dx}{1+\sqrt{x}}; \begin{cases} u = \sqrt{x} \\ du = \frac{dx}{2\sqrt{x}} \end{cases} \rightarrow \int \frac{u^2 \cdot 2u du}{1+u} = \int \left(2u^2 - 2u + 2 - \frac{2}{1+u}\right) du = \frac{2}{3}u^3 - u^2 + 2u - 2 \ln |1+u| + C$$

$$= \frac{2x^{3/2}}{3} - x + 2\sqrt{x} - 2 \ln(1+\sqrt{x}) + C$$

$$70. \int \frac{x^3+2}{4-x^2} dx = -\int \left(x + \frac{4x+2}{x^2-4}\right) dx = -\int x dx - \frac{3}{2} \int \frac{dx}{x+2} - \frac{5}{2} \int \frac{dx}{x-2} = -\frac{x^2}{2} - \frac{3}{2} \ln |x+2| - \frac{5}{2} \ln |x-2| + C$$

$$71. \int \sqrt{2x-x^2} dx; \quad x-1 = \sin \theta \quad dx = \cos \theta d\theta$$

For the integrand to be nonnegative x must be between 0 and 2 so $x-1$ is between -1 and 1 and we can take θ between $-\pi/2$ and $\pi/2$, where cosine is nonnegative. Thus

$$\sqrt{2x-x^2} = \sqrt{1-(x-1)^2} = \sqrt{1-\sin^2 \theta} = \sqrt{\cos^2 \theta} = \cos \theta.$$

$$\int \sqrt{2x-x^2} dx = \int \cos \theta \cos \theta d\theta = \int \cos^2 \theta d\theta = \frac{1}{2} \int (1 + \cos 2\theta) d\theta$$

$$= \frac{1}{2} \theta + \frac{1}{4} \sin 2\theta + C = \frac{1}{2} \theta + \frac{1}{2} \sin \theta \cos \theta + C$$

$$= \frac{1}{2} \sin^{-1}(x-1) + \frac{1}{2}(x-1)\sqrt{2x-x^2} + C$$

$$72. \int \frac{dx}{\sqrt{-2x-x^2}} = \int \frac{dx}{\sqrt{1-(x+1)^2}} = \sin^{-1}(x+1) + C$$

$$73. \int \frac{2-\cos x + \sin x}{\sin^2 x} dx = \int 2 \csc^2 x dx - \int \frac{\cos x dx}{\sin^2 x} + \int \csc x dx = -2 \cot x + \frac{1}{\sin x} - \ln |\csc x + \cot x| + C$$

$$= -2 \cot x + \csc x - \ln |\csc x + \cot x| + C$$

$$74. \int \sin^2 \theta \cos^5 \theta d\theta$$

$$\int \sin^2 \theta \cos^5 \theta d\theta = \int \sin^2 \theta (1-\sin^2 \theta)^2 \cos \theta d\theta; \quad u = \sin \theta \quad du = \cos \theta d\theta$$

$$\int \sin^2 \theta (1-\sin^2 \theta)^2 \cos \theta d\theta = \int (\sin^2 \theta - 2\sin^4 \theta + \sin^6 \theta) \cos \theta d\theta$$

$$= \int (u^2 - 2u^4 + u^6) du = \frac{u^3}{3} - \frac{2}{5}u^5 + \frac{1}{7}u^7 + C$$

$$= \frac{\sin^3 \theta}{3} - \frac{2}{5} \sin^5 \theta + \frac{1}{7} \sin^7 \theta + C$$

$$75. \int \frac{9 \, dv}{81-v^4} = \frac{1}{2} \int \frac{dv}{v^2+9} + \frac{1}{12} \int \frac{dv}{3-v} + \frac{1}{12} \int \frac{dv}{3+v} = \frac{1}{12} \ln \left| \frac{3+v}{3-v} \right| + \frac{1}{6} \tan^{-1} \frac{v}{3} + C$$

$$76. \int_2^{\infty} \frac{dx}{(x-1)^2} = \lim_{b \rightarrow \infty} \left[\frac{1}{1-x} \right]_2^b = \lim_{b \rightarrow \infty} \left[\frac{1}{1-b} - (-1) \right] = 0 + 1 = 1$$

$$77. \begin{array}{l} \cos(2\theta+1) \\ \theta \xrightarrow{(+)} \frac{1}{2} \sin(2\theta+1) \\ 1 \xrightarrow{(-)} -\frac{1}{4} \cos(2\theta+1) \\ 0 \end{array} \Rightarrow \int \theta \cos(2\theta+1) \, d\theta = \frac{\theta}{2} \sin(2\theta+1) + \frac{1}{4} \cos(2\theta+1) + C$$

$$78. \int \frac{x^3 \, dx}{x^2-2x+1} = \int \left(x+2 + \frac{3x-2}{x^2-2x+1} \right) dx = \int (x+2) \, dx + 3 \int \frac{dx}{x-1} + \int \frac{dx}{(x-1)^2} = \frac{x^2}{2} + 2x + 3 \ln |x-1| - \frac{1}{x-1} + C$$

$$79. \int \frac{\sin 2\theta \, d\theta}{(1+\cos 2\theta)^2} = -\frac{1}{2} \int \frac{(-2 \sin 2\theta) \, d\theta}{(1+\cos 2\theta)^2} = \frac{1}{2(1+\cos 2\theta)} + C = \frac{1}{4} \sec^2 \theta + C$$

$$80. \int_{\pi/4}^{\pi/2} \sqrt{1+\cos 4x} \, dx = -\sqrt{2} \int_{\pi/4}^{\pi/2} \cos 2x \, dx = \left[-\frac{\sqrt{2}}{2} \sin 2x \right]_{\pi/4}^{\pi/2} = \frac{\sqrt{2}}{2}$$

$$81. \int \frac{x \, dx}{\sqrt{2-x}}; \begin{cases} y = 2-x \\ dy = -dx \end{cases} \rightarrow -\int \frac{(2-y) \, dy}{\sqrt{y}} = \frac{2}{3} y^{3/2} - 4y^{1/2} + C = \frac{2}{3} (2-x)^{3/2} - 4(2-x)^{1/2} + C \\ = 2 \left[\frac{(\sqrt{2-x})^3}{3} - 2\sqrt{2-x} \right] + C$$

$$82. \int \frac{\sqrt{1-v^2}}{v^2} \, dv; [v = \sin \theta] \rightarrow \int \frac{\cos \theta \cdot \cos \theta \, d\theta}{\sin^2 \theta} = \int \frac{(1-\sin^2 \theta) \, d\theta}{\sin^2 \theta} = \int \csc^2 \theta \, d\theta - \int d\theta = \cot \theta - \theta + C \\ = -\sin^{-1} v - \frac{\sqrt{1-v^2}}{v} + C$$

$$83. \int \frac{dy}{y^2-2y+2} = \int \frac{dy}{(y-1)^2+1} = \tan^{-1}(y-1) + C$$

$$84. \int \frac{x \, dx}{\sqrt{8-2x^2-x^4}} = \frac{1}{2} \int \frac{(2x) \, dx}{\sqrt{9-(x^2+1)^2}} = \frac{1}{2} \sin^{-1} \left(\frac{x^2+1}{3} \right) + C$$

$$85. \int \frac{z+1}{z^2(z^2+4)} \, dz = \frac{1}{4} \int \left(\frac{1}{z} + \frac{1}{z^2} - \frac{z+1}{z^2+4} \right) dz = \frac{1}{4} \ln |z| - \frac{1}{4z} - \frac{1}{8} \ln(z^2+4) - \frac{1}{8} \tan^{-1} \frac{z}{2} + C$$

$$86. \int x^2(x-1)^{1/3} dx; \quad u = x-1 \quad du = dx \quad x^2 = (u+1)^2$$

$$\begin{aligned} \int x^2(x-1)^{1/3} dx &= \int (u^2 + 2u + 1) \cdot u^{1/3} du \\ &= \int (u^{7/3} + 2u^{4/3} + u^{1/3}) du \\ &= \frac{3}{10} u^{10/3} + \frac{6}{7} u^{7/3} + \frac{3}{4} u^{4/3} + C \\ &= \frac{3}{10} (x-1)^{10/3} + \frac{6}{7} (x-1)^{7/3} + \frac{3}{4} (x-1)^{4/3} + C \end{aligned}$$

$$87. \int \frac{t dt}{\sqrt{9-4t^2}} = -\frac{1}{8} \int \frac{(-8t) dt}{\sqrt{9-4t^2}} = -\frac{1}{4} \sqrt{9-4t^2} + C$$

$$\begin{aligned} 88. \quad u = \tan^{-1} x, \quad du = \frac{dx}{1+x^2}; \quad dv = \frac{dx}{x^2}, \quad v = -\frac{1}{x}; \quad \int \frac{\tan^{-1} x dx}{x^2} &= -\frac{1}{x} \tan^{-1} x + \int \frac{dx}{x(1+x^2)} = -\frac{1}{x} \tan^{-1} x + \int \frac{dx}{x} - \int \frac{x dx}{1+x^2} \\ &= -\frac{1}{x} \tan^{-1} x + \ln|x| - \frac{1}{2} \ln(1+x^2) + C = -\frac{\tan^{-1} x}{x} + \ln|x| - \ln\sqrt{1+x^2} + C \end{aligned}$$

$$89. \int \frac{e^t dt}{e^{2t} + 3e^t + 2}; \quad [e^t = x] \rightarrow \int \frac{dx}{(x+1)(x+2)} = \int \frac{dx}{x+1} - \int \frac{dx}{x+2} = \ln|x+1| - \ln|x+2| + C = \ln\left|\frac{x+1}{x+2}\right| + C = \ln\left(\frac{e^t+1}{e^t+2}\right) + C$$

$$90. \int \tan^3 t dt = \int (\tan t) (\sec^2 t - 1) dt = \frac{\tan^2 t}{2} - \int \tan t dt = \frac{\tan^2 t}{2} - \ln|\sec t| + C$$

$$\begin{aligned} 91. \int_1^\infty \frac{\ln y dy}{y^3}; \quad \left[\begin{array}{l} x = \ln y \\ dx = \frac{dy}{y} \\ dy = e^x dx \end{array} \right] \rightarrow \int_0^\infty \frac{x e^x}{e^{3x}} dx = \int_0^\infty x e^{-2x} dx = \lim_{b \rightarrow \infty} \left[-\frac{x}{2} e^{-2x} - \frac{1}{4} e^{-2x} \right]_0^b \\ = \lim_{b \rightarrow \infty} \left[\left(\frac{-b}{2e^{2b}} - \frac{1}{4e^{2b}} \right) - \left(0 - \frac{1}{4} \right) \right] = \frac{1}{4} \end{aligned}$$

$$92. \int y^{3/2} (\ln y)^2 dy; \quad u = (\ln y)^2, \quad du = \frac{2 \ln y}{y} dy, \quad dv = y^{3/2} dy, \quad v = \frac{2}{5} y^{5/2}$$

$$\int y^{3/2} (\ln y)^2 dy = \frac{2}{5} y^{5/2} (\ln y)^2 - \frac{4}{5} \int y^{3/2} \ln y dy$$

$$\text{Now we compute } \int y^{3/2} \ln y dy: \quad u = \ln y, \quad du = \frac{1}{y} dy, \quad dv = y^{3/2} dy, \quad v = \frac{2}{5} y^{5/2}$$

$$\begin{aligned} \int y^{3/2} \ln y dy &= \frac{2}{5} y^{5/2} \ln y - \frac{2}{5} \int y^{3/2} dy \\ &= \frac{2}{5} y^{5/2} \ln y - \frac{4}{5} y^{5/2} \end{aligned}$$

$$\begin{aligned}\int y^{3/2}(\ln y)^2 dy &= \frac{2}{5}y^{5/2}(\ln y)^2 - \frac{4}{5}\int y^{3/2} \ln y dy \\ &= \frac{2}{5}y^{5/2}(\ln y)^2 - \frac{4}{5}\left(\frac{2}{5}y^{5/2} \ln y - \frac{4}{5}y^{5/2}\right) \\ &= y^{5/2}\left(\frac{2}{5}(\ln y)^2 - \frac{8}{25}\ln y + \frac{16}{125}\right) + C\end{aligned}$$

$$93. \int e^{\ln \sqrt{x}} dx = \int \sqrt{x} dx = \frac{2}{3}x^{3/2} + C$$

$$94. \int e^{\theta} \sqrt{3+4e^{\theta}} d\theta; \left[\begin{array}{l} u = 4e^{\theta} \\ du = 4e^{\theta} d\theta \end{array} \right] \rightarrow \frac{1}{4} \int \sqrt{3+u} du = \frac{1}{4} \cdot \frac{2}{3} (3+u)^{3/2} + C = \frac{1}{6} (3+4e^{\theta})^{3/2} + C$$

$$95. \int \frac{\sin 5t dt}{1+(\cos 5t)^2}; \left[\begin{array}{l} u = \cos 5t \\ du = -5 \sin 5t dt \end{array} \right] \rightarrow -\frac{1}{5} \int \frac{du}{1+u^2} = -\frac{1}{5} \tan^{-1} u + C = -\frac{1}{5} \tan^{-1}(\cos 5t) + C$$

$$96. \int \frac{dv}{\sqrt{e^{2v}-1}}; \left[\begin{array}{l} x = e^v \\ dx = e^v dv \end{array} \right] \rightarrow \int \frac{dx}{x\sqrt{x^2-1}} = \sec^{-1} x + C = \sec^{-1}(e^v) + C$$

$$97. \int \frac{dr}{1+\sqrt{r}}; \left[\begin{array}{l} u = \sqrt{r} \\ du = \frac{dr}{2\sqrt{r}} \end{array} \right] \rightarrow \int \frac{2u du}{1+u} = \int \left(2 - \frac{2}{1+u}\right) du = 2u - 2 \ln |1+u| + C = 2\sqrt{r} - 2 \ln(1+\sqrt{r}) + C$$

$$98. \int \frac{4x^3-20x}{x^4-10x^2+9} dx = \int \frac{(4x^3-20x)dx}{x^4-10x^2+9} = \ln|x^4-10x^2+9| + C$$

$$99. \int \frac{x^3}{1+x^2} dx = \int \left(x - \frac{x}{1+x^2}\right) dx = \int x dx - \frac{1}{2} \int \frac{2x}{1+x^2} dx = \frac{1}{2}x^2 - \frac{1}{2} \ln(1+x^2) + C$$

$$100. \int \frac{x^2}{1+x^3} dx = \frac{1}{3} \int \frac{3x^2}{1+x^3} dx = \frac{1}{3} \ln|1+x^3| + C$$

$$101. \int \frac{1+x^2}{1+x^3} dx; \frac{1+x^2}{1+x^3} = \frac{A}{1+x} + \frac{Bx+C}{1-x+x^2} \Rightarrow 1+x^2 = A(1-x+x^2) + (Bx+C)(1+x) \\ = (A+B)x^2 + (-A+B+C)x + (A+C) \Rightarrow A+B=1, -A+B+C=0, A+C=1 \Rightarrow A=\frac{2}{3}, B=\frac{1}{3}, C=\frac{1}{3};$$

$$\int \frac{1+x^2}{1+x^3} dx = \int \left(\frac{2/3}{1+x} + \frac{(1/3)x+1/3}{1-x+x^2}\right) dx = \frac{2}{3} \int \frac{1}{1+x} dx + \frac{1}{3} \int \frac{x+1}{1-x+x^2} dx = \frac{2}{3} \int \frac{1}{1+x} dx + \frac{1}{3} \int \frac{x+1}{\frac{3}{4}+(x-\frac{1}{2})^2} dx;$$

$$\left[\begin{array}{l} u = x - \frac{1}{2} \\ du = dx \end{array} \right] \rightarrow \frac{1}{3} \int \frac{u+\frac{3}{2}}{\frac{3}{4}+u^2} du = \frac{1}{3} \int \frac{u}{\frac{3}{4}+u^2} du + \frac{1}{2} \int \frac{1}{\frac{3}{4}+u^2} du = \frac{1}{6} \ln\left|\frac{3}{4}+u^2\right| + \frac{1}{\sqrt{3}} \tan^{-1}\left(\frac{u}{\sqrt{3}/2}\right)$$

$$= \frac{1}{6} \ln\left|\frac{3}{4} + \left(x - \frac{1}{2}\right)^2\right| + \frac{1}{\sqrt{3}} \tan^{-1}\left(\frac{x-\frac{1}{2}}{\sqrt{3}/2}\right) = \frac{1}{6} \ln|1-x+x^2| + \frac{1}{\sqrt{3}} \tan^{-1}\left(\frac{2x-1}{\sqrt{3}}\right)$$

$$\Rightarrow \frac{2}{3} \int \frac{1}{1+x} dx + \frac{1}{3} \int \frac{x+1}{1-x+x^2} dx = \frac{2}{3} \ln|1+x| + \frac{1}{6} \ln|1-x+x^2| + \frac{1}{\sqrt{3}} \tan^{-1}\left(\frac{2x-1}{\sqrt{3}}\right) + C$$

$$102. \int \frac{1+x^2}{(1+x)^3} dx; \left[\begin{array}{l} u = 1+x \\ du = dx \end{array} \right] \rightarrow \int \frac{1+(u-1)^2}{u^3} du = \int \frac{u^2-2u+2}{u^3} du = \int \frac{1}{u} du - \int \frac{2}{u^2} du + \int \frac{2}{u^3} du = \ln |u| + \frac{2}{u} - \frac{1}{u^2} + C$$

$$= \ln |1+x| + \frac{2}{1+x} - \frac{1}{(1+x)^2} + C$$

$$103. \int \sqrt{x}\sqrt{1+\sqrt{x}} dx; \left[\begin{array}{l} w = \sqrt{x} \Rightarrow w^2 = x \\ 2w dw = dx \end{array} \right] \rightarrow \int 2w^2 \sqrt{1+w} dw$$

$$\begin{array}{l} \sqrt{1+w} \\ 2w^2 \xrightarrow{(+)} \frac{2}{3}(1+w)^{3/2} \\ 4w \xrightarrow{(-)} \frac{4}{15}(1+w)^{5/2} \\ 4 \xrightarrow{(+)} \frac{8}{105}(1+w)^{7/2} \\ 0 \end{array} \Rightarrow \int 2w^2 \sqrt{1+w} dw = \frac{4}{3}w^2(1+w)^{3/2} - \frac{16}{15}w(1+w)^{5/2} + \frac{32}{105}(1+w)^{7/2} + C$$

$$= \frac{4}{3}x(1+\sqrt{x})^{3/2} - \frac{16}{15}\sqrt{x}(1+\sqrt{x})^{5/2} + \frac{32}{105}(1+\sqrt{x})^{7/2} + C$$

$$104. \int \sqrt{1+\sqrt{1+x}} dx; \left[\begin{array}{l} w = \sqrt{1+x} \Rightarrow w^2 = 1+x \\ 2w dw = dx \end{array} \right] \rightarrow \int 2w\sqrt{1+w} dw;$$

$$\left[u = 2w, du = 2dw, dv = \sqrt{1+w} dw, v = \frac{2}{3}(1+w)^{3/2} \right]$$

$$\int 2w\sqrt{1+w} dw = \frac{4}{3}w(1+w)^{3/2} - \int \frac{4}{3}(1+w)^{3/2} dw = \frac{4}{3}w(1+w)^{3/2} - \frac{8}{15}(1+w)^{5/2} + C$$

$$= \frac{4}{3}\sqrt{1+x}(1+\sqrt{1+x})^{3/2} - \frac{8}{15}(1+\sqrt{1+x})^{5/2} + C$$

$$105. \int \frac{1}{\sqrt{x}\sqrt{1+x}} dx; \left[\begin{array}{l} u = \sqrt{x} \Rightarrow u^2 = x \\ 2u du = dx \end{array} \right] \rightarrow \int \frac{2}{\sqrt{1+u^2}} du; \left[u = \tan \theta, -\frac{\pi}{2} < \theta < \frac{\pi}{2}, du = \sec^2 \theta d\theta, \sqrt{1+u^2} = \sec \theta \right]$$

$$\int \frac{2}{\sqrt{1+u^2}} du = \int \frac{2\sec^2 \theta}{\sec \theta} d\theta = \int 2\sec \theta d\theta = 2\ln |\sec \theta + \tan \theta| + C = 2\ln \left| \sqrt{1+u^2} + u \right| + C = 2\ln \left| \sqrt{1+x} + \sqrt{x} \right| + C$$

$$106. \int_0^{1/2} \sqrt{1+\sqrt{1-x^2}} dx;$$

$$\left[x = \sin \theta, -\frac{\pi}{2} < \theta < \frac{\pi}{2}, dx = \cos \theta d\theta, \sqrt{1-x^2} = \cos \theta, x = 0 = \sin \theta \Rightarrow \theta = 0, x = \frac{1}{2} = \sin \theta \Rightarrow \theta = \frac{\pi}{6} \right]$$

$$\rightarrow \int_0^{\pi/6} \sqrt{1+\cos \theta} \cos \theta d\theta = \int_0^{\pi/6} \frac{\sqrt{1-\cos^2 \theta}}{\sqrt{1-\cos \theta}} \cos \theta d\theta = \int_0^{\pi/6} \frac{\sin \theta \cos \theta}{\sqrt{1-\cos \theta}} d\theta = \lim_{c \rightarrow 0^+} \int_c^{\pi/6} \frac{\sin \theta \cos \theta}{\sqrt{1-\cos \theta}} d\theta;$$

$$\left[u = \cos \theta, du = -\sin \theta d\theta, dv = \frac{\sin \theta}{\sqrt{1-\cos \theta}} d\theta, v = 2(1-\cos \theta)^{1/2} \right]$$

$$= \lim_{c \rightarrow 0^+} \left[\left[2\cos \theta (1-\cos \theta)^{1/2} \right]_c^{\pi/6} + \int_c^{\pi/6} 2(1-\cos \theta)^{1/2} \sin \theta d\theta \right]$$

$$= \lim_{c \rightarrow 0^+} \left[\left(2\cos \left(\frac{\pi}{6} \right) \left(1-\cos \left(\frac{\pi}{6} \right) \right)^{1/2} - 2\cos c (1-\cos c)^{1/2} \right) + \left[\frac{4}{3}(1-\cos \theta)^{3/2} \right]_c^{\pi/6} \right]$$

$$= \lim_{c \rightarrow 0^+} \left[\sqrt{3} \left(1-\frac{\sqrt{3}}{2} \right)^{1/2} - 2\cos c (1-\cos c)^{1/2} + \left(\frac{4}{3} \left(1-\cos \left(\frac{\pi}{6} \right) \right)^{3/2} - \frac{4}{3} (1-\cos c)^{3/2} \right) \right]$$

$$= \lim_{c \rightarrow 0^+} \left[\sqrt{3} \left(1 - \frac{\sqrt{3}}{2}\right)^{1/2} - 2 \cos c (1 - \cos c)^{1/2} + \frac{4}{3} \left(1 - \frac{\sqrt{3}}{2}\right)^{3/2} - \frac{4}{3} (1 - \cos c)^{3/2} \right]$$

$$= \sqrt{3} \left(1 - \frac{\sqrt{3}}{2}\right)^{1/2} + \frac{4}{3} \left(1 - \frac{\sqrt{3}}{2}\right)^{3/2} = \left(1 - \frac{\sqrt{3}}{2}\right)^{1/2} \left(\frac{4 + \sqrt{3}}{3}\right) = \frac{(4 + \sqrt{3})\sqrt{2 - \sqrt{3}}}{3\sqrt{2}}$$

$$107. \int \frac{\ln x}{x + x \ln x} dx = \int \frac{\ln x}{x(1 + \ln x)} dx; \quad \begin{cases} u = 1 + \ln x \\ du = \frac{1}{x} dx \end{cases} \rightarrow \int \frac{u-1}{u} du = \int du - \int \frac{1}{u} du = u - \ln |u| + C$$

$$= (1 + \ln x) - \ln |1 + \ln x| + C = \ln x - \ln |1 + \ln x| + C$$

$$108. \int \frac{1}{x \ln x \cdot \ln(\ln x)} dx; \quad \begin{cases} u = \ln(\ln x) \\ du = \frac{1}{x \ln x} dx \end{cases} \rightarrow \int \frac{1}{u} du = \ln |u| + C = \ln |\ln(\ln x)| + C$$

$$109. \int \frac{x^{\ln x} \ln x}{x} dx; \quad \left[u = x^{\ln x} \Rightarrow \ln u = \ln x^{\ln x} = (\ln x)^2 \Rightarrow \frac{1}{u} du = \frac{2 \ln x}{x} dx \Rightarrow du = \frac{2u \ln x}{x} dx = \frac{2x^{\ln x} \ln x}{x} dx \right]$$

$$\rightarrow \frac{1}{2} \int du = \frac{1}{2} u + C = \frac{1}{2} x^{\ln x} + C$$

$$110. \int (\ln x)^{\ln x} \left[\frac{1}{x} + \frac{\ln(\ln x)}{x} \right] dx; \quad \left[u = (\ln x)^{\ln x} \Rightarrow \ln u = \ln(\ln x)^{\ln x} = (\ln x) \ln(\ln x) \Rightarrow \frac{1}{u} du = \left(\frac{\ln x}{x \ln x} + \frac{\ln(\ln x)}{x} \right) dx \right]$$

$$\Rightarrow du = u \left[\frac{1}{x} + \frac{\ln(\ln x)}{x} \right] dx = (\ln x)^{\ln x} \left[\frac{1}{x} + \frac{\ln(\ln x)}{x} \right] dx \rightarrow \int du = u + C = (\ln x)^{\ln x} + C$$

$$111. \int \frac{1}{x\sqrt{1-x^4}} dx = \int \frac{x}{x^2\sqrt{1-x^4}} dx; \quad \left[x^2 = \sin \theta, 0 \leq \theta < \frac{\pi}{2}, 2x dx = \cos \theta d\theta, \sqrt{1-x^4} = \cos \theta \right]$$

$$\rightarrow \frac{1}{2} \int \frac{\cos \theta}{\sin \theta \cos \theta} d\theta = \frac{1}{2} \int \csc \theta d\theta = -\frac{1}{2} \ln |\csc \theta + \cot \theta| + C = -\frac{1}{2} \ln \left| \frac{1}{x^2} + \frac{\sqrt{1-x^4}}{x^2} \right| + C = -\frac{1}{2} \ln \left| \frac{1 + \sqrt{1-x^4}}{x^2} \right| + C$$

$$112. \int \frac{\sqrt{1-x}}{x} dx; \quad \left[u = \sqrt{1-x} \Rightarrow u^2 = 1-x \Rightarrow 2u du = -dx \right] \rightarrow \int \frac{-2u^2}{1-u^2} du = \int \frac{2u^2}{u^2-1} du = \int \left(2 + \frac{2}{u^2-1} \right) du;$$

$$\frac{2}{u^2-1} = \frac{A}{u-1} + \frac{B}{u+1} \Rightarrow 2 = A(u+1) + B(u-1) = (A+B)u + A-B \Rightarrow A+B=0, A-B=2 \Rightarrow A=1 \Rightarrow B=-1;$$

$$\int \left(2 + \frac{2}{u^2-1} \right) du = \int 2 du + \int \left(\frac{1}{u-1} - \frac{1}{u+1} \right) du = 2u + \ln |u-1| - \ln |u+1| + C = 2\sqrt{1-x} + \frac{1}{2} \ln \left| \frac{\sqrt{1-x}-1}{\sqrt{1-x}+1} \right| + C$$

$$113. (a) \int_0^a f(a-x) dx; \quad \left[u = a-x \Rightarrow du = -dx, x=0 \Rightarrow u=a, x=a \Rightarrow u=0 \right] \rightarrow -\int_a^0 f(u) du = \int_0^a f(u) du, \text{ which}$$

is the same integral as $\int_0^a f(x) dx$.

$$(b) \int_0^{\pi/2} \frac{\sin x}{\sin x + \cos x} dx = \int_0^{\pi/2} \frac{\sin(\frac{\pi}{2}-x)}{\sin(\frac{\pi}{2}-x) + \cos(\frac{\pi}{2}-x)} dx = \int_0^{\pi/2} \frac{\sin(\frac{\pi}{2})\cos x - \cos(\frac{\pi}{2})\sin x}{\sin(\frac{\pi}{2})\cos x - \cos(\frac{\pi}{2})\sin x + \cos(\frac{\pi}{2})\cos x + \sin(\frac{\pi}{2})\sin x} dx$$

$$= \int_0^{\pi/2} \frac{\cos x}{\cos x + \sin x} dx \Rightarrow 2 \int_0^{\pi/2} \frac{\sin x}{\sin x + \cos x} dx = \int_0^{\pi/2} \frac{\sin x}{\sin x + \cos x} dx + \int_0^{\pi/2} \frac{\cos x}{\cos x + \sin x} dx$$

$$= \int_0^{\pi/2} \frac{\sin x + \cos x}{\sin x + \cos x} dx = \int_0^{\pi/2} dx = [x]_0^{\pi/2} = \frac{\pi}{2} \Rightarrow 2 \int_0^{\pi/2} \frac{\sin x}{\sin x + \cos x} dx = \frac{\pi}{2} \Rightarrow \int_0^{\pi/2} \frac{\sin x}{\sin x + \cos x} dx = \frac{\pi}{4}$$

$$\begin{aligned}
 114. \int \frac{\sin x}{\sin x + \cos x} dx &= \int \frac{\sin x + \cos x - \cos x + \sin x - \sin x}{\sin x + \cos x} dx = \int \frac{\sin x + \cos x}{\sin x + \cos x} dx + \int \frac{-\cos x + \sin x}{\sin x + \cos x} dx + \int \frac{-\sin x}{\sin x + \cos x} dx \\
 &= \int dx - \int \frac{\cos x - \sin x}{\sin x + \cos x} dx - \int \frac{\sin x}{\sin x + \cos x} dx = x - \ln |\sin x + \cos x| - \int \frac{\sin x}{\sin x + \cos x} dx \\
 &\Rightarrow 2 \int \frac{\sin x}{\sin x + \cos x} dx = x - \ln |\sin x + \cos x| \Rightarrow \int \frac{\sin x}{\sin x + \cos x} dx = \frac{x}{2} - \frac{1}{2} \ln |\sin x + \cos x| + C
 \end{aligned}$$

$$\begin{aligned}
 115. \int \frac{\sin^2 x}{1 + \sin^2 x} dx &= \int \frac{\frac{\sin^2 x}{\cos^2 x}}{\frac{1}{\cos^2 x} + \frac{\sin^2 x}{\cos^2 x}} dx = \int \frac{\tan^2 x}{\sec^2 x + \tan^2 x} dx = \int \frac{\tan^2 x + \sec^2 x - \sec^2 x}{\sec^2 x + \tan^2 x} dx = \int \frac{\tan^2 x + \sec^2 x}{\sec^2 x + \tan^2 x} dx - \int \frac{\sec^2 x}{\sec^2 x + \tan^2 x} dx \\
 &= \int dx - \int \frac{\sec^2 x}{1 + 2 \tan^2 x} dx = x - \frac{1}{\sqrt{2}} \tan^{-1}(\sqrt{2} \tan x) + C
 \end{aligned}$$

$$\begin{aligned}
 116. \int \frac{1 - \cos x}{1 + \cos x} dx &= \int \frac{(1 - \cos x)^2}{1 - \cos^2 x} dx = \int \frac{1 - 2 \cos x + \cos^2 x}{\sin^2 x} dx = \int \frac{1}{\sin^2 x} dx - \int \frac{2 \cos x}{\sin^2 x} dx + \int \frac{\cos^2 x}{\sin^2 x} dx \\
 &= \int \csc^2 x dx - 2 \int \csc x \cot x dx + \int \cot^2 x dx = -\cot x + 2 \csc x + \int (\csc^2 x - 1) dx = -2 \cot x + 2 \csc x - x + C
 \end{aligned}$$

CHAPTER 8 ADDITIONAL AND ADVANCED EXERCISES

1. $u = (\sin^{-1} x)^2$, $du = \frac{2 \sin^{-1} x dx}{\sqrt{1-x^2}}$; $dv = dx$, $v = x$;

$$\int (\sin^{-1} x)^2 dx = x (\sin^{-1} x)^2 - \int \frac{2x \sin^{-1} x dx}{\sqrt{1-x^2}}; \quad u = \sin^{-1} x, \quad du = \frac{dx}{\sqrt{1-x^2}}; \quad dv = -\frac{2x dx}{\sqrt{1-x^2}}, \quad v = 2\sqrt{1-x^2};$$

$$-\int \frac{2x \sin^{-1} x dx}{\sqrt{1-x^2}} = 2(\sin^{-1} x)\sqrt{1-x^2} - \int 2 dx = 2(\sin^{-1} x)\sqrt{1-x^2} - 2x + C; \text{ therefore}$$

$$\int (\sin^{-1} x)^2 dx = x(\sin^{-1} x)^2 + 2(\sin^{-1} x)\sqrt{1-x^2} - 2x + C$$

2. $\frac{1}{x} = \frac{1}{x}$,

$$\frac{1}{x(x+1)} = \frac{1}{x} - \frac{1}{x+1},$$

$$\frac{1}{x(x+1)(x+2)} = \frac{1}{2x} - \frac{1}{x+1} + \frac{1}{2(x+2)},$$

$$\frac{1}{x(x+1)(x+2)(x+3)} = \frac{1}{6x} - \frac{1}{2(x+1)} + \frac{1}{2(x+2)} - \frac{1}{6(x+3)},$$

$$\frac{1}{x(x+1)(x+2)(x+3)(x+4)} = \frac{1}{24x} - \frac{1}{6(x+1)} + \frac{1}{4(x+2)} - \frac{1}{6(x+3)} + \frac{1}{24(x+4)}$$

$$\Rightarrow \text{the following pattern: } \frac{1}{x(x+1)(x+2)\cdots(x+m)} = \sum_{k=0}^m \frac{(-1)^k}{(k!(m-k)!(x+k)};$$

$$\text{therefore } \int \frac{dx}{x(x+1)(x+2)\cdots(x+m)} = \sum_{k=0}^m \left[\frac{(-1)^k}{(k!(m-k)!} \ln|x+k| \right] + C$$

3. $u = \sin^{-1} x, du = \frac{dx}{\sqrt{1-x^2}}; dv = x dx, v = \frac{x^2}{2}; \int x \sin^{-1} x dx = \frac{x^2}{2} \sin^{-1} x - \int \frac{x^2 dx}{2\sqrt{1-x^2}};$
 $\left[\begin{array}{l} x = \sin \theta \\ dx = \cos \theta d\theta \end{array} \right] \rightarrow \int x \sin^{-1} x dx = \frac{x^2}{2} \sin^{-1} x - \int \frac{\sin^2 \theta \cos \theta d\theta}{2 \cos \theta} = \frac{x^2}{2} \sin^{-1} x - \frac{1}{2} \int \sin^2 \theta d\theta$
 $= \frac{x^2}{2} \sin^{-1} x - \frac{1}{2} \left(\frac{\theta}{2} - \frac{\sin 2\theta}{4} \right) + C = \frac{x^2}{2} \sin^{-1} x + \frac{\sin \theta \cos \theta - \theta}{4} + C = \frac{x^2}{2} \sin^{-1} x + \frac{x\sqrt{1-x^2} - \sin^{-1} x}{4} + C$
4. $\int \sin^{-1} \sqrt{y} dy; \left[\begin{array}{l} z = \sqrt{y} \\ dz = \frac{dy}{2\sqrt{y}} \end{array} \right] \rightarrow \int 2z \sin^{-1} z dz; \text{ from Exercise 3, } \int z \sin^{-1} z dz = \frac{z^2 \sin^{-1} z}{2} + \frac{z\sqrt{1-z^2} - \sin^{-1} z}{4} + C$
 $\Rightarrow \int \sin^{-1} \sqrt{y} dy = y \sin^{-1} \sqrt{y} + \frac{\sqrt{y}\sqrt{1-y} - \sin^{-1} \sqrt{y}}{2} + C = y \sin^{-1} \sqrt{y} + \frac{\sqrt{y-y^2}}{2} - \frac{\sin^{-1} \sqrt{y}}{2} + C$
5. $\int \frac{dt}{t-\sqrt{1-t^2}}; \left[\begin{array}{l} t = \sin \theta \\ dt = \cos \theta d\theta \end{array} \right] \rightarrow \int \frac{\cos \theta d\theta}{\sin \theta - \cos \theta} = \int \frac{d\theta}{\tan \theta - 1}; \left[\begin{array}{l} u = \tan \theta \\ du = \sec^2 \theta d\theta \\ d\theta = \frac{du}{u^2+1} \end{array} \right] \rightarrow \int \frac{du}{(u-1)(u^2+1)}$
 $= \frac{1}{2} \int \frac{du}{u-1} - \frac{1}{2} \int \frac{du}{u^2+1} - \frac{1}{2} \int \frac{u du}{u^2+1} = \frac{1}{2} \ln \left| \frac{u-1}{\sqrt{u^2+1}} \right| - \frac{1}{2} \tan^{-1} u + C = \frac{1}{2} \ln \left| \frac{\tan \theta - 1}{\sec \theta} \right| - \frac{1}{2} \theta + C$
 $= \frac{1}{2} \ln \left(t - \sqrt{1-t^2} \right) - \frac{1}{2} \sin^{-1} t + C$
6. $\int \frac{1}{x^4+4} dx = \int \frac{1}{(x^2+2)^2 - 4x^2} dx = \int \frac{1}{(x^2+2x+2)(x^2-2x+2)} dx = \frac{1}{16} \int \left[\frac{2x+2}{x^2+2x+2} + \frac{2}{(x+1)^2+1} - \frac{2x-2}{x^2-2x+2} + \frac{2}{(x-1)^2+1} \right] dx$
 $= \frac{1}{16} \ln \left| \frac{x^2+2x+2}{x^2-2x+2} \right| + \frac{1}{8} \left[\tan^{-1}(x+1) + \tan^{-1}(x-1) \right] + C$
7. $\lim_{x \rightarrow \infty} \int_{-x}^x \sin t dt = \lim_{x \rightarrow \infty} [-\cos t]_{-x}^x = \lim_{x \rightarrow \infty} [-\cos x + \cos(-x)] = \lim_{x \rightarrow \infty} (-\cos x + \cos x) = \lim_{x \rightarrow \infty} 0 = 0$
8. $\lim_{x \rightarrow 0^+} \int_x^1 \frac{\cos t}{t^2} dt; \lim_{t \rightarrow 0^+} \frac{\left(\frac{1}{t^2}\right)}{\cos t} = \lim_{t \rightarrow 0^+} \frac{1}{\cos t} = 1 \Rightarrow \lim_{x \rightarrow 0^+} \int_x^1 \frac{\cos t}{t^2} dt$ diverges since $\int_0^1 \frac{dt}{t^2}$ diverges; thus
 $\lim_{x \rightarrow 0^+} x \int_x^1 \frac{\cos t}{t^2} dt$ is an indeterminate $0 \cdot \infty$ form and we apply l'Hôpital's rule:
 $\lim_{x \rightarrow 0^+} x \int_x^1 \frac{\cos t}{t^2} dt = \lim_{x \rightarrow 0^+} \frac{-\int_1^x \frac{\cos t}{t^2} dt}{\frac{1}{x}} = \lim_{x \rightarrow 0^+} \frac{-\left(\frac{\cos x}{x^2}\right)}{\left(-\frac{1}{x^2}\right)} = \lim_{x \rightarrow 0^+} \cos x = 1$
9. $\lim_{n \rightarrow \infty} \sum_{k=1}^n \ln \sqrt[1+\frac{k}{n}] = \lim_{n \rightarrow \infty} \sum_{k=1}^n \ln \left(1 + k \left(\frac{1}{n} \right) \right) \left(\frac{1}{n} \right) = \int_0^1 \ln(1+x) dx; \left[\begin{array}{l} u = 1+x, du = dx \\ x = 0 \Rightarrow u = 1, x = 1 \Rightarrow u = 2 \end{array} \right]$
 $\rightarrow \int_1^2 \ln u du = [u \ln u - u]_1^2 = (2 \ln 2 - 2) - (\ln 1 - 1) = 2 \ln 2 - 1 = \ln 4 - 1$

$$10. \lim_{n \rightarrow \infty} \sum_{k=0}^{n-1} \frac{1}{\sqrt{n^2 - k^2}} = \lim_{n \rightarrow \infty} \sum_{k=0}^{n-1} \left(\frac{n}{\sqrt{n^2 - k^2}} \right) \left(\frac{1}{n} \right) = \lim_{n \rightarrow \infty} \sum_{k=0}^{n-1} \left(\frac{1}{\sqrt{1 - \left[\frac{k}{n} \right]^2}} \right) \left(\frac{1}{n} \right) = \int_0^1 \frac{1}{\sqrt{1-x^2}} dx = \left[\sin^{-1} x \right]_0^1 = \frac{\pi}{2}$$

$$11. \frac{dy}{dx} = \sqrt{\cos 2x} \Rightarrow 1 + \left(\frac{dy}{dx} \right)^2 = 1 + \cos 2x = 2 \cos^2 x; \quad L = \int_0^{\pi/4} \sqrt{1 + (\sqrt{\cos 2t})^2} dt = \sqrt{2} \int_0^{\pi/4} \sqrt{\cos^2 t} dt = \sqrt{2} [\sin t]_0^{\pi/4} = 1$$

$$12. \frac{dy}{dx} = \frac{-2x}{1-x^2} \Rightarrow 1 + \left(\frac{dy}{dx} \right)^2 = \frac{(1-x^2)^2 + 4x^2}{(1-x^2)^2} = \frac{1+2x^2+x^4}{(1-x^2)^2} = \left(\frac{1+x^2}{1-x^2} \right)^2; \quad L = \int_0^{1/2} \sqrt{1 + \left(\frac{dy}{dx} \right)^2} dx = \int_0^{1/2} \left(\frac{1+x^2}{1-x^2} \right) dx = \int_0^{1/2} \left(-1 + \frac{2}{1-x^2} \right) dx = \int_0^{1/2} \left(-1 + \frac{1}{1+x} + \frac{1}{1-x} \right) dx = \left[-x + \ln \left| \frac{1+x}{1-x} \right| \right]_0^{1/2} = \left(-\frac{1}{2} + \ln 3 \right) - (0 + \ln 1) = \ln 3 - \frac{1}{2}$$

$$13. V = \int_a^b 2\pi \left(\begin{matrix} \text{shell} \\ \text{radius} \end{matrix} \right) \left(\begin{matrix} \text{shell} \\ \text{height} \end{matrix} \right) dx = \int_0^1 2\pi xy dx = 6\pi \int_0^1 x^2 \sqrt{1-x} dx; \quad [u = 1-x, du = -dx, x^2 = (1-u)^2] \\ \rightarrow -6\pi \int_1^0 (1-u)^2 \sqrt{u} du = 6\pi \int_0^1 (u^{1/2} - 2u^{3/2} + u^{5/2}) du = 6\pi \left[\frac{2}{3} u^{3/2} - \frac{4}{5} u^{5/2} + \frac{2}{7} u^{7/2} \right]_0^1 = 6\pi \left(\frac{2}{3} - \frac{4}{5} + \frac{2}{7} \right) = 6\pi \left(\frac{70-84+30}{105} \right) = 6\pi \left(\frac{16}{105} \right) = \frac{32\pi}{35}$$

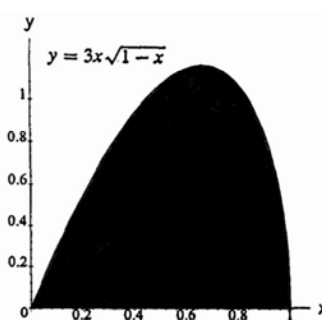

$$14. V = \int_a^b \pi y^2 dx = \pi \int_1^4 \frac{25 dx}{x^2(5-x)} = \pi \int_1^4 \left(\frac{1}{x} + \frac{5}{x^2} + \frac{1}{5-x} \right) dx = \pi \left[\ln \left| \frac{x}{5-x} \right| - \frac{5}{x} \right]_1^4 = \pi \left(\ln 4 - \frac{5}{4} \right) - \pi \left(\ln \frac{1}{4} - 5 \right) = \frac{15\pi}{4} + 2\pi \ln 4$$

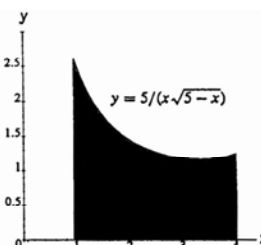

$$15. V = \int_a^b 2\pi \left(\begin{matrix} \text{shell} \\ \text{radius} \end{matrix} \right) \left(\begin{matrix} \text{shell} \\ \text{height} \end{matrix} \right) dx = \int_0^1 2\pi x e^x dx = 2\pi \left[x e^x - e^x \right]_0^1 = 2\pi$$

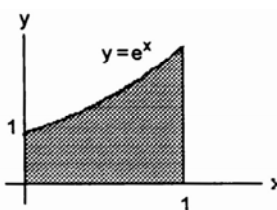

$$16. V = \int_0^{\ln 2} 2\pi (\ln 2 - x)(e^x - 1) dx = 2\pi \int_0^{\ln 2} [(\ln 2)e^x - \ln 2 - x e^x + x] dx = 2\pi \left[(\ln 2)e^x - (\ln 2)x - x e^x + e^x + \frac{x^2}{2} \right]_0^{\ln 2} = 2\pi \left[2 \ln 2 - (\ln 2)^2 - 2 \ln 2 + 2 + \frac{(\ln 2)^2}{2} \right] - 2\pi (\ln 2 + 1)$$

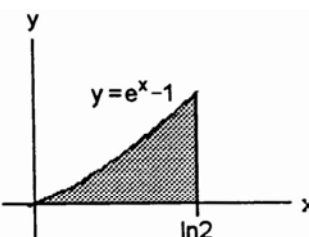

$$= 2\pi \left[-\frac{(\ln 2)^2}{2} - \ln 2 + 1 \right]$$

$$17. \text{ (a) } V = \int_1^e \pi \left[1 - (\ln x)^2 \right] dx$$

$$= \pi \left[x - x(\ln x)^2 \right]_1^e + 2\pi \int_1^e \ln x \, dx$$

(FORMULA 110)

$$= \pi \left[x - x(\ln x)^2 + 2(x \ln x - x) \right]_1^e$$

$$= \pi \left[-x - x(\ln x)^2 + 2x \ln x \right]_1^e$$

$$= \pi \left[-e - e + 2e - (-1) \right] = \pi$$

$$\text{(b) } V = \int_1^e \pi (1 - \ln x)^2 \, dx = \pi \int_1^e \left[1 - 2 \ln x + (\ln x)^2 \right] dx$$

$$= \pi \left[x - 2(x \ln x - x) + x(\ln x)^2 \right]_1^e - 2\pi \int_1^e \ln x \, dx$$

$$= \pi \left[x - 2(x \ln x - x) + x(\ln x)^2 - 2(x \ln x - x) \right]_1^e$$

$$= \pi \left[5x - 4x \ln x + x(\ln x)^2 \right]_1^e$$

$$= \pi \left[(5e - 4e + e) - (5) \right] = \pi(2e - 5)$$

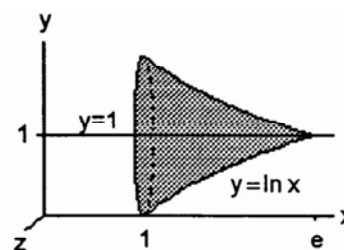
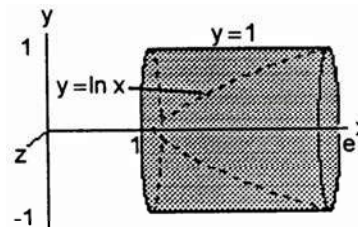

$$18. \text{ (a) } V = \pi \int_0^1 \left[(e^y)^2 - 1 \right] dy = \pi \int_0^1 (e^{2y} - 1) dy = \pi \left[\frac{e^{2y}}{2} - y \right]_0^1 = \pi \left[\frac{e^2}{2} - 1 - \left(\frac{1}{2} \right) \right] = \frac{\pi(e^2 - 3)}{2}$$

$$\text{(b) } V = \pi \int_0^1 (e^y - 1)^2 dy = \pi \int_0^1 (e^{2y} - 2e^y + 1) dy = \pi \left[\frac{e^{2y}}{2} - 2e^y + y \right]_0^1 = \pi \left[\left(\frac{e^2}{2} - 2e + 1 \right) - \left(\frac{1}{2} - 2 \right) \right]$$

$$= \pi \left(\frac{e^2}{2} - 2e + \frac{5}{2} \right) = \frac{\pi(e^2 - 4e + 5)}{2}$$

$$19. \text{ (a) } \lim_{x \rightarrow 0^+} x \ln x = 0 \Rightarrow \lim_{x \rightarrow 0^+} f(x) = 0 = f(0) \Rightarrow f \text{ is continuous}$$

$$\text{(b) } V = \int_0^2 \pi x^2 (\ln x)^2 dx; \left[u = (\ln x)^2, du = (2 \ln x) \frac{dx}{x}; dv = x^2 dx, v = \frac{x^3}{3} \right]$$

$$\rightarrow \pi \left(\lim_{b \rightarrow 0^+} \left[\frac{x^3}{3} (\ln x)^2 \right]_b^2 - \int_0^2 \left(\frac{x^3}{3} \right) (2 \ln x) \frac{dx}{x} \right) = \pi \left[\left(\frac{8}{3} \right) (\ln 2)^2 - \left(\frac{2}{3} \right) \lim_{b \rightarrow 0^+} \left[\frac{x^3}{3} \ln x - \frac{x^3}{9} \right]_b^2 \right]$$

$$= \pi \left[\frac{8(\ln 2)^2}{3} - \frac{16(\ln 2)}{9} + \frac{16}{27} \right]$$

$$\begin{aligned}
 20. \quad V &= \int_0^1 \pi (-\ln x)^2 dx = \pi \int_0^1 (\ln x)^2 dx \\
 &= \pi \left(\lim_{b \rightarrow 0^+} \left[x(\ln x)^2 \right]_b^1 - 2 \int_0^1 \ln x dx \right) \\
 &= -2\pi \lim_{b \rightarrow 0^+} [x \ln x - x]_b^1 = 2\pi
 \end{aligned}$$

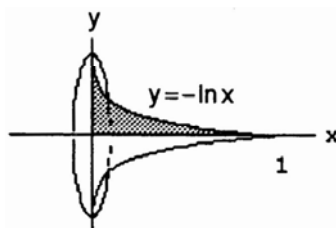

$$\begin{aligned}
 21. \quad M &= \int_1^e \ln x dx = [x \ln x - x]_1^e = (e - e) - (0 - 1) = 1; \\
 M_x &= \int_1^e (\ln x) \left(\frac{\ln x}{2} \right) dx = \frac{1}{2} \int_1^e (\ln x)^2 dx \\
 &= \frac{1}{2} \left([x(\ln x)^2]_1^e - 2 \int_1^e \ln x dx \right) = \frac{1}{2}(e - 2); \\
 M_y &= \int_1^e x \ln x dx = \left[\frac{x^2 \ln x}{2} \right]_1^e - \frac{1}{2} \int_1^e x dx \\
 &= \frac{1}{2} \left[x^2 \ln x - \frac{x^2}{2} \right]_1^e = \frac{1}{2} \left[\left(e^2 - \frac{e^2}{2} \right) + \frac{1}{2} \right] = \frac{1}{4}(e^2 + 1); \\
 \text{therefore, } \bar{x} &= \frac{M_y}{M} = \frac{e^2 + 1}{4} \text{ and } \bar{y} = \frac{M_x}{M} = \frac{e - 2}{2}
 \end{aligned}$$

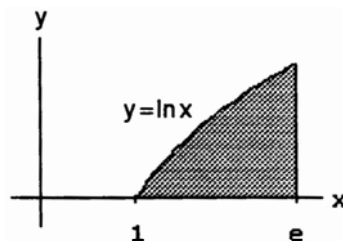

$$\begin{aligned}
 22. \quad M &= \int_0^1 \frac{2x dx}{\sqrt{1-x^2}} = [2 \sin^{-1} x]_0^1 = \pi; \\
 M_y &= \int_0^1 \frac{2x dx}{\sqrt{1-x^2}} = 2 \left[-\sqrt{1-x^2} \right]_0^1 = 2; \text{ therefore,} \\
 \bar{x} &= \frac{M_y}{M} = \frac{2}{\pi} \text{ and } \bar{y} = 0 \text{ by symmetry}
 \end{aligned}$$

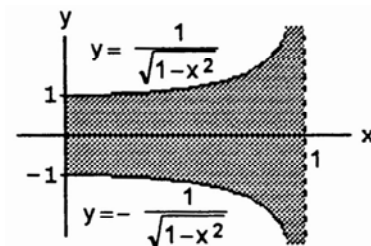

$$\begin{aligned}
 23. \quad L &= \int_1^e \sqrt{1 + \frac{1}{x^2}} dx = \int_1^e \frac{\sqrt{x^2 + 1}}{x} dx; \quad \begin{cases} x = \tan \theta \\ dx = \sec^2 \theta d\theta \end{cases} \rightarrow L = \int_{\pi/4}^{\tan^{-1} e} \frac{\sec \theta \cdot \sec^2 \theta d\theta}{\tan \theta} = \int_{\pi/4}^{\tan^{-1} e} \frac{(\sec \theta)(\tan^2 \theta + 1)}{\tan \theta} d\theta \\
 &= \int_{\pi/4}^{\tan^{-1} e} (\tan \theta \sec \theta + \csc \theta) d\theta = [\sec \theta - \ln |\csc \theta + \cot \theta|]_{\pi/4}^{\tan^{-1} e} \\
 &= \left(\sqrt{1 + e^2} - \ln \left| \frac{\sqrt{1 + e^2}}{e} + \frac{1}{e} \right| \right) - \left[\sqrt{2} - \ln(1 + \sqrt{2}) \right] = \sqrt{1 + e^2} - \ln \left(\frac{\sqrt{1 + e^2}}{e} + \frac{1}{e} \right) - \sqrt{2} + \ln(1 + \sqrt{2})
 \end{aligned}$$

$$\begin{aligned}
 24. \quad y = \ln x \Rightarrow 1 + \left(\frac{dx}{dy} \right)^2 &= 1 + x^2 \Rightarrow S = 2\pi \int_c^d x \sqrt{1 + x^2} dy \Rightarrow S = 2\pi \int_0^1 e^y \sqrt{1 + e^{2y}} dy; \\
 \begin{cases} u = e^y \\ du = e^y dy \end{cases} \rightarrow S &= 2\pi \int_1^e \sqrt{1 + u^2} du; \quad \begin{cases} u = \tan \theta \\ du = \sec^2 \theta d\theta \end{cases} \rightarrow 2\pi \int_{\pi/4}^{\tan^{-1} e} \sec \theta \cdot \sec^2 \theta d\theta \\
 &= 2\pi \left(\frac{1}{2} \right) [\sec \theta \tan \theta + \ln |\sec \theta + \tan \theta|]_{\pi/4}^{\tan^{-1} e} = \pi \left[\left(\sqrt{1 + e^2} \right) e + \ln \left| \sqrt{1 + e^2} + e \right| \right] - \pi \left[\sqrt{2} \cdot 1 + \ln(\sqrt{2} + 1) \right] \\
 &= \pi \left[e \sqrt{1 + e^2} + \ln \left(\frac{\sqrt{1 + e^2} + e}{\sqrt{2} + 1} \right) - \sqrt{2} \right]
 \end{aligned}$$

$$\begin{aligned}
 25. \quad S &= 2\pi \int_{-1}^1 f(x) \sqrt{1 + [f'(x)]^2} \, dx; \quad f(x) = (1 - x^{2/3})^{3/2} \Rightarrow [f'(x)]^2 + 1 = \frac{1}{x^{2/3}} \Rightarrow S = 2\pi \int_{-1}^1 (1 - x^{2/3})^{3/2} \cdot \frac{dx}{\sqrt{x^{2/3}}} \\
 &= 4\pi \int_0^1 (1 - x^{2/3})^{3/2} \left(\frac{1}{x^{1/3}}\right) dx; \quad \begin{cases} u = x^{2/3} \\ du = \frac{2}{3} \frac{dx}{x^{1/3}} \end{cases} \rightarrow 4 \cdot \frac{3}{2} \pi \int_0^1 (1 - u)^{3/2} du = -6\pi \int_0^1 (1 - u)^{3/2} (-1) du \\
 &= -6\pi \cdot \frac{2}{5} \left[(1 - u)^{5/2} \right]_0^1 = \frac{12\pi}{5}
 \end{aligned}$$

$$\begin{aligned}
 26. \quad y &= \int_1^x \sqrt{\sqrt{t} - 1} \, dt \Rightarrow \frac{dy}{dx} = \sqrt{\sqrt{x} - 1} \Rightarrow L = \int_1^{16} \sqrt{1 + (\sqrt{\sqrt{x} - 1})^2} \, dx = \int_1^{16} \sqrt{1 + \sqrt{x} - 1} \, dx = \int_1^{16} \sqrt[4]{x} \, dx = \left[\frac{4}{5} x^{5/4} \right]_1^{16} \\
 &= \frac{4}{5} (16)^{5/4} - \frac{4}{5} (1)^{5/4} = \frac{124}{5}
 \end{aligned}$$

$$\begin{aligned}
 27. \quad \int_1^\infty \left(\frac{ax}{x^2+1} - \frac{1}{2x} \right) dx &= \lim_{b \rightarrow \infty} \int_1^b \left(\frac{ax}{x^2+1} - \frac{1}{2x} \right) dx = \lim_{b \rightarrow \infty} \left[\frac{a}{2} \ln(x^2+1) - \frac{1}{2} \ln x \right]_1^b = \lim_{b \rightarrow \infty} \left[\frac{1}{2} \ln \frac{(x^2+1)^a}{x} \right]_1^b \\
 &= \lim_{b \rightarrow \infty} \frac{1}{2} \left[\ln \frac{(b^2+1)^a}{b} - \ln 2^a \right]; \quad \lim_{b \rightarrow \infty} \frac{(b^2+1)^a}{b} > \lim_{b \rightarrow \infty} \frac{b^{2a}}{b} = \lim_{b \rightarrow \infty} b^{2(a-\frac{1}{2})} = \infty \text{ if } a > \frac{1}{2} \Rightarrow \text{the improper integral}
 \end{aligned}$$

diverges if $a > \frac{1}{2}$; for $a = \frac{1}{2}$: $\lim_{b \rightarrow \infty} \frac{\sqrt{b^2+1}}{b} = \lim_{b \rightarrow \infty} \sqrt{1 + \frac{1}{b^2}} = 1 \Rightarrow \lim_{b \rightarrow \infty} \frac{1}{2} \left[\ln \frac{(b^2+1)^{1/2}}{b} - \ln 2^{1/2} \right]$

$$= \frac{1}{2} \left(\ln 1 - \frac{1}{2} \ln 2 \right) = -\frac{\ln 2}{4}; \text{ if } a < \frac{1}{2}: \quad 0 \leq \lim_{b \rightarrow \infty} \frac{(b^2+1)^a}{b} < \lim_{b \rightarrow \infty} \frac{(b+1)^{2a}}{b+1} = \lim_{b \rightarrow \infty} (b+1)^{2a-1} = 0$$

$$\Rightarrow \lim_{b \rightarrow \infty} \ln \frac{(b^2+1)^a}{b} = -\infty \Rightarrow \text{the improper integral diverges if } a < \frac{1}{2}; \text{ in summary, the improper integral}$$

$$\int_1^\infty \left(\frac{ax}{x^2+1} - \frac{1}{2x} \right) dx \text{ converges only when } a = \frac{1}{2} \text{ and has the value } -\frac{\ln 2}{4}$$

$$28. \quad G(x) = \lim_{b \rightarrow \infty} \int_0^b e^{-xt} \, dt = \lim_{b \rightarrow \infty} \left[-\frac{1}{x} e^{-xt} \right]_0^b = \lim_{b \rightarrow \infty} \left(\frac{1 - e^{-xb}}{x} \right) = \frac{1-0}{x} = \frac{1}{x} \text{ if } x > 0 \Rightarrow xG(x) = x \left(\frac{1}{x} \right) = 1 \text{ if } x > 0$$

29. $A = \int_1^\infty \frac{dx}{x^p}$ converges if $p > 1$ and diverges if $p \leq 1$. Thus, $p \leq 1$ for infinite area. The volume of the solid of revolution about the x -axis is $V = \int_1^\infty \pi \left(\frac{1}{x^p} \right)^2 dx = \pi \int_1^\infty \frac{dx}{x^{2p}}$ which converges if $2p > 1$ and diverges if $2p \leq 1$. Thus we want $p > \frac{1}{2}$ for finite volume. In conclusion, the curve $y = x^{-p}$ gives infinite area and finite volume for values of p satisfying $\frac{1}{2} < p \leq 1$.

30. The area is given by the integral $A = \int_0^1 \frac{dx}{x^p}$;

$$p = 1: A = \lim_{b \rightarrow 0^+} [\ln x]_b^1 = -\lim_{b \rightarrow 0^+} \ln b = \infty, \text{ diverges;}$$

$$p > 1: A = \lim_{b \rightarrow 0^+} [x^{1-p}]_b^1 = 1 - \lim_{b \rightarrow 0^+} b^{1-p} = -\infty, \text{ diverges;}$$

$$p < 1: A = \lim_{b \rightarrow 0^+} [x^{1-p}]_b^1 = 1 - \lim_{b \rightarrow 0^+} b^{1-p} = 1 - 0, \text{ converges; thus, } p \geq 1 \text{ for infinite area.}$$

The volume of the solid of revolution about the x -axis is $V_x = \pi \int_0^1 \frac{dx}{x^{2p}}$ which converges if $2p < 1$ or $p < \frac{1}{2}$, and diverges if $p \geq \frac{1}{2}$. Thus, V_x is infinite whenever the area is infinite ($p \geq 1$). The volume of the solid of

revolution about the y -axis is $V_y = \pi \int_1^\infty [R(y)]^2 dy = \pi \int_1^\infty \frac{dy}{y^{2/p}}$ which converges if $\frac{2}{p} > 1 \Leftrightarrow p < 2$ (see

Exercise 29). In conclusion, the curve $y = x^{-p}$ gives infinite area and finite volume for values of p satisfying $1 \leq p < 2$, as described above.

31. See the generalization proved in 32.

$$\begin{aligned} 32. \quad 0 &\leq \int_0^a \left(f'(x) + x - \frac{a}{2} \right) dx \\ &= \int_0^a (f'(x))^2 dx + \int_0^a (2x - a)f'(x) dx + \int_0^a \left(x - \frac{a}{2} \right)^2 dx \end{aligned}$$

$$\text{The last integral is } \frac{1}{3} \left(x - \frac{a}{2} \right)^3 \Big|_0^a = \frac{a^3}{12}.$$

Using integration by parts with $u = 2x - a$, $du = 2dx$, $dv = f'(x)$, $v = f(x)$, and the fact that

$$f(a) = f(0) = b, \text{ the second integral is } (2x - a)f(x) \Big|_0^a - 2 \int_0^a f(x) dx = 2ab - 2 \int_0^a f(x) dx. \text{ Thus}$$

$$\int_0^a (f'(x))^2 dx \geq 2 \int_0^a f(x) dx - \left(2ab + \frac{a^3}{12} \right).$$

$$\begin{array}{l} 33. \quad e^{2x} \xrightarrow{(+)} \cos 3x \\ \quad \quad 2e^{2x} \xrightarrow{(-)} \frac{1}{3} \sin 3x \\ \quad \quad 4e^{2x} \xrightarrow{(+)} -\frac{1}{9} \cos 3x \end{array}$$

$$I = \frac{e^{2x}}{3} \sin 3x + \frac{2e^{2x}}{9} \cos 3x - \frac{4}{9} I \Rightarrow \frac{13}{9} I = \frac{e^{2x}}{9} (3 \sin 3x + 2 \cos 3x) \Rightarrow I = \frac{e^{2x}}{13} (3 \sin 3x + 2 \cos 3x) + C$$

$$\begin{array}{l}
 34. \quad e^{3x} \xrightarrow{(+)} \sin 4x \\
 \quad \quad 3e^{3x} \xrightarrow{(-)} -\frac{1}{4} \cos 4x \\
 \quad \quad 9e^{3x} \xrightarrow{(+)} -\frac{1}{16} \sin 4x
 \end{array}$$

$$I = -\frac{e^{3x}}{4} \cos 4x + \frac{3e^{3x}}{16} \sin 4x - \frac{9}{16} I \Rightarrow \frac{25}{16} I = \frac{e^{3x}}{16} (3 \sin 4x - 4 \cos 4x) \Rightarrow I = \frac{e^{3x}}{25} (3 \sin 4x - 4 \cos 4x) + C$$

$$\begin{array}{l}
 35. \quad \sin 3x \xrightarrow{(+)} \sin x \\
 \quad \quad 3 \cos 3x \xrightarrow{(-)} -\cos x \\
 \quad \quad -9 \sin 3x \xrightarrow{(+)} -\sin x
 \end{array}$$

$$I = -\sin 3x \cos x + 3 \cos 3x \sin x + 9I \Rightarrow -8I = -\sin 3x \cos x + 3 \cos 3x \sin x \Rightarrow I = \frac{\sin 3x \cos x - 3 \cos 3x \sin x}{8} + C$$

$$\begin{array}{l}
 36. \quad \cos 5x \xrightarrow{(+)} \sin 4x \\
 \quad \quad -5 \sin 5x \xrightarrow{(-)} -\frac{1}{4} \cos 4x \\
 \quad \quad -25 \cos 5x \xrightarrow{(+)} -\frac{1}{16} \sin 4x
 \end{array}$$

$$\begin{aligned}
 I &= -\frac{1}{4} \cos 5x \cos 4x - \frac{5}{16} \sin 5x \sin 4x + \frac{25}{16} I \Rightarrow -\frac{9}{16} I = -\frac{1}{4} \cos 5x \cos 4x - \frac{5}{16} \sin 5x \sin 4x \\
 &\Rightarrow I = \frac{1}{9} (4 \cos 5x \cos 4x + 5 \sin 5x \sin 4x) + C
 \end{aligned}$$

$$\begin{array}{l}
 37. \quad e^{ax} \xrightarrow{(+)} \sin bx \\
 \quad \quad ae^{ax} \xrightarrow{(-)} -\frac{1}{b} \cos bx \\
 \quad \quad a^2 e^{ax} \xrightarrow{(+)} -\frac{1}{b^2} \sin bx
 \end{array}$$

$$I = -\frac{e^{ax}}{b} \cos bx + \frac{ae^{ax}}{b^2} \sin bx - \frac{a^2}{b^2} I \Rightarrow \left(\frac{a^2+b^2}{b^2}\right) I = \frac{e^{ax}}{b^2} (a \sin bx - b \cos bx) \Rightarrow I = \frac{e^{ax}}{a^2+b^2} (a \sin bx - b \cos bx) + C$$

$$\begin{array}{l}
 38. \quad e^{ax} \xrightarrow{(+)} \cos bx \\
 \quad \quad ae^{ax} \xrightarrow{(-)} \frac{1}{b} \sin bx \\
 \quad \quad a^2 e^{ax} \xrightarrow{(+)} -\frac{1}{b^2} \cos bx
 \end{array}$$

$$I = \frac{e^{ax}}{b} \sin bx + \frac{ae^{ax}}{b^2} \cos bx - \frac{a^2}{b^2} I \Rightarrow \left(\frac{a^2+b^2}{b^2}\right) I = \frac{e^{ax}}{b^2} (a \cos bx + b \sin bx) \Rightarrow I = \frac{e^{ax}}{a^2+b^2} (a \cos bx + b \sin bx) + C$$

$$\begin{array}{l}
 39. \quad \ln(ax) \xrightarrow{(+)} 1 \\
 \quad \quad \frac{1}{x} \xrightarrow{(-)} x
 \end{array}$$

$$I = x \ln(ax) - \int \left(\frac{1}{x}\right) x dx = x \ln(ax) - x + C$$

$$40. \ln(ax) \quad (+) \quad x^2$$

$$\frac{1}{x} \quad \xrightarrow{(-)} \quad \frac{1}{3}x^3$$

$$I = \frac{1}{3}x^3 \ln(ax) - \int \left(\frac{1}{x}\right) \left(\frac{x^3}{3}\right) dx = \frac{1}{3}x^3 \ln(ax) - \frac{1}{9}x^3 + C$$

$$41. \int \frac{dx}{1-\sin x} = \int \frac{\left(\frac{2dz}{1+z^2}\right)}{1-\left(\frac{2z}{1+z^2}\right)} = \int \frac{2 dz}{(1-z)^2} = \frac{2}{1-z} + C = \frac{2}{1-\tan\left(\frac{x}{2}\right)} + C$$

$$42. \int \frac{dx}{1+\sin x+\cos x} = \int \frac{\left(\frac{2dz}{1+z^2}\right)}{1+\left(\frac{2z}{1+z^2}\right)+\left(\frac{1-z^2}{1+z^2}\right)} = \int \frac{2 dz}{1+z^2+2z+1-z^2} = \int \frac{dz}{1+z} = \ln|1+z| + C = \ln\left|\tan\left(\frac{x}{2}\right)+1\right| + C$$

$$43. \int_0^{\pi/2} \frac{dx}{1+\sin x} = \int_0^1 \frac{\left(\frac{2dz}{1+z^2}\right)}{1+\left(\frac{2z}{1+z^2}\right)} = \int_0^1 \frac{2 dz}{(1+z)^2} = -\left[\frac{2}{1+z}\right]_0^1 = -(1-2) = 1$$

$$44. \int_{\pi/3}^{\pi/2} \frac{dx}{1-\cos x} = \int_{1/\sqrt{3}}^1 \frac{\left(\frac{2dz}{1+z^2}\right)}{1-\left(\frac{1-z^2}{1+z^2}\right)} = \int_{1/\sqrt{3}}^1 \frac{dz}{z^2} = \left[-\frac{1}{z}\right]_{1/\sqrt{3}}^1 = \sqrt{3}-1$$

$$45. \int_0^{\pi/2} \frac{d\theta}{2+\cos\theta} = \int_0^1 \frac{\left(\frac{2 dz}{1+z^2}\right)}{2+\left(\frac{1-z^2}{1+z^2}\right)} = \int_0^1 \frac{2 dz}{2+2z^2+1-z^2} = \int_0^1 \frac{2 dz}{z^2+3} = \frac{2}{\sqrt{3}} \left[\tan^{-1} \frac{z}{\sqrt{3}}\right]_0^1 = \frac{2}{\sqrt{3}} \tan^{-1} \frac{1}{\sqrt{3}} = \frac{\pi}{3\sqrt{3}} = \frac{\sqrt{3}\pi}{9}$$

$$46. \int_{\pi/2}^{2\pi/3} \frac{\cos\theta d\theta}{\sin\theta\cos\theta+\sin\theta} = \int_1^{\sqrt{3}} \frac{\left(\frac{1-z^2}{1+z^2}\right)\left(\frac{2 dz}{1+z^2}\right)}{\left[\frac{2z(1-z^2)}{(1+z^2)^2} + \left(\frac{2z}{1+z^2}\right)\right]} = \int_1^{\sqrt{3}} \frac{2(1-z^2) dz}{2z-2z^3+2z+2z^3} = \int_1^{\sqrt{3}} \frac{1-z^2}{2z} dz = \left[\frac{1}{2} \ln z - \frac{z^2}{4}\right]_1^{\sqrt{3}}$$

$$= \left(\frac{1}{2} \ln \sqrt{3} - \frac{3}{4}\right) - \left(0 - \frac{1}{4}\right) = \frac{\ln 3}{4} - \frac{1}{2} = \frac{1}{4}(\ln 3 - 2) = \frac{1}{2}(\ln \sqrt{3} - 1)$$

$$47. \int \frac{dt}{\sin t - \cos t} = \int \frac{\left(\frac{2dz}{1+z^2}\right)}{\left(\frac{2z}{1+z^2} - \frac{1-z^2}{1+z^2}\right)} = \int \frac{2dz}{2z-1+z^2} = \int \frac{2dz}{(z+1)^2-2} = \frac{1}{\sqrt{2}} \ln \left| \frac{z+1-\sqrt{2}}{z+1+\sqrt{2}} \right| + C = \frac{1}{\sqrt{2}} \ln \left| \frac{\tan\left(\frac{t}{2}\right)+1-\sqrt{2}}{\tan\left(\frac{t}{2}\right)+1+\sqrt{2}} \right| + C$$

$$48. \int \frac{\cos t dt}{1-\cos t} = \int \frac{\left(\frac{1-z^2}{1+z^2}\right)\left(\frac{2dz}{1+z^2}\right)}{1-\left(\frac{1-z^2}{1+z^2}\right)} = \int \frac{2(1-z^2) dz}{(1+z^2)^2 - (1-z^2)(1-z^2)} = \int \frac{2(1-z^2) dz}{(1+z^2)(1+z^2-1+z^2)} = \int \frac{(1-z^2) dz}{(1+z^2)z^2} = \int \frac{dz}{z^2(1+z^2)} - \int \frac{dz}{1+z^2}$$

$$= \int \frac{dz}{z^2} - 2 \int \frac{dz}{z^2+1} = -\frac{1}{z} - 2 \tan^{-1} z + C = -\cot\left(\frac{t}{2}\right) - t + C$$

$$49. \int \sec\theta d\theta = \int \frac{d\theta}{\cos\theta} = \int \frac{\left(\frac{2 dz}{1+z^2}\right)}{\left(\frac{1-z^2}{1+z^2}\right)} = \int \frac{2 dz}{1-z^2} = \int \frac{2dz}{(1+z)(1-z)} = \int \frac{dz}{1+z} + \int \frac{dz}{1-z} = \ln|1+z| - \ln|1-z| + C = \ln \left| \frac{1+\tan\left(\frac{\theta}{2}\right)}{1-\tan\left(\frac{\theta}{2}\right)} \right| + C$$

$$50. \int \csc\theta d\theta = \int \frac{d\theta}{\sin\theta} = \int \frac{\left(\frac{2 dz}{1+z^2}\right)}{\left(\frac{2z}{1+z^2}\right)} = \int \frac{dz}{z} = \ln|z| + C = \ln \left| \tan \frac{\theta}{2} \right| + C$$

51. (a) $\Gamma(1) = \int_0^\infty e^{-t} dt = \lim_{b \rightarrow \infty} \int_0^b e^{-t} dt = \lim_{b \rightarrow \infty} [-e^{-t}]_0^b = \lim_{b \rightarrow \infty} \left[-\frac{1}{e^b} - (-1)\right] = 0 + 1 = 1$
- (b) $u = t^x, du = xt^{x-1} dt; dv = e^{-t} dt, v = -e^{-t}; x = \text{fixed positive real}$
 $\Rightarrow \Gamma(x+1) = \int_0^\infty t^x e^{-t} dt = \lim_{b \rightarrow \infty} [-t^x e^{-t}]_0^b + x \int_0^\infty t^{x-1} e^{-t} dt = \lim_{b \rightarrow \infty} \left(-\frac{b^x}{e^b} + 0^x e^0\right) + x\Gamma(x) = x\Gamma(x)$
- (c) $\Gamma(n+1) = n\Gamma(n) = n!$:
 $n = 0: \Gamma(0+1) = \Gamma(1) = 0!$;
 $n = k: \text{Assume } \Gamma(k+1) = k! \quad \text{for some } k > 0;$
 $n = k+1: \Gamma(k+1+1) = (k+1)\Gamma(k+1) \quad \text{from part (b)}$
 $\quad \quad \quad = (k+1)k! \quad \text{induction hypothesis}$
 $\quad \quad \quad = (k+1)! \quad \text{definition of factorial}$

Thus, $\Gamma(n+1) = n\Gamma(n) = n!$ for every positive integer n .

52. (a) $\Gamma(x) \approx \left(\frac{x}{e}\right)^x \sqrt{\frac{2\pi}{x}}$ and $n\Gamma(n) = n! \Rightarrow n! \approx n\left(\frac{n}{e}\right)^n \sqrt{\frac{2\pi}{n}} = \left(\frac{n}{e}\right)^n \sqrt{2n\pi}$

(b)

n	$\left(\frac{n}{e}\right)^n \sqrt{2n\pi}$	calculator
10	3598695.619	3628800
20	2.4227868×10^{18}	2.432902×10^{18}
30	2.6451710×10^{32}	2.652528×10^{32}
40	8.1421726×10^{47}	8.1591528×10^{47}
50	3.0363446×10^{64}	3.0414093×10^{64}
60	8.3094383×10^{81}	8.3209871×10^{81}

(c)

n	$\left(\frac{n}{e}\right)^n \sqrt{2n\pi}$	$\left(\frac{n}{e}\right)^n \sqrt{2n\pi} e^{1/12n}$	calculator
10	3598695.619	3628810.051	3628800

CHAPTER 9 FIRST-ORDER DIFFERENTIAL EQUATIONS

9.1 SOLUTIONS, SLOPE FIELDS AND EULER'S METHOD

- $y' = x + y \Rightarrow$ slope of 0 for the line $y = -x$.
 For $x, y > 0$, $y' = x + y \Rightarrow$ slope > 0 in Quadrant I.
 For $x, y < 0$, $y' = x + y \Rightarrow$ slope < 0 in Quadrant III.
 For $|y| > |x|$, $y > 0, x < 0$, $y' = x + y \Rightarrow$ slope > 0 in Quadrant II above $y = -x$.
 For $|y| < |x|$, $y > 0, x < 0$, $y' = x + y \Rightarrow$ slope < 0 in Quadrant II below $y = -x$.
 For $|y| < |x|$, $x > 0, y < 0$, $y' = x + y \Rightarrow$ slope > 0 in Quadrant IV above $y = -x$.
 For $|y| > |x|$, $x > 0, y < 0$, $y' = x + y \Rightarrow$ slope < 0 in Quadrant IV below $y = -x$.
 All of the conditions are seen in slope field (d).

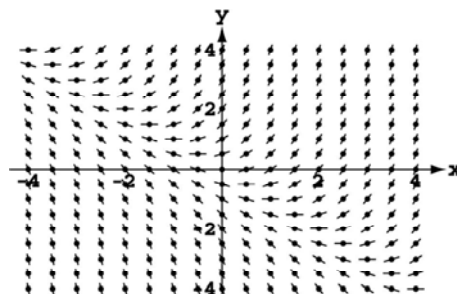

- $y' = y + 1 \Rightarrow$ slope is constant for a given value of y , slope is 0 for $y = -1$, slope is positive for $y > -1$ and negative for $y < -1$. These characteristics are evident in slope field (c)

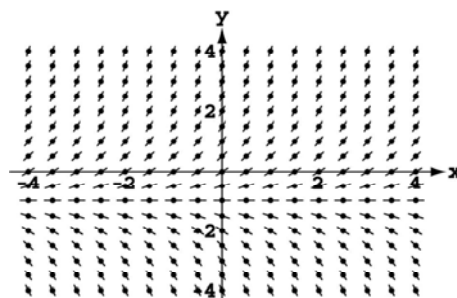

- $y' = -\frac{x}{y} \Rightarrow$ slope = 1 on $y = -x$ and -1 on $y = x$. $y' = -\frac{x}{y} \Rightarrow$ slope = 0 on the y -axis, excluding $(0, 0)$, and is undefined on the x -axis. Slopes are positive for $x > 0, y < 0$ and $x < 0, y > 0$ (Quadrants II and IV), otherwise negative. Field (a) is consistent with these conditions.

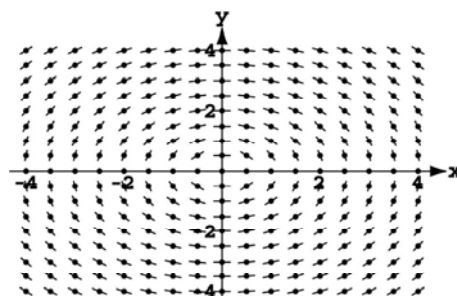

- $y' = y^2 - x^2 \Rightarrow$ slope is 0 for $y = x$ and for $y = -x$. For $|y| > |x|$ slope is positive and for $|y| < |x|$ slope is negative. Field (b) has these characteristics.

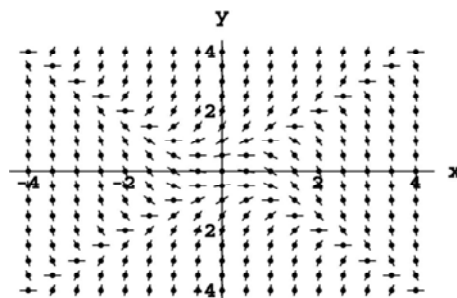

5.

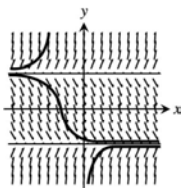

6.

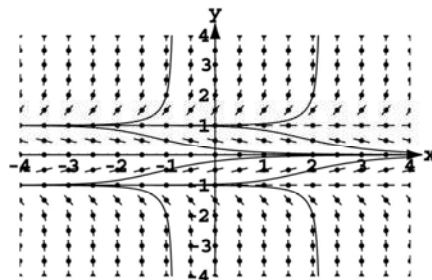

7. $y = -1 + \int_1^x (t - y(t)) dt \Rightarrow \frac{dy}{dx} = x - y(x); y(1) = -1 + \int_1^1 (t - y(t)) dt = -1; \frac{dy}{dx} = x - y, y(1) = -1$

8. $y = \int_1^x \frac{1}{t} dt \Rightarrow \frac{dy}{dx} = \frac{1}{x}; y(1) = \int_1^1 \frac{1}{t} dt = 0; \frac{dy}{dx} = \frac{1}{x}, y(1) = 0$

9. $y = 2 - \int_0^x (1 + y(t)) \sin t dt \Rightarrow \frac{dy}{dx} = -(1 + y(x)) \sin x; y(0) = 2 - \int_0^0 (1 + y(t)) \sin t dt = 2; \frac{dy}{dx} = -(1 + y) \sin x, y(0) = 2$

10. $y = 1 + \int_0^x y(t) dt \Rightarrow \frac{dy}{dx} = y(x); y(0) = 1 + \int_0^0 y(t) dt = 1; \frac{dy}{dx} = y, y(0) = 1$

11. $y_1 = y_0 + \left(1 - \frac{y_0}{x_0}\right) dx = -1 + \left(1 - \frac{-1}{.5}\right)(.5) = -0.25,$

$y_2 = y_1 + \left(1 - \frac{y_1}{x_1}\right) dx = -0.25 + \left(1 - \frac{-0.25}{2.5}\right)(.5) = 0.3,$

$y_3 = y_2 + \left(1 - \frac{y_2}{x_2}\right) dx = 0.3 + \left(1 - \frac{0.3}{3}\right)(.5) = 0.75;$

$\frac{dy}{dx} + \left(\frac{1}{x}\right)y = 1 \Rightarrow P(x) = \frac{1}{x}, Q(x) = 1 \Rightarrow \int P(x) dx = \int \frac{1}{x} dx = \ln|x| = \ln x, x > 0 \Rightarrow v(x) = e^{\ln x} = x$

$\Rightarrow y = \frac{1}{x} \int x \cdot 1 dx = \frac{1}{x} \left(\frac{x^2}{2} + C\right); x = 2, y = -1 \Rightarrow -1 = 1 + \frac{C}{2} \Rightarrow C = -4 \Rightarrow y = \frac{x}{2} - \frac{4}{x}$

$\Rightarrow y(3.5) = \frac{3.5}{2} - \frac{4}{3.5} = \frac{4.25}{7} \approx 0.6071$

12. $y_1 = y_0 + x_0(1 - y_0) dx = 0 + 1(1 - 0)(.2) = .2,$

$y_2 = y_1 + x_1(1 - y_1) dx = .2 + 1.2(1 - .2)(.2) = .392,$

$y_3 = y_2 + x_2(1 - y_2) dx = .392 + 1.4(1 - .392)(.2) = .5622;$

$\frac{dy}{1-y} = x dx \Rightarrow -\ln|1-y| = \frac{x^2}{2} + C; x = 1, y = 0 \Rightarrow -\ln 1 = \frac{1}{2} + C \Rightarrow C = -\frac{1}{2} \Rightarrow \ln|1-y| = -\frac{x^2}{2} + \frac{1}{2}$

$\Rightarrow y = 1 - e^{(1-x^2)/2} \Rightarrow y(1.6) \approx .5416$

13. $y_1 = y_0 + (2x_0y_0 + 2y_0) dx = 3 + [2(0)(3) + 2(3)](.2) = 4.2,$

$y_2 = y_1 + (2x_1y_1 + 2y_1) dx = 4.2 + [2(.2)(4.2) + 2(4.2)](.2) = 6.216,$

$y_3 = y_2 + (2x_2y_2 + 2y_2) dx = 6.216 + [2(.4)(6.216) + 2(6.216)](.2) = 9.6969;$

$\frac{dy}{dx} = 2y(x+1) \Rightarrow \frac{dy}{y} = 2(x+1) dx \Rightarrow \ln|y| = (x+1)^2 + C; x = 0, y = 3 \Rightarrow \ln 3 = 1 + C \Rightarrow C = \ln 3 - 1$

$\Rightarrow \ln y = (x+1)^2 + \ln 3 - 1 \Rightarrow y = e^{(x+1)^2 + \ln 3 - 1} = e^{\ln 3} e^{x^2 + 2x} = 3e^{x(x+2)} \Rightarrow y(.6) \approx 14.2765$

14. $y_1 = y_0 + y_0^2(1 + 2x_0) dx = 1 + 1^2[1 + 2(-1)](.5) = .5,$
 $y_2 = y_1 + y_1^2(1 + 2x_1) dx = .5 + (.5)^2[1 + 2(-.5)](.5) = .5,$
 $y_3 = y_2 + y_2^2(1 + 2x_2) dx = .5 + (.5)^2[1 + 2(0)](.5) = .625;$
 $\frac{dy}{y^2} = (1 + 2x) dx \Rightarrow -\frac{1}{y} = x + x^2 + C; \quad x = -1, y = 1 \Rightarrow -1 = -1 + (-1)^2 + C \Rightarrow C = -1 \Rightarrow \frac{1}{y} = 1 - x - x^2$
 $\Rightarrow y = \frac{1}{1 - x - x^2} \Rightarrow y(.5) = \frac{1}{1 - .5 - (.5)^2} = 4$
15. $y_1 = y_0 + 2x_0 e^{x_0^2} dx = 2 + 2(0)(.1) = 2,$
 $y_2 = y_1 + 2x_1 e^{x_1^2} dx = 2 + 2(.1)e^{(.1)^2} (.1) = 2.0202,$
 $y_3 = y_2 + 2x_2 e^{x_2^2} dx = 2.0202 + 2(.2)e^{(.2)^2} (.1) = 2.0618,$
 $dy = 2xe^{x^2} dx \Rightarrow y = e^{x^2} + C; \quad y(0) = 2 \Rightarrow 2 = 1 + C \Rightarrow C = 1 \Rightarrow y = e^{x^2} + 1 \Rightarrow y(.3) = e^{(.3)^2} + 1 \approx 2.0942$
16. $y_1 = y_0 + (y_0 e^{x_0}) dx = 2 + (2 \cdot e^0)(.5) = 3,$
 $y_2 = y_1 + (y_1 e^{x_1}) dx = 3 + (3 \cdot e^{.5})(.5) = 5.47308,$
 $y_3 = y_2 + (y_2 e^{x_2}) dx = 5.47308 + (5.47308 \cdot e^{1.0})(.5) = 12.9118,$
 $\frac{dy}{dx} = ye^x \Rightarrow \frac{dy}{y} = e^x dx \Rightarrow \ln|y| = e^x + C; \quad x = 0, y = 2 \Rightarrow \ln 2 = 1 + C \Rightarrow C = \ln 2 - 1 \Rightarrow \ln|y| = e^x + \ln 2 - 1$
 $\Rightarrow y = 2e^{e^x - 1} \Rightarrow y(1.5) = 2e^{e^{1.5} - 1} \approx 65.0292$
17. $y_1 = 1 + 1(.2) = 1.2,$
 $y_2 = 1.2 + (1.2)(.2) = 1.44,$
 $y_3 = 1.44 + (1.44)(.2) = 1.728,$
 $y_4 = 1.728 + (1.728)(.2) = 2.0736,$
 $y_5 = 2.0736 + (2.0736)(.2) = 2.48832;$
 $\frac{dy}{y} = dx \Rightarrow \ln y = x + C_1 \Rightarrow y = Ce^x; \quad y(0) = 1 \Rightarrow 1 = Ce^0 \Rightarrow C = 1 \Rightarrow y = e^x \Rightarrow y(1) = e \approx 2.7183$
18. $y_1 = 2 + \left(\frac{2}{1}\right)(.2) = 2.4,$
 $y_2 = 2.4 + \left(\frac{2.4}{1.2}\right)(.2) = 2.8,$
 $y_3 = 2.8 + \left(\frac{2.8}{1.4}\right)(.2) = 3.2,$
 $y_4 = 3.2 + \left(\frac{3.2}{1.6}\right)(.2) = 3.6,$
 $y_5 = 3.6 + \left(\frac{3.6}{1.8}\right)(.2) = 4;$
 $\frac{dy}{y} = \frac{dx}{x} \Rightarrow \ln y = \ln x + C \Rightarrow y = kx; \quad y(1) = 2 \Rightarrow 2 = k \Rightarrow y = 2x \Rightarrow y(2) = 4$
19. $y_1 = -1 + \left[\frac{(-1)^2}{\sqrt{1}}\right](.5) = -.5,$
 $y_2 = -.5 + \left[\frac{(-.5)^2}{\sqrt{1.5}}\right](.5) = -.39794,$

$$y_3 = -0.39794 + \left[\frac{(-0.39794)^2}{\sqrt{2}} \right] (0.5) = -0.34195,$$

$$y_4 = -0.34195 + \left[\frac{(-0.34195)^2}{\sqrt{2.5}} \right] (0.5) = -0.30497,$$

$$y_5 = -0.27812, y_6 = -0.25745, y_7 = -0.24088, y_8 = -0.2272;$$

$$\frac{dy}{y^2} = \frac{dx}{\sqrt{x}} \Rightarrow -\frac{1}{y} = 2\sqrt{x} + C; \quad y(1) = -1 \Rightarrow 1 = 2 + C \Rightarrow C = -1 \Rightarrow y = \frac{1}{1-2\sqrt{x}} \Rightarrow y(5) = \frac{1}{1-2\sqrt{5}} \approx -0.2880$$

$$20. \quad y_1 = 1 + (0 \cdot \sin 1) \left(\frac{1}{3} \right) = 1,$$

$$y_2 = 1 + \left(\frac{1}{3} \cdot \sin 1 \right) \left(\frac{1}{3} \right) = 1.09350,$$

$$y_3 = 1.09350 + \left(\frac{2}{3} \cdot \sin 1.09350 \right) \left(\frac{1}{3} \right) = 1.29089,$$

$$y_4 = 1.29089 + \left(\frac{3}{3} \cdot \sin 1.29089 \right) \left(\frac{1}{3} \right) = 1.61125,$$

$$y_5 = 1.61125 + \left(\frac{4}{3} \cdot \sin 1.61125 \right) \left(\frac{1}{3} \right) = 2.05533,$$

$$y_6 = 2.05533 + \left(\frac{5}{3} \cdot \sin 2.05533 \right) \left(\frac{1}{3} \right) = 2.54694;$$

$$y' = x \sin y \Rightarrow \csc y \, dy = x \, dx \Rightarrow -\ln |\csc y + \cot y| = \frac{1}{2}x^2 + C \Rightarrow \csc y + \cot y = e^{-\frac{1}{2}x^2 + C} = Ce^{-\frac{1}{2}x^2}$$

$$\Rightarrow \frac{1 + \cos y}{\sin y} = Ce^{-\frac{1}{2}x^2} \Rightarrow \cot \left(\frac{y}{2} \right) = Ce^{-\frac{1}{2}x^2}; \quad y(0) = 1 \Rightarrow \cot \left(\frac{1}{2} \right) = Ce^0 = C \Rightarrow \cot \left(\frac{y}{2} \right) = \cot \left(\frac{1}{2} \right) e^{-\frac{1}{2}x^2}$$

$$\Rightarrow y = 2 \cot^{-1} \left(\cot \left(\frac{1}{2} \right) e^{-\frac{1}{2}x^2} \right), \quad y(2) = 2 \cot^{-1} \left(\cot \left(\frac{1}{2} \right) e^{-2} \right) = 2.65591$$

$$21. \quad y = -1 - x + (1 + x_0 + y_0) e^{x-x_0} \Rightarrow y(x_0) = -1 - x_0 + (1 + x_0 + y_0) e^{x_0-x_0} = -1 - x_0 + (1 + x_0 + y_0)(1) = y_0$$

$$\frac{dy}{dx} = -1 + (1 + x_0 + y_0) e^{x-x_0} \Rightarrow y = -1 - x + (1 + x_0 + y_0) e^{x-x_0} = \frac{dy}{dx} - x \Rightarrow \frac{dy}{dx} = x + y$$

$$22. \quad y' = f(x), \quad y(x_0) = y_0 \Rightarrow y = \int_{x_0}^x f(t) \, dt + C, \quad y(x_0) = \int_{x_0}^{x_0} f(t) \, dt + C = C \Rightarrow C = y_0 \Rightarrow y = \int_{x_0}^x f(t) \, dt + y_0$$

23-34. Example CAS commands:

Maple:

```
ode := diff( y(x), x ) = y(x);
```

```
icA := [0,1];
```

```
icB := [0, 2];
```

```
icC := [0, -1];
```

```
DEplot( ode, y(x), x=0..2, [icA,icB,icC], arrows=slim, linecolor=blue, title="#23 (Section 9.1)");
```

Mathematica:

To plot vector fields, you must begin by loading a graphics package.

```
<<Graphics`PlotField`
```

To control lengths and appearance of vectors, select the Help browser, type PlotVectorField and select Go.

```
Clear[x, y, f]
```

```
yprime = y (2 - y);
```



```
pv = PlotVectorField[{1, yprime}, {x, -5, 5}, {y, -4, 6}, Axes -> True, AxesLabel -> {x, y}];
```

To draw solution curves with Mathematica, you must first solve the differential equation. This will be done with the DSolve command. The $y[x]$ and x at the end of the command specify the dependent and independent variables. The command will not work unless the y in the differential equation is referenced as $y[x]$.

```
equation = y'[x]==y[x] (2 - y[x]);
initcond = y[a] == b;
sols = DSolve[{equation, initcond}, y[x], x]
vals = {{0, 1/2}, {0, 3/2}, {0, 2}, {0, 3}}
f[{a_, b_}] = sols[[1, 1, 2]];
solnset = Map[f, vals]
ps = Plot[Evaluate[solnset, {x, -5, 5}];
Show[pv, ps, PlotRange -> {-4, 6}];
```

The code for problems such as 31 & 32 is similar for the direction field, but the analytical solutions involve complicated inverse functions, so the numerical solver NDSolve is used. Note that a domain interval is specified.

```
equation = y'[x] == Cos[2x - y[x]];
initcond = y[0] == 2;
sol = NDSolve[{equation, initcond}, y[x], {x, 0, 5}]
ps = Plot[Evaluate[y[x]/.sol, {x, 0, 5}];
N[y[x] /. sol/.x -> 2]
Show[pv, ps, PlotRange -> {0, 5}];
```

Solutions for 33 can be found one at a time and plots named and shown together. No direction fields here. For 34, the direction field code is similar, but the solution is found implicitly using integrations. The plot requires loading another special graphics package.

```
<<Graphics`ImplicitPlot`
Clear[x,y]
solution[c_] = Integrate[2 (y - 1), y] == Integrate[3x^2 + 4x + 2, x] + c
values = {-6, -4, -2, 0, 2, 4, 6};
solns = Map[solution, values];
ps = ImplicitPlot[solns, {x, -3, 3}, {y, -3, 3}]
Show[pv, ps]
```

23.

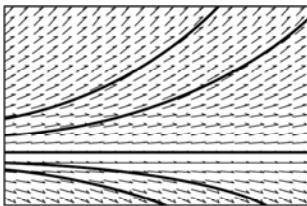

24.

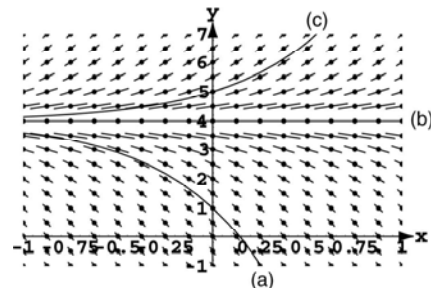

25.

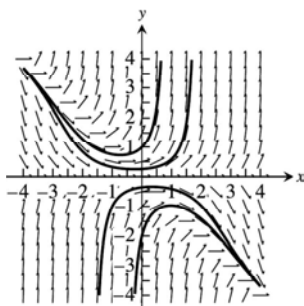

26.

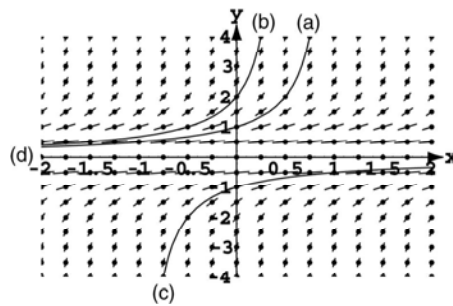

27.

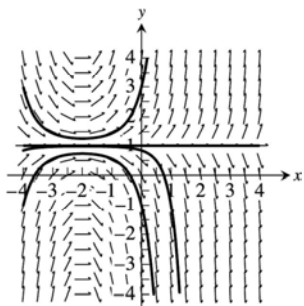

28.

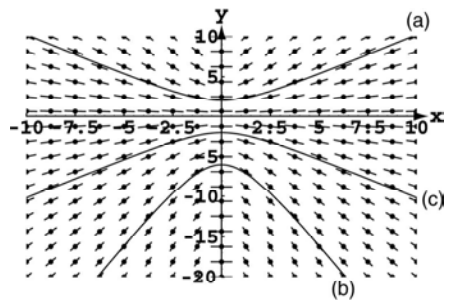

29. The general solution is $y = \frac{2}{1 + ce^{-2t}}$. The particular solution $y = \frac{2}{1 + 3e^{-2t}}$ is shown below together with the slope field.

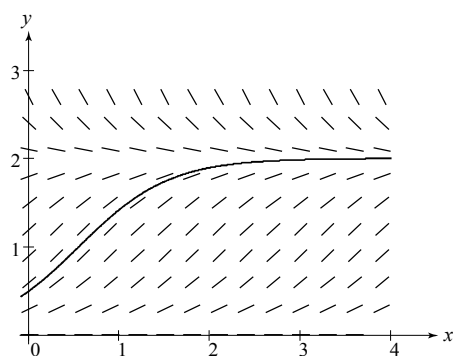

30. The general solution is $y = \pi + \tan^{-1}\left(\frac{2e^{c-\cos x}}{1 - e^{2(c-\cos x)}}\right)$. The required particular solution with $c = 1 + \ln(\csc 2 - \cot 2) \approx 1.443$ is shown below together with the slope field.

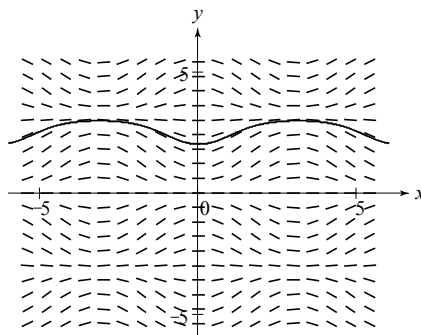

31. The particular solution with $y(0) = 2$ is shown together with the slope field.

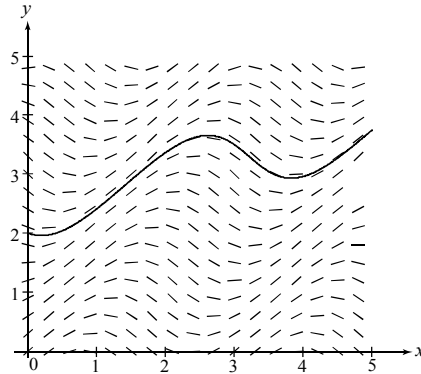

32. The particular solution with $y(0) = 1/3$ is shown together with the slope field.

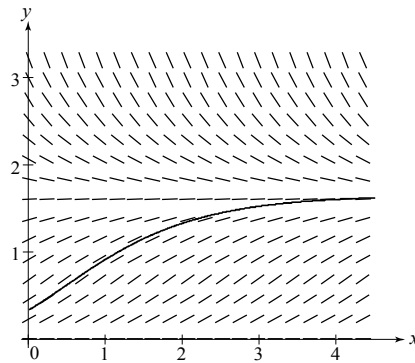

33. The particular solutions with $y(0) = 0$ are:

- (a) $y = 2e^{-2x} + 2x - 2$
- (b) $y = \frac{1}{5}\sin 2x - \frac{2}{5}\cos 2x + \frac{2}{5}e^{-x}$
- (c) $y = 2e^{x/2} - 2e^{-x}$
- (d) $y = e^{-x/2}\left(\frac{4}{17}\cos 2x + \frac{16}{17}\sin 2x\right) - \frac{4}{17}e^{-x}$

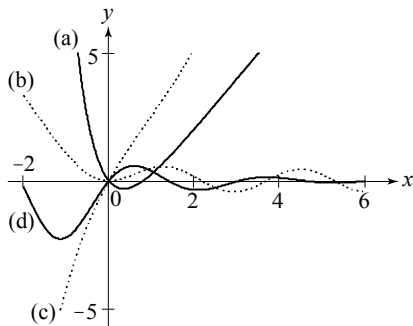

34. (a)

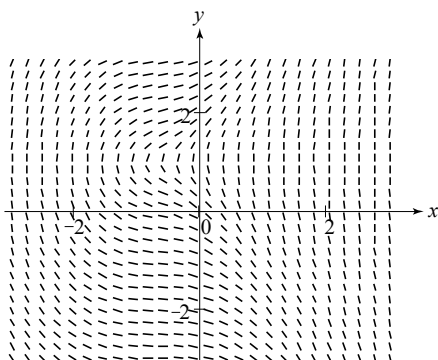
(b) The solution is given implicitly by $y^2 - 2y = x^3 + 2x^2 + 2x + c$.

35. $\frac{dy}{dx} = 2xe^{x^2}$, $y(0) = 2 \Rightarrow y_{n+1} = y_n + 2x_n e^{x_n^2} dx = y_n + 2x_n e^{x_n^2} (0.1) = y_n + 0.2x_n e^{x_n^2}$

On a TI-84 calculator home screen, type the following commands:

2 STO > y: 0 STO > x: y (enter)

 $y + 0.2 * x * e^{(x^2)}$ STO > y: x + 0.1 STO > x: y (enter, 10 times)The last value displayed gives $y_{\text{Euler}}(1) \approx 3.45835$ The exact solution: $dy = 2xe^{x^2} dx \Rightarrow y = e^{x^2} + C$; $y(0) = 2 = e^0 + C \Rightarrow C = 1 \Rightarrow y = 1 + e^{x^2}$
 $\Rightarrow y_{\text{exact}}(1) = 1 + e \approx 3.71828$

36. $\frac{dy}{dx} = 2y^2(x-1)$, $y(2) = -\frac{1}{2} \Rightarrow y_{n+1} = y_n + 2y_n^2(x_n-1)dx = y_n + 0.2y_n^2(x_n-1)$

On a TI-84 calculator home screen, type the following commands:

 -0.5 STO > y: 2 STO > x: y (enter) $y + 0.2 * y^2 * (x - 1)$ STO > y: x + 0.1 STO > x: y (enter, 10 times)The last value displayed gives $y_{\text{Euler}}(2) \approx -0.19285$ The exact solution: $\frac{dy}{dx} = 2y^2(x-1) \Rightarrow \frac{dy}{y^2} = (2x-2)dx \Rightarrow -\frac{1}{y} = x^2 - 2x + C \Rightarrow \frac{1}{y} = -x^2 + 2x + C$

$$y(2) = -\frac{1}{2} \Rightarrow \frac{1}{-1/2} = -(2)^2 + 2(2) + C = C \Rightarrow C = -2 \Rightarrow \frac{1}{y} = -x^2 + 2x - 2 \Rightarrow y = \frac{1}{-x^2 + 2x - 2}$$

$$y(3) = \frac{1}{-(3)^2 + 2(3) - 2} = -0.2$$

37. $\frac{dy}{dx} = \frac{\sqrt{x}}{y}$, $y > 0$, $y(0) = 1 \Rightarrow y_{n+1} = y_n + \frac{\sqrt{x_n}}{y_n} dx = y_n + \frac{\sqrt{x_n}}{y_n} (0.1) = y_n + 0.1 \frac{\sqrt{x_n}}{y_n}$

On a TI-84 calculator home screen, type the following commands:

1 STO > y: 0 STO > x: y (enter)

 $y + 0.1 * (\sqrt{x} / y)$ STO > y: x + 0.1 STO > x: y (enter, 10 times)The last value displayed gives $y_{\text{Euler}}(1) \approx 1.5000$ The exact solution: $dy = \frac{\sqrt{x}}{y} dx \Rightarrow y dy = \sqrt{x} dx \Rightarrow \frac{y^2}{2} = \frac{2}{3}x^{3/2} + C$; $\frac{(y(0))^2}{2} = \frac{1^2}{2} = \frac{1}{2} = \frac{2}{3}(0)^{3/2} + C \Rightarrow C = \frac{1}{2}$

$$\Rightarrow \frac{y^2}{2} = \frac{2}{3}x^{3/2} + \frac{1}{2} \Rightarrow y = \sqrt{\frac{4}{3}x^{3/2} + 1} \Rightarrow y_{\text{exact}}(1) = \sqrt{\frac{4}{3}(1)^{3/2} + 1} \approx 1.5275$$

$$38. \quad \frac{dy}{dx} = 1 + y^2, \quad y(0) = 0 \Rightarrow y_{n+1} = y_n + (1 + y_n^2)dx = y_n + (1 + y_n^2)(0.1) = y_n + 0.1(1 + y_n^2)$$

On a TI-84 calculator home screen, type the following commands:

0 STO > y: 0 STO > x: y (enter)

y + 0.1*(1+y²) STO > y: x + 0.1 STO > x: y (enter, 10 times)

The last value displayed gives $y_{\text{Euler}}(1) \approx 1.3964$

The exact solution: $dy = (1 + y^2)dx \Rightarrow \frac{dy}{1+y^2} = dx \Rightarrow \tan^{-1} y = x + C; \quad \tan^{-1} y(0) = \tan^{-1} 0 = 0 = 0 + C$

$\Rightarrow C = 0 \Rightarrow \tan^{-1} y = x \Rightarrow y = \tan x \Rightarrow y_{\text{exact}}(1) = \tan 1 \approx 1.5574$

39. Example CAS commands:

Maple:

```
ode := diff( y(x), x ) = x + y(x); ic := y(0)=-7/10;
```

```
x0 := -4; x1 := 4; y0 := -4; y1 := 4;
```

```
b := 1;
```

```
P1 := DEplot( ode, y(x), x=x0..x1, y=y0..y1, arrows=thin, title="#39(a) (Section 9.1)");
```

```
P1;
```

```
Ygen := unapply( rhs(dsolve( ode, y(x) )), x, _C1 ); # (b)
```

```
P2 := seq( plot( Ygen(x,c), x=x0..x1, y=y0..y1, color=blue ), c=-2..2 ); # (c)
```

```
display( [P1,P2], title="#39(c) (Section 9.1)");
```

```
CC := solve( Ygen(0,C)=rhs(ic), C ); # (d)
```

```
Ypart := Ygen(x,CC);
```

```
P3 := plot( Ypart, x=0..b, title="#39(d) (Section 9.1)");
```

```
P3;
```

```
euler4 := dsolve( {ode,ic}, numeric, method=classical[foreuler], stepsize = (x1-x0)/4 ); # (e)
```

```
P4 := odeplot( euler4, [x,y(x)], x=0..b, numpoints=4, color=blue );
```

```
display( [P3,P4], title="#39(e) (Section 9.1)");
```

```
euler8 := dsolve( {ode,ic}, numeric, method=classical[foreuler], stepsize=(x1-x0)/8 ); # (f)
```

```
P5 := odeplot( euler8, [x,y(x)], x=0..b, numpoints=8, color=green );
```

```
euler16 := dsolve( {ode,ic}, numeric, method=classical[foreuler], stepsize=(x1-x0)/16 );
```

```
P6 := odeplot( euler16, [x,y(x)], x=0..b, numpoints=16, color=pink );
```

```
euler32 := dsolve( {ode,ic}, numeric, method=classical[foreuler], stepsize=(x1-x0)/32 );
```

```
P7 := odeplot( euler32, [x,y(x)], x=0..b, numpoints=32, color=cyan );
```

```
display( [P3,P4,P5,P6,P7], title="#39(f) (Section 9.1)");
```

```
<< N | h | percent error > , # (g)
```

```
< 4 | (x1-x0)/4 | evalf[5]( abs(1-eval(y(x),euler4(b)))/eval(Ypart,x=b))*100 ) > ,
```

```
< 8 | (x1-x0)/8 | evalf[5]( abs(1-eval(y(x),euler8(b)))/eval(Ypart,x=b))*100 ) > ,
```

```
< 16 | (x1-x0)/16 | evalf[5]( abs(1-eval(y(x),euler16(b)))/eval(Ypart,x=b))*100 ) > ,
```

```
< 32 | (x1-x0)/32 | evalf[5]( abs(1-eval(y(x),euler32(b)))/eval(Ypart,x=b))*100 ) >> ;
```

39-42. Example CAS commands:

Mathematica: (assigned functions, step sizes, and values for initial conditions may vary)

Problems 39 - 42 involve use of code from Problems 23 - 34 together with the above code for Euler's method.

9.2 FIRST-ORDER LINEAR EQUATIONS

- $x \frac{dy}{dx} + y = e^x \Rightarrow \frac{dy}{dx} + \left(\frac{1}{x}\right)y = \frac{e^x}{x}$, $P(x) = \frac{1}{x}$, $Q(x) = \frac{e^x}{x}$
 $\int P(x) dx = \int \frac{1}{x} dx = \ln|x| = \ln x$, $x > 0 \Rightarrow v(x) = e^{\int P(x) dx} = e^{\ln x} = x$
 $y = \frac{1}{v(x)} \int v(x)Q(x) dx = \frac{1}{x} \int x \left(\frac{e^x}{x}\right) dx = \frac{1}{x} (e^x + C) = \frac{e^x + C}{x}$, $x > 0$
- $e^x \frac{dy}{dx} + 2e^x y = 1 \Rightarrow \frac{dy}{dx} + 2y = e^{-x}$, $P(x) = 2$, $Q(x) = e^{-x}$
 $\int P(x) dx = \int 2 dx = 2x \Rightarrow v(x) = e^{\int P(x) dx} = e^{2x}$
 $y = \frac{1}{e^{2x}} \int e^{2x} \cdot e^{-x} dx = \frac{1}{e^{2x}} \int e^x dx = \frac{1}{e^{2x}} (e^x + C) = e^{-x} + C e^{-2x}$
- $xy' + 3y = \frac{\sin x}{x^2}$, $x > 0 \Rightarrow \frac{dy}{dx} + \left(\frac{3}{x}\right)y = \frac{\sin x}{x^3}$, $P(x) = \frac{3}{x}$, $Q(x) = \frac{\sin x}{x^3}$
 $\int \frac{3}{x} dx = 3 \ln|x| = \ln x^3$, $x > 0 \Rightarrow v(x) = e^{\ln x^3} = x^3$
 $y = \frac{1}{x^3} \int x^3 \left(\frac{\sin x}{x^3}\right) dx = \frac{1}{x^3} \int \sin x dx = \frac{1}{x^3} (-\cos x + C) = \frac{C - \cos x}{x^3}$, $x > 0$
- $y' + (\tan x)y = \cos^2 x$, $-\frac{\pi}{2} < x < \frac{\pi}{2} \Rightarrow \frac{dy}{dx} + (\tan x)y = \cos^2 x$, $P(x) = \tan x$, $Q(x) = \cos^2 x$
 $\int \tan x dx = \int \frac{\sin x}{\cos x} dx = -\ln|\cos x| = \ln(\cos x)^{-1}$, $-\frac{\pi}{2} < x < \frac{\pi}{2} \Rightarrow v(x) = e^{\ln(\cos x)^{-1}} = (\cos x)^{-1} = \sec x$
 $y = \frac{1}{\sec x} \int \sec x \cdot \cos^2 x dx = (\cos x) \int \cos x dx = (\cos x)(\sin x + C) = \sin x \cos x + C \cos x$
- $x \frac{dy}{dx} + 2y = 1 - \frac{1}{x}$, $x > 0 \Rightarrow \frac{dy}{dx} + \left(\frac{2}{x}\right)y = \frac{1}{x} - \frac{1}{x^2}$, $P(x) = \frac{2}{x}$, $Q(x) = \frac{1}{x} - \frac{1}{x^2}$
 $\int \frac{2}{x} dx = 2 \ln|x| = \ln x^2$, $x > 0 \Rightarrow v(x) = e^{\ln x^2} = x^2$
 $y = \frac{1}{x^2} \int x^2 \left(\frac{1}{x} - \frac{1}{x^2}\right) dx = \frac{1}{x^2} \int (x - 1) dx = \frac{1}{x^2} \left(\frac{x^2}{2} - x + C\right) = \frac{1}{2} - \frac{1}{x} + \frac{C}{x^2}$, $x > 0$
- $(1+x)y' + y = \sqrt{x} \Rightarrow \frac{dy}{dx} + \left(\frac{1}{1+x}\right)y = \frac{\sqrt{x}}{1+x}$, $P(x) = \frac{1}{1+x}$, $Q(x) = \frac{\sqrt{x}}{1+x}$
 $\int \frac{1}{1+x} dx = \ln(1+x)$, since $x > 0 \Rightarrow v(x) = e^{\ln(1+x)} = 1+x$
 $y = \frac{1}{1+x} \int (1+x) \left(\frac{\sqrt{x}}{1+x}\right) dx = \frac{1}{1+x} \int \sqrt{x} dx = \left(\frac{1}{1+x}\right) \left(\frac{2}{3} x^{3/2} + C\right) = \frac{2x^{3/2}}{3(1+x)} + \frac{C}{1+x}$
- $\frac{dy}{dx} - \frac{1}{2}y = \frac{1}{2}e^{x/2} \Rightarrow P(x) = -\frac{1}{2}$, $Q(x) = \frac{1}{2}e^{x/2} \Rightarrow \int P(x) dx = -\frac{1}{2}x \Rightarrow v(x) = e^{-x/2}$
 $\Rightarrow y = \frac{1}{e^{-x/2}} \int e^{-x/2} \left(\frac{1}{2}e^{x/2}\right) dx = e^{x/2} \int \frac{1}{2} dx = e^{x/2} \left(\frac{1}{2}x + C\right) = \frac{1}{2}xe^{x/2} + Ce^{x/2}$

8. $\frac{dy}{dx} + 2y = 2xe^{-2x} \Rightarrow P(x) = 2, Q(x) = 2xe^{-2x} \Rightarrow \int P(x)dx = \int 2 dx = 2x \Rightarrow v(x) = e^{2x}$
 $\Rightarrow y = \frac{1}{e^{2x}} \int e^{2x} (2xe^{-2x}) dx = \frac{1}{e^{2x}} \int 2x dx = e^{-2x} (x^2 + C) = x^2 e^{-2x} + C e^{-2x}$
9. $\frac{dy}{dx} - \left(\frac{1}{x}\right)y = 2 \ln x \Rightarrow P(x) = -\frac{1}{x}, Q(x) = 2 \ln x \Rightarrow \int P(x) dx = -\int \frac{1}{x} dx = -\ln x, x > 0$
 $\Rightarrow v(x) = e^{-\ln x} = \frac{1}{x} \Rightarrow y = x \int \left(\frac{1}{x}\right)(2 \ln x) dx = x \left[(\ln x)^2 + C \right] = x(\ln x)^2 + Cx$
10. $\frac{dy}{dx} + \left(\frac{2}{x}\right)y = \frac{\cos x}{x^2}, x > 0 \Rightarrow P(x) = \frac{2}{x}, Q(x) = \frac{\cos x}{x^2} \Rightarrow \int P(x) dx = \int \frac{2}{x} dx = 2 \ln|x| = \ln x^2, x > 0$
 $\Rightarrow v(x) = e^{\ln x^2} = x^2 \Rightarrow y = \frac{1}{x^2} \int x^2 \left(\frac{\cos x}{x^2}\right) dx = \frac{1}{x^2} \int \cos x dx = \frac{1}{x^2} (\sin x + C) = \frac{\sin x + C}{x^2}$
11. $\frac{ds}{dt} + \left(\frac{4}{t-1}\right)s = \frac{t+1}{(t-1)^3} \Rightarrow P(t) = \frac{4}{t-1}, Q(t) = \frac{t+1}{(t-1)^3} \Rightarrow \int P(t) dt = \int \frac{4}{t-1} dt = 4 \ln|t-1| = \ln(t-1)^4$
 $\Rightarrow v(t) = e^{\ln(t-1)^4} = (t-1)^4 \Rightarrow s = \frac{1}{(t-1)^4} \int (t-1)^4 \left[\frac{t+1}{(t-1)^3}\right] dt = \frac{1}{(t-1)^4} \int (t^2 - 1) dt = \frac{1}{(t-1)^4} \left(\frac{t^3}{3} - t + C\right)$
 $= \frac{t^3}{3(t-1)^4} - \frac{t}{(t-1)^4} + \frac{C}{(t-1)^4}$
12. $(t+1)\frac{ds}{dt} + 2s = 3(t+1) + \frac{1}{(t+1)^2} \Rightarrow \frac{ds}{dt} + \left(\frac{2}{t+1}\right)s = 3 + \frac{1}{(t+1)^3} \Rightarrow P(t) = \frac{2}{t+1}, Q(t) = 3 + (t+1)^{-3}$
 $\Rightarrow \int P(t) dt = \int \frac{2}{t+1} dt = 2 \ln|t+1| = \ln(t+1)^2 \Rightarrow v(t) = e^{\ln(t+1)^2} = (t+1)^2$
 $\Rightarrow s = \frac{1}{(t+1)^2} \int (t+1)^2 \left[3 + (t+1)^{-3}\right] dt = \frac{1}{(t+1)^2} \int \left[3(t+1)^2 + (t+1)^{-1}\right] dt$
 $= \frac{1}{(t+1)^2} \left[(t+1)^3 + \ln|t+1| + C\right] = (t+1) + (t+1)^{-2} \ln(t+1) + \frac{C}{(t+1)^2}, t > -1$
13. $\frac{dr}{d\theta} + (\cot \theta) r = \sec \theta \Rightarrow P(\theta) = \cot \theta, Q(\theta) = \sec \theta \Rightarrow \int P(\theta) d\theta = \int \cot \theta d\theta = \ln|\sin \theta| \Rightarrow v(\theta) = e^{\ln|\sin \theta|}$
 $= \sin \theta$ because $0 < \theta < \frac{\pi}{2} \Rightarrow r = \frac{1}{\sin \theta} \int (\sin \theta)(\sec \theta) d\theta = \frac{1}{\sin \theta} \int \tan \theta d\theta = \frac{1}{\sin \theta} (\ln|\sec \theta| + C)$
 $= (\csc \theta) (\ln|\sec \theta| + C)$
14. $\tan \theta \frac{dr}{d\theta} + r = \sin^2 \theta \Rightarrow \frac{dr}{d\theta} + \frac{r}{\tan \theta} = \frac{\sin^2 \theta}{\tan \theta} \Rightarrow \frac{dr}{d\theta} + (\cot \theta) r = \sin \theta \cos \theta \Rightarrow P(\theta) = \cot \theta, Q(\theta) = \sin \theta \cos \theta$
 $\Rightarrow \int P(\theta) d\theta = \int \cot \theta d\theta = \ln|\sin \theta| = \ln(\sin \theta)$ since $0 < \theta < \frac{\pi}{2} \Rightarrow v(\theta) = e^{\ln(\sin \theta)} = \sin \theta$
 $\Rightarrow r = \frac{1}{\sin \theta} \int (\sin \theta)(\sin \theta \cos \theta) d\theta = \frac{1}{\sin \theta} \int \sin^2 \theta \cos \theta d\theta = \left(\frac{1}{\sin \theta}\right) \left(\frac{\sin^3 \theta}{3} + C\right) = \frac{\sin^2 \theta}{3} + \frac{C}{\sin \theta}$
15. $\frac{dy}{dt} + 2y = 3 \Rightarrow P(t) = 2, Q(t) = 3 \Rightarrow \int P(t) dt = \int 2 dt = 2t \Rightarrow v(t) = e^{2t} \Rightarrow y = \frac{1}{e^{2t}} \int 3e^{2t} dt = \frac{1}{e^{2t}} \left(\frac{3}{2} e^{2t} + C\right);$
 $y(0) = 1 \Rightarrow \frac{3}{2} + C = 1 \Rightarrow C = -\frac{1}{2} \Rightarrow y = \frac{3}{2} - \frac{1}{2} e^{-2t}$
16. $\frac{dy}{dt} + \frac{2y}{t} = t^2 \Rightarrow P(t) = \frac{2}{t}, Q(t) = t^2 \Rightarrow \int P(t) dt = 2 \ln|t| \Rightarrow v(t) = e^{\ln t^2} = t^2 \Rightarrow y = \frac{1}{t^2} \int (t^2) (t^2) dt$
 $= \frac{1}{t^2} \int t^4 dt = \frac{1}{t^2} \left(\frac{t^5}{5} + C\right) = \frac{t^3}{5} + \frac{C}{t^2}; y(2) = 1 \Rightarrow \frac{8}{5} + \frac{C}{4} = 1 \Rightarrow C = -\frac{12}{5} \Rightarrow y = \frac{t^3}{5} - \frac{12}{5t^2}$

17. $\frac{dy}{d\theta} + \left(\frac{1}{\theta}\right)y = \frac{\sin\theta}{\theta} \Rightarrow P(\theta) = \frac{1}{\theta}, Q(\theta) = \frac{\sin\theta}{\theta} \Rightarrow \int P(\theta)d\theta = \ln|\theta| \Rightarrow v(\theta) = e^{\ln|\theta|} = |\theta| \Rightarrow y = \frac{1}{|\theta|} \int \left(\frac{\sin\theta}{\theta}\right) d\theta$
 $= \frac{1}{\theta} \int \theta \left(\frac{\sin\theta}{\theta}\right) d\theta$ for $\theta \neq 0 \Rightarrow y = \frac{1}{\theta} \int \sin\theta d\theta = \frac{1}{\theta}(-\cos\theta + C) = -\frac{1}{\theta} \cos\theta + \frac{C}{\theta}; y\left(\frac{\pi}{2}\right) = 1 \Rightarrow C = \frac{\pi}{2}$
 $\Rightarrow y = -\frac{1}{\theta} \cos\theta + \frac{\pi}{2\theta}$
18. $\frac{dy}{d\theta} - \left(\frac{2}{\theta}\right)y = \theta^2 \sec\theta \tan\theta \Rightarrow P(\theta) = -\frac{2}{\theta}, Q(\theta) = \theta^2 \sec\theta \tan\theta \Rightarrow \int P(\theta) d\theta = -2\ln|\theta| \Rightarrow v(\theta) = e^{-2\ln|\theta|}$
 $= \theta^{-2} \Rightarrow y = \frac{1}{\theta^{-2}} \int \left(\theta^{-2}\right) \left(\theta^2 \sec\theta \tan\theta\right) d\theta = \theta^2 \int \sec\theta \tan\theta d\theta = \theta^2 (\sec\theta + C) = \theta^2 \sec\theta + C\theta^2;$
 $y\left(\frac{\pi}{3}\right) = 2 \Rightarrow 2 = \left(\frac{\pi^2}{9}\right)(2) + C\left(\frac{\pi^2}{9}\right) \Rightarrow C = \frac{18}{\pi^2} - 2 \Rightarrow y = \theta^2 \sec\theta + \left(\frac{18}{\pi^2} - 2\right)\theta^2$
19. $(x+1)\frac{dy}{dx} - 2(x^2+x)y = \frac{e^{x^2}}{x+1} \Rightarrow \frac{dy}{dx} - 2\left[\frac{x(x+1)}{x+1}\right]y = \frac{e^{x^2}}{(x+1)^2} \Rightarrow \frac{dy}{dx} - 2xy = \frac{e^{x^2}}{(x+1)^2} \Rightarrow P(x) = -2x, Q(x) = \frac{e^{x^2}}{(x+1)^2}$
 $\Rightarrow \int P(x) dx = \int -2x dx = -x^2 \Rightarrow v(x) = e^{-x^2} \Rightarrow y = \frac{1}{e^{-x^2}} \int e^{-x^2} \left[\frac{e^{x^2}}{(x+1)^2}\right] dx = e^{x^2} \int \frac{1}{(x+1)^2} dx = e^{x^2} \left[\frac{(x+1)^{-1}}{-1} + C\right]$
 $= -\frac{e^{x^2}}{x+1} + Ce^{x^2}; y(0) = 5 \Rightarrow -\frac{1}{0+1} + C = 5 \Rightarrow -1 + C = 5 \Rightarrow C = 6 \Rightarrow y = 6e^{x^2} - \frac{e^{x^2}}{x+1}$
20. $\frac{dy}{dx} + xy = x \Rightarrow P(x) = x, Q(x) = x \Rightarrow \int P(x) dx = \int x dx = \frac{x^2}{2} \Rightarrow v(x) = e^{x^2/2} \Rightarrow y = \frac{1}{e^{x^2/2}} \int e^{x^2/2} \cdot x dx$
 $= \frac{1}{e^{x^2/2}} \left(e^{x^2/2} + C\right) = 1 + \frac{C}{e^{x^2/2}}; y(0) = -6 \Rightarrow 1 + C = -6 \Rightarrow C = -7 \Rightarrow y = 1 - \frac{7}{e^{x^2/2}}$
21. $\frac{dy}{dt} - ky = 0 \Rightarrow P(t) = -k, Q(t) = 0 \Rightarrow \int P(t) dt = \int -k dt = -kt \Rightarrow v(t) = e^{-kt} \Rightarrow y = \frac{1}{e^{-kt}} \int \left(e^{-kt}\right) (0) dt$
 $= e^{kt} (0 + C) = Ce^{kt}; y(0) = y_0 \Rightarrow C = y_0 \Rightarrow y = y_0 e^{kt}$
22. (a) $\frac{du}{dt} + \frac{k}{m}u = 0 \Rightarrow P(t) = \frac{k}{m}, Q(t) = 0 \Rightarrow \int P(t) dt = \int \frac{k}{m} dt = \frac{k}{m}t = \frac{kt}{m} \Rightarrow u(t) = e^{kt/m}$
 $\Rightarrow y = \frac{1}{e^{kt/m}} \int e^{kt/m} \cdot 0 dt = \frac{C}{e^{kt/m}}; u(0) = u_0 \Rightarrow \frac{C}{e^{k(0)/m}} = u_0 \Rightarrow C = u_0 \Rightarrow u = u_0 e^{-(k/m)t}$
 (b) $\frac{du}{dt} = -\frac{k}{m}u \Rightarrow \frac{du}{u} = -\frac{k}{m} dt \Rightarrow \ln u = -\frac{k}{m}t + C \Rightarrow u = e^{-(k/m)t + C} \Rightarrow u = e^{-(k/m)t} \cdot e^C$. Let $e^C = C_1$.
 Then $u = \frac{1}{e^{(k/m)t}} \cdot C_1$ and $u(0) = u_0 = \frac{1}{e^{(k/m)(0)}} \cdot C_1 = C_1$. So $u = u_0 e^{-(k/m)t}$
23. $x \int \frac{1}{x} dx = x(\ln|x| + C) = x \ln|x| + Cx \Rightarrow$ (b) is correct
24. $\frac{1}{\cos x} \int \cos x dx = \frac{1}{\cos x}(\sin x + C) = \tan x + \frac{C}{\cos x} \Rightarrow$ (b) is correct
25. Steady State $= \frac{V}{R}$ and we want $i = \frac{1}{2}\left(\frac{V}{R}\right) \Rightarrow \frac{1}{2}\left(\frac{V}{R}\right) = \frac{V}{R}(1 - e^{-Rt/L}) \Rightarrow \frac{1}{2} = 1 - e^{-Rt/L} \Rightarrow -\frac{1}{2} = -e^{-Rt/L}$
 $\Rightarrow \ln \frac{1}{2} = -\frac{Rt}{L} \Rightarrow -\frac{L}{R} \ln \frac{1}{2} = t \Rightarrow t = \frac{L}{R} \ln 2$ sec
26. (a) $\frac{di}{dt} + \frac{R}{L}i = 0 \Rightarrow \frac{1}{i} di = -\frac{R}{L} dt \Rightarrow \ln i = -\frac{Rt}{L} + C_1 \Rightarrow i = e^{C_1} e^{-Rt/L} = C e^{-Rt/L}; i(0) = I \Rightarrow I = C$
 $\Rightarrow i = I e^{-Rt/L}$ amp

$$(b) \frac{1}{2}I = I e^{-Rt/L} \Rightarrow e^{-Rt/L} = \frac{1}{2} \Rightarrow -\frac{Rt}{L} = \ln \frac{1}{2} = -\ln 2 \Rightarrow t = \frac{L}{R} \ln 2 \text{ .sec}$$

$$(c) t = \frac{L}{R} \Rightarrow i = I e^{(-Rt/L)(L/R)} = I e^{-1} \text{ amp}$$

$$27. (a) t = \frac{3L}{R} \Rightarrow i = \frac{V}{R} \left(1 - e^{(-R/L)(3L/R)}\right) = \frac{V}{R} \left(1 - e^{-3}\right) \approx 0.9502 \frac{V}{R} \text{ amp, or about 95\% of the steady state value}$$

$$(b) t = \frac{2L}{R} \Rightarrow i = \frac{V}{R} \left(1 - e^{(-R/L)(2L/R)}\right) = \frac{V}{R} \left(1 - e^{-2}\right) \approx 0.8647 \frac{V}{R} \text{ amp or about 86\% of the steady state value}$$

$$28. (a) \frac{di}{dt} + \frac{R}{L}i = \frac{V}{L} \Rightarrow P(t) = \frac{R}{L}, Q(t) = \frac{V}{L} \Rightarrow \int P(t) dt = \int \frac{R}{L} dt = \frac{Rt}{L} \Rightarrow v(t) = e^{Rt/L} \Rightarrow i = \frac{1}{e^{Rt/L}} \int e^{Rt/L} \left(\frac{V}{L}\right) dt$$

$$= \frac{1}{e^{Rt/L}} \left[\frac{L}{R} e^{Rt/L} \left(\frac{V}{L}\right) + C \right] = \frac{V}{R} + C e^{-(R/L)t}$$

$$(b) i(0) = 0 \Rightarrow \frac{V}{R} + C = 0 \Rightarrow C = -\frac{V}{R} \Rightarrow i = \frac{V}{R} - \frac{V}{R} e^{-Rt/L}$$

$$(c) i = \frac{V}{R} \Rightarrow \frac{di}{dt} = 0 \Rightarrow \frac{di}{dt} + \frac{R}{L}i = 0 + \left(\frac{R}{L}\right)\left(\frac{V}{R}\right) = \frac{V}{L} \Rightarrow i = \frac{V}{R} \text{ is a solution of Eq. (6); } i = C e^{-(R/L)t}$$

$$29. y' - y = -y^2; \text{ we have } n = 2, \text{ so let } u = y^{1-2} = y^{-1}. \text{ Then } y = u^{-1} \text{ and } \frac{du}{dx} = -1y^{-2} \frac{dy}{dx} \Rightarrow \frac{dy}{dx} = -y^2 \frac{du}{dx}$$

$$\Rightarrow -u^{-2} \frac{du}{dx} - u^{-1} = -u^{-2} \Rightarrow \frac{du}{dx} + u = 1. \text{ With } e^{\int dx} = e^x \text{ as the integrating factor, we have}$$

$$e^x \left(\frac{du}{dx} + u\right) = \frac{d}{dx}(e^x u) = e^x. \text{ Integrating, we get } e^x u = e^x + C \Rightarrow u = 1 + \frac{C}{e^x} = \frac{1}{y} \Rightarrow y = \frac{1}{1 + \frac{C}{e^x}} = \frac{e^x}{e^x + C}$$

$$30. y' - y = xy^2; \text{ we have } n = 2, \text{ so let } u = y^{-1}. \text{ Then } y = u^{-1} \text{ and } \frac{du}{dx} = -y^{-2} \frac{dy}{dx} \Rightarrow \frac{dy}{dx} = -y^2 \frac{du}{dx} = -u^{-2} \frac{du}{dx}.$$

$$\text{Substituting: } -u^{-2} \frac{du}{dx} - u^{-1} = xu^{-2} \Rightarrow \frac{du}{dx} + u = -x. \text{ Using } e^{\int dx} = e^x \text{ as an integrating factor:}$$

$$e^x \left(\frac{du}{dx} + u\right) = \frac{d}{dx}(e^x u) = -x e^x \Rightarrow e^x u = e^x(1-x) + C \Rightarrow u = \frac{e^x(1-x) + C}{e^x} \Rightarrow y = u^{-1} = \frac{e^x}{e^x - x e^x + C}$$

$$31. xy' + y = y^{-2} \Rightarrow y' + \left(\frac{1}{x}\right)y = \left(\frac{1}{x}\right)y^{-2}. \text{ Let } u = y^{1-(-2)} = y^3 \Rightarrow y = u^{1/3} \text{ and } y^{-2} = u^{-2/3}.$$

$$\frac{du}{dx} = 3y^2 \frac{dy}{dx} \Rightarrow y' = \frac{dy}{dx} = \left(\frac{1}{3}\right)\left(\frac{du}{dx}\right)\left(y^{-2}\right) = \left(\frac{1}{3}\right)\left(\frac{du}{dx}\right)\left(u^{-2/3}\right). \text{ Thus we have}$$

$$\left(\frac{1}{3}\right)\left(\frac{du}{dx}\right)\left(u^{-2/3}\right) + \left(\frac{1}{x}\right)u^{1/3} = \left(\frac{1}{x}\right)u^{-2/3} \Rightarrow \frac{du}{dx} + \left(\frac{3}{x}\right)u = \left(\frac{3}{x}\right). \text{ The integrating factor is } v(x) = e^{\int \frac{3}{x} dx} = e^{3 \ln x}$$

$$= e^{\ln x^3} = x^3. \text{ Thus } \frac{d}{dx}(x^3 u) = \left(\frac{3}{x}\right)x^3 = 3x^2 \Rightarrow x^3 u = x^3 + C \Rightarrow u = 1 + \frac{C}{x^3} = y^3 \Rightarrow y = \left(1 + \frac{C}{x^3}\right)^{1/3}$$

$$32. x^2 y' + 2xy = y^3 \Rightarrow y' + \left(\frac{2}{x}\right)y = \left(\frac{1}{x^2}\right)y^3. P(x) = \left(\frac{2}{x}\right), Q(x) = \left(\frac{1}{x^2}\right), n = 3. \text{ Let } u = y^{1-3} = y^{-2}. \text{ Substituting}$$

$$\text{gives } \frac{du}{dx} + (-2)\left(\frac{2}{x}\right)u = -2\left(\frac{1}{x^2}\right) \Rightarrow \frac{du}{dx} + \left(\frac{-4}{x}\right)u = \frac{-2}{x^2}. \text{ Let the integrating factor, } v(x), \text{ be}$$

$$e^{\int \left(\frac{-4}{x}\right) dx} = e^{\ln x^{-4}} = x^{-4}. \text{ Thus } \frac{d}{dx}(x^{-4} u) = -2x^{-6} \Rightarrow x^{-4} u = \frac{2}{5} x^{-5} + C \Rightarrow u = \frac{2}{5x} + Cx^4 = y^{-2}$$

$$\Rightarrow y = \left(\frac{2}{5x} + Cx^4\right)^{-1/2}$$

9.3 APPLICATIONS

1. Note that the total mass is $66 + 7 = 73$ kg, therefore, $v = v_0 e^{-(k/m)t} \Rightarrow v = 9e^{-3.9t/73}$

(a) $s(t) = \int 9e^{-3.9t/73} dt = -\frac{2190}{13} e^{-3.9t/73} + C$

Since $s(0) = 0$ we have $C = \frac{2190}{13}$ and $\lim_{t \rightarrow \infty} s(t) = \lim_{t \rightarrow \infty} \frac{2190}{13} (1 - e^{-3.9t/73}) = \frac{2190}{13} \approx 168.5$

The cyclist will coast about 168.5 meters.

(b) $1 = 9e^{-3.9t/73} \Rightarrow \frac{3.9t}{73} = \ln 9 \Rightarrow t = \frac{73 \ln 9}{3.9} \approx 41.13$ sec

It will take about 41.13 seconds.

2. $v = v_0 e^{-(k/m)t} \Rightarrow v = 9e^{-(59,000/51,000,000)t} \Rightarrow v = 9e^{-59t/51,000}$

(a) $s(t) = \int 9e^{-59t/51,000} dt = -\frac{459,000}{59} e^{-59t/51,000} + C$

Since $s(0) = 0$ we have $C = \frac{459,000}{59}$ and $\lim_{t \rightarrow \infty} s(t) = \lim_{t \rightarrow \infty} \frac{459,000}{59} (1 - e^{-59t/51,000}) = \frac{459,000}{59} \approx 7780$ m

The ship will coast about 7780 m, or 7.78 km.

(b) $1 = 9e^{-59t/51,000} \Rightarrow \frac{59t}{51,000} = \ln 9 \Rightarrow t = \frac{51,000 \ln 9}{59} \approx 1899.3$ sec

It will take about 31.65 minutes.

3. The total distance traveled $= \frac{v_0 m}{k} \Rightarrow \frac{(2.75)(39.92)}{k} = 4.91 \Rightarrow k = 22.36$. Therefore, the distance traveled is given by the function $s(t) = 4.91(1 - e^{-(22.36/39.92)t})$. The graph shows $s(t)$ and the data points.

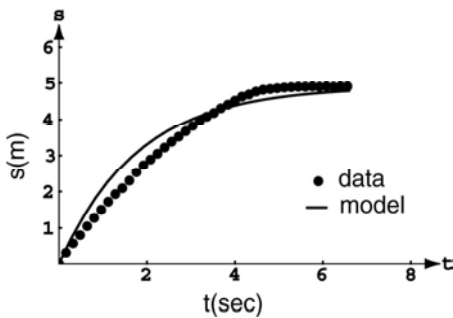

4. $\frac{v_0 m}{k} = \text{coasting distance} \Rightarrow \frac{(0.80)(49.90)}{k} = 1.32 \Rightarrow k = \frac{998}{33}$

We know that $\frac{v_0 m}{k} = 1.32$ and $\frac{k}{m} = \frac{998}{33(49.9)} = \frac{20}{33}$.

Using Equation 2, we have: $s(t) = \frac{v_0 m}{k} (1 - e^{-(k/m)t}) = 1.32(1 - e^{-20t/33}) \approx 1.32(1 - e^{-0.606t})$

5. $y = mx \Rightarrow \frac{y}{x} = m \Rightarrow \frac{xy' - y}{x^2} = 0 \Rightarrow y' = \frac{y}{x}$. So for

orthogonals: $\frac{dy}{dx} = -\frac{x}{y} \Rightarrow y dy = -x dx \Rightarrow \frac{y^2}{2} + \frac{x^2}{2} = C$

$\Rightarrow x^2 + y^2 = C_1$

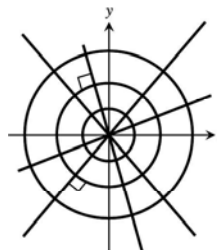

$$\begin{aligned}
 6. \quad y = cx^2 &\Rightarrow \frac{y}{x^2} = c \Rightarrow \frac{x^2 y' - 2xy}{x^4} = 0 \Rightarrow x^2 y' = 2xy \\
 &\Rightarrow y' = \frac{2y}{x}. \text{ So for the orthogonals: } \frac{dy}{dx} = -\frac{x}{2y} \\
 &\Rightarrow 2y dy = -x dx \Rightarrow y^2 = -\frac{x^2}{2} + C \Rightarrow y = \pm \sqrt{-\frac{x^2}{2} + C}, \\
 &C > 0
 \end{aligned}$$

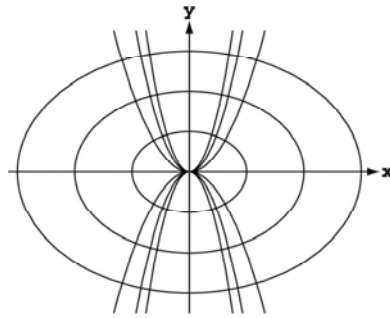

$$\begin{aligned}
 7. \quad kx^2 + y^2 = 1 &\Rightarrow 1 - y^2 = kx^2 \Rightarrow \frac{1-y^2}{x^2} = k \\
 &\Rightarrow \frac{x^2(2y)y' - (1-y^2)2x}{x^4} = 0 \Rightarrow -2yx^2 y' = (1-y^2)(2x) \\
 &\Rightarrow y' = \frac{(1-y^2)(2x)}{-2xy^2} = \frac{(1-y^2)}{-xy}. \text{ So for the orthogonals:} \\
 &\frac{dy}{dx} = \frac{xy}{1-y^2} \Rightarrow \frac{(1-y^2)}{y} dy = x dx \Rightarrow \ln y - \frac{y^2}{2} = \frac{x^2}{2} + C
 \end{aligned}$$

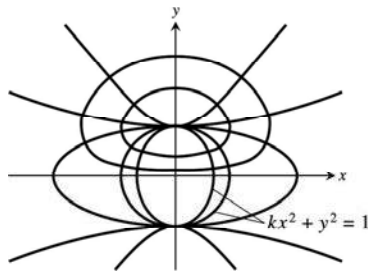

$$\begin{aligned}
 8. \quad 2x^2 + y^2 = c^2 &\Rightarrow 4x + 2yy' = 0 \Rightarrow y' = -\frac{4x}{2y} = -\frac{2x}{y}. \text{ For} \\
 \text{orthogonals: } \frac{dy}{dx} &= \frac{y}{2x} \Rightarrow \frac{dy}{y} = \frac{dx}{2x} \Rightarrow \ln y = \frac{1}{2} \ln x + C \\
 &\Rightarrow \ln y = \ln x^{1/2} + \ln C_1 \Rightarrow y = C_1 |x|^{1/2}
 \end{aligned}$$

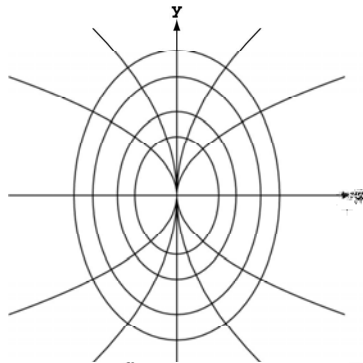

$$\begin{aligned}
 9. \quad y = ce^{-x} &\Rightarrow \frac{y}{e^{-x}} = c \Rightarrow \frac{e^{-x}y' - y(e^{-x})(-1)}{(e^{-x})^2} = 0 \\
 &\Rightarrow e^{-x}y' = -ye^{-x} \Rightarrow y' = -y. \text{ So for the orthogonals:} \\
 &\frac{dy}{dx} = \frac{1}{y} \Rightarrow y dy = dx \Rightarrow \frac{y^2}{2} = x + C \Rightarrow y^2 = 2x + C_1 \\
 &\Rightarrow y = \pm \sqrt{2x + C_1}
 \end{aligned}$$

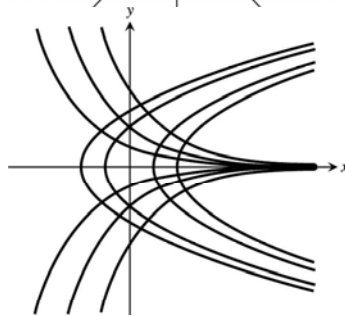

$$\begin{aligned}
 10. \quad y = e^{kx} &\Rightarrow \ln y = kx \Rightarrow \frac{\ln y}{x} = k \Rightarrow \frac{x(\frac{1}{y})y' - \ln y}{x^2} = 0 \\
 &\Rightarrow \left(\frac{x}{y}\right)y' - \ln y = 0 \Rightarrow y' = \frac{y \ln y}{x}. \text{ So for the} \\
 \text{orthogonals: } \frac{dy}{dx} &= \frac{-x}{y \ln y} \Rightarrow y \ln y dy = -x dx \\
 &\Rightarrow \frac{1}{2} y^2 \ln y - \frac{1}{4} (y^2)^2 = \left(-\frac{1}{2} x^2\right) + C \\
 &\Rightarrow y^2 \ln y - \frac{y^2}{2} = -x^2 + C_1
 \end{aligned}$$

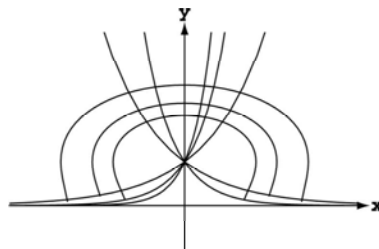

11. $2x^2 + 3y^2 = 5$ and $y^2 = x^3$ intersect at $(1, 1)$. Also, $2x^2 + 3y^2 = 5 \Rightarrow 4x + 6y y' = 0 \Rightarrow y' = -\frac{4x}{6y}$
 $\Rightarrow y'(1, 1) = -\frac{2}{3}$ and $y_1^2 = x^3 \Rightarrow 2y_1 y_1' = 3x^2 \Rightarrow y_1' = \frac{3x^2}{2y_1} \Rightarrow y_1'(1, 1) = \frac{3}{2}$. Since $y' \cdot y_1' = \left(-\frac{2}{3}\right)\left(\frac{3}{2}\right) = -1$, the curves are orthogonal.

12. (a) $x dx + y dy = 0 \Rightarrow \frac{x^2}{2} + \frac{y^2}{2} = C$ the general equation of the family with slope $y' = -\frac{x}{y}$.
 For the orthogonals: $y' = \frac{y}{x} \Rightarrow \frac{dy}{y} = \frac{dx}{x}$
 $\Rightarrow \ln y = \ln x + C$ or $y = C_1 x$ (where $C_1 = e^C$) is the general equation of the orthogonals.

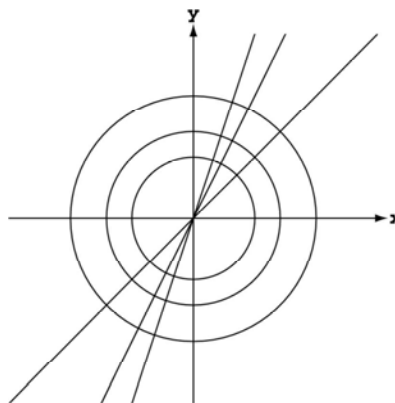

- (b) $x dy - 2y dx = 0 \Rightarrow 2y dx = x dy \Rightarrow \frac{dy}{y} = \frac{dx}{2x}$
 $\Rightarrow \frac{1}{2} \left(\frac{dy}{y}\right) = \frac{dx}{x} \Rightarrow \frac{1}{2} \ln y = \ln x + C \Rightarrow y = C_1 x^2$
 is the equation for the solution family.
 $\frac{1}{2} \ln y - \ln x = C \Rightarrow \frac{1}{2} \frac{y'}{y} - \frac{1}{x} = 0 \Rightarrow y' = \frac{2y}{x}$
 \Rightarrow slope of orthogonals is $\frac{dy}{dx} = -\frac{x}{2y}$
 $\Rightarrow 2y dy = -x dx \Rightarrow y^2 = -\frac{x^2}{2} + C$ is the general equation of the orthogonals.

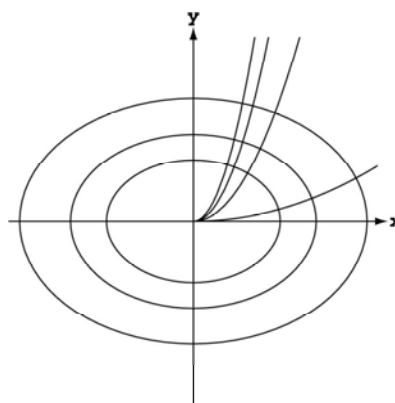

13. Let $y(t)$ = the amount of salt in the container and $V(t)$ = the total volume of liquid in the tank at time t . Then, the departure rate is $\frac{y(t)}{V(t)}$ (the outflow rate).

(a) Rate entering = $2 \frac{\text{lb}}{\text{gal}} \cdot 5 \frac{\text{gal}}{\text{min}} = 10 \frac{\text{lb}}{\text{min}}$

(b) Volume = $V(t) = 100 \text{ gal} + (5t \text{ gal} - 4t \text{ gal}) = (100 + t) \text{ gal}$

(c) The volume at time t is $(100 + t)$ gal. The amount of salt in the tank at time t is y lbs. So the concentration at any time t is $\frac{y}{100+t} \frac{\text{lb}}{\text{gal}}$. Then, the rate leaving = $\frac{y}{100+t} \left(\frac{\text{lb}}{\text{gal}}\right) \cdot 4 \left(\frac{\text{gal}}{\text{min}}\right) = \frac{4y}{100+t} \left(\frac{\text{lb}}{\text{min}}\right)$

(d) $\frac{dy}{dt} = 10 - \frac{4y}{100+t} \Rightarrow \frac{dy}{dt} + \left(\frac{4}{100+t}\right)y = 10 \Rightarrow P(t) = \frac{4}{100+t}, Q(t) = 10 \Rightarrow \int P(t) dt = \int \frac{4}{100+t} dt = 4 \ln(100+t)$
 $\Rightarrow v(t) = e^{4 \ln(100+t)} = (100+t)^4 \Rightarrow y = \frac{1}{(100+t)^4} \int (100+t)^4 (10 dt) = \frac{10}{(100+t)^4} \left(\frac{(100+t)^5}{5} + C\right)$
 $= 2(100+t) + \frac{C}{(100+t)^4}; y(0) = 50 \Rightarrow 2(100+0) + \frac{C}{(100+0)^4} = 50 \Rightarrow C = -(150)(100)^4$
 $\Rightarrow y = 2(100+t) - \frac{(150)(100)^4}{(100+t)^4} \Rightarrow y = 2(100+t) - \frac{150}{\left(1+\frac{t}{100}\right)^4}$

(e) $y(25) = 2(100+25) - \frac{(150)(100)^4}{(100+25)^4} \approx 188.56 \text{ lbs} \Rightarrow \text{concentration} = \frac{y(25)}{\text{volume}} \approx \frac{188.6}{125} \approx 1.5 \frac{\text{lb}}{\text{gal}}$

14. (a) $\frac{dV}{dt} = (5-3) = 2 \Rightarrow V = 100 + 2t$

The tank is full when $V = 200 = 100 + 2t \Rightarrow t = 50$ min

(b) Let $y(t)$ be the amount of concentrate in the tank at time t .

$$\frac{dy}{dt} = \left(\frac{1}{2} \frac{\text{lb}}{\text{gal}}\right) \left(5 \frac{\text{gal}}{\text{min}}\right) - \left(\frac{y}{100+2t} \frac{\text{lb}}{\text{gal}}\right) \left(3 \frac{\text{gal}}{\text{min}}\right) \Rightarrow \frac{dy}{dt} = \frac{5}{2} - \frac{3}{2} \left(\frac{y}{50+t}\right) \Rightarrow \frac{dy}{dt} + \frac{3}{2(t+50)} y = \frac{5}{2}; \quad Q(t) = \frac{5}{2};$$

$$P(t) = \frac{3}{2} \left(\frac{1}{t+50}\right) \Rightarrow \int P(t) dt = \frac{3}{2} \int \frac{1}{t+50} dt = \frac{3}{2} \ln(t+50) \text{ since } t+50 > 0 \Rightarrow v(t) = e^{\int P(t) dt} = e^{\frac{3}{2} \ln(t+50)}$$

$$= (t+50)^{3/2} \Rightarrow y(t) = \frac{1}{(t+50)^{3/2}} \int \frac{5}{2} (t+50)^{3/2} dt = (t+50)^{-3/2} \left[(t+50)^{5/2} + C \right] \Rightarrow y(t) = t + 50 + \frac{C}{(t+50)^{3/2}}$$

Apply the initial condition (i.e., distilled water in the tank at $t = 0$):

$$y(0) = 0 = 50 + \frac{C}{50^{3/2}} \Rightarrow C = -50^{5/2} \Rightarrow y(t) = t + 50 - \frac{50^{5/2}}{(t+50)^{3/2}}. \text{ When the tank is full at } t = 50,$$

$$y(50) = 100 - \frac{50^{5/2}}{100^{3/2}} \approx 83.22 \text{ pounds of concentrate.}$$

15. Let y be the amount of fertilizer in the tank at time t . Then rate entering $= 1 \frac{\text{lb}}{\text{gal}} \cdot 1 \frac{\text{gal}}{\text{min}} = 1 \frac{\text{lb}}{\text{min}}$ and the volume

in the tank at time t is $V(t) = 100 \text{ (gal)} + \left[1 \left(\frac{\text{gal}}{\text{min}}\right) - 3 \left(\frac{\text{gal}}{\text{min}}\right) \right] t \text{ min} = (100 - 2t) \text{ gal}$. Hence rate out

$$= \left(\frac{y}{100-2t}\right) 3 = \frac{3y}{100-2t} \frac{\text{lb}}{\text{min}} \Rightarrow \frac{dy}{dt} = \left(1 - \frac{3y}{100-2t}\right) \frac{\text{lb}}{\text{min}} \Rightarrow \frac{dy}{dt} + \left(\frac{3}{100-2t}\right) y = 1 \Rightarrow P(t) = \frac{3}{100-2t}, \quad Q(t) = 1$$

$$\Rightarrow \int P(t) dt = \int \frac{3}{100-2t} dt = \frac{3 \ln(100-2t)}{-2} \Rightarrow v(t) = e^{(-3 \ln(100-2t))/2} = (100-2t)^{-3/2}$$

$$\Rightarrow y = \frac{1}{(100-2t)^{-3/2}} \int (100-2t)^{-3/2} dt = (100-2t)^{-3/2} \left[\frac{-2(100-2t)^{-1/2}}{-2} + C \right] = (100-2t) + C(100-2t)^{3/2};$$

$$y(0) = 0 \Rightarrow [100 - 2(0)] + C[100 - 2(0)]^{3/2} \Rightarrow C(100)^{3/2} = -100 \Rightarrow C = -(100)^{-1/2} = -\frac{1}{10}$$

$$\Rightarrow y = (100 - 2t) - \frac{(100 - 2t)^{3/2}}{10}. \text{ Let } \frac{dy}{dt} = 0 \Rightarrow \frac{dy}{dt} = -2 - \frac{(\frac{3}{2})(100-2t)^{1/2}(-2)}{10} = -2 + \frac{3\sqrt{100-2t}}{10} = 0$$

$$\Rightarrow 20 = 3\sqrt{100-2t} \Rightarrow 400 = 9(100-2t) \Rightarrow 400 = 900 - 18t \Rightarrow -500 = -18t \Rightarrow t \approx 27.8 \text{ min, the time to}$$

reach the maximum. The maximum amount is then $y(27.8) = [100 - 2(27.8)] - \frac{[100 - 2(27.8)]^{3/2}}{10} \approx 14.8 \text{ lb}$

16. Let $y = y(t)$ be the amount of carbon monoxide (CO) in the room at time t . The amount of CO entering the

room is $\left(\frac{4}{100} \times \frac{3}{10}\right) = \frac{12}{1000} \frac{\text{ft}^3}{\text{min}}$, and the amount of CO leaving the room is $\left(\frac{y}{4500}\right) \left(\frac{3}{10}\right) = \frac{y}{15,000} \frac{\text{ft}^3}{\text{min}}$.

$$\text{Thus, } \frac{dy}{dt} = \frac{12}{1000} - \frac{y}{15,000} \Rightarrow \frac{dy}{dt} + \frac{1}{15,000} y = \frac{12}{1000} \Rightarrow P(t) = \frac{1}{15,000}, \quad Q(t) = \frac{12}{1000} \Rightarrow v(t) = e^{t/15,000}$$

$$\Rightarrow y = \frac{1}{e^{t/15,000}} \int \frac{12}{1000} e^{t/15,000} dt \Rightarrow y = e^{-t/15,000} \left(\frac{12 \cdot 15,000}{1000} e^{t/15,000} + C \right) = e^{-t/15,000} (180 e^{t/15,000} + C);$$

$$y(0) = 0 \Rightarrow 0 = 1(180 + C) \Rightarrow C = -180 \Rightarrow y = 180 - 180 e^{-t/15,000}. \text{ When the concentration of CO is } 0.01\%$$

in the room, the amount of CO satisfies $\frac{y}{4500} = \frac{0.01}{100} \Rightarrow y = 0.45 \text{ ft}^3$. When the room contains this amount

we have $0.45 = 180 - 180 e^{-t/15,000} \Rightarrow \frac{179.55}{180} = e^{-t/15,000} \Rightarrow t = -15,000 \ln\left(\frac{179.55}{180}\right) \approx 37.55 \text{ min}$.

9.4 GRAPHICAL SOLUTIONS OF AUTONOMOUS EQUATIONS

1. $y' = (y + 2)(y - 3)$

(a) $y = -2$ is a stable equilibrium value and $y = 3$ is an unstable equilibrium.

(b) $y'' = (2y - 1)y' = 2(y + 2)(y - \frac{1}{2})(y - 3)$

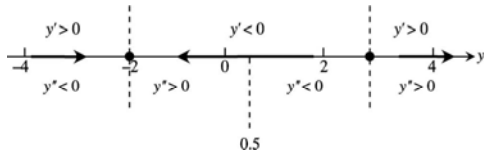

(c)

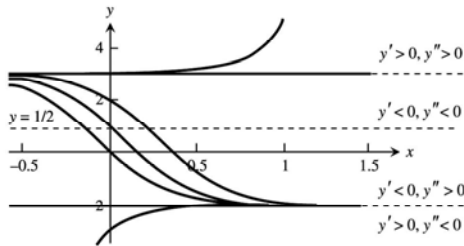

2. $y' = (y + 2)(y - 2)$

(a) $y = -2$ is a stable equilibrium value and $y = 2$ is an unstable equilibrium.

(b) $y'' = 2yy' = 2(y + 2)y(y - 2)$

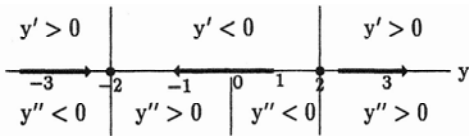

(c)

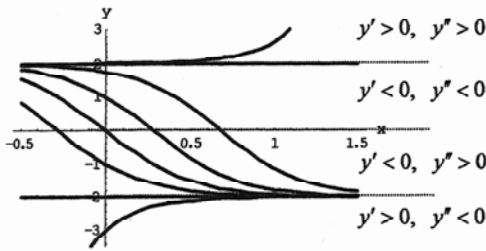

3. $y' = y^3 - y = (y + 1)y(y - 1)$

(a) $y = -1$ and $y = 1$ are unstable equilibria and $y = 0$ is a stable equilibrium value.

(b) $y'' = (3y^2 - 1)y' = 3(y + 1)(y + \frac{1}{\sqrt{3}})y(y - \frac{1}{\sqrt{3}})(y - 1)$

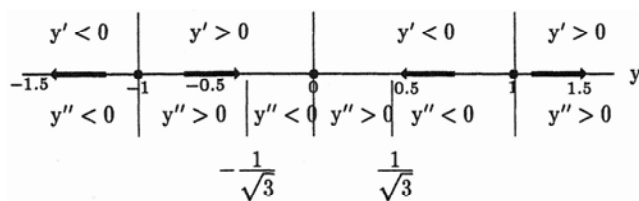

(c)

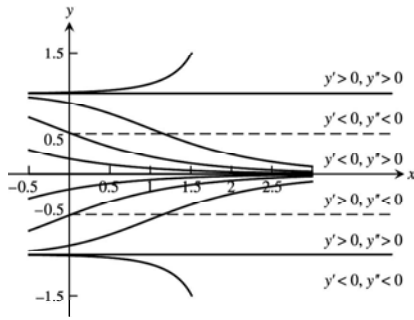

4. $y' = y(y-2)$

(a) $y = 0$ is a stable equilibrium value and $y = 2$ is an unstable equilibrium.

(b) $y'' = (2y-2)y' = 2y(y-1)(y-2)$

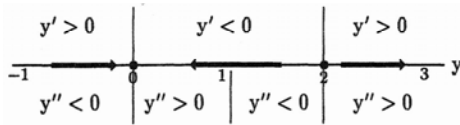

(c)

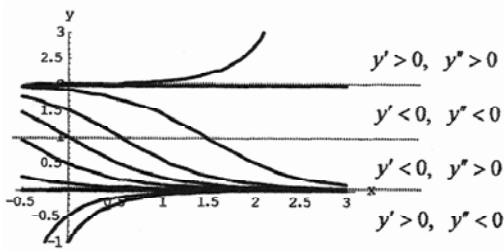

5. $y' = \sqrt{y}, y > 0$

(a) There are no equilibrium values.

(b) $y'' = \frac{1}{2\sqrt{y}} y' = \frac{1}{2\sqrt{y}} \sqrt{y} = \frac{1}{2}$

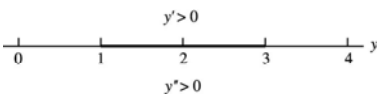

(c)

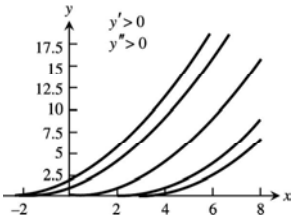

6. $y' = y - \sqrt{y}, y > 0$

(a) $y = 1$ is an unstable equilibrium.

(b) $y'' = \left(1 - \frac{1}{2\sqrt{y}}\right)y' = \left(1 - \frac{1}{2\sqrt{y}}\right)(y - \sqrt{y}) = \left(\sqrt{y} - \frac{1}{2}\right)(\sqrt{y} - 1)$

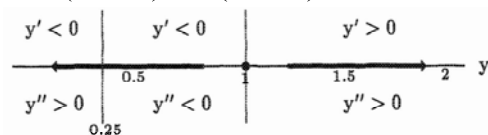

(c)

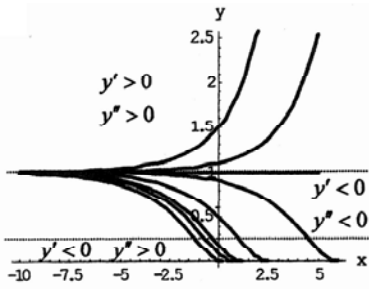

7. $y' = (y-1)(y-2)(y-3)$

(a) $y = 1$ and $y = 3$ are unstable equilibria and $y = 2$ is a stable equilibrium value.

(b) $y'' = (3y^2 - 12y + 11)(y-1)(y-2)(y-3) = 3(y-1)\left(y - \frac{6-\sqrt{3}}{3}\right)(y-2)\left(y - \frac{6+\sqrt{3}}{3}\right)(y-3)$

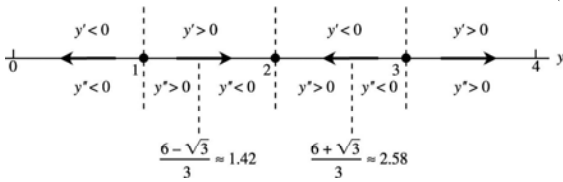

(c)

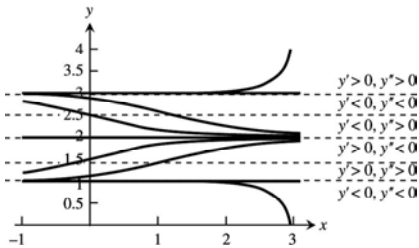

8. $y' = y^3 - y^2 = y^2(y-1)$

(a) $y = 0$ and $y = 1$ are unstable equilibria.

(b) $y'' = (3y^2 - 2y)(y^3 - y^2) = y^3(3y-2)(y-1)$

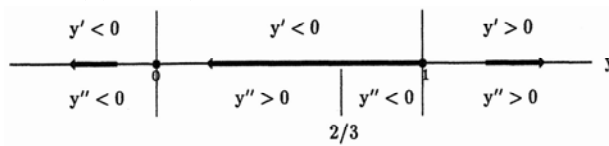

(c)

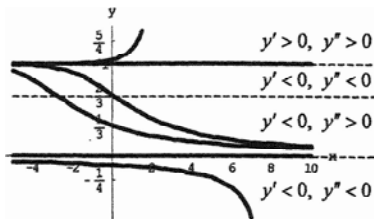

9. $\frac{dp}{dt} = 1 - 2P$ has a stable equilibrium at $P = \frac{1}{2}$. $\frac{d^2P}{dt^2} = -2\frac{dp}{dt} = -2(1 - 2P)$

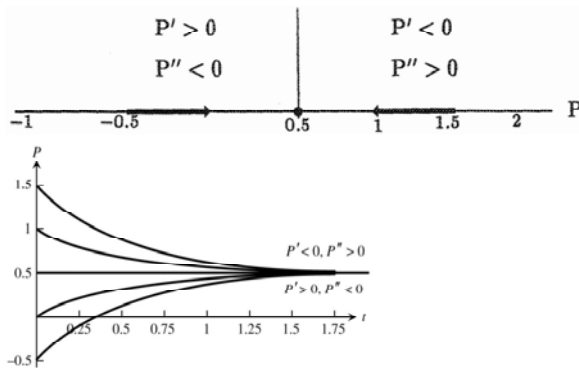

10. $\frac{dP}{dt} = P(1 - 2P)$ has an unstable equilibrium at $P = 0$ and a stable equilibrium at $P = \frac{1}{2}$.
 $\frac{d^2P}{dt^2} = (1 - 4P)\frac{dP}{dt} = P(1 - 4P)(1 - 2P)$

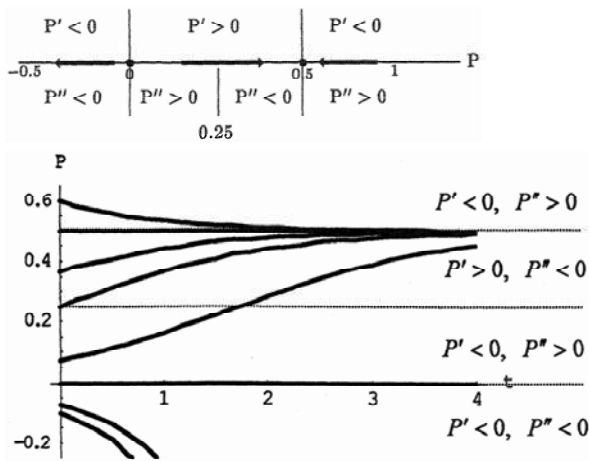

11. $\frac{dP}{dt} = 2P(P - 3)$ has a stable equilibrium at $P = 0$ and an unstable equilibrium at $P = 3$.
 $\frac{d^2P}{dt^2} = 2(2P - 3)\frac{dP}{dt} = 4P(2P - 3)(P - 3)$

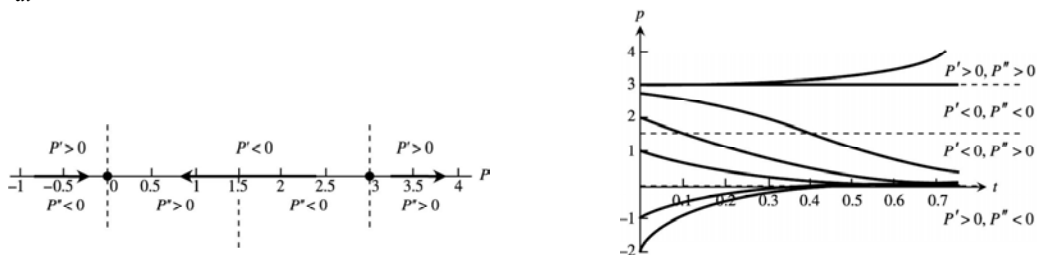

12. $\frac{dP}{dt} = 3P(1-P)\left(P - \frac{1}{2}\right)$ has a stable equilibria at $P = 0$ and $P = 1$ and an unstable equilibrium at $P = \frac{1}{2}$.

$$\frac{d^2P}{dt^2} = -\frac{3}{2}(6P^2 - 6P + 1)\frac{dP}{dt} = \frac{3}{2}P\left(P - \frac{3-\sqrt{3}}{6}\right)\left(P - \frac{1}{2}\right)\left(P - \frac{3+\sqrt{3}}{6}\right)(P-1)$$

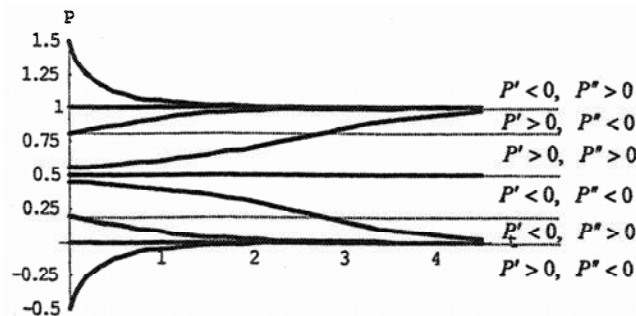
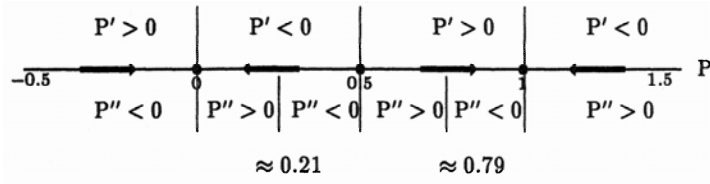

13.

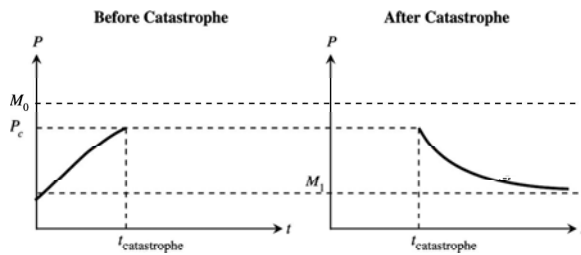

Before the catastrophe, the population exhibits logistic growth and $P(t) \rightarrow M_0$, the stable equilibrium. After the catastrophe, the population declines logistically and $P(t) \rightarrow M_1$, the new stable equilibrium.

14. $\frac{dP}{dt} = rP(M - P)(P - m)$, $r, M, m > 0$

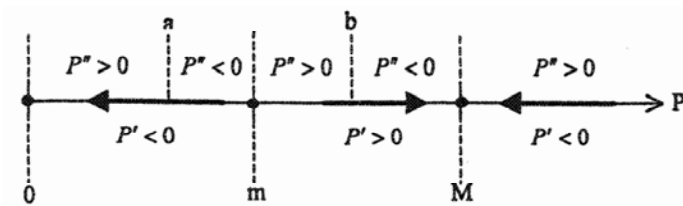

The model has 3 equilibrium points. The rest point $P = 0$, $P = M$ are asymptotically stable while $P = m$ is unstable. For initial populations greater than m , the model predicts P approaches M for large t . For initial populations less than m , the model predicts extinction. Points of inflection occur at $P = a$ and $P = b$ where

$$a = \frac{1}{3}\left[M + m - \sqrt{M^2 - mM + m^2}\right] \text{ and } b = \frac{1}{3}\left[M + m + \sqrt{M^2 - mM + m^2}\right].$$

(a) The model is reasonable in the sense that if $P < m$, then $P \rightarrow 0$ as $t \rightarrow \infty$; if $m < P < M$, then $P \rightarrow M$ as $t \rightarrow \infty$; if $P > M$, then $P \rightarrow M$ as $t \rightarrow \infty$.

- (b) It is different if the population falls below m , for then $P \rightarrow 0$ as $t \rightarrow \infty$ (extinction). It is probably a more realistic model for that reason because we know some populations have become extinct after the population level became too low.
- (c) For $P > M$ we see that $\frac{dP}{dt} = rP(M - P)(P - m)$ is negative. Thus the curve is everywhere decreasing. Moreover, $P \equiv M$ is a solution to the differential equation. Since the equation satisfies the existence and uniqueness conditions, solution trajectories cannot cross. Thus, $P \rightarrow M$ as $t \rightarrow \infty$.
- (d) See the initial discussion above.
- (e) See the initial discussion above.

15. $\frac{dv}{dt} = g - \frac{k}{m}v^2, g, k, m > 0$ and $v(t) \geq 0$

Equilibrium: $\frac{dv}{dt} = g - \frac{k}{m}v^2 = 0 \Rightarrow v = \sqrt{\frac{mg}{k}}$

Concavity: $\frac{d^2v}{dt^2} = -2\left(\frac{k}{m}v\right)\frac{dv}{dt} = -2\left(\frac{k}{m}v\right)\left(g - \frac{k}{m}v^2\right)$

(a)

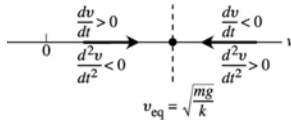

(b)

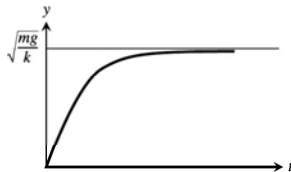

(c) $V_{\text{terminal}} = \sqrt{\frac{160}{0.005}} = 178.9 \frac{\text{ft}}{\text{s}} = 122 \text{ mph}$

16. $F = F_p - F_r$

$ma = mg - k\sqrt{v}$

$\frac{dv}{dt} = g - \frac{k}{m}\sqrt{v}, v(0) = v_0$

Thus, $\frac{dv}{dt} = 0$ implies $v = \left(\frac{mg}{k}\right)^2$, the terminal velocity. If $v_0 < \left(\frac{mg}{k}\right)^2$, the object will fall faster and faster, approaching the terminal velocity; if $v_0 > \left(\frac{mg}{k}\right)^2$, the object will slow down to the terminal velocity.

17. $F = F_p - F_r$

$ma = 50 - 5|v|$

$\frac{dv}{dt} = \frac{1}{m}(50 - 5|v|)$

The maximum velocity occurs when $\frac{dv}{dt} = 0$ or $v = 10 \frac{\text{ft}}{\text{sec}}$.

18. (a) The model seems reasonable because the rate of spread of a piece of information, an innovation, or a cultural fad is proportional to the product of the number of individuals who have it (X) and those who do not ($N - X$). When X is small, there are only a few individuals to spread the item so the rate of spread is slow. On the other hand, when $(N - X)$ is small the rate of spread will be slow because there are only a few individuals who can receive it during the interval of time. The rate of spread will be fastest when both X and $(N - X)$ are large because then there are a lot of individuals to spread the item and a lot of individuals to receive it.

(b) There is a stable equilibrium at $X = N$ and an unstable equilibrium at $X = 0$.

$$\frac{d^2x}{dt^2} = k \frac{dx}{dt} (N - X) - kX \frac{dx}{dt} = k^2 X(N - X)(N - 2X) \Rightarrow \text{inflection point at } X = 0, X = \frac{N}{2}, \text{ and } X = N.$$

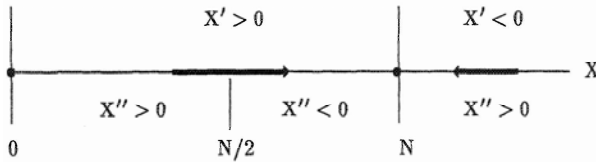

(c)

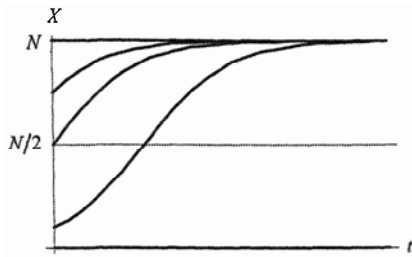

(d) The spread rate is most rapid when $x = \frac{N}{2}$. Eventually all of the people will receive the item.

19. $L \frac{di}{dt} + Ri = V \Rightarrow \frac{di}{dt} = \frac{V}{L} - \frac{R}{L}i = \frac{R}{L} \left(\frac{V}{R} - i \right), V, L, R > 0$

Equilibrium: $\frac{di}{dt} = \frac{R}{L} \left(\frac{V}{R} - i \right) = 0 \Rightarrow i = \frac{V}{R}$

Concavity: $\frac{d^2i}{dt^2} = -\left(\frac{R}{L}\right) \frac{di}{dt} = -\left(\frac{R}{L}\right)^2 \left(\frac{V}{R} - i \right)$

Phase Line:

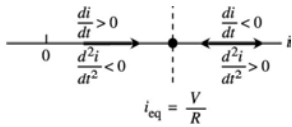

If the switch is closed at $t = 0$, then $i(0) = 0$, and the graph of the solution looks like this:

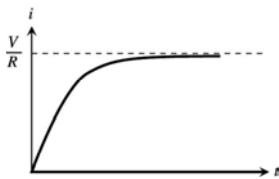

As $t \rightarrow \infty$, $i \rightarrow i_{\text{steady state}} = \frac{V}{R}$. (In the steady state condition, the self-inductance acts like a simple wire connector and, as a result, the current through the resistor can be calculated using the familiar version of Ohm's Law.)

20. (a) Free body diagram of the pearl:

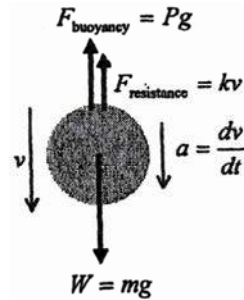

(b) Use Newton's Second Law, summing forces in the direction of the acceleration:

$$mg - Pg - kv = ma \Rightarrow \frac{dv}{dt} = \left(\frac{m-P}{m}\right)g - \frac{k}{m}v.$$

(c) Equilibrium: $\frac{dv}{dt} = \frac{k}{m} \left(\frac{(m-P)g}{k} - v\right) = 0$

$$\Rightarrow v_{\text{terminal}} = \frac{(m-P)g}{k}$$

$$\text{Concavity: } \frac{d^2v}{dt^2} = -\frac{k}{m} \frac{dv}{dt} = -\left(\frac{k}{m}\right)^2 \left(\frac{(m-P)g}{k} - v\right)$$

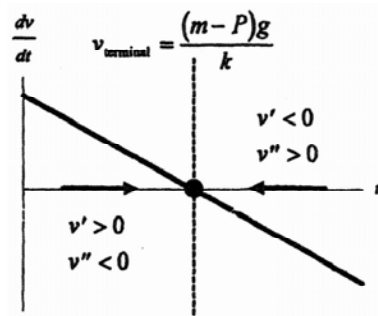

(d)

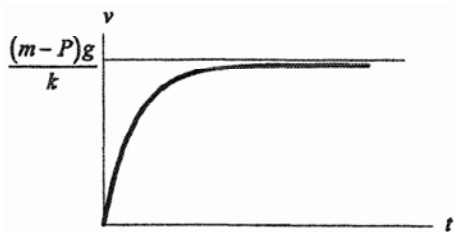

(e) The terminal velocity of the pearl is $\frac{(m-P)g}{k}$.

9.5 SYSTEMS OF EQUATIONS AND PHASE PLANES

1. Seasonal variations, nonconformity of the environments, effects of other interactions, unexpected disasters, etc.

$$2. \quad x = r \cos \theta \Rightarrow \frac{dx}{dt} = -r \sin \theta \frac{d\theta}{dt} + \cos \theta \frac{dr}{dt} = y + x - x(x^2 + y^2) = r \sin \theta + r \cos \theta - r^3 \cos \theta$$

$$y = r \sin \theta \Rightarrow \frac{dy}{dt} = r \cos \theta \frac{d\theta}{dt} + \sin \theta \frac{dr}{dt} = -x + y - y(x^2 + y^2) = -r \cos \theta + r \sin \theta - r^3 \sin \theta$$

Solve for $\frac{dr}{dt}$ by adding $\cos \theta \times \text{eq}(1)$ to $\sin \theta \times \text{eq}(2)$:

$$\cos^2 \theta \frac{dr}{dt} + \sin^2 \theta \frac{dr}{dt} = \cos \theta (r \sin \theta + r \cos \theta - r^3 \cos \theta) + \sin \theta (-r \cos \theta + r \sin \theta - r^3 \sin \theta)$$

$$\Rightarrow \frac{dr}{dt} = r \sin \theta \cos \theta + r \cos^2 \theta - r^3 \cos^2 \theta - r \sin \theta \cos \theta + r \sin^2 \theta - r^3 \sin^2 \theta = r - r^3 = r(1 - r^2)$$

Solve for $\frac{d\theta}{dt}$ by adding $(-\sin \theta) \times \text{eq}(1)$ to $\cos \theta \times \text{eq}(2)$: $\text{eq}(1)$ to $\cos \theta \times \text{eq}(2)$:

$$r \sin^2 \theta \frac{d\theta}{dt} + r \cos^2 \theta \frac{d\theta}{dt} = -\sin \theta (r \sin \theta + r \cos \theta - r^3 \cos \theta) + \cos \theta (-r \cos \theta + r \sin \theta - r^3 \sin \theta)$$

$$\Rightarrow r \frac{d\theta}{dt} = -r \sin^2 \theta - r \sin \theta \cos \theta + r^3 \sin \theta \cos \theta - r \cos^2 \theta + r \sin \theta \cos \theta - r^3 \sin \theta \cos \theta = -r \Rightarrow \frac{d\theta}{dt} = -1$$

If $r = 1$ (that is, the trajectory starts on the circle $x^2 + y^2 = 1$), then $\frac{dr}{dt}|_{r=1} = (1)(1 - (1)^2) = 0$, thus the trajectory remains on the circle, and rotates around the circle in a clockwise direction, since $\frac{d\theta}{dt} = -1$. The solution is periodic since at any point (x, y) on the trajectory, $(x, y) = (r \cos \theta, r \sin \theta) = (1 \cos \theta, 1 \sin \theta) = (\cos \theta, \sin \theta) \Rightarrow$ both x and y are periodic.

3. This model assumes that the number of interactions is proportional to the product of x and y :

$$\frac{dx}{dt} = (a - b y) x, \quad a < 0,$$

$$\frac{dy}{dt} = m \left(1 - \frac{y}{M}\right) y - n x y = y \left(m - \frac{m}{M} y - n x\right).$$

To find the equilibrium points:

$$\frac{dx}{dt} = 0 \Rightarrow (a - b y)x = 0 \Rightarrow x = 0 \text{ or } y = \frac{a}{b}$$

(remember $\frac{a}{b} < 0$);

$$\frac{dy}{dt} = 0 \Rightarrow y \left(m - \frac{m}{M} y - n x\right) \Rightarrow y = 0 \text{ or } y = -\frac{Mn}{m} x + M;$$

$$y = -\frac{Mn}{m} x + M;$$

Thus there are two equilibrium points, both occur when $x = 0$, $(0, 0)$ and $(0, M)$.

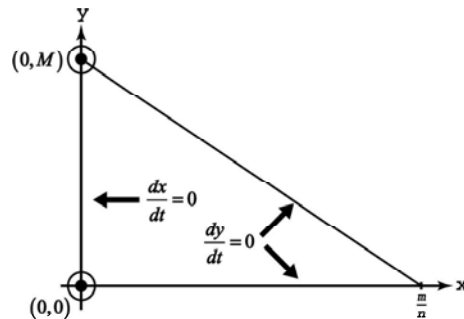

Implies coexistence is not possible because eventually trout die out and bass reach their population limit.

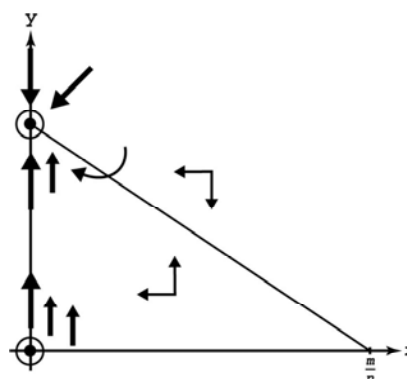

4. The coefficients $a, b, m,$ and n need to be determined by sampling or by analyzing historical data. Then, more specific graphical predictions can be made. These predictions would then have to be compared to actual population growth patterns. If the predictions match actual results, we have partially validated our model. If necessary, more tests could be run. However, it should be remembered that the primary purpose of a graphical analysis is to analyze the behavior qualitatively. With reference to Figure 9.29, attempt to maintain the fish populations in Region B through stocking and regulation (open and closed seasons). For example, should Regions A or D be entered, restocking the appropriate species can cause a return to Region B .

5. (a) Logistic growth occurs in the absence of the competitor, and simple interaction of the species: growth dominates the competition when either population is small so it is difficult to drive either species to extinction.

- (b) a = per capita growth rate for trout
 m = per capita growth rate for bass
 b = intensity of competition to the trout
 n = intensity of competition to the bass
 k_1 = environmental carrying capacity for the trout
 k_2 = environmental carrying capacity for the bass

(c) $\frac{dx}{dt} = 0 \Rightarrow a \left(1 - \frac{x}{k_1}\right) x - bxy = \left[a \left(1 - \frac{x}{k_1}\right) - by \right] x = 0 \Rightarrow x = 0$ or $a \left(1 - \frac{x}{k_1}\right) - by = 0 \Rightarrow x = 0$ or $y = \frac{a}{b} - \frac{a}{bk_1} x$;
 $\frac{dy}{dt} = 0 \Rightarrow m \left(1 - \frac{y}{k_2}\right) y - nxy = \left[m \left(1 - \frac{y}{k_2}\right) - nx \right] y = 0 \Rightarrow y = 0$ or $m \left(1 - \frac{y}{k_2}\right) - nx = 0 \Rightarrow y = 0$ or $y = k_2 - \frac{nk_2}{m} x$. There are five cases to consider.

Case I: $\frac{a}{b} > k_2$ and $\frac{m}{n} > k_1$.

By picking $\frac{a}{b} > k_2$ and $\frac{m}{n} > k_1$ we ensure an equilibrium point exists inside the first quadrant.

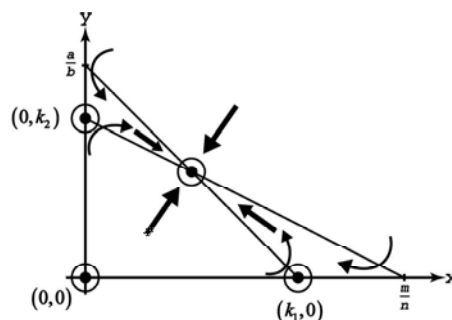
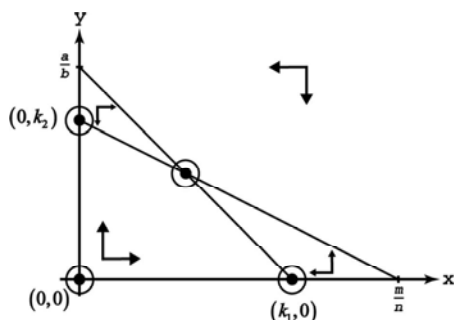

Graphical analysis implies four equilibrium points exist: $(0, 0), (k_1, 0), (0, k_2)$, and $\left(\frac{a m k_1 - b m k_1 k_2}{a m - b n k_1 k_2}, \frac{a m k_2 - a n k_1 k_2}{a m - b n k_1 k_2}\right)$ (the point of intersection of the two boundaries in the first quadrant).

All of these equilibrium points are unstable except for the point of intersection. The possibility of coexistence is predicted by this model.

Case II: $\frac{a}{b} > k_2$ and $\frac{m}{n} < k_1$.

- $(0, k_2)$: unstable
- $(k_1, 0)$: stable
- $(0, 0)$: unstable
- Trout wins: $(k_1, 0)$
- Not sensitive
- No coexistence

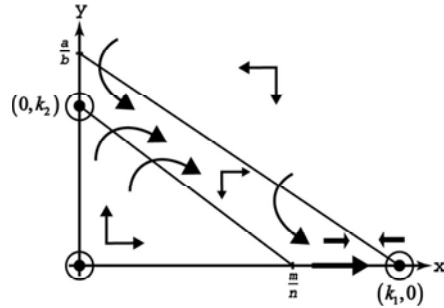

Case III: $\frac{a}{b} < k_2$ and $\frac{m}{n} > k_1$.

- $(0, k_2)$: stable
- $(k_1, 0)$: unstable
- $(0, 0)$: unstable
- Bass wins: $(0, k_2)$
- Not sensitive
- No coexistence

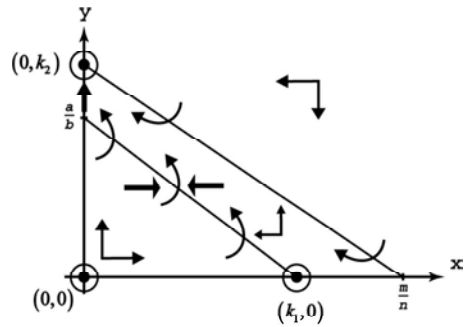

Case IV: $\frac{a}{b} < k_2$ and $\frac{m}{n} < k_1$.

- $(0, k_2)$: stable
- $(k_1, 0)$: stable
- $(0, 0)$: unstable
- $\left(\frac{a m k_1 - b m k_1 k_2}{a m - b n k_1 k_2}, \frac{a m k_2 - a n k_1 k_2}{a m - b n k_1 k_2}\right)$: unstable
- Bass or trout: $(0, k_2)$ or $(k_1, 0)$
- Very sensitive
- Coexistence is possible but not predicted

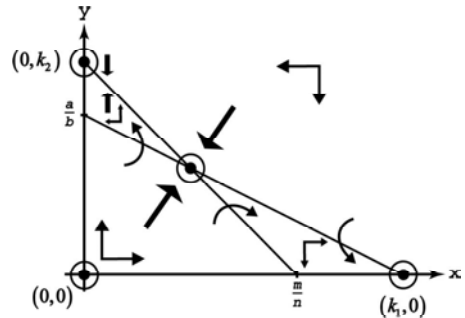

If we assume $\frac{a}{b} < k_2$ and $\frac{m}{n} < k_1$ then graphical analysis implies four equilibrium points exist:

$(0, k_2), (k_1, 0), (0, 0)$, and $\left(\frac{a m k_1 - b m k_1 k_2}{a m - b n k_1 k_2}, \frac{a m k_2 - a n k_1 k_2}{a m - b n k_1 k_2}\right)$ (the point of intersection of the two boundaries in the first quadrant).

Case V: $\frac{a}{b} = k_2$ and $\frac{a}{b k_1} = \frac{n k_2}{m}$ (lines coincide).

- $(0, k_2)$: stable
- $(k_1, 0)$: stable
- $(0, 0)$: unstable
- Line segment joining $(0, k_2)$ and $(k_1, 0)$: stable
- Bass wins: $(0, k_2)$
- Not sensitive
- Coexistence is likely outcome

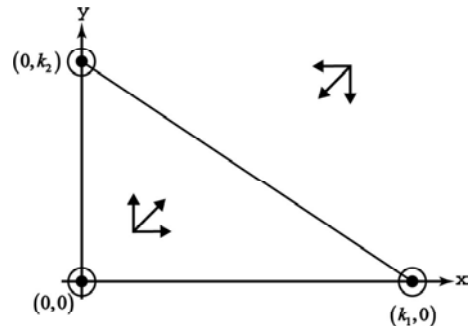

Note that all points on the line segment joining $(0, k_2)$ and $(k_1, 0)$ are rest points.

6. For a fixed price, as Q increases, $\frac{dP}{dt}$ gets smaller and, possibly, becomes negative. This observation implies that as the quantity supplied increases, the price will not rise as fast. If Q gets high enough, then the price will decrease. Next, consider $\frac{dQ}{dt}$: For a fixed quantity, as P increases, $\frac{dQ}{dt}$ gets larger. Thus, as the market price increases, the quantity supplied will increase at a faster rate. If P is too small, $\frac{dQ}{dt}$ will be negative and the quantity supplied will decrease. This observation is the traditional explanation of the effect of market price levels on the quantity supplied.

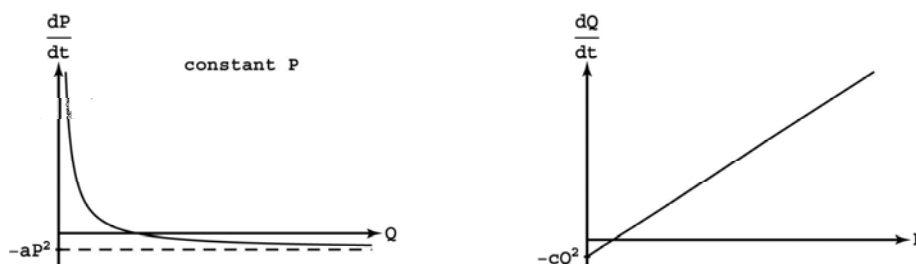

- (a) $\frac{dP}{dt} = 0$ and $\frac{dQ}{dt} = 0$ gives the equilibrium points $(P, Q): (0, 0)$ and $(25.8, 775)$. Now $\frac{dP}{dt} > 0$ when $PQ < 20,000$ and $P > 0$; $\frac{dP}{dt} < 0$ otherwise. $\frac{dQ}{dt} > 0$ when $P > \frac{Q}{30}$ and $Q > 0$; $\frac{dQ}{dt} < 0$ otherwise.
- (b) These considerations give the following graphical analysis:

Region	$\frac{dP}{dt}$	$\frac{dQ}{dt}$
I	> 0	< 0
II	> 0	> 0
III	< 0	< 0
IV	< 0	> 0

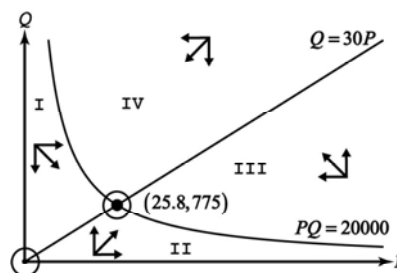

The equilibrium point $(0, 0)$ is unstable. The graphical analysis for the point $(25.8, 775)$ is inconclusive: trajectories near the point may be periodic, or may spiral toward or away from the point.

- (c) The curve $\frac{dP}{dt} = 0$ or $PQ = 20000$ can be thought of as the demand curve; $\frac{dQ}{dt} = 0$ or $Q = 30P$ can be viewed as the supply curve.
7. (a) $\frac{dx}{dt} = ax - bxy = (a - by)x$ and $\frac{dy}{dt} = my - nxy = (m - nx)y \Rightarrow \frac{dy}{dt} = \frac{dy}{dx} \frac{dx}{dt} \Rightarrow \frac{dy}{dx} = \frac{\frac{dy}{dt}}{\frac{dx}{dt}} = \frac{(m-nx)y}{(a-by)x}$
- (b) $\frac{dy}{dx} = \frac{(m-nx)y}{(a-by)x} \Rightarrow \left(\frac{a}{y} - b\right) dy = \left(\frac{m}{x} - n\right) dx \Rightarrow \int \left(\frac{a}{y} - b\right) dy = \int \left(\frac{m}{x} - n\right) dx \Rightarrow a \ln|y| - by = m \ln|x| - nx + C$
 $\Rightarrow \ln|y^a| + \ln e^{-by} = \ln|x^m| + \ln e^{-nx} + \ln e^C \Rightarrow \ln|y^a e^{-by}| = \ln|x^m e^{-nx} e^C| \Rightarrow y^a e^{-by} = x^m e^{-nx} e^C,$
 let $K = e^C \Rightarrow y^a e^{-by} = Kx^m e^{-nx}$
- (c) $f(y) = y^a e^{-by} \Rightarrow f'(y) = ay^{a-1} e^{-by} - by^a e^{-by} = y^{a-1} e^{-by} (a - by)$ and $f'(y) = 0 \Rightarrow y = 0$ or $y = \frac{a}{b}$;
 $f''\left(\frac{a}{b}\right) = -b \left(\frac{a}{b}\right)^{a-1} e^{-a} < 0 \Rightarrow f(y)$ has a unique max of $M_y = \left(\frac{a}{eb}\right)^a$ when $y = \frac{a}{b}$.
 $g(x) = x^m e^{-nx} \Rightarrow g'(x) = mx^{m-1} e^{-nx} - nx^m e^{-nx} = x^{m-1} e^{-nx} (m - nx)$ and $g'(x) = 0 \Rightarrow x = 0$ or $x = \frac{m}{n}$;
 $g''\left(\frac{m}{n}\right) = -n \left(\frac{m}{n}\right)^{m-1} e^{-m} < 0 \Rightarrow g(x)$ has a unique max of $M_x = \left(\frac{m}{en}\right)^m$ when $x = \frac{m}{n}$.

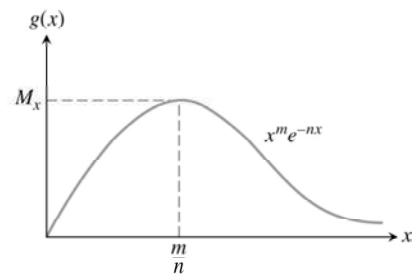
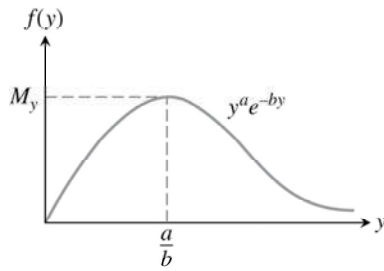

(d) Consider trajectory $(x, y) \rightarrow (\frac{m}{n}, \frac{a}{b})$. For $y^a e^{-by} = Kx^m e^{-nx} \Rightarrow \frac{y^a}{e^{by}} \cdot \frac{e^{nx}}{x^m} = K$, taking the limit of both sides $\Rightarrow \lim_{\substack{x \rightarrow m/n \\ y \rightarrow a/b}} \left(\frac{y^a}{e^{by}} \cdot \frac{e^{nx}}{x^m} \right) = \lim_{\substack{x \rightarrow m/n \\ y \rightarrow a/b}} K \Rightarrow \frac{M_y}{M_x} = K$. Thus, $\frac{y^a}{e^{by}} = \frac{M_y}{M_x} \frac{x^m}{e^{nx}}$ represents the equation any solution trajectory must satisfy if the trajectory approaches the rest point asymptotically.

(e) Pick initial condition $y_0 < \frac{a}{b}$. Then, from the figure at right,

$f(y_0) < M_y$ implies $\frac{M_y}{M_x} \frac{x^m}{e^{nx}} = \frac{y_0^a}{e^{by_0}} < M_y$ and thus

$\frac{x^m}{e^{nx}} < M_x$. From the figure for $g(x)$, there exists a unique

$x_0 < \frac{m}{n}$ satisfying $\frac{x^m}{e^{nx}} < M_x$. That is, for each $y < \frac{a}{b}$ there

is a unique x satisfying $\frac{y^a}{e^{by}} = \frac{M_y}{M_x} \frac{x^m}{e^{nx}}$. Thus, there can exist

only one trajectory solution approaching $(\frac{m}{n}, \frac{a}{b})$. (You can think of the point (x_0, y_0) as the initial condition for that trajectory.)

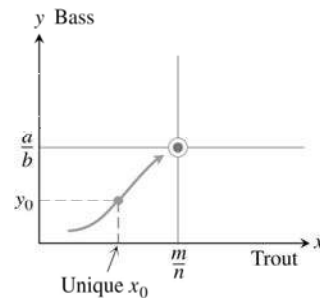

(f) Likewise there exists a unique trajectory when $y_0 > \frac{a}{b}$. Again, $f(y_0) < M_y$ implies $\frac{M_y}{M_x} \frac{x^m}{e^{nx}} = \frac{y_0^a}{e^{by_0}} < M_y$ and thus $\frac{x^m}{e^{nx}} < M_x$. From the figure for $g(x)$, there exists a unique $x_0 > \frac{m}{n}$ satisfying $\frac{x^m}{e^{nx}} < M_x$. That is, for each $y > \frac{a}{b}$ there is a unique x satisfying $\frac{y^a}{e^{by}} = \frac{M_y}{M_x} \frac{x^m}{e^{nx}}$. Thus, there can exist only one trajectory solution approaching $(\frac{m}{n}, \frac{a}{b})$.

8. Let $z = y' = \frac{dy}{dx} \Rightarrow \frac{dz}{dx} = z' = y''$, then given the differential equation $y'' = F(x, y, y')$, we can write it as the following system of first order differential equations: $\frac{dy}{dx} = z$

$$\frac{dz}{dx} = F(x, y, z)$$

In general, for the n th order differential equation given by $y^{(n)} = F(x, y, y', y'', \dots, y^{(n-1)})$, let $z_1 = y' = \frac{dy}{dx}$

$\Rightarrow \frac{dz_1}{dx} = z_1' = y''$, let $z_2 = z_1' = y'' \Rightarrow \frac{dz_2}{dx} = z_2' = y'''$, ..., let $z_{n-1} = z_{n-2}' = y^{(n-1)} \Rightarrow z_{n-1}' = y^{(n)}$. This gives us

the following system of first order differential equations: $\frac{dy}{dx} = z_1$

$$\frac{dz_1}{dx} = z_2$$

$$\frac{dz_2}{dx} = z_3$$

⋮

$$\frac{dz_{n-2}}{dx} = z_{n-1}$$

$$\frac{dz_{n-1}}{dx} = F(x, y, z_1, z_2, \dots, z_{n-1})$$

9. In the absence of foxes $\Rightarrow b = 0 \Rightarrow \frac{dx}{dt} = ax$ and the population of rabbits grows at a rate proportional to the number of rabbits.
10. In the absence of rabbits $\Rightarrow d = 0 \Rightarrow \frac{dy}{dt} = -cy$ and the population of foxes decays (since the foxes have no food source) at a rate proportional to the number of foxes.
11. $\frac{dx}{dt} = (a - by)x = 0 \Rightarrow y = \frac{a}{b}$ or $x = 0$; $\frac{dy}{dt} = (-c + dx)y = 0 \Rightarrow x = \frac{c}{d}$ or $y = 0 \Rightarrow$ equilibrium points at $(0, 0)$ or $(\frac{c}{d}, \frac{a}{b})$. For the point $(0, 0)$, there are no rabbits and no foxes. It is an unstable equilibrium point, if there are no foxes, but a few rabbits are introduced, then $\frac{dx}{dt} = a \Rightarrow$ the rabbit population will grow exponentially away from $(0, 0)$.
12. Let $x(t)$ and $y(t)$ both be positive and suppose that they satisfy the differential equations $\frac{dx}{dt} = (a - by)x$ and $\frac{dy}{dt} = (-c + dx)y$. Let $C(t) = a \ln y(t) - b \cdot y(t) - d \cdot x(t) + c \ln x(t) \Rightarrow C'(t) = a \frac{y'(t)}{y(t)} - b \cdot y'(t) - d \cdot x'(t) + c \frac{x'(t)}{x(t)}$
 $= \left(\frac{a}{y(t)} - b\right)y'(t) + \left(\frac{c}{x(t)} - d\right)x'(t) = \left(\frac{a}{y(t)} - b\right)(-c + dx(t))x(t) + \left(\frac{c}{x(t)} - d\right)(a - b \cdot y(t))y(t) = 0$
 Since $C'(t) = 0 \Rightarrow C(t) = \text{constant}$.
13. Consider a particular trajectory and suppose that (x_0, y_0) is such that $x_0 < \frac{c}{d}$ and $y_0 < \frac{a}{b}$, then $\frac{dx}{dt} > 0$ and $\frac{dy}{dt} < 0 \Rightarrow$ the rabbit population is increasing while the fox population is decreasing, points on the trajectory are moving down and to the right; if $x_0 > \frac{c}{d}$ and $y_0 < \frac{a}{b}$, then $\frac{dx}{dt} > 0$ and $\frac{dy}{dt} > 0 \Rightarrow$ both the rabbit and fox populations are increasing, points on the trajectory are moving up and to the right; if $x_0 > \frac{c}{d}$ and $y_0 > \frac{a}{b}$, then $\frac{dx}{dt} < 0$ and $\frac{dy}{dt} > 0 \Rightarrow$ the rabbit population is decreasing while the fox population is increasing, points on the trajectory are moving up and to the left; and finally if $x_0 < \frac{c}{d}$ and $y_0 > \frac{a}{b}$, then $\frac{dx}{dt} < 0$ and $\frac{dy}{dt} < 0 \Rightarrow$ both the rabbit and fox populations are decreasing, points on the trajectory are moving down and to the left. Thus, points travel around the trajectory in a counterclockwise direction. Note that we will follow the same trajectory if (x_0, y_0) starts at a different point on the trajectory.
14. There are three possible cases: If the rabbit population begins (before the wolf) and ends (after the wolf) at a value larger than the equilibrium level of $x = \frac{c}{d}$, then the trajectory moves closer to the equilibrium and the maximum value of the foxes is smaller. If the rabbit population begins (before the wolf) and ends (after the wolf) at a value smaller than the equilibrium level of $x = \frac{c}{d}$, but greater than 0, then the trajectory moves further from the equilibrium and the maximum value of the foxes is greater. If the rabbit population begins and ends very near the equilibrium value, then the trajectory will stay near the equilibrium value, since it is a stable equilibrium, and the fox population will remain roughly the same.

CHAPTER 9 PRACTICE EXERCISES

1. $y' = xe^y \sqrt{x-2} \Rightarrow e^{-y} dy = x\sqrt{x-2} dx \Rightarrow -e^{-y} = \frac{2(x-2)^{3/2}(3x+4)}{15} + C \Rightarrow e^{-y} = \frac{-2(x-2)^{3/2}(3x+4)}{15} - C$
 $\Rightarrow -y = \ln \left[\frac{-2(x-2)^{3/2}(3x+4)}{15} - C \right] \Rightarrow y = -\ln \left[\frac{-2(x-2)^{3/2}(3x+4)}{15} - C \right]$
2. $y' = xy e^{x^2} \Rightarrow \frac{dy}{y} = e^{x^2} x dx \Rightarrow \ln y = \frac{1}{2} e^{x^2} + C$
3. $\sec x dy + x \cos^2 y dx = 0 \Rightarrow \frac{dy}{\cos^2 y} = -\frac{x dx}{\sec x} \Rightarrow \tan y = -\cos x - x \sin x + C$
4. $2x^2 dx - 3\sqrt{y} \csc x dy = 0 \Rightarrow 3\sqrt{y} dy = \frac{2x^2}{\csc x} dx \Rightarrow 2y^{3/2} = 2(2-x^2)\cos x + 4x \sin x + C$
 $\Rightarrow y^{3/2} = (2-x^2)\cos x + 2x \sin x + C_1$
5. $y' = \frac{e^y}{xy} \Rightarrow ye^{-y} dy = \frac{dx}{x} \Rightarrow (y+1)e^{-y} = -\ln|x| + C$
6. $y' = xe^{x-y} \csc y \Rightarrow y' = \frac{xe^x}{e^y} \csc y \Rightarrow \frac{e^y}{\csc y} dy = xe^x dx \Rightarrow \frac{e^y}{2}(\sin y - \cos y) = (x-1)e^x + C$
7. $x(x-1)dy - y dx = 0 \Rightarrow x(x-1)dy = y dx \Rightarrow \frac{dy}{y} = \frac{dx}{x(x-1)} \Rightarrow \ln y = \ln(x-1) - \ln(x) + C$
 $\Rightarrow \ln y = \ln(x-1) - \ln(x) + \ln C_1 \Rightarrow \ln y = \ln \left(\frac{C_1(x-1)}{x} \right) \Rightarrow y = \frac{C_1(x-1)}{x}$
8. $y' = (y^2 - 1)(x^{-1}) \Rightarrow \frac{dy}{y^2 - 1} = \frac{dx}{x} \Rightarrow \frac{\ln \left(\frac{y-1}{y+1} \right)}{2} = \ln x + C \Rightarrow \ln \left(\frac{y-1}{y+1} \right) = 2 \ln x + \ln C_1 \Rightarrow \frac{y-1}{y+1} = C_1 x^2 = C_1 x$
9. $2y' - y = xe^{x/2} \Rightarrow y' - \frac{1}{2}y = \frac{x}{2}e^{x/2}$.
 $P(x) = -\frac{1}{2}, v(x) = e^{\int (-\frac{1}{2})dx} = e^{-x/2}$.
 $e^{-x/2}y' - \frac{1}{2}e^{-x/2}y = \left(e^{-x/2} \right) \left(\frac{x}{2} \right) \left(e^{x/2} \right) = \frac{x}{2} \Rightarrow \frac{d}{dx} \left(e^{-x/2}y \right) = \frac{x}{2} \Rightarrow e^{-x/2}y = \frac{x^2}{4} + C \Rightarrow y = e^{x/2} \left(\frac{x^2}{4} + C \right)$
10. $\frac{y'}{2} + y = e^{-x} \sin x \Rightarrow y' + 2y = 2e^{-x} \sin x$.
 $P(x) = 2, v(x) = e^{\int 2dx} = e^{2x}$.
 $e^{2x}y' + 2e^{2x}y = 2e^{2x}e^{-x} \sin x = 2e^x \sin x \Rightarrow \frac{d}{dx} \left(e^{2x}y \right) = 2e^x \sin x \Rightarrow e^{2x}y = e^x (\sin x - \cos x) + C$
 $\Rightarrow y = e^{-x} (\sin x - \cos x) + Ce^{-2x}$

$$11. \quad xy' + 2y = 1 - x^{-1} \Rightarrow y' + \left(\frac{2}{x}\right)y = \frac{1}{x} - \frac{1}{x^2}.$$

$$v(x) = e^{2\int \frac{dx}{x}} = e^{2\ln x} = e^{\ln x^2} = x^2.$$

$$x^2 y' + 2xy = x - 1 \Rightarrow \frac{d}{dx}(x^2 y) = x - 1 \Rightarrow x^2 y = \frac{x^2}{2} - x + C \Rightarrow y = \frac{1}{2} - \frac{1}{x} + \frac{C}{x^2}$$

$$12. \quad xy' - y = 2x \ln x \Rightarrow y' - \left(\frac{1}{x}\right)y = 2 \ln x.$$

$$v(x) = e^{-\int \frac{dx}{x}} = e^{-\ln x} = \frac{1}{x}.$$

$$\left(\frac{1}{x}\right)y' - \left(\frac{1}{x}\right)^2 y = \frac{2}{x} \ln x \Rightarrow \frac{d}{dx}\left(\frac{1}{x} \cdot y\right) = \frac{2}{x} \ln x \Rightarrow \frac{1}{x} \cdot y = [\ln x]^2 + C \Rightarrow y = x[\ln x]^2 + Cx$$

$$13. \quad (1 + e^x)dy + (ye^x + e^{-x})dx = 0 \Rightarrow (1 + e^x)y' + e^x y = -e^{-x} \Rightarrow y' = \frac{-e^{-x}}{1 + e^x} y = \frac{-e^{-x}}{1 + e^x}.$$

$$v(x) = e^{\int \frac{e^x dx}{1 + e^x}} = e^{\ln(e^x + 1)} = e^x + 1.$$

$$(e^x + 1)y' + (e^x + 1)\left(\frac{e^x}{1 + e^x}\right)y = \frac{-e^{-x}}{1 + e^x}(e^x + 1) \Rightarrow \frac{d}{dx}[(e^x + 1)y] = -e^{-x} \Rightarrow (e^x + 1)y = e^{-x} + C$$

$$\Rightarrow y = \frac{e^{-x} + C}{e^x + 1} = \frac{e^{-x} + C}{1 + e^x}$$

$$14. \quad e^{-x}dy + (e^{-x}y - 4x)dx = 0 \Rightarrow \frac{dy}{dx} + y = 4xe^x \Rightarrow p(x) = 1, \quad v(x) = e^{\int 1 dx} = e^x \Rightarrow e^x \frac{dy}{dx} + ye^x = 4xe^{2x}$$

$$\Rightarrow \frac{d}{dx}(ye^x) = 4xe^{2x} \Rightarrow ye^x = \int 4xe^{2x} dx \Rightarrow ye^x = 2xe^{2x} - e^{2x} + C \Rightarrow y = 2xe^x - e^x + Ce^{-x}$$

$$15. \quad (x + 3y^2)dy + y dx = 0 \Rightarrow x dy + y dx = -3y^2 dy \Rightarrow \frac{d}{dx}(xy) = -3y^2 dy \Rightarrow xy = -y^3 + C$$

$$16. \quad x dy + (3y - x^{-2} \cos x)dx = 0 \Rightarrow y' + \left(\frac{3}{x}\right)y = x^{-3} \cos x. \text{ Let } v(y) = e^{\int \frac{3dx}{x}} = e^{3 \ln x} = e^{\ln x^3} = x^3.$$

$$\text{Then } x^3 y' + 3x^2 y = \cos x \text{ and } x^3 y = \int \cos x dx = \sin x + C. \text{ So } y = x^{-3}(\sin x + C)$$

$$17. \quad (x+1)\frac{dy}{dx} + 2y = x \Rightarrow y' + \left(\frac{2}{x+1}\right)y = \frac{x}{x+1}. \text{ Let } v(x) = e^{\int \frac{2}{x+1} dx} = e^{2 \ln(x+1)} = e^{\ln(x+1)^2} = (x+1)^2.$$

$$\text{So } y'(x+1)^2 + \frac{2}{(x+1)}(x+1)^2 y = \frac{x}{(x+1)}(x+1)^2 \Rightarrow \frac{d}{dx}[y(x+1)^2] = x(x+1) \Rightarrow y(x+1)^2 = \int x(x+1) dx$$

$$\Rightarrow y(x+1)^2 = \frac{x^3}{3} + \frac{x^2}{2} + C \Rightarrow y = (x+1)^{-2} \left(\frac{x^3}{3} + \frac{x^2}{2} + C \right). \text{ We have } y(0) = 1 \Rightarrow 1 = C. \text{ So}$$

$$y = (x+1)^{-2} \left(\frac{x^3}{3} + \frac{x^2}{2} + 1 \right)$$

$$18. \quad x \frac{dy}{dx} + 2y = x^2 + 1 \Rightarrow y' + \left(\frac{2}{x}\right)y = x + \frac{1}{x}. \text{ Let } v(x) = e^{\int \left(\frac{2}{x}\right) dx} = e^{\ln x^2} = x^2. \text{ So } x^2 y' + 2xy = x^3 + x$$

$$\Rightarrow \frac{d}{dx}(x^2 y) = x^3 + x \Rightarrow x^2 y = \frac{x^4}{4} + \frac{x^2}{2} + C \Rightarrow y = \frac{x^2}{4} + \frac{C}{x^2} + \frac{1}{2}. \text{ We have } y(1) = 1 \Rightarrow 1 = \frac{1}{4} + C + \frac{1}{2} \Rightarrow C = \frac{1}{4}.$$

$$\text{So } y = \frac{x^2}{4} + \frac{1}{4x^2} + \frac{1}{2} = \frac{x^4 + 2x^2 + 1}{4x^2}$$

19. $\frac{dy}{dx} + 3x^2y = x^2$. Let $v(x) = e^{\int 3x^2 dx} = e^{x^3}$. So $e^{x^3}y' + 3x^2e^{x^3}y = x^2e^{x^3} \Rightarrow \frac{d}{dx}(e^{x^3}y) = x^2e^{x^3}$
 $\Rightarrow e^{x^3}y = \frac{1}{3}e^{x^3} + C$. We have $y(0) = -1 \Rightarrow e^{0^3}(-1) = \frac{1}{3}e^{0^3} + C \Rightarrow -1 = \frac{1}{3} + C \Rightarrow C = -\frac{4}{3}$ and $e^{x^3}y = \frac{1}{3}e^{x^3} - \frac{4}{3}$
 $\Rightarrow y = \frac{1}{3} - \frac{4}{3}e^{-x^3}$
20. $xy' + (y - \cos x)dx = 0 \Rightarrow xy' + y - \cos x = 0 \Rightarrow y' + \left(\frac{1}{x}\right)y = \frac{\cos x}{x}$. Let $v(x) = e^{\int \frac{1}{x} dx} = e^{\ln x} = x$.
 So $xy' + x\left(\frac{1}{x}\right)y = \cos x \Rightarrow \frac{d}{dx}(xy) = \cos x \Rightarrow xy = \int \cos x dx \Rightarrow xy = \sin x + C$.
 We have $y\left(\frac{\pi}{2}\right) = 0 \Rightarrow \left(\frac{\pi}{2}\right)0 = 1 + C \Rightarrow C = -1$. So $xy = -1 + \sin x \Rightarrow y = \frac{-1 + \sin x}{x}$
21. $xy' + (x-2)y = 3x^3e^{-x} \Rightarrow y' + \left(\frac{x-2}{x}\right)y = 3x^2e^{-x}$. Let $v(x) = e^{\int \left(\frac{x-2}{x}\right) dx} = e^{x-2\ln x} = \frac{e^x}{x^2}$.
 So $\frac{e^x}{x^2}y' + \frac{e^x}{x^2}\left(\frac{x-2}{x}\right)y = 3 \Rightarrow \frac{d}{dx}\left(y \cdot \frac{e^x}{x^2}\right) = 3 \Rightarrow y \cdot \frac{e^x}{x^2} = 3x + C$. We have $y(1) = 0 \Rightarrow 0 = 3(1) + C \Rightarrow C = -3$
 $\Rightarrow y \cdot \frac{e^x}{x^2} = 3x - 3 \Rightarrow y = x^2e^{-x}(3x - 3)$
22. $y dx + (3x - xy + 2) dy = 0 \Rightarrow \frac{dx}{dy} + \frac{3x - xy + 2}{y} = 0 \Rightarrow \frac{dx}{dy} + \frac{3x}{y} - x = -\frac{2}{y} \Rightarrow \frac{dx}{dy} + \left(\frac{3}{y} - 1\right)x = -\frac{2}{y}$.
 $P(y) = \frac{3}{y} - 1 \Rightarrow \int P(y) dy = 3 \ln y - y \Rightarrow v(y) = e^{3 \ln y - y} = y^3 e^{-y}$
 $y^3 e^{-y} x' + y^3 e^{-y} \left(\frac{3}{y} - 1\right)x = -2y^2 e^{-y} \Rightarrow y^3 e^{-y} x = \int -2y^2 e^{-y} dy = 2e^{-y} (y^2 + 2y + 2) + C$
 $\Rightarrow y^3 = \frac{2(y^2 + 2y + 2) + Ce^y}{x}$. We have $y(2) = -1 \Rightarrow -1 = \frac{2(1 - 2 + 2) + Ce^{-1}}{2} \Rightarrow C = -4e$ and $\Rightarrow y^3 = \frac{2(y^2 + 2y + 2) - 4e^{y+1}}{x}$
23. To find the approximate values let $y_n = y_{n-1} + (y_{n-1} + \cos x_{n-1})(0.1)$ with $x_0 = 0, y_0 = 0$, and 20 steps. Use a spreadsheet, graphing calculator, or CAS to obtain the values in the following table.

x	y	x	y
0	0	1.1	1.6241
0.1	0.1000	1.2	1.8319
0.2	0.2095	1.3	2.0513
0.3	0.3285	1.4	2.2832
0.4	0.4568	1.5	2.5285
0.5	0.5946	1.6	2.7884
0.6	0.7418	1.7	3.0643
0.7	0.8986	1.8	3.3579
0.8	1.0649	1.9	3.6709
0.9	1.2411	2.0	4.0057
1.0	1.4273		

24. To find the approximate values let $y_n = y_{n-1} + (2 - y_{n-1})(2x_{n-1} + 3)(0.1)$ with $x_0 = -3, y_0 = 1$, and 20 steps. Use a spreadsheet, graphing calculator, or CAS to obtain the values in the following table.

x	y	x	y
-3.0	1.0000	-1.9	-5.3172
-2.9	0.7000	-1.8	-5.9026
-2.8	0.3360	-1.7	-6.3768
-2.7	-0.0966	-1.6	-6.7119
-2.6	-0.5998	-1.5	-6.8861
-2.5	-1.1718	-1.4	-6.8861
-2.4	-1.8062	-1.3	-6.7084
-2.3	-2.4913	-1.2	-6.3601
-2.2	-3.2099	-1.1	-5.8585
-2.1	-3.9393	-1.0	-5.2298
-2.0	-4.6520		

25. To estimate $y(3)$, let $y = y_{n-1} + \left(\frac{x_{n-1} - 2y_{n-1}}{x_{n-1} + 1}\right)(0.05)$ with initial values $x_0 = 0, y_0 = 1$, and 60 steps. Use a spreadsheet, graphing calculator, or CAS to obtain $y(3) \approx 0.8981$.
26. To estimate $y(4)$, let $z_n = y_{n-1} + \left(\frac{x_{n-1}^2 - 2y_{n-1} + 1}{x_{n-1}}\right)(0.05)$ with initial values $x_0 = 1, y_0 = 1$, and 60 steps. Use a spreadsheet, graphing calculator, or CAS to obtain $y(4) \approx 4.4974$.
27. Let $y_n = y_{n-1} + \left(\frac{1}{e^{x_{n-1} + y_{n-1} + 2}}\right)(dx)$ with starting values $x_0 = 0$ and $y_0 = 2$, and steps of 0.1 and -0.1 . Use a spreadsheet, programmable calculator, or CAS to generate the following graphs.

(a)

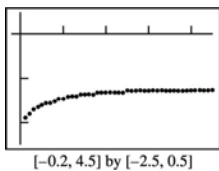

- (b) Note that we choose a small interval of x -values because the y -values decrease very rapidly and our calculator cannot handle the calculations for $x \leq -1$. (This occurs because the analytic solution is $y = -2 + \ln(2 - e^{-x})$, which has an asymptote at $x = -\ln 2 \approx 0.69$. Obviously, the Euler approximations are misleading for $x \leq -0.7$.)

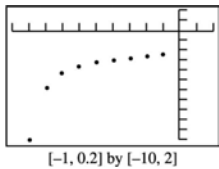

28. Let $y_n = y_{n-1} - \left(\frac{x_{n-1}^2 + y_{n-1}}{e^{y_{n-1} + x_{n-1}}} \right) (\Delta x)$ with starting values $x_0 = 0$ and $y_0 = 0$, and steps of 0.1 and -0.1 . Use a spreadsheet, programmable calculator, or CAS to generate the following graphs.

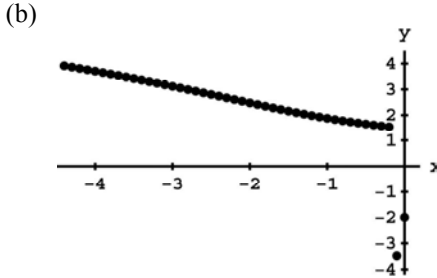
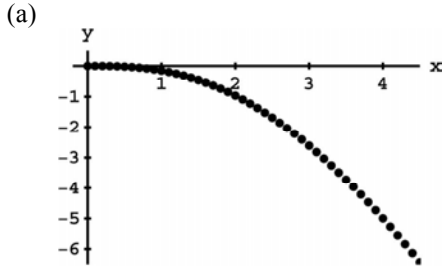

29.

x	1	1.2	1.4	1.6	1.8	2.0
y	-1	-0.8	-0.56	-0.28	0.04	0.4

$$\frac{dy}{dx} = x \Rightarrow dy = x dx \Rightarrow y = \frac{x^2}{2} + C; \quad x = 1 \text{ and } y = -1$$

$$\Rightarrow -1 = \frac{1}{2} + C \Rightarrow C = -\frac{3}{2} \Rightarrow y(\text{exact}) = \frac{x^2}{2} - \frac{3}{2}$$

$$\Rightarrow y(2) = \frac{2^2}{2} - \frac{3}{2} = \frac{1}{2} \text{ is the exact value.}$$

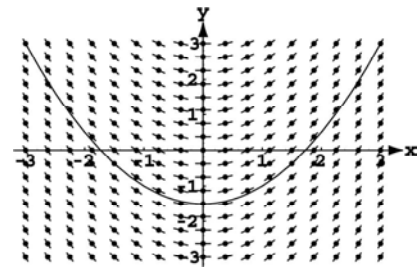

30.

x	1	1.2	1.4	1.6	1.8	2.0
y	-1	-0.8	-0.6333	-0.4904	-0.3654	-0.2544

$$\frac{dy}{dx} = \frac{1}{x} \Rightarrow dy = \frac{1}{x} dx \Rightarrow y = \ln|x| + C; \quad x = 1 \text{ and } y = -1$$

$$\Rightarrow -1 = \ln 1 + C \Rightarrow C = -1 \Rightarrow y(\text{exact}) = \ln|x| - 1$$

$$\Rightarrow y(2) = \ln 2 - 1 \approx -0.3069 \text{ is the exact value.}$$

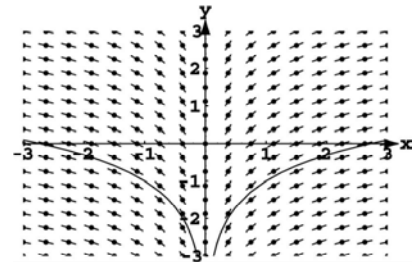

31.

x	1	1.2	1.4	1.6	1.8	2.0
y	-1	-1.2	-0.488	-1.9046	-2.5141	-3.4192

$$\frac{dy}{dx} = xy \Rightarrow \frac{dy}{y} = x dx \Rightarrow \ln|y| = \frac{x^2}{2} + C$$

$$\Rightarrow y = e^{\frac{x^2}{2} + C} = e^{\frac{x^2}{2}} \cdot e^C = C_1 e^{\frac{x^2}{2}}; \quad x = 1 \text{ and } y = -1$$

$$\Rightarrow -1 = C_1 e^{1/2} \Rightarrow C_1 = -e^{-1/2} \Rightarrow y(\text{exact}) = -e^{-1/2} \cdot e^{\frac{x^2}{2}}$$

$$= -e^{(x^2-1)/2} \Rightarrow y(2) = -e^{3/2} \approx -4.4817 \text{ is the exact value.}$$

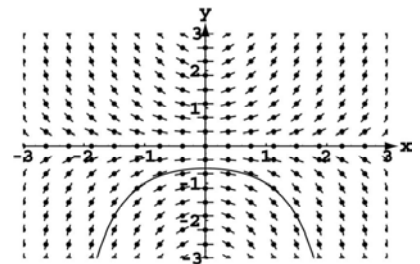

32.

x	1	1.2	1.4	1.6	1.8	2.0
y	-1	-1.2	-1.3667	-1.5130	-1.6452	-1.7688

$$\frac{dy}{dx} = \frac{1}{y} \Rightarrow y dy = dx \Rightarrow \frac{y^2}{2} = x + C; \quad x = 1 \text{ and } y = -1$$

$$\frac{1}{2} = 1 + C \Rightarrow C = -\frac{1}{2} \Rightarrow y^2 = 2x - 1$$

$$\Rightarrow y(\text{exact}) = \sqrt{2x-1} \Rightarrow y(2) = \sqrt{3} \approx 1.7321 \text{ is the exact value.}$$

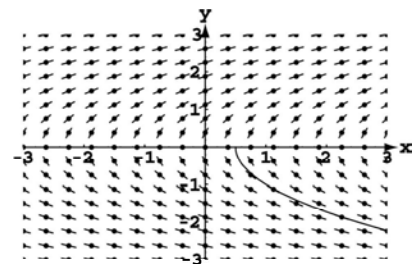

33. $\frac{dy}{dx} = y^2 - 1 \Rightarrow y' = (y+1)(y-1)$. We have $y' = 0 \Rightarrow (y+1) = 0, (y-1) = 0 \Rightarrow y = -1, 1$.

(a) Equilibrium points are -1 (stable) and 1 (unstable)

(b) $y' = y^2 - 1 \Rightarrow y'' = 2yy' \Rightarrow y'' = 2y(y^2 - 1) = 2y(y+1)(y-1)$. So $y'' = 0 \Rightarrow y = 0, y = -1, y = 1$.

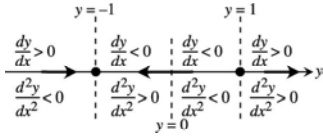

(c)

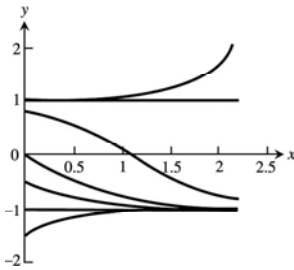

34. $\frac{dy}{dx} = y - y^2 \Rightarrow y' = y(1 - y)$. We have $y' = 0 \Rightarrow y(1 - y) = 0 \Rightarrow y = 0, 1 - y = 0 \Rightarrow y = 0, 1$.

(a) The equilibrium points are 0 and 1 . So, 0 is unstable and 1 is stable.

(b) Let \rightarrow = increasing. \leftarrow = decreasing.

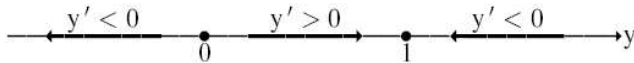

$$y' = y - y^2 \Rightarrow y'' = y' - 2yy' \Rightarrow y'' = (y - y^2) - 2y(y - y^2) = y - y^2 - 2y^2 + 2y^3 \Rightarrow y'' = 2y^3 - 3y^2 + y$$

$$= y(2y^2 - 3y + 1) \Rightarrow y'' = y(2y - 1)(y - 1)$$

So, $y'' = 0 \Rightarrow y = 0, 2y - 1 = 0, y - 1 = 0 \Rightarrow y = 0, y = \frac{1}{2}, y = 1$.

Let \rightarrow = concave up, \leftarrow = concave down.

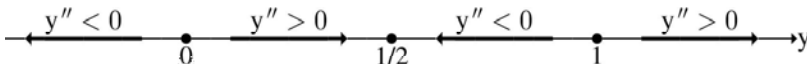

(c)

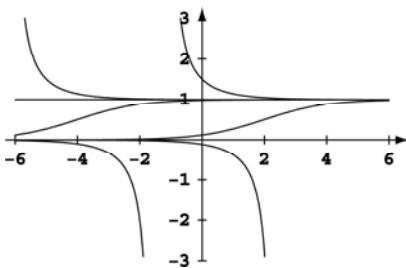

35. (a) Force = Mass times Acceleration (Newton's Second Law) or $F = ma$. Let $a = \frac{dv}{dt} = \frac{dv}{ds} \cdot \frac{ds}{dt} = v \frac{dv}{ds}$. Then

$$ma = -mgR^2 s^{-2} \Rightarrow a = -gR^2 s^{-2} \Rightarrow v \frac{dv}{ds} = -gR^2 s^{-2} \Rightarrow v dv = -gR^2 s^{-2} ds \Rightarrow \int v dv = \int -gR^2 s^{-2} ds$$

$$\Rightarrow \frac{v^2}{2} = \frac{gR^2}{s} + C_1 \Rightarrow v^2 = \frac{2gR^2}{s} + 2C_1 = \frac{2gR^2}{s} + C$$

When $t = 0, v = v_0$ and $s = R \Rightarrow v_0^2 = \frac{2gR^2}{R} + C$

$$\Rightarrow C = v_0^2 - 2gR \Rightarrow v^2 = \frac{2gR^2}{s} + v_0^2 - 2gR$$

(b) If $v_0 = \sqrt{2gR}$, the $v^2 = \frac{2gR^2}{s} \Rightarrow v = \sqrt{\frac{2gR^2}{s}}$, since $v \geq 0$ if $v_0 \geq \sqrt{2gR}$. Then $\frac{ds}{dt} = \frac{\sqrt{2gR^2}}{\sqrt{s}}$
 $\Rightarrow \sqrt{s} ds = \sqrt{2gR^2} dt \Rightarrow \int s^{1/2} ds = \int \sqrt{2gR^2} dt \Rightarrow \frac{2}{3}s^{3/2} = \sqrt{2gR^2}t + C_1 \Rightarrow s^{3/2} = \left(\frac{3}{2}\sqrt{2gR^2}\right)t + C$; $t = 0$
 and $s = R \Rightarrow R^{3/2} = \left(\frac{3}{2}\sqrt{2gR^2}\right)(0) + C \Rightarrow C = R^{3/2} \Rightarrow s^{3/2} = \left(\frac{3}{2}\sqrt{2gR^2}\right)t + R^{3/2} = \left(\frac{3}{2}R\sqrt{2g}\right)t + R^{3/2}$
 $= R^{3/2} \left[\left(\frac{3}{2}R^{-1/2}\sqrt{2g}\right)t + 1 \right] = R^{3/2} \left[\left(\frac{3\sqrt{2gR}}{2R}\right)t + 1 \right] = R^{3/2} \left[\left(\frac{3v_0}{2R}\right)t + 1 \right] \Rightarrow s = R \left[1 + \left(\frac{3v_0}{2R}\right)t \right]^{2/3}$

36. $\frac{v_0 m}{k} = \text{coasting distance} \Rightarrow \frac{(0.86)(30.84)}{k} = 0.97 \Rightarrow k \approx 27.343$. $s(t) = \frac{v_0 m}{k} (1 - e^{-(k/m)t})$
 $\Rightarrow s(t) = 0.97 (1 - e^{-(27.343/30.84)t}) \Rightarrow s(t) = 0.97 (1 - e^{-0.8866t})$. A graph of the model is shown superimposed on a graph of the data.

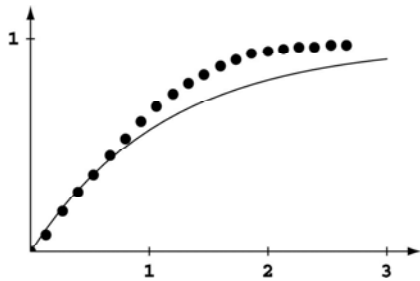

CHAPTER 9 ADDITIONAL AND ADVANCED EXERCISES

1. (a) $\frac{dy}{dt} = k \frac{A}{V} (c - y) \Rightarrow dy = -k \frac{A}{V} (y - c) dt \Rightarrow \frac{dy}{y - c} = -k \frac{A}{V} dt \Rightarrow \int \frac{dy}{y - c} = -\int k \frac{A}{V} dt \Rightarrow \ln|y - c| = -k \frac{A}{V} t + C_1$
 $\Rightarrow y - c = \pm e^{C_1} e^{-k \frac{A}{V} t}$. Apply the initial condition, $y(0) = y_0 \Rightarrow y_0 = c + C \Rightarrow C = y_0 - c$
 $\Rightarrow y = c + (y_0 - c) e^{-k \frac{A}{V} t}$.

(b) Steady state solution: $y_\infty = \lim_{t \rightarrow \infty} y(t) = \lim_{t \rightarrow \infty} \left[c + (y_0 - c) e^{-k \frac{A}{V} t} \right] = c + (y_0 - c)(0) = c$

2. $\frac{d(mv)}{dt} = F + (v + u) \frac{dm}{dt} \Rightarrow F = \frac{d(mv)}{dt} - (v + u) \frac{dm}{dt} \Rightarrow F = m \frac{dv}{dt} + v \frac{dm}{dt} - v \frac{dm}{dt} - u \frac{dm}{dt} \Rightarrow F = m \frac{dv}{dt} - u \frac{dm}{dt}$.
 $\frac{dm}{dt} = -b \Rightarrow m = -|b|t + C$. At $t = 0, m = m_0$, so $C = m_0$ and $m = m_0 - |b|t$.

Thus $F = (m_0 - |b|t) \frac{dv}{dt} - u|b| = -(m_0 - |b|t)|g| \Rightarrow \frac{dv}{dt} = -g + \frac{u|b|}{m_0 - |b|t} \Rightarrow v = -gt - u \ln \left(\frac{m_0 - |b|t}{m_0} \right) + C_1$

$v = 0$ at $t = 0 \Rightarrow C_1 = 0$. So $v = -gt - u \ln \left(\frac{m_0 - |b|t}{m_0} \right) = \frac{dy}{dt} \Rightarrow y = \int \left[-gt - u \ln \left(\frac{m_0 - |b|t}{m_0} \right) \right] dt$ and $u = c, y = 0$ at

$t = 0 \Rightarrow y = -\frac{1}{2}gt^2 + c \left[t + \left(\frac{m_0 - |b|t}{|b|} \right) \ln \left(\frac{m_0 - |b|t}{m_0} \right) \right]$

3. (a) Let y be any function such that $v(x)y = \int v(x)Q(x)dx + C$, $v(x) = e^{\int P(x)dx}$. Then
- $$\frac{d}{dx}(v(x) \cdot y) = v(x) \cdot y' + y \cdot v'(x) = v(x)Q(x). \text{ We have } v(x) = e^{\int P(x)dx}$$
- $$\Rightarrow v'(x) = e^{\int P(x)dx} P(x) = v(x)P(x). \text{ Thus } v(x) \cdot y' + y \cdot v(x)P(x) = v(x)Q(x) \Rightarrow y' + yP(x) = Q(x) \Rightarrow \text{ the given } y \text{ is a solution.}$$
- (b) If v and Q are continuous on $[a, b]$ and $x \in (a, b)$, then $\frac{d}{dx} \left[\int_{x_0}^x v(t)Q(t)dt \right] = v(x)Q(x)$
- $$\Rightarrow \int_{x_0}^x v(t)Q(t)dt = \int v(x)Q(x)dx. \text{ So } C = y_0v(x_0) - \int v(x)Q(x)dx. \text{ From part (a),}$$
- $$v(x)y = \int v(x)Q(x)dx + C. \text{ Substituting for } C: v(x)y = \int v(x)Q(x)dx + y_0v(x_0) - \int v(x)Q(x)dx$$
- $$\Rightarrow v(x)y = y_0v(x_0) \text{ when } x = x_0.$$
4. (a) $y' + P(x)y = 0, y(x_0) = 0$. Use $v(x) = e^{\int P(x)dx}$ as an integrating factor. Then $\frac{d}{dx}(v(x)y) = 0$
- $$\Rightarrow v(x)y = C \Rightarrow y = Ce^{-\int P(x)dx} \text{ and } y_1 = C_1e^{-\int P(x)dx}, y_2 = C_2e^{-\int P(x)dx}, y_1(x_0) = y_2(x_0) = 0,$$
- $$y_1 - y_2 = (C_1 - C_2)e^{-\int P(x)dx} = C_3e^{-\int P(x)dx} \text{ and } y_1 - y_2 = 0 - 0 = 0. \text{ So } y_1 - y_2 \text{ is a solution to}$$
- $$y' + P(x)y = 0 \text{ with } y(x_0) = 0.$$
- (b) $\frac{d}{dx}(v(x)[y_1(x) - y_2(x)]) = \frac{d}{dx} \left(e^{\int P(x)dx} \left[e^{-\int P(x)dx} (C_1 - C_2) \right] \right) = \frac{d}{dx}(C_1 - C_2) = \frac{d}{dx}(C_3) = 0.$
- $$\int \frac{d}{dx}(v(x)[y_1(x) - y_2(x)]) dx = (v(x)[y_1(x) - y_2(x)]) = \int 0 dx = C$$
- (c) $y_1 = C_1e^{-\int P(x)dx}, y_2 = C_2e^{-\int P(x)dx}, y = y_1 - y_2$. So $y(x_0) = 0 \Rightarrow C_1e^{-\int P(x)dx} - C_2e^{-\int P(x)dx} = 0$
- $$\Rightarrow C_1 - C_2 = 0 \Rightarrow C_1 = C_2 \Rightarrow y_1(x) = y_2(x) \text{ for } a < x < b.$$
5. $(x^2 + y^2)dx + xydy = 0 \Rightarrow \frac{dy}{dx} = \frac{-(x^2 + y^2)}{xy} = -\frac{x}{y} - \frac{y}{x} = -\frac{1}{y/x} - \frac{y}{x} = F\left(\frac{y}{x}\right) \Rightarrow F(v) = \frac{1}{v} - v \Rightarrow \frac{dx}{x} + \frac{dv}{v - F(v)} = 0$
- $$\Rightarrow \frac{dx}{x} + \frac{dv}{v - \left(\frac{1}{v} - v\right)} = 0 \Rightarrow \int \frac{dx}{x} + \int \frac{v dv}{2v^2 + 1} = C \Rightarrow \ln|x| + \frac{1}{4} \ln|2v^2 + 1| = C \Rightarrow 4 \ln|x| + \ln\left|2\left(\frac{y}{x}\right)^2 + 1\right| = C$$
- $$\Rightarrow \ln|x^4| + \ln\left|\frac{2y^2 + x^2}{x^2}\right| = C \Rightarrow \ln|x^2(2y^2 + x^2)| = C \Rightarrow x^2(2y^2 + x^2) = e^C \Rightarrow x^2(2y^2 + x^2) = C$$
6. $x^2dy + (y^2 - xy)dx = 0 \Rightarrow \frac{dy}{dx} = \frac{-(y^2 - xy)}{x^2} \Rightarrow \frac{dy}{dx} = -\left(\frac{y}{x}\right)^2 + \frac{y}{x} = F\left(\frac{y}{x}\right) \Rightarrow F(v) = -v^2 + v \Rightarrow \frac{dx}{x} + \frac{dv}{v - (-v^2 + v)} = 0$
- $$\Rightarrow \int \frac{dx}{x} + \int \frac{dv}{v^2} = C \Rightarrow \ln|x| - \frac{1}{v} = C \Rightarrow \ln|x| - \frac{1}{y/x} = C \Rightarrow \ln|x| - \frac{x}{y} = C$$
7. $(xe^{y/x} + y)dx - xdy = 0 \Rightarrow \frac{dy}{dx} = \frac{xe^{y/x} + y}{x} = e^{y/x} + \frac{y}{x} = F\left(\frac{y}{x}\right) \Rightarrow F(v) = e^v + v \Rightarrow \frac{dx}{x} + \frac{dv}{v - (e^v + v)} = 0$
- $$\Rightarrow \int \frac{dx}{x} - \int \frac{dv}{e^v} = C \Rightarrow \ln|x| + e^{-v} = C \Rightarrow \ln|x| + e^{-y/x} = C$$

8. $(x+y)dy + (x-y)dx = 0 \Rightarrow \frac{dy}{dx} = \frac{-(x-y)}{x+y} = \frac{\frac{y}{x}-1}{1+\frac{y}{x}} = F\left(\frac{y}{x}\right) \Rightarrow F(v) = \frac{v-1}{1+v} \Rightarrow \frac{dx}{x} + \frac{dv}{v-\left(\frac{v-1}{1+v}\right)} = 0 \Rightarrow \int \frac{dx}{x} + \int \frac{(1+v)dv}{v^2+1} = 0$
- $$\Rightarrow \int \frac{dx}{x} + \int \frac{dv}{v^2+1} + \int \frac{v dv}{v^2+1} = 0 \Rightarrow \ln|x| + \tan^{-1} v + \frac{1}{2} \ln|v^2+1| = C \Rightarrow 2 \ln|x| + 2 \tan^{-1} v + \ln\left|\left(\frac{y}{x}\right)^2 + 1\right| = C$$
- $$\Rightarrow \ln|x^2| + 2 \tan^{-1}\left(\frac{y}{x}\right) + \ln\left|\frac{y^2+x^2}{x^2}\right| = C \Rightarrow 2 \tan^{-1}\left(\frac{y}{x}\right) + \ln|y^2+x^2| = C$$
9. $y' = \frac{y}{x} + \cos\left(\frac{y-x}{x}\right) = \frac{y}{x} + \cos\left(\frac{y}{x}-1\right) = F\left(\frac{y}{x}\right) \Rightarrow F(v) = v + \cos(v-1) \Rightarrow \frac{dx}{x} + \frac{dv}{v-(v+\cos(v-1))} = 0$
- $$\Rightarrow \int \frac{dx}{x} - \int \sec(v-1) dv = 0 \Rightarrow \ln|x| - \ln|\sec(v-1) + \tan(v-1)| = C \Rightarrow \ln|x| - \ln\left|\sec\left(\frac{y}{x}-1\right) + \tan\left(\frac{y}{x}-1\right)\right| = C$$
10. $\left(x \sin \frac{y}{x} - y \cos \frac{y}{x}\right) dx + x \cos \frac{y}{x} dy = 0 \Rightarrow \frac{dy}{dx} = \frac{-(x \sin \frac{y}{x} - y \cos \frac{y}{x})}{x \cos \frac{y}{x}} = \frac{y}{x} - \tan \frac{y}{x} = F\left(\frac{y}{x}\right) \Rightarrow F(v) = v - \tan v$
- $$\Rightarrow \frac{dx}{x} + \frac{dv}{v-(v-\tan v)} = 0 \Rightarrow \int \frac{dx}{x} + \int \cot v dv = 0 \Rightarrow \ln|x| + \ln|\sin v| = C \Rightarrow \ln|x| + \ln\left|\sin \frac{y}{x}\right| = C$$

CHAPTER 10 INFINITE SEQUENCES AND SERIES

10.1 SEQUENCES

- $a_1 = \frac{1-1}{1^2} = 0$, $a_2 = \frac{1-2}{2^2} = -\frac{1}{4}$, $a_3 = \frac{1-3}{3^2} = -\frac{2}{9}$, $a_4 = \frac{1-4}{4^2} = -\frac{3}{16}$
- $a_1 = \frac{1}{1!} = 1$, $a_2 = \frac{1}{2!} = \frac{1}{2}$, $a_3 = \frac{1}{3!} = \frac{1}{6}$, $a_4 = \frac{1}{4!} = \frac{1}{24}$
- $a_1 = \frac{(-1)^2}{2-1} = 1$, $a_2 = \frac{(-1)^3}{4-1} = -\frac{1}{3}$, $a_3 = \frac{(-1)^4}{6-1} = \frac{1}{5}$, $a_4 = \frac{(-1)^5}{8-1} = -\frac{1}{7}$
- $a_1 = 2 + (-1)^1 = 1$, $a_2 = 2 + (-1)^2 = 3$, $a_3 = 2 + (-1)^3 = 1$, $a_4 = 2 + (-1)^4 = 3$
- $a_1 = \frac{2}{2^2} = \frac{1}{2}$, $a_2 = \frac{2^2}{2^3} = \frac{1}{2}$, $a_3 = \frac{2^3}{2^4} = \frac{1}{2}$, $a_4 = \frac{2^4}{2^5} = \frac{1}{2}$
- $a_1 = \frac{2-1}{2} = \frac{1}{2}$, $a_2 = \frac{2^2-1}{2^2} = \frac{3}{4}$, $a_3 = \frac{2^3-1}{2^3} = \frac{7}{8}$, $a_4 = \frac{2^4-1}{2^4} = \frac{15}{16}$
- $a_1 = 1$, $a_2 = 1 + \frac{1}{2} = \frac{3}{2}$, $a_3 = \frac{3}{2} + \frac{1}{2^2} = \frac{7}{4}$, $a_4 = \frac{7}{4} + \frac{1}{2^3} = \frac{15}{8}$, $a_5 = \frac{15}{8} + \frac{1}{2^4} = \frac{31}{16}$, $a_6 = \frac{63}{32}$, $a_7 = \frac{127}{64}$, $a_8 = \frac{255}{128}$,
 $a_9 = \frac{511}{256}$, $a_{10} = \frac{1023}{512}$
- $a_1 = 1$, $a_2 = \frac{1}{2}$, $a_3 = \frac{(\frac{1}{2})}{3} = \frac{1}{6}$, $a_4 = \frac{(\frac{1}{6})}{4} = \frac{1}{24}$, $a_5 = \frac{(\frac{1}{24})}{5} = \frac{1}{120}$, $a_6 = \frac{1}{720}$, $a_7 = \frac{1}{5040}$, $a_8 = \frac{1}{40,320}$,
 $a_9 = \frac{1}{362,880}$, $a_{10} = \frac{1}{3,628,800}$
- $a_1 = 2$, $a_2 = \frac{(-1)^2(2)}{2} = 1$, $a_3 = \frac{(-1)^3(1)}{2} = -\frac{1}{2}$, $a_4 = \frac{(-1)^4(\frac{1}{2})}{2} = -\frac{1}{4}$, $a_5 = \frac{(-1)^5(\frac{1}{4})}{2} = \frac{1}{8}$, $a_6 = \frac{1}{16}$, $a_7 = -\frac{1}{32}$,
 $a_8 = -\frac{1}{64}$, $a_9 = \frac{1}{128}$, $a_{10} = \frac{1}{256}$
- $a_1 = -2$, $a_2 = \frac{1(-2)}{2} = -1$, $a_3 = \frac{2(-1)}{3} = -\frac{2}{3}$, $a_4 = \frac{3(\frac{-2}{3})}{4} = -\frac{1}{2}$, $a_5 = \frac{4(\frac{-1}{2})}{5} = -\frac{2}{5}$, $a_6 = -\frac{1}{3}$, $a_7 = -\frac{2}{7}$,
 $a_8 = -\frac{1}{4}$, $a_9 = -\frac{2}{9}$, $a_{10} = -\frac{1}{5}$
- $a_1 = 1$, $a_2 = 1$, $a_3 = 1+1 = 2$, $a_4 = 2+1 = 3$, $a_5 = 3+2 = 5$, $a_6 = 8$, $a_7 = 13$, $a_8 = 21$, $a_9 = 34$, $a_{10} = 55$
- $a_1 = 2$, $a_2 = -1$, $a_3 = -\frac{1}{2}$, $a_4 = \frac{(-\frac{1}{2})}{-1} = \frac{1}{2}$, $a_5 = \frac{(\frac{1}{2})}{(-\frac{1}{2})} = -1$, $a_6 = -2$, $a_7 = 2$, $a_8 = -1$, $a_9 = -\frac{1}{2}$, $a_{10} = \frac{1}{2}$
- $a_n = (-1)^{n+1}$, $n = 1, 2, \dots$
- $a_n = (-1)^n$, $n = 1, 2, \dots$
- $a_n = (-1)^{n+1}n^2$, $n = 1, 2, \dots$
- $a_n = \frac{(-1)^{n+1}}{n^2}$, $n = 1, 2, \dots$

17. $a_n = \frac{2^{n-1}}{3(n+2)}, n = 1, 2, \dots$

18. $a_n = \frac{2n-5}{n(n+1)}, n = 1, 2, \dots$

19. $a_n = n^2 - 1, n = 1, 2, \dots$

20. $a_n = n - 4, n = 1, 2, \dots$

21. $a_n = 4n - 3, n = 1, 2, \dots$

22. $a_n = 4n - 2, n = 1, 2, \dots$

23. $a_n = \frac{3n+2}{n!}, n = 1, 2, \dots$

24. $a_n = \frac{n^3}{5^{n+1}}, n = 1, 2, \dots$

25. $a_n = \frac{1+(-1)^{n+1}}{2}, n = 1, 2, \dots$

26. $a_n = \frac{n - \frac{1}{2} + (-1)^n \left(\frac{1}{2}\right)}{2} = \left\lfloor \frac{n}{2} \right\rfloor, n = 1, 2, \dots$

27. $\lim_{n \rightarrow \infty} (2 + (0.1)^n) = 2 \Rightarrow \text{converges}$ (Theorem 5, #4)

28. $\lim_{n \rightarrow \infty} \frac{n+(-1)^n}{n} = \lim_{n \rightarrow \infty} \left(1 + \frac{(-1)^n}{n}\right) = 1 \Rightarrow \text{converges}$

29. $\lim_{n \rightarrow \infty} \frac{1-2n}{1+2n} = \lim_{n \rightarrow \infty} \frac{\left(\frac{1}{n}\right)-2}{\left(\frac{1}{n}\right)+2} = \lim_{n \rightarrow \infty} \frac{-2}{2} = -1 \Rightarrow \text{converges}$

30. $\lim_{n \rightarrow \infty} \frac{2n+1}{1-3\sqrt{n}} = \lim_{n \rightarrow \infty} \frac{2\sqrt{n} + \left(\frac{1}{\sqrt{n}}\right)}{\left(\frac{1}{\sqrt{n}} - 3\right)} = -\infty \Rightarrow \text{diverges}$

31. $\lim_{n \rightarrow \infty} \frac{1-5n^4}{n^4+8n^3} = \lim_{n \rightarrow \infty} \frac{\left(\frac{1}{n^4}\right)-5}{1+\left(\frac{8}{n}\right)} = -5 \Rightarrow \text{converges}$

32. $\lim_{n \rightarrow \infty} \frac{n+3}{n^2+5n+6} = \lim_{n \rightarrow \infty} \frac{n+3}{(n+3)(n+2)} = \lim_{n \rightarrow \infty} \frac{1}{n+2} = 0 \Rightarrow \text{converges}$

33. $\lim_{n \rightarrow \infty} \frac{n^2-2n+1}{n-1} = \lim_{n \rightarrow \infty} \frac{(n-1)(n-1)}{n-1} = \lim_{n \rightarrow \infty} (n-1) = \infty \Rightarrow \text{diverges}$

34. $\lim_{n \rightarrow \infty} \frac{1-n^3}{70-4n^2} = \lim_{n \rightarrow \infty} \frac{\left(\frac{1}{n^2}\right)-n}{\left(\frac{70}{n^2}\right)-4} = \infty \Rightarrow \text{diverges}$

35. $\lim_{n \rightarrow \infty} (1 + (-1)^n)$ does not exist \Rightarrow diverges

36. $\lim_{n \rightarrow \infty} (-1)^n \left(1 - \frac{1}{n}\right)$ does not exist \Rightarrow diverges

37. $\lim_{n \rightarrow \infty} \left(\frac{n+1}{2n}\right) \left(1 - \frac{1}{n}\right) = \lim_{n \rightarrow \infty} \left(\frac{1}{2} + \frac{1}{2n}\right) \left(1 - \frac{1}{n}\right) = \frac{1}{2} \Rightarrow \text{converges}$

38. $\lim_{n \rightarrow \infty} \left(2 - \frac{1}{2^n}\right) \left(3 + \frac{1}{2^n}\right) = 6 \Rightarrow \text{converges}$

39. $\lim_{n \rightarrow \infty} \frac{(-1)^{n+1}}{2n-1} = 0 \Rightarrow \text{converges}$

40. $\lim_{n \rightarrow \infty} \left(-\frac{1}{2}\right)^n = \lim_{n \rightarrow \infty} \frac{(-1)^n}{2^n} = 0 \Rightarrow$ converges
41. $\lim_{n \rightarrow \infty} \sqrt{\frac{2n}{n+1}} = \sqrt{\lim_{n \rightarrow \infty} \frac{2n}{n+1}} = \sqrt{\lim_{n \rightarrow \infty} \left(\frac{2}{1+\frac{1}{n}}\right)} = \sqrt{2} \Rightarrow$ converges
42. $\lim_{n \rightarrow \infty} \frac{1}{(0.9)^n} = \lim_{n \rightarrow \infty} \left(\frac{10}{9}\right)^n = \infty \Rightarrow$ diverges
43. $\lim_{n \rightarrow \infty} \sin\left(\frac{\pi}{2} + \frac{1}{n}\right) = \sin\left(\lim_{n \rightarrow \infty} \left(\frac{\pi}{2} + \frac{1}{n}\right)\right) = \sin \frac{\pi}{2} = 1 \Rightarrow$ converges
44. $\lim_{n \rightarrow \infty} n\pi \cos(n\pi) = \lim_{n \rightarrow \infty} (n\pi)(-1)^n$ does not exist \Rightarrow diverges
45. $\lim_{n \rightarrow \infty} \frac{\sin n}{n} = 0$ because $-\frac{1}{n} \leq \frac{\sin n}{n} \leq \frac{1}{n} \Rightarrow$ converges by the Sandwich Theorem for sequences
46. $\lim_{n \rightarrow \infty} \frac{\sin^2 n}{2^n} = 0$ because $0 \leq \frac{\sin^2 n}{2^n} \leq \frac{1}{2^n} \Rightarrow$ converges by the Sandwich Theorem for sequences
47. $\lim_{n \rightarrow \infty} \frac{n}{2^n} = \lim_{n \rightarrow \infty} \frac{1}{2^n \ln 2} = 0 \Rightarrow$ converges (using l'Hôpital's rule)
48. $\lim_{n \rightarrow \infty} \frac{3^n}{n^3} = \lim_{n \rightarrow \infty} \frac{3^n \ln 3}{3n^2} = \lim_{n \rightarrow \infty} \frac{3^n (\ln 3)^2}{6n} = \lim_{n \rightarrow \infty} \frac{3^n (\ln 3)^3}{6} = \infty \Rightarrow$ diverges (using l'Hôpital's rule)
49. $\lim_{n \rightarrow \infty} \frac{\ln(n+1)}{\sqrt{n}} = \lim_{n \rightarrow \infty} \frac{\left(\frac{1}{n+1}\right)}{\left(\frac{1}{2\sqrt{n}}\right)} = \lim_{n \rightarrow \infty} \frac{2\sqrt{n}}{n+1} = \lim_{n \rightarrow \infty} \frac{\left(\frac{2}{\sqrt{n}}\right)}{1+\left(\frac{1}{n}\right)} = 0 \Rightarrow$ converges
50. $\lim_{n \rightarrow \infty} \frac{\ln n}{\ln 2n} = \lim_{n \rightarrow \infty} \frac{\left(\frac{1}{n}\right)}{\left(\frac{2}{2n}\right)} = 1 \Rightarrow$ converges
51. $\lim_{n \rightarrow \infty} 8^{1/n} = 1 \Rightarrow$ converges (Theorem 5, #3)
52. $\lim_{n \rightarrow \infty} (0.03)^{1/n} = 1 \Rightarrow$ converges (Theorem 5, #3)
53. $\lim_{n \rightarrow \infty} \left(1 + \frac{7}{n}\right)^n = e^7 \Rightarrow$ converges (Theorem 5, #5)
54. $\lim_{n \rightarrow \infty} \left(1 - \frac{1}{n}\right)^n = \lim_{n \rightarrow \infty} \left[1 + \frac{(-1)}{n}\right]^n = e^{-1} \Rightarrow$ converges (Theorem 5, #5)
55. $\lim_{n \rightarrow \infty} \sqrt[n]{10n} = \lim_{n \rightarrow \infty} 10^{1/n} \cdot n^{1/n} = 1 \cdot 1 = 1 \Rightarrow$ converges (Theorem 5, #3 and #2)

$$56. \lim_{n \rightarrow \infty} \sqrt[n]{n^2} = \lim_{n \rightarrow \infty} \left(\sqrt[n]{n} \right)^2 = 1^2 = 1 \Rightarrow \text{converges} \quad (\text{Theorem 5, \#2})$$

$$57. \lim_{n \rightarrow \infty} \left(\frac{3}{n} \right)^{1/n} = \frac{\lim_{n \rightarrow \infty} 3^{1/n}}{\lim_{n \rightarrow \infty} n^{1/n}} = \frac{1}{1} = 1 \Rightarrow \text{converges} \quad (\text{Theorem 5, \#3 and \#2})$$

$$58. \lim_{n \rightarrow \infty} (n+4)^{1/(n+4)} = \lim_{x \rightarrow \infty} x^{1/x} = 1 \Rightarrow \text{converges; (let } x = n+4, \text{ then use Theorem 5, \#2)}$$

$$59. \lim_{n \rightarrow \infty} \frac{\ln n}{n^{1/n}} = \frac{\lim_{n \rightarrow \infty} \ln n}{\lim_{n \rightarrow \infty} n^{1/n}} = \frac{\infty}{1} = \infty \Rightarrow \text{diverges} \quad (\text{Theorem 5, \#2})$$

$$60. \lim_{n \rightarrow \infty} [\ln n - \ln(n+1)] = \lim_{n \rightarrow \infty} \ln \left(\frac{n}{n+1} \right) = \ln \left(\lim_{n \rightarrow \infty} \frac{n}{n+1} \right) = \ln 1 = 0 \Rightarrow \text{converges}$$

$$61. \lim_{n \rightarrow \infty} \sqrt[n]{4^n n} = \lim_{n \rightarrow \infty} 4 \sqrt[n]{n} = 4 \cdot 1 = 4 \Rightarrow \text{converges} \quad (\text{Theorem 5, \#2})$$

$$62. \lim_{n \rightarrow \infty} \sqrt[n]{3^{2n+1}} = \lim_{n \rightarrow \infty} 3^{2+(1/n)} = \lim_{n \rightarrow \infty} 3^2 \cdot 3^{1/n} = 9 \cdot 1 = 9 \Rightarrow \text{converges} \quad (\text{Theorem 5, \#3})$$

$$63. \lim_{n \rightarrow \infty} \frac{n!}{n^n} = \lim_{n \rightarrow \infty} \frac{1 \cdot 2 \cdot 3 \cdots (n-1) \cdot n}{n \cdot n \cdot n \cdots n} \leq \lim_{n \rightarrow \infty} \left(\frac{1}{n} \right) = 0 \text{ and } \frac{n!}{n^n} \geq 0 \Rightarrow \lim_{n \rightarrow \infty} \frac{n!}{n^n} = 0 \Rightarrow \text{converges}$$

$$64. \lim_{n \rightarrow \infty} \frac{(-4)^n}{n!} = 0 \Rightarrow \text{converges} \quad (\text{Theorem 5, \#6})$$

$$65. \lim_{n \rightarrow \infty} \frac{n!}{10^{6n}} = \lim_{n \rightarrow \infty} \frac{1}{\left(\frac{(10^6)^n}{n!} \right)} = \infty \Rightarrow \text{diverges} \quad (\text{Theorem 5, \#6})$$

$$66. \lim_{n \rightarrow \infty} \frac{n!}{2^n 3^n} = \lim_{n \rightarrow \infty} \frac{1}{\left(\frac{6^n}{n!} \right)} = \infty \Rightarrow \text{diverges} \quad (\text{Theorem 5, \#6})$$

$$67. \lim_{n \rightarrow \infty} \left(\frac{1}{n} \right)^{1/(\ln n)} = \lim_{n \rightarrow \infty} \exp \left(\frac{1}{\ln n} \ln \left(\frac{1}{n} \right) \right) = \lim_{n \rightarrow \infty} \exp \left(\frac{\ln 1 - \ln n}{\ln n} \right) = e^{-1} \Rightarrow \text{converges}$$

$$68. \lim_{n \rightarrow \infty} \ln \left(1 + \frac{1}{n} \right)^n = \ln \left(\lim_{n \rightarrow \infty} \left(1 + \frac{1}{n} \right)^n \right) = \ln e = 1 \Rightarrow \text{converges} \quad (\text{Theorem 5, \#5})$$

$$69. \lim_{n \rightarrow \infty} \left(\frac{3n+1}{3n-1} \right)^n = \lim_{n \rightarrow \infty} \exp \left(n \ln \left(\frac{3n+1}{3n-1} \right) \right) = \lim_{n \rightarrow \infty} \exp \left(\frac{\ln(3n+1) - \ln(3n-1)}{\frac{1}{n}} \right) = \lim_{n \rightarrow \infty} \exp \left(\frac{\frac{3}{3n+1} - \frac{3}{3n-1}}{\left(-\frac{1}{n^2} \right)} \right)$$

$$= \lim_{n \rightarrow \infty} \exp \left(\frac{6n^2}{(3n+1)(3n-1)} \right) = \exp \left(\frac{6}{9} \right) = e^{2/3} \Rightarrow \text{converges}$$

70. $\lim_{n \rightarrow \infty} \left(\frac{n}{n+1}\right)^n = \lim_{n \rightarrow \infty} \exp\left(n \ln\left(\frac{n}{n+1}\right)\right) = \lim_{n \rightarrow \infty} \exp\left(\frac{\ln n - \ln(n+1)}{\left(\frac{1}{n}\right)}\right) = \lim_{n \rightarrow \infty} \exp\left(\frac{\frac{1}{n} - \frac{1}{n+1}}{\left(-\frac{1}{n^2}\right)}\right)$
 $= \lim_{n \rightarrow \infty} \exp\left(-\frac{n^2}{n(n+1)}\right) = e^{-1} \Rightarrow \text{converges}$
71. $\lim_{n \rightarrow \infty} \left(\frac{x^n}{2n+1}\right)^{1/n} = \lim_{n \rightarrow \infty} x \left(\frac{1}{2n+1}\right)^{1/n} = x \lim_{n \rightarrow \infty} \exp\left(\frac{1}{n} \ln\left(\frac{1}{2n+1}\right)\right) = x \lim_{n \rightarrow \infty} \exp\left(\frac{-\ln(2n+1)}{n}\right) = x \lim_{n \rightarrow \infty} \exp\left(\frac{-2}{2n+1}\right)$
 $= xe^0 = x, x > 0 \Rightarrow \text{converges}$
72. $\lim_{n \rightarrow \infty} \left(1 - \frac{1}{n^2}\right)^n = \lim_{n \rightarrow \infty} \exp\left(n \ln\left(1 - \frac{1}{n^2}\right)\right) = \lim_{n \rightarrow \infty} \exp\left(\frac{\ln\left(1 - \frac{1}{n^2}\right)}{\left(\frac{1}{n}\right)}\right) = \lim_{n \rightarrow \infty} \exp\left[\frac{\left(\frac{2}{n^3}\right) / \left(1 - \frac{1}{n^2}\right)}{\left(-\frac{1}{n^2}\right)}\right] = \lim_{n \rightarrow \infty} \exp\left(\frac{-2n}{n^2-1}\right)$
 $= e^0 = 1 \Rightarrow \text{converges}$
73. $\lim_{n \rightarrow \infty} \frac{3^n \cdot 6^n}{2^{-n} \cdot n!} = \lim_{n \rightarrow \infty} \frac{36^n}{n!} = 0 \Rightarrow \text{converges}$ (Theorem 5, #6)
74. $\lim_{n \rightarrow \infty} \frac{\left(\frac{10}{11}\right)^n}{\left(\frac{9}{10}\right)^n + \left(\frac{11}{12}\right)^n} = \lim_{n \rightarrow \infty} \frac{\left(\frac{12}{11}\right)^n \left(\frac{10}{11}\right)^n}{\left(\frac{12}{11}\right)^n \left(\frac{9}{10}\right)^n + \left(\frac{12}{11}\right)^n \left(\frac{11}{12}\right)^n} = \lim_{n \rightarrow \infty} \frac{\left(\frac{120}{121}\right)^n}{\left(\frac{108}{110}\right)^n + 1} = 0 \Rightarrow \text{converges}$ (Theorem 5, #4)
75. $\lim_{n \rightarrow \infty} \tanh n = \lim_{n \rightarrow \infty} \frac{e^n - e^{-n}}{e^n + e^{-n}} = \lim_{n \rightarrow \infty} \frac{e^{2n} - 1}{e^{2n} + 1} = \lim_{n \rightarrow \infty} \frac{2e^{2n}}{2e^{2n}} = \lim_{n \rightarrow \infty} 1 = 1 \Rightarrow \text{converges}$
76. $\lim_{n \rightarrow \infty} \sinh(\ln n) = \lim_{n \rightarrow \infty} \frac{e^{\ln n} - e^{-\ln n}}{2} = \lim_{n \rightarrow \infty} \frac{n - \left(\frac{1}{n}\right)}{2} = \infty \Rightarrow \text{diverges}$
77. $\lim_{n \rightarrow \infty} \frac{n^2 \sin\left(\frac{1}{n}\right)}{2n-1} = \lim_{n \rightarrow \infty} \frac{\sin\left(\frac{1}{n}\right)}{\left(\frac{2}{n} - \frac{1}{n^2}\right)} = \lim_{n \rightarrow \infty} \frac{-\left(\cos\left(\frac{1}{n}\right)\right)\left(-\frac{1}{n^2}\right)}{\left(-\frac{2}{n^2} + \frac{2}{n^3}\right)} = \lim_{n \rightarrow \infty} \frac{-\cos\left(\frac{1}{n}\right)}{-2 + \left(\frac{2}{n}\right)} = \frac{1}{2} \Rightarrow \text{converges}$
78. $\lim_{n \rightarrow \infty} n\left(1 - \cos \frac{1}{n}\right) = \lim_{n \rightarrow \infty} \frac{(1 - \cos \frac{1}{n})}{\left(\frac{1}{n}\right)} = \lim_{n \rightarrow \infty} \frac{\left[\sin\left(\frac{1}{n}\right)\right]\left(-\frac{1}{n^2}\right)}{\left(-\frac{1}{n^2}\right)} = \lim_{n \rightarrow \infty} \sin\left(\frac{1}{n}\right) = 0 \Rightarrow \text{converges}$
79. $\lim_{n \rightarrow \infty} \sqrt{n} \sin\left(\frac{1}{\sqrt{n}}\right) = \lim_{n \rightarrow \infty} \frac{\sin\left(\frac{1}{\sqrt{n}}\right)}{\frac{1}{\sqrt{n}}} = \lim_{n \rightarrow \infty} \frac{\cos\left(\frac{1}{\sqrt{n}}\right)\left(-\frac{1}{2n^{3/2}}\right)}{-\frac{1}{2n^{3/2}}} = \lim_{n \rightarrow \infty} \cos\left(\frac{1}{\sqrt{n}}\right) = \cos 0 = 1 \Rightarrow \text{converges}$
80. $\lim_{n \rightarrow \infty} \left(3^n + 5^n\right)^{1/n} = \lim_{n \rightarrow \infty} \exp\left[\ln\left(3^n + 5^n\right)^{1/n}\right] = \lim_{n \rightarrow \infty} \exp\left[\frac{\ln\left(3^n + 5^n\right)}{n}\right] = \lim_{n \rightarrow \infty} \exp\left[\frac{3^n \ln 3 + 5^n \ln 5}{3^n + 5^n}\right]$
 $= \lim_{n \rightarrow \infty} \exp\left[\frac{\left(\frac{3^n}{5^n}\right) \ln 3 + \ln 5}{\left(\frac{3^n}{5^n}\right) + 1}\right] = \lim_{n \rightarrow \infty} \exp\left[\frac{\left(\frac{3}{5}\right)^n \ln 3 + \ln 5}{\left(\frac{3}{5}\right)^n + 1}\right] = \exp(\ln 5) = 5$

81. $\lim_{n \rightarrow \infty} \tan^{-1} n = \frac{\pi}{2} \Rightarrow$ converges
82. $\lim_{n \rightarrow \infty} \frac{1}{\sqrt{n}} \tan^{-1} n = 0 \cdot \frac{\pi}{2} = 0 \Rightarrow$ converges
83. $\lim_{n \rightarrow \infty} \left(\left(\frac{1}{3} \right)^n + \frac{1}{\sqrt{2^n}} \right) = \lim_{n \rightarrow \infty} \left(\left(\frac{1}{3} \right)^n + \left(\frac{1}{\sqrt{2}} \right)^n \right) = 0 \Rightarrow$ converges (Theorem 5, #4)
84. $\lim_{n \rightarrow \infty} \sqrt[n]{n^2 + n} = \lim_{n \rightarrow \infty} \exp \left[\frac{\ln(n^2 + n)}{n} \right] = \lim_{n \rightarrow \infty} \exp \left(\frac{2n+1}{n^2+n} \right) = e^0 = 1 \Rightarrow$ converges
85. $\lim_{n \rightarrow \infty} \frac{(\ln n)^{200}}{n} = \lim_{n \rightarrow \infty} \frac{200(\ln n)^{199}}{n} = \lim_{n \rightarrow \infty} \frac{200 \cdot 199 (\ln n)^{198}}{n} = \dots = \lim_{n \rightarrow \infty} \frac{200!}{n} = 0 \Rightarrow$ converges
86. $\lim_{n \rightarrow \infty} \frac{(\ln n)^5}{\sqrt{n}} = \lim_{n \rightarrow \infty} \left[\frac{\left(\frac{5(\ln n)^4}{n} \right)}{\left(\frac{1}{2\sqrt{n}} \right)} \right] = \lim_{n \rightarrow \infty} \frac{10(\ln n)^4}{\sqrt{n}} = \lim_{n \rightarrow \infty} \frac{80(\ln n)^3}{\sqrt{n}} = \dots = \lim_{n \rightarrow \infty} \frac{3840}{\sqrt{n}} = 0 \Rightarrow$ converges
87. $\lim_{n \rightarrow \infty} \left(n - \sqrt{n^2 - n} \right) = \lim_{n \rightarrow \infty} \left(n - \sqrt{n^2 - n} \right) \left(\frac{n + \sqrt{n^2 - n}}{n + \sqrt{n^2 - n}} \right) = \lim_{n \rightarrow \infty} \frac{n}{n + \sqrt{n^2 - n}} = \lim_{n \rightarrow \infty} \frac{1}{1 + \sqrt{1 - \frac{1}{n}}} = \frac{1}{2} \Rightarrow$ converges
88. $\lim_{n \rightarrow \infty} \frac{1}{\sqrt{n^2 - 1} - \sqrt{n^2 + n}} = \lim_{n \rightarrow \infty} \left(\frac{1}{\sqrt{n^2 - 1} - \sqrt{n^2 + n}} \right) \left(\frac{\sqrt{n^2 - 1} + \sqrt{n^2 + n}}{\sqrt{n^2 - 1} + \sqrt{n^2 + n}} \right) = \lim_{n \rightarrow \infty} \frac{\sqrt{n^2 - 1} + \sqrt{n^2 + n}}{-1 - n} = \lim_{n \rightarrow \infty} \frac{\sqrt{1 - \frac{1}{n^2}} + \sqrt{1 + \frac{1}{n}}}{\left(-\frac{1}{n} - 1 \right)} = -2$
 \Rightarrow converges
89. $\lim_{n \rightarrow \infty} \frac{1}{n} \int_1^n \frac{1}{x} dx = \lim_{n \rightarrow \infty} \frac{\ln n}{n} = \lim_{n \rightarrow \infty} \frac{1}{n} = 0 \Rightarrow$ converges (Theorem 5, #1)
90. $\lim_{n \rightarrow \infty} \int_1^n \frac{1}{x^p} dx = \lim_{n \rightarrow \infty} \left[\frac{1}{1-p} \frac{1}{x^{p-1}} \right]_1^n = \lim_{n \rightarrow \infty} \frac{1}{1-p} \left(\frac{1}{n^{p-1}} - 1 \right) = \frac{1}{p-1}$ if $p > 1 \Rightarrow$ converges
91. Since a_n converges $\Rightarrow \lim_{n \rightarrow \infty} a_n = L \Rightarrow \lim_{n \rightarrow \infty} a_{n+1} = \lim_{n \rightarrow \infty} \frac{72}{1+a_n} \Rightarrow L = \frac{72}{1+L} \Rightarrow L(1+L) = 72$
 $\Rightarrow L^2 + L - 72 = 0 \Rightarrow L = -9$ or $L = 8$; since $a_n > 0$ for $n \geq 1 \Rightarrow L = 8$
92. Since a_n converges $\Rightarrow \lim_{n \rightarrow \infty} a_n = L \Rightarrow \lim_{n \rightarrow \infty} a_{n+1} = \lim_{n \rightarrow \infty} \frac{a_n + 6}{a_n + 2} \Rightarrow L = \frac{L+6}{L+2} \Rightarrow L(L+2) = L+6$
 $\Rightarrow L^2 + L - 6 = 0 \Rightarrow L = -3$ or $L = 2$; since $a_n > 0$ for $n \geq 2 \Rightarrow L = 2$
93. Since a_n converges $\Rightarrow \lim_{n \rightarrow \infty} a_n = L \Rightarrow \lim_{n \rightarrow \infty} a_{n+1} = \lim_{n \rightarrow \infty} \sqrt{8+2a_n} \Rightarrow L = \sqrt{8+2L} \Rightarrow L^2 - 2L - 8 = 0$
 $\Rightarrow L = -2$ or $L = 4$; since $a_n > 0$ for $n \geq 3 \Rightarrow L = 4$
94. Since a_n converges $\Rightarrow \lim_{n \rightarrow \infty} a_n = L \Rightarrow \lim_{n \rightarrow \infty} a_{n+1} = \lim_{n \rightarrow \infty} \sqrt{8+2a_n} \Rightarrow L = \sqrt{8+2L} \Rightarrow L^2 - 2L - 8 = 0$
 $\Rightarrow L = -2$ or $L = 4$; since $a_n > 0$ for $n \geq 2 \Rightarrow L = 4$

95. Since a_n converges $\Rightarrow \lim_{n \rightarrow \infty} a_n = L \Rightarrow \lim_{n \rightarrow \infty} a_{n+1} = \lim_{n \rightarrow \infty} \sqrt{5a_n} \Rightarrow L = \sqrt{5L} \Rightarrow L^2 - 5L = 0 \Rightarrow L = 0$ or $L = 5$;
since $a_n > 0$ for $n \geq 1 \Rightarrow L = 5$

96. Since a_n converges $\Rightarrow \lim_{n \rightarrow \infty} a_n = L \Rightarrow \lim_{n \rightarrow \infty} a_{n+1} = \lim_{n \rightarrow \infty} (12 - \sqrt{a_n}) \Rightarrow L = (12 - \sqrt{L}) \Rightarrow L^2 - 25L + 144 = 0$
 $\Rightarrow L = 9$ or $L = 16$; since $12 - \sqrt{a_n} < 12$ for $n \geq 1 \Rightarrow L = 9$

97. $a_{n+1} = 2 + \frac{1}{a_n}$, $n \geq 1$, $a_1 = 2$. Since a_n converges $\Rightarrow \lim_{n \rightarrow \infty} a_n = L \Rightarrow \lim_{n \rightarrow \infty} a_{n+1} = \lim_{n \rightarrow \infty} \left(2 + \frac{1}{a_n}\right) \Rightarrow L = 2 + \frac{1}{L}$
 $\Rightarrow L^2 - 2L - 1 = 0 \Rightarrow L = 1 \pm \sqrt{2}$; since $a_n > 0$ for $n \geq 1 \Rightarrow L = 1 + \sqrt{2}$

98. $a_{n+1} = \sqrt{1+a_n}$, $n \geq 1$, $a_1 = \sqrt{1}$. Since a_n converges $\Rightarrow \lim_{n \rightarrow \infty} a_n = L \Rightarrow \lim_{n \rightarrow \infty} a_{n+1} = \lim_{n \rightarrow \infty} \sqrt{1+a_n} \Rightarrow L = \sqrt{1+L}$
 $\Rightarrow L^2 - L - 1 = 0 \Rightarrow L = \frac{1 \pm \sqrt{5}}{2}$; since $a_n > 0$ for $n \geq 1 \Rightarrow L = \frac{1 + \sqrt{5}}{2}$

99. $1, 1, 2, 4, 8, 16, 32, \dots = 1, 2^0, 2^1, 2^2, 2^3, 2^4, 2^5, \dots \Rightarrow x_1 = 1$ and $x_n = 2^{n-2}$ for $n \geq 2$

100. (a) $1^2 - 2(1)^2 = -1$, $3^2 - 2(2)^2 = 1$; let $f(a, b) = (a+2b)^2 - 2(a+b)^2 = a^2 + 4ab + 4b^2 - 2a^2 - 4ab - 2b^2$
 $= 2b^2 - a^2$; $a^2 - 2b^2 = -1 \Rightarrow f(a, b) = 2b^2 - a^2 = 1$; $a^2 - 2b^2 = 1 \Rightarrow f(a, b) = 2b^2 - a^2 = -1$

(b) $r_n^2 - 2 = \left(\frac{a+2b}{a+b}\right)^2 - 2 = \frac{a^2 + 4ab + 4b^2 - 2a^2 - 4ab - 2b^2}{(a+b)^2} = \frac{-(a^2 - 2b^2)}{(a+b)^2} = \frac{\pm 1}{y_n^2} \Rightarrow r_n = \sqrt{2 \pm \left(\frac{1}{y_n}\right)^2}$

In the first and second fractions, $y_n \geq n$. Let $\frac{a}{b}$ represent the $(n-1)$ th fraction where $\frac{a}{b} \geq 1$ and $b \geq n-1$
for n a positive integer ≥ 3 . Now the n th fraction is $\frac{a+2b}{a+b}$ and $a+b \geq 2b \geq 2n-2 \geq n \Rightarrow y_n \geq n$.

Thus, $\lim_{n \rightarrow \infty} r_n = \sqrt{2}$.

101. (a) $f(x) = x^2 - 2$; the sequence converges to $1.414213562 \approx \sqrt{2}$

(b) $f(x) = \tan(x) - 1$; the sequence converges to $0.7853981635 \approx \frac{\pi}{4}$

(c) $f(x) = e^x$; the sequence $1, 0, -1, -2, -3, -4, -5, \dots$ diverges

102. (a) $\lim_{n \rightarrow \infty} n f\left(\frac{1}{n}\right) = \lim_{\Delta x \rightarrow 0^+} \frac{f(\Delta x)}{\Delta x} = \lim_{\Delta x \rightarrow 0^+} \frac{f(0+\Delta x) - f(0)}{\Delta x} = f'(0)$, where $\Delta x = \frac{1}{n}$

(b) $\lim_{n \rightarrow \infty} n \tan^{-1}\left(\frac{1}{n}\right) = f'(0) = \frac{1}{1+0^2} = 1$, $f(x) = \tan^{-1} x$

(c) $\lim_{n \rightarrow \infty} n(e^{1/n} - 1) = f'(0) = e^0 = 1$, $f(x) = e^x - 1$

(d) $\lim_{n \rightarrow \infty} n \ln\left(1 + \frac{2}{n}\right) = f'(0) = \frac{2}{1+2(0)} = 2$, $f(x) = \ln(1+2x)$

103. (a) If $a = 2n + 1$, then $b = \left\lfloor \frac{a^2}{2} \right\rfloor = \left\lfloor \frac{4n^2 + 4n + 1}{2} \right\rfloor = \left\lfloor 2n^2 + 2n + \frac{1}{2} \right\rfloor = 2n^2 + 2n$, $c = \left\lceil \frac{a^2}{2} \right\rceil = \left\lceil 2n^2 + 2n + \frac{1}{2} \right\rceil = 2n^2 + 2n + 1$ and $a^2 + b^2 = (2n + 1)^2 + (2n^2 + 2n)^2 = 4n^2 + 4n + 1 + 4n^4 + 8n^3 + 4n^2 = 4n^4 + 8n^3 + 8n^2 + 4n + 1 = (2n^2 + 2n + 1)^2 = c^2$.

(b) $\lim_{a \rightarrow \infty} \frac{\left\lfloor \frac{a^2}{2} \right\rfloor}{\left\lceil \frac{a^2}{2} \right\rceil} = \lim_{a \rightarrow \infty} \frac{2n^2 + 2n}{2n^2 + 2n + 1} = 1$ or $\lim_{a \rightarrow \infty} \frac{\left\lfloor \frac{a^2}{2} \right\rfloor}{\left\lceil \frac{a^2}{2} \right\rceil} = \lim_{a \rightarrow \infty} \sin \theta = \lim_{\theta \rightarrow \frac{\pi}{2}} \sin \theta = 1$

104. (a) $\lim_{n \rightarrow \infty} (2n\pi)^{1/(2n)} = \lim_{n \rightarrow \infty} \exp\left(\frac{\ln 2n\pi}{2n}\right) = \lim_{n \rightarrow \infty} \exp\left(\frac{\left(\frac{2\pi}{2n\pi}\right)}{2}\right) = \lim_{n \rightarrow \infty} \exp\left(\frac{1}{2n}\right) = e^0 = 1$; $n! \approx \left(\frac{n}{e}\right)^n \sqrt{2n\pi}$,

Stirling's approximation $\Rightarrow \sqrt[n]{n!} \approx \left(\frac{n}{e}\right) (2n\pi)^{1/(2n)} \approx \frac{n}{e}$ for large values of n

(b)

n	$\sqrt[n]{n!}$	$\frac{n}{e}$
40	15.76852702	14.71517765
50	19.48325423	18.39397206
60	23.19189561	22.07276647

105. (a) $\lim_{n \rightarrow \infty} \frac{\ln n}{n^c} = \lim_{n \rightarrow \infty} \frac{\left(\frac{1}{n}\right)}{cn^{c-1}} = \lim_{n \rightarrow \infty} \frac{1}{cn^c} = 0$

(b) For all $\epsilon > 0$, there exists an $N = e^{-(\ln \epsilon)/c}$ such that $n > e^{-(\ln \epsilon)/c} \Rightarrow \ln n > -\frac{\ln \epsilon}{c} \Rightarrow \ln n^c > \ln\left(\frac{1}{\epsilon}\right) \Rightarrow n^c > \frac{1}{\epsilon} \Rightarrow \frac{1}{n^c} < \epsilon \Rightarrow \left|\frac{1}{n^c} - 0\right| < \epsilon \Rightarrow \lim_{n \rightarrow \infty} \frac{1}{n^c} = 0$

106. Let $\{a_n\}$ and $\{b_n\}$ be sequences both converging to L . Define $\{c_n\}$ by $c_{2n} = b_n$ and $c_{2n-1} = a_n$, where $n = 1, 2, 3, \dots$. For all $\epsilon > 0$ there exists N_1 such that when $n > N_1$ then $|a_n - L| < \epsilon$ and there exists N_2 such that when $n > N_2$ then $|b_n - L| < \epsilon$. If $n > 1 + 2 \max\{N_1, N_2\}$, then $|c_n - L| < \epsilon$, so $\{c_n\}$ converges to L .

107. $\lim_{n \rightarrow \infty} n^{1/n} = \lim_{n \rightarrow \infty} \exp\left(\frac{1}{n} \ln n\right) = \lim_{n \rightarrow \infty} \exp\left(\frac{1}{n}\right) = e^0 = 1$

108. $\lim_{n \rightarrow \infty} x^{1/n} = \lim_{n \rightarrow \infty} \exp\left(\frac{1}{n} \ln x\right) = e^0 = 1$, because x remains fixed while n gets large

109. Assume the hypotheses of the theorem and let ϵ be a positive number. For all ϵ there exists an N_1 such that when $n > N_1$ then $|a_n - L| < \epsilon \Rightarrow -\epsilon < a_n - L < \epsilon \Rightarrow L - \epsilon < a_n$, and there exists an N_2 such that when $n > N_2$ then $|c_n - L| < \epsilon \Rightarrow -\epsilon < c_n - L < \epsilon \Rightarrow c_n < L + \epsilon$. If $n > \max\{N_1, N_2\}$, then $L - \epsilon < a_n \leq b_n \leq c_n < L + \epsilon \Rightarrow |b_n - L| < \epsilon \Rightarrow \lim_{n \rightarrow \infty} b_n = L$.

110. Let $\epsilon > 0$. We have f continuous at $L \Rightarrow$ there exists δ so that $|x - L| < \delta \Rightarrow |f(x) - f(L)| < \epsilon$. Also, $a_n \rightarrow L \Rightarrow$ there exists N so that for $n > N$, $|a_n - L| < \delta$. Thus for $n > N$, $|f(a_n) - f(L)| < \epsilon \Rightarrow f(a_n) \rightarrow f(L)$.

111. $a_{n+1} \geq a_n \Rightarrow \frac{3(n+1)+1}{(n+1)+1} > \frac{3n+1}{n+1} \Rightarrow \frac{3n+4}{n+2} > \frac{3n+1}{n+1} \Rightarrow 3n^2 + 3n + 4n + 4 > 3n^2 + 6n + n + 2 \Rightarrow 4 > 2$;
 the steps are reversible so the sequence is nondecreasing; $\frac{3n+1}{n+1} < 3 \Rightarrow 3n+1 < 3n+3 \Rightarrow 1 < 3$;
 the steps are reversible so the sequence is bounded above by 3
112. $a_{n+1} \geq a_n \Rightarrow \frac{(2(n+1)+3)!}{((n+1)+1)!} > \frac{(2n+3)!}{(n+1)!} \Rightarrow \frac{(2n+5)!}{(n+2)!} > \frac{(2n+3)!}{(n+1)!} \Rightarrow \frac{(2n+5)!}{(2n+3)!} > \frac{(n+2)!}{(n+1)!} \Rightarrow (2n+5)(2n+4) > n+2$;
 the steps are reversible so the sequence is nondecreasing; the sequence is not bounded since
 $\frac{(2n+3)!}{(n+1)!} = (2n+3)(2n+2)\cdots(n+2)$ can become as large as we please
113. $a_{n+1} \leq a_n \Rightarrow \frac{2^{n+1}3^{n+1}}{(n+1)!} \leq \frac{2^n 3^n}{n!} \Rightarrow \frac{2^{n+1}3^{n+1}}{2^n 3^n} \leq \frac{(n+1)!}{n!} \Rightarrow 2 \cdot 3 \leq n+1$ which is true for $n \geq 5$; the steps are reversible so
 the sequence is decreasing after a_5 , but it is not nondecreasing for all its terms; $a_1 = 6$, $a_2 = 18$, $a_3 = 36$,
 $a_4 = 54$, $a_5 = \frac{324}{5} = 64.8 \Rightarrow$ the sequence is bounded from above by 64.8
114. $a_{n+1} \geq a_n \Rightarrow 2 - \frac{2}{n+1} - \frac{1}{2^{n+1}} \geq 2 - \frac{2}{n} - \frac{1}{2^n} \Rightarrow \frac{2}{n} - \frac{2}{n+1} \geq \frac{1}{2^{n+1}} - \frac{1}{2^n} \Rightarrow \frac{2}{n(n+1)} \geq -\frac{1}{2^{n+1}}$; the steps are reversible so the
 sequence is nondecreasing; $2 - \frac{2}{n} - \frac{1}{2^n} \leq 2 \Rightarrow$ the sequence is bounded from above
115. $a_n = 1 - \frac{1}{n}$ converges because $\frac{1}{n} \rightarrow 0$ by Example 1; also it is a nondecreasing sequence bounded above by 1
116. $a_n = n - \frac{1}{n}$ diverges because $n \rightarrow \infty$ and $\frac{1}{n} \rightarrow 0$ by Example 1, so the sequence is unbounded
117. $a_n = \frac{2^n - 1}{2^n} = 1 - \frac{1}{2^n}$ and $0 < \frac{1}{2^n} < \frac{1}{n}$; since $\frac{1}{n} \rightarrow 0$ (by Example 1) $\Rightarrow \frac{1}{2^n} \rightarrow 0$, the sequence converges; also it is
 a nondecreasing sequence bounded above by 1
118. $a_n = \frac{2^n - 1}{3^n} = \left(\frac{2}{3}\right)^n - \frac{1}{3^n}$; the sequence converges to 0 by Theorem 5, #4
119. $a_n = \left((-1)^n + 1\right)\left(\frac{n+1}{n}\right)$ diverges because $a_n = 0$ for n odd, while for n even $a_n = 2\left(1 + \frac{1}{n}\right)$ converges to 2; it
 diverges by definition of divergence
120. $x_n = \max \{\cos 1, \cos 2, \cos 3, \dots, \cos n\}$ and $x_{n+1} = \max \{\cos 1, \cos 2, \cos 3, \dots, \cos (n+1)\} \geq x_n$ with $x_n \leq 1$
 so the sequence is nondecreasing and bounded above by 1 \Rightarrow the sequence converges.
121. $a_n \geq a_{n+1} \Leftrightarrow \frac{1+\sqrt{2n}}{\sqrt{n}} \geq \frac{1+\sqrt{2(n+1)}}{\sqrt{n+1}} \Leftrightarrow \sqrt{n+1} + \sqrt{2n^2 + 2n} \geq \sqrt{n} + \sqrt{2n^2 + 2n} \Leftrightarrow \sqrt{n+1} \geq \sqrt{n}$ and $\frac{1+\sqrt{2n}}{\sqrt{n}} \geq \sqrt{2}$;
 thus the sequence is nonincreasing and bounded below by $\sqrt{2} \Rightarrow$ it converges
122. $a_n \geq a_{n+1} \Leftrightarrow \frac{n+1}{n} \geq \frac{(n+1)+1}{n+1} \Leftrightarrow n^2 + 2n + 1 \geq n^2 + 2n \Leftrightarrow 1 \geq 0$ and $\frac{n+1}{n} \geq 1$; thus the sequence is nonincreasing
 and bounded below by 1 \Rightarrow it converges

123. $\frac{4^{n+1}+3^n}{4^n} = 4 + \left(\frac{3}{4}\right)^n$ so $a_n \geq a_{n+1} \Leftrightarrow 4 + \left(\frac{3}{4}\right)^n \geq 4 + \left(\frac{3}{4}\right)^{n+1} \Leftrightarrow \left(\frac{3}{4}\right)^n \geq \left(\frac{3}{4}\right)^{n+1} \Leftrightarrow 1 \geq \frac{3}{4}$ and $4 + \left(\frac{3}{4}\right)^n \geq 4$; thus the sequence is nonincreasing and bounded below by 4 \Rightarrow it converges

124. $a_1 = 1$, $a_2 = 2 - 3$, $a_3 = 2(2 - 3) - 3 = 2^2 - (2^2 - 1) \cdot 3$, $a_4 = 2(2^2 - (2^2 - 1) \cdot 3) - 3 = 2^3 - (2^3 - 1) \cdot 3$,
 $a_5 = 2[2^3 - (2^3 - 1) \cdot 3] - 3 = 2^4 - (2^4 - 1) \cdot 3$, ..., $a_n = 2^{n-1} - (2^{n-1} - 1) \cdot 3 = 2^{n-1} - 3 \cdot 2^{n-1} + 3$
 $= 2^{n-1}(1 - 3) + 3 = -2^{n-1} + 3$; $a_n \geq a_{n+1} \Leftrightarrow -2^{n-1} + 3 \geq -2^n + 3 \Leftrightarrow -2^{n-1} \geq -2^n \Leftrightarrow 1 \leq 2$ so the sequence is nonincreasing but not bounded below and therefore diverges

125. For a given ε , choose N to be any integer greater than $1/\varepsilon$. Then for $n > N$,

$$\left| \frac{\sin n}{n} - 0 \right| = \frac{|\sin n|}{n} \leq \frac{1}{n} < \frac{1}{N} < \varepsilon.$$

126. For a given ε , choose N to be any integer greater than $1/\sqrt{\varepsilon}$. Then for $n > N$, $\left| 1 - \frac{1}{n^2} - 1 \right| = \frac{1}{n^2} < \frac{1}{N^2} < \varepsilon$.

127. Let $0 < M < 1$ and let N be an integer greater than $\frac{M}{1-M}$. Then $n > N \Rightarrow n > \frac{M}{1-M} \Rightarrow n - nM > M$
 $\Rightarrow n > M + nM \Rightarrow n > M(n+1) \Rightarrow \frac{n}{n+1} > M$.

128. Since M_1 is a least upper bound and M_2 is an upper bound, $M_1 \leq M_2$. Since M_2 is a least upper bound and M_1 is an upper bound, $M_2 \leq M_1$. We conclude that $M_1 = M_2$ so the least upper bound is unique.

129. The sequence $a_n = 1 + \frac{(-1)^n}{2}$ is the sequence $\frac{1}{2}, \frac{3}{2}, \frac{1}{2}, \frac{3}{2}, \dots$. This sequence is bounded above by $\frac{3}{2}$, but it clearly does not converge, by definition of convergence.

130. Let L be the limit of the convergent sequence $\{a_n\}$. Then by definition of convergence, for $\frac{\varepsilon}{2}$ there corresponds an N such that for all m and n , $m > N \Rightarrow |a_m - L| < \frac{\varepsilon}{2}$ and $n > N \Rightarrow |a_n - L| < \frac{\varepsilon}{2}$. Now
 $|a_m - a_n| = |a_m - L + L - a_n| \leq |a_m - L| + |L - a_n| < \frac{\varepsilon}{2} + \frac{\varepsilon}{2} = \varepsilon$ whenever $m > N$ and $n > N$.

131. Given an $\varepsilon > 0$, by definition of convergence there corresponds an N such that for all $n > N$, $|L_1 - a_n| < \varepsilon$ and $|L_2 - a_n| < \varepsilon$. Now $|L_2 - L_1| = |L_2 - a_n + a_n - L_1| \leq |L_2 - a_n| + |a_n - L_1| < \varepsilon + \varepsilon = 2\varepsilon$. $|L_2 - L_1| < 2\varepsilon$ says that the difference between two fixed values is smaller than any positive number 2ε . The only nonnegative number smaller than every positive number is 0, so $|L_1 - L_2| = 0$ or $L_1 = L_2$.

132. Let $k(n)$ and $i(n)$ be two order-preserving functions whose domains are the set of positive integers and whose ranges are a subset of the positive integers. Consider the two subsequences $a_{k(n)}$ and $a_{i(n)}$, where

$a_{k(n)} \rightarrow L_1$, $a_{i(n)} \rightarrow L_2$ and $L_1 \neq L_2$. Thus $|a_{k(n)} - a_{i(n)}| \rightarrow |L_1 - L_2| > 0$. So there does not exist N such that for all m , $n > N \Rightarrow |a_m - a_n| < \varepsilon$. So by Exercise 128, the sequence $\{a_n\}$ is not convergent and hence diverges.

133. $a_{2k} \rightarrow L \Leftrightarrow$ given an $\epsilon > 0$ there corresponds an N_1 such that $[2k > N_1 \Rightarrow |a_{2k} - L| < \epsilon]$. Similarly, $a_{2k+1} \rightarrow L \Leftrightarrow [2k+1 > N_2 \Rightarrow |a_{2k+1} - L| < \epsilon]$. Let $N = \max\{N_1, N_2\}$. Then $n > N \Rightarrow |a_n - L| < \epsilon$ whether n is even or odd, and hence $a_n \rightarrow L$.

134. Assume $a_n \rightarrow 0$. This implies that given an $\epsilon > 0$ there corresponds an N such that $n > N \Rightarrow |a_n - 0| < \epsilon \Rightarrow |a_n| < \epsilon \Rightarrow \|a_n\| < \epsilon \Rightarrow \|a_n - 0\| < \epsilon \Rightarrow |a_n| \rightarrow 0$. On the other hand, assume $|a_n| \rightarrow 0$. This implies that given an $\epsilon > 0$ there corresponds an N such that for $n > N$, $\|a_n - 0\| < \epsilon \Rightarrow \|a_n\| < \epsilon \Rightarrow |a_n| < \epsilon \Rightarrow |a_n - 0| < \epsilon \Rightarrow a_n \rightarrow 0$.

135. (a) $f(x) = x^2 - a \Rightarrow f'(x) = 2x \Rightarrow x_{n+1} = x_n - \frac{x_n^2 - a}{2x_n} \Rightarrow x_{n+1} = \frac{2x_n^2 - (x_n^2 - a)}{2x_n} = \frac{x_n^2 + a}{2x_n} = \frac{x_n + \frac{a}{x_n}}{2}$

(b) $x_1 = 2$, $x_2 = 1.75$, $x_3 = 1.732142857$, $x_4 = 1.73205081$, $x_5 = 1.732050808$; we are finding the positive number where $x^2 - 3 = 0$; that is, where $x^2 = 3$, $x > 0$, or where $x = \sqrt{3}$.

136. $x_1 = 1$, $x_2 = 1 + \cos(1) = 1.540302306$, $x_3 = 1.540302306 + \cos(1 + \cos(1)) = 1.570791601$,
 $x_4 = 1.570791601 + \cos(1.570791601) = 1.570796327 = \frac{\pi}{2}$ to 9 decimal places. After a few steps, the arc (x_{n-1}) and line segment $\cos(x_{n-1})$ are nearly the same as the quarter circle.

137-148. Example CAS Commands:

Mathematica: (sequence functions may vary):

```
Clear[a, n]
a[n_] := n1/n
first25 = Table[N[a[n]], {n, 1, 25}]
Limit[a[n], n → 8]
```

The last command (Limit) will not always work in Mathematica. You could also explore the limit by enlarging your table to more than the first 25 values.

If you know the limit (1 in the above example), to determine how far to go to have all further terms within 0.01 of the limit, do the following.

```
Clear[minN, lim]
lim = 1
Do[{diff = Abs[a[n] - lim], If[diff < .01, {minN = n, Abort[]}]}, {n, 2, 1000}]
minN
```

For sequences that are given recursively, the following code is suggested. The portion of the command $a[n_]:=a[n]$ stores the elements of the sequence and helps to streamline computation.

```
Clear[a, n]
a[1] = 1;
a[n_] := a[n] = a[n-1] + (1/5)n-1
first25 = Table[N[a[n]], {n, 1, 25}]
```

The limit command does not work in this case, but the limit can be observed as 1.25.

Clear[minN, lim]

lim=1.25

Do[{diff=Abs[a[n]-lim], If[diff<.01, {minN=n, Abort[]}]}, {n, 2, 1000}]

minN

10.2 INFINITE SERIES

$$1. \quad s_n = \frac{a(1-r^n)}{(1-r)} = \frac{2\left(1-\left(\frac{1}{3}\right)^n\right)}{1-\left(\frac{1}{3}\right)} \Rightarrow \lim_{n \rightarrow \infty} s_n = \frac{2}{1-\left(\frac{1}{3}\right)} = 3$$

$$2. \quad s_n = \frac{a(1-r^n)}{(1-r)} = \frac{\left(\frac{9}{100}\right)\left(1-\left(\frac{1}{100}\right)^n\right)}{1-\left(\frac{1}{100}\right)} \Rightarrow \lim_{n \rightarrow \infty} s_n = \frac{\left(\frac{9}{100}\right)}{1-\left(\frac{1}{100}\right)} = \frac{1}{11}$$

$$3. \quad s_n = \frac{a(1-r^n)}{(1-r)} = \frac{1-\left(-\frac{1}{2}\right)^n}{1-\left(-\frac{1}{2}\right)} \Rightarrow \lim_{n \rightarrow \infty} s_n = \frac{1}{\left(\frac{3}{2}\right)} = \frac{2}{3}$$

$$4. \quad s_n = \frac{1-(-2)^n}{1-(-2)}, \text{ a geometric series where } |r| > 1 \Rightarrow \text{divergence}$$

$$5. \quad \frac{1}{(n+1)(n+2)} = \frac{1}{n+1} - \frac{1}{n+2} \Rightarrow s_n = \left(\frac{1}{2} - \frac{1}{3}\right) + \left(\frac{1}{3} - \frac{1}{4}\right) + \dots + \left(\frac{1}{n+1} - \frac{1}{n+2}\right) = \frac{1}{2} - \frac{1}{n+2} \Rightarrow \lim_{n \rightarrow \infty} s_n = \frac{1}{2}$$

$$6. \quad \frac{5}{n(n+1)} = \frac{5}{n} - \frac{5}{n+1} \Rightarrow s_n = \left(5 - \frac{5}{2}\right) + \left(\frac{5}{2} - \frac{5}{3}\right) + \left(\frac{5}{3} - \frac{5}{4}\right) + \dots + \left(\frac{5}{n-1} - \frac{5}{n}\right) + \left(\frac{5}{n} - \frac{5}{n+1}\right) = 5 - \frac{5}{n+1} \Rightarrow \lim_{n \rightarrow \infty} s_n = 5$$

$$7. \quad 1 - \frac{1}{4} + \frac{1}{16} - \frac{1}{64} + \dots, \text{ the sum of this geometric series is } \frac{1}{1-\left(-\frac{1}{4}\right)} = \frac{1}{1+\left(\frac{1}{4}\right)} = \frac{4}{5}$$

$$8. \quad \frac{1}{16} + \frac{1}{64} + \frac{1}{256} + \dots, \text{ the sum of this geometric series is } \frac{\left(\frac{1}{16}\right)}{1-\left(-\frac{1}{4}\right)} = \frac{1}{12}$$

$$9. \quad \frac{7}{4} + \frac{7}{16} + \frac{7}{64} + \dots, \text{ the sum of this geometric series is } \frac{\left(\frac{7}{4}\right)}{1-\left(-\frac{1}{4}\right)} = \frac{7}{3}$$

$$10. \quad 5 - \frac{5}{4} + \frac{5}{16} - \frac{5}{64} + \dots, \text{ the sum of this geometric series is } \frac{5}{1-\left(-\frac{1}{4}\right)} = 4$$

$$11. \quad (5+1) + \left(\frac{5}{2} + \frac{1}{3}\right) + \left(\frac{5}{4} + \frac{1}{9}\right) + \left(\frac{5}{8} + \frac{1}{27}\right) + \dots, \text{ is the sum of two geometric series; the sum is}$$

$$\frac{5}{1-\left(\frac{1}{2}\right)} + \frac{1}{1-\left(\frac{1}{3}\right)} = 10 + \frac{3}{2} = \frac{23}{2}$$

12. $(5-1) + \left(\frac{5}{2} - \frac{1}{3}\right) + \left(\frac{5}{4} - \frac{1}{9}\right) + \left(\frac{5}{8} - \frac{1}{27}\right) + \dots$, is the difference of two geometric series; the sum is

$$\frac{5}{1-\frac{1}{2}} - \frac{1}{1-\frac{1}{3}} = 10 - \frac{3}{2} = \frac{17}{2}$$
13. $(1+1) + \left(\frac{1}{2} - \frac{1}{5}\right) + \left(\frac{1}{4} + \frac{1}{25}\right) + \left(\frac{1}{8} - \frac{1}{125}\right) + \dots$, is the sum of two geometric series; the sum is

$$\frac{1}{1-\frac{1}{2}} + \frac{1}{1+\frac{1}{5}} = 2 + \frac{5}{6} = \frac{17}{6}$$
14. $2 + \frac{4}{5} + \frac{8}{25} + \frac{16}{125} + \dots = 2\left(1 + \frac{2}{5} + \frac{4}{25} + \frac{8}{125} + \dots\right)$; the sum of this geometric series is $2\left(\frac{1}{1-\frac{2}{5}}\right) = \frac{10}{3}$
15. Series is geometric with $r = \frac{2}{5} \Rightarrow \left|\frac{2}{5}\right| < 1 \Rightarrow$ Converges to $\frac{1}{1-\frac{2}{5}} = \frac{5}{3}$
16. Series is geometric with $r = -3 \Rightarrow |-3| > 1 \Rightarrow$ Diverges
17. Series is geometric with $r = \frac{1}{8} \Rightarrow \left|\frac{1}{8}\right| < 1 \Rightarrow$ Converges to $\frac{\frac{1}{8}}{1-\frac{1}{8}} = \frac{1}{7}$
18. Series is geometric with $r = -\frac{2}{3} \Rightarrow \left|-\frac{2}{3}\right| < 1 \Rightarrow$ Converges to $\frac{-\frac{2}{3}}{1-\left(-\frac{2}{3}\right)} = -\frac{2}{5}$
19. $0.\overline{23} = \sum_{n=0}^{\infty} \frac{23}{100} \left(\frac{1}{10^2}\right)^n = \frac{\left(\frac{23}{100}\right)}{1-\left(\frac{1}{100}\right)} = \frac{23}{99}$
20. $0.\overline{234} = \sum_{n=0}^{\infty} \frac{234}{1000} \left(\frac{1}{10^3}\right)^n = \frac{\left(\frac{234}{1000}\right)}{1-\left(\frac{1}{1000}\right)} = \frac{234}{999}$
21. $0.\overline{7} = \sum_{n=0}^{\infty} \frac{7}{10} \left(\frac{1}{10}\right)^n = \frac{\left(\frac{7}{10}\right)}{1-\left(\frac{1}{10}\right)} = \frac{7}{9}$
22. $0.\overline{d} = \sum_{n=0}^{\infty} \frac{d}{10} \left(\frac{1}{10}\right)^n = \frac{\left(\frac{d}{10}\right)}{1-\left(\frac{1}{10}\right)} = \frac{d}{9}$
23. $0.0\overline{6} = \sum_{n=0}^{\infty} \left(\frac{1}{10}\right) \left(\frac{6}{10}\right) \left(\frac{1}{10}\right)^n = \frac{\left(\frac{6}{100}\right)}{1-\left(\frac{1}{10}\right)} = \frac{6}{90} = \frac{1}{15}$
24. $1.\overline{414} = 1 + \sum_{n=0}^{\infty} \frac{414}{1000} \left(\frac{1}{10^3}\right)^n = 1 + \frac{\left(\frac{414}{1000}\right)}{1-\left(\frac{1}{1000}\right)} = 1 + \frac{414}{999} = \frac{1413}{999}$
25. $1.24\overline{123} = \frac{124}{100} + \sum_{n=0}^{\infty} \frac{123}{10^5} \left(\frac{1}{10^3}\right)^n = \frac{124}{100} + \frac{\left(\frac{123}{10^5}\right)}{1-\left(\frac{1}{10^3}\right)} = \frac{124}{100} + \frac{123}{10^5-10^2} = \frac{124}{100} + \frac{123}{99,900} = \frac{123,999}{99,900} = \frac{41,333}{33,300}$
26. $3.\overline{142857} = 3 + \sum_{n=0}^{\infty} \frac{142,857}{10^6} \left(\frac{1}{10^6}\right)^n = 3 + \frac{\left(\frac{142,857}{10^6}\right)}{1-\left(\frac{1}{10^6}\right)} = 3 + \frac{142,857}{10^6-1} = \frac{3,142,854}{999,999} = \frac{116,402}{37,037}$

27. $\lim_{n \rightarrow \infty} \frac{n}{n+10} = \lim_{n \rightarrow \infty} \frac{1}{1} = 1 \neq 0 \Rightarrow$ diverges
28. $\lim_{n \rightarrow \infty} \frac{n(n+1)}{(n+2)(n+3)} = \lim_{n \rightarrow \infty} \frac{n^2+n}{n^2+5n+6} = \lim_{n \rightarrow \infty} \frac{2n+1}{2n+5} = \lim_{n \rightarrow \infty} \frac{2}{2} = 1 \neq 0 \Rightarrow$ diverges
29. $\lim_{n \rightarrow \infty} \frac{1}{n+4} = 0 \Rightarrow$ test inconclusive
30. $\lim_{n \rightarrow \infty} \frac{n}{n^2+3} = \lim_{n \rightarrow \infty} \frac{1}{2n} = 0 \Rightarrow$ test inconclusive
31. $\lim_{n \rightarrow \infty} \cos \frac{1}{n} = \cos 0 = 1 \neq 0 \Rightarrow$ diverges
32. $\lim_{n \rightarrow \infty} \frac{e^n}{e^n+n} = \lim_{n \rightarrow \infty} \frac{e^n}{e^n+1} = \lim_{n \rightarrow \infty} \frac{e^n}{e^n} = \lim_{n \rightarrow \infty} \frac{1}{1} = 1 \neq 0 \Rightarrow$ diverges
33. $\lim_{n \rightarrow \infty} \ln \frac{1}{n} = -\infty \neq 0 \Rightarrow$ diverges
34. $\lim_{n \rightarrow \infty} \cos n\pi =$ does not exist \Rightarrow diverges
35. $s_k = \left(1 - \frac{1}{2}\right) + \left(\frac{1}{2} - \frac{1}{3}\right) + \left(\frac{1}{3} - \frac{1}{4}\right) + \dots + \left(\frac{1}{k-1} - \frac{1}{k}\right) + \left(\frac{1}{k} - \frac{1}{k+1}\right) = 1 - \frac{1}{k+1} \Rightarrow \lim_{k \rightarrow \infty} s_k = \lim_{k \rightarrow \infty} \left(1 - \frac{1}{k+1}\right) = 1,$
series converges to 1
36. $s_k = \left(\frac{3}{1} - \frac{3}{4}\right) + \left(\frac{3}{4} - \frac{3}{9}\right) + \left(\frac{3}{9} - \frac{3}{16}\right) + \dots + \left(\frac{3}{(k-1)^2} - \frac{3}{k^2}\right) + \left(\frac{3}{k^2} - \frac{3}{(k+1)^2}\right) = 3 - \frac{3}{(k+1)^2}$
 $\Rightarrow \lim_{k \rightarrow \infty} s_k = \lim_{k \rightarrow \infty} \left(3 - \frac{3}{(k+1)^2}\right) = 3,$ series converges to 3
37. $s_k = (\ln \sqrt{2} - \ln \sqrt{1}) + (\ln \sqrt{3} - \ln \sqrt{2}) + (\ln \sqrt{4} - \ln \sqrt{3}) + \dots + (\ln \sqrt{k} - \ln \sqrt{k-1}) + (\ln \sqrt{k+1} - \ln \sqrt{k})$
 $= \ln \sqrt{k+1} - \ln \sqrt{1} = \ln \sqrt{k+1} \Rightarrow \lim_{k \rightarrow \infty} s_k = \lim_{k \rightarrow \infty} \ln \sqrt{k+1} = \infty;$ series diverges
38. $s_k = (\tan 1 - \tan 0) + (\tan 2 - \tan 1) + (\tan 3 - \tan 2) + \dots + (\tan k - \tan(k-1)) + (\tan(k+1) - \tan k)$
 $= \tan(k+1) - \tan 0 = \tan(k+1) \Rightarrow \lim_{k \rightarrow \infty} s_k = \lim_{k \rightarrow \infty} \tan(k+1) =$ does not exist; series diverges
39. $s_k = \left(\cos^{-1}\left(\frac{1}{2}\right) - \cos^{-1}\left(\frac{1}{3}\right)\right) + \left(\cos^{-1}\left(\frac{1}{3}\right) - \cos^{-1}\left(\frac{1}{4}\right)\right) + \left(\cos^{-1}\left(\frac{1}{4}\right) - \cos^{-1}\left(\frac{1}{5}\right)\right) + \dots$
 $+ \left(\cos^{-1}\left(\frac{1}{k}\right) - \cos^{-1}\left(\frac{1}{k+1}\right)\right) + \left(\cos^{-1}\left(\frac{1}{k+1}\right) - \cos^{-1}\left(\frac{1}{k+2}\right)\right) = \frac{\pi}{3} - \cos^{-1}\left(\frac{1}{k+2}\right)$
 $\Rightarrow \lim_{k \rightarrow \infty} s_k = \lim_{k \rightarrow \infty} \left[\frac{\pi}{3} - \cos^{-1}\left(\frac{1}{k+2}\right)\right] = \frac{\pi}{3} - \frac{\pi}{2} = \frac{\pi}{6},$ series converges to $\frac{\pi}{6}$

40. $s_k = (\sqrt{5} - \sqrt{4}) + (\sqrt{6} - \sqrt{5}) + (\sqrt{7} - \sqrt{6}) + \dots + (\sqrt{k+3} - \sqrt{k+2}) + (\sqrt{k+4} - \sqrt{k+3}) = \sqrt{k+4} - 2$
 $\Rightarrow \lim_{k \rightarrow \infty} s_k = \lim_{k \rightarrow \infty} [\sqrt{k+4} - 2] = \infty$; series diverges
41. $\frac{4}{(4n-3)(4n+1)} = \frac{1}{4n-3} - \frac{1}{4n+1} \Rightarrow s_k = (1 - \frac{1}{5}) + (\frac{1}{5} - \frac{1}{9}) + (\frac{1}{9} - \frac{1}{13}) + \dots + (\frac{1}{4k-7} - \frac{1}{4k-3}) + (\frac{1}{4k-3} - \frac{1}{4k+1}) = 1 - \frac{1}{4k+1}$
 $\Rightarrow \lim_{k \rightarrow \infty} s_k = \lim_{k \rightarrow \infty} (1 - \frac{1}{4k+1}) = 1$
42. $\frac{6}{(2n-1)(2n+1)} = \frac{A}{2n-1} + \frac{B}{2n+1} = \frac{A(2n+1) + B(2n-1)}{(2n-1)(2n+1)} \Rightarrow A(2n+1) + B(2n-1) = 6 \Rightarrow (2A+2B)n + (A-B) = 6$
 $\Rightarrow \begin{cases} 2A+2B=6 \\ A-B=6 \end{cases} \Rightarrow \begin{cases} A+B=3 \\ A-B=6 \end{cases} \Rightarrow 2A=9 \Rightarrow A=4.5 \text{ and } B=-1.5$. Hence, $\sum_{n=1}^k \frac{6}{(2n-1)(2n+1)} = 3 \sum_{n=1}^k (\frac{1}{2n-1} - \frac{1}{2n+1})$
 $= 3(\frac{1}{1} - \frac{1}{3} + \frac{1}{3} - \frac{1}{5} + \frac{1}{5} - \frac{1}{7} + \dots - \frac{1}{2(k-1)+1} + \frac{1}{2k-1} - \frac{1}{2k+1}) = 3(1 - \frac{1}{2k+1}) \Rightarrow$ the sum is $\lim_{k \rightarrow \infty} 3(1 - \frac{1}{2k+1}) = 3$
43. $\frac{40n}{(2n-1)^2(2n+1)^2} = \frac{A}{(2n-1)} + \frac{B}{(2n-1)^2} + \frac{C}{(2n+1)} + \frac{D}{(2n+1)^2} = \frac{A(2n-1)(2n+1)^2 + B(2n+1)^2 + C(2n+1)(2n-1)^2 + D(2n-1)^2}{(2n-1)^2(2n+1)^2}$
 $\Rightarrow A(2n-1)(2n+1)^2 + B(2n+1)^2 + C(2n+1)(2n-1)^2 + D(2n-1)^2 = 40n$
 $\Rightarrow A(8n^3 + 4n^2 - 2n - 1) + B(4n^2 + 4n + 1) + C(8n^3 - 4n^2 - 2n + 1) + D(4n^2 - 4n + 1) = 40n$
 $\Rightarrow (8A+8C)n^3 + (4A+4B-4C+4D)n^2 + (-2A+4B-2C-4D)n + (-A+B+C+D) = 40n$
 $\Rightarrow \begin{cases} 8A+8C=0 \\ 4A+4B-4C+4D=0 \\ -2A+4B-2C-4D=40 \\ -A+B+C+D=0 \end{cases} \Rightarrow \begin{cases} A+C=0 \\ A+B-C+D=0 \\ -A+2B-C-2D=20 \\ -A+B+C+D=0 \end{cases} \Rightarrow \begin{cases} B+D=0 \\ 2B-2D=20 \end{cases} \Rightarrow 4B=20 \Rightarrow B=5$
 and $D = -5 \Rightarrow \begin{cases} A+C=0 \\ -A+5+C-5=0 \end{cases} \Rightarrow C=0 \text{ and } A=0$. Hence,
 $\sum_{n=1}^k \left[\frac{40n}{(2n-1)^2(2n+1)^2} \right] = 5 \sum_{n=1}^k \left[\frac{1}{(2n-1)^2} - \frac{1}{(2n+1)^2} \right] = 5 \left(\frac{1}{1} - \frac{1}{9} + \frac{1}{9} - \frac{1}{25} + \frac{1}{25} - \dots - \frac{1}{(2(k-1)+1)^2} + \frac{1}{(2k-1)^2} - \frac{1}{(2k+1)^2} \right)$
 $= 5 \left(1 - \frac{1}{(2k+1)^2} \right) \Rightarrow$ the sum is $\lim_{n \rightarrow \infty} 5 \left(1 - \frac{1}{(2k+1)^2} \right) = 5$
44. $\frac{2n+1}{n^2(n+1)^2} = \frac{1}{n^2} - \frac{1}{(n+1)^2} \Rightarrow s_k = (1 - \frac{1}{4}) + (\frac{1}{4} - \frac{1}{9}) + (\frac{1}{9} - \frac{1}{16}) + \dots + \left[\frac{1}{(k-1)^2} - \frac{1}{k^2} \right] + \left[\frac{1}{k^2} - \frac{1}{(k+1)^2} \right]$
 $\Rightarrow \lim_{k \rightarrow \infty} s_k = \lim_{k \rightarrow \infty} \left[1 - \frac{1}{(k+1)^2} \right] = 1$
45. $s_k = (1 - \frac{1}{\sqrt{2}}) + (\frac{1}{\sqrt{2}} - \frac{1}{\sqrt{3}}) + (\frac{1}{\sqrt{3}} - \frac{1}{\sqrt{4}}) + \dots + (\frac{1}{\sqrt{k-1}} + \frac{1}{\sqrt{k}}) + (\frac{1}{\sqrt{k}} - \frac{1}{\sqrt{k+1}}) = 1 - \frac{1}{\sqrt{k+1}}$
 $\Rightarrow \lim_{k \rightarrow \infty} s_k = \lim_{k \rightarrow \infty} (1 - \frac{1}{\sqrt{k+1}}) = 1$
46. $s_k = (\frac{1}{2} - \frac{1}{2^{1/2}}) + (\frac{1}{2^{1/2}} - \frac{1}{2^{1/3}}) + (\frac{1}{2^{1/3}} - \frac{1}{2^{1/4}}) + \dots + (\frac{1}{2^{1/(k-1)}} - \frac{1}{2^{1/k}}) + (\frac{1}{2^{1/k}} - \frac{1}{2^{1/(k+1)}}) = \frac{1}{2} - \frac{1}{2^{1/(k+1)}}$
 $\Rightarrow \lim_{k \rightarrow \infty} s_k = \frac{1}{2} - \frac{1}{1} = -\frac{1}{2}$

$$47. s_k = \left(\frac{1}{\ln 3} - \frac{1}{\ln 2}\right) + \left(\frac{1}{\ln 4} - \frac{1}{\ln 3}\right) + \left(\frac{1}{\ln 5} - \frac{1}{\ln 4}\right) + \dots + \left(\frac{1}{\ln(k+1)} - \frac{1}{\ln k}\right) + \left(\frac{1}{\ln(k+2)} - \frac{1}{\ln(k+1)}\right) = -\frac{1}{\ln 2} + \frac{1}{\ln(k+2)}$$

$$\Rightarrow \lim_{k \rightarrow \infty} s_k = -\frac{1}{\ln 2}$$

$$48. s_k = \left[\tan^{-1}(1) - \tan^{-1}(2)\right] + \left[\tan^{-1}(2) - \tan^{-1}(3)\right] + \dots + \left[\tan^{-1}(k-1) - \tan^{-1}(k)\right] + \left[\tan^{-1}(k) - \tan^{-1}(k+1)\right]$$

$$= \tan^{-1}(1) - \tan^{-1}(k+1) \Rightarrow \lim_{k \rightarrow \infty} s_k = \tan^{-1}(1) - \frac{\pi}{2} = \frac{\pi}{4} - \frac{\pi}{2} = -\frac{\pi}{4}$$

$$49. \text{convergent geometric series with sum } \frac{1}{1 - \left(\frac{1}{\sqrt{2}}\right)} = \frac{\sqrt{2}}{\sqrt{2}-1} = 2 + \sqrt{2}$$

$$50. \text{divergent geometric series with } |r| = \sqrt{2} > 1$$

$$51. \text{convergent geometric series with sum } \frac{\left(\frac{3}{2}\right)}{1 - \left(-\frac{1}{2}\right)} = 1$$

$$52. \lim_{n \rightarrow \infty} (-1)^{n+1} n \neq 0 \Rightarrow \text{diverges}$$

53. The sequence $a_n = \cos\left(\frac{n\pi}{2}\right)$ starting with $n = 0$ is $1, 0, -1, 0, 1, 0, -1, 0, \dots$, so the sequence of partial sums for the given series is $1, 1, 0, 0, 1, 1, 0, 0, \dots$ and thus the series diverges.

$$54. \cos(n\pi) = (-1)^n \Rightarrow \text{convergent geometric series with sum } \frac{1}{1 - \left(-\frac{1}{5}\right)} = \frac{5}{6}$$

$$55. \text{convergent geometric series with sum } \frac{1}{1 - \left(\frac{1}{e^2}\right)} = \frac{e^2}{e^2 - 1}$$

$$56. \lim_{n \rightarrow \infty} \ln \frac{1}{3^n} = -\infty \neq 0 \Rightarrow \text{diverges}$$

$$57. \text{convergent geometric series with sum } \frac{2}{1 - \left(\frac{1}{10}\right)} - 2 = \frac{20}{9} - \frac{18}{9} = \frac{2}{9}$$

$$58. \text{convergent geometric series with sum } \frac{1}{1 - \left(\frac{1}{x}\right)} = \frac{x}{x-1}$$

$$59. \text{difference of two geometric series with sum } \frac{1}{1 - \left(\frac{2}{3}\right)} - \frac{1}{1 - \left(\frac{1}{3}\right)} = 3 - \frac{3}{2} = \frac{3}{2}$$

$$60. \lim_{n \rightarrow \infty} \left(1 - \frac{1}{n}\right)^n = \lim_{n \rightarrow \infty} \left(1 + \frac{-1}{n}\right)^n = e^{-1} \neq 0 \Rightarrow \text{diverges}$$

61. $\lim_{n \rightarrow \infty} \frac{n!}{1000^n} = \infty \neq 0 \Rightarrow$ diverges
62. $\lim_{n \rightarrow \infty} \frac{n^n}{n!} = \lim_{n \rightarrow \infty} \frac{n \cdot n \cdots n}{1 \cdot 2 \cdots n} > \lim_{n \rightarrow \infty} n = \infty \Rightarrow$ diverges
63. $\sum_{n=1}^{\infty} \frac{2^n + 3^n}{4^n} = \sum_{n=1}^{\infty} \frac{2^n}{4^n} + \sum_{n=1}^{\infty} \frac{3^n}{4^n} = \sum_{n=1}^{\infty} \left(\frac{1}{2}\right)^n + \sum_{n=1}^{\infty} \left(\frac{3}{4}\right)^n$; both $\sum_{n=1}^{\infty} \left(\frac{1}{2}\right)^n$ and $\sum_{n=1}^{\infty} \left(\frac{3}{4}\right)^n$ are geometric series, and both converge since $r = \frac{1}{2} \Rightarrow \left|\frac{1}{2}\right| < 1$ and $r = \frac{3}{4} \Rightarrow \left|\frac{3}{4}\right| < 1$, respectively $\Rightarrow \sum_{n=1}^{\infty} \left(\frac{1}{2}\right)^n = \frac{\frac{1}{2}}{1 - \frac{1}{2}} = 1$ and $\sum_{n=1}^{\infty} \left(\frac{3}{4}\right)^n = \frac{\frac{3}{4}}{1 - \frac{3}{4}} = 3$
 $\Rightarrow \sum_{n=1}^{\infty} \frac{2^n + 3^n}{4^n} = 1 + 3 = 4$ by Theorem 8, part (1)
64. $\lim_{n \rightarrow \infty} \frac{2^n + 4^n}{3^n + 4^n} = \lim_{n \rightarrow \infty} \frac{\frac{2^n}{4^n} + 1}{\frac{3^n}{4^n} + 1} = \lim_{n \rightarrow \infty} \frac{\left(\frac{1}{2}\right)^n + 1}{\left(\frac{3}{4}\right)^n + 1} = \frac{1}{1} = 1 \neq 0 \Rightarrow$ diverges by n^{th} term test for divergence
65. $\sum_{n=1}^{\infty} \ln\left(\frac{n}{n+1}\right) = \sum_{n=1}^{\infty} [\ln(n) - \ln(n+1)]$
 $\Rightarrow s_k = [\ln(1) - \ln(2)] + [\ln(2) - \ln(3)] + [\ln(3) - \ln(4)] + \dots + [\ln(k-1) - \ln(k)] + [\ln(k) - \ln(k+1)] = -\ln(k+1)$
 $\Rightarrow \lim_{k \rightarrow \infty} s_k = -\infty, \Rightarrow$ diverges
66. $\lim_{n \rightarrow \infty} a_n = \lim_{n \rightarrow \infty} \ln\left(\frac{n}{2n+1}\right) = \ln\left(\frac{1}{2}\right) \neq 0 \Rightarrow$ diverges
67. convergent geometric series with sum $\frac{1}{1 - \left(\frac{e}{\pi}\right)} = \frac{\pi}{\pi - e}$
68. divergent geometric series with $|r| = \frac{e^\pi}{\pi^e} \approx \frac{23.141}{22.459} > 1$
69. $\sum_{n=0}^{\infty} (-1)^n x^n = \sum_{n=0}^{\infty} (-x)^n$; $a = 1, r = -x$; converges to $\frac{1}{1 - (-x)} = \frac{1}{1+x}$ for $|x| < 1$
70. $\sum_{n=0}^{\infty} (-1)^n x^{2n} = \sum_{n=0}^{\infty} (-x^2)^n$; $a = 1, r = -x^2$; converges to $\frac{1}{1+x^2}$ for $|x| < 1$
71. $a = 3, r = \frac{x-1}{2}$; converges to $\frac{3}{1 - \left(\frac{x-1}{2}\right)} = \frac{6}{3-x}$ for $-1 < \frac{x-1}{2} < 1$ or $-1 < x < 3$
72. $\sum_{n=0}^{\infty} \frac{(-1)^n}{2} \left(\frac{1}{3+\sin x}\right)^n = \sum_{n=0}^{\infty} \frac{1}{2} \left(\frac{-1}{3+\sin x}\right)^n$; $a = \frac{1}{2}, r = \frac{-1}{3+\sin x}$; converges to $\frac{\left(\frac{1}{2}\right)}{1 - \left(\frac{-1}{3+\sin x}\right)} = \frac{3+\sin x}{2(4+\sin x)} = \frac{3+\sin x}{8+2\sin x}$
for all x (since $\frac{1}{4} \leq \frac{1}{3+\sin x} \leq \frac{1}{2}$ for all x)
73. $a = 1, r = 2x$; converges to $\frac{1}{1-2x}$ for $|2x| < 1$ or $|x| < \frac{1}{2}$

74. $a = 1, r = -\frac{1}{x^2}$; converges to $\frac{1}{1 - \left(\frac{-1}{x^2}\right)} = \frac{x^2}{x^2 + 1}$ for $\left|\frac{1}{x^2}\right| < 1$ or $|x| > 1$

75. $a = 1, r = -(x + 1)$; converges to $\frac{1}{1 + (x + 1)} = \frac{1}{2 + x}$ for $|x + 1| < 1$ or $-2 < x < 0$

76. $a = 1, r = \frac{3-x}{2}$; converges to $\frac{1}{1 - \left(\frac{3-x}{2}\right)} = \frac{2}{x-1}$ for $\left|\frac{3-x}{2}\right| < 1$ or $1 < x < 5$

77. $a = 1, r = \sin x$; converges to $\frac{1}{1 - \sin x}$ for $x \neq (2k + 1)\frac{\pi}{2}$, k an integer

78. $a = 1, r = \ln x$; converges to $\frac{1}{1 - \ln x}$ for $|\ln x| < 1$ or $e^{-1} < x < e$

79. (a) $\sum_{n=-2}^{\infty} \frac{1}{(n+4)(n+5)}$ (b) $\sum_{n=0}^{\infty} \frac{1}{(n+2)(n+3)}$ (c) $\sum_{n=5}^{\infty} \frac{1}{(n-3)(n-2)}$

80. (a) $\sum_{n=-1}^{\infty} \frac{5}{(n+2)(n+3)}$ (b) $\sum_{n=3}^{\infty} \frac{5}{(n-2)(n-1)}$ (c) $\sum_{n=20}^{\infty} \frac{5}{(n-19)(n-18)}$

81. (a) one example is $\frac{1}{2} + \frac{1}{4} + \frac{1}{8} + \frac{1}{16} + \dots = \frac{\left(\frac{1}{2}\right)}{1 - \left(\frac{1}{2}\right)} = 1$

(b) one example is $-\frac{3}{2} - \frac{3}{4} - \frac{3}{8} - \frac{3}{16} - \dots = \frac{\left(-\frac{3}{2}\right)}{1 - \left(\frac{1}{2}\right)} = -3$

(c) one example is $1 - \frac{1}{2} - \frac{1}{4} - \frac{1}{8} - \frac{1}{16} - \dots = 1 - \frac{\left(\frac{1}{2}\right)}{1 - \left(\frac{1}{2}\right)} = 0$

82. The series $\sum_{n=0}^{\infty} k \left(\frac{1}{2}\right)^{n+1}$ is a geometric series whose sum is $\frac{\left(\frac{k}{2}\right)}{1 - \left(\frac{1}{2}\right)} = k$ where k can be any positive or negative number.

83. Let $a_n = b_n = \left(\frac{1}{2}\right)^n$. Then $\sum_{n=1}^{\infty} a_n = \sum_{n=1}^{\infty} b_n = \sum_{n=1}^{\infty} \left(\frac{1}{2}\right)^n = 1$, while $\sum_{n=1}^{\infty} \left(\frac{a_n}{b_n}\right) = \sum_{n=1}^{\infty} (1)$ diverges.

84. Let $a_n = b_n = \left(\frac{1}{2}\right)^n$. Then $\sum_{n=1}^{\infty} a_n = \sum_{n=1}^{\infty} b_n = \sum_{n=1}^{\infty} \left(\frac{1}{2}\right)^n = 1$, while $\sum_{n=1}^{\infty} (a_n b_n) = \sum_{n=1}^{\infty} \left(\frac{1}{4}\right)^n = \frac{1}{3} \neq AB$.

85. Let $a_n = \left(\frac{1}{4}\right)^n$ and $b_n = \left(\frac{1}{2}\right)^n$. Then $A = \sum_{n=1}^{\infty} a_n = \frac{1}{3}$, $B = \sum_{n=1}^{\infty} b_n = 1$ and $\sum_{n=1}^{\infty} \left(\frac{a_n}{b_n}\right) = \sum_{n=1}^{\infty} \left(\frac{1}{2}\right)^n = 1 \neq \frac{A}{B}$.

86. Yes: $\sum \left(\frac{1}{a_n}\right)$ diverges. The reasoning: $\sum a_n$ converges $\Rightarrow a_n \rightarrow 0 \Rightarrow \frac{1}{a_n} \rightarrow \infty \Rightarrow \sum \left(\frac{1}{a_n}\right)$ diverges by the n th-Term Test.

87. Since the sum of a finite number of terms is finite, adding or subtracting a finite number of terms from a series that diverges does not change the divergence of the series.

88. Let $A_n = a_1 + a_2 + \dots + a_n$ and $\lim_{n \rightarrow \infty} A_n = A$. Assume $\sum (a_n + b_n)$ converges to S . Let

$$\begin{aligned} S_n &= (a_1 + b_1) + (a_2 + b_2) + \dots + (a_n + b_n) \Rightarrow S_n = (a_1 + a_2 + \dots + a_n) + (b_1 + b_2 + \dots + b_n) \\ &\Rightarrow b_1 + b_2 + \dots + b_n = S_n - A_n \Rightarrow \lim_{n \rightarrow \infty} (b_1 + b_2 + \dots + b_n) = S - A \Rightarrow \sum b_n \text{ converges. This contradicts the} \\ &\text{assumption that } \sum b_n \text{ diverges; therefore, } \sum (a_n + b_n) \text{ diverges.} \end{aligned}$$

89. (a) $\frac{2}{1-r} = 5 \Rightarrow \frac{2}{5} = 1-r \Rightarrow r = \frac{3}{5}; 2 + 2\left(\frac{3}{5}\right) + 2\left(\frac{3}{5}\right)^2 + \dots$

(b) $\frac{\left(\frac{13}{2}\right)}{1-r} = 5 \Rightarrow \frac{13}{10} = 1-r \Rightarrow r = -\frac{3}{10}; \frac{13}{2} - \frac{13}{2}\left(\frac{3}{10}\right) + \frac{13}{2}\left(\frac{3}{10}\right)^2 - \frac{13}{2}\left(\frac{3}{10}\right)^3 + \dots$

90. $1 + e^b + e^{2b} + \dots = \frac{1}{1-e^b} = 9 \Rightarrow \frac{1}{9} = 1-e^b \Rightarrow e^b = \frac{8}{9} \Rightarrow b = \ln\left(\frac{8}{9}\right)$

91. $s_n = 1 + 2r + r^2 + 2r^3 + r^4 + 2r^5 + \dots + r^{2n} + 2r^{2n+1}, n = 0, 1, \dots$

$$\Rightarrow s_n = (1 + r^2 + r^4 + \dots + r^{2n}) + (2r + 2r^3 + 2r^5 + \dots + 2r^{2n+1}) \Rightarrow \lim_{n \rightarrow \infty} s_n = \frac{1}{1-r^2} + \frac{2r}{1-r^2} = \frac{1+2r}{1-r^2},$$

if $|r^2| < 1$ or $|r| < 1$

92. $\text{area} = 2^2 + (\sqrt{2})^2 + (1)^2 + \left(\frac{1}{\sqrt{2}}\right)^2 + \dots = 4 + 2 + 1 + \frac{1}{2} + \dots = \frac{4}{1-\frac{1}{2}} = 8 \text{ m}^2$

93. (a) After 24 hours, before the second pill: $300e^{(-0.12)(24)} \approx 16.840$ mg; after 48 hours, the amount present after 24 hours continues to decay and the dose taken at 24 hours has 24 hours to decay, so the amount present is $300e^{(-0.12)(48)} + 300e^{(-0.12)(24)} \approx 0.945 + 16.840 = 17.785$ mg.

(b) The long-run quantity of the drug is $300 \sum_1^{\infty} \left(e^{(-0.12)(24)}\right)^n = 300 \frac{e^{(-0.12)(24)}}{1 - e^{(-0.12)(24)}} \approx 17.84$ mg.

94. $L - s_n = \frac{a}{1-r} - \frac{a(1-r^n)}{1-r} = \frac{ar^n}{1-r}$

95. (a) The endpoint of any closed interval remaining at any stage of the construction will remain in the Cantor set, so some points in the set include $0, \frac{1}{27}, \frac{2}{27}, \frac{1}{9}, \frac{2}{9}, \frac{7}{27}, \frac{8}{27}, \frac{1}{3}, \frac{2}{3}, \frac{7}{9}, \frac{8}{9}, 1$.

(b) The lengths of the intervals removed are:

Stage 1: $\frac{1}{3}$

Stage 2: $\frac{1}{3}\left(1 - \frac{1}{3}\right) = \frac{2}{9}$

Stage 3: $\frac{1}{3}\left(1 - \frac{1}{3} - \frac{2}{9}\right) = \frac{4}{27}$ and so on.

Thus the sum of the lengths of the intervals removed is $\sum_{n=1}^{\infty} \frac{1}{3}\left(\frac{2}{3}\right)^{n-1} = \frac{1}{3} \cdot \frac{1}{1-(2/3)} = 1$.

$$96. \text{ (a) } L_1 = 3, L_2 = 3\left(\frac{4}{3}\right), L_3 = 3\left(\frac{4}{3}\right)^2, \dots, L_n = 3\left(\frac{4}{3}\right)^{n-1} \Rightarrow \lim_{n \rightarrow \infty} L_n = \lim_{n \rightarrow \infty} 3\left(\frac{4}{3}\right)^{n-1} = \infty$$

(b) Using the fact that the area of an equilateral triangle of side length s is $\frac{\sqrt{3}}{4}s^2$, we see that $A_1 = \frac{\sqrt{3}}{4}$,

$$A_2 = A_1 + 3\left(\frac{\sqrt{3}}{4}\right)\left(\frac{1}{3}\right)^2 = \frac{\sqrt{3}}{4} + \frac{\sqrt{3}}{12}, A_3 = A_2 + 3(4)\left(\frac{\sqrt{3}}{4}\right)\left(\frac{1}{3^2}\right)^2 = \frac{\sqrt{3}}{4} + \frac{\sqrt{3}}{12} + \frac{\sqrt{3}}{27},$$

$$A_4 = A_3 + 3(4)^2\left(\frac{\sqrt{3}}{4}\right)\left(\frac{1}{3^3}\right)^2, A_5 = A_4 + 3(4)^3\left(\frac{\sqrt{3}}{4}\right)\left(\frac{1}{3^4}\right)^2, \dots,$$

$$A_n = \frac{\sqrt{3}}{4} + \sum_{k=2}^n 3(4)^{k-2}\left(\frac{\sqrt{3}}{4}\right)\left(\frac{1}{3^2}\right)^{k-1} = \frac{\sqrt{3}}{4} + \sum_{k=2}^n 3\sqrt{3}(4)^{k-3}\left(\frac{1}{9}\right)^{k-1} = \frac{\sqrt{3}}{4} + 3\sqrt{3}\left(\sum_{k=2}^n \frac{4^{k-3}}{9^{k-1}}\right).$$

$$\lim_{n \rightarrow \infty} A_n = \lim_{n \rightarrow \infty} \left(\frac{\sqrt{3}}{4} + 3\sqrt{3}\left(\sum_{k=2}^n \frac{4^{k-3}}{9^{k-1}}\right) \right) = \frac{\sqrt{3}}{4} + 3\sqrt{3}\left(\frac{1}{\frac{36}{1-4}}\right) = \frac{\sqrt{3}}{4} + 3\sqrt{3}\left(\frac{1}{20}\right) = \frac{\sqrt{3}}{4}\left(1 + \frac{3}{5}\right) = \frac{\sqrt{3}}{4}\left(\frac{8}{5}\right) = \frac{8}{5}A_1$$

10.3 THE INTEGRAL TEST

$$1. f(x) = \frac{1}{x^2} \text{ is positive, continuous, and decreasing for } x \geq 1; \int_1^{\infty} \frac{1}{x^2} dx = \lim_{b \rightarrow \infty} \int_1^b \frac{1}{x^2} dx = \lim_{b \rightarrow \infty} \left[-\frac{1}{x}\right]_1^b \\ = \lim_{b \rightarrow \infty} \left(-\frac{1}{b} + 1\right) = 1 \Rightarrow \int_1^{\infty} \frac{1}{x^2} dx \text{ converges} \Rightarrow \sum_{n=1}^{\infty} \frac{1}{n^2} \text{ converges}$$

$$2. f(x) = \frac{1}{x^{0.2}} \text{ is positive, continuous, and decreasing for } x \geq 1; \int_1^{\infty} \frac{1}{x^{0.2}} dx = \lim_{b \rightarrow \infty} \int_1^b \frac{1}{x^{0.2}} dx = \lim_{b \rightarrow \infty} \left[\frac{5}{4}x^{0.8}\right]_1^b \\ = \lim_{b \rightarrow \infty} \left(\frac{5}{4}b^{0.8} - \frac{5}{4}\right) = \infty \Rightarrow \int_1^{\infty} \frac{1}{x^{0.2}} dx \text{ diverges} \Rightarrow \sum_{n=1}^{\infty} \frac{1}{n^{0.2}} \text{ diverges}$$

$$3. f(x) = \frac{1}{x^2+4} \text{ is positive, continuous, and decreasing for } x \geq 1; \int_1^{\infty} \frac{1}{x^2+4} dx = \lim_{b \rightarrow \infty} \int_1^b \frac{1}{x^2+4} dx \\ = \lim_{b \rightarrow \infty} \left[\frac{1}{2} \tan^{-1} \frac{x}{2}\right]_1^b = \lim_{b \rightarrow \infty} \left(\frac{1}{2} \tan^{-1} \frac{b}{2} - \frac{1}{2} \tan^{-1} \frac{1}{2}\right) = \frac{\pi}{4} - \frac{1}{2} \tan^{-1} \frac{1}{2} \Rightarrow \int_1^{\infty} \frac{1}{x^2+4} dx \text{ converges} \\ \Rightarrow \sum_{n=1}^{\infty} \frac{1}{n^2+4} \text{ converges}$$

$$4. f(x) = \frac{1}{x+4} \text{ is positive, continuous, and decreasing for } x \geq 1; \int_1^{\infty} \frac{1}{x+4} dx = \lim_{b \rightarrow \infty} \int_1^b \frac{1}{x+4} dx = \lim_{b \rightarrow \infty} [\ln|x+4|]_1^b \\ = \lim_{b \rightarrow \infty} (\ln|b+4| - \ln 5) = \infty \Rightarrow \int_1^{\infty} \frac{1}{x+4} dx \text{ diverges} \Rightarrow \sum_{n=1}^{\infty} \frac{1}{n+4} \text{ diverges}$$

$$5. f(x) = e^{-2x} \text{ is positive, continuous, and decreasing for } x \geq 1; \int_1^{\infty} e^{-2x} dx = \lim_{b \rightarrow \infty} \int_1^b e^{-2x} dx \\ = \lim_{b \rightarrow \infty} \left[-\frac{1}{2}e^{-2x}\right]_1^b = \lim_{b \rightarrow \infty} \left(-\frac{1}{2e^{2b}} + \frac{1}{2e^2}\right) = \frac{1}{2e^2} \Rightarrow \int_1^{\infty} e^{-2x} dx \text{ converges} \Rightarrow \sum_{n=1}^{\infty} e^{-2n} \text{ converges}$$

6. $f(x) = \frac{1}{x(\ln x)^2}$ is positive, continuous, and decreasing for $x \geq 2$; $\int_2^\infty \frac{1}{x(\ln x)^2} dx = \lim_{b \rightarrow \infty} \int_2^b \frac{1}{x(\ln x)^2} dx$
 $= \lim_{b \rightarrow \infty} \left[-\frac{1}{\ln x} \right]_2^b = \lim_{b \rightarrow \infty} \left(-\frac{1}{\ln b} + \frac{1}{\ln 2} \right) = \frac{1}{\ln 2} \Rightarrow \int_2^\infty \frac{1}{x(\ln x)^2} dx$ converges $\Rightarrow \sum_{n=2}^\infty \frac{1}{n(\ln n)^2}$ converges
7. $f(x) = \frac{x}{x^2+4}$ is positive and continuous for $x \geq 1$, $f'(x) = \frac{4-x^2}{(x^2+4)^2} < 0$ for $x > 2$, thus f is decreasing for
 $x \geq 3$; $\int_3^\infty \frac{x}{x^2+4} dx = \lim_{b \rightarrow \infty} \int_3^b \frac{x}{x^2+4} dx = \lim_{b \rightarrow \infty} \left[\frac{1}{2} \ln(x^2+4) \right]_3^b = \lim_{b \rightarrow \infty} \left(\frac{1}{2} \ln(b^2+4) - \frac{1}{2} \ln(13) \right) = \infty \Rightarrow \int_3^\infty \frac{x}{x^2+4} dx$
 diverges $\Rightarrow \sum_{n=3}^\infty \frac{n}{n^2+4}$ diverges $\Rightarrow \sum_{n=1}^\infty \frac{n}{n^2+4} = \frac{1}{5} + \frac{2}{8} + \sum_{n=3}^\infty \frac{n}{n^2+4}$ diverges
8. $f(x) = \frac{\ln x^2}{x}$ is positive and continuous for $x \geq 2$, $f'(x) = \frac{2-\ln x^2}{x^2} < 0$ for $x > e$, thus f is decreasing for $x \geq 3$;
 $\int_3^\infty \frac{\ln x^2}{x} dx = \lim_{b \rightarrow \infty} \int_3^b \frac{\ln x^2}{x} dx = \lim_{b \rightarrow \infty} \left[2(\ln x) \right]_3^b = \lim_{b \rightarrow \infty} (2(\ln b) - 2(\ln 3)) = \infty \Rightarrow \int_3^\infty \frac{\ln x^2}{x} dx$ diverges
 $\Rightarrow \sum_{n=3}^\infty \frac{\ln n^2}{n}$ diverges $\Rightarrow \sum_{n=2}^\infty \frac{\ln n^2}{n} = \frac{\ln 4}{2} + \sum_{n=3}^\infty \frac{\ln n^2}{n}$ diverges
9. $f(x) = \frac{x^2}{e^{x/3}}$ is positive and continuous for $x \geq 1$, $f'(x) = \frac{-x(x-6)}{3e^{x/3}} < 0$ for $x > 6$, thus f is decreasing for $x \geq 7$;
 $\int_7^\infty \frac{x^2}{e^{x/3}} dx = \lim_{b \rightarrow \infty} \int_7^b \frac{x^2}{e^{x/3}} dx = \lim_{b \rightarrow \infty} \left[-\frac{3x^2}{e^{x/3}} - \frac{18x}{e^{x/3}} - \frac{54}{e^{x/3}} \right]_7^b = \lim_{b \rightarrow \infty} \left(\frac{-3b^2-18b-54}{e^{b/3}} + \frac{327}{e^{7/3}} \right) = \lim_{b \rightarrow \infty} \left(\frac{3(-6b-18)}{e^{b/3}} \right) + \frac{327}{e^{7/3}}$
 $= \lim_{b \rightarrow \infty} \left(\frac{-54}{e^{b/3}} \right) + \frac{327}{e^{7/3}} = \frac{327}{e^{7/3}} \Rightarrow \int_7^\infty \frac{x^2}{e^{x/3}} dx$ converges $\Rightarrow \sum_{n=7}^\infty \frac{n^2}{e^{n/3}}$ converges
 $\Rightarrow \sum_{n=1}^\infty \frac{n^2}{e^{n/3}} = \frac{1}{e^{1/3}} + \frac{4}{e^{2/3}} + \frac{9}{e^1} + \frac{16}{e^{4/3}} + \frac{25}{e^{5/3}} + \frac{36}{e^2} + \sum_{n=7}^\infty \frac{n^2}{e^{n/3}}$ converges
10. $f(x) = \frac{x-4}{x^2-2x+1} = \frac{x-4}{(x-1)^2}$ is continuous for $x \geq 2$, f is positive for $x > 4$, and $f'(x) = \frac{7-x}{(x-1)^3} < 0$ for $x > 7$,
 thus f is decreasing for $x \geq 8$; $\int_8^\infty \frac{x-4}{(x-1)^2} dx = \lim_{b \rightarrow \infty} \left[\int_8^b \frac{x-1}{(x-1)^2} dx - \int_8^b \frac{3}{(x-1)^2} dx \right] = \lim_{b \rightarrow \infty} \left[\int_8^b \frac{1}{x-1} dx - \int_8^b \frac{3}{(x-1)^2} dx \right]$
 $= \lim_{b \rightarrow \infty} \left[\ln|x-1| + \frac{3}{x-1} \right]_8^b = \lim_{b \rightarrow \infty} \left(\ln|b-1| + \frac{3}{b-1} - \ln 7 - \frac{3}{7} \right) = \infty \Rightarrow \int_8^\infty \frac{x-4}{(x-1)^2} dx$ diverges $\Rightarrow \sum_{n=8}^\infty \frac{n-4}{n^2-2n+1}$ diverges
 $\Rightarrow \sum_{n=2}^\infty \frac{n-4}{n^2-2n+1} = -2 - \frac{1}{4} + 0 + \frac{1}{16} + \frac{2}{25} + \frac{3}{36} + \sum_{n=8}^\infty \frac{n-4}{n^2-2n+1}$ diverges
11. converges; a geometric series with $r = \frac{1}{10} < 1$ 12. converges; a geometric series with $r = \frac{1}{e} < 1$
13. diverges; by the n th-Term Test for Divergence, $\lim_{n \rightarrow \infty} \frac{n}{n+1} = 1 \neq 0$
14. diverges by the Integral Test; $\int_1^n \frac{5}{x+1} dx = 5 \ln(n+1) - 5 \ln 2 \Rightarrow \int_1^\infty \frac{5}{x+1} dx \rightarrow \infty$

15. diverges; $\sum_{n=1}^{\infty} \frac{3}{\sqrt{n}} = 3 \sum_{n=1}^{\infty} \frac{1}{\sqrt{n}}$, which is a divergent p -series with $p = \frac{1}{2}$

16. converges; $\sum_{n=1}^{\infty} \frac{-2}{n\sqrt{n}} = -2 \sum_{n=1}^{\infty} \frac{1}{n^{3/2}}$, which is a convergent p -series with $p = \frac{3}{2}$

17. converges; a geometric series with $r = \frac{1}{8} < 1$

18. diverges; $\sum_{n=1}^{\infty} \frac{-8}{n} = -8 \sum_{n=1}^{\infty} \frac{1}{n}$ and since $\sum_{n=1}^{\infty} \frac{1}{n}$ diverges, $-8 \sum_{n=1}^{\infty} \frac{1}{n}$ diverges

19. diverges by the Integral Test: $\int_2^{\infty} \frac{\ln x}{x} dx = \frac{1}{2}(\ln^2 n - \ln 2) \Rightarrow \int_2^{\infty} \frac{\ln x}{x} dx \rightarrow \infty$

20. diverges by the Integral Test: $\int_2^{\infty} \frac{\ln x}{\sqrt{x}} dx$; $\left[t = \ln x, dt = \frac{dx}{x}, dx = e^t dt \right]$
 $\rightarrow \int_{\ln 2}^{\infty} t e^{t/2} dt = \lim_{b \rightarrow \infty} \left[2t e^{t/2} - 4e^{t/2} \right]_{\ln 2}^b = \lim_{b \rightarrow \infty} \left[2e^{b/2}(b-2) - 2e^{(\ln 2)/2}(\ln 2 - 2) \right] = \infty$

21. converges; a geometric series with $r = \frac{2}{3} < 1$

22. diverges; $\lim_{n \rightarrow \infty} \frac{5^n}{4^{n+3}} = \lim_{n \rightarrow \infty} \frac{5^n \ln 5}{4^n \ln 4} = \lim_{n \rightarrow \infty} \left(\frac{\ln 5}{\ln 4} \right) \left(\frac{5}{4} \right)^n = \infty \neq 0$

23. diverges; $\sum_{n=0}^{\infty} \frac{-2}{n+1} = -2 \sum_{n=0}^{\infty} \frac{1}{n+1}$, which diverges by the Integral Test

24. diverges by the Integral Test: $\int_1^{\infty} \frac{dx}{2x-1} = \frac{1}{2} \ln(2n-1) \rightarrow \infty$ as $n \rightarrow \infty$

25. diverges; $\lim_{n \rightarrow \infty} a_n = \lim_{n \rightarrow \infty} \frac{2^n}{n+1} = \lim_{n \rightarrow \infty} \frac{2^n \ln 2}{1} = \infty \neq 0$

26. diverges by the Integral Test: $\int_1^{\infty} \frac{dx}{\sqrt{x}(\sqrt{x}+1)}$; $\left[u = \sqrt{x} + 1, du = \frac{dx}{\sqrt{x}} \right] \rightarrow \int_2^{\sqrt{n}+1} \frac{du}{u} = \ln(\sqrt{n}+1) - \ln 2 \rightarrow \infty$ as $n \rightarrow \infty$

27. diverges; $\lim_{n \rightarrow \infty} \frac{\sqrt[n]{n}}{\ln n} = \lim_{n \rightarrow \infty} \frac{\left(\frac{1}{2\sqrt[n]{n}} \right)}{\left(\frac{1}{n} \right)} = \lim_{n \rightarrow \infty} \frac{\sqrt[n]{n}}{2} = \infty \neq 0$

28. diverges; $\lim_{n \rightarrow \infty} a_n = \lim_{n \rightarrow \infty} \left(1 + \frac{1}{n} \right)^n = e \neq 0$

29. diverges; a geometric series with $r = \frac{1}{\ln 2} \approx 1.44 > 1$

30. converges; a geometric series with $r = \frac{1}{\ln 3} \approx 0.91 < 1$

31. converges by the Integral Test: $\int_3^\infty \frac{\left(\frac{1}{x}\right)}{(\ln x)\sqrt{(\ln x)^2 - 1}} dx$; $[u = \ln x, du = \frac{1}{x} dx]$

$$\rightarrow \int_{\ln 3}^\infty \frac{1}{u\sqrt{u^2 - 1}} du = \lim_{b \rightarrow \infty} \left[\sec^{-1} |u| \right]_{\ln 3}^b = \lim_{b \rightarrow \infty} \left[\sec^{-1} b - \sec^{-1}(\ln 3) \right] = \lim_{b \rightarrow \infty} \left[\cos^{-1} \left(\frac{1}{b} \right) - \sec^{-1}(\ln 3) \right]$$

$$= \cos^{-1}(0) - \sec^{-1}(\ln 3) = \frac{\pi}{2} - \sec^{-1}(\ln 3) \approx 1.1439$$

32. converges by the Integral Test: $\int_1^\infty \frac{1}{x(1+\ln^2 x)} dx = \int_1^\infty \frac{\left(\frac{1}{x}\right)}{1+(\ln x)^2} dx$; $[u = \ln x, du = \frac{1}{x} dx]$

$$\rightarrow \int_0^\infty \frac{1}{1+u^2} du = \lim_{b \rightarrow \infty} \left[\tan^{-1} u \right]_0^b = \lim_{b \rightarrow \infty} \left(\tan^{-1} b - \tan^{-1} 0 \right) = \frac{\pi}{2} - 0 = \frac{\pi}{2}$$

33. diverges by the n th-Term Test for divergence; $\lim_{n \rightarrow \infty} n \sin\left(\frac{1}{n}\right) = \lim_{n \rightarrow \infty} \frac{\sin\left(\frac{1}{n}\right)}{\left(\frac{1}{n}\right)} = \lim_{x \rightarrow 0} \frac{\sin x}{x} = 1 \neq 0$

34. diverges by the n th-Term Test for divergence; $\lim_{n \rightarrow \infty} n \tan\left(\frac{1}{n}\right) = \lim_{n \rightarrow \infty} \frac{\tan\left(\frac{1}{n}\right)}{\left(\frac{1}{n}\right)} = \lim_{n \rightarrow \infty} \frac{\left(-\frac{1}{n^2}\right) \sec^2\left(\frac{1}{n}\right)}{\left(-\frac{1}{n^2}\right)}$

$$= \lim_{n \rightarrow \infty} \sec^2\left(\frac{1}{n}\right) = \sec^2 0 = 1 \neq 0$$

35. converges by the Integral Test: $\int_1^\infty \frac{e^x}{1+e^{2x}} dx$; $[u = e^x, du = e^x dx]$

$$\rightarrow \int_e^\infty \frac{1}{1+u^2} du = \lim_{b \rightarrow \infty} \left[\tan^{-1} u \right]_e^b = \lim_{b \rightarrow \infty} \left(\tan^{-1} b - \tan^{-1} e \right) = \frac{\pi}{2} - \tan^{-1} e \approx 0.35$$

36. converges by the Integral Test: $\int_1^\infty \frac{2}{1+e^x} dx$; $[u = e^x, du = e^x dx, dx = \frac{1}{u} du] \rightarrow \int_e^\infty \frac{2}{u(1+u)} du$

$$= \int_e^\infty \left(\frac{2}{u} - \frac{2}{u+1} \right) du = \lim_{b \rightarrow \infty} \left[2 \ln \frac{u}{u+1} \right]_e^b = \lim_{b \rightarrow \infty} \left[2 \ln \left(\frac{b}{b+1} \right) - 2 \ln \left(\frac{e}{e+1} \right) \right] = 2 \ln 1 - 2 \ln \left(\frac{e}{e+1} \right) = -2 \ln \left(\frac{e}{e+1} \right) \approx 0.63$$

37. converges by the Integral Test: $\int_1^\infty \frac{8 \tan^{-1} x}{1+x^2} dx$; $\left[\begin{array}{l} u = \tan^{-1} x \\ du = \frac{dx}{1+x^2} \end{array} \right] \rightarrow \int_{\pi/4}^{\pi/2} 8u du = \left[4u^2 \right]_{\pi/4}^{\pi/2} = 4 \left(\frac{\pi^2}{4} - \frac{\pi^2}{16} \right) = \frac{3\pi^2}{4}$

38. diverges by the Integral Test: $\int_1^\infty \frac{x}{x^2+1} dx$; $\left[\begin{array}{l} u = x^2 + 1 \\ du = 2x dx \end{array} \right] \rightarrow \frac{1}{2} \int_2^\infty \frac{du}{u} = \lim_{b \rightarrow \infty} \left[\frac{1}{2} \ln u \right]_2^b = \lim_{b \rightarrow \infty} \frac{1}{2} (\ln b - \ln 2) = \infty$

39. converges by the Integral Test: $\int_1^\infty \operatorname{sech} x dx = 2 \lim_{b \rightarrow \infty} \int_1^b \frac{e^x}{1+(e^x)^2} dx = 2 \lim_{b \rightarrow \infty} \left[\tan^{-1} e^x \right]_1^b$

$$= 2 \lim_{b \rightarrow \infty} \left(\tan^{-1} e^b - \tan^{-1} e \right) = \pi - 2 \tan^{-1} e \approx 0.71$$

40. converges by the Integral Test: $\int_1^\infty \operatorname{sech}^2 x \, dx = \lim_{b \rightarrow \infty} \int_1^b \operatorname{sech}^2 x \, dx = \lim_{b \rightarrow \infty} [\tanh x]_1^b = \lim_{b \rightarrow \infty} (\tanh b - \tanh 1) = 1 - \tanh 1 \approx 0.76$

41. $\int_1^\infty \left(\frac{a}{x+2} - \frac{1}{x+4}\right) dx = \lim_{b \rightarrow \infty} [a \ln|x+2| - \ln|x+4|]_1^b = \lim_{b \rightarrow \infty} \left[\ln \frac{(b+2)^a}{b+4} - \ln \left(\frac{3^a}{5}\right) \right] = \lim_{b \rightarrow \infty} \ln \frac{(b+2)^a}{b+4} - \ln \left(\frac{3^a}{5}\right);$
 $\lim_{b \rightarrow \infty} \frac{(b+2)^a}{b+4} = a \lim_{b \rightarrow \infty} (b+2)^{a-1} = \begin{cases} \infty, & a > 1 \\ 1, & a = 1 \end{cases} \Rightarrow$ the series converges to $\ln\left(\frac{5}{3}\right)$ if $a = 1$ and diverges to ∞ if $a > 1$. If $a < 1$, the terms of the series eventually become negative and the Integral Test does not apply. From that point on, however, the series behaves like a negative multiple of the harmonic series, and so it diverges.

42. $\int_3^\infty \left(\frac{1}{x-1} - \frac{2a}{x+1}\right) dx = \lim_{b \rightarrow \infty} \left[\ln \left| \frac{x-1}{(x+1)^{2a}} \right| \right]_3^b = \lim_{b \rightarrow \infty} \left[\ln \frac{b-1}{(b+1)^{2a}} - \ln \left(\frac{2}{4^{2a}}\right) \right] = \lim_{b \rightarrow \infty} \ln \frac{b-1}{(b+1)^{2a}} - \ln \left(\frac{2}{4^{2a}}\right);$
 $\lim_{b \rightarrow \infty} \frac{b-1}{(b+1)^{2a}} = \lim_{b \rightarrow \infty} \frac{1}{2a(b+1)^{2a-1}} = \begin{cases} 1, & a = \frac{1}{2} \\ \infty, & a < \frac{1}{2} \end{cases} \Rightarrow$ the series converges to $\ln\left(\frac{4}{2}\right) = \ln 2$ if $a = \frac{1}{2}$ and diverges to ∞ if $a < \frac{1}{2}$. If $a > \frac{1}{2}$, the terms of the series eventually become negative and the Integral Test does not apply. From that point on, however, the series behaves like a negative multiple of the harmonic series, and so it diverges.

43. (a)

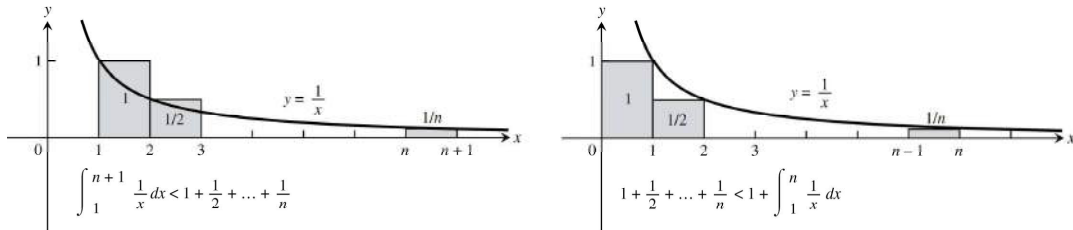

(b) There are $(13)(365)(24)(60)(60) (10^9)$ seconds in 13 billion years; by part (a) $s_n \leq 1 + \ln n$ where $n = (13)(365)(24)(60)(60) (10^9) \Rightarrow s_n \leq 1 + \ln((13)(365)(24)(60)(60) (10^9)) = 1 + \ln(13) + \ln(365) + \ln(24) + 2 \ln(60) + 9 \ln(10) \approx 41.55$

44. No, because $\sum_{n=1}^\infty \frac{1}{nx} = \frac{1}{x} \sum_{n=1}^\infty \frac{1}{n}$ and $\sum_{n=1}^\infty \frac{1}{n}$ diverges

45. Yes. If $\sum_{n=1}^\infty a_n$ is a divergent series of positive numbers, then $\left(\frac{1}{2}\right) \sum_{n=1}^\infty a_n = \sum_{n=1}^\infty \left(\frac{a_n}{2}\right)$ also diverges and $\frac{a_n}{2} < a_n$.

There is no “smallest” divergent series of positive number: for any divergent series $\sum_{n=1}^\infty a_n$ of positive

numbers $\sum_{n=1}^\infty \left(\frac{a_n}{2}\right)$ has smaller terms and still diverges.

46. No, if $\sum_{n=1}^{\infty} a_n$ is a convergent series of positive numbers, then $2\sum_{n=1}^{\infty} a_n = \sum_{n=1}^{\infty} 2a_n$ also converges, and $2a_n \geq a_n$. There is no “largest” convergent series of positive numbers.

47. (a) Both integrals can represent the area under the curve $f(x) = \frac{1}{\sqrt{x+1}}$, and the sum s_{50} can be considered an approximation of either integral using rectangles with $\Delta x = 1$. The sum $s_{50} = \sum_{n=1}^{50} \frac{1}{\sqrt{n+1}}$ is an overestimate

of the integral $\int_1^{51} \frac{1}{\sqrt{x+1}} dx$. The sum s_{50} represents a left-hand sum (that is, the we are choosing the left-hand endpoint of each subinterval for c_i) and because f is a decreasing function, the value of f is a maximum at the left-hand endpoint of each subinterval. The area of each rectangle overestimates the true area, thus $\int_1^{51} \frac{1}{\sqrt{x+1}} dx < \sum_{n=1}^{50} \frac{1}{\sqrt{n+1}}$. In a similar manner, s_{50} underestimates the integral $\int_0^{50} \frac{1}{\sqrt{x+1}} dx$. In

this case, the sum s_{50} represents a right-hand sum and because f is a decreasing function, the value of f is a minimum at the right-hand endpoint of each subinterval. The area of each rectangle underestimates the true area, thus $\sum_{n=1}^{50} \frac{1}{\sqrt{n+1}} < \int_0^{50} \frac{1}{\sqrt{x+1}} dx$. Evaluating the integrals we find $\int_1^{51} \frac{1}{\sqrt{x+1}} dx = [2\sqrt{x+1}]_1^{51}$

$$= 2\sqrt{52} - 2\sqrt{2} \approx 11.6 \text{ and } \int_0^{50} \frac{1}{\sqrt{x+1}} dx = [2\sqrt{x+1}]_0^{50} = 2\sqrt{51} - 2\sqrt{1} \approx 12.3. \text{ Thus, } 11.6 < \sum_{n=1}^{50} \frac{1}{\sqrt{n+1}} < 12.3.$$

(b) $s_n > 1000 \Rightarrow \int_1^{n+1} \frac{1}{\sqrt{x+1}} dx = [2\sqrt{x+1}]_1^{n+1} = 2\sqrt{n+1} - 2\sqrt{2} > 1000 \Rightarrow n > (500 + \sqrt{2})^2 - 1 \approx 251414.2$
 $\Rightarrow n \geq 251415.$

48. (a) Since we are using $s_{30} = \sum_{n=1}^{30} \frac{1}{n^4}$ to estimate $\sum_{n=1}^{\infty} \frac{1}{n^4}$, the error is given by $\sum_{n=31}^{\infty} \frac{1}{n^4}$. We can consider this sum as an estimate of the area under the curve $f(x) = \frac{1}{x^4}$ when $x \geq 30$ using rectangles with $\Delta x = 1$ and c_i is the right-hand endpoint of each subinterval. Since f is a decreasing function, the value of f is a

minimum at the right-hand endpoint of each subinterval, thus $\sum_{n=31}^{\infty} \frac{1}{n^4} < \int_{30}^{\infty} \frac{1}{x^4} dx = \lim_{b \rightarrow \infty} \int_{30}^b \frac{1}{x^4} dx$
 $= \lim_{b \rightarrow \infty} \left[-\frac{1}{3x^3} \right]_{30}^b = \lim_{b \rightarrow \infty} \left(-\frac{1}{3b^3} + \frac{1}{3(30)^3} \right) \approx 1.23 \times 10^{-5}$. Thus the error $< 1.23 \times 10^{-5}$.

(b) We want $S - s_n < 0.000001 \Rightarrow \int_n^{\infty} \frac{1}{x^4} dx < 0.000001 \Rightarrow \int_n^{\infty} \frac{1}{x^4} dx = \lim_{b \rightarrow \infty} \int_n^b \frac{1}{x^4} dx = \lim_{b \rightarrow \infty} \left[-\frac{1}{3x^3} \right]_n^b$
 $= \lim_{b \rightarrow \infty} \left(-\frac{1}{3b^3} + \frac{1}{3n^3} \right) = \frac{1}{3n^3} < 0.000001 \Rightarrow n > \sqrt[3]{\frac{1000000}{3}} \approx 69.336 \Rightarrow n \geq 70.$

49. We want $S - s_n < 0.01 \Rightarrow \int_n^{\infty} \frac{1}{x^3} dx < 0.01 \Rightarrow \int_n^{\infty} \frac{1}{x^3} dx = \lim_{b \rightarrow \infty} \int_n^b \frac{1}{x^3} dx = \lim_{b \rightarrow \infty} \left[-\frac{1}{2x^2} \right]_n^b = \lim_{b \rightarrow \infty} \left(-\frac{1}{2b^2} + \frac{1}{2n^2} \right)$
 $= \frac{1}{2n^2} < 0.01 \Rightarrow n > \sqrt{50} \approx 7.071 \Rightarrow n \geq 8 \Rightarrow S \approx s_8 = \sum_{n=1}^8 \frac{1}{n^3} \approx 1.195$

$$\begin{aligned}
 50. \quad & \text{We want } S - s_n < 0.1 \Rightarrow \int_n^\infty \frac{1}{x^2+4} dx < 0.1 \Rightarrow \lim_{b \rightarrow \infty} \int_n^b \frac{1}{x^2+4} dx = \lim_{b \rightarrow \infty} \left[\frac{1}{2} \tan^{-1} \left(\frac{x}{2} \right) \right]_n^b \\
 & = \lim_{b \rightarrow \infty} \left(\frac{1}{2} \tan^{-1} \left(\frac{b}{2} \right) - \frac{1}{2} \tan^{-1} \left(\frac{n}{2} \right) \right) = \frac{\pi}{4} - \frac{1}{2} \tan^{-1} \left(\frac{n}{2} \right) < 0.1 \Rightarrow n > 2 \tan \left(\frac{\pi}{2} - 0.2 \right) \approx 9.867 \Rightarrow n \geq 10 \\
 & \Rightarrow S \approx s_{10} = \sum_{n=1}^{10} \frac{1}{n^2+4} \approx 0.57
 \end{aligned}$$

$$\begin{aligned}
 51. \quad & S - s_n < 0.00001 \Rightarrow \int_n^\infty \frac{1}{x^{1.1}} dx < 0.00001 \Rightarrow \int_n^\infty \frac{1}{x^{1.1}} dx = \lim_{b \rightarrow \infty} \int_n^b \frac{1}{x^{1.1}} dx = \lim_{b \rightarrow \infty} \left[-\frac{10}{x^{0.1}} \right]_n^b = \lim_{b \rightarrow \infty} \left(-\frac{10}{b^{0.1}} + \frac{10}{n^{0.1}} \right) \\
 & = \frac{10}{n^{0.1}} < 0.00001 \Rightarrow n > 1000000^{10} \Rightarrow n > 10^{60}
 \end{aligned}$$

$$\begin{aligned}
 52. \quad & S - s_n < 0.01 \Rightarrow \int_n^\infty \frac{1}{x(\ln x)^3} dx < 0.01 \Rightarrow \int_n^\infty \frac{1}{x(\ln x)^3} dx = \lim_{b \rightarrow \infty} \int_n^b \frac{1}{x(\ln x)^3} dx = \lim_{b \rightarrow \infty} \left[-\frac{1}{2(\ln x)^2} \right]_n^b \\
 & = \lim_{b \rightarrow \infty} \left(-\frac{1}{2(\ln b)^2} + \frac{1}{2(\ln n)^2} \right) = \frac{1}{2(\ln n)^2} < 0.01 \Rightarrow n > e^{\sqrt{50}} \approx 1177.405 \Rightarrow n \geq 1178
 \end{aligned}$$

53. Let $A_n = \sum_{k=1}^n a_k$ and $B_n = \sum_{k=1}^n 2^k a_{(2^k)}$, where $\{a_k\}$ is a nonincreasing sequence of positive terms converging to 0. Note that $\{A_n\}$ and $\{B_n\}$ are nondecreasing sequences of positive terms. Now,

$$\begin{aligned}
 & B_n = 2a_2 + 4a_4 + 8a_8 + \dots + 2^n a_{(2^n)} \\
 & = 2a_2 + (2a_4 + 2a_4) + (2a_8 + 2a_8 + 2a_8 + 2a_8) + \dots + \underbrace{(2a_{(2^n)} + 2a_{(2^n)} + \dots + 2a_{(2^n)})}_{2^{n-1} \text{ terms}} \\
 & \leq 2a_1 + 2a_2 + (2a_3 + 2a_4) + (2a_5 + 2a_6 + 2a_7 + 2a_8) + \dots + \left(2a_{(2^{n-1})} + 2a_{(2^{n-1}+1)} + \dots + 2a_{(2^n)} \right) = 2A_{(2^n)} \\
 & \leq 2 \sum_{k=1}^\infty a_k. \text{ Therefore if } \sum a_k \text{ converges, then } \{B_n\} \text{ is bounded above } \Rightarrow \sum 2^k a_{(2^k)} \text{ converges. Conversely,}
 \end{aligned}$$

$$A_n = a_1 + (a_2 + a_3) + (a_4 + a_5 + a_6 + a_7) + \dots + a_n < a_1 + 2a_2 + 4a_4 + \dots + 2^n a_{(2^n)} = a_1 + B_n < a_1 + \sum_{k=1}^\infty 2^k a_{(2^k)}.$$

Therefore, if $\sum_{k=1}^\infty 2^k a_{(2^k)}$ converges, then $\{A_n\}$ is bounded above and hence converges.

$$\begin{aligned}
 54. \quad (a) \quad & a_{(2^n)} = \frac{1}{2^n \ln(2^n)} = \frac{1}{2^n \cdot n \ln 2} \Rightarrow \sum_{n=2}^\infty 2^n a_{(2^n)} = \sum_{n=2}^\infty 2^n \frac{1}{2^n \cdot n \ln 2} = \frac{1}{\ln 2} \sum_{n=2}^\infty \frac{1}{n}, \text{ which diverges} \\
 & \Rightarrow \sum_{n=2}^\infty \frac{1}{n \ln n} \text{ diverges.}
 \end{aligned}$$

$$\begin{aligned}
 (b) \quad & a_{(2^n)} = \frac{1}{2^{np}} \Rightarrow \sum_{n=1}^\infty 2^n a_{(2^n)} = \sum_{n=1}^\infty 2^n \cdot \frac{1}{2^{np}} = \sum_{n=1}^\infty \frac{1}{(2^n)^{p-1}} = \sum_{n=1}^\infty \left(\frac{1}{2^{p-1}} \right)^n, \text{ a geometries series that converges if} \\
 & \frac{1}{2^{p-1}} < 1 \text{ or } p > 1, \text{ but diverges if } p \leq 1.
 \end{aligned}$$

$$55. (a) \int_2^{\infty} \frac{dx}{x(\ln x)^p}; \left[u = \ln x, du = \frac{dx}{x} \right] \rightarrow \int_{\ln 2}^{\infty} u^{-p} du = \lim_{b \rightarrow \infty} \left[\frac{u^{-p+1}}{-p+1} \right]_{\ln 2}^b = \lim_{b \rightarrow \infty} \left(\frac{1}{1-p} \right) \left[b^{-p+1} - (\ln 2)^{-p+1} \right]$$

$$= \begin{cases} \frac{1}{p-1} (\ln 2)^{-p+1} & p > 1 \\ \infty, & p < 1 \end{cases} \Rightarrow \text{the improper integral converges if } p > 1 \text{ and diverges if } p < 1. \text{ For } p = 1:$$

$$\int_2^{\infty} \frac{dx}{x \ln x} = \lim_{b \rightarrow \infty} [\ln(\ln x)]_2^b = \lim_{b \rightarrow \infty} [\ln(\ln b) - \ln(\ln 2)] = \infty, \text{ so the improper integral diverges if } p = 1.$$

(b) Since the series and the integral converge or diverge together, $\sum_{n=2}^{\infty} \frac{1}{n(\ln n)^p}$ converges if and only if $p > 1$.

56. (a) $p = 1 \Rightarrow$ the series diverges

(b) $p = 1.01 \Rightarrow$ the series converges

(c) $\sum_{n=2}^{\infty} \frac{1}{n(\ln n^3)} = \frac{1}{3} \sum_{n=2}^{\infty} \frac{1}{n(\ln n)}$; $p = 1 \Rightarrow$ the series diverges

(d) $p = 3 \Rightarrow$ the series converges

57. (a) From Fig. 10.11 (a) in the text with $f(x) = \frac{1}{x}$ and $a_k = \frac{1}{k}$, we have $\int_1^{n+1} \frac{1}{x} dx \leq 1 + \frac{1}{2} + \frac{1}{3} + \dots + \frac{1}{n}$
 $\leq 1 + \int_1^n f(x) dx \Rightarrow \ln(n+1) \leq 1 + \frac{1}{2} + \frac{1}{3} + \dots + \frac{1}{n} \leq 1 + \ln n \Rightarrow 0 \leq \ln(n+1) - \ln n \leq \left(1 + \frac{1}{2} + \frac{1}{3} + \dots + \frac{1}{n}\right) - \ln n \leq 1.$

Therefore the sequence $\left\{ \left(1 + \frac{1}{2} + \frac{1}{3} + \dots + \frac{1}{n}\right) - \ln n \right\}$ is bounded above by 1 and below by 0.

(b) From the graph in Fig. 10.11 (b) with $f(x) = \frac{1}{x}$, $\frac{1}{n+1} < \int_n^{n+1} \frac{1}{x} dx = \ln(n+1) - \ln n$

$$\Rightarrow 0 > \frac{1}{n+1} - [\ln(n+1) - \ln n] = \left(1 + \frac{1}{2} + \frac{1}{3} + \dots + \frac{1}{n+1} - \ln(n+1)\right) - \left(1 + \frac{1}{2} + \frac{1}{3} + \dots + \frac{1}{n} - \ln n\right).$$

If we define $a_n = 1 + \frac{1}{2} + \frac{1}{3} + \dots + \frac{1}{n} - \ln n$, then $0 > a_{n+1} - a_n \Rightarrow a_{n+1} < a_n \Rightarrow \{a_n\}$ is a decreasing sequence of nonnegative terms.

58. $e^{-x^2} \leq e^{-x}$ for $x \geq 1$, and $\int_1^{\infty} e^{-x} dx = \lim_{b \rightarrow \infty} [-e^{-x}]_1^b = \lim_{b \rightarrow \infty} (-e^{-b} + e^{-1}) = e^{-1} \Rightarrow \int_1^{\infty} e^{-x^2} dx$ converges by the

Comparison Test for improper integrals $\Rightarrow \sum_{n=0}^{\infty} e^{-n^2} = 1 + \sum_{n=1}^{\infty} e^{-n^2}$ converges by the Integral Test.

59. (a) $s_{10} = \sum_{n=1}^{\infty} \frac{1}{n^3} = 1.97531986$; $\int_{11}^{\infty} \frac{1}{x^3} dx = \lim_{b \rightarrow \infty} \int_{11}^b x^{-3} dx = \lim_{b \rightarrow \infty} \left[-\frac{x^{-2}}{2} \right]_{11}^b = \lim_{b \rightarrow \infty} \left(-\frac{1}{2b^2} + \frac{1}{242} \right) = \frac{1}{242}$

$$\text{and } \int_{10}^{\infty} \frac{1}{x^3} dx = \lim_{b \rightarrow \infty} \int_{10}^b x^{-3} dx = \lim_{b \rightarrow \infty} \left[-\frac{x^{-2}}{2} \right]_{10}^b = \lim_{b \rightarrow \infty} \left(-\frac{1}{2b^2} + \frac{1}{200} \right) = \frac{1}{200}$$

$$\Rightarrow 1.97531986 + \frac{1}{242} < s < 1.97531986 + \frac{1}{200} \Rightarrow 1.20166 < s < 1.20253$$

(b) $s = \sum_{n=1}^{\infty} \frac{1}{n^3} \approx \frac{1.20166 + 1.20253}{2} = 1.202095$; error $\leq \frac{1.20253 - 1.20166}{2} = 0.000435$

$$60. \text{ (a) } s_{10} = \sum_{n=1}^{10} \frac{1}{n^4} = 1.082036583; \int_{11}^{\infty} \frac{1}{x^4} dx = \lim_{b \rightarrow \infty} \int_{11}^b x^{-4} dx = \lim_{b \rightarrow \infty} \left[-\frac{x^{-3}}{3} \right]_{11}^b = \lim_{b \rightarrow \infty} \left(-\frac{1}{3b^3} + \frac{1}{3993} \right) = \frac{1}{3993}$$

$$\text{and } \int_{10}^{\infty} \frac{1}{x^4} dx = \lim_{b \rightarrow \infty} \int_{10}^b x^{-4} dx = \lim_{b \rightarrow \infty} \left[-\frac{x^{-3}}{3} \right]_{10}^b = \lim_{b \rightarrow \infty} \left(-\frac{1}{3b^3} + \frac{1}{3000} \right) = \frac{1}{3000}$$

$$\Rightarrow 1.082036583 + \frac{1}{3993} < s < 1.082036583 + \frac{1}{3000} \Rightarrow 1.08229 < s < 1.08237$$

$$\text{(b) } s = \sum_{n=1}^{\infty} \frac{1}{n^4} \approx \frac{1.08229 + 1.08237}{2} = 1.08233; \text{ error} \leq \frac{1.08237 - 1.08229}{2} = 0.00004$$

61. The total area will be $\sum_{n=1}^{\infty} \frac{1}{n} \left(\frac{1}{n} - \frac{1}{n+1} \right) = \sum_{n=1}^{\infty} \left(\frac{1}{n^2} - \frac{1}{n(n+1)} \right)$. The p -series $\sum_{n=1}^{\infty} \frac{1}{n^2}$ converges to $\frac{\pi^2}{6}$ and

$\sum_{n=1}^{\infty} \frac{1}{n(n+1)}$ converges to 1 (see Example 5). Thus we can write the area as the difference of these two values,

$$\text{or } \frac{\pi^2}{6} - 1 \approx 0.64493.$$

62. The area of the n th trapezoid is $\frac{1}{2} \left(\frac{1}{n} + \frac{1}{n+1} \right) \left(\frac{1}{n} - \frac{1}{n+1} \right) = \frac{1}{2} \left(\frac{1}{n^2} - \frac{1}{(n+1)^2} \right)$. The total area will be

$$\frac{1}{2} \sum_{n=1}^{\infty} \left(\frac{1}{n^2} - \frac{1}{(n+1)^2} \right) = \frac{1}{2}, \text{ since the series telescopes and has a value of 1.}$$

10.4 COMPARISON TESTS

1. Compare with $\sum_{n=1}^{\infty} \frac{1}{n^2}$, which is a convergent p -series since $p = 2 > 1$. Both series have nonnegative terms for

$n \geq 1$. For $n \geq 1$, we have $n^2 \leq n^2 + 30 \Rightarrow \frac{1}{n^2} \geq \frac{1}{n^2 + 30}$. Then by Comparison Test, $\sum_{n=1}^{\infty} \frac{1}{n^2 + 30}$ converges.

2. Compare with $\sum_{n=1}^{\infty} \frac{1}{n^3}$, which is a convergent p -series since $p = 3 > 1$. Both series have nonnegative terms for

$n \geq 1$. For $n \geq 1$, we have $n^4 \leq n^4 + 2 \Rightarrow \frac{1}{n^4} \geq \frac{1}{n^4 + 2} \Rightarrow \frac{n}{n^4} \geq \frac{n}{n^4 + 2} \Rightarrow \frac{1}{n^3} \geq \frac{n}{n^4 + 2} \geq \frac{n-1}{n^4 + 2}$. Then by Comparison

Test, $\sum_{n=1}^{\infty} \frac{n-1}{n^4 + 2}$ converges.

3. Compare with $\sum_{n=2}^{\infty} \frac{1}{\sqrt{n}}$, which is a divergent p -series since $p = \frac{1}{2} \leq 1$. Both series have nonnegative terms for

$n \geq 2$. For $n \geq 2$, we have $\sqrt{n} - 1 \leq \sqrt{n} \Rightarrow \frac{1}{\sqrt{n-1}} \geq \frac{1}{\sqrt{n}}$. Then by Comparison Test, $\sum_{n=2}^{\infty} \frac{1}{\sqrt{n-1}}$ diverges.

4. Compare with $\sum_{n=2}^{\infty} \frac{1}{n}$, which is a divergent p -series since $p = 1 \leq 1$. Both series have nonnegative terms for $n \geq 2$. For $n \geq 2$, we have $n^2 - n \leq n^2 \Rightarrow \frac{1}{n^2 - n} \geq \frac{1}{n^2} \Rightarrow \frac{n}{n^2 - n} \geq \frac{n}{n^2} = \frac{1}{n} \Rightarrow \frac{n+2}{n^2 - n} \geq \frac{n}{n^2 - n} \geq \frac{1}{n}$. Thus $\sum_{n=2}^{\infty} \frac{n+2}{n^2 - n}$ diverges.
5. Compare with $\sum_{n=1}^{\infty} \frac{1}{n^{3/2}}$, which is a convergent p -series since $p = \frac{3}{2} > 1$. Both series have nonnegative terms for $n \geq 1$. For $n \geq 1$, we have $0 \leq \cos^2 n \leq 1 \Rightarrow \frac{\cos^2 n}{n^{3/2}} \leq \frac{1}{n^{3/2}}$. Then by Comparison Test, $\sum_{n=1}^{\infty} \frac{\cos^2 n}{n^{3/2}}$ converges.
6. Compare with $\sum_{n=1}^{\infty} \frac{1}{3^n}$, which is a convergent geometric series, since $|r| = \left|\frac{1}{3}\right| < 1$. Both series have nonnegative terms for $n \geq 1$. For $n \geq 1$, we have $n \cdot 3^n \geq 3^n \Rightarrow \frac{1}{n \cdot 3^n} \leq \frac{1}{3^n}$. Then by Comparison Test, $\sum_{n=1}^{\infty} \frac{1}{n \cdot 3^n}$ converges.
7. Compare with $\sum_{n=1}^{\infty} \frac{\sqrt{5}}{n^{3/2}}$. The series $\sum_{n=1}^{\infty} \frac{1}{n^{3/2}}$ is a convergent p -series since $p = \frac{3}{2} > 1$, and the series $\sum_{n=1}^{\infty} \frac{\sqrt{5}}{n^{3/2}} = \sqrt{5} \sum_{n=1}^{\infty} \frac{1}{n^{3/2}}$ converges by Theorem 8 part 3. Both series have nonnegative terms for $n \geq 1$. For $n \geq 1$, we have $n^3 \leq n^4 \Rightarrow 4n^3 \leq 4n^4 \Rightarrow n^4 + 4n^3 \leq n^4 + 4n^4 = 5n^4 \Rightarrow n^4 + 4n^3 \leq 5n^4 + 20 = 5(n^4 + 4) \Rightarrow \frac{n^4 + 4n^3}{n^4 + 4} \leq 5 \Rightarrow \frac{n^3(n+4)}{n^4 + 4} \leq 5 \Rightarrow \frac{n+4}{n^4 + 4} \leq \frac{5}{n^3} \Rightarrow \sqrt{\frac{n+4}{n^4 + 4}} \leq \sqrt{\frac{5}{n^3}} = \frac{\sqrt{5}}{n^{3/2}}$. Then by Comparison Test, $\sum_{n=1}^{\infty} \sqrt{\frac{n+4}{n^4 + 4}}$ converges.
8. Compare with $\sum_{n=1}^{\infty} \frac{1}{\sqrt{n}}$, which is a divergent p -series since $p = \frac{1}{2} \leq 1$. Both series have nonnegative terms for $n \geq 1$. For $n \geq 1$, we have $\sqrt{n} \geq 1 \Rightarrow 2\sqrt{n} \geq 2 \Rightarrow 2\sqrt{n} + 1 \geq 3 \Rightarrow n(2\sqrt{n} + 1) \geq 3n \geq 3 \Rightarrow 2n\sqrt{n} + n \geq 3 \Rightarrow n^2 + 2n\sqrt{n} + n \geq n^2 + 3 \Rightarrow \frac{n(n+2\sqrt{n}+1)}{n^2+3} \geq 1 \Rightarrow \frac{n+2\sqrt{n}+1}{n^2+3} \geq \frac{1}{n} \Rightarrow \frac{(\sqrt{n}+1)^2}{n^2+3} \geq \frac{1}{n} \Rightarrow \sqrt{\frac{(\sqrt{n}+1)^2}{n^2+3}} \geq \sqrt{\frac{1}{n}} \Rightarrow \frac{\sqrt{n}+1}{\sqrt{n^2+3}} \geq \frac{1}{\sqrt{n}}$. Then by Comparison Test, $\sum_{n=1}^{\infty} \frac{\sqrt{n}+1}{\sqrt{n^2+3}}$ diverges.
9. Compare with $\sum_{n=1}^{\infty} \frac{1}{n^2}$, which is a convergent p -series since $p = 2 > 1$. Both series have positive terms for $n \geq 1$. $\lim_{n \rightarrow \infty} \frac{a_n}{b_n} = \lim_{n \rightarrow \infty} \frac{\frac{n-2}{n^3-n^2+3}}{\frac{1}{n^2}} = \lim_{n \rightarrow \infty} \frac{n^3-2n^2}{n^3-n^2+3} = \lim_{n \rightarrow \infty} \frac{3n^2-4n}{3n^2-2n} = \lim_{n \rightarrow \infty} \frac{6n-4}{6n-2} = \lim_{n \rightarrow \infty} \frac{6}{6} = 1 > 0$. Then by Limit Comparison Test, $\sum_{n=1}^{\infty} \frac{n-2}{n^3-n^2+3}$ converges.

10. Compare with $\sum_{n=1}^{\infty} \frac{1}{\sqrt{n}}$, which is a divergent p -series since $p = \frac{1}{2} \leq 1$. Both series have positive terms for $n \geq 1$.

$$\lim_{n \rightarrow \infty} \frac{a_n}{b_n} = \lim_{n \rightarrow \infty} \frac{\sqrt{\frac{n+1}{n^2+2}}}{1/\sqrt{n}} = \lim_{n \rightarrow \infty} \sqrt{\frac{n^2+n}{n^2+2}} = \sqrt{\lim_{n \rightarrow \infty} \frac{n^2+n}{n^2+2}} = \sqrt{\lim_{n \rightarrow \infty} \frac{2n+1}{2n}} = \sqrt{\lim_{n \rightarrow \infty} \frac{2}{2}} = \sqrt{1} = 1 > 0. \text{ Then by Limit}$$

Comparison Test, $\sum_{n=1}^{\infty} \sqrt{\frac{n+1}{n^2+2}}$ diverges.

11. Compare with $\sum_{n=2}^{\infty} \frac{1}{n}$, which is a divergent p -series since $p = 1 \leq 1$. Both series have positive terms for $n \geq 2$.

$$\lim_{n \rightarrow \infty} \frac{a_n}{b_n} = \lim_{n \rightarrow \infty} \frac{\frac{n(n+1)}{(n^2+1)^{(n-1)}}}{1/n} = \lim_{n \rightarrow \infty} \frac{n^3+n^2}{n^3-n^2+n-1} = \lim_{n \rightarrow \infty} \frac{3n^2+2n}{3n^2-2n+1} = \lim_{n \rightarrow \infty} \frac{6n+2}{6n-2} = \lim_{n \rightarrow \infty} \frac{6}{6} = 1 > 0. \text{ Then by Limit}$$

Comparison Test, $\sum_{n=2}^{\infty} \frac{n(n+1)}{(n^2+1)^{(n-1)}}$ diverges.

12. Compare with $\sum_{n=1}^{\infty} \frac{1}{2^n}$, which is a convergent geometric series, since $|r| = \left|\frac{1}{2}\right| < 1$. Both series have positive

terms for $n \geq 1$. $\lim_{n \rightarrow \infty} \frac{a_n}{b_n} = \lim_{n \rightarrow \infty} \frac{2^n}{\frac{3+4^n}{1/2^n}} = \lim_{n \rightarrow \infty} \frac{4^n}{3+4^n} = \lim_{n \rightarrow \infty} \frac{4^n \ln 4}{4^n \ln 4} = 1 > 0$. Then by Limit Comparison Test,

$$\sum_{n=1}^{\infty} \frac{2^n}{3+4^n} \text{ converges.}$$

13. Compare with $\sum_{n=1}^{\infty} \frac{1}{\sqrt{n}}$, which is a divergent p -series since $p = \frac{1}{2} \leq 1$. Both series have positive terms for $n \geq 1$.

$$\lim_{n \rightarrow \infty} \frac{a_n}{b_n} = \lim_{n \rightarrow \infty} \frac{\frac{5^n}{\sqrt{n} \cdot 4^n}}{1/\sqrt{n}} = \lim_{n \rightarrow \infty} \frac{5^n}{4^n} = \lim_{n \rightarrow \infty} \left(\frac{5}{4}\right)^n = \infty. \text{ Then by Limit Comparison Test, } \sum_{n=1}^{\infty} \frac{5^n}{\sqrt{n} \cdot 4^n} \text{ diverges.}$$

14. Compare with $\sum_{n=1}^{\infty} \left(\frac{2}{5}\right)^n$, which is a convergent geometric series since $|r| = \left|\frac{2}{5}\right| < 1$. Both series have positive

terms for $n \geq 1$. $\lim_{n \rightarrow \infty} \frac{a_n}{b_n} = \lim_{n \rightarrow \infty} \frac{\left(\frac{2n+3}{5n+4}\right)^n}{\left(\frac{2}{5}\right)^n} = \lim_{n \rightarrow \infty} \left(\frac{10n+15}{10n+8}\right)^n = \exp \lim_{n \rightarrow \infty} \ln \left(\frac{10n+15}{10n+8}\right)^n = \exp \lim_{n \rightarrow \infty} n \ln \left(\frac{10n+15}{10n+8}\right)$

$$= \exp \lim_{x \rightarrow \infty} \frac{\ln \left(\frac{10n+15}{10n+8}\right)}{1/n} = \exp \lim_{n \rightarrow \infty} \frac{\frac{10}{10n+15} - \frac{10}{10n+8}}{-1/n^2} = \exp \lim_{n \rightarrow \infty} \frac{70n^2}{(10n+15)(10n+8)} = \exp \lim_{n \rightarrow \infty} \frac{70n^2}{100n^2 + 230n + 120}$$

$$= \exp \lim_{n \rightarrow \infty} \frac{140n}{200n+230} = \exp \lim_{n \rightarrow \infty} \frac{140}{200} = e^{7/10} > 0. \text{ Then by Limit Comparison Test, } \sum_{n=1}^{\infty} \left(\frac{2n+3}{5n+4}\right)^n \text{ converges.}$$

15. Compare with $\sum_{n=2}^{\infty} \frac{1}{n}$, which is a divergent p -series, since $p = 1 \leq 1$. Both series have positive terms for $n \geq 2$.

$$\lim_{n \rightarrow \infty} \frac{a_n}{b_n} = \lim_{n \rightarrow \infty} \frac{\frac{1}{\ln n}}{1/n} = \lim_{n \rightarrow \infty} \frac{n}{\ln n} = \lim_{n \rightarrow \infty} \frac{1}{1/n} = \lim_{n \rightarrow \infty} n = \infty. \text{ Then by Limit Comparison Test, } \sum_{n=2}^{\infty} \frac{1}{\ln n} \text{ diverges.}$$

16. Compare with $\sum_{n=1}^{\infty} \frac{1}{n^2}$, which is a convergent p -series since $p = 2 > 1$. Both series have positive terms for

$$n \geq 1. \quad \lim_{n \rightarrow \infty} \frac{a_n}{b_n} = \lim_{n \rightarrow \infty} \frac{\ln\left(1 + \frac{1}{n^2}\right)}{1/n^2} = \lim_{n \rightarrow \infty} \frac{\frac{1}{1 + \frac{1}{n^2}} \left(-\frac{2}{n^3}\right)}{\left(-\frac{2}{n^3}\right)} = \lim_{n \rightarrow \infty} \frac{1}{1 + \frac{1}{n^2}} = 1 > 0. \quad \text{Then by Limit Comparison Test,}$$

$$\sum_{n=1}^{\infty} \ln\left(1 + \frac{1}{n^2}\right) \text{ converges.}$$

17. diverges by the Limit Comparison Test (part 1) when compared with $\sum_{n=1}^{\infty} \frac{1}{\sqrt[n]{n}}$, a divergent p -series

$$\lim_{n \rightarrow \infty} \frac{\left(\frac{1}{2\sqrt{n} + \sqrt[3]{n}}\right)}{\left(\frac{1}{\sqrt{n}}\right)} = \lim_{n \rightarrow \infty} \frac{\sqrt{n}}{2\sqrt{n} + \sqrt[3]{n}} = \lim_{n \rightarrow \infty} \left(\frac{1}{2 + n^{-1/6}}\right) = \frac{1}{2}$$

18. diverges by the Direct Comparison Test since $n + n + n > n + \sqrt{n} + 0 \Rightarrow \frac{3}{n + \sqrt{n}} > \frac{1}{n}$, which is the n th term of the divergent series $\sum_{n=1}^{\infty} \frac{1}{n}$ or use Limit Comparison Test with $b_n = \frac{1}{n}$

19. converges by the Direct Comparison Test; $\frac{\sin^2 n}{2^n} \leq \frac{1}{2^n}$, which is the n th term of a convergent geometric series

20. converges by the Direct Comparison Test; $\frac{1 + \cos n}{n^2} \leq \frac{2}{n^2}$ and the p -series $\sum_{n=1}^{\infty} \frac{1}{n^2}$ converges

21. diverges since $\lim_{n \rightarrow \infty} \frac{2n}{3n-1} = \frac{2}{3} \neq 0$

22. converges by the Limit Comparison Test (part 1) with $\frac{1}{n^{3/2}}$, the n th term of a convergent p -series

$$\lim_{n \rightarrow \infty} \frac{\left(\frac{n+1}{n^2 \sqrt{n}}\right)}{\left(\frac{1}{n^{3/2}}\right)} = \lim_{n \rightarrow \infty} \left(\frac{n+1}{n}\right) = 1$$

23. converges by the Limit Comparison Test (part 1) with $\frac{1}{n^2}$, the n th term of a convergent p -series

$$\lim_{n \rightarrow \infty} \frac{\left(\frac{10n+1}{n(n+1)(n+2)}\right)}{\left(\frac{1}{n^2}\right)} = \lim_{n \rightarrow \infty} \frac{10n^2 + n}{n^2 + 3n + 2} = \lim_{n \rightarrow \infty} \frac{20n+1}{2n+3} = \lim_{n \rightarrow \infty} \frac{20}{2} = 10$$

24. converges by the Limit Comparison Test (part 1) with $\frac{1}{n^2}$, the n th term of a convergent p -series

$$\lim_{n \rightarrow \infty} \frac{\left(\frac{5n^3 - 3n}{n^2(n-2)(n^2+5)}\right)}{\left(\frac{1}{n^2}\right)} = \lim_{n \rightarrow \infty} \frac{5n^3 - 3n}{n^3 - 2n^2 + 5n - 10} = \lim_{n \rightarrow \infty} \frac{15n^2 - 3}{3n^2 - 4n + 5} = \lim_{n \rightarrow \infty} \frac{30n}{6n - 4} = 5$$

25. converges by the Direct Comparison Test; $\left(\frac{n}{3n+1}\right)^n < \left(\frac{n}{3n}\right)^n = \left(\frac{1}{3}\right)^n$, the n th term of a convergent geometric series

26. converges by the Limit Comparison Test (part 1) with $\frac{1}{n^{3/2}}$, the n th term of a convergent p -series

$$\lim_{n \rightarrow \infty} \frac{\left(\frac{1}{n^{3/2}}\right)}{\left(\frac{1}{\sqrt{n^3+2}}\right)} = \lim_{n \rightarrow \infty} \frac{\sqrt{n^3+2}}{n^3} = \lim_{n \rightarrow \infty} \sqrt{1 + \frac{2}{n^3}} = 1$$

27. diverges by the Direct Comparison Test; $n > \ln n \Rightarrow \ln n > \ln \ln n \Rightarrow \frac{1}{n} < \frac{1}{\ln n} < \frac{1}{\ln(\ln n)}$ and $\sum_{n=3}^{\infty} \frac{1}{n}$ diverges

28. converges by the Limit Comparison Test (part 2) when compared with $\sum_{n=1}^{\infty} \frac{1}{n^2}$, a convergent p -series

$$\lim_{n \rightarrow \infty} \frac{\left[\frac{(\ln n)^2}{n^3}\right]}{\left(\frac{1}{n^2}\right)} = \lim_{n \rightarrow \infty} \frac{(\ln n)^2}{n} = \lim_{n \rightarrow \infty} \frac{2(\ln n)\left(\frac{1}{n}\right)}{1} = 2 \lim_{n \rightarrow \infty} \frac{\ln n}{n} = 0$$

29. diverges by the Limit Comparison Test (part 3) with $\frac{1}{n}$, the n th term of the divergent harmonic series:

$$\lim_{n \rightarrow \infty} \frac{\left[\frac{1}{\sqrt{n} \ln n}\right]}{\left(\frac{1}{n}\right)} = \lim_{n \rightarrow \infty} \frac{\sqrt{n}}{\ln n} = \lim_{n \rightarrow \infty} \frac{\left(\frac{1}{2\sqrt{n}}\right)}{\left(\frac{1}{n}\right)} = \lim_{n \rightarrow \infty} \frac{\sqrt{n}}{2} = \infty$$

30. converges by the Limit Comparison Test (part 2) with $\frac{1}{n^{5/4}}$, the n th term of a convergent p -series

$$\lim_{n \rightarrow \infty} \frac{\left[\frac{(\ln n)^2}{n^{3/2}}\right]}{\left(\frac{1}{n^{5/4}}\right)} = \lim_{n \rightarrow \infty} \frac{(\ln n)^2}{n^{1/4}} = \lim_{n \rightarrow \infty} \frac{\left(\frac{2 \ln n}{n}\right)}{\left(\frac{1}{4n^{3/4}}\right)} = 8 \lim_{n \rightarrow \infty} \frac{\ln n}{n^{1/4}} = 8 \lim_{n \rightarrow \infty} \frac{\left(\frac{1}{n}\right)}{\left(\frac{1}{4n^{3/4}}\right)} = 32 \lim_{n \rightarrow \infty} \frac{1}{n^{1/4}} = 32 \cdot 0 = 0$$

31. diverges by the Limit Comparison Test (part 3) with $\frac{1}{n}$, the n th term of the divergent harmonic series:

$$\lim_{n \rightarrow \infty} \frac{\left(\frac{1}{1+\ln n}\right)}{\left(\frac{1}{n}\right)} = \lim_{n \rightarrow \infty} \frac{n}{1+\ln n} = \lim_{n \rightarrow \infty} \frac{1}{\left(\frac{1}{n}\right)} = \lim_{n \rightarrow \infty} n = \infty$$

32. diverges by the Integral Test: $\int_2^{\infty} \frac{\ln(x+1)}{x+1} dx = \int_{\ln 3}^{\infty} u du = \lim_{b \rightarrow \infty} \left[\frac{1}{2}u^2\right]_{\ln 3}^b = \lim_{b \rightarrow \infty} \frac{1}{2}(b^2 - \ln^2 3) = \infty$

33. converges by the Direct Comparison Test with $\frac{1}{n^{3/2}}$, the n th term of a convergent p -series $n^2 - 1 > n$ for

$$n \geq 2 \Rightarrow n^2(n^2 - 1) > n^3 \Rightarrow n\sqrt{n^2 - 1} > n^{3/2} \Rightarrow \frac{1}{n^{3/2}} > \frac{1}{n\sqrt{n^2 - 1}}$$
 or use Limit Comparison Test with $\frac{1}{n^2}$.

34. converges by the Direct Comparison Test with $\frac{1}{n^{3/2}}$, the n th term of a convergent p -series

$$n^2 + 1 > n^2 \Rightarrow n^2 + 1 > \sqrt{n} \cdot n^{3/2} \Rightarrow \frac{n^2 + 1}{\sqrt{n}} > n^{3/2} \Rightarrow \frac{\sqrt{n}}{n^2 + 1} < \frac{1}{n^{3/2}}$$
 or use Limit Comparison Test with $\frac{1}{n^{3/2}}$.

35. converges because $\sum_{n=1}^{\infty} \frac{1-n}{n2^n} = \sum_{n=1}^{\infty} \frac{1}{n2^n} + \sum_{n=1}^{\infty} \frac{-1}{2^n}$ which is the sum of two convergent series: $\sum_{n=1}^{\infty} \frac{1}{n2^n}$ converges by the Direct Comparison Test since $\frac{1}{n2^n} < \frac{1}{2^n}$, and $\sum_{n=1}^{\infty} \frac{-1}{2^n}$ is a convergent geometric series

36. converges by the Direct Comparison Test: $\sum_{n=1}^{\infty} \frac{n+2^n}{n^2 2^n} = \sum_{n=1}^{\infty} \left(\frac{1}{n2^n} + \frac{1}{n^2} \right)$ and $\frac{1}{n2^n} + \frac{1}{n^2} \leq \frac{1}{2^n} + \frac{1}{n^2}$, the sum of the n th terms of a convergent geometric series and a convergent p -series

37. converges by the Direct Comparison Test: $\frac{1}{3^{n-1}+1} < \frac{1}{3^{n-1}}$, which is the n th term of a convergent geometric series

38. diverges; $\lim_{n \rightarrow \infty} \left(\frac{3^{n-1}+1}{3^n} \right) = \lim_{n \rightarrow \infty} \left(\frac{1}{3} + \frac{1}{3^n} \right) = \frac{1}{3} \neq 0$

39. converges by Limit Comparison Test: compare with $\sum_{n=1}^{\infty} \left(\frac{1}{5} \right)^n$, which is a convergent geometric series with

$$|r| = \frac{1}{5} < 1, \lim_{n \rightarrow \infty} \frac{\left(\frac{n+1}{n^2+3n} \right) \frac{1}{5^n}}{\left(\frac{1}{5} \right)^n} = \lim_{n \rightarrow \infty} \frac{n+1}{n^2+3n} = \lim_{n \rightarrow \infty} \frac{1}{2n+3} = 0.$$

40. converges by Limit Comparison Test: compare with $\sum_{n=1}^{\infty} \left(\frac{3}{4} \right)^n$, which is a convergent geometric series with

$$|r| = \frac{3}{4} < 1, \lim_{n \rightarrow \infty} \frac{\left(\frac{2^n+3^n}{3^n+4^n} \right) \left(\frac{3}{4} \right)^n}{\left(\frac{3}{4} \right)^n} = \lim_{n \rightarrow \infty} \frac{8^n+12^n}{9^n+12^n} = \lim_{n \rightarrow \infty} \frac{\left(\frac{8}{12} \right)^n+1}{\left(\frac{9}{12} \right)^n+1} = \frac{1}{1} = 1 > 0.$$

41. diverges by Limit Comparison Test: compare with $\sum_{n=1}^{\infty} \frac{1}{n}$, which is a divergent p -series

$$\lim_{n \rightarrow \infty} \frac{\left(\frac{2^n-n}{n \cdot 2^n} \right) \frac{1}{n}}{\frac{1}{n}} = \lim_{n \rightarrow \infty} \frac{2^n-n}{2^n} = \lim_{n \rightarrow \infty} \frac{2^n \ln 2 - 1}{2^n \ln 2} = \lim_{n \rightarrow \infty} \frac{2^n (\ln 2)^2}{2^n (\ln 2)^2} = 1 > 0.$$

42. Since \sqrt{n} grows faster than $\ln n$ and $\sqrt{2} > \ln 2$, $\lim_{n \rightarrow \infty} \frac{\frac{\ln n}{\sqrt{n}} e^n}{e^n} = \lim_{n \rightarrow \infty} \frac{\ln n}{\sqrt{n}} = 0$. Since $e > 1$,

$$\sum_{n=1}^{\infty} \frac{1}{e^n} \text{ is a convergent geometric series, so } \sum_{n=1}^{\infty} \frac{\ln n}{\sqrt{n} e^n} \text{ converges.}$$

43. converges by Comparison Test with $\sum_{n=2}^{\infty} \frac{1}{n(n-1)}$ which converges since $\sum_{n=2}^{\infty} \frac{1}{n(n-1)} = \sum_{n=2}^{\infty} \left[\frac{1}{n-1} - \frac{1}{n} \right]$, and

$$s_k = \left(1 - \frac{1}{2} \right) + \left(\frac{1}{2} - \frac{1}{3} \right) + \dots + \left(\frac{1}{k-2} - \frac{1}{k-1} \right) + \left(\frac{1}{k-1} - \frac{1}{k} \right) = 1 - \frac{1}{k} \Rightarrow \lim_{k \rightarrow \infty} s_k = 1; \text{ for } n \geq 2, (n-2)! \geq 1$$

$$\Rightarrow n(n-1)(n-2)! \geq n(n-1) \Rightarrow n! \geq n(n-1) \Rightarrow \frac{1}{n!} \leq \frac{1}{n(n-1)}$$

44. converges by Limit Comparison Test: compare with $\sum_{n=1}^{\infty} \frac{1}{n^3}$, which is a convergent p -series

$$\lim_{n \rightarrow \infty} \frac{\frac{(n-1)!}{(n+2)!}}{1/n^3} = \lim_{n \rightarrow \infty} \frac{n^3(n-1)!}{(n+2)(n+1)n(n-1)!} = \lim_{n \rightarrow \infty} \frac{n^2}{n^2+3n+2} = \lim_{n \rightarrow \infty} \frac{2n}{2n+3} = \lim_{n \rightarrow \infty} \frac{2}{2} = 1 > 0$$

45. diverges by the Limit Comparison Test (part 1) with $\frac{1}{n}$, the n th term of the divergent harmonic series:

$$\lim_{n \rightarrow \infty} \frac{\left(\frac{\sin \frac{1}{n}}{\frac{1}{n}}\right)}{\left(\frac{1}{n}\right)} = \lim_{x \rightarrow 0} \frac{\sin x}{x} = 1$$

46. diverges by the Limit Comparison Test (part 1) with $\frac{1}{n}$, the n th term of the divergent harmonic series:

$$\lim_{n \rightarrow \infty} \frac{\left(\frac{\tan \frac{1}{n}}{\frac{1}{n}}\right)}{\left(\frac{1}{n}\right)} = \lim_{n \rightarrow \infty} \left(\frac{1}{\cos \frac{1}{n}}\right) \left(\frac{\sin \frac{1}{n}}{\frac{1}{n}}\right) = \lim_{x \rightarrow 0} \left(\frac{1}{\cos x}\right) \left(\frac{\sin x}{x}\right) = 1 \cdot 1 = 1$$

47. converges by the Direct Comparison Test: $\frac{\tan^{-1} n}{n^{1.1}} < \frac{\pi/2}{n^{1.1}}$ and $\sum_{n=1}^{\infty} \frac{\pi/2}{n^{1.1}} = \frac{\pi}{2} \sum_{n=1}^{\infty} \frac{1}{n^{1.1}}$ is the product of a convergent p -series and a nonzero constant

48. converges by the Direct Comparison Test: $\sec^{-1} n < \frac{\pi}{2} \Rightarrow \frac{\sec^{-1} n}{n^{1.3}} < \frac{(\pi/2)}{n^{1.3}}$ and $\sum_{n=1}^{\infty} \frac{(\pi/2)}{n^{1.3}} = \frac{\pi}{2} \sum_{n=1}^{\infty} \frac{1}{n^{1.3}}$ is the product of a convergent p -series and a nonzero constant

49. converges by the Limit Comparison Test (part 1) with $\frac{1}{n^2}$: $\lim_{n \rightarrow \infty} \frac{\left(\frac{\coth n}{n^2}\right)}{\left(\frac{1}{n^2}\right)} = \lim_{n \rightarrow \infty} \coth n = \lim_{n \rightarrow \infty} \frac{e^n + e^{-n}}{e^n - e^{-n}}$
 $= \lim_{n \rightarrow \infty} \frac{1+e^{-2n}}{1-e^{-2n}} = 1$

50. converges by the Limit Comparison Test (part 1) with $\frac{1}{n^2}$: $\lim_{n \rightarrow \infty} \frac{\left(\frac{\tanh n}{n^2}\right)}{\left(\frac{1}{n^2}\right)} = \lim_{n \rightarrow \infty} \tanh n = \lim_{n \rightarrow \infty} \frac{e^n - e^{-n}}{e^n + e^{-n}}$
 $= \lim_{n \rightarrow \infty} \frac{1-e^{-2n}}{1+e^{-2n}} = 1$

51. diverges by the Limit Comparison Test (part 1) with $\frac{1}{n}$: $\lim_{n \rightarrow \infty} \frac{\left(\frac{1}{n\sqrt[n]{n}}\right)}{\left(\frac{1}{n}\right)} = \lim_{n \rightarrow \infty} \frac{1}{\sqrt[n]{n}} = 1$

52. converges by the Limit Comparison Test (part 1) with $\frac{1}{n^2}$: $\lim_{n \rightarrow \infty} \frac{\left(\frac{\sqrt[n]{n}}{n^2}\right)}{\left(\frac{1}{n^2}\right)} = \lim_{n \rightarrow \infty} \sqrt[n]{n} = 1$

53. $\frac{1}{1+2+3+\dots+n} = \frac{1}{\left(\frac{n(n+1)}{2}\right)} = \frac{2}{n(n+1)}$. The series converges by the Limit Comparison Test (part 1) with $\frac{1}{n^2}$:

$$\lim_{n \rightarrow \infty} \frac{\left(\frac{2}{n(n+1)}\right)}{\left(\frac{1}{n^2}\right)} = \lim_{n \rightarrow \infty} \frac{2n^2}{n^2+n} = \lim_{n \rightarrow \infty} \frac{4n}{2n+1} = \lim_{n \rightarrow \infty} \frac{4}{2} = 2.$$

54. $\frac{1}{1+2^2+3^2+\dots+n^2} = \frac{1}{\frac{n(n+1)(2n+1)}{6}} = \frac{6}{n(n+1)(2n+1)} \leq \frac{6}{n^3} \Rightarrow$ the series converges by the Direct Comparison Test

55. (a) If $\lim_{n \rightarrow \infty} \frac{a_n}{b_n} = 0$, then there exists an integer N such that for all $n > N$, $\left|\frac{a_n}{b_n} - 0\right| < 1 \Rightarrow -1 < \frac{a_n}{b_n} < 1 \Rightarrow a_n < b_n$. Thus, if $\sum b_n$ converges, then $\sum a_n$ converges by the Direct Comparison Test.

(b) If $\lim_{n \rightarrow \infty} \frac{a_n}{b_n} = \infty$, then there exists an integer N such that for all $n > N$, $\frac{a_n}{b_n} > 1 \Rightarrow a_n > b_n$. Thus, if $\sum b_n$ diverges, then $\sum a_n$ diverges by the Direct Comparison Test.

56. Yes, $\sum_{n=1}^{\infty} \frac{a_n}{n}$ converges by the Direct Comparison Test because $\frac{a_n}{n} < a_n$

57. $\lim_{n \rightarrow \infty} \frac{a_n}{b_n} = \infty \Rightarrow$ there exists an integer N such that for all $n > N$, $\frac{a_n}{b_n} > 1 \Rightarrow a_n > b_n$. If $\sum a_n$ converges, then $\sum b_n$ converges by the Direct Comparison Test

58. $\sum a_n$ converges $\Rightarrow \lim_{n \rightarrow \infty} a_n = 0 \Rightarrow$ there exists an integer N such that for all $n > N$, $0 \leq a_n < 1 \Rightarrow a_n^2 < a_n \Rightarrow \sum a_n^2$ converges by the Direct Comparison Test

59. Since $a_n > 0$ and $\lim_{n \rightarrow \infty} a_n = \infty \neq 0$, by n^{th} term test for divergence, $\sum a_n$ diverges.

60. Since $a_n > 0$ and $\lim_{n \rightarrow \infty} (n^2 \cdot a_n) = 0$, compare $\sum a_n$ with $\sum \frac{1}{n^2}$, which is a convergent p -series

$$\lim_{n \rightarrow \infty} \frac{a_n}{1/n^2} = \lim_{n \rightarrow \infty} (n^2 \cdot a_n) = 0 \Rightarrow \sum a_n \text{ converges by Limit Comparison Test}$$

61. Let $-\infty < q < \infty$ and $p > 1$. If $q = 0$, then $\sum_{n=2}^{\infty} \frac{(\ln n)^q}{n^p} = \sum_{n=2}^{\infty} \frac{1}{n^p}$, which is a convergent p -series. If $q \neq 0$,

compare with $\sum_{n=2}^{\infty} \frac{1}{n^r}$ where $1 < r < p$, then $\lim_{n \rightarrow \infty} \frac{\frac{(\ln n)^q}{n^p}}{1/n^r} = \lim_{n \rightarrow \infty} \frac{(\ln n)^q}{n^{p-r}}$, and $p-r > 0$. If $q < 0 \Rightarrow -q > 0$ and

$$\lim_{n \rightarrow \infty} \frac{(\ln n)^q}{n^{p-r}} = \lim_{n \rightarrow \infty} \frac{1}{(\ln n)^{-q} n^{p-r}} = 0. \text{ If } q > 0, \lim_{n \rightarrow \infty} \frac{(\ln n)^q}{n^{p-r}} = \lim_{n \rightarrow \infty} \frac{q(\ln n)^{q-1} \left(\frac{1}{n}\right)}{(p-r)n^{p-r-1}} = \lim_{n \rightarrow \infty} \frac{q(\ln n)^{q-1}}{(p-r)n^{p-r}}. \text{ If}$$

$q-1 \leq 0 \Rightarrow 1-q \geq 0$ and $\lim_{n \rightarrow \infty} \frac{q(\ln n)^{q-1}}{(p-r)n^{p-r}} = \lim_{n \rightarrow \infty} \frac{q}{(p-r)n^{p-r}(\ln n)^{1-q}} = 0$, otherwise, we apply L'Hopital's Rule

again. $\lim_{n \rightarrow \infty} \frac{q(q-1)(\ln n)^{q-2} \left(\frac{1}{n}\right)}{(p-r)^2 n^{p-r-1}} = \lim_{n \rightarrow \infty} \frac{q(q-1)(\ln n)^{q-2}}{(p-r)^2 n^{p-r}}$. If $q-2 \leq 0 \Rightarrow 2-q \geq 0$ and

$\lim_{n \rightarrow \infty} \frac{q(q-1)(\ln n)^{q-2}}{(p-r)^2 n^{p-r}} = \lim_{n \rightarrow \infty} \frac{q(q-1)}{(p-r)^2 n^{p-r} (\ln n)^{2-q}} = 0$; otherwise, we apply L'Hopital's Rule again. Since q is finite, there is a positive integer k such that $q - k \leq 0 \Rightarrow k - q \geq 0$. Thus, after k applications of L'Hopital's Rule we obtain $\lim_{n \rightarrow \infty} \frac{q(q-1) \cdots (q-k+1)(\ln n)^{q-k}}{(p-r)^k n^{p-r}} = \lim_{n \rightarrow \infty} \frac{q(q-1) \cdots (q-k+1)}{(p-r)^k n^{p-r} (\ln n)^{k-q}} = 0$. Since the limit is 0 in every case, by Limit Comparison Test, the series $\sum_{n=1}^{\infty} \frac{(\ln n)^q}{n^p}$ converges.

62. Let $-\infty < q < \infty$ and $p \leq 1$. If $q = 0$, then $\sum_{n=2}^{\infty} \frac{(\ln n)^q}{n^p} = \sum_{n=2}^{\infty} \frac{1}{n^p}$, which is a divergent p -series. If $q > 0$, compare with $\sum_{n=2}^{\infty} \frac{1}{n^p}$, which is a divergent p -series. Then $\lim_{n \rightarrow \infty} \frac{\frac{(\ln n)^q}{n^p}}{1/n^p} = \lim_{n \rightarrow \infty} (\ln n)^q = \infty$. If $q < 0 \Rightarrow -q > 0$, compare with $\sum_{n=2}^{\infty} \frac{1}{n^r}$, where $0 < p < r < 1$. $\lim_{n \rightarrow \infty} \frac{\frac{(\ln n)^q}{n^p}}{1/n^r} = \lim_{n \rightarrow \infty} \frac{(\ln n)^q}{n^{p-r}} = \lim_{n \rightarrow \infty} \frac{n^{r-p}}{(\ln n)^{-q}}$ since $r - p > 0$. Apply L'Hopital's to obtain $\lim_{n \rightarrow \infty} \frac{(r-p)n^{r-p-1}}{(-q)(\ln n)^{-q-1}(\frac{1}{n})} = \lim_{n \rightarrow \infty} \frac{(r-p)n^{r-p}}{(-q)(\ln n)^{-q-1}}$. If $-q - 1 \leq 0 \Rightarrow q + 1 \geq 0$ and $\lim_{n \rightarrow \infty} \frac{(r-p)n^{r-p}(\ln n)^{q+1}}{(-q)} = \infty$, otherwise, we apply L'Hopital's Rule again to obtain $\lim_{n \rightarrow \infty} \frac{(r-p)^2 n^{r-p-1}}{(-q)(-q-1)(\ln n)^{-q-2}(\frac{1}{n})} = \lim_{n \rightarrow \infty} \frac{(r-p)^2 n^{r-p}}{(-q)(-q-1)(\ln n)^{-q-2}}$. If $-q - 2 \leq 0 \Rightarrow q + 2 \geq 0$ and $\lim_{n \rightarrow \infty} \frac{(r-p)^2 n^{r-p}}{(-q)(-q-1)(\ln n)^{-q-2}} = \lim_{n \rightarrow \infty} \frac{(r-p)^2 n^{r-p} (\ln n)^{q+2}}{(-q)(-q-1)} = \infty$, otherwise, we apply L'Hopital's Rule again. Since q is finite, there is a positive integer k such that $-q - k \leq 0 \Rightarrow q + k \geq 0$. Thus, after k applications of L'Hopital's Rule we obtain $\lim_{n \rightarrow \infty} \frac{(r-p)^k n^{r-p}}{(-q)(-q-1) \cdots (-q-k+1)(\ln n)^{-q-k}} = \lim_{n \rightarrow \infty} \frac{(r-p)^k n^{r-p} (\ln n)^{q+k}}{(-q)(-q-1) \cdots (-q-k+1)} = \infty$. Since the limit is ∞ if $q > 0$ or if $q < 0$ and $p < 1$, by Limit comparison test, the series $\sum_{n=1}^{\infty} \frac{(\ln n)^q}{n^{p-r}}$ diverges. Finally if $q < 0$ and $p = 1$ then $\sum_{n=2}^{\infty} \frac{(\ln n)^q}{n^p} = \sum_{n=2}^{\infty} \frac{(\ln n)^q}{n}$. Compare with $\sum_{n=2}^{\infty} \frac{1}{n}$, which is a divergent p -series. For $n \geq 3$, $\ln n \geq 1 \Rightarrow (\ln n)^q \geq 1 \Rightarrow \frac{(\ln n)^q}{n} \geq \frac{1}{n}$. Thus $\sum_{n=2}^{\infty} \frac{(\ln n)^q}{n}$ diverges by Comparison Test. Thus, if $-\infty < q < \infty$ and $p \leq 1$, the series $\sum_{n=1}^{\infty} \frac{(\ln n)^q}{n^{p-r}}$ diverges.

63. Since $0 \leq d_n \leq 9$ for all n and the geometric series $\sum_{n=1}^{\infty} \frac{9}{10^n}$ converges to 1, $\sum_{n=1}^{\infty} \frac{d_n}{10^n}$ converges.

64. Since $\sum_{n=1}^{\infty} a_n$ converges, $a_n \rightarrow 0$ as $n \rightarrow \infty$. Thus for all n greater than some N we have $0 < a_n < \frac{\pi}{2}$ and thus $0 < \sin a_n < a_n$. Thus $\sum_{n=1}^{\infty} \sin a_n$ converges by Theorem 10.

65. Converges by Exercise 61 with $q = 3$ and $p = 4$.

66. Diverges by Exercise 62 with $q = \frac{1}{2}$ and $p = \frac{1}{2}$.
67. Converges by Exercise 61 with $q = 1000$ and $p = 1.001$.
68. Diverges by Exercise 62 with $q = \frac{1}{5}$ and $p = 0.99$.
69. Converges by Exercise 61 with $q = -3$ and $p = 1.1$.
70. Diverges by Exercise 62 with $q = -\frac{1}{2}$ and $p = \frac{1}{2}$.

71. Example CAS commands:

Maple:

```
a := n -> 1./n^3/sin(n)^2;
s := k -> sum( a(n), n=1..k ); # (a)
limit( s(k), k=infinity );
pts := [seq( [k,s(k)], k=1..100 )]: # (b)
plot( pts, style=point, title="#71(b) (Section 10.4)");
pts := [seq( [k,s(k)], k=1..200 )]: # (c)
plot( pts, style=point, title="#71(c) (Section 10.4)");
pts := [seq( [k,s(k)], k=1..400 )]: # (d)
plot( pts, style=point, title="#71(d) (Section 10.4)");
evalf( 355/113 );
```

Mathematica:

```
Clear[ a, n, s, k, p ]
a[n_]:= 1 / ( n^3 Sin[n]^2 )
s[k_]= Sum[ a[n], {n, 1, k}];
points[p_]:= Table[ {k, N[s[k]]}, {k, 1, p} ]
points[100]
ListPlot[points[100]]
points[200]
ListPlot[points[200]]
points[400]
ListPlot[points[400], PlotRange -> All]
```

To investigate what is happening around $k = 355$, you could do the following.

```
N[355/113]
N[ $\pi - 355/113$ ]
Sin[355]/N
a[355]/N
N[s[354]]
N[s[355]]
N[s[356]]
```

72. (a) Let $S = \sum_{n=1}^{\infty} \frac{1}{n^2}$, which is a convergent p -series. By Example 5 in Section 10.2, $\sum_{n=1}^{\infty} \frac{1}{n(n+1)}$ converges to 1. By Theorem 8, $S = \sum_{n=1}^{\infty} \frac{1}{n^2} = \sum_{n=1}^{\infty} \frac{1}{n(n+1)} + \sum_{n=1}^{\infty} \frac{1}{n^2} - \sum_{n=1}^{\infty} \frac{1}{n(n+1)} = \sum_{n=1}^{\infty} \frac{1}{n(n+1)} + \sum_{n=1}^{\infty} \left(\frac{1}{n^2} - \frac{1}{n(n+1)} \right)$ also converges.
- (b) Since $\sum_{n=1}^{\infty} \frac{1}{n(n+1)}$ converges to 1 (from Example 5 in Section 10.2), $S = 1 + \sum_{n=1}^{\infty} \left(\frac{1}{n^2} - \frac{1}{n(n+1)} \right) = 1 + \sum_{n=1}^{\infty} \frac{1}{n^2(n+1)}$
- (c) The new series is comparable to $\sum_{n=1}^{\infty} \frac{1}{n^3}$, so it will converge faster because its terms $\rightarrow 0$ faster than the terms of $\sum_{n=1}^{\infty} \frac{1}{n^2}$.
- (d) The series $1 + \sum_{n=1}^{1000} \frac{1}{n^2(n+1)}$ gives a better approximation. Using Mathematica, $1 + \sum_{n=1}^{1000} \frac{1}{n^2(n+1)} = 1.644933568$, while $\sum_{n=1}^{1000000} \frac{1}{n^2} = 1.644933067$. Note that $\frac{\pi^2}{6} = 1.644934067$. The error is 4.99×10^{-7} compared with 1×10^{-6} .

10.5 ABSOLUTE CONVERGENCE; THE RATIO AND ROOT TESTS

- $\lim_{n \rightarrow \infty} \left| \frac{\frac{2^{n+1}}{(n+1)!}}{\frac{2^n}{n!}} \right| = \lim_{n \rightarrow \infty} \left(\frac{2^n \cdot 2}{(n+1) \cdot n!} \cdot \frac{n!}{2^n} \right) = \lim_{n \rightarrow \infty} \left(\frac{2}{n+1} \right) = 0 < 1 \Rightarrow \sum_{n=1}^{\infty} \frac{2^n}{n!}$ converges
- $\lim_{n \rightarrow \infty} \left| \frac{(-1)^{n+1} \frac{(n+1)+2}{3^{n+1}}}{(-1)^n \frac{n+2}{3^n}} \right| = \lim_{n \rightarrow \infty} \left(\frac{n+3}{3^n \cdot 3} \cdot \frac{3^n}{n+2} \right) = \lim_{n \rightarrow \infty} \left(\frac{n+3}{3n+6} \right) = \lim_{n \rightarrow \infty} \left(\frac{1}{3} \right) = \frac{1}{3} < 1 \Rightarrow \sum_{n=1}^{\infty} (-1)^n \frac{n+2}{3^n}$ converges
- $\lim_{n \rightarrow \infty} \left| \frac{\frac{((n+1)-1)!}{((n+1)+1)^2}}{\frac{(n-1)!}{(n+1)^2}} \right| = \lim_{n \rightarrow \infty} \left(\frac{n(n-1)!}{(n+2)^2} \cdot \frac{(n+1)^2}{(n-1)!} \right) = \lim_{n \rightarrow \infty} \left(\frac{n^3+2n^2+n}{n^2+4n+4} \right) = \lim_{n \rightarrow \infty} \left(\frac{3n^2+4n+1}{2n+4} \right) = \lim_{n \rightarrow \infty} \left(\frac{6n+4}{2} \right) = \infty > 1 \Rightarrow \sum_{n=1}^{\infty} \frac{(n-1)!}{(n+1)^2}$ diverges
- $\lim_{n \rightarrow \infty} \left| \frac{\frac{2^{(n+1)+1}}{(n+1)3^{(n+1)-1}}}{\frac{2^{n+1}}{n \cdot 3^{n-1}}} \right| = \lim_{n \rightarrow \infty} \left(\frac{2^{n+1} \cdot 2}{(n+1) \cdot 3^{n-1} \cdot 3} \cdot \frac{n \cdot 3^{n-1}}{2^{n+1}} \right) = \lim_{n \rightarrow \infty} \left(\frac{2n}{3n+3} \right) = \lim_{n \rightarrow \infty} \left(\frac{2}{3} \right) = \frac{2}{3} < 1 \Rightarrow \sum_{n=1}^{\infty} \frac{2^{n+1}}{n \cdot 3^{n-1}}$ converges
- $\lim_{n \rightarrow \infty} \left| \frac{\frac{(n+1)^4}{(-4)^{n+1}}}{\frac{n^4}{(-4)^n}} \right| = \lim_{n \rightarrow \infty} \left(\frac{(n+1)^4}{4^n \cdot 4} \cdot \frac{4^n}{n^4} \right) = \lim_{n \rightarrow \infty} \left(\frac{n^4+4n^3+6n^2+4n+1}{4n^4} \right) = \lim_{n \rightarrow \infty} \left(\frac{1}{4} + \frac{1}{n} + \frac{3}{2n^2} + \frac{1}{n^3} + \frac{1}{4n^4} \right) = \frac{1}{4} < 1 \Rightarrow \sum_{n=1}^{\infty} \frac{n^4}{(-4)^n}$ converges
- $\lim_{n \rightarrow \infty} \left| \frac{\frac{3^{(n+1)+2}}{\ln(n+1)}}{\frac{3^{n+2}}{\ln n}} \right| = \lim_{n \rightarrow \infty} \left(\frac{3^{n+2} \cdot 3}{\ln(n+1)} \cdot \frac{\ln n}{3^{n+2}} \right) = \lim_{n \rightarrow \infty} \left(\frac{3 \ln n}{\ln(n+1)} \right) = \lim_{n \rightarrow \infty} \left(\frac{\frac{3}{n}}{\frac{1}{n+1}} \right) = \lim_{n \rightarrow \infty} \left(\frac{3n+3}{n} \right) = \lim_{n \rightarrow \infty} \left(\frac{3}{1} \right) = 3 > 1 \Rightarrow \sum_{n=2}^{\infty} \frac{3^{n+2}}{\ln n}$ diverges

$$7. \lim_{n \rightarrow \infty} \left| \frac{(-1)^{n+1} \frac{(n+1)^2 (n+1)!}{(n+1)! 3^{2(n+1)}}}{(-1)^n \frac{n^2 (n+2)!}{n! 3^{2n}}} \right| = \lim_{n \rightarrow \infty} \left(\frac{(n+1)^2 (n+3)(n+2)!}{(n+1) \cdot n! 3^{2n} \cdot 3^2} \cdot \frac{n! 3^{2n}}{n^2 (n+2)!} \right) = \lim_{n \rightarrow \infty} \left(\frac{n^3 + 5n^2 + 7n + 3}{9n^3 + 9n^2} \right)$$

$$= \lim_{n \rightarrow \infty} \left(\frac{3n^2 + 15n + 7}{27n^2 + 18n} \right) = \lim_{n \rightarrow \infty} \left(\frac{6n + 15}{54n + 18} \right) = \lim_{n \rightarrow \infty} \left(\frac{6}{54} \right) = \frac{1}{9} < 1 \Rightarrow \sum_{n=1}^{\infty} (-1)^n \frac{n^2 (n+2)!}{n! 3^{2n}} \text{ converges}$$

$$8. \lim_{n \rightarrow \infty} \left| \frac{\frac{(n+1)5^{n+1}}{(2(n+1)+3)\ln(n+1)}}{\frac{n \cdot 5^n}{(2n+3)\ln(n+1)}} \right| = \lim_{n \rightarrow \infty} \left(\frac{(n+1) \cdot 5^n \cdot 5}{(2n+5)\ln(n+2)} \cdot \frac{(2n+3)\ln(n+1)}{n \cdot 5^n} \right) = \lim_{n \rightarrow \infty} \left(\frac{5(n+1)(2n+3)}{n(2n+5)} \cdot \frac{\ln(n+1)}{\ln(n+2)} \right)$$

$$= \lim_{n \rightarrow \infty} \left(\frac{10n^2 + 25n + 15}{2n^2 + 5n} \right) \cdot \lim_{n \rightarrow \infty} \left(\frac{\ln(n+1)}{\ln(n+2)} \right) = \lim_{n \rightarrow \infty} \left(\frac{20n + 25}{4n + 5} \right) \cdot \lim_{n \rightarrow \infty} \left(\frac{\frac{1}{n+1}}{\frac{1}{n+2}} \right) = \lim_{n \rightarrow \infty} \left(\frac{20}{4} \right) \cdot \lim_{n \rightarrow \infty} \left(\frac{n+2}{n+1} \right)$$

$$= 5 \cdot \lim_{n \rightarrow \infty} \left(\frac{1}{1} \right) = 5 \cdot 1 = 5 > 1 \Rightarrow \sum_{n=2}^{\infty} \frac{n \cdot 5^n}{(2n+3)\ln(n+1)} \text{ diverges}$$

$$9. \lim_{n \rightarrow \infty} n \sqrt[n]{\frac{7}{(2n+5)^n}} = \lim_{n \rightarrow \infty} \left(\frac{\sqrt[n]{7}}{2n+5} \right) = 0 < 1 \Rightarrow \sum_{n=1}^{\infty} \frac{7}{(2n+5)^n} \text{ converges}$$

$$10. \lim_{n \rightarrow \infty} n \sqrt[n]{\frac{4^n}{(3n)^n}} = \lim_{n \rightarrow \infty} \left(\frac{4}{3n} \right) = 0 < 1 \Rightarrow \sum_{n=1}^{\infty} \frac{4^n}{(3n)^n} \text{ converges}$$

$$11. \lim_{n \rightarrow \infty} n \sqrt[n]{\left(\frac{4n+3}{3n-5} \right)^n} = \lim_{n \rightarrow \infty} \left(\frac{4n+3}{3n-5} \right) = \lim_{n \rightarrow \infty} \left(\frac{4}{3} \right) = \frac{4}{3} > 1 \Rightarrow \sum_{n=1}^{\infty} \left(\frac{4n+3}{3n-5} \right)^n \text{ diverges}$$

$$12. \lim_{n \rightarrow \infty} n \sqrt[n]{\left[-\ln \left(e^2 + \frac{1}{n} \right) \right]^{n+1}} = \lim_{n \rightarrow \infty} \left[\ln \left(e^2 + \frac{1}{n} \right) \right]^{1+1/n} = \ln(e^2) = 2 > 1 \Rightarrow \sum_{n=1}^{\infty} \left[\ln \left(e^2 + \frac{1}{n} \right) \right]^{n+1} \text{ diverges}$$

$$13. \lim_{n \rightarrow \infty} n \sqrt[n]{\frac{-8}{\left(3 + \frac{1}{n}\right)^{2n}}} = \lim_{n \rightarrow \infty} \left(\frac{\sqrt[n]{-8}}{\left(3 + \frac{1}{n}\right)^2} \right) = \frac{1}{9} < 1 \Rightarrow \sum_{n=1}^{\infty} \frac{8}{\left(3 + \frac{1}{n}\right)^{2n}} \text{ converges}$$

$$14. \lim_{n \rightarrow \infty} n \sqrt[n]{\left[\sin \left(\frac{1}{\sqrt{n}} \right) \right]^n} = \lim_{n \rightarrow \infty} \sin \left(\frac{1}{\sqrt{n}} \right) = \sin(0) = 0 < 1 \Rightarrow \sum_{n=1}^{\infty} \left[\sin \left(\frac{1}{\sqrt{n}} \right) \right]^n \text{ converges}$$

$$15. \lim_{n \rightarrow \infty} n \sqrt[n]{(-1)^n \left(1 - \frac{1}{n}\right)^{n^2}} = \lim_{n \rightarrow \infty} \left(1 - \frac{1}{n}\right)^n = e^{-1} < 1 \Rightarrow \sum_{n=1}^{\infty} \left(1 - \frac{1}{n}\right)^{n^2} \text{ converges}$$

$$16. \lim_{n \rightarrow \infty} n \sqrt[n]{\frac{(-1)^n}{n^{1+n}}} = \lim_{n \rightarrow \infty} \left(\frac{\sqrt[n]{-1}}{n^{1/n+1}} \right) = \lim_{n \rightarrow \infty} \left(\frac{\sqrt[n]{-1}}{n^{1/n+1}} \right) = 0 < 1 \Rightarrow \sum_{n=2}^{\infty} \frac{1}{n^{1+n}} \text{ converges}$$

17. converges by the Ratio Test: $\lim_{n \rightarrow \infty} \left| \frac{a_{n+1}}{a_n} \right| = \lim_{n \rightarrow \infty} \frac{\left[\frac{(n+1)\sqrt{2}}{2^{n+1}} \right]}{\left[\frac{n\sqrt{2}}{2^n} \right]} = \lim_{n \rightarrow \infty} \frac{(n+1)\sqrt{2}}{2^{n+1}} \cdot \frac{2^n}{n\sqrt{2}} = \lim_{n \rightarrow \infty} \left(1 + \frac{1}{n}\right) \sqrt{2} \left(\frac{1}{2}\right) = \frac{1}{2} < 1$

18. converges by the Ratio Test: $\lim_{n \rightarrow \infty} \left| \frac{a_{n+1}}{a_n} \right| = \lim_{n \rightarrow \infty} \frac{\left(\frac{(n+1)^2}{e^{n+1}} \right)}{\left(\frac{n^2}{e^n} \right)} = \lim_{n \rightarrow \infty} \frac{(n+1)^2}{e^{n+1}} \cdot \frac{e^n}{n^2} = \lim_{n \rightarrow \infty} \left(1 + \frac{1}{n}\right)^2 \left(\frac{1}{e}\right) = \frac{1}{e} < 1$

19. diverges by the Ratio Test: $\lim_{n \rightarrow \infty} \left| \frac{a_{n+1}}{a_n} \right| = \lim_{n \rightarrow \infty} \frac{\left(\frac{(n+1)!}{e^{n+1}} \right)}{\left(\frac{n!}{e^n} \right)} = \lim_{n \rightarrow \infty} \frac{(n+1)!}{e^{n+1}} \cdot \frac{e^n}{n!} = \lim_{n \rightarrow \infty} \frac{n+1}{e} = \infty$

20. diverges by the Ratio Test: $\lim_{n \rightarrow \infty} \left| \frac{a_{n+1}}{a_n} \right| = \lim_{n \rightarrow \infty} \frac{\left(\frac{(n+1)!}{10^{n+1}} \right)}{\left(\frac{n!}{10^n} \right)} = \lim_{n \rightarrow \infty} \frac{(n+1)!}{10^{n+1}} \cdot \frac{10^n}{n!} = \lim_{n \rightarrow \infty} \frac{n}{10} = \infty$

21. converges by the Ratio Test: $\lim_{n \rightarrow \infty} \left| \frac{a_{n+1}}{a_n} \right| = \lim_{n \rightarrow \infty} \frac{\left(\frac{(n+1)^{10}}{10^{n+1}} \right)}{\left(\frac{n^{10}}{10^n} \right)} = \lim_{n \rightarrow \infty} \frac{(n+1)^{10}}{10^{n+1}} \cdot \frac{10^n}{n^{10}} = \lim_{n \rightarrow \infty} \left(1 + \frac{1}{n}\right)^{10} \left(\frac{1}{10}\right) = \frac{1}{10} < 1$

22. diverges; $\lim_{n \rightarrow \infty} a_n = \lim_{n \rightarrow \infty} \left(\frac{n-2}{n}\right)^n = \lim_{n \rightarrow \infty} \left(1 + \frac{-2}{n}\right)^n = e^{-2} \neq 0$

23. converges by the Direct Comparison Test: $\frac{2+(-1)^n}{(1.25)^n} = \left(\frac{4}{5}\right)^n [2+(-1)^n] \leq \left(\frac{4}{5}\right)^n (3)$ which is the n^{th} term of a convergent geometric series

24. converges; a geometric series with $|r| = \left| -\frac{2}{3} \right| < 1$

25. diverges; $\lim_{n \rightarrow \infty} a_n = \lim_{n \rightarrow \infty} (-1)^n \left(1 - \frac{3}{n}\right)^n = \lim_{n \rightarrow \infty} (-1)^n \left(1 + \frac{-3}{n}\right)^n$; $(-1)^n \left(1 + \frac{-3}{n}\right)^n \Rightarrow e^{-3}$ for n even and $-e^{-3}$ for n odd, so the limit does not exist

26. diverges; $\lim_{n \rightarrow \infty} a_n = \lim_{n \rightarrow \infty} \left(1 - \frac{1}{3n}\right)^n = \lim_{n \rightarrow \infty} \left(1 + \frac{\left(-\frac{1}{3}\right)}{n}\right)^n = e^{-1/3} \approx 0.72 \neq 0$

27. converges by the Direct Comparison Test: $\frac{\ln n}{n^3} < \frac{n}{n^3} = \frac{1}{n^2}$ for $n \geq 2$, the n^{th} term of a convergent p -series

28. converges by the n^{th} -Root Test: $\lim_{n \rightarrow \infty} \sqrt[n]{|a_n|} = \lim_{n \rightarrow \infty} \sqrt[n]{\frac{(\ln n)^n}{n^n}} = \lim_{n \rightarrow \infty} \frac{((\ln n)^n)^{1/n}}{(n^n)^{1/n}} = \lim_{n \rightarrow \infty} \frac{\ln n}{n} = \lim_{n \rightarrow \infty} \left(\frac{1}{n}\right) = 0 < 1$

29. diverges by the Direct Comparison Test: $\frac{1}{n} - \frac{1}{n^2} = \frac{n-1}{n^2} > \frac{1}{2} \left(\frac{1}{n}\right)$ for $n > 2$ or by the Limit Comparison Test (part 1) with $\frac{1}{n}$.
30. converges by the n th-Root Test: $\lim_{n \rightarrow \infty} \sqrt[n]{|a_n|} = \lim_{n \rightarrow \infty} \sqrt[n]{\left(\frac{1}{n} - \frac{1}{n^2}\right)^n} = \lim_{n \rightarrow \infty} \left(\frac{1}{n} - \frac{1}{n^2}\right) = \lim_{n \rightarrow \infty} \left(\frac{1}{n} - \frac{1}{n^2}\right) = 0 < 1$
31. diverges by the n th-Term Test: Any exponential with base > 1 grows faster than any fixed power, so $\lim_{n \rightarrow \infty} a_n \neq 0$.
32. converges by the Ratio Test: $\lim_{n \rightarrow \infty} \left| \frac{a_{n+1}}{a_n} \right| = \lim_{n \rightarrow \infty} \frac{(n+1)\ln(n+1)}{2^{n+1}} \cdot \frac{2^n}{n \ln(n)} = \frac{1}{2} < 1$
33. converges by the Ratio Test: $\lim_{n \rightarrow \infty} \left| \frac{a_{n+1}}{a_n} \right| = \lim_{n \rightarrow \infty} \frac{(n+2)(n+3)}{(n+1)!} \cdot \frac{n!}{(n+1)(n+2)} = 0 < 1$
34. converges by the Ratio Test: $\lim_{n \rightarrow \infty} \left| \frac{a_{n+1}}{a_n} \right| = \lim_{n \rightarrow \infty} \frac{(n+1)^3}{e^{n+1}} \cdot \frac{e^n}{n^3} = \frac{1}{e} < 1$
35. converges by the Ratio Test: $\lim_{n \rightarrow \infty} \left| \frac{a_{n+1}}{a_n} \right| = \lim_{n \rightarrow \infty} \frac{(n+4)!}{3!(n+1)!3^{n+1}} \cdot \frac{3!n!3^n}{(n+3)!} = \lim_{n \rightarrow \infty} \frac{n+4}{3(n+1)} = \frac{1}{3} < 1$
36. converges by the Ratio Test: $\lim_{n \rightarrow \infty} \left| \frac{a_{n+1}}{a_n} \right| = \lim_{n \rightarrow \infty} \frac{(n+1)2^{n+1}(n+2)!}{3^{n+1}(n+1)!} \cdot \frac{3^n n!}{n2^n(n+1)!} = \lim_{n \rightarrow \infty} \left(\frac{n+1}{n}\right) \left(\frac{2}{3}\right) \left(\frac{n+2}{n+1}\right) = \frac{2}{3} < 1$
37. converges by the Ratio Test: $\lim_{n \rightarrow \infty} \left| \frac{a_{n+1}}{a_n} \right| = \lim_{n \rightarrow \infty} \frac{(n+1)!}{(2n+3)!} \cdot \frac{(2n+1)!}{n!} = \lim_{n \rightarrow \infty} \frac{n+1}{(2n+3)(2n+2)} = 0 < 1$
38. converges by the Ratio Test: $\lim_{n \rightarrow \infty} \left| \frac{a_{n+1}}{a_n} \right| = \lim_{n \rightarrow \infty} \frac{(n+1)!}{(n+1)^{n+1}} \cdot \frac{n^n}{n!} = \lim_{n \rightarrow \infty} \left(\frac{n}{n+1}\right)^n = \lim_{n \rightarrow \infty} \frac{1}{\left(\frac{n+1}{n}\right)^n} = \lim_{n \rightarrow \infty} \frac{1}{\left(1 + \frac{1}{n}\right)^n} = \frac{1}{e} < 1$
39. converges by the Root Test: $\lim_{n \rightarrow \infty} \sqrt[n]{|a_n|} = \lim_{n \rightarrow \infty} \sqrt[n]{\frac{n}{(\ln n)^n}} = \lim_{n \rightarrow \infty} \frac{\sqrt[n]{n}}{\ln n} = \frac{\lim_{n \rightarrow \infty} \sqrt[n]{n}}{\lim_{n \rightarrow \infty} \ln n} = 0 < 1$
40. converges by the Root Test: $\lim_{n \rightarrow \infty} \sqrt[n]{|a_n|} = \lim_{n \rightarrow \infty} \sqrt[n]{\frac{n}{(\ln n)^{n/2}}} = \lim_{n \rightarrow \infty} \frac{\sqrt[n]{n}}{\sqrt{\ln n}} = \frac{\lim_{n \rightarrow \infty} \sqrt[n]{n}}{\lim_{n \rightarrow \infty} \sqrt{\ln n}} = 0 < 1 \left(\lim_{n \rightarrow \infty} \sqrt[n]{n} = 1 \right)$
41. converges by the Direct Comparison Test: $\frac{n! \ln n}{n(n+2)!} = \frac{\ln n}{n(n+1)(n+2)} < \frac{n}{n(n+1)(n+2)} = \frac{1}{(n+1)(n+2)} < \frac{1}{n^2}$ which is the n th-term of a convergent p -series
42. diverges by the Ratio Test: $\lim_{n \rightarrow \infty} \left| \frac{a_{n+1}}{a_n} \right| = \lim_{n \rightarrow \infty} \frac{3^{n+1}}{(n+1)^3 2^{n+1}} \cdot \frac{n^3 2^n}{3^n} = \lim_{n \rightarrow \infty} \frac{n^3}{(n+1)^3} \left(\frac{3}{2}\right) = \frac{3}{2} > 1$

43. converges by the Ratio Test: $\lim_{n \rightarrow \infty} \left| \frac{a_{n+1}}{a_n} \right| = \lim_{n \rightarrow \infty} \frac{[(n+1)!]^2 \cdot (2n)!}{[2(n+1)!]^2 \cdot [n!]^2} = \lim_{n \rightarrow \infty} \frac{(n+1)^2}{(2n+2)(2n+1)} = \lim_{n \rightarrow \infty} \frac{n^2+2n+1}{4n^2+6n+2} = \frac{1}{4} < 1$

44. converges by the Ratio Test: $\lim_{n \rightarrow \infty} \left| \frac{a_{n+1}}{a_n} \right| = \lim_{n \rightarrow \infty} \frac{(2n+5)(2^{n+1}+3)}{3^{n+1}+2} \cdot \frac{3^n+2}{(2n+3)(2^n+3)} = \lim_{n \rightarrow \infty} \left[\frac{2n+5}{2n+3} \cdot \frac{2 \cdot 6^n + 4 \cdot 2^n + 3 \cdot 3^n + 6}{3 \cdot 6^n + 9 \cdot 3^n + 2 \cdot 2^n + 6} \right]$
 $= \lim_{n \rightarrow \infty} \left[\frac{2n+5}{2n+3} \right] \cdot \lim_{n \rightarrow \infty} \left[\frac{2 \cdot 6^n + 4 \cdot 2^n + 3 \cdot 3^n + 6}{3 \cdot 6^n + 9 \cdot 3^n + 2 \cdot 2^n + 6} \right] = 1 \cdot \frac{2}{3} = \frac{2}{3} < 1$

45. converges by the Ratio Test: $\lim_{n \rightarrow \infty} \left| \frac{a_{n+1}}{a_n} \right| = \lim_{n \rightarrow \infty} \frac{\left(\frac{1+\sin n}{n}\right)a_n}{a_n} = 0 < 1$

46. converges by the Ratio Test: $\lim_{n \rightarrow \infty} \left| \frac{a_{n+1}}{a_n} \right| = \lim_{n \rightarrow \infty} \frac{\left(\frac{1+\tan^{-1} n}{n}\right)a_n}{a_n} = \lim_{n \rightarrow \infty} \frac{1+\tan^{-1} n}{n} = 0$ since the numerator approaches $1 + \frac{\pi}{2}$ while the denominator tends to ∞

47. diverges by the Ratio Test: $\lim_{n \rightarrow \infty} \left| \frac{a_{n+1}}{a_n} \right| = \lim_{n \rightarrow \infty} \frac{\left(\frac{3n-1}{2n+5}\right)a_n}{a_n} = \lim_{n \rightarrow \infty} \frac{3n-1}{2n+5} = \frac{3}{2} > 1$

48. diverges; $a_{n+1} = \frac{n}{n+1}a_n \Rightarrow a_{n+1} = \left(\frac{n}{n+1}\right)\left(\frac{n-1}{n}\right)a_{n-1} \Rightarrow a_{n+1} = \left(\frac{n}{n+1}\right)\left(\frac{n-1}{n}\right)\left(\frac{n-2}{n-1}\right)a_{n-2}$
 $\Rightarrow a_{n+1} = \left(\frac{n}{n+1}\right)\left(\frac{n-1}{n}\right)\left(\frac{n-2}{n-1}\right) \cdots \left(\frac{1}{2}\right)a_1 \Rightarrow a_{n+1} = \frac{a_1}{n+1} \Rightarrow a_{n+1} = \frac{3}{n+1}$, which is a constant times the general term of the diverging harmonic series

49. converges by the Ratio Test: $\lim_{n \rightarrow \infty} \left| \frac{a_{n+1}}{a_n} \right| = \lim_{n \rightarrow \infty} \frac{\left(\frac{2}{n}\right)a_n}{a_n} = \lim_{n \rightarrow \infty} \frac{2}{n} = 0 < 1$

50. converges by the Ratio Test: $\lim_{n \rightarrow \infty} \left| \frac{a_{n+1}}{a_n} \right| = \lim_{n \rightarrow \infty} \frac{\left(\frac{\sqrt[n]{n}}{2}\right)a_n}{a_n} = \lim_{n \rightarrow \infty} \frac{\sqrt[n]{n}}{2} = \frac{1}{2} < 1 - \infty$

51. converges by the Ratio Test: $\lim_{n \rightarrow \infty} \left| \frac{a_{n+1}}{a_n} \right| = \lim_{n \rightarrow \infty} \frac{\left(\frac{1+\ln n}{n}\right)a_n}{a_n} = \lim_{n \rightarrow \infty} \frac{1+\ln n}{n} = \lim_{n \rightarrow \infty} \frac{1}{n} = 0 < 1$

52. $\frac{n+\ln n}{n+10} > 0$ and $a_1 = \frac{1}{2} \Rightarrow a_n > 0$; $\ln n > 10$ for $n > e^{10} \Rightarrow n + \ln n > n + 10 \Rightarrow \frac{n+\ln n}{n+10} > 1$
 $\Rightarrow a_{n+1} = \frac{n+\ln n}{n+10}a_n > a_n$; thus $a_{n+1} > a_n \geq \frac{1}{2} \Rightarrow \lim_{n \rightarrow \infty} a_n \neq 0$, so the series diverges by the n th-Term Test

53. diverges by the n th-Term Test: $a_1 = \frac{1}{3}$, $a_2 = \sqrt[2]{\frac{1}{3}}$, $a_3 = \sqrt[3]{2\sqrt[2]{\frac{1}{3}}} = \sqrt[6]{\frac{1}{3}}$, $a_4 = \sqrt[4]{3\sqrt[3]{2\sqrt[2]{\frac{1}{3}}}} = \sqrt[12]{\frac{1}{3}}$, \dots , $a_n = \sqrt[n]{\frac{1}{3}}$
 $\Rightarrow \lim_{n \rightarrow \infty} a_n = 1$ because $\left\{\sqrt[n]{\frac{1}{3}}\right\}$ is a subsequence of $\left\{\sqrt[n]{\frac{1}{3}}\right\}$ whose limit is 1 by Table 8.1

54. converges by the Direct Comparison Test: $a_1 = \frac{1}{2}$, $a_2 = \left(\frac{1}{2}\right)^2$, $a_3 = \left(\left(\frac{1}{2}\right)^2\right)^3 = \left(\frac{1}{2}\right)^6$, $a_4 = \left(\left(\frac{1}{2}\right)^6\right)^4 = \left(\frac{1}{2}\right)^{24}$, ...
 $\Rightarrow a_n = \left(\frac{1}{2}\right)^{n!} < \left(\frac{1}{2}\right)^n$ which is the n th-term of a convergent geometric series

55. converges by the Ratio Test: $\lim_{n \rightarrow \infty} \left| \frac{a_{n+1}}{a_n} \right| = \lim_{n \rightarrow \infty} \frac{2^{n+1}(n+1)(n+1)!}{(2n+2)!} \cdot \frac{(2n)!}{2^n n! n!} = \lim_{n \rightarrow \infty} \frac{2(n+1)(n+1)}{(2n+2)(2n+1)} = \lim_{n \rightarrow \infty} \frac{n+1}{2n+1} = \frac{1}{2} < 1$

56. diverges by the Ratio Test: $\lim_{n \rightarrow \infty} \left| \frac{a_{n+1}}{a_n} \right| = \lim_{n \rightarrow \infty} \frac{(3n+3)!}{(n+1)!(n+2)!(n+3)!} \cdot \frac{n!(n+1)!(n+2)!}{(3n)!} = \lim_{n \rightarrow \infty} \frac{(3n+3)(3+2)(3n+1)}{(n+1)(n+2)(n+3)}$
 $= \lim_{n \rightarrow \infty} 3 \left(\frac{3n+2}{n+2} \right) \left(\frac{3n+1}{n+3} \right) = 3 \cdot 3 \cdot 3 = 27 > 1$

57. diverges by the Root Test: $\lim_{n \rightarrow \infty} \sqrt[n]{|a_n|} = \lim_{n \rightarrow \infty} \sqrt[n]{\frac{(n!)^n}{(n^n)^2}} = \lim_{n \rightarrow \infty} \frac{n!}{n^2} = \infty > 1$

58. converges by the Root Test: $\lim_{n \rightarrow \infty} \sqrt[n]{\left| \frac{(-1)^n (n!)^n}{n^{2n}} \right|} = \lim_{n \rightarrow \infty} \sqrt[n]{\frac{(n!)^n}{(n^n)^2}} = \lim_{n \rightarrow \infty} \frac{n!}{n^2} = \lim_{n \rightarrow \infty} \left(\frac{1}{n} \right) \left(\frac{2}{n} \right) \left(\frac{3}{n} \right) \cdots \left(\frac{n-1}{n} \right) \left(\frac{n}{n} \right) \leq \lim_{n \rightarrow \infty} \frac{1}{n}$
 $= 0 < 1$

59. converges by the Root Test: $\lim_{n \rightarrow \infty} \sqrt[n]{|a_n|} = \lim_{n \rightarrow \infty} \sqrt[n]{\frac{n^n}{2^{n^2}}} = \lim_{n \rightarrow \infty} \frac{n}{2^n} = \lim_{n \rightarrow \infty} \frac{1}{2^{n \ln 2}} = 0 < 1$

60. diverges by the Root Test: $\lim_{n \rightarrow \infty} \sqrt[n]{|a_n|} = \lim_{n \rightarrow \infty} \sqrt[n]{\frac{n^n}{(2^n)^2}} = \lim_{n \rightarrow \infty} \frac{n}{4} = \infty > 1$

61. converges by the Ratio Test: $\lim_{n \rightarrow \infty} \left| \frac{a_{n+1}}{a_n} \right| = \lim_{n \rightarrow \infty} \frac{1 \cdot 3 \cdots (2n-1)(2n+1)}{4^{n+1} 2^{n+1} (n+1)!} \cdot \frac{4^n 2^n n!}{1 \cdot 3 \cdots (2n-1)} = \lim_{n \rightarrow \infty} \frac{2n+1}{(4 \cdot 2)(n+1)} = \frac{1}{4} < 1$

62. converges by the Ratio Test: $a_n = \frac{1 \cdot 3 \cdots (2n-1)}{(2 \cdot 4 \cdots 2n)(3^{n+1})} = \frac{1 \cdot 2 \cdot 3 \cdot 4 \cdots (2n-1)(2n)}{(2 \cdot 4 \cdots 2n)^2 (3^{n+1})} = \frac{(2n)!}{(2^n n!)^2 (3^{n+1})}$
 $\Rightarrow \lim_{n \rightarrow \infty} \frac{(2n+2)!}{[2^{n+1}(n+1)!]^2 (3^{n+1}+1)} \cdot \frac{(2^n n!)^2 (3^n+1)}{(2n)!} = \lim_{n \rightarrow \infty} \frac{(2n+1)(2n+2)(3^n+1)}{2^2(n+1)^2 (3^n+1)} = \lim_{n \rightarrow \infty} \left(\frac{4n^2+6n+2}{4n^2+8n+4} \right) \left(\frac{1+3^{-n}}{3+3^{-n}} \right) = 1 \cdot \frac{1}{3} = \frac{1}{3} < 1$

63. Ratio: $\lim_{n \rightarrow \infty} \left| \frac{a_{n+1}}{a_n} \right| = \lim_{n \rightarrow \infty} \frac{1}{(n+1)^p} \cdot \frac{n^p}{1} = \lim_{n \rightarrow \infty} \left(\frac{n}{n+1} \right)^p = 1^p = 1 \Rightarrow$ no conclusion

Root: $\lim_{n \rightarrow \infty} \sqrt[n]{|a_n|} = \lim_{n \rightarrow \infty} \sqrt[n]{\frac{1}{n^p}} = \lim_{n \rightarrow \infty} \frac{1}{(\sqrt[n]{n})^p} = \frac{1}{(1)^p} = 1 \Rightarrow$ no conclusion

64. Ratio: $\lim_{n \rightarrow \infty} \left| \frac{a_{n+1}}{a_n} \right| = \lim_{n \rightarrow \infty} \frac{1}{(\ln(n+1))^p} \cdot \frac{(\ln n)^p}{1} = \left[\lim_{n \rightarrow \infty} \frac{\ln n}{\ln(n+1)} \right]^p = \left[\lim_{n \rightarrow \infty} \left(\frac{\frac{1}{n}}{\frac{1}{n+1}} \right) \right]^p = \left(\lim_{n \rightarrow \infty} \frac{n+1}{n} \right)^p = (1)^p = 1 \Rightarrow$ no conclusion

Root: $\lim_{n \rightarrow \infty} \sqrt[n]{|a_n|} = \lim_{n \rightarrow \infty} \sqrt[n]{\frac{1}{(\ln n)^p}} = \frac{1}{\left(\lim_{n \rightarrow \infty} (\ln n)^{1/n}\right)^p}$; let $f(n) = (\ln n)^{1/n}$, then $\ln f(n) = \frac{\ln(\ln n)}{n}$

$\Rightarrow \lim_{n \rightarrow \infty} \ln f(n) = \lim_{n \rightarrow \infty} \frac{\ln(\ln n)}{n} = \lim_{n \rightarrow \infty} \frac{\left(\frac{1}{n \ln n}\right)}{1} = \lim_{n \rightarrow \infty} \frac{1}{n \ln n} = 0 \Rightarrow \lim_{n \rightarrow \infty} (\ln n)^{1/n} = \lim_{n \rightarrow \infty} e^{\ln f(n)} = e^0 = 1$;

therefore $\lim_{n \rightarrow \infty} \sqrt[n]{|a_n|} = \frac{1}{\left(\lim_{n \rightarrow \infty} (\ln n)^{1/n}\right)^p} = \frac{1}{(1)^p} = 1 \Rightarrow$ no conclusion

65. $a_n \leq \frac{n}{2^n}$ for every n and the series $\sum_{n=1}^{\infty} \frac{n}{2^n}$ converges by the Ratio Test since $\lim_{n \rightarrow \infty} \frac{(n+1)}{2^{n+1}} \cdot \frac{2^n}{n} = \frac{1}{2} < 1$

$\Rightarrow \sum_{n=1}^{\infty} a_n$ converges by the Direct Comparison Test

66. $\frac{2^{n^2}}{n!} > 0$ for all $n \geq 1$; $\lim_{n \rightarrow \infty} \left(\frac{\frac{2^{(n+1)^2}}{(n+1)!}}{\frac{2^{n^2}}{n!}} \right) = \lim_{n \rightarrow \infty} \left(\frac{2^{2n+2n+1}}{(n+1) \cdot n!} \cdot \frac{n!}{2^{n^2}} \right) = \lim_{n \rightarrow \infty} \left(\frac{2^{2n+1}}{n+1} \right) = \lim_{n \rightarrow \infty} \left(\frac{2 \cdot 4^n}{n+1} \right) = \lim_{n \rightarrow \infty} \left(\frac{2 \cdot 4^n \ln 4}{1} \right)$

$= \infty > 1 \Rightarrow \sum_{n=1}^{\infty} \frac{2^{n^2}}{n!}$ diverges

10.6 ALTERNATING SERIES AND CONDITIONAL CONVERGENCE

- converges by the Alternating Convergence Test since: $u_n = \frac{1}{\sqrt{n}} > 0$ for all $n \geq 1$;
 $n \geq 1 \Rightarrow n+1 \geq n \Rightarrow \sqrt{n+1} \geq \sqrt{n} \Rightarrow \frac{1}{\sqrt{n+1}} \leq \frac{1}{\sqrt{n}} \Rightarrow u_{n+1} \leq u_n$; $\lim_{n \rightarrow \infty} u_n = \lim_{n \rightarrow \infty} \frac{1}{\sqrt{n}} = 0$.
- converges absolutely \Rightarrow converges by the Alternating Convergence Test since $\sum_{n=1}^{\infty} |a_n| = \sum_{n=1}^{\infty} \frac{1}{n^{3/2}}$ which is a convergent p -series.
- converges \Rightarrow converges by Alternating Series Test since: $u_n = \frac{1}{n3^n} > 0$ for all $n \geq 1$;
 $n \geq 1 \Rightarrow n+1 \geq n \Rightarrow 3^{n+1} \geq 3^n \Rightarrow (n+1)3^{n+1} \geq n3^n \Rightarrow \frac{1}{(n+1)3^{n+1}} \leq \frac{1}{n3^n} \Rightarrow u_{n+1} \leq u_n$; $\lim_{n \rightarrow \infty} u_n = \lim_{n \rightarrow \infty} \frac{1}{n3^n} = 0$.
- converges \Rightarrow converges by Alternating Series Test since: $u_n = \frac{4}{(\ln n)^2} > 0$ for all $n \geq 2$;
 $n \geq 2 \Rightarrow n+1 \geq n \Rightarrow \ln(n+1) \geq \ln n \Rightarrow (\ln(n+1))^2 \geq (\ln n)^2 \Rightarrow \frac{1}{(\ln(n+1))^2} \leq \frac{1}{(\ln n)^2} \Rightarrow \frac{4}{(\ln(n+1))^2} \leq \frac{4}{(\ln n)^2} \Rightarrow u_{n+1} \leq u_n$;
 $\lim_{n \rightarrow \infty} u_n = \lim_{n \rightarrow \infty} \frac{4}{(\ln n)^2} = 0$.
- converges \Rightarrow converges by Alternating Series Test since: $u_n = \frac{n}{n^2+1} > 0$ for all $n \geq 1$;
 $n \geq 1 \Rightarrow 2n^2 + 2n \geq n^2 + n + 1 \Rightarrow n^3 + 2n^2 + 2n \geq n^3 + n^2 + n + 1 \Rightarrow n(n^2 + 2n + 2) \geq n^3 + n^2 + n + 1$
 $\Rightarrow n((n+1)^2 + 1) \geq (n^2 + 1)(n+1) \Rightarrow \frac{n}{n^2+1} \geq \frac{n+1}{(n+1)^2+1} \Rightarrow u_{n+1} \leq u_n$; $\lim_{n \rightarrow \infty} u_n = \lim_{n \rightarrow \infty} \frac{n}{n^2+1} = 0$.

6. diverges \Rightarrow diverges by n^{th} Term Test for Divergence since: $\lim_{n \rightarrow \infty} \frac{n^2+5}{n^2+4} = 1 \Rightarrow \lim_{n \rightarrow \infty} (-1)^{n+1} \frac{n^2+5}{n^2+4} =$ does not exist
7. diverges \Rightarrow diverges by n^{th} Term Test for Divergence since: $\lim_{n \rightarrow \infty} \frac{2^n}{n^2} = \infty \Rightarrow \lim_{n \rightarrow \infty} (-1)^{n+1} \frac{2^n}{n^2} =$ does not exist
8. converges absolutely \Rightarrow converges by the Absolute Convergence Test since $\sum_{n=1}^{\infty} |a_n| = \sum_{n=1}^{\infty} \frac{10^n}{(n+1)!}$, which converges by the Ratio Test, since $\lim_{n \rightarrow \infty} \left| \frac{a_{n+1}}{a_n} \right| = \lim_{n \rightarrow \infty} \frac{10}{n+2} = 0 < 1$
9. diverges by the n^{th} -Term Test since for $n > 10 \Rightarrow \frac{n}{10} > 1 \Rightarrow \lim_{n \rightarrow \infty} \left(\frac{n}{10}\right)^n \neq 0 \Rightarrow \sum_{n=1}^{\infty} (-1)^{n+1} \left(\frac{n}{10}\right)^n$ diverges
10. converges by the Alternating Series Test because $f(x) = \ln x$ an increasing function of $x \Rightarrow \frac{1}{\ln x}$ is decreasing $\Rightarrow u_n \geq u_{n+1}$ for $n \geq 1$; also $u_n \geq 0$ for $n \geq 1$ and $\lim_{n \rightarrow \infty} \frac{1}{\ln n} = 0$
11. converges by the Alternating Series Test since $f(x) = \frac{\ln x}{x} \Rightarrow f'(x) = \frac{1-\ln x}{x^2} < 0$ when $x > e \Rightarrow f(x)$ is decreasing $\Rightarrow u_n \geq u_{n+1}$; also $u_n \geq 0$ for $n \geq 1$ and $\lim_{n \rightarrow \infty} u_n = \lim_{n \rightarrow \infty} \frac{\ln n}{n} = \lim_{n \rightarrow \infty} \frac{\left(\frac{1}{n}\right)}{1} = 0$
12. converges by the Alternating Series Test since $f(x) = \ln(1+x^{-1}) \Rightarrow f'(x) = \frac{-1}{x(x+1)} < 0$ for $x > 0 \Rightarrow f(x)$ is decreasing $\Rightarrow u_n \geq u_{n+1}$; also $u_n \geq 0$ for $n \geq 1$ and $\lim_{n \rightarrow \infty} u_n = \lim_{n \rightarrow \infty} \ln\left(1+\frac{1}{n}\right) = \ln\left(\lim_{n \rightarrow \infty} \left(1+\frac{1}{n}\right)\right) = \ln 1 = 0$
13. converges by the Alternating Series Test since $f(x) = \frac{\sqrt{x+1}}{x+1} \Rightarrow f'(x) = \frac{1-x-2\sqrt{x}}{2\sqrt{x}(x+1)^2} < 0 \Rightarrow f(x)$ is decreasing $\Rightarrow u_n \geq u_{n+1}$; also $u_n \geq 0$ for $n \geq 1$ and $\lim_{n \rightarrow \infty} u_n = \lim_{n \rightarrow \infty} \frac{\sqrt{n+1}}{n+1} = 0$
14. diverges by the n^{th} -Term Test since $\lim_{n \rightarrow \infty} \frac{3\sqrt{n+1}}{\sqrt{n+1}} = \lim_{n \rightarrow \infty} \frac{3\sqrt{1+\frac{1}{n}}}{1+\left(\frac{1}{\sqrt{n}}\right)} = 3 \neq 0$
15. converges absolutely since $\sum_{n=1}^{\infty} |a_n| = \sum_{n=1}^{\infty} \left(\frac{1}{10}\right)^n$ a convergent geometric series
16. converges absolutely by the Direct Comparison Test since $\left| \frac{(-1)^{n+1}(0.1)^n}{n} \right| = \frac{1}{(10)^n n} < \left(\frac{1}{10}\right)^n$ which is the n^{th} term of a convergent geometric series
17. converges conditionally since $\frac{1}{\sqrt{n}} > \frac{1}{\sqrt{n+1}} > 0$ and $\lim_{n \rightarrow \infty} \frac{1}{\sqrt{n}} = 0 \Rightarrow$ convergence; but $\sum_{n=1}^{\infty} |a_n| = \sum_{n=1}^{\infty} \frac{1}{n^{1/2}}$ is a divergent p -series

18. converges conditionally since $\frac{1}{1+\sqrt{n}} > \frac{1}{1+\sqrt{n+1}} > 0$ and $\lim_{n \rightarrow \infty} \frac{1}{1+\sqrt{n}} = 0 \Rightarrow$ convergence; but $\sum_{n=1}^{\infty} |a_n| = \sum_{n=1}^{\infty} \frac{1}{1+\sqrt{n}}$

is a divergent series since $\frac{1}{1+\sqrt{n}} \geq \frac{1}{2\sqrt{n}}$ and $\sum_{n=1}^{\infty} \frac{1}{n^{1/2}}$ is a divergent p -series

19. converges absolutely since $\sum_{n=1}^{\infty} |a_n| = \sum_{n=1}^{\infty} \frac{n}{n^3+1}$ and $\frac{n}{n^3+1} < \frac{1}{n^2}$ which is the n th-term of a converging p -series

20. diverges by the n th-Term Test since $\lim_{n \rightarrow \infty} \frac{n!}{2^n} = \infty$

21. converges conditionally since $\frac{1}{n+3} > \frac{1}{(n+1)+3} > 0$ and $\lim_{n \rightarrow \infty} \frac{1}{n+3} = 0 \Rightarrow$ convergence; but $\sum_{n=1}^{\infty} |a_n| = \sum_{n=1}^{\infty} \frac{1}{n+3}$

diverges because $\frac{1}{n+3} \geq \frac{1}{4n}$ and $\sum_{n=1}^{\infty} \frac{1}{n}$ is a divergent series

22. converges absolutely because the series $\sum_{n=1}^{\infty} \left| \frac{\sin n}{n^2} \right|$ converges by the Direct Comparison Test since $\left| \frac{\sin n}{n^2} \right| \leq \frac{1}{n^2}$

23. diverges by the n th-Term Test since $\lim_{n \rightarrow \infty} \frac{3+n}{5+n} = 1 \neq 0$

24. converges absolutely by the Direct Comparison Test since $\left| \frac{(-2)^{n+1}}{n+5^n} \right| = \frac{2^{n+1}}{n+5^n} < 2\left(\frac{2}{5}\right)^n$ which is the n th term of a convergent geometric series

25. converges conditionally since $f(x) = \frac{1}{x^2} + \frac{1}{x} \Rightarrow f'(x) = -\left(\frac{2}{x^3} + \frac{1}{x^2}\right) < 0 \Rightarrow f(x)$ is decreasing and hence

$u_n > u_{n+1} > 0$ for $n \geq 1$ and $\lim_{n \rightarrow \infty} \left(\frac{1}{n^2} + \frac{1}{n}\right) = 0 \Rightarrow$ convergence; but $\sum_{n=1}^{\infty} |a_n| = \sum_{n=1}^{\infty} \frac{1+n}{n^2} = \sum_{n=1}^{\infty} \frac{1}{n^2} + \sum_{n=1}^{\infty} \frac{1}{n}$ is the sum of a convergent and divergent series, and hence diverges

26. diverges by the n th-Term Test since $\lim_{n \rightarrow \infty} a_n = \lim_{n \rightarrow \infty} 10^{1/n} = 1 \neq 0$

27. converges absolutely by the Ratio Test: $\lim_{n \rightarrow \infty} \left| \frac{u_{n+1}}{u_n} \right| = \lim_{n \rightarrow \infty} \left[\frac{(n+1)^2 \left(\frac{2}{3}\right)^{n+1}}{n^2 \left(\frac{2}{3}\right)^n} \right] = \frac{2}{3} < 1$

28. converges conditionally since $f(x) = \frac{1}{x \ln x} \Rightarrow f'(x) = -\frac{[\ln(x)+1]}{(x \ln x)^2} < 0 \Rightarrow f(x)$ is decreasing $\Rightarrow u_n > u_{n+1} > 0$ for

$$n \geq 2 \text{ and } \lim_{n \rightarrow \infty} \frac{1}{n \ln n} = 0 \Rightarrow \text{convergence; but by the Integral Test, } \int_2^{\infty} \frac{dx}{x \ln x} = \lim_{b \rightarrow \infty} \int_2^b \left(\frac{1}{x} \right) \frac{1}{\ln x} dx$$

$$= \lim_{b \rightarrow \infty} [\ln(\ln x)]_2^b = \lim_{b \rightarrow \infty} [\ln(\ln b) - \ln(\ln 2)] = \infty \Rightarrow \sum_{n=1}^{\infty} |a_n| = \sum_{n=1}^{\infty} \frac{1}{n \ln n} \text{ diverges}$$

29. converges absolutely by the Integral Test since $\int_1^{\infty} (\tan^{-1} x) \left(\frac{1}{1+x^2} \right) dx = \lim_{b \rightarrow \infty} \left[\frac{(\tan^{-1} x)^2}{2} \right]_1^b$

$$= \lim_{b \rightarrow \infty} \left[(\tan^{-1} b)^2 - (\tan^{-1} 1)^2 \right] = \frac{1}{2} \left[\left(\frac{\pi}{2} \right)^2 - \left(\frac{\pi}{4} \right)^2 \right] = \frac{3\pi^2}{32}$$

30. converges conditionally since $f(x) = \frac{\ln x}{x - \ln x} \Rightarrow f'(x) = \frac{\left(\frac{1}{x} \right) (x - \ln x) - (\ln x) \left(1 - \frac{1}{x} \right)}{(x - \ln x)^2} = \frac{1 - \left(\frac{\ln x}{x} \right) - \ln x + \left(\frac{\ln x}{x} \right)}{(x - \ln x)^2} = \frac{1 - \ln x}{(x - \ln x)^2} < 0$

$$\Rightarrow u_n \geq u_{n+1} > 0 \text{ when } n > e \text{ and } \lim_{n \rightarrow \infty} \frac{\ln n}{n - \ln n} = \lim_{n \rightarrow \infty} \frac{\left(\frac{1}{n} \right)}{1 - \left(\frac{1}{n} \right)} = 0 \Rightarrow \text{convergence; but } n - \ln n < n \Rightarrow \frac{1}{n - \ln n} > \frac{1}{n}$$

$$\Rightarrow \frac{\ln n}{n - \ln n} > \frac{1}{n} \text{ so that } \sum_{n=1}^{\infty} |a_n| = \sum_{n=1}^{\infty} \frac{\ln n}{n - \ln n} \text{ diverges by the Direct Comparison Test}$$

31. diverges by the n th-Term Test since $\lim_{n \rightarrow \infty} \frac{n}{n+1} = 1 \neq 0$

32. converges absolutely since $\sum_{n=1}^{\infty} |a_n| = \sum_{n=1}^{\infty} \left(\frac{1}{5} \right)^n$ is a convergent geometric series

33. converges absolutely by the Ratio Test: $\lim_{n \rightarrow \infty} \left| \frac{u_{n+1}}{u_n} \right| = \lim_{n \rightarrow \infty} \frac{(100)^{n+1}}{(n+1)!} \cdot \frac{n!}{(100)^n} = \lim_{n \rightarrow \infty} \frac{100}{n+1} = 0 < 1$

34. converges absolutely by the Direct Comparison Test since $\sum_{n=1}^{\infty} |a_n| = \sum_{n=1}^{\infty} \frac{1}{n^2 + 2n + 1}$ and $\frac{1}{n^2 + 2n + 1} < \frac{1}{n^2}$ which is the n th-term of a convergent p -series

35. converges absolutely since $\sum_{n=1}^{\infty} |a_n| = \sum_{n=1}^{\infty} \left| \frac{(-1)^n}{n \sqrt{n}} \right| = \sum_{n=1}^{\infty} \frac{1}{n^{3/2}}$ is a convergent p -series

36. converges conditionally since $\sum_{n=1}^{\infty} \frac{\cos n\pi}{n} = \sum_{n=1}^{\infty} \frac{(-1)^n}{n}$ is the convergent alternating harmonic series,

$$\text{but } \sum_{n=1}^{\infty} |a_n| = \sum_{n=1}^{\infty} \frac{1}{n} \text{ diverges}$$

37. converges absolutely by the Root Test: $\lim_{n \rightarrow \infty} \sqrt[n]{|a_n|} = \lim_{n \rightarrow \infty} \left(\frac{(n+1)^n}{(2n)^n} \right)^{1/n} = \lim_{n \rightarrow \infty} \frac{n+1}{2n} = \frac{1}{2} < 1$

38. converges absolutely by the Ratio Test: $\lim_{n \rightarrow \infty} \left| \frac{a_{n+1}}{a_n} \right| = \lim_{n \rightarrow \infty} \frac{((n+1)!)^2}{((2n+2)!) (n!)^2} \cdot \frac{(2n)!}{(n!)^2} = \lim_{n \rightarrow \infty} \frac{(n+1)^2}{(2n+2)(2n+1)} = \frac{1}{4} < 1$

39. diverges by the n th-Term Test since $\lim_{n \rightarrow \infty} |a_n| = \lim_{n \rightarrow \infty} \frac{(2n)!}{2^n n! n} = \lim_{n \rightarrow \infty} \frac{(n+1)(n+2) \cdots (2n)}{2^n n} = \lim_{n \rightarrow \infty} \frac{(n+1)(n+2) \cdots (n+(n-1))}{2^{n-1}}$
 $> \lim_{n \rightarrow \infty} \left(\frac{n+1}{2} \right)^{n-1} = \infty \neq 0$

40. converges absolutely by the Ratio Test: $\lim_{n \rightarrow \infty} \left| \frac{a_{n+1}}{a_n} \right| = \lim_{n \rightarrow \infty} \frac{(n+1)!(n+1)!3^{n+1}}{(2n+3)!} \cdot \frac{(2n)!}{n!n!3^n} = \lim_{n \rightarrow \infty} \frac{(n+1)^2 3}{(2n+2)(2n+3)} = \frac{3}{4} < 1$

41. converges conditionally since $\frac{\sqrt{n+1}-\sqrt{n}}{1} \cdot \frac{\sqrt{n+1}+\sqrt{n}}{\sqrt{n+1}+\sqrt{n}} = \frac{1}{\sqrt{n+1}+\sqrt{n}}$ and $\left\{ \frac{1}{\sqrt{n+1}+\sqrt{n}} \right\}$ is a decreasing sequence of positive terms which converges to 0 $\Rightarrow \sum_{n=1}^{\infty} \frac{(-1)^n}{\sqrt{n+1}+\sqrt{n}}$ converges; but $\sum_{n=1}^{\infty} |a_n| = \sum_{n=1}^{\infty} \frac{1}{\sqrt{n+1}+\sqrt{n}}$ diverges by the Limit Comparison Test (part 1) with $\frac{1}{\sqrt{n}}$; a divergent p -series $\lim_{n \rightarrow \infty} \left(\frac{\frac{1}{\sqrt{n+1}+\sqrt{n}}}{\frac{1}{\sqrt{n}}} \right) = \lim_{n \rightarrow \infty} \frac{\sqrt{n}}{\sqrt{n+1}+\sqrt{n}}$
 $= \lim_{n \rightarrow \infty} \frac{1}{\sqrt{1+\frac{1}{n}}+1} = \frac{1}{2}$

42. diverges by the n th-Term Test since $\lim_{n \rightarrow \infty} \left(\sqrt{n^2+n} - n \right) = \lim_{n \rightarrow \infty} \left(\sqrt{n^2+n} - n \right) \cdot \left(\frac{\sqrt{n^2+n}+n}{\sqrt{n^2+n}+n} \right) = \lim_{n \rightarrow \infty} \frac{n}{\sqrt{n^2+n}+n}$
 $= \lim_{n \rightarrow \infty} \frac{1}{\sqrt{1+\frac{1}{n}}+1} = \frac{1}{2} \neq 0$

43. diverges by the n th-Term Test since $\lim_{n \rightarrow \infty} \left(\sqrt{n+\sqrt{n}} - \sqrt{n} \right) = \lim_{n \rightarrow \infty} \left[\left(\sqrt{n+\sqrt{n}} - \sqrt{n} \right) \left(\frac{\sqrt{n+\sqrt{n}}+\sqrt{n}}{\sqrt{n+\sqrt{n}}+\sqrt{n}} \right) \right]$
 $= \lim_{n \rightarrow \infty} \frac{\sqrt{n}}{\sqrt{n+\sqrt{n}}+\sqrt{n}} = \lim_{n \rightarrow \infty} \frac{1}{\sqrt{1+\frac{1}{\sqrt{n}}}+1} = \frac{1}{2} \neq 0$

44. converges conditionally since $\left\{ \frac{1}{\sqrt{n}+\sqrt{n+1}} \right\}$ is a decreasing sequence of positive terms converging to 0
 $\Rightarrow \sum_{n=1}^{\infty} \frac{(-1)^n}{\sqrt{n}+\sqrt{n+1}}$ converges; but $\lim_{n \rightarrow \infty} \frac{\left(\frac{1}{\sqrt{n}+\sqrt{n+1}} \right)}{\left(\frac{1}{\sqrt{n}} \right)} = \lim_{n \rightarrow \infty} \frac{\sqrt{n}}{\sqrt{n}+\sqrt{n+1}} = \lim_{n \rightarrow \infty} \frac{1}{1+\sqrt{1+\frac{1}{n}}} = \frac{1}{2}$ so that $\sum_{n=1}^{\infty} \frac{1}{\sqrt{n}+\sqrt{n+1}}$
diverges by the Limit Comparison Test with $\sum_{n=1}^{\infty} \frac{1}{\sqrt{n}}$ which is a divergent p -series

45. converges absolutely by the Direct Comparison Test since $\operatorname{sech}(n) = \frac{2}{e^n + e^{-n}} = \frac{2e^n}{e^{2n} + 1} < \frac{2e^n}{e^{2n}} = \frac{2}{e^n}$ which is the n th term of a convergent geometric series

46. converges absolutely by the Limit Comparison Test (part 1): $\sum_{n=1}^{\infty} |a_n| = \sum_{n=1}^{\infty} \frac{2}{e^n - e^{-n}}$ Apply the Limit Comparison

Test with $\frac{1}{e^n}$, the n th term of a convergent geometric series: $\lim_{n \rightarrow \infty} \left(\frac{\frac{2}{e^n - e^{-n}}}{\frac{1}{e^n}} \right) = \lim_{n \rightarrow \infty} \frac{2e^n}{e^n - e^{-n}} = \lim_{n \rightarrow \infty} \frac{2}{1 - e^{-2n}} = 2$

47. $\frac{1}{4} - \frac{1}{6} + \frac{1}{8} - \frac{1}{10} + \frac{1}{12} - \frac{1}{14} + \dots = \sum_{n=1}^{\infty} \frac{(-1)^{n+1}}{2(n+1)}$; converges by Alternating Series Test since: $u_n = \frac{1}{2(n+1)} > 0$ for all $n \geq 1$; $n+2 \geq n+1 \Rightarrow 2(n+2) \geq 2(n+1) \Rightarrow \frac{1}{2(n+1+1)} \leq \frac{1}{2(n+1)} \Rightarrow u_{n+1} \leq u_n$; $\lim_{n \rightarrow \infty} u_n = \lim_{n \rightarrow \infty} \frac{1}{2(n+1)} = 0$.

48. $1 + \frac{1}{4} - \frac{1}{9} - \frac{1}{16} + \frac{1}{25} + \frac{1}{36} - \frac{1}{49} - \frac{1}{64} + \dots = \sum_{n=1}^{\infty} a_n$; converges by the Absolute Convergence Test since

$$\sum_{n=1}^{\infty} |a_n| = \sum_{n=1}^{\infty} \frac{1}{n^2} \text{ which is a convergent } p\text{-series}$$

49. $|\text{error}| < \left| (-1)^6 \left(\frac{1}{5} \right) \right| = 0.2$

50. $|\text{error}| < \left| (-1)^6 \left(\frac{1}{10^5} \right) \right| = 0.00001$

51. $|\text{error}| < \left| (-1)^6 \frac{(0.01)^5}{5} \right| = 2 \times 10^{-11}$

52. $|\text{error}| < \left| (-1)^4 t^4 \right| = t^4 < 1$

53. $|\text{error}| < 0.001 \Rightarrow u_{n+1} < 0.001 \Rightarrow \frac{1}{(n+1)^2 + 3} < 0.001 \Rightarrow (n+1)^2 + 3 > 1000 \Rightarrow n > -1 + \sqrt{997} \approx 30.5753 \Rightarrow n \geq 31$

54. $|\text{error}| < 0.001 \Rightarrow u_{n+1} < 0.001 \Rightarrow \frac{n+1}{(n+1)^2 + 1} < 0.001 \Rightarrow (n+1)^2 + 1 > 1000(n+1) \Rightarrow n > \frac{998 + \sqrt{998^2 + 4(998)}}{2} \approx 998.9999 \Rightarrow n \geq 999$

55. $|\text{error}| < 0.001 \Rightarrow u_{n+1} < 0.001 \Rightarrow \frac{1}{((n+1) + 3\sqrt{n+1})^3} < 0.001 \Rightarrow ((n+1) + 3\sqrt{n+1})^3 > 1000$
 $\Rightarrow (\sqrt{n+1})^2 + 3\sqrt{n+1} - 10 > 0 \Rightarrow \sqrt{n+1} = \frac{-3 + \sqrt{9+40}}{2} = 2 \Rightarrow n = 3 \Rightarrow n \geq 4$

56. $|\text{error}| < 0.001 \Rightarrow u_{n+1} < 0.001 \Rightarrow \frac{1}{\ln(\ln(n+3))} < 0.001 \Rightarrow \ln(\ln(n+3)) > 1000 \Rightarrow n > -3 + e^{1000} \approx 5.297 \times 10^{323228467}$ which is the maximum arbitrary-precision number represented by Mathematica on the particular computer solving this problem.

57. $\frac{1}{(2n)!} < \frac{5}{10^6} \Rightarrow (2n)! > \frac{10^6}{5} = 200,000 \Rightarrow n \geq 5 \Rightarrow 1 - \frac{1}{2!} + \frac{1}{4!} - \frac{1}{6!} + \frac{1}{8!} \approx 0.54030$

58. $\frac{1}{n!} < \frac{5}{10^6} \Rightarrow \frac{10^6}{5} < n! \Rightarrow n \geq 9 \Rightarrow 1 - 1 + \frac{1}{2!} - \frac{1}{3!} + \frac{1}{4!} - \frac{1}{5!} + \frac{1}{6!} - \frac{1}{7!} + \frac{1}{8!} \approx 0.367881944$

59. (a) $a_n \geq a_{n+1}$ fails since $\frac{1}{3} < \frac{1}{2}$

- (b) Since $\sum_{n=1}^{\infty} |a_n| = \sum_{n=1}^{\infty} \left[\left(\frac{1}{3}\right)^n + \left(\frac{1}{2}\right)^n \right] = \sum_{n=1}^{\infty} \left(\frac{1}{3}\right)^n + \sum_{n=1}^{\infty} \left(\frac{1}{2}\right)^n$ is the sum of two absolutely convergent series, we can rearrange the terms of the original series to find its sum: $\left(\frac{1}{3} + \frac{1}{9} + \frac{1}{27} + \dots\right) - \left(\frac{1}{2} + \frac{1}{4} + \frac{1}{8} + \dots\right)$
- $$= \frac{\left(\frac{1}{3}\right)}{1 - \left(\frac{1}{3}\right)} - \frac{\left(\frac{1}{2}\right)}{1 - \left(\frac{1}{2}\right)} = \frac{1}{2} - 1 = -\frac{1}{2}$$

60. $s_{20} = 1 - \frac{1}{2} + \frac{1}{3} - \frac{1}{4} + \dots + \frac{1}{19} - \frac{1}{20} \approx 0.6687714032 \Rightarrow s_{20} + \frac{1}{2} \cdot \frac{1}{21} \approx 0.692580927$

61. The unused terms are $\sum_{j=n+1}^{\infty} (-1)^{j+1} a_j = (-1)^{n+1} (a_{n+1} - a_{n+2}) + (-1)^{n+3} (a_{n+3} - a_{n+4}) + \dots$
 $= (-1)^{n+1} [(a_{n+1} - a_{n+2}) + (a_{n+3} - a_{n+4}) + \dots]$. Each grouped term is positive, so the remainder has the same sign as $(-1)^{n+1}$, which is the sign of the first unused term.

62. $s_n = \frac{1}{1 \cdot 2} + \frac{1}{2 \cdot 3} + \frac{1}{3 \cdot 4} + \dots + \frac{1}{n(n+1)} = \sum_{k=1}^n \frac{1}{k(k+1)} = \sum_{k=1}^n \left(\frac{1}{k} - \frac{1}{k+1}\right) = \left(1 - \frac{1}{2}\right) + \left(\frac{1}{2} - \frac{1}{3}\right) + \left(\frac{1}{3} - \frac{1}{4}\right) + \left(\frac{1}{4} - \frac{1}{5}\right) + \dots + \left(\frac{1}{n} - \frac{1}{n+1}\right)$

which are the first $2n$ terms of the first series, hence the two series are the same. Yes, for $s_n = \sum_{k=1}^n \left(\frac{1}{k} - \frac{1}{k+1}\right)$

$$= \left(1 - \frac{1}{2}\right) + \left(\frac{1}{2} - \frac{1}{3}\right) + \left(\frac{1}{3} - \frac{1}{4}\right) + \left(\frac{1}{4} - \frac{1}{5}\right) + \dots + \left(\frac{1}{n-1} - \frac{1}{n}\right) + \left(\frac{1}{n} - \frac{1}{n+1}\right) = 1 - \frac{1}{n+1} \Rightarrow \lim_{n \rightarrow \infty} s_n = \lim_{n \rightarrow \infty} \left(1 - \frac{1}{n+1}\right) = 1$$

\Rightarrow both series converge to 1. The sum of the first $2n+1$ terms of the first series is $\left(1 - \frac{1}{n+1}\right) + \frac{1}{n+1} = 1$.

Their sum is $\lim_{n \rightarrow \infty} s_n = \lim_{n \rightarrow \infty} \left(1 - \frac{1}{n+1}\right) = 1$.

63. Theorem 16 states that $\sum_{n=1}^{\infty} |a_n|$ converges $\Rightarrow \sum_{n=1}^{\infty} a_n$ converges. But this is equivalent to $\sum_{n=1}^{\infty} a_n$ diverges
 $\Rightarrow \sum_{n=1}^{\infty} |a_n|$ diverges

64. $|a_1 + a_2 + \dots + a_n| \leq |a_1| + |a_2| + \dots + |a_n|$ for all n ; then $\sum_{n=1}^{\infty} |a_n|$ converges $\Rightarrow \sum_{n=1}^{\infty} a_n$ converges and these imply

that $\left| \sum_{n=1}^{\infty} a_n \right| \leq \sum_{n=1}^{\infty} |a_n|$

65. (a) $\sum_{n=1}^{\infty} |a_n + b_n|$ converges by the Direct Comparison Test since $|a_n + b_n| \leq |a_n| + |b_n|$ and hence $\sum_{n=1}^{\infty} (|a_n| + |b_n|)$ converges absolutely

- (b) $\sum_{n=1}^{\infty} |b_n|$ converges $\Rightarrow \sum_{n=1}^{\infty} -b_n$ converges absolutely; since $\sum_{n=1}^{\infty} a_n$ converges absolutely and $\sum_{n=1}^{\infty} -b_n$

converges absolutely, we have $\sum_{n=1}^{\infty} [a_n + (-b_n)] = \sum_{n=1}^{\infty} (a_n - b_n)$ converges absolutely by part (a)

- (c) $\sum_{n=1}^{\infty} |a_n|$ converges $\Rightarrow |k| \sum_{n=1}^{\infty} |a_n| = \sum_{n=1}^{\infty} |ka_n|$ converges $\Rightarrow \sum_{n=1}^{\infty} ka_n$ converges absolutely

66. If $a_n = b_n = (-1)^n \frac{1}{\sqrt{n}}$, then $\sum_{n=1}^{\infty} (-1)^n \frac{1}{\sqrt{n}}$ converges, but $\sum_{n=1}^{\infty} a_n b_n = \sum_{n=1}^{\infty} \frac{1}{n}$ diverges
67. Since $\sum_{n=1}^{\infty} a_n$ converges, $a_n \rightarrow 0$ and for all n greater than some N , $|a_n| < 1$ and $(a_n)^2 < |a_n|$. Since $\sum_{n=1}^{\infty} a_n$ is absolutely convergent, $\sum_{n=1}^{\infty} |a_n|$ converges and thus $\sum_{n=1}^{\infty} (a_n)^2$ converges by the Direct Comparison Test.

68. For $n > 2$, $\frac{1}{n} - \frac{1}{n^2} > \frac{1}{2n}$. Thus $\sum_{n=1}^{\infty} \left(\frac{1}{n} - \frac{1}{n^2}\right)$ diverges by comparison with the divergent harmonic series.

69. $s_1 = -\frac{1}{2}, s_2 = -\frac{1}{2} + 1 = \frac{1}{2},$
 $s_3 = -\frac{1}{2} + 1 - \frac{1}{4} - \frac{1}{6} - \frac{1}{8} - \frac{1}{10} - \frac{1}{12} - \frac{1}{14} - \frac{1}{16} - \frac{1}{18} - \frac{1}{20} - \frac{1}{22} \approx -0.5099,$
 $s_4 = s_3 + \frac{1}{3} \approx -0.1766,$
 $s_5 = s_4 - \frac{1}{24} - \frac{1}{26} - \frac{1}{28} - \frac{1}{30} - \frac{1}{32} - \frac{1}{34} - \frac{1}{36} - \frac{1}{38} - \frac{1}{40} - \frac{1}{42} - \frac{1}{44} \approx -0.512,$
 $s_6 = s_5 + \frac{1}{5} \approx -0.312,$
 $s_7 = s_6 - \frac{1}{46} - \frac{1}{48} - \frac{1}{50} - \frac{1}{52} - \frac{1}{54} - \frac{1}{56} - \frac{1}{58} - \frac{1}{60} - \frac{1}{62} - \frac{1}{64} - \frac{1}{66} \approx -0.51106$

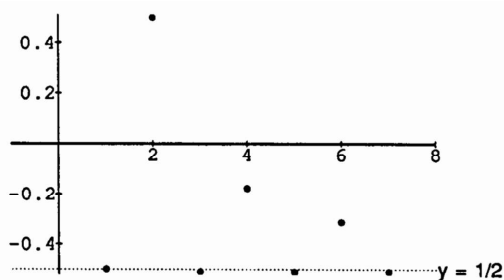

70. (a) Since $\sum |a_n|$ converges, say to M , for $\epsilon > 0$ there is an integer N_1 such that

$$\left| \sum_{n=1}^{N_1-1} |a_n| - M \right| < \frac{\epsilon}{2} \Leftrightarrow \left| \sum_{n=1}^{N_1-1} |a_n| - \left(\sum_{n=1}^{N_1-1} |a_n| + \sum_{n=N_1}^{\infty} |a_n| \right) \right| < \frac{\epsilon}{2} \Leftrightarrow \left| - \sum_{n=N_1}^{\infty} |a_n| \right| < \frac{\epsilon}{2} \Leftrightarrow \sum_{n=N_1}^{\infty} |a_n| < \frac{\epsilon}{2}.$$

Also, $\sum a_n$ converges to $L \Leftrightarrow$ for $\epsilon > 0$ there is an integer N_2 (which we can choose greater than or equal to N_1) such that $|s_{N_2} - L| < \frac{\epsilon}{2}$. Therefore, $\sum_{n=N_1}^{\infty} |a_n| < \frac{\epsilon}{2}$ and $|s_{N_2} - L| < \frac{\epsilon}{2}$.

(b) The series $\sum_{n=1}^{\infty} |a_n|$ converges absolutely, say to M . Thus, there exists N_1 such that $\left| \sum_{n=1}^k |a_n| - M \right| < \epsilon$ whenever $k > N_1$. Now all of the terms in the sequence $\{b_n\}$ appear in $\{a_n\}$. Sum together all of the terms in $\{b_n\}$, in order, until you include all of the terms $\{a_n\}_{n=1}^{N_1}$, and let N_2 be the largest index in the sum $\sum_{n=1}^{N_2} |b_n|$ so obtained. Then $\left| \sum_{n=1}^{N_2} |b_n| - M \right| < \epsilon$ as well $\Rightarrow \sum_{n=1}^{\infty} |b_n|$ converges to M .

10.7 POWER SERIES

$$1. \lim_{n \rightarrow \infty} \left| \frac{u_{n+1}}{u_n} \right| < 1 \Rightarrow \lim_{n \rightarrow \infty} \left| \frac{x^{n+1}}{x^n} \right| < 1 \Rightarrow |x| < 1 \Rightarrow -1 < x < 1; \text{ when } x = -1 \text{ we have } \sum_{n=1}^{\infty} (-1)^n, \text{ a divergent series;}$$

when $x = 1$ we have $\sum_{n=1}^{\infty} 1$, a divergent series

- (a) the radius is 1; the interval of convergence is $-1 < x < 1$
- (b) the interval of absolute convergence is $-1 < x < 1$
- (c) there are no values for which the series converges conditionally

$$2. \lim_{n \rightarrow \infty} \left| \frac{u_{n+1}}{u_n} \right| < 1 \Rightarrow \lim_{n \rightarrow \infty} \left| \frac{(x+5)^{n+1}}{(x+5)^n} \right| < 1 \Rightarrow |x+5| < 1 \Rightarrow -6 < x < -4; \text{ when } x = -6 \text{ we have } \sum_{n=1}^{\infty} (-1)^n, \text{ a divergent}$$

series; when $x = -4$ we have $\sum_{n=1}^{\infty} 1$, a divergent series

- (a) the radius is 1; the interval of convergence is $-6 < x < -4$
- (b) the interval of absolute convergence is $-6 < x < -4$
- (c) there are no values for which the series converges conditionally

$$3. \lim_{n \rightarrow \infty} \left| \frac{u_{n+1}}{u_n} \right| < 1 \Rightarrow \lim_{n \rightarrow \infty} \left| \frac{(4x+1)^{n+1}}{(4x+1)^n} \right| < 1 \Rightarrow |4x+1| < 1 \Rightarrow -1 < 4x+1 < 1 \Rightarrow -\frac{1}{2} < x < 0; \text{ when } x = -\frac{1}{2} \text{ we have}$$

$$\sum_{n=1}^{\infty} (-1)^n (-1)^n = \sum_{n=1}^{\infty} (-1)^{2n} = \sum_{n=1}^{\infty} 1^n, \text{ a divergent series; when } x = 0 \text{ we have } \sum_{n=1}^{\infty} (-1)^n (1)^n = \sum_{n=1}^{\infty} (-1)^n,$$

a divergent series

- (a) the radius is $\frac{1}{4}$; the interval of convergence is $-\frac{1}{2} < x < 0$
- (b) the interval of absolute convergence is $-\frac{1}{2} < x < 0$
- (c) there are no values for which the series converges conditionally

$$4. \lim_{n \rightarrow \infty} \left| \frac{u_{n+1}}{u_n} \right| < 1 \Rightarrow \lim_{n \rightarrow \infty} \left| \frac{(3x-2)^{n+1}}{n+1} \cdot \frac{n}{(3x-2)^n} \right| < 1 \Rightarrow |3x-2| \lim_{n \rightarrow \infty} \left(\frac{n}{n+1} \right) < 1 \Rightarrow |3x-2| < 1 \Rightarrow -1 < 3x-2 < 1$$

$\Rightarrow \frac{1}{3} < x < 1$; when $x = \frac{1}{3}$ we have $\sum_{n=1}^{\infty} \frac{(-1)^n}{n}$ which is the alternating harmonic series and is conditionally

convergent; when $x = 1$ we have $\sum_{n=1}^{\infty} \frac{1}{n}$, the divergent harmonic series

- (a) the radius is $\frac{1}{3}$; the interval of convergence is $\frac{1}{3} \leq x < 1$
- (b) the interval of absolute convergence is $\frac{1}{3} < x < 1$
- (c) the series converges conditionally at $x = \frac{1}{3}$

$$5. \lim_{n \rightarrow \infty} \left| \frac{u_{n+1}}{u_n} \right| < 1 \Rightarrow \lim_{n \rightarrow \infty} \left| \frac{(x-2)^{n+1}}{10^{n+1}} \cdot \frac{10^n}{(x-2)^n} \right| < 1 \Rightarrow \frac{|x-2|}{10} < 1 \Rightarrow |x-2| < 10 \Rightarrow -10 < x-2 < 10 \Rightarrow -8 < x < 12; \text{ when}$$

$x = -8$ we have $\sum_{n=1}^{\infty} (-1)^n$, a divergent series; when $x = 12$ we have $\sum_{n=1}^{\infty} 1$, a divergent series

- (a) the radius is 10; the interval of convergence is $-8 < x < 12$
- (b) the interval of absolute convergence is $-8 < x < 12$
- (c) there are no values for which the series converges conditionally

$$6. \lim_{n \rightarrow \infty} \left| \frac{u_{n+1}}{u_n} \right| < 1 \Rightarrow \lim_{n \rightarrow \infty} \left| \frac{(2x)^{n+1}}{(2x)^n} \right| < 1 \Rightarrow \lim_{n \rightarrow \infty} |2x| < 1 \Rightarrow |2x| < 1 \Rightarrow -\frac{1}{2} < x < \frac{1}{2}; \text{ when } x = -\frac{1}{2} \text{ we have } \sum_{n=1}^{\infty} (-1)^n,$$

a divergent series; when $x = \frac{1}{2}$ we have $\sum_{n=1}^{\infty} 1$, a divergent series

(a) the radius is $\frac{1}{2}$; the interval of convergence is $-\frac{1}{2} < x < \frac{1}{2}$

(b) the interval of absolute convergence is $-\frac{1}{2} < x < \frac{1}{2}$

(c) there are no values for which the series converges conditionally

$$7. \lim_{n \rightarrow \infty} \left| \frac{u_{n+1}}{u_n} \right| < 1 \Rightarrow \lim_{n \rightarrow \infty} \left| \frac{(n+1)x^{n+1}}{(n+3)} \cdot \frac{(n+2)}{nx^n} \right| < 1 \Rightarrow |x| \lim_{n \rightarrow \infty} \frac{(n+1)(n+2)}{(n+3)(n)} < 1 \Rightarrow |x| < 1 \Rightarrow -1 < x < 1; \text{ when } x = -1 \text{ we have}$$

$\sum_{n=1}^{\infty} (-1)^n \frac{n}{n+2}$, a divergent series by the n th-term; Test; when $x = 1$ we have $\sum_{n=1}^{\infty} \frac{n}{n+2}$, a divergent series

(a) the radius is 1; the interval of convergence is $-1 < x < 1$

(b) the interval of absolute convergence is $-1 < x < 1$

(c) there are no values for which the series converges conditionally

$$8. \lim_{n \rightarrow \infty} \left| \frac{u_{n+1}}{u_n} \right| < 1 \Rightarrow \lim_{n \rightarrow \infty} \left| \frac{(x+2)^{n+1}}{n+1} \cdot \frac{n}{(x+2)^n} \right| < 1 \Rightarrow |x+2| \lim_{n \rightarrow \infty} \left(\frac{n}{n+1} \right) < 1 \Rightarrow |x+2| < 1 \Rightarrow -1 < x+2 < 1 \Rightarrow -3 < x < -1;$$

when $x = -3$ we have $\sum_{n=1}^{\infty} \frac{1}{n}$, a divergent series; when $x = -1$ we have $\sum_{n=1}^{\infty} \frac{(-1)^n}{n}$, a convergent series

(a) the radius is 1; the interval of convergence is $-3 < x \leq -1$

(b) the interval of absolute convergence is $-3 < x < -1$

(c) the series converges conditionally at $x = -1$

$$9. \lim_{n \rightarrow \infty} \left| \frac{u_{n+1}}{u_n} \right| < 1 \Rightarrow \lim_{n \rightarrow \infty} \left| \frac{x^{n+1}}{(n+1)\sqrt{n+1}3^{n+1}} \cdot \frac{n\sqrt{n}3^n}{x^n} \right| < 1 \Rightarrow \frac{|x|}{3} \left(\lim_{n \rightarrow \infty} \frac{n}{n+1} \right) \left(\sqrt{\lim_{n \rightarrow \infty} \frac{n}{n+1}} \right) < 1 \Rightarrow \frac{|x|}{3} (1)(1) < 1 \Rightarrow |x| < 3$$

$\Rightarrow -3 < x < 3$; when $x = -3$ we have $\sum_{n=1}^{\infty} \frac{(-1)^n}{n^{3/2}}$, an absolutely convergent series; when $x = 3$ we have

$\sum_{n=1}^{\infty} \frac{1}{n^{3/2}}$, a convergent p -series

(a) the radius is 3; the interval of convergence is $-3 \leq x \leq 3$

(b) the interval of absolute convergence is $-3 \leq x \leq 3$

(c) there are no values for which the series converges conditionally

$$10. \lim_{n \rightarrow \infty} \left| \frac{u_{n+1}}{u_n} \right| < 1 \Rightarrow \lim_{n \rightarrow \infty} \left| \frac{(x-1)^{n+1}}{\sqrt{n+1}} \cdot \frac{\sqrt{n}}{(x-1)^n} \right| < 1 \Rightarrow |x-1| \sqrt{\lim_{n \rightarrow \infty} \frac{n}{n+1}} < 1 \Rightarrow |x-1| < 1 \Rightarrow -1 < x-1 < 1 \Rightarrow 0 < x < 2; \text{ when}$$

$x = 0$ we have $\sum_{n=1}^{\infty} \frac{(-1)^n}{n^{1/2}}$, a conditionally convergent series; when $x = 2$ we have $\sum_{n=1}^{\infty} \frac{1}{n^{1/2}}$, a divergent series

(a) the radius is 1; the interval of convergence is $0 \leq x < 2$

(b) the interval of absolute convergence is $0 < x < 2$

(c) the series converges conditionally at $x = 0$

11. $\lim_{n \rightarrow \infty} \left| \frac{u_{n+1}}{u_n} \right| < 1 \Rightarrow \lim_{n \rightarrow \infty} \left| \frac{x^{n+1}}{(n+1)!} \cdot \frac{n!}{x^n} \right| < 1 \Rightarrow |x| \lim_{n \rightarrow \infty} \left(\frac{1}{n+1} \right) < 1$ for all x
 (a) the radius is ∞ ; the series converges for all x
 (b) the series converges absolutely for all x
 (c) there are no values for which the series converges conditionally
12. $\lim_{n \rightarrow \infty} \left| \frac{u_{n+1}}{u_n} \right| < 1 \Rightarrow \lim_{n \rightarrow \infty} \left| \frac{3^{n+1} x^{n+1}}{(n+1)!} \cdot \frac{n!}{3^n x^n} \right| < 1 \Rightarrow 3|x| \lim_{n \rightarrow \infty} \left(\frac{1}{n+1} \right) < 1$ for all x
 (a) the radius is ∞ ; the series converges for all x
 (b) the series converges absolutely for all x
 (c) there are no values for which the series converges conditionally
13. $\lim_{n \rightarrow \infty} \left| \frac{u_{n+1}}{u_n} \right| < 1 \Rightarrow \lim_{n \rightarrow \infty} \left| \frac{4^{n+1} x^{2n+2}}{n+1} \cdot \frac{n}{4^n x^{2n}} \right| < 1 \Rightarrow x^2 \lim_{n \rightarrow \infty} \left(\frac{4n}{n+1} \right) = 4x^2 < 1 \Rightarrow x^2 < \frac{1}{4} \Rightarrow -\frac{1}{2} < x < \frac{1}{2}$; when $x = -\frac{1}{2}$ we have $\sum_{n=1}^{\infty} \frac{4^n}{n} \left(-\frac{1}{2}\right)^{2n} = \sum_{n=1}^{\infty} \frac{1}{n}$, a divergent p -series when $x = \frac{1}{2}$ we have $\sum_{n=1}^{\infty} \frac{4^n}{n} \left(\frac{1}{2}\right)^{2n} = \sum_{n=1}^{\infty} \frac{1}{n}$, a divergent p -series
 (a) the radius is $\frac{1}{2}$; the interval of convergence is $-\frac{1}{2} < x < \frac{1}{2}$
 (b) the interval of absolute convergence is $-\frac{1}{2} < x < \frac{1}{2}$
 (c) there are no values for which the series converges conditionally
14. $\lim_{n \rightarrow \infty} \left| \frac{u_{n+1}}{u_n} \right| < 1 \Rightarrow \lim_{n \rightarrow \infty} \left| \frac{(x-1)^{n+1}}{(n+1)^2 3^{n+1}} \cdot \frac{n^2 3^n}{(x-1)^n} \right| < 1 \Rightarrow |x-1| \lim_{n \rightarrow \infty} \left(\frac{n^2}{3(n+1)^2} \right) = \frac{1}{3} |x-1| < 1 \Rightarrow -2 < x < 4$; when $x = -2$ we have $\sum_{n=1}^{\infty} \frac{(-3)^n}{n^2 3^n} = \sum_{n=1}^{\infty} \frac{(-1)^n}{n^2}$, an absolutely convergent series; when $x = 4$ we have $\sum_{n=1}^{\infty} \frac{(3)^n}{n^2 3^n} = \sum_{n=1}^{\infty} \frac{1}{n^2}$, an absolutely convergent series.
 (a) the radius is 3; the interval of convergence is $-2 \leq x \leq 4$
 (b) the interval of absolute convergence is $-2 \leq x \leq 4$
 (c) there are no values for which the series converges conditionally
15. $\lim_{n \rightarrow \infty} \left| \frac{u_{n+1}}{u_n} \right| < 1 \Rightarrow \lim_{n \rightarrow \infty} \left| \frac{x^{n+1}}{\sqrt{(n+1)^2+3}} \cdot \frac{\sqrt{n^2+3}}{x^n} \right| < 1 \Rightarrow |x| \sqrt{\lim_{n \rightarrow \infty} \frac{n^2+3}{n^2+2n+4}} < 1 \Rightarrow |x| < 1 \Rightarrow -1 < x < 1$; when $x = -1$ we have $\sum_{n=1}^{\infty} \frac{(-1)^n}{\sqrt{n^2+3}}$, a conditionally convergent series; when $x = 1$ we have $\sum_{n=1}^{\infty} \frac{1}{\sqrt{n^2+3}}$, a divergent series
 (a) the radius is 1; the interval of convergence is $-1 \leq x < 1$
 (b) the interval of absolute convergence is $-1 < x < 1$
 (c) the series converges conditionally at $x = -1$
16. $\lim_{n \rightarrow \infty} \left| \frac{u_{n+1}}{u_n} \right| < 1 \Rightarrow \lim_{n \rightarrow \infty} \left| \frac{x^{n+1}}{\sqrt{(n+1)^2+3}} \cdot \frac{\sqrt{n^2+3}}{x^n} \right| < 1 \Rightarrow |x| \sqrt{\lim_{n \rightarrow \infty} \frac{n^2+3}{n^2+2n+4}} < 1 \Rightarrow |x| < 1 \Rightarrow -1 < x < 1$; when $x = -1$ we have $\sum_{n=1}^{\infty} \frac{1}{\sqrt{n^2+3}}$, a divergent series; when $x = 1$ we have $\sum_{n=1}^{\infty} \frac{(-1)^n}{\sqrt{n^2+3}}$, a conditionally convergent series
 (a) the radius is 1; the interval of convergence is $-1 < x \leq 1$
 (b) the interval of absolute convergence is $-1 < x < 1$
 (c) the series converges conditionally at $x = 1$

$$17. \lim_{n \rightarrow \infty} \left| \frac{u_{n+1}}{u_n} \right| < 1 \Rightarrow \lim_{n \rightarrow \infty} \left| \frac{(n+1)(x+3)^{n+1}}{5^{n+1}} \cdot \frac{5^n}{n(x+3)^n} \right| < 1 \Rightarrow \frac{|x+3|}{5} \lim_{n \rightarrow \infty} \left(\frac{n+1}{n} \right) < 1 \Rightarrow \frac{|x+3|}{5} < 1 \Rightarrow |x+3| < 5 \Rightarrow -5 < x+3 < 5$$

$\Rightarrow -8 < x < 2$; when $x = -8$ we have $\sum_{n=1}^{\infty} \frac{n(-5)^n}{5^n} = \sum_{n=1}^{\infty} (-1)^n n$, a divergent series; when $x = 2$ we have

$$\sum_{n=1}^{\infty} \frac{n5^n}{5^n} = \sum_{n=1}^{\infty} n, \text{ a divergent series}$$

- (a) the radius is 5; the interval of convergence is $-8 < x < 2$
 (b) the interval of absolute convergence is $-8 < x < 2$
 (c) there are no values for which the series converges conditionally

$$18. \lim_{n \rightarrow \infty} \left| \frac{u_{n+1}}{u_n} \right| < 1 \Rightarrow \lim_{n \rightarrow \infty} \left| \frac{(n+1)x^{n+1}}{4^{n+1}(n^2+2n+2)} \cdot \frac{4^n(n^2+1)}{nx^n} \right| < 1 \Rightarrow \frac{|x|}{4} \lim_{n \rightarrow \infty} \left| \frac{(n+1)(n^2+1)}{n(n^2+2n+2)} \right| < 1 \Rightarrow |x| < 4 \Rightarrow -4 < x < 4$$
; when

$x = -4$ we have $\sum_{n=1}^{\infty} \frac{n(-1)^n}{n^2+1}$, a conditionally convergent series; when $x = 4$ we have $\sum_{n=1}^{\infty} \frac{n}{n^2+1}$, a divergent

series

- (a) the radius is 4; the interval of convergence is $-4 \leq x < 4$
 (b) the interval of absolute convergence is $-4 < x < 4$
 (c) the series converges conditionally at $x = -4$

$$19. \lim_{n \rightarrow \infty} \left| \frac{u_{n+1}}{u_n} \right| < 1 \Rightarrow \lim_{n \rightarrow \infty} \left| \frac{\sqrt{n+1}x^{n+1}}{3^{n+1}} \cdot \frac{3^n}{\sqrt{nx^n}} \right| < 1 \Rightarrow \frac{|x|}{3} \sqrt{\lim_{n \rightarrow \infty} \left(\frac{n+1}{n} \right)} < 1 \Rightarrow \frac{|x|}{3} < 1 \Rightarrow |x| < 3 \Rightarrow -3 < x < 3$$
; when $x = -3$

we have $\sum_{n=1}^{\infty} (-1)^n \sqrt{n}$, a divergent series; when $x = 3$ we have $\sum_{n=1}^{\infty} \sqrt{n}$, a divergent series

- (a) the radius is 3; the interval of convergence is $-3 < x < 3$
 (b) the interval of absolute convergence is $-3 < x < 3$
 (c) there are no values for which the series converges conditionally

$$20. \lim_{n \rightarrow \infty} \left| \frac{u_{n+1}}{u_n} \right| < 1 \Rightarrow \lim_{n \rightarrow \infty} \left| \frac{n^{\sqrt{n+1}}(2x+5)^{n+1}}{\sqrt[n]{n}(2x+5)^n} \right| < 1 \Rightarrow |2x+5| \lim_{n \rightarrow \infty} \left(\frac{n^{\sqrt{n+1}}}{\sqrt[n]{n}} \right) < 1 \Rightarrow |2x+5| \left(\frac{\lim_{t \rightarrow \infty} \sqrt[t]{t}}{\lim_{n \rightarrow \infty} \sqrt[n]{n}} \right) < 1 \Rightarrow |2x+5| < 1$$

$\Rightarrow -1 < 2x+5 < 1 \Rightarrow -3 < x < -2$; when $x = -3$ we have $\sum_{n=1}^{\infty} (-1)^n \sqrt[n]{n}$, a divergent series since $\lim_{n \rightarrow \infty} \sqrt[n]{n} = 1$;

when $x = -2$ we have $\sum_{n=1}^{\infty} \sqrt[n]{n}$, a divergent series

- (a) the radius is $\frac{1}{2}$; the interval of convergence is $-3 < x < -2$
 (b) the interval of absolute convergence is $-3 < x < -2$
 (c) there are no values for which the series converges conditionally

$$21. \text{ First, rewrite the series as } \sum_{n=1}^{\infty} (2 + (-1)^n)(x+1)^{n-1} = \sum_{n=1}^{\infty} 2(x+1)^{n-1} + \sum_{n=1}^{\infty} (-1)^n(x+1)^{n-1}.$$

For the series $\sum_{n=1}^{\infty} 2(x+1)^{n-1}$: $\lim_{n \rightarrow \infty} \left| \frac{u_{n+1}}{u_n} \right| < 1 \Rightarrow \lim_{n \rightarrow \infty} \left| \frac{2(x+1)^n}{2(x+1)^{n-1}} \right| < 1 \Rightarrow |x+1| \lim_{n \rightarrow \infty} 1 = |x+1| < 1 \Rightarrow -2 < x < 0$;

For the series $\sum_{n=1}^{\infty} (-1)^n(x+1)^{n-1}$: $\lim_{n \rightarrow \infty} \left| \frac{u_{n+1}}{u_n} \right| < 1 \Rightarrow \lim_{n \rightarrow \infty} \left| \frac{(-1)^{n+1}(x+1)^n}{(-1)^n(x+1)^{n-1}} \right| < 1 \Rightarrow |x+1| \lim_{n \rightarrow \infty} 1 = |x+1| < 1$

$\Rightarrow -2 < x < 0$; when $x = -2$ we have $\sum_{n=1}^{\infty} (2 + (-1)^n)(-1)^{n-1}$, a divergent series; when $x = 0$ we have

$\sum_{n=1}^{\infty} (2 + (-1)^n)$, a divergent series

- (a) the radius is 1; the interval of convergence is $-2 < x < 0$
 (b) the interval of absolute convergence is $-2 < x < 0$
 (c) there are no values for which the series converges conditionally

$$22. \lim_{n \rightarrow \infty} \left| \frac{u_{n+1}}{u_n} \right| < 1 \Rightarrow \lim_{n \rightarrow \infty} \left| \frac{(-1)^{n+1} 3^{2n+2} (x-2)^{n+1}}{3(n+1)} \cdot \frac{3n}{(-1)^n 3^{2n} (x-2)^n} \right| < 1 \Rightarrow |x-2| \lim_{n \rightarrow \infty} \frac{9n}{n+1} = 9|x-2| < 1 \Rightarrow \frac{17}{9} < x < \frac{19}{9};$$

when $x = \frac{17}{9}$ we have $\sum_{n=1}^{\infty} \frac{(-1)^n 3^{2n}}{3n} \left(-\frac{1}{9}\right)^n = \sum_{n=1}^{\infty} \frac{1}{3n}$, a divergent series; when $x = \frac{19}{9}$ we have

$\sum_{n=1}^{\infty} \frac{(-1)^n 3^{2n}}{3n} \left(\frac{1}{9}\right)^n = \sum_{n=1}^{\infty} \frac{(-1)^n}{3n}$, a conditionally convergent series.

- (a) the radius is $\frac{1}{9}$; the interval of convergence is $\frac{17}{9} < x \leq \frac{19}{9}$
 (b) the interval of absolute convergence is $\frac{17}{9} < x < \frac{19}{9}$
 (c) the series converges conditionally at $x = \frac{19}{9}$

$$23. \lim_{n \rightarrow \infty} \left| \frac{u_{n+1}}{u_n} \right| < 1 \Rightarrow \lim_{n \rightarrow \infty} \left| \frac{\left(1 + \frac{1}{n+1}\right)^{n+1} x^{n+1}}{\left(1 + \frac{1}{n}\right)^n x^n} \right| < 1 \Rightarrow |x| \left(\frac{\lim_{t \rightarrow \infty} \left(1 + \frac{1}{t}\right)^t}{\lim_{n \rightarrow \infty} \left(1 + \frac{1}{n}\right)^n} \right) < 1 \Rightarrow |x| \left(\frac{e}{e} \right) < 1 \Rightarrow |x| < 1 \Rightarrow -1 < x < 1; \text{ when } x = -1$$

we have $\sum_{n=1}^{\infty} (-1)^n \left(1 + \frac{1}{n}\right)^n$, a divergent series by the n th-Term Test since $\lim_{n \rightarrow \infty} \left(1 + \frac{1}{n}\right)^n = e \neq 0$; when $x = 1$

we have $\sum_{n=1}^{\infty} \left(1 + \frac{1}{n}\right)^n$, a divergent series

- (a) the radius is 1; the interval of convergence is $-1 < x < 1$
 (b) the interval of absolute convergence is $-1 < x < 1$
 (c) there are no values for which the series converges conditionally

$$24. \lim_{n \rightarrow \infty} \left| \frac{u_{n+1}}{u_n} \right| < 1 \Rightarrow \lim_{n \rightarrow \infty} \left| \frac{\ln(n+1)x^{n+1}}{x^n \ln n} \right| < 1 \Rightarrow |x| \lim_{n \rightarrow \infty} \left| \frac{\left(\frac{1}{n+1}\right)}{\left(\frac{1}{n}\right)} \right| < 1 \Rightarrow |x| \lim_{n \rightarrow \infty} \left(\frac{n}{n+1}\right) < 1 \Rightarrow |x| < 1 \Rightarrow -1 < x < 1;$$

when $x = -1$ we have $\sum_{n=1}^{\infty} (-1)^n \ln n$, a divergent series by the n th-Term Test since $\lim_{n \rightarrow \infty} \ln n \neq 0$; when $x = 1$

we have $\sum_{n=1}^{\infty} \ln n$, a divergent series

- (a) the radius is 1; the interval of convergence is $-1 < x < 1$
 (b) the interval of absolute convergence is $-1 < x < 1$
 (c) there are no values for which the series converges conditionally

25. $\lim_{n \rightarrow \infty} \left| \frac{u_{n+1}}{u_n} \right| < 1 \Rightarrow \lim_{n \rightarrow \infty} \left| \frac{(n+1)^{n+1} x^{n+1}}{n^n x^n} \right| < 1 \Rightarrow |x| \left(\lim_{n \rightarrow \infty} \left(1 + \frac{1}{n} \right)^n \right) \left(\lim_{n \rightarrow \infty} (n+1) \right) < 1 \Rightarrow e|x| \lim_{n \rightarrow \infty} (n+1) < 1 \Rightarrow$ only $x = 0$ satisfies this inequality
 (a) the radius is 0; the series converges only for $x = 0$
 (b) the series converges absolutely only for $x = 0$
 (c) there are no values for which the series converges conditionally

26. $\lim_{n \rightarrow \infty} \left| \frac{u_{n+1}}{u_n} \right| < 1 \Rightarrow \lim_{n \rightarrow \infty} \left| \frac{(n+1)!(x-4)^{n+1}}{n!(x-4)^n} \right| < 1 \Rightarrow |x-4| \lim_{n \rightarrow \infty} (n+1) < 1 \Rightarrow$ only $x = 4$ satisfies this inequality
 (a) the radius is 0; the series converges only for $x = 4$
 (b) the series converges absolutely only for $x = 4$
 (c) there are no values for which the series converges conditionally

27. $\lim_{n \rightarrow \infty} \left| \frac{u_{n+1}}{u_n} \right| < 1 \Rightarrow \lim_{n \rightarrow \infty} \left| \frac{(x+2)^{n+1}}{(n+1)2^{n+1}} \cdot \frac{n2^n}{(x+2)^n} \right| < 1 \Rightarrow \frac{|x+2|}{2} \lim_{n \rightarrow \infty} \left(\frac{n}{n+1} \right) < 1 \Rightarrow \frac{|x+2|}{2} < 1 \Rightarrow |x+2| < 2 \Rightarrow -2 < x+2 < 2$
 $\Rightarrow -4 < x < 0$; when $x = -4$ we have $\sum_{n=1}^{\infty} \frac{-1}{n}$, a divergent series; when $x = 0$ we have $\sum_{n=1}^{\infty} \frac{(-1)^{n+1}}{n}$, the alternating harmonic series which converges conditionally
 (a) the radius is 2; the interval of convergence is $-4 < x \leq 0$
 (b) the interval of absolute convergence is $-4 < x < 0$
 (c) the series converges conditionally at $x = 0$

28. $\lim_{n \rightarrow \infty} \left| \frac{u_{n+1}}{u_n} \right| < 1 \Rightarrow \lim_{n \rightarrow \infty} \left| \frac{(-2)^{n+1}(n+2)(x-1)^{n+1}}{(-2)^n(n+1)(x-1)^n} \right| < 1 \Rightarrow 2|x-1| \lim_{n \rightarrow \infty} \left(\frac{n+2}{n+1} \right) < 1 \Rightarrow 2|x-1| < 1 \Rightarrow |x-1| < \frac{1}{2}$
 $\Rightarrow -\frac{1}{2} < x-1 < \frac{1}{2} \Rightarrow \frac{1}{2} < x < \frac{3}{2}$; when $x = \frac{1}{2}$ we have $\sum_{n=1}^{\infty} (n+1)$, a divergent series; when $x = \frac{3}{2}$ we have $\sum_{n=1}^{\infty} (-1)^n (n+1)$, a divergent series
 (a) the radius is $\frac{1}{2}$; the interval of convergence is $\frac{1}{2} < x < \frac{3}{2}$
 (b) the interval of absolute convergence is $\frac{1}{2} < x < \frac{3}{2}$
 (c) there are no values for which the series converges conditionally

29. $\lim_{n \rightarrow \infty} \left| \frac{u_{n+1}}{u_n} \right| < 1 \Rightarrow \lim_{n \rightarrow \infty} \left| \frac{x^{n+1}}{(n+1)(\ln(n+1))^2} \cdot \frac{n(\ln n)^2}{x^n} \right| < 1 \Rightarrow |x| \left(\lim_{n \rightarrow \infty} \frac{n}{n+1} \right) \left(\lim_{n \rightarrow \infty} \frac{\ln n}{\ln(n+1)} \right)^2 < 1$
 $\Rightarrow |x| \left(1 \left(\lim_{n \rightarrow \infty} \left(\frac{1/n}{1/(n+1)} \right) \right)^2 \right) < 1 \Rightarrow |x| \left(\lim_{n \rightarrow \infty} \frac{n+1}{n} \right)^2 < 1 \Rightarrow |x| < 1 \Rightarrow -1 < x < 1$; when $x = -1$ we have $\sum_{n=1}^{\infty} \frac{(-1)^n}{n(\ln n)^2}$ which converges absolutely; when $x = 1$ we have $\sum_{n=1}^{\infty} \frac{1}{n(\ln n)^2}$ which converges
 (a) the radius is 1; the interval of convergence is $-1 \leq x \leq 1$
 (b) the interval of absolute convergence is $-1 \leq x \leq 1$
 (c) there are no values for which the series converges conditionally

$$30. \lim_{n \rightarrow \infty} \left| \frac{u_{n+1}}{u_n} \right| < 1 \Rightarrow \lim_{n \rightarrow \infty} \left| \frac{x^{n+1}}{(n+1) \ln(n+1)} \cdot \frac{n \ln(n)}{x^n} \right| < 1 \Rightarrow |x| \left(\lim_{n \rightarrow \infty} \frac{n}{n+1} \right) \left(\lim_{n \rightarrow \infty} \frac{\ln(n)}{\ln(n+1)} \right) < 1 \Rightarrow |x|(1)(1) < 1 \Rightarrow |x| < 1$$

$$\Rightarrow -1 < x < 1; \text{ when } x = -1 \text{ we have } \sum_{n=2}^{\infty} \frac{(-1)^n}{n \ln n}, \text{ a convergent alternating series; when } x = 1 \text{ we have } \sum_{n=2}^{\infty} \frac{1}{n \ln n}$$

which diverges by Exercise 56(a) Section 10.3

(a) the radius is 1; the interval of convergence is $-1 \leq x < 1$

(b) the interval of absolute convergence is $-1 < x < 1$

(c) the series converges conditionally at $x = -1$

$$31. \lim_{n \rightarrow \infty} \left| \frac{u_{n+1}}{u_n} \right| < 1 \Rightarrow \lim_{n \rightarrow \infty} \left| \frac{(4x-5)^{2n+3}}{(n+1)^{3/2}} \cdot \frac{n^{3/2}}{(4x-5)^{2n+1}} \right| < 1 \Rightarrow (4x-5)^2 \left(\lim_{n \rightarrow \infty} \frac{n}{n+1} \right)^{3/2} < 1 \Rightarrow (4x-5)^2 < 1 \Rightarrow |4x-5| < 1$$

$$\Rightarrow -1 < 4x-5 < 1 \Rightarrow 1 < x < \frac{3}{2}; \text{ when } x = 1 \text{ we have } \sum_{n=1}^{\infty} \frac{(-1)^{2n+1}}{n^{3/2}} = \sum_{n=1}^{\infty} \frac{-1}{n^{3/2}} \text{ which is absolutely convergent;}$$

when $x = \frac{3}{2}$ we have $\sum_{n=1}^{\infty} \frac{(1)^{2n+1}}{n^{3/2}}$, a convergent p -series

(a) the radius is $\frac{1}{4}$; the interval of convergence is $1 \leq x \leq \frac{3}{2}$

(b) the interval of absolute convergence is $1 \leq x \leq \frac{3}{2}$

(c) there are no values for which the series converges conditionally

$$32. \lim_{n \rightarrow \infty} \left| \frac{u_{n+1}}{u_n} \right| < 1 \Rightarrow \lim_{n \rightarrow \infty} \left| \frac{(3x+1)^{n+2}}{2n+4} \cdot \frac{2n+2}{(3x+1)^{n+1}} \right| < 1 \Rightarrow |3x+1| \lim_{n \rightarrow \infty} \left(\frac{2n+2}{2n+4} \right) < 1 \Rightarrow |3x+1| < 1 \Rightarrow -1 < 3x+1 < 1$$

$$\Rightarrow -\frac{2}{3} < x < 0; \text{ when } x = -\frac{2}{3} \text{ we have } \sum_{n=1}^{\infty} \frac{(-1)^{n+1}}{2n+1}, \text{ a conditionally convergent series; when } x = 0$$

we have $\sum_{n=1}^{\infty} \frac{(1)^{n+1}}{2n+1} = \sum_{n=1}^{\infty} \frac{1}{2n+1}$, a divergent series

(a) the radius is $\frac{1}{3}$; the interval of convergence is $-\frac{2}{3} \leq x < 0$

(b) the interval of absolute convergence is $-\frac{2}{3} < x < 0$

(c) the series converges conditionally at $x = -\frac{2}{3}$

$$33. \lim_{n \rightarrow \infty} \left| \frac{u_{n+1}}{u_n} \right| < 1 \Rightarrow \lim_{n \rightarrow \infty} \left| \frac{x^{n+1}}{2 \cdot 4 \cdot 6 \cdots (2n)(2(n+1))} \cdot \frac{2 \cdot 4 \cdot 6 \cdots (2n)}{x^n} \right| < 1 \Rightarrow |x| \lim_{n \rightarrow \infty} \left(\frac{1}{2n+2} \right) < 1 \text{ for all } x$$

(a) the radius is ∞ ; the series converges for all x

(b) the series converges absolutely for all x

(c) there are no values for which the series converges conditionally

$$34. \lim_{n \rightarrow \infty} \left| \frac{u_{n+1}}{u_n} \right| < 1 \Rightarrow \lim_{n \rightarrow \infty} \left| \frac{3 \cdot 5 \cdot 7 \cdots (2n+1)(2(n+1)+1)x^{n+2}}{(n+1)^2 2^{n+1}} \cdot \frac{n^2 2^n}{3 \cdot 5 \cdot 7 \cdots (2n+1)x^{n+1}} \right| < 1 \Rightarrow |x| \lim_{n \rightarrow \infty} \left(\frac{(2n+3)n^2}{2(n+1)^2} \right) < 1$$

\Rightarrow only $x = 0$ satisfies this inequality

(a) the radius is 0; the series converges only for $x = 0$

(b) the series converges absolutely only for $x = 0$

(c) there are no values for which the series converges conditionally

35. For the series $\sum_{n=1}^{\infty} \frac{1+2+\dots+n}{1^2+2^2+\dots+n^2} x^n$, recall $1+2+\dots+n = \frac{n(n+1)}{2}$ and $1^2+2^2+\dots+n^2 = \frac{n(n+1)(2n+1)}{6}$ so that we can rewrite the series as $\sum_{n=1}^{\infty} \left(\frac{\frac{n(n+1)}{2}}{\frac{n(n+1)(2n+1)}{6}} \right) x^n = \sum_{n=1}^{\infty} \left(\frac{3}{2n+1} \right) x^n$; then $\lim_{n \rightarrow \infty} \left| \frac{u_{n+1}}{u_n} \right| < 1 \Rightarrow \lim_{n \rightarrow \infty} \left| \frac{3x^{n+1}}{(2(n+1)+1)} \cdot \frac{(2n+1)}{3x^n} \right| < 1 \Rightarrow |x| \lim_{n \rightarrow \infty} \left| \frac{(2n+1)}{(2n+3)} \right| < 1 \Rightarrow |x| < 1 \Rightarrow -1 < x < 1$; when $x = -1$ we have $\sum_{n=1}^{\infty} \left(\frac{3}{2n+1} \right) (-1)^n$, a conditionally convergent series; when $x = 1$ we have $\sum_{n=1}^{\infty} \left(\frac{3}{2n+1} \right)$, a divergent series.

- (a) the radius is 1; the interval of convergence is $-1 \leq x < 1$
- (b) the interval of absolute convergence is $-1 < x < 1$
- (c) the series converges conditionally at $x = -1$

36. For the series $\sum_{n=1}^{\infty} (\sqrt{n+1} - \sqrt{n})(x-3)^n$, note that $\sqrt{n+1} - \sqrt{n} = \frac{\sqrt{n+1} - \sqrt{n}}{1} \cdot \frac{\sqrt{n+1} + \sqrt{n}}{\sqrt{n+1} + \sqrt{n}} = \frac{1}{\sqrt{n+1} + \sqrt{n}}$ so that we can rewrite the series as $\sum_{n=1}^{\infty} \frac{(x-3)^n}{\sqrt{n+1} + \sqrt{n}}$; then $\lim_{n \rightarrow \infty} \left| \frac{u_{n+1}}{u_n} \right| < 1 \Rightarrow \lim_{n \rightarrow \infty} \left| \frac{(x-3)^{n+1}}{\sqrt{n+2} + \sqrt{n+1}} \cdot \frac{\sqrt{n+1} + \sqrt{n}}{(x-3)^n} \right| < 1 \Rightarrow |x-3| \lim_{n \rightarrow \infty} \frac{\sqrt{n+1} + \sqrt{n}}{\sqrt{n+2} + \sqrt{n+1}} < 1 \Rightarrow |x-3| < 1 \Rightarrow 2 < x < 4$; when $x = 2$ we have $\sum_{n=1}^{\infty} \frac{(-1)^n}{\sqrt{n+1} + \sqrt{n}}$, a conditionally convergent series; when $x = 4$ we have $\sum_{n=1}^{\infty} \frac{1}{\sqrt{n+1} + \sqrt{n}}$, a divergent series;

- (a) the radius is 1; the interval of convergence is $2 \leq x < 4$
- (b) the interval of absolute convergence is $2 < x < 4$
- (c) the series converges conditionally at $x = 2$

37. $\lim_{n \rightarrow \infty} \left| \frac{u_{n+1}}{u_n} \right| < 1 \Rightarrow \lim_{n \rightarrow \infty} \left| \frac{(n+1)! x^{n+1}}{3 \cdot 6 \cdot 9 \cdots (3n)(3(n+1))} \cdot \frac{3 \cdot 6 \cdot 9 \cdots (3n)}{n! x^n} \right| < 1 \Rightarrow |x| \lim_{n \rightarrow \infty} \left| \frac{(n+1)}{3(n+1)} \right| < 1 \Rightarrow \frac{|x|}{3} < 1 \Rightarrow |x| < 3 \Rightarrow R = 3$

38. $\lim_{n \rightarrow \infty} \left| \frac{u_{n+1}}{u_n} \right| < 1 \Rightarrow \lim_{n \rightarrow \infty} \left| \frac{(2 \cdot 4 \cdot 6 \cdots (2n)(2(n+1)))^2 x^{n+1}}{(2 \cdot 5 \cdot 8 \cdots (3n-1)(3(n+1)-1))^2} \cdot \frac{(2 \cdot 5 \cdot 8 \cdots (3n-1))^2}{(2 \cdot 4 \cdot 6 \cdots (2n))^2 x^n} \right| < 1 \Rightarrow |x| \lim_{n \rightarrow \infty} \left| \frac{(2n+2)^2}{(3n+2)^2} \right| < 1 \Rightarrow \frac{4|x|}{9} < 1 \Rightarrow |x| < \frac{9}{4} \Rightarrow R = \frac{9}{4}$

39. $\lim_{n \rightarrow \infty} \left| \frac{u_{n+1}}{u_n} \right| < 1 \Rightarrow \lim_{n \rightarrow \infty} \left| \frac{((n+1)!)^2 x^{n+1}}{2^{n+1} (2(n+1))!} \cdot \frac{2^n (2n)!}{(n!)^2 x^n} \right| < 1 \Rightarrow |x| \lim_{n \rightarrow \infty} \left| \frac{(n+1)^2}{2(2n+2)(2n+1)} \right| < 1 \Rightarrow \frac{|x|}{8} < 1 \Rightarrow |x| < 8 \Rightarrow R = 8$

40. $\lim_{n \rightarrow \infty} \sqrt[n]{u_n} < 1 \Rightarrow \lim_{n \rightarrow \infty} \sqrt[n]{\left(\frac{n}{n+1} \right)^{n^2} x^n} < 1 \Rightarrow |x| \lim_{n \rightarrow \infty} \left(\frac{n}{n+1} \right)^n < 1 \Rightarrow |x| e^{-1} < 1 \Rightarrow |x| < e \Rightarrow R = e$

41. $\lim_{n \rightarrow \infty} \left| \frac{u_{n+1}}{u_n} \right| < 1 \Rightarrow \lim_{n \rightarrow \infty} \left| \frac{3^{n+1} x^{n+1}}{3^n x^n} \right| < 1 \Rightarrow |x| \lim_{n \rightarrow \infty} 3 < 1 \Rightarrow |x| < \frac{1}{3} \Rightarrow -\frac{1}{3} < x < \frac{1}{3}$; at $x = -\frac{1}{3}$ we have $\sum_{n=0}^{\infty} 3^n \left(-\frac{1}{3}\right)^n = \sum_{n=0}^{\infty} (-1)^n$, which diverges; at $x = \frac{1}{3}$ we have $\sum_{n=0}^{\infty} 3^n \left(\frac{1}{3}\right)^n = \sum_{n=0}^{\infty} 1$, which diverges. The series $\sum_{n=0}^{\infty} 3^n x^n = \sum_{n=0}^{\infty} (3x)^n$, is a convergent geometric series when $-\frac{1}{3} < x < \frac{1}{3}$ and the sum is $\frac{1}{1-3x}$.

42. $\lim_{n \rightarrow \infty} \left| \frac{u_{n+1}}{u_n} \right| < 1 \Rightarrow \lim_{n \rightarrow \infty} \left| \frac{(e^x - 4)^{n+1}}{(e^x - 4)^n} \right| < 1 \Rightarrow |e^x - 4| \lim_{n \rightarrow \infty} 1 < 1 \Rightarrow |e^x - 4| < 1 \Rightarrow 3 < e^x < 5 \Rightarrow \ln 3 < x < \ln 5$;
 at $x = \ln 3$ we have $\sum_{n=0}^{\infty} (e^{\ln 3} - 4)^n = \sum_{n=0}^{\infty} (-1)^n$, which diverges; at $x = \ln 5$ we have $\sum_{n=0}^{\infty} (e^{\ln 5} - 4)^n = \sum_{n=0}^{\infty} 1$, which diverges. The series $\sum_{n=0}^{\infty} (e^x - 4)^n$ is a convergent geometric series when $\ln 3 < x < \ln 5$ and the sum is $\frac{1}{1 - (e^x - 4)} = \frac{1}{5 - e^x}$.

43. $\lim_{n \rightarrow \infty} \left| \frac{u_{n+1}}{u_n} \right| < 1 \Rightarrow \lim_{n \rightarrow \infty} \left| \frac{(x-1)^{2n+2}}{4^{n+1}} \cdot \frac{4^n}{(x-1)^{2n}} \right| < 1 \Rightarrow \frac{(x-1)^2}{4} \lim_{n \rightarrow \infty} |1| < 1 \Rightarrow (x-1)^2 < 4 \Rightarrow |x-1| < 2 \Rightarrow -2 < x-1 < 2$
 $\Rightarrow -1 < x < 3$; at $x = -1$ we have $\sum_{n=0}^{\infty} \frac{(-2)^{2n}}{4^n} = \sum_{n=0}^{\infty} \frac{4^n}{4^n} = \sum_{n=0}^{\infty} 1$, which diverges; at $x = 3$ we have $\sum_{n=0}^{\infty} \frac{2^{2n}}{4^n}$
 $= \sum_{n=0}^{\infty} \frac{4^n}{4^n} = \sum_{n=0}^{\infty} 1$, a divergent series; the interval of convergence is $-1 < x < 3$; the series $\sum_{n=0}^{\infty} \frac{(x-1)^{2n}}{4^n}$
 $= \sum_{n=0}^{\infty} \left(\left(\frac{x-1}{2} \right)^2 \right)^n$ is a convergent geometric series when $-1 < x < 3$ and sum is $\frac{1}{1 - \left(\frac{x-1}{2} \right)^2} = \frac{1}{\left[\frac{4 - (x-1)^2}{4} \right]} = \frac{4}{4 - x^2 + 2x - 1}$
 $= \frac{4}{3 + 2x - x^2}$

44. $\lim_{n \rightarrow \infty} \left| \frac{u_{n+1}}{u_n} \right| < 1 \Rightarrow \lim_{n \rightarrow \infty} \left| \frac{(x+1)^{2n+2}}{9^{n+1}} \cdot \frac{9^n}{(x+1)^{2n}} \right| < 1 \Rightarrow \frac{(x+1)^2}{9} \lim_{n \rightarrow \infty} |1| < 1 \Rightarrow (x+1)^2 < 9 \Rightarrow |x+1| < 3 \Rightarrow -3 < x+1 < 3$
 $\Rightarrow -4 < x < 2$; when $x = -4$ we have $\sum_{n=0}^{\infty} \frac{(-3)^{2n}}{9^n} = \sum_{n=0}^{\infty} 1$ which diverges; at $x = 2$ we have $\sum_{n=0}^{\infty} \frac{3^{2n}}{9^n} = \sum_{n=0}^{\infty} 1$
 which also diverges; the interval of convergence is $-4 < x < 2$; the series $\sum_{n=0}^{\infty} \frac{(x+1)^{2n}}{9^n} = \sum_{n=0}^{\infty} \left(\left(\frac{x+1}{3} \right)^2 \right)^n$ is a
 convergent geometric series when $-4 < x < 2$ and the sum is $\frac{1}{1 - \left(\frac{x+1}{3} \right)^2} = \frac{1}{\left[\frac{9 - (x+1)^2}{9} \right]} = \frac{9}{9 - x^2 - 2x - 1} = \frac{9}{8 - 2x - x^2}$

45. $\lim_{n \rightarrow \infty} \left| \frac{u_{n+1}}{u_n} \right| < 1 \Rightarrow \lim_{n \rightarrow \infty} \left| \frac{(\sqrt{x}-2)^{n+1}}{2^{n+1}} \cdot \frac{2^n}{(\sqrt{x}-2)^n} \right| < 1 \Rightarrow |\sqrt{x}-2| < 2 \Rightarrow -2 < \sqrt{x}-2 < 2 \Rightarrow 0 < \sqrt{x} < 4 \Rightarrow 0 < x < 16$;
 when $x = 0$ we have $\sum_{n=0}^{\infty} (-1)^n$, a divergent series; when $x = 16$ we have $\sum_{n=0}^{\infty} (1)^n$, a divergent series; the

interval of convergence is $0 < x < 16$; the series $\sum_{n=0}^{\infty} \left(\frac{\sqrt{x}-2}{2}\right)^n$ is a convergent geometric series when $0 < x < 16$

and its sum is $\frac{1}{1-\left(\frac{\sqrt{x}-2}{2}\right)} = \frac{1}{\left(\frac{2-\sqrt{x}+2}{2}\right)} = \frac{2}{4-\sqrt{x}}$

46. $\lim_{n \rightarrow \infty} \left| \frac{u_{n+1}}{u_n} \right| < 1 \Rightarrow \lim_{n \rightarrow \infty} \left| \frac{(\ln x)^{n+1}}{(\ln x)^n} \right| < 1 \Rightarrow |\ln x| < 1 \Rightarrow -1 < \ln x < 1 \Rightarrow e^{-1} < x < e$; when $x = e^{-1}$ or e we obtain the series $\sum_{n=0}^{\infty} 1^n$ and $\sum_{n=0}^{\infty} (-1)^n$ which both diverge; the interval of convergence is $e^{-1} < x < e$; $\sum_{n=0}^{\infty} (\ln x)^n = \frac{1}{1-\ln x}$ when $e^{-1} < x < e$

47. $\lim_{n \rightarrow \infty} \left| \frac{u_{n+1}}{u_n} \right| < 1 \Rightarrow \lim_{n \rightarrow \infty} \left| \left(\frac{x^2+1}{3}\right)^{n+1} \cdot \left(\frac{3}{x^2+1}\right)^n \right| < 1 \Rightarrow \frac{(x^2+1)}{3} \lim_{n \rightarrow \infty} |1| < 1 \Rightarrow \frac{x^2+1}{3} < 1 \Rightarrow x^2 < 2 \Rightarrow |x| < \sqrt{2}$

$\Rightarrow -\sqrt{2} < x < \sqrt{2}$; at $x = \pm\sqrt{2}$ we have $\sum_{n=0}^{\infty} (1)^n$ which diverges; the interval of convergence is

$-\sqrt{2} < x < \sqrt{2}$; the series $\sum_{n=0}^{\infty} \left(\frac{x^2+1}{3}\right)^n$ is a convergent geometric series when $-\sqrt{2} < x < \sqrt{2}$ and its sum is

$$\frac{1}{1-\left(\frac{x^2+1}{3}\right)} = \frac{1}{\left(\frac{3-x^2-1}{3}\right)} = \frac{3}{2-x^2}$$

48. $\lim_{n \rightarrow \infty} \left| \frac{u_{n+1}}{u_n} \right| < 1 \Rightarrow \lim_{n \rightarrow \infty} \left| \frac{(x^2-1)^{n+1}}{2^{n+1}} \cdot \frac{2^n}{(x^2+1)^n} \right| < 1 \Rightarrow |x^2-1| < 2 \Rightarrow -\sqrt{3} < x < \sqrt{3}$; when $x = \pm\sqrt{3}$ we have $\sum_{n=0}^{\infty} 1^n$,

a divergent series; the interval of convergence is $-\sqrt{3} < x < \sqrt{3}$; the series $\sum_{n=0}^{\infty} \left(\frac{x^2-1}{2}\right)^n$ is a convergent

geometric series when $-\sqrt{3} < x < \sqrt{3}$ and its sum is $\frac{1}{1-\left(\frac{x^2-1}{2}\right)} = \frac{1}{\left(\frac{2-(x^2-1)}{2}\right)} = \frac{2}{3-x^2}$

49. Writing $\frac{2}{x}$ as $\frac{2}{1-[-(x-1)]}$ we see that it can be written as the power

series $\sum_{n=0}^{\infty} 2[-(x-1)]^n = \sum_{n=0}^{\infty} 2(-1)^n(x-1)^n$. Since this is a geometric series with ratio $-(x-1)$ it will converge

for

$$|-(x-1)| < 1 \text{ or } 0 < x < 2.$$

50. (a) $f(x) = \frac{5}{3-x} = \frac{5/3}{1-(x/3)} = \sum_{n=0}^{\infty} \frac{5}{3} \left(\frac{x}{3}\right)^n$, which converges for $\left|\frac{x}{3}\right| < 1$ or $|x| < 3$.

- (b) $g(x) = \frac{3}{x-2} = \frac{-3/2}{1-(x/2)} = \sum_{n=0}^{\infty} -\frac{3}{2} \left(\frac{x}{2}\right)^n = \sum_{n=0}^{\infty} -\frac{3}{2^{n+1}} x^n$, which converges for $\left|\frac{x}{2}\right| < 1$ or $|x| < 2$.

51. $g(x) = \frac{3}{x-2} = \frac{3}{3-[-(x-5)]} = \frac{1}{1-\left[-\left(\frac{x-5}{3}\right)\right]} = \sum_{n=0}^{\infty} \left(-\frac{1}{3}\right)^n (x-5)^n$, which converges for

$$\left|\frac{x-5}{3}\right| < 1 \text{ or } 2 < x < 8.$$

52. (a) We can write the given series as $\frac{1}{2} \sum_{n=0}^{\infty} \left(\frac{x}{4}\right)^n$ which shows that the interval of convergence is $-4 < x < 4$.

(b) The function represented by the series in (a) is $\frac{2}{4-x}$ for $-4 < x < 4$. If we rewrite this function as

$$\frac{2}{1-(x-3)}$$

we can represent it by the geometric series $\sum_{n=0}^{\infty} 2(x-3)^n$ which will converge only for

$$|x-3| < 1 \text{ or } 2 < x < 4.$$

53. $\lim_{n \rightarrow \infty} \left| \frac{(x-3)^{n+1}}{2^{n+1}} \cdot \frac{2^n}{(x-3)^n} \right| < 1 \Rightarrow |x-3| < 2 \Rightarrow 1 < x < 5$; when $x=1$ we have $\sum_{n=0}^{\infty} (1)^n$ which diverges; when $x=5$

we have $\sum_{n=1}^{\infty} (-1)^n$ which also diverges; the interval of convergence is $1 < x < 5$; the sum of this convergent

geometric series is $\frac{1}{1+\left(\frac{x-3}{2}\right)} = \frac{2}{x-1}$. If $f(x) = 1 - \frac{1}{2}(x-3) + \frac{1}{4}(x-3)^2 + \dots + \left(-\frac{1}{2}\right)^n (x-3)^n + \dots = \frac{2}{x-1}$ then

$f'(x) = -\frac{1}{2} + \frac{1}{2}(x-3) + \dots + \left(-\frac{1}{2}\right)^n n(x-3)^{n-1} + \dots$ is convergent when $1 < x < 5$, and diverges when $x=1$ or

5. The sum for $f'(x)$ is $\frac{-2}{(x-1)^2}$, the derivative of $\frac{2}{x-1}$.

54. If $f(x) = 1 - \frac{1}{2}(x-3) + \frac{1}{4}(x-3)^2 + \dots + \left(-\frac{1}{2}\right)^n (x-3)^n + \dots = \frac{2}{x-1}$ then

$$\int f(x) dx = x - \frac{(x-3)^2}{4} + \frac{(x-3)^3}{12} + \dots + \left(-\frac{1}{2}\right)^n \frac{(x-3)^{n+1}}{n+1} + \dots$$

At $x=1$ the series $\sum_{n=1}^{\infty} \frac{-2}{n+1}$ diverges; at $x=5$ the

series $\sum_{n=1}^{\infty} \frac{(-1)^n 2}{n+1}$ converges. Therefore the interval of convergence is $1 < x \leq 5$ and the sum is

$$2 \ln|x-1| + (3 - \ln 4), \text{ since } \int \frac{2}{x-1} dx = 2 \ln|x-1| + C, \text{ where } C = 3 - \ln 4 \text{ when } x = 3.$$

55. (a) Differentiate the series for $\sin x$ to get $\cos x = 1 - \frac{3x^2}{3!} + \frac{5x^4}{5!} - \frac{7x^6}{7!} + \frac{9x^8}{9!} - \frac{11x^{10}}{11!} + \dots$

$= 1 - \frac{x^2}{2!} + \frac{x^4}{4!} - \frac{x^6}{6!} + \frac{x^8}{8!} - \frac{x^{10}}{10!} + \dots$. The series converges for all values of x since

$$\lim_{n \rightarrow \infty} \left| \frac{x^{2n+2}}{(2n+2)!} \cdot \frac{(2n)!}{x^{2n}} \right| = x^2 \lim_{n \rightarrow \infty} \left(\frac{1}{(2n+1)(2n+2)} \right) = 0 < 1 \text{ for all } x.$$

(b) $\sin 2x = 2x - \frac{2^3 x^3}{3!} + \frac{2^5 x^5}{5!} - \frac{2^7 x^7}{7!} + \frac{2^9 x^9}{9!} - \frac{2^{11} x^{11}}{11!} + \dots = 2x - \frac{8x^3}{3!} + \frac{32x^5}{5!} - \frac{128x^7}{7!} + \frac{512x^9}{9!} - \frac{2048x^{11}}{11!} + \dots$

(c) $2 \sin x \cos x = 2 \left[(0 \cdot 1) + (0 \cdot 0 + 1 \cdot 1)x + \left(0 \cdot \frac{-1}{2} + 1 \cdot 0 + 0 \cdot 1\right)x^2 + \left(0 \cdot 0 - 1 \cdot \frac{1}{2} + 0 \cdot 0 - 1 \cdot \frac{1}{3!}\right)x^3 \right.$
 $\left. + \left(0 \cdot \frac{1}{4!} + 1 \cdot 0 - 0 \cdot \frac{1}{2} - 0 \cdot \frac{1}{3!} + 0 \cdot 1\right)x^4 + \left(0 \cdot 0 + 1 \cdot \frac{1}{4!} + 0 \cdot 0 + \frac{1}{2} \cdot \frac{1}{3!} + 0 \cdot 0 + 1 \cdot \frac{1}{5!}\right)x^5 \right]$

$$\begin{aligned}
 & + \left(0 \cdot \frac{1}{6!} + 1 \cdot 0 + 0 \cdot \frac{1}{4!} + 0 \cdot \frac{1}{3!} + 0 \cdot \frac{1}{2} + 0 \cdot \frac{1}{5!} + 0 \cdot 1 \right) x^6 + \dots \Big] = 2 \left[x - \frac{4x^3}{3!} + \frac{16x^5}{5!} - \dots \right] \\
 & = 2x - \frac{2^3 x^3}{3!} + \frac{2^5 x^5}{5!} - \frac{2^7 x^7}{7!} + \frac{2^9 x^9}{9!} - \frac{2^{11} x^{11}}{11!} + \dots
 \end{aligned}$$

56. (a) $\frac{d}{dx}(e^x) = 1 + \frac{2x}{2!} + \frac{3x^2}{3!} + \frac{4x^3}{4!} + \frac{5x^4}{5!} + \dots = 1 + x + \frac{x^2}{2!} + \frac{x^3}{3!} + \frac{x^4}{4!} + \dots = e^x$; thus the derivative of e^x is e^x itself

(b) $\int e^x dx = e^x + C = x + \frac{x^2}{2} + \frac{x^3}{3!} + \frac{x^4}{4!} + \frac{x^5}{5!} + \dots + C$, which is the general antiderivative of e^x

(c) $e^{-x} = 1 - x + \frac{x^2}{2!} - \frac{x^3}{3!} + \frac{x^4}{4!} - \frac{x^5}{5!} + \dots$;

$$\begin{aligned}
 e^{-x} \cdot e^x & = 1 \cdot 1 + (1 \cdot 1 - 1 \cdot 1)x + \left(1 \cdot \frac{1}{2!} - 1 \cdot 1 + \frac{1}{2!} \cdot 1 \right) x^2 + \left(1 \cdot \frac{1}{3!} - 1 \cdot \frac{1}{2!} + \frac{1}{2!} \cdot 1 - \frac{1}{3!} \cdot 1 \right) x^3 \\
 & \quad + \left(1 \cdot \frac{1}{4!} - 1 \cdot \frac{1}{3!} + \frac{1}{2!} \cdot \frac{1}{2!} - \frac{1}{3!} \cdot 1 + \frac{1}{4!} \cdot 1 \right) x^4 + \left(1 \cdot \frac{1}{5!} - 1 \cdot \frac{1}{4!} + \frac{1}{2!} \cdot \frac{1}{3!} - \frac{1}{3!} \cdot \frac{1}{2!} + \frac{1}{4!} \cdot 1 - \frac{1}{5!} \cdot 1 \right) x^5 + \dots \\
 & = 1 + 0 + 0 + 0 + 0 + 0 + \dots
 \end{aligned}$$

57. (a) $\ln|\sec x| + C = \int \tan x dx = \int \left(x + \frac{x^3}{3} + \frac{2x^5}{15} + \frac{17x^7}{315} + \frac{62x^9}{2835} + \dots \right) dx = \frac{x^2}{2} + \frac{x^4}{12} + \frac{x^6}{45} + \frac{17x^8}{2520} + \frac{31x^{10}}{14,175} + \dots + C$;

$$x = 0 \Rightarrow C = 0 \Rightarrow \ln|\sec x| = \frac{x^2}{2} + \frac{x^4}{12} + \frac{x^6}{45} + \frac{17x^8}{2520} + \frac{31x^{10}}{14,175} + \dots, \text{ converges when } -\frac{\pi}{2} < x < \frac{\pi}{2}$$

(b) $\sec^2 x = \frac{d(\tan x)}{dx} = \frac{d}{dx} \left(x + \frac{x^3}{3} + \frac{2x^5}{15} + \frac{17x^7}{315} + \frac{62x^9}{2835} + \dots \right) = 1 + x^2 + \frac{2x^4}{3} + \frac{17x^6}{45} + \frac{62x^8}{315} + \dots$, converges when $-\frac{\pi}{2} < x < \frac{\pi}{2}$

(c) $\sec^2 x = (\sec x)(\sec x) = \left(1 + \frac{x^2}{2} + \frac{5x^4}{24} + \frac{61x^6}{720} + \dots \right) \left(1 + \frac{x^2}{2} + \frac{5x^4}{24} + \frac{61x^6}{720} + \dots \right)$
 $= 1 + \left(\frac{1}{2} + \frac{1}{2} \right) x^2 + \left(\frac{5}{24} + \frac{1}{4} + \frac{5}{24} \right) x^4 + \left(\frac{61}{720} + \frac{5}{48} + \frac{5}{48} + \frac{61}{720} \right) x^6 + \dots = 1 + x^2 + \frac{2x^4}{3} + \frac{17x^6}{45} + \frac{62x^8}{315} + \dots$,
 $-\frac{\pi}{2} < x < \frac{\pi}{2}$

58. (a) $\ln|\sec x + \tan x| + C = \int \sec x dx = \int \left(1 + \frac{x^2}{2} + \frac{5x^4}{24} + \frac{61x^6}{720} + \dots \right) dx = x + \frac{x^3}{6} + \frac{x^5}{24} + \frac{61x^7}{5040} + \frac{277x^9}{72,576} + \dots + C$;

$$x = 0 \Rightarrow C = 0 \Rightarrow \ln|\sec x + \tan x| = x + \frac{x^3}{6} + \frac{x^5}{24} + \frac{61x^7}{5040} + \frac{277x^9}{72,576} + \dots, \text{ converges when } -\frac{\pi}{2} < x < \frac{\pi}{2}$$

(b) $\sec x \tan x = \frac{d(\sec x)}{dx} = \frac{d}{dx} \left(1 + \frac{x^2}{2} + \frac{5x^4}{24} + \frac{61x^6}{720} + \dots \right) = x + \frac{5x^3}{6} + \frac{61x^5}{120} + \frac{277x^7}{1008} + \dots$, converges when $-\frac{\pi}{2} < x < \frac{\pi}{2}$

(c) $(\sec x)(\tan x) = \left(1 + \frac{x^2}{2} + \frac{5x^4}{24} + \frac{61x^6}{720} + \dots \right) \left(x + \frac{x^3}{3} + \frac{2x^5}{15} + \frac{17x^7}{315} + \dots \right)$
 $= x + \left(\frac{1}{3} + \frac{1}{2} \right) x^3 + \left(\frac{2}{15} + \frac{1}{6} + \frac{5}{24} \right) x^5 + \left(\frac{17}{315} + \frac{1}{15} + \frac{5}{72} + \frac{61}{720} \right) x^7 + \dots = x + \frac{5x^3}{6} + \frac{61x^5}{120} + \frac{277x^7}{1008} + \dots$,
 $-\frac{\pi}{2} < x < \frac{\pi}{2}$

59. (a) If $f(x) = \sum_{n=0}^{\infty} a_n x^n$, then $f^{(k)}(x) = \sum_{n=k}^{\infty} n(n-1)(n-2)\dots(n-(k-1)) a_n x^{n-k}$ and $f^{(k)}(0) = k! a_k$

$$\Rightarrow a_k = \frac{f^{(k)}(0)}{k!}; \text{ likewise if } f(x) = \sum_{n=0}^{\infty} b_n x^n, \text{ then } b_k = \frac{f^{(k)}(0)}{k!} \Rightarrow a_k = b_k \text{ for every nonnegative integer } k$$

(b) If $f(x) = \sum_{n=0}^{\infty} a_n x^n = 0$ for all x , then $f^{(k)}(x) = 0$ for all $x \Rightarrow$ from part (a) that $a_k = 0$ for every nonnegative integer k

10.8 TAYLOR AND MACLAURIN SERIES

- $f(x) = e^{2x}$, $f'(x) = 2e^{2x}$, $f''(x) = 4e^{2x}$, $f'''(x) = 8e^{2x}$; $f(0) = e^{2(0)} = 1$, $f'(0) = 2$, $f''(0) = 4$, $f'''(0) = 8$
 $\Rightarrow P_0(x) = 1$, $P_1(x) = 1 + 2x$, $P_2(x) = 1 + 2x + 2x^2$, $P_3(x) = 1 + 2x + 2x^2 + \frac{4}{3}x^3$
- $f(x) = \sin x$, $f'(x) = \cos x$, $f''(x) = -\sin x$, $f'''(x) = -\cos x$; $f(0) = \sin 0 = 0$, $f'(0) = 1$, $f''(0) = 0$, $f'''(0) = -1$
 $\Rightarrow P_0(x) = 0$, $P_1(x) = x$, $P_2(x) = x$, $P_3(x) = x - \frac{1}{6}x^3$
- $f(x) = \ln x$, $f'(x) = \frac{1}{x}$, $f''(x) = -\frac{1}{x^2}$, $f'''(x) = \frac{2}{x^3}$; $f(1) = \ln 1 = 0$, $f'(1) = 1$, $f''(1) = -1$, $f'''(1) = 2$
 $\Rightarrow P_0(x) = 0$, $P_1(x) = (x-1)$, $P_2(x) = (x-1) - \frac{1}{2}(x-1)^2$, $P_3(x) = (x-1) - \frac{1}{2}(x-1)^2 + \frac{1}{3}(x-1)^3$
- $f(x) = \ln(1+x)$, $f'(x) = \frac{1}{1+x} = (1+x)^{-1}$, $f''(x) = -(1+x)^{-2}$, $f'''(x) = 2(1+x)^{-3}$; $f(0) = \ln 1 = 0$, $f'(0) = \frac{1}{1} = 1$,
 $f''(0) = -(1)^{-2} = -1$, $f'''(0) = 2(1)^{-3} = 2 \Rightarrow P_0(x) = 0$, $P_1(x) = x$, $P_2(x) = x - \frac{x^2}{2}$, $P_3(x) = x - \frac{x^2}{2} + \frac{x^3}{3}$
- $f(x) = \frac{1}{x} = x^{-1}$, $f'(x) = -x^{-2}$, $f''(x) = 2x^{-3}$, $f'''(x) = -6x^{-4}$; $f(2) = \frac{1}{2}$, $f'(2) = -\frac{1}{4}$, $f''(2) = \frac{1}{4}$, $f'''(2) = -\frac{3}{8}$
 $\Rightarrow P_0(x) = \frac{1}{2}$, $P_1(x) = \frac{1}{2} - \frac{1}{4}(x-2)$, $P_2(x) = \frac{1}{2} - \frac{1}{4}(x-2) + \frac{1}{8}(x-2)^2$,
 $\Rightarrow P_3(x) = \frac{1}{2} - \frac{1}{4}(x-2) + \frac{1}{8}(x-2)^2 - \frac{1}{16}(x-2)^3$
- $f(x) = (x+2)^{-1}$, $f'(x) = -(x+2)^{-2}$, $f''(x) = 2(x+2)^{-3}$, $f'''(x) = -6(x+2)^{-4}$;
 $f(0) = (2)^{-1} = \frac{1}{2}$, $f'(0) = -(2)^{-2} = -\frac{1}{4}$, $f''(0) = 2(2)^{-3} = \frac{1}{4}$, $f'''(0) = -6(2)^{-4} = -\frac{3}{8}$
 $\Rightarrow P_0(x) = \frac{1}{2}$, $P_1(x) = \frac{1}{2} - \frac{x}{4}$, $P_2(x) = \frac{1}{2} - \frac{x}{4} + \frac{x^2}{8}$, $P_3(x) = \frac{1}{2} - \frac{x}{4} + \frac{x^2}{8} - \frac{x^3}{16}$
- $f(x) = \sin x$, $f'(x) = \cos x$, $f''(x) = -\sin x$, $f'''(x) = -\cos x$; $f\left(\frac{\pi}{4}\right) = \sin \frac{\pi}{4} = \frac{\sqrt{2}}{2}$, $f'\left(\frac{\pi}{4}\right) = \cos \frac{\pi}{4} = \frac{\sqrt{2}}{2}$,
 $f''\left(\frac{\pi}{4}\right) = -\sin \frac{\pi}{4} = -\frac{\sqrt{2}}{2}$, $f'''\left(\frac{\pi}{4}\right) = -\cos \frac{\pi}{4} = -\frac{\sqrt{2}}{2} \Rightarrow P_0 = \frac{\sqrt{2}}{2}$, $P_1(x) = \frac{\sqrt{2}}{2} + \frac{\sqrt{2}}{2}\left(x - \frac{\pi}{4}\right)$,
 $P_2(x) = \frac{\sqrt{2}}{2} + \frac{\sqrt{2}}{2}\left(x - \frac{\pi}{4}\right) - \frac{\sqrt{2}}{4}\left(x - \frac{\pi}{4}\right)^2$, $P_3(x) = \frac{\sqrt{2}}{2} + \frac{\sqrt{2}}{2}\left(x - \frac{\pi}{4}\right) - \frac{\sqrt{2}}{4}\left(x - \frac{\pi}{4}\right)^2 + \frac{\sqrt{2}}{12}\left(x - \frac{\pi}{4}\right)^3$
- $f(x) = \tan x$, $f'(x) = \sec^2 x$, $f''(x) = 2 \sec^2 x \tan x$, $f'''(x) = 2 \sec^4 x + 4 \sec^2 x \tan^2 x$; $f\left(\frac{\pi}{4}\right) = \tan \frac{\pi}{4} = 1$,
 $f'\left(\frac{\pi}{4}\right) = \sec^2\left(\frac{\pi}{4}\right) = 2$, $f''\left(\frac{\pi}{4}\right) = 2 \sec^2\left(\frac{\pi}{4}\right) \tan\left(\frac{\pi}{4}\right) = 4$, $f'''\left(\frac{\pi}{4}\right) = 2 \sec^4\left(\frac{\pi}{4}\right) + 4 \sec^2\left(\frac{\pi}{4}\right) \tan^2\left(\frac{\pi}{4}\right) = 16$
 $\Rightarrow P_0(x) = 1$, $P_1(x) = 1 + 2\left(x - \frac{\pi}{4}\right)$, $P_2(x) = 1 + 2\left(x - \frac{\pi}{4}\right) + 2\left(x - \frac{\pi}{4}\right)^2$,
 $P_3(x) = 1 + 2\left(x - \frac{\pi}{4}\right) + 2\left(x - \frac{\pi}{4}\right)^2 + \frac{8}{3}\left(x - \frac{\pi}{4}\right)^3$
- $f(x) = \sqrt{x} = x^{1/2}$, $f'(x) = \left(\frac{1}{2}\right)x^{-1/2}$, $f''(x) = \left(-\frac{1}{4}\right)x^{-3/2}$, $f'''(x) = \left(\frac{3}{8}\right)x^{-5/2}$; $f(4) = \sqrt{4} = 2$,
 $f'(4) = \left(\frac{1}{2}\right)4^{-1/2} = \frac{1}{4}$, $f''(4) = \left(-\frac{1}{4}\right)4^{-3/2} = -\frac{1}{32}$, $f'''(4) = \left(\frac{3}{8}\right)4^{-5/2} = \frac{3}{256} \Rightarrow P_0(x) = 2$, $P_1(x) = 2 + \frac{1}{4}(x-4)$,
 $P_2(x) = 2 + \frac{1}{4}(x-4) - \frac{1}{64}(x-4)^2$, $P_3(x) = 2 + \frac{1}{4}(x-4) - \frac{1}{64}(x-4)^2 + \frac{1}{512}(x-4)^3$

10. $f(x) = (1-x)^{1/2}$, $f'(x) = -\frac{1}{2}(1-x)^{-1/2}$, $f''(x) = -\frac{1}{4}(1-x)^{-3/2}$, $f'''(x) = -\frac{3}{8}(1-x)^{-5/2}$;
 $f(0) = (1)^{1/2} = 1$, $f'(0) = -\frac{1}{2}(1)^{-1/2} = -\frac{1}{2}$, $f''(0) = -\frac{1}{4}(1)^{-3/2} = -\frac{1}{4}$, $f'''(0) = -\frac{3}{8}(1)^{-5/2} = -\frac{3}{8}$
 $\Rightarrow P_0(x) = 1, P_1(x) = 1 - \frac{1}{2}x, P_2(x) = 1 - \frac{1}{2}x - \frac{1}{8}x^2, P_3(x) = 1 - \frac{1}{2}x - \frac{1}{8}x^2 - \frac{1}{16}x^3$
11. $f(x) = e^{-x}$, $f'(x) = -e^{-x}$, $f''(x) = e^{-x}$, $f'''(x) = -e^{-x} \Rightarrow \dots f^{(k)}(x) = (-1)^k e^{-x}$; $f(0) = e^{-0} = 1$, $f'(0) = -1$,
 $f''(0) = 1$, $f'''(0) = -1, \dots, f^{(k)}(0) = (-1)^k \Rightarrow e^{-x} = 1 - x + \frac{1}{2}x^2 - \frac{1}{6}x^3 + \dots = \sum_{n=0}^{\infty} \frac{(-1)^n}{n!} x^n$
12. $f(x) = x e^x$, $f'(x) = x e^x + e^x$, $f''(x) = x e^x + 2e^x$, $f'''(x) = x e^x + 3e^x \Rightarrow \dots f^{(k)}(x) = x e^x + k e^x$;
 $f(0) = (0)e^{(0)} = 0$, $f'(0) = 1$, $f''(0) = 2$, $f'''(0) = 3, \dots, f^{(k)}(0) = k \Rightarrow x + x^2 + \frac{1}{2}x^3 + \dots = \sum_{n=0}^{\infty} \frac{1}{(n-1)!} x^n$
13. $f(x) = (1+x)^{-1} \Rightarrow f'(x) = -(1+x)^{-2}$, $f''(x) = 2(1+x)^{-3}$, $f'''(x) = -3!(1+x)^{-4}$
 $\Rightarrow \dots f^{(k)}(x) = (-1)^k k!(1+x)^{-k-1}$; $f(0) = 1$, $f'(0) = -1$, $f''(0) = 2$, $f'''(0) = -3!, \dots, f^{(k)}(0) = (-1)^k k!$
 $\Rightarrow 1 - x + x^2 - x^3 + \dots = \sum_{n=0}^{\infty} (-x)^n = \sum_{n=0}^{\infty} (-1)^n x^n$
14. $f(x) = \frac{2+x}{1-x} \Rightarrow f'(x) = \frac{3}{(1-x)^2}$, $f''(x) = 6(1-x)^{-3}$, $f'''(x) = 18(1-x)^{-4} \Rightarrow \dots f^{(k)}(x) = 3(k!)(1-x)^{-k-1}$;
 $f(0) = 2$, $f'(0) = 3$, $f''(0) = 6$, $f'''(0) = 18, \dots, f^{(k)}(0) = 3(k!) \Rightarrow 2 + 3x + 3x^2 + 3x^3 + \dots = 2 + \sum_{n=1}^{\infty} 3x^n$
15. $\sin x = \sum_{n=0}^{\infty} \frac{(-1)^n x^{2n+1}}{(2n+1)!} \Rightarrow \sin 3x = \sum_{n=0}^{\infty} \frac{(-1)^n (3x)^{2n+1}}{(2n+1)!} = \sum_{n=0}^{\infty} \frac{(-1)^n 3^{2n+1} x^{2n+1}}{(2n+1)!} = 3x - \frac{3^3 x^3}{3!} + \frac{3^5 x^5}{5!} - \dots$
16. $\sin x = \sum_{n=0}^{\infty} \frac{(-1)^n x^{2n+1}}{(2n+1)!} \Rightarrow \sin \frac{x}{2} = \sum_{n=0}^{\infty} \frac{(-1)^n \left(\frac{x}{2}\right)^{2n+1}}{(2n+1)!} = \sum_{n=0}^{\infty} \frac{(-1)^n x^{2n+1}}{2^{2n+1} (2n+1)!} = \frac{x}{2} - \frac{x^3}{2^3 \cdot 3!} + \frac{x^5}{2^5 \cdot 5!} + \dots$
17. $7 \cos(-x) = 7 \cos x = 7 \sum_{n=0}^{\infty} \frac{(-1)^n x^{2n}}{(2n)!} = 7 - \frac{7x^2}{2!} + \frac{7x^4}{4!} - \frac{7x^6}{6!} + \dots$, since the cosine is an even function
18. $\cos x = \sum_{n=0}^{\infty} \frac{(-1)^n x^{2n}}{(2n)!} \Rightarrow 5 \cos \pi x = 5 \sum_{n=0}^{\infty} \frac{(-1)^n (\pi x)^{2n}}{(2n)!} = 5 - \frac{5\pi^2 x^2}{2!} + \frac{5\pi^4 x^4}{4!} - \frac{5\pi^6 x^6}{6!} + \dots$
19. $\cosh x = \frac{e^x + e^{-x}}{2} = \frac{1}{2} \left[\left(1 + x + \frac{x^2}{2!} + \frac{x^3}{3!} + \frac{x^4}{4!} + \dots \right) + \left(1 - x + \frac{x^2}{2!} - \frac{x^3}{3!} + \frac{x^4}{4!} - \dots \right) \right] = 1 + \frac{x^2}{2!} + \frac{x^4}{4!} + \frac{x^6}{6!} + \dots = \sum_{n=0}^{\infty} \frac{x^{2n}}{(2n)!}$
20. $\sinh x = \frac{e^x - e^{-x}}{2} = \frac{1}{2} \left[\left(1 + x + \frac{x^2}{2!} + \frac{x^3}{3!} + \frac{x^4}{4!} + \dots \right) - \left(1 - x + \frac{x^2}{2!} - \frac{x^3}{3!} + \frac{x^4}{4!} - \dots \right) \right] = x + \frac{x^3}{3!} + \frac{x^5}{5!} + \frac{x^6}{6!} + \dots = \sum_{n=0}^{\infty} \frac{x^{2n+1}}{(2n+1)!}$

21. $f(x) = x^4 - 2x^3 - 5x + 4 \Rightarrow f'(x) = 4x^3 - 6x^2 - 5, f''(x) = 12x^2 - 12x, f'''(x) = 24x - 12, f^{(4)}(x) = 24$
 $\Rightarrow f^{(n)}(x) = 0$ if $n \geq 5; f(0) = 4, f'(0) = -5, f''(0) = 0, f'''(0) = -12, f^{(4)}(0) = 24, f^{(n)}(0) = 0$ if $n \geq 5$
 $\Rightarrow x^4 - 2x^3 - 5x + 4 = 4 - 5x - \frac{12}{3!}x^3 + \frac{24}{4!}x^4 = x^4 - 2x^3 - 5x + 4$
22. $f(x) = \frac{x^2}{x+1} \Rightarrow f'(x) = \frac{2x+x^2}{(x+1)^2}; f''(x) = \frac{2}{(x+1)^3}; f'''(x) = \frac{-6}{(x+1)^4} \Rightarrow f^{(n)}(x) = \frac{(-1)^n n!}{(x+1)^{n+1}};$
 $f(0) = 0, f'(0) = 0, f''(0) = 2, f'''(0) = -6, f^{(n)}(0) = (-1)^n n!$ if $n \geq 2 \Rightarrow x^2 - x^3 + x^4 - x^5 + \dots = \sum_{n=2}^{\infty} (-1)^n x^n$
23. $f(x) = x^3 - 2x + 4 \Rightarrow f'(x) = 3x^2 - 2, f''(x) = 6x, f'''(x) = 6 \Rightarrow f^{(n)}(x) = 0$ if $n \geq 4;$
 $f(2) = 8, f'(2) = 10, f''(2) = 12, f'''(2) = 6, f^{(n)}(2) = 0$ if $n \geq 4$
 $\Rightarrow x^3 - 2x + 4 = 8 + 10(x-2) + \frac{12}{2!}(x-2)^2 + \frac{6}{3!}(x-2)^3 = 8 + 10(x-2) + 6(x-2)^2 + (x-2)^3$
24. $f(x) = 2x^3 + x^2 + 3x - 8 \Rightarrow f'(x) = 6x^2 + 2x + 3, f''(x) = 12x + 2, f'''(x) = 12 \Rightarrow f^{(n)}(x) = 0$ if $n \geq 4;$
 $f(1) = -2, f'(1) = 11, f''(1) = 14, f'''(1) = 12, f^{(n)}(1) = 0$ if $n \geq 4$
 $\Rightarrow 2x^3 + x^2 + 3x - 8 = -2 + 11(x-1) + \frac{14}{2!}(x-1)^2 + \frac{12}{3!}(x-1)^3 = -2 + 11(x-1) + 7(x-1)^2 + 2(x-1)^3$
25. $f(x) = x^4 + x^2 + 1 \Rightarrow f'(x) = 4x^3 + 2x, f''(x) = 12x^2 + 2, f'''(x) = 24x, f^{(4)}(x) = 24, f^{(n)}(x) = 0$ if $n \geq 5;$
 $f(-2) = 21, f'(-2) = -36, f''(-2) = 50, f'''(-2) = -48, f^{(4)}(-2) = 24, f^{(n)}(-2) = 0$ if $n \geq 5 \Rightarrow x^4 + x^2 + 1$
 $= 21 - 36(x+2) + \frac{50}{2!}(x+2)^2 - \frac{48}{3!}(x+2)^3 + \frac{24}{4!}(x+2)^4 = 21 - 36(x+2) + 25(x+2)^2 - 8(x+2)^3 + (x+2)^4$
26. $f(x) = 3x^5 - x^4 + 2x^3 + x^2 - 2 \Rightarrow f'(x) = 15x^4 - 4x^3 + 6x^2 + 2x, f''(x) = 60x^3 - 12x^2 + 12x + 2,$
 $f'''(x) = 180x^2 - 24x + 12, f^{(4)}(x) = 360x - 24, f^{(5)}(x) = 360, f^{(n)}(x) = 0$ if $n \geq 6;$
 $f(-1) = -7, f'(-1) = 23, f''(-1) = -82, f'''(-1) = 216, f^{(4)}(-1) = -384, f^{(5)}(-1) = 360, f^{(n)}(-1) = 0$ if $n \geq 6$
 $\Rightarrow 3x^5 - x^4 + 2x^3 + x^2 - 2 = -7 + 23(x+1) - \frac{82}{2!}(x+1)^2 + \frac{216}{3!}(x+1)^3 - \frac{384}{4!}(x+1)^4 + \frac{360}{5!}(x+1)^5$
 $= -7 + 23(x+1) - 41(x+1)^2 + 36(x+1)^3 - 16(x+1)^4 + 3(x+1)^5$
27. $f(x) = x^{-2} \Rightarrow f'(x) = -2x^{-3}, f''(x) = 3!x^{-4}, f'''(x) = -4!x^{-5} \Rightarrow f^{(n)}(x) = (-1)^n (n+1)!x^{-n-2};$
 $f(1) = 1, f'(1) = -2, f''(1) = 3!, f'''(1) = -4!, f^{(n)}(1) = (-1)^n (n+1)!$
 $\Rightarrow \frac{1}{x^2} = 1 - 2(x-1) + 3(x-1)^2 - 4(x-1)^3 + \dots = \sum_{n=0}^{\infty} (-1)^n (n+1)(x-1)^n$
28. $f(x) = \frac{1}{(1-x)^3} \Rightarrow f'(x) = 3(1-x)^{-4}, f''(x) = 12(1-x)^{-5}, f'''(x) = 60(1-x)^{-6} \Rightarrow f^{(n)}(x) = \frac{(n+2)!}{2}(1-x)^{-n-3};$
 $f(0) = 1, f'(0) = 3, f''(0) = 12, f'''(0) = 60, \dots, f^{(n)}(0) = \frac{(n+2)!}{2}$
 $\Rightarrow \frac{1}{(1-x)^3} = 1 + 3x + 6x^2 + 10x^3 + \dots = \sum_{n=0}^{\infty} \frac{(n+2)(n+1)}{2} x^n$

29. $f(x) = e^x \Rightarrow f'(x) = e^x, f''(x) = e^x \Rightarrow f^{(n)}(x) = e^x; f(2) = e^2, f'(2) = e^2, \dots, f^{(n)}(2) = e^2$
 $\Rightarrow e^x = e^2 + e^2(x-2) + \frac{e^2}{2}(x-2)^2 + \frac{e^2}{3!}(x-2)^3 + \dots = \sum_{n=0}^{\infty} \frac{e^2}{n!}(x-2)^n$
30. $f(x) = 2^x \Rightarrow f'(x) = 2^x \ln 2, f''(x) = 2^x (\ln 2)^2, f'''(x) = 2^x (\ln 2)^3 \Rightarrow f^{(n)}(x) = 2^x (\ln 2)^n;$
 $f(1) = 2, f'(1) = 2 \ln 2, f''(1) = 2(\ln 2)^2, f'''(1) = 2(\ln 2)^3, \dots, f^{(n)}(1) = 2(\ln 2)^n$
 $\Rightarrow 2^x = 2 + (2 \ln 2)(x-1) + \frac{2(\ln 2)^2}{2}(x-1)^2 + \frac{2(\ln 2)^3}{3!}(x-1)^3 + \dots = \sum_{n=0}^{\infty} \frac{2(\ln 2)^n (x-1)^n}{n!}$
31. $f(x) = \cos\left(2x + \frac{\pi}{2}\right), f'(x) = -2 \sin\left(2x + \frac{\pi}{2}\right), f''(x) = -4 \cos\left(2x + \frac{\pi}{2}\right), f'''(x) = 8 \sin\left(2x + \frac{\pi}{2}\right),$
 $f^{(4)}(x) = 2^4 \cos\left(2x + \frac{\pi}{2}\right), f^{(5)}(x) = -2^5 \sin\left(2x + \frac{\pi}{2}\right), \dots;$
 $f\left(\frac{\pi}{4}\right) = -1, f'\left(\frac{\pi}{4}\right) = 0, f''\left(\frac{\pi}{4}\right) = 4, f'''\left(\frac{\pi}{4}\right) = 0, f^{(4)}\left(\frac{\pi}{4}\right) = 2^4, f^{(5)}\left(\frac{\pi}{4}\right) = 0, \dots, f^{(2n)}\left(\frac{\pi}{4}\right) = (-1)^n 2^{2n}$
 $\Rightarrow \cos\left(2x + \frac{\pi}{2}\right) = -1 + 2\left(x - \frac{\pi}{4}\right)^2 - \frac{2}{3}\left(x - \frac{\pi}{4}\right)^4 + \dots = \sum_{n=0}^{\infty} \frac{(-1)^n 2^{2n}}{(2n)!} \left(x - \frac{\pi}{4}\right)^{2n}$
32. $f(x) = \sqrt{x+1}, f'(x) = \frac{1}{2}(x+1)^{-1/2}, f''(x) = -\frac{1}{4}(x+1)^{-3/2}, f'''(x) = \frac{3}{8}(x+1)^{-5/2}, f^{(4)}(x) = -\frac{15}{16}(x+1)^{-7/2}, \dots;$
 $f(0) = 1, f'(0) = \frac{1}{2}, f''(0) = -\frac{1}{4}, f'''(0) = \frac{3}{8}, f^{(4)}(0) = -\frac{15}{16}, \dots \Rightarrow \sqrt{x+1} = 1 + \frac{1}{2}x - \frac{1}{8}x^2 + \frac{1}{16}x^3 - \frac{5}{128}x^4 + \dots$
33. The Maclaurin series generated by $\cos x$ is $\sum_{n=0}^{\infty} \frac{(-1)^n}{(2n)!} x^{2n}$ which converges on $(-\infty, \infty)$ and the Maclaurin series generated by $\frac{2}{1-x}$ is $2 \sum_{n=0}^{\infty} x^n$ which converges on $(-1, 1)$. Thus the Maclaurin series generated by $f(x) = \cos x - \frac{2}{1-x}$ is given by $\sum_{n=0}^{\infty} \frac{(-1)^n}{(2n)!} x^{2n} - 2 \sum_{n=0}^{\infty} x^n = -1 - 2x - \frac{5}{2}x^2 - \dots$ which converges on the intersection of $(-\infty, \infty)$ and $(-1, 1)$, so the interval of convergence is $(-1, 1)$.
34. The Maclaurin series generated by e^x is $\sum_{n=0}^{\infty} \frac{x^n}{n!}$ which converges on $(-\infty, \infty)$. The Maclaurin series generated by $f(x) = (1-x+x^2)e^x$ is given by $(1-x+x^2) \sum_{n=0}^{\infty} \frac{x^n}{n!} = 1 + \frac{1}{2}x^2 + \frac{2}{3}x^3 \dots$ which converges on $(-\infty, \infty)$.
35. The Maclaurin series generated by $\sin x$ is $\sum_{n=0}^{\infty} \frac{(-1)^n}{(2n+1)!} x^{2n+1}$ which converges on $(-\infty, \infty)$ and the Maclaurin series generated by $\ln(1+x)$ is $\sum_{n=1}^{\infty} \frac{(-1)^{n-1}}{n} x^n$ which converges on $(-1, 1)$. Thus the Maclaurin series generated by $f(x) = \sin x \cdot \ln(1+x)$ is given by $\left(\sum_{n=0}^{\infty} \frac{(-1)^n}{(2n+1)!} x^{2n+1}\right) \left(\sum_{n=1}^{\infty} \frac{(-1)^{n-1}}{n} x^n\right) = x^2 - \frac{1}{2}x^3 + \frac{1}{6}x^4 - \dots$ which converges on the intersection of $(-\infty, \infty)$ and $(-1, 1)$, so the interval convergence is $(-1, 1)$.

36. The Maclaurin series generated by $\sin x$ is $\sum_{n=0}^{\infty} \frac{(-1)^n}{(2n+1)!} x^{2n+1}$ which converges on $(-\infty, \infty)$. The Maclaurin

series generated by $f(x) = x \sin^2 x$ is given by $x \left(\sum_{n=0}^{\infty} \frac{(-1)^n}{(2n+1)!} x^{2n+1} \right)^2 = x \left(\sum_{n=0}^{\infty} \frac{(-1)^n}{(2n+1)!} x^{2n+1} \right) \left(\sum_{n=0}^{\infty} \frac{(-1)^n}{(2n+1)!} x^{2n+1} \right)$
 $= x^3 - \frac{1}{3}x^5 + \frac{2}{45}x^7 + \dots$ which converges on $(-\infty, \infty)$.

37. If $e^x = \sum_{n=0}^{\infty} \frac{f^{(n)}(a)}{n!} (x-a)^n$ and $f(x) = e^x$, we have $f^{(n)}(a) = e^a$ for all $n = 0, 1, 2, 3, \dots$

$$\Rightarrow e^x = e^a \left[\frac{(x-a)^0}{0!} + \frac{(x-a)^1}{1!} + \frac{(x-a)^2}{2!} + \dots \right] = e^a \left[1 + (x-a) + \frac{(x-a)^2}{2!} + \dots \right] \text{ at } x = a$$

38. $f(x) = e^x \Rightarrow f^{(n)}(x) = e^x$ for all $n \Rightarrow f^{(n)}(1) = e$ for all $n = 0, 1, 2, \dots$

$$\Rightarrow e^x = e + e(x-1) + \frac{e}{2!}(x-1)^2 + \frac{e}{3!}(x-1)^3 + \dots = e \left[1 + (x-1) + \frac{(x-1)^2}{2!} + \frac{(x-1)^3}{3!} + \dots \right]$$

39. $f(x) = f(a) + f'(a)(x-a) + \frac{f''(a)}{2}(x-a)^2 + \frac{f'''(a)}{3!}(x-a)^3 + \dots$

$$\Rightarrow f'(x) = f'(a) + f''(a)(x-a) + \frac{f'''(a)}{3!}3(x-a)^2 + \dots \Rightarrow f''(x) = f''(a) + f'''(a)(x-a) + \frac{f^{(4)}(a)}{4!}4 \cdot 3(x-a)^2 + \dots$$

$$\Rightarrow f^{(n)}(x) = f^{(n)}(a) + f^{(n+1)}(a)(x-a) + \frac{f^{(n+2)}(a)}{2}(x-a)^2 + \dots$$

$$\Rightarrow f(a) = f(a) + 0, f'(a) = f'(a) + 0, \dots, f^{(n)}(a) = f^{(n)}(a) + 0$$

40. $E(x) = f(x) - b_0 - b_1(x-a) - b_2(x-a)^2 - b_3(x-a)^3 - \dots - b_n(x-a)^n \Rightarrow 0 = E(a) = f(a) - b_0 \Rightarrow b_0 = f(a)$; from condition (b),

$$\lim_{x \rightarrow a} \frac{f(x) - f(a) - b_1(x-a) - b_2(x-a)^2 - b_3(x-a)^3 - \dots - b_n(x-a)^n}{(x-a)^n} = 0$$

$$\Rightarrow \lim_{x \rightarrow a} \frac{f'(x) - b_1 - 2b_2(x-a) - 3b_3(x-a)^2 - \dots - nb_n(x-a)^{n-1}}{n(x-a)^{n-1}} = 0 \Rightarrow b_1 = f'(a)$$

$$\Rightarrow \lim_{x \rightarrow a} \frac{f''(x) - 2b_2 - 3!b_3(x-a) - \dots - n(n-1)b_n(x-a)^{n-2}}{n(n-1)(x-a)^{n-2}} = 0 \Rightarrow b_2 = \frac{1}{2}f''(a)$$

$$\Rightarrow \lim_{x \rightarrow a} \frac{f'''(x) - 3!b_3 - \dots - n(n-1)(n-2)b_n(x-a)^{n-3}}{n(n-1)(n-2)(x-a)^{n-3}} = 0 \Rightarrow b_3 = \frac{1}{3!}f'''(a)$$

$$\Rightarrow \lim_{x \rightarrow a} \frac{f^{(n)}(x) - n!b_n}{n!} = 0 \Rightarrow b_n = \frac{1}{n!}f^{(n)}(a); \text{ therefore,}$$

$$g(x) = f(a) + f'(a)(x-a) + \frac{f''(a)}{2!}(x-a)^2 + \dots + \frac{f^{(n)}(a)}{n!}(x-a)^n = P_n(x)$$

41. $f(x) = \ln(\cos x) \Rightarrow f'(x) = -\tan x$ and $f''(x) = -\sec^2 x$; $f(0) = 0, f'(0) = 0, f''(0) = -1$

$$\Rightarrow L(x) = 0 \text{ and } Q(x) = -\frac{x^2}{2}$$

42. $f(x) = e^{\sin x} \Rightarrow f'(x) = (\cos x)e^{\sin x}$ and $f''(x) = (-\sin x)e^{\sin x} + (\cos x)^2 e^{\sin x}$; $f(0) = 1, f'(0) = 1, f''(0) = 1$

$$\Rightarrow L(x) = 1 + x \text{ and } Q(x) = 1 + x + \frac{x^2}{2}$$

$$43. f(x) = (1-x^2)^{-1/2} \Rightarrow f'(x) = x(1-x^2)^{-3/2} \text{ and } f''(x) = (1-x^2)^{-3/2} + 3x^2(1-x^2)^{-5/2};$$

$$f(0) = 1, f'(0) = 0, f''(0) = 1 \Rightarrow L(x) = 1 \text{ and } Q(x) = 1 + \frac{x^2}{2}$$

$$44. f(x) = \cosh x \Rightarrow f'(x) = \sinh x \text{ and } f''(x) = \cosh x; f(0) = 1, f'(0) = 0, f''(0) = 1$$

$$\Rightarrow L(x) = 1 \text{ and } Q(x) = 1 + \frac{x^2}{2}$$

$$45. f(x) = \sin x \Rightarrow f'(x) = \cos x \text{ and } f''(x) = -\sin x; f(0) = 0, f'(0) = 1, f''(0) = 0 \Rightarrow L(x) = x \text{ and } Q(x) = x$$

$$46. f(x) = \tan x \Rightarrow f'(x) = \sec^2 x \text{ and } f''(x) = 2\sec^2 x \tan x; f(0) = 0, f'(0) = 1, f''(0) = 0 \Rightarrow L(x) = x \text{ and } Q(x) = x$$

10.9 CONVERGENCE OF TAYLOR SERIES

$$1. e^x = 1 + x + \frac{x^2}{2!} + \dots = \sum_{n=0}^{\infty} \frac{x^n}{n!} \Rightarrow e^{-5x} = 1 + (-5x) + \frac{(-5x)^2}{2!} + \dots = 1 - 5x + \frac{5^2 x^2}{2!} - \frac{5^3 x^3}{3!} + \dots = \sum_{n=0}^{\infty} \frac{(-1)^n 5^n x^n}{n!}$$

$$2. e^x = 1 + x + \frac{x^2}{2!} + \dots = \sum_{n=0}^{\infty} \frac{x^n}{n!} \Rightarrow e^{-x/2} = 1 + \left(\frac{-x}{2}\right) + \frac{\left(\frac{-x}{2}\right)^2}{2!} + \dots = 1 - \frac{x}{2} + \frac{x^2}{2^2 2!} - \frac{x^3}{2^3 3!} + \dots = \sum_{n=0}^{\infty} \frac{(-1)^n x^n}{2^n n!}$$

$$3. \sin x = x - \frac{x^3}{3!} + \frac{x^5}{5!} - \dots = \sum_{n=0}^{\infty} \frac{(-1)^n x^{2n+1}}{(2n+1)!} \Rightarrow 5 \sin(-x) = 5 \left[(-x) - \frac{(-x)^3}{3!} + \frac{(-x)^5}{5!} - \dots \right] = \sum_{n=0}^{\infty} \frac{5(-1)^{n+1} x^{2n+1}}{(2n+1)!}$$

$$4. \sin x = x - \frac{x^3}{3!} + \frac{x^5}{5!} - \dots = \sum_{n=0}^{\infty} \frac{(-1)^n x^{2n+1}}{(2n+1)!} \Rightarrow \sin \frac{\pi x}{2} = \frac{\pi x}{2} - \frac{\left(\frac{\pi x}{2}\right)^3}{3!} + \frac{\left(\frac{\pi x}{2}\right)^5}{5!} - \frac{\left(\frac{\pi x}{2}\right)^7}{7!} + \dots = \sum_{n=0}^{\infty} \frac{(-1)^n \pi^{2n+1} x^{2n+1}}{2^{2n+1} (2n+1)!}$$

$$5. \cos x = \sum_{n=0}^{\infty} \frac{(-1)^n x^{2n}}{(2n)!} \Rightarrow \cos 5x^2 = \sum_{n=0}^{\infty} \frac{(-1)^n (5x^2)^{2n}}{(2n)!} = \sum_{n=0}^{\infty} \frac{(-1)^n 5^{2n} x^{4n}}{(2n)!} = 1 - \frac{25x^4}{2!} + \frac{625x^8}{4!} - \frac{15625x^{12}}{6!} + \dots$$

$$6. \cos x = \sum_{n=0}^{\infty} \frac{(-1)^n x^{2n}}{(2n)!} \Rightarrow \cos\left(\frac{x^3}{\sqrt{2}}\right) = \cos\left(\left(\frac{x^3}{2}\right)^{1/2}\right) = \sum_{n=0}^{\infty} \frac{(-1)^n \left(\left(\frac{x^3}{2}\right)^{1/2}\right)^{2n}}{(2n)!} = \sum_{n=0}^{\infty} \frac{(-1)^n x^{3n}}{2^n (2n)!} = 1 - \frac{x^3}{2 \cdot 2!} + \frac{x^6}{2^2 \cdot 4!} - \frac{x^9}{2^3 \cdot 6!} + \dots$$

$$7. \ln(1+x) = \sum_{n=1}^{\infty} \frac{(-1)^{n-1} x^n}{n} \Rightarrow \ln(1+x^2) = \sum_{n=1}^{\infty} \frac{(-1)^{n-1} (x^2)^n}{n} = \sum_{n=1}^{\infty} \frac{(-1)^{n-1} x^{2n}}{n} = x^2 - \frac{x^4}{2} + \frac{x^6}{3} - \frac{x^8}{4} + \dots$$

$$8. \tan^{-1} x = \sum_{n=0}^{\infty} \frac{(-1)^n x^{2n+1}}{2n+1} \Rightarrow \tan^{-1}(3x^4) = \sum_{n=0}^{\infty} \frac{(-1)^n (3x^4)^{2n+1}}{2n+1} = \sum_{n=0}^{\infty} \frac{(-1)^n 3^{2n+1} x^{8n+4}}{2n+1}$$

$$= 3x^4 - 9x^{12} + \frac{243}{5}x^{20} - \frac{2187}{7}x^{28} + \dots$$

$$9. \frac{1}{1+x} = \sum_{n=0}^{\infty} (-1)^n x^n \Rightarrow \frac{1}{1+\frac{3}{4}x^3} = \sum_{n=0}^{\infty} (-1)^n \left(\frac{3}{4}x^3\right)^n = \sum_{n=0}^{\infty} (-1)^n \left(\frac{3}{4}\right)^n x^{3n} = 1 - \frac{3}{4}x^3 + \frac{9}{16}x^6 - \frac{27}{64}x^9 + \dots$$

$$10. \frac{1}{1-x} = \sum_{n=0}^{\infty} x^n \Rightarrow \frac{1}{2-x} = \frac{1}{2} \frac{1}{1-\frac{1}{2}x} = \frac{1}{2} \sum_{n=0}^{\infty} \left(\frac{1}{2}x\right)^n = \sum_{n=0}^{\infty} \left(\frac{1}{2}\right)^{n+1} x^n = \frac{1}{2} + \frac{1}{4}x + \frac{1}{8}x^2 + \frac{1}{16}x^3 + \dots$$

$$11. e^x = \sum_{n=0}^{\infty} \frac{x^n}{n!} \Rightarrow xe^x = x \left(\sum_{n=0}^{\infty} \frac{x^n}{n!} \right) = \sum_{n=0}^{\infty} \frac{x^{n+1}}{n!} = x + x^2 + \frac{x^3}{2!} + \frac{x^4}{3!} + \frac{x^5}{4!} + \dots$$

$$12. \sin x = \sum_{n=0}^{\infty} \frac{(-1)^n x^{2n+1}}{(2n+1)!} \Rightarrow x^2 \sin x = x^2 \left(\sum_{n=0}^{\infty} \frac{(-1)^n x^{2n+1}}{(2n+1)!} \right) = \sum_{n=0}^{\infty} \frac{(-1)^n x^{2n+3}}{(2n+1)!} = x^3 - \frac{x^5}{3!} + \frac{x^7}{5!} - \frac{x^9}{7!} + \dots$$

$$13. \cos x = \sum_{n=0}^{\infty} \frac{(-1)^n x^{2n}}{(2n)!} \Rightarrow \frac{x^2}{2} - 1 + \cos x = \frac{x^2}{2} - 1 + \sum_{n=0}^{\infty} \frac{(-1)^n x^{2n}}{(2n)!} = \frac{x^2}{2} - 1 + 1 - \frac{x^2}{2} + \frac{x^4}{4!} - \frac{x^6}{6!} + \frac{x^8}{8!} - \frac{x^{10}}{10!} + \dots$$

$$= \frac{x^4}{4!} - \frac{x^6}{6!} + \frac{x^8}{8!} - \frac{x^{10}}{10!} + \dots = \sum_{n=2}^{\infty} \frac{(-1)^n x^{2n}}{(2n)!}$$

$$14. \sin x = \sum_{n=0}^{\infty} \frac{(-1)^n x^{2n+1}}{(2n+1)!} \Rightarrow \sin x - x + \frac{x^3}{3!} = \left(\sum_{n=0}^{\infty} \frac{(-1)^n x^{2n+1}}{(2n+1)!} \right) - x + \frac{x^3}{3!} = \left(x - \frac{x^3}{3!} + \frac{x^5}{5!} - \frac{x^7}{7!} + \frac{x^9}{9!} - \frac{x^{11}}{11!} + \dots \right) - x + \frac{x^3}{3!}$$

$$= \frac{x^5}{5!} - \frac{x^7}{7!} + \frac{x^9}{9!} - \frac{x^{11}}{11!} + \dots = \sum_{n=2}^{\infty} \frac{(-1)^n x^{2n+1}}{(2n+1)!}$$

$$15. \cos x = \sum_{n=0}^{\infty} \frac{(-1)^n x^{2n}}{(2n)!} \Rightarrow x \cos \pi x = x \sum_{n=0}^{\infty} \frac{(-1)^n (\pi x)^{2n}}{(2n)!} = \sum_{n=0}^{\infty} \frac{(-1)^n \pi^{2n} x^{2n+1}}{(2n)!} = x - \frac{\pi^2 x^3}{2!} + \frac{\pi^4 x^5}{4!} - \frac{\pi^6 x^7}{6!} + \dots$$

$$16. \cos x = \sum_{n=0}^{\infty} \frac{(-1)^n x^{2n}}{(2n)!} \Rightarrow x^2 \cos(x^2) = x^2 \sum_{n=0}^{\infty} \frac{(-1)^n (x^2)^{2n}}{(2n)!} = \sum_{n=0}^{\infty} \frac{(-1)^n x^{4n+2}}{(2n)!} = x^2 - \frac{x^6}{2!} + \frac{x^{10}}{4!} - \frac{x^{14}}{6!} + \dots$$

$$17. \cos^2 x = \frac{1}{2} + \frac{\cos 2x}{2} = \frac{1}{2} + \frac{1}{2} \sum_{n=0}^{\infty} \frac{(-1)^n (2x)^{2n}}{(2n)!} = \frac{1}{2} + \frac{1}{2} \left[1 - \frac{(2x)^2}{2!} + \frac{(2x)^4}{4!} - \frac{(2x)^6}{6!} + \frac{(2x)^8}{8!} - \dots \right]$$

$$= 1 - \frac{(2x)^2}{2 \cdot 2!} + \frac{(2x)^4}{2 \cdot 4!} - \frac{(2x)^6}{2 \cdot 6!} + \frac{(2x)^8}{2 \cdot 8!} - \dots = 1 + \sum_{n=1}^{\infty} \frac{(-1)^n (2x)^{2n}}{2 \cdot (2n)!} = 1 + \sum_{n=1}^{\infty} \frac{(-1)^n 2^{2n-1} x^{2n}}{(2n)!}$$

$$18. \sin^2 x = \frac{1 - \cos 2x}{2} = \frac{1}{2} - \frac{1}{2} \cos 2x = \frac{1}{2} - \frac{1}{2} \left(1 - \frac{(2x)^2}{2!} + \frac{(2x)^4}{4!} - \frac{(2x)^6}{6!} + \dots \right) = \frac{(2x)^2}{2 \cdot 2!} - \frac{(2x)^4}{2 \cdot 4!} + \frac{(2x)^6}{2 \cdot 6!} - \dots$$

$$= \sum_{n=1}^{\infty} \frac{(-1)^{n+1} (2x)^{2n}}{2 \cdot (2n)!} = \sum_{n=1}^{\infty} \frac{(-1)^n 2^{2n-1} x^{2n}}{(2n)!}$$

$$19. \frac{x^2}{1-2x} = x^2 \left(\frac{1}{1-2x} \right) = x^2 \sum_{n=0}^{\infty} (2x)^n = \sum_{n=0}^{\infty} 2^n x^{n+2} = x^2 + 2x^3 + 2^2 x^4 + 2^3 x^5 + \dots$$

$$20. \quad x \ln(1+2x) = x \sum_{n=1}^{\infty} \frac{(-1)^{n-1} (2x)^n}{n} = \sum_{n=1}^{\infty} \frac{(-1)^{n-1} 2^n x^{n+1}}{n} = 2x^2 - \frac{2^2 x^3}{2} + \frac{2^3 x^4}{4} - \frac{2^4 x^5}{5} + \dots$$

$$21. \quad \frac{1}{1-x} = \sum_{n=0}^{\infty} x^n = 1 + x + x^2 + x^3 + \dots \Rightarrow \frac{d}{dx} \left(\frac{1}{1-x} \right) = \frac{1}{(1-x)^2} = 1 + 2x + 3x^2 + \dots = \sum_{n=1}^{\infty} nx^{n-1} = \sum_{n=0}^{\infty} (n+1)x^n$$

$$22. \quad \frac{2}{(1-x)^3} = \frac{d^2}{dx^2} \left(\frac{1}{1-x} \right) = \frac{d}{dx} \left(\frac{1}{(1-x)^2} \right) = \frac{d}{dx} (1 + 2x + 3x^2 + \dots) = 2 + 6x + 12x^2 + \dots = \sum_{n=2}^{\infty} n(n-1)x^{n-2} \\ = \sum_{n=0}^{\infty} (n+2)(n+1)x^n$$

$$23. \quad \tan^{-1} x = x - \frac{1}{3}x^3 + \frac{1}{5}x^5 - \frac{1}{7}x^7 + \dots \Rightarrow x \tan^{-1} x^2 = x \left(x^2 - \frac{1}{3}(x^2)^3 + \frac{1}{5}(x^2)^5 - \frac{1}{7}(x^2)^7 + \dots \right) \\ = x^3 - \frac{1}{3}x^7 + \frac{1}{5}x^{11} - \frac{1}{7}x^{15} + \dots = \sum_{n=1}^{\infty} \frac{(-1)^n x^{4n-1}}{2n-1}$$

$$24. \quad \sin x = x - \frac{x^3}{3!} + \frac{x^5}{5!} - \frac{x^7}{7!} + \dots \Rightarrow \sin x \cdot \cos x = \frac{1}{2} \sin 2x = \frac{1}{2} \left(2x - \frac{(2x)^3}{3!} + \frac{(2x)^5}{5!} - \frac{(2x)^7}{7!} + \dots \right) \\ = x - \frac{4x^3}{3!} + \frac{16x^5}{5!} - \frac{64x^7}{7!} + \dots = x - \frac{2x^3}{3} + \frac{2x^5}{15} - \frac{4x^7}{315} + \dots = \sum_{n=0}^{\infty} \frac{(-1)^n 2^{2n} x^{2n+1}}{(2n+1)!}$$

$$25. \quad e^x = 1 + x + \frac{x^2}{2!} + \frac{x^3}{3!} + \dots \text{ and } \frac{1}{1+x} = 1 - x + x^2 - x^3 + \dots \Rightarrow e^x + \frac{1}{1+x} = \left(1 + x + \frac{x^2}{2!} + \frac{x^3}{3!} + \dots \right) + \left(1 - x + x^2 - x^3 + \dots \right) \\ = 2 + \frac{3}{2}x^2 - \frac{5}{6}x^3 + \frac{25}{24}x^4 + \dots = \sum_{n=0}^{\infty} \left(\frac{1}{n!} + (-1)^n \right) x^n$$

$$26. \quad \sin x = x - \frac{x^3}{3!} + \frac{x^5}{5!} - \frac{x^7}{7!} + \dots \text{ and } \cos x = 1 - \frac{x^2}{2!} + \frac{x^4}{4!} - \frac{x^6}{6!} + \dots \\ \Rightarrow \cos x - \sin x = \left(1 - \frac{x^2}{2!} + \frac{x^4}{4!} - \frac{x^6}{6!} + \dots \right) - \left(x - \frac{x^3}{3!} + \frac{x^5}{5!} - \frac{x^7}{7!} + \dots \right) = 1 - x - \frac{x^2}{2!} + \frac{x^3}{3!} + \frac{x^4}{4!} - \frac{x^5}{5!} - \frac{x^6}{6!} + \frac{x^7}{7!} + \dots \\ = \sum_{n=0}^{\infty} \left(\frac{(-1)^n x^{2n}}{(2n)!} - \frac{(-1)^n x^{2n+1}}{(2n+1)!} \right)$$

$$27. \quad \ln(1+x) = x - \frac{1}{2}x^2 + \frac{1}{3}x^3 - \frac{1}{4}x^4 + \dots \Rightarrow \frac{x}{3} \ln(1+x^2) = \frac{x}{3} \left(x^2 - \frac{1}{2}(x^2)^2 + \frac{1}{3}(x^2)^3 - \frac{1}{4}(x^2)^4 + \dots \right) \\ = \frac{1}{3}x^3 - \frac{1}{6}x^5 + \frac{1}{9}x^7 - \frac{1}{12}x^9 + \dots = \sum_{n=1}^{\infty} \frac{(-1)^{n-1}}{3n} x^{2n+1}$$

$$28. \quad \ln(1+x) = x - \frac{1}{2}x^2 + \frac{1}{3}x^3 - \frac{1}{4}x^4 + \dots \text{ and } \ln(1-x) = -x - \frac{1}{2}x^2 - \frac{1}{3}x^3 - \frac{1}{4}x^4 + \dots \Rightarrow \ln(1+x) - \ln(1-x) \\ = \left(x - \frac{1}{2}x^2 + \frac{1}{3}x^3 - \frac{1}{4}x^4 + \dots \right) - \left(-x - \frac{1}{2}x^2 - \frac{1}{3}x^3 - \frac{1}{4}x^4 + \dots \right) = 2x + \frac{2}{3}x^3 + \frac{2}{5}x^5 + \dots = \sum_{n=0}^{\infty} \frac{2}{2n+1} x^{2n+1}$$

29. $e^x = 1 + x + \frac{x^2}{2!} + \frac{x^3}{3!} + \dots$ and $\sin x = x - \frac{x^3}{3!} + \frac{x^5}{5!} - \frac{x^7}{7!} + \dots$
 $\Rightarrow e^x \cdot \sin x = \left(1 + x + \frac{x^2}{2!} + \frac{x^3}{3!} + \dots\right) \left(x - \frac{x^3}{3!} + \frac{x^5}{5!} - \frac{x^7}{7!} + \dots\right) = x + x^2 + \frac{1}{3}x^3 - \frac{1}{30}x^5 - \dots$
30. $\ln(1+x) = x - \frac{1}{2}x^2 + \frac{1}{3}x^3 - \frac{1}{4}x^4 + \dots$ and $\frac{1}{1-x} = 1 + x + x^2 + x^3 + \dots$
 $\Rightarrow \frac{\ln(1+x)}{1-x} = \ln(1+x) \cdot \frac{1}{1-x} = \left(x - \frac{1}{2}x^2 + \frac{1}{3}x^3 - \frac{1}{4}x^4 + \dots\right) \left(1 + x + x^2 + x^3 + \dots\right) = x + \frac{1}{2}x^2 + \frac{5}{6}x^3 + \frac{7}{12}x^4 + \dots$
31. $\tan^{-1} x = x - \frac{1}{3}x^3 + \frac{1}{5}x^5 - \frac{1}{7}x^7 + \dots \Rightarrow \left(\tan^{-1} x\right)^2 = \left(\tan^{-1} x\right) \left(\tan^{-1} x\right)$
 $= \left(x - \frac{1}{3}x^3 + \frac{1}{5}x^5 - \frac{1}{7}x^7 + \dots\right) \left(x - \frac{1}{3}x^3 + \frac{1}{5}x^5 - \frac{1}{7}x^7 + \dots\right) = x^2 - \frac{2}{3}x^4 - \frac{23}{45}x^6 - \frac{44}{105}x^8 + \dots$
32. $\sin x = x - \frac{x^3}{3!} + \frac{x^5}{5!} - \frac{x^7}{7!} + \dots$ and $\cos x = 1 - \frac{x^2}{2!} + \frac{x^4}{4!} - \frac{x^6}{6!} + \dots \Rightarrow \cos^2 x \cdot \sin x = \cos x \cdot \cos x \cdot \sin x$
 $= \cos x \cdot \frac{1}{2} \sin 2x = \frac{1}{2} \left(1 - \frac{x^2}{2!} + \frac{x^4}{4!} - \frac{x^6}{6!} + \dots\right) \left(2x - \frac{(2x)^3}{3!} + \frac{(2x)^5}{5!} - \frac{(2x)^7}{7!} + \dots\right) = x - \frac{7}{6}x^3 + \frac{61}{120}x^5 - \frac{1247}{5040}x^7 + \dots$
33. $\sin x = x - \frac{x^3}{3!} + \frac{x^5}{5!} - \frac{x^7}{7!} + \dots$ and $e^x = 1 + x + \frac{x^2}{2!} + \frac{x^3}{3!} + \dots$
 $\Rightarrow e^{\sin x} = 1 + \left(x - \frac{x^3}{3!} + \frac{x^5}{5!} - \frac{x^7}{7!} + \dots\right) + \frac{1}{2} \left(x - \frac{x^3}{3!} + \frac{x^5}{5!} - \frac{x^7}{7!} + \dots\right)^2 + \frac{1}{6} \left(x - \frac{x^3}{3!} + \frac{x^5}{5!} - \frac{x^7}{7!} + \dots\right)^3 + \dots$
 $= 1 + x + \frac{1}{2}x^2 - \frac{1}{8}x^4 + \dots$
34. $\sin x = x - \frac{x^3}{3!} + \frac{x^5}{5!} - \frac{x^7}{7!} + \dots$ and $\tan^{-1} x = x - \frac{1}{3}x^3 + \frac{1}{5}x^5 - \frac{1}{7}x^7 + \dots \Rightarrow \sin\left(\tan^{-1} x\right)$
 $= \left(x - \frac{1}{3}x^3 + \frac{1}{5}x^5 - \frac{1}{7}x^7 + \dots\right) - \frac{1}{6} \left(x - \frac{1}{3}x^3 + \frac{1}{5}x^5 - \frac{1}{7}x^7 + \dots\right)^3 + \frac{1}{120} \left(x - \frac{1}{3}x^3 + \frac{1}{5}x^5 - \frac{1}{7}x^7 + \dots\right)^5$
 $- \frac{1}{5040} \left(x - \frac{1}{3}x^3 + \frac{1}{5}x^5 - \frac{1}{7}x^7 + \dots\right)^7 + \dots = x - \frac{1}{2}x^3 + \frac{3}{8}x^5 - \frac{5}{16}x^7 + \dots$
35. Since $n = 3$, then $f^{(4)}(x) = \sin x$, $|f^{(4)}(x)| \leq M$ on $[0, 0.1] \Rightarrow |\sin x| \leq 1$ on $[0, 0.1] \Rightarrow M = 1$.
Then $|R_3(0.1)| \leq 1 \frac{|0.1-0|^4}{4!} = 4.2 \times 10^{-6} \Rightarrow \text{error} \leq 4.2 \times 10^{-6}$
36. Since $n = 4$, then $f^{(5)}(x) = e^x$, $|f^{(5)}(x)| \leq M$ on $[0, 0.5] \Rightarrow |e^x| \leq \sqrt{e}$ on $[0, 0.5] \Rightarrow M = 2.7$.
Then $|R_4(0.5)| \leq 2.7 \frac{|0.5-0|^5}{5!} = 7.03 \times 10^{-4} \Rightarrow \text{error} \leq 7.03 \times 10^{-4}$
37. By the Alternating Series Estimation Theorem, the error is less than $\frac{|x|^5}{5!} \Rightarrow |x|^5 < (5!) (5 \times 10^{-4})$
 $\Rightarrow |x|^5 < 600 \times 10^{-4} \Rightarrow |x| < \sqrt[5]{6 \times 10^{-2}} \approx 0.56968$

38. If $\cos x = 1 - \frac{x^2}{2}$ and $|x| < 0.5$, then the error is less than $\left| \frac{(.5)^4}{24} \right| = 0.0026$, by Alternating Series Estimation Theorem; since the next term in the series is positive, the approximation $1 - \frac{x^2}{2}$ is too small, by the Alternating Series Estimation Theorem
39. If $\sin x = x$ and $|x| < 10^{-3}$, then the error is less than $\frac{(10^{-3})^3}{3!} \approx 1.67 \times 10^{-10}$, by Alternating Series Estimation Theorem; The Alternating Series Estimation Theorem says $R_2(x)$ has the same sign as $-\frac{x^3}{3!}$. Moreover, $x < \sin x \Rightarrow 0 < \sin x - x = R_2(x) \Rightarrow x < 0 \Rightarrow -10^{-3} < x < 0$.
40. $\sqrt{1+x} = 1 + \frac{x}{2} - \frac{x^2}{8} + \frac{x^3}{16} - \dots$. By the Alternating Series Estimation Theorem the $|\text{error}| < \left| \frac{-x^2}{8} \right| < \frac{(0.01)^2}{8} = 1.25 \times 10^{-5}$
41. $|R_2(x)| = \left| \frac{e^c x^3}{3!} \right| < \frac{3^{(0.1)}(0.1)^3}{3!} < 1.87 \times 10^{-4}$, where c is between 0 and x
42. $|R_2(x)| = \left| \frac{e^c x^3}{3!} \right| < \frac{(0.1)^3}{3!} = 1.67 \times 10^{-4}$, where c is between 0 and x
43. $\sin^2 x = \left(\frac{1 - \cos 2x}{2} \right) = \frac{1}{2} - \frac{1}{2} \cos 2x = \frac{1}{2} - \frac{1}{2} \left(1 - \frac{(2x)^2}{2!} + \frac{(2x)^4}{4!} - \frac{(2x)^6}{6!} + \dots \right) = \frac{2x^2}{2!} - \frac{2^3 x^4}{4!} + \frac{2^5 x^6}{6!} - \dots$
 $\Rightarrow \frac{d}{dx}(\sin^2 x) = \frac{d}{dx} \left(\frac{2x^2}{2!} - \frac{2^3 x^4}{4!} + \frac{2^5 x^6}{6!} - \dots \right) = 2x - \frac{(2x)^3}{3!} + \frac{(2x)^5}{5!} - \frac{(2x)^7}{7!} + \dots$
 $\Rightarrow 2 \sin x \cos x = 2x - \frac{(2x)^3}{3!} + \frac{(2x)^5}{5!} - \frac{(2x)^7}{7!} + \dots = \sin 2x$, which checks
44. $\cos^2 x = \cos 2x + \sin^2 x = \left(1 - \frac{(2x)^2}{2!} + \frac{(2x)^4}{4!} - \frac{(2x)^6}{6!} + \frac{(2x)^8}{8!} + \dots \right) + \left(\frac{2x^2}{2!} - \frac{2^3 x^4}{4!} + \frac{2^5 x^6}{6!} - \frac{2^7 x^8}{8!} + \dots \right)$
 $= 1 - \frac{2x^2}{2!} + \frac{2^3 x^4}{4!} - \frac{2^5 x^6}{6!} + \dots = 1 - x^2 + \frac{1}{3} x^4 - \frac{2}{45} x^6 + \frac{1}{315} x^8 - \dots$
45. A special case of Taylor's Theorem is $f(b) = f(a) + f'(c)(b-a)$, where c is between a and $b \Rightarrow f(b) - f(a) = f'(c)(b-a)$, the Mean Value Theorem.
46. If $f(x)$ is twice differentiable and at $x = a$ there is a point of inflection, then $f''(a) = 0$. Therefore, $L(x) = Q(x) = f(a) + f'(a)(x-a)$.
47. (a) $f'' \leq 0$, $f'(a) = 0$ and $x = a$ interior to the interval $I \Rightarrow f(x) - f(a) = \frac{f''(c_2)}{2}(x-a)^2 \leq 0$ throughout $I \Rightarrow f(x) \leq f(a)$ throughout $I \Rightarrow f$ has a local maximum at $x = a$
 (b) similar reasoning gives $f(x) - f(a) = \frac{f''(c_2)}{2}(x-a)^2 \geq 0$ throughout $I \Rightarrow f(x) \geq f(a)$ throughout $I \Rightarrow f$ has a local minimum at $x = a$

48. $f(x) = (1-x)^{-1} \Rightarrow f'(x) = (1-x)^{-2} \Rightarrow f''(x) = 2(1-x)^{-3} \Rightarrow f^{(3)}(x) = 6(1-x)^{-4} \Rightarrow f^{(4)}(x) = 24(1-x)^{-5}$;
 therefore $\frac{1}{1-x} \approx 1 + x + x^2 + x^3$. $|x| < 0.1 \Rightarrow \frac{10}{11} < \frac{1}{1-x} < \frac{10}{9} \Rightarrow \left| \frac{1}{(1-x)^5} \right| < \left(\frac{10}{9} \right)^5 \Rightarrow \left| \frac{x^4}{(1-x)^5} \right| < x^4 \left(\frac{10}{9} \right)^5 \Rightarrow$ the error
 $e_3 \leq \left| \frac{\max f^{(4)}(x)x^4}{4!} \right| < (0.1)^4 \left(\frac{10}{9} \right)^5 = 0.00016935 < 0.00017$, since $\left| \frac{f^{(4)}(x)}{4!} \right| = \left| \frac{1}{(1-x)^5} \right|$.
49. (a) $f(x) = (1+x)^k \Rightarrow f'(x) = k(1+x)^{k-1} \Rightarrow f''(x) = k(k-1)(1+x)^{k-2}$; $f(0) = 1$, $f'(0) = k$, and
 $f''(0) = k(k-1) \Rightarrow Q(x) = 1 + kx + \frac{k(k-1)}{2}x^2$
- (b) $|R_2(x)| = \left| \frac{3.21}{3!}x^3 \right| < \frac{1}{100} \Rightarrow |x^3| < \frac{1}{100} \Rightarrow 0 < x < \frac{1}{100^{1/3}}$ or $0 < x < .21544$
50. (a) Let $P = x + \pi \Rightarrow |x| = |P - \pi| < .5 \times 10^{-n}$ since P approximates π accurate to n decimals. Then,
 $P + \sin P = (\pi + x) + \sin(\pi + x) = (\pi + x) - \sin x = \pi + (x - \sin x)$
 $\Rightarrow |(P + \sin P) - \pi| = |x - \sin x| \leq \frac{|x|^3}{3!} < \frac{0.125}{3!} \times 10^{-3n} < 0.5 \times 10^{-3n} \Rightarrow P + \sin P$ gives an approximation to
 π correct to $3n$ decimals.
51. If $f(x) = \sum_{n=0}^{\infty} a_n x^n$, then $f^{(k)}(x) = \sum_{n=k}^{\infty} n(n-1)(n-2)\cdots(n-k+1)a_n x^{n-k}$ and $f^{(k)}(0) = k!a_k \Rightarrow a_k = \frac{f^{(k)}(0)}{k!}$
 for k a nonnegative integer. Therefore, the coefficients of $f(x)$ are identical with the corresponding
 coefficients in the Maclaurin series of $f(x)$ and the statement follows.
52. Note: f even $\Rightarrow f(-x) = f(x) \Rightarrow -f'(-x) = f'(x) \Rightarrow f'(-x) = -f'(x) \Rightarrow f'$ odd;
 f odd $\Rightarrow f(-x) = -f(x) \Rightarrow -f'(-x) = -f'(x) \Rightarrow f'(-x) = f'(x) \Rightarrow f'$ even;
 also, f odd $\Rightarrow f(-0) = f(0) \Rightarrow 2f(0) = 0 \Rightarrow f(0) = 0$
- (a) If $f(x)$ is even, then any odd-order derivative is odd and equal to 0 at $x = 0$.
 Therefore, $a_1 = a_3 = a_5 = \dots = 0$; that is, the Maclaurin series for f contains only even powers.
- (b) If $f(x)$ is odd, then any even-order derivative is odd and equal to 0 at $x = 0$.
 Therefore, $a_0 = a_2 = a_4 = \dots = 0$; that is, the Maclaurin series for f contains only odd powers.

53-58. Example CAS commands:

Maple:

```
f := x -> 1/sqrt(1+x);
```

```
x0 := -3/4;
```

```
x1 := 3/4;
```

```
# Step 1:
```

```
plot( f(x), x=x0..x1, title="Step 1: #53 (Section 10.9)");
```

```
# Step 2:
```

```
P1 := unapply( TaylorApproximation(f(x), x = 0, order=1), x );
```

```
P2 := unapply( TaylorApproximation(f(x), x = 0, order=2), x );
```

```
P3 := unapply( TaylorApproximation(f(x), x = 0, order=3), x );
```

```

# Step 3:
D2f := D(D(f));
D3f := D(D(D(f)));
D4f := D(D(D(D(f))));
plot( [D2f(x),D3f(x),D4f(x)], x=x0..x1, thickness=[0,2,4], color=[red,blue,green], title="Step 3: #57
(Section 10.9)" );
c1 := x0;
M1 := abs( D2f(c1) );
c2 := x0;
M2 := abs( D3f(c2) );
c3 := x0;
M3 := abs( D4f(c3) );
# Step 4:
R1 := unapply( abs(M1/2!*(x-0)^2), x );
R2 := unapply( abs(M2/3!*(x-0)^3), x );
R3 := unapply( abs(M3/4!*(x-0)^4), x );
plot( [R1(x),R2(x),R3(x)], x=x0..x1, thickness=[0,2,4], color=[red,blue,green], title="Step 4: #53
(Section 10.9)" );
# Step 5:
E1 := unapply( abs(f(x)-P1(x)), x );
E2 := unapply( abs(f(x)-P2(x)), x );
E3 := unapply( abs(f(x)-P3(x)), x );
plot( [E1(x),E2(x),E3(x),R1(x),R2(x),R3(x)], x=x0..x1, thickness=[0,2,4], color=[red,blue,green],
linestyle=[1,1,1,3,3,3], title="Step 5: #53 (Section 10.9)" );
# Step 6:
TaylorApproximation( f(x), view=[x0..x1,DEFAULT], x=0, output=animation, order=1..3 );
L1 := fsolve( abs(f(x)-P1(x))=0.01, x=x0/2 ); # (a)
R1 := fsolve( abs(f(x)-P1(x))=0.01, x=x1/2 );
L2 := fsolve( abs(f(x)-P2(x))=0.01, x=x0/2 );
R2 := fsolve( abs(f(x)-P2(x))=0.01, x=x1/2 );
L3 := fsolve( abs(f(x)-P3(x))=0.01, x=x0/2 );
R3 := fsolve( abs(f(x)-P3(x))=0.01, x=x1/2 );
plot( [E1(x),E2(x),E3(x),0.01], x=min(L1,L2,L3)..max(R1,R2,R3), thickness=[0,2,4,0], linestyle=[0,0,0,2]
color=[red,blue,green,black], view=[DEFAULT,0..0.01], title="#53(a) (Section 10.9)" );
abs( f(x) - P [1](x) ) <= evalf( E1(x0) ); # (b)
abs( f(x) - P [2](x) ) <= evalf( E2(x0) );
abs( f(x) - P [3](x) ) <= evalf( E3(x0) );

```

Mathematica: (assigned function and values for a, b, c, and n may vary)

```
Clear[x, f, c]
f[x_]= (1 + x)3/2
{a, b} = {-1/2, 2};
pf=Plot[ f[x], {x, a, b}];
poly1[x_]=Series[f[x], {x,0,1}]/Normal
poly2[x_]=Series[f[x], {x,0,2}]/Normal
poly3[x_]=Series[f[x], {x,0,3}]/Normal
Plot[ {f[x], poly1[x], poly2[x], poly3[x]}, {x, a, b},
PlotStyle → {RGBColor[1,0,0], RGBColor[0,1,0], RGBColor[0,0,1], RGBColor[0,.5,.5]}];
```

The above defines the approximations. The following analyzes the derivatives to determine their maximum values.

```
f'[c]
Plot[f'[x], {x, a, b}];
f''[c]
Plot[f''[x], {x, a, b}];
f'''[c]
[f'''[x], {x, a, b}];
```

Noting the upper bound for each of the above derivatives occurs at $x = a$, the upper bounds m_1 , m_2 , and m_3 can be defined and bounds for remainders viewed as functions of x .

```
m1=f'[a]
m2=-f''[a]
m3=f'''[a]
r1[x_]=m1 x2/2!
Plot[r1[x], {x, a, b}];
r2[x_]=m2 x3/3!
Plot[r2[x], {x, a, b}];
r3[x_]=m3 x4/4!
Plot[r3[x], {x, a, b}];
```

A three dimensional look at the error functions, allowing both c and x to vary can also be viewed. Recall that c must be a value between 0 and x . so some points on the surfaces where c is not in that interval are meaningless.

```
Plot3D[f'[c] x2/2!, {x, a, b}, {c, a, b}, PlotRange → All]
Plot3D[f''[c] x3/3!, {x, a, b}, {c, a, b}, PlotRange → All]
Plot3D[f'''[c] x4/4!, {x, a, b}, {c, a, b}, PlotRange → All]
```

10.10 THE BINOMIAL SERIES AND APPLICATIONS OF TAYLOR SERIES

1. $(1+x)^{1/2} = 1 + \frac{1}{2}x + \frac{(\frac{1}{2})(-\frac{1}{2})x^2}{2!} + \frac{(\frac{1}{2})(-\frac{1}{2})(-\frac{3}{2})x^3}{3!} + \dots = 1 + \frac{1}{2}x - \frac{1}{8}x^2 + \frac{1}{16}x^3 - \dots$
2. $(1+x)^{1/3} = 1 + \frac{1}{3}x + \frac{(\frac{1}{3})(-\frac{2}{3})x^2}{2!} + \frac{(\frac{1}{3})(-\frac{2}{3})(-\frac{5}{3})x^3}{3!} + \dots = 1 + \frac{1}{3}x - \frac{1}{9}x^2 + \frac{5}{81}x^3 - \dots$
3. $(1-x)^{-3} = 1 + (-3)(-x) + \frac{(-3)(-4)(-x)^2}{2!} + \frac{(-3)(-4)(-5)(-x)^3}{3!} + \dots = 1 + 3x + 6x^2 + 10x^3 + \dots$
4. $(1-2x)^{1/2} = 1 + \frac{1}{2}(-2x) + \frac{(\frac{1}{2})(-\frac{1}{2})(-2x)^2}{2!} + \frac{(\frac{1}{2})(-\frac{1}{2})(-\frac{3}{2})(-2x)^3}{3!} + \dots = 1 - x - \frac{1}{2}x^2 - \frac{1}{2}x^3 - \dots$
5. $(1+\frac{x}{2})^{-2} = 1 - 2(\frac{x}{2}) + \frac{(-2)(-3)(\frac{x}{2})^2}{2!} + \frac{(-2)(-3)(-4)(\frac{x}{2})^3}{3!} + \dots = 1 - x + \frac{3}{4}x^2 - \frac{1}{2}x^3 + \dots$
6. $(1-\frac{x}{3})^4 = 1 + 4(-\frac{x}{3}) + \frac{(4)(3)(-\frac{x}{3})^2}{2!} + \frac{(4)(3)(2)(-\frac{x}{3})^3}{3!} + \frac{(4)(3)(2)(1)(-\frac{x}{3})^4}{4!} + 0 + \dots = 1 - \frac{4}{3}x + \frac{2}{3}x^2 - \frac{4}{27}x^3 + \frac{1}{81}x^4$
7. $(1+x^3)^{-1/2} = 1 - \frac{1}{2}x^3 + \frac{(-\frac{1}{2})(-\frac{3}{2})(x^3)^2}{2!} + \frac{(-\frac{1}{2})(-\frac{3}{2})(-\frac{5}{2})(x^3)^3}{3!} + \dots = 1 - \frac{1}{2}x^3 + \frac{3}{8}x^6 - \frac{5}{16}x^9 + \dots$
8. $(1+x^2)^{-1/3} = 1 - \frac{1}{3}x^2 + \frac{(-\frac{1}{3})(-\frac{4}{3})(x^2)^2}{2!} + \frac{(-\frac{1}{3})(-\frac{4}{3})(-\frac{7}{3})(x^2)^3}{3!} + \dots = 1 - \frac{1}{3}x^2 + \frac{2}{9}x^4 - \frac{14}{81}x^6 + \dots$
9. $(1+\frac{1}{x})^{1/2} = 1 + \frac{1}{2}(\frac{1}{x}) + \frac{(\frac{1}{2})(-\frac{1}{2})(\frac{1}{x})^2}{2!} + \frac{(\frac{1}{2})(-\frac{1}{2})(-\frac{3}{2})(\frac{1}{x})^3}{3!} + \dots = 1 + \frac{1}{2x} - \frac{1}{8x^2} + \frac{1}{16x^3} + \dots$
10. $\frac{x}{\sqrt[3]{1+x}} = x(1+x)^{-1/3} = x\left(1 - \left(-\frac{1}{3}\right)x + \frac{(-\frac{1}{3})(-\frac{4}{3})x^2}{2!} + \frac{(-\frac{1}{3})(-\frac{4}{3})(-\frac{7}{3})x^3}{3!} + \dots\right) = x - \frac{1}{3}x^2 + \frac{2}{9}x^3 - \frac{14}{81}x^4 + \dots$
11. $(1+x)^4 = 1 + 4x + \frac{(4)(3)x^2}{2!} + \frac{(4)(3)(2)x^3}{3!} + \frac{(4)(3)(2)x^4}{4!} = 1 + 4x + 6x^2 + 4x^3 + x^4$
12. $(1+x^2)^3 = 1 + 3x^2 + \frac{(3)(2)(x^2)^2}{2!} + \frac{(3)(2)(1)(x^2)^3}{3!} = 1 + 3x^2 + 3x^4 + x^6$
13. $(1-2x)^3 = 1 + 3(-2x) + \frac{(3)(2)(-2x)^2}{2!} + \frac{(3)(2)(1)(-2x)^3}{3!} = 1 - 6x + 12x^2 - 8x^3$
14. $(1-\frac{x}{2})^4 = 1 + 4(-\frac{x}{2}) + \frac{(4)(3)(-\frac{x}{2})^2}{2!} + \frac{(4)(3)(2)(-\frac{x}{2})^3}{3!} + \frac{(4)(3)(2)(1)(-\frac{x}{2})^4}{4!} = 1 - 2x + \frac{3}{2}x^2 - \frac{1}{2}x^3 + \frac{1}{16}x^4$

15. Example 3 gives the indefinite integral as $C + \frac{x^3}{3} - \frac{x^7}{7 \cdot 3!} + \frac{x^{11}}{11 \cdot 5!} - \frac{x^{15}}{15 \cdot 7!} + \dots$. Since the lower limit of integration is 0, the value of the definite integral will be the value of this series at the upper limit, with $C = 0$. Since $\frac{0.6^{11}}{11 \cdot 5!} \approx 2.75 \times 10^{-6}$ and the preceding term is greater than 10^{-5} , the first two terms should give the required accuracy, and the integral is approximated to within 10^{-5} by $\frac{0.6^3}{3} - \frac{0.6^7}{7 \cdot 3!} \approx 0.0713335$
16. Using the series for e^{-x} , we find $\frac{e^{-x} - 1}{x} = -1 + \frac{x}{2!} - \frac{x^2}{3!} + \dots$. Integrating term by term and noting that the lower limit of integration is 0, the value of the definite integral from 0 to x is given by $-x + \frac{x^2}{2 \cdot 2!} - \frac{x^3}{3 \cdot 3!} + \dots$. Since $\frac{0.4^6}{6 \cdot 6!} \approx 9.48 \times 10^{-7}$ and the preceding term is greater than 10^{-5} , the first five terms should give the required accuracy, and the integral is approximated to within 10^{-5} by $-0.4 + \frac{0.4^2}{2 \cdot 2!} - \frac{0.4^3}{3 \cdot 3!} + \frac{0.4^4}{4 \cdot 4!} - \frac{0.4^5}{5 \cdot 5!} \approx -0.3633060$.
17. Using a binomial series we find $\frac{1}{\sqrt{1+x^4}} = 1 - \frac{x^4}{2} + \frac{3x^8}{8} - \frac{5x^{12}}{16} + \dots$. Integrating term by term and noting that the lower limit of integration is 0, the value of the definite integral from 0 to x is given by $x - \frac{x^5}{10} + \frac{x^9}{24} - \frac{5x^{13}}{13 \cdot 16} + \dots$. Since $\frac{5 \cdot 0.5^{13}}{13 \cdot 16} \approx 2.93 \times 10^{-6}$ and the preceding term is greater than 10^{-5} , the first three terms should give the required accuracy, and the integral is approximated to within 10^{-5} by $0.5 - \frac{0.5^5}{10} + \frac{0.5^9}{24} \approx 0.4969564$.
18. Using a binomial series we find $\sqrt[3]{1+x^2} = 1 + \frac{x^2}{3} - \frac{x^4}{9} + \frac{5x^6}{81} - \dots$. Integrating term by term and noting that the lower limit of integration is 0, the value of the integral from 0 to x is given by $x + \frac{x^3}{9} - \frac{x^5}{45} + \frac{5x^7}{7 \cdot 81} - \dots$. Since $\frac{5 \cdot 0.35^7}{7 \cdot 81} \approx 5.67 \times 10^{-6}$ and the preceding term is greater than 10^{-5} , the first three terms should give the required accuracy, and the integral is approximated to within 10^{-5} by $0.35 + \frac{0.35^3}{9} - \frac{0.35^5}{45} \approx 0.3546472$.
19. $\int_0^{0.1} \frac{\sin x}{x} dx = \int_0^{0.1} \left(1 - \frac{x^2}{3!} + \frac{x^4}{5!} - \frac{x^6}{7!} + \dots\right) dx = \left[x - \frac{x^3}{3 \cdot 3!} + \frac{x^5}{5 \cdot 5!} - \frac{x^7}{7 \cdot 7!} + \dots\right]_0^{0.1} \approx \left[x - \frac{x^3}{3 \cdot 3!} + \frac{x^5}{5 \cdot 5!}\right]_0^{0.1}$
 $\approx 0.0999444611, |E| \leq \frac{(0.1)^7}{7 \cdot 7!} \approx 2.8 \times 10^{-12}$
20. $\int_0^{0.1} e^{-x^2} dx = \int_0^{0.1} \left(1 - x^2 + \frac{x^4}{2!} - \frac{x^6}{3!} + \frac{x^8}{4!} - \dots\right) dx = \left[x - \frac{x^3}{3} + \frac{x^5}{10} - \frac{x^7}{42} + \dots\right]_0^{0.1} \approx \left[x - \frac{x^3}{3} + \frac{x^5}{10} - \frac{x^7}{42}\right]_0^{0.1}$
 $\approx 0.0996676643, |E| \leq \frac{(0.1)^9}{216} \approx 4.6 \times 10^{-12}$

21. $(1+x^4)^{1/2} = (1)^{1/2} + \frac{(\frac{1}{2})}{1}(1)^{-1/2}(x^4) + \frac{(\frac{1}{2})(-\frac{1}{2})}{2!}(1)^{-3/2}(x^4)^2 + \frac{(\frac{1}{2})(-\frac{1}{2})(-\frac{3}{2})}{3!}(1)^{-5/2}(x^4)^3$
 $+ \frac{(\frac{1}{2})(-\frac{1}{2})(-\frac{3}{2})(-\frac{5}{2})}{4!}(1)^{-7/2}(x^4)^4 + \dots = 1 + \frac{x^4}{2} - \frac{x^8}{8} + \frac{x^{12}}{16} - \frac{5x^{16}}{128} + \dots$
 $\Rightarrow \int_0^{0.1} \left(1 + \frac{x^4}{2} - \frac{x^8}{8} + \frac{x^{12}}{16} - \frac{5x^{16}}{128} + \dots\right) dx \approx \left[x + \frac{x^5}{10}\right]_0^{0.1} \approx 0.100001, |E| \leq \frac{(0.1)^9}{72} \approx 1.39 \times 10^{-11}$
22. $\int_0^1 \left(\frac{1-\cos x}{x^2}\right) dx = \int_0^1 \left(\frac{1}{2} - \frac{x^2}{4!} + \frac{x^4}{6!} - \frac{x^6}{8!} + \frac{x^8}{10!} - \dots\right) dx \approx \left[\frac{x}{2} - \frac{x^3}{3 \cdot 4!} + \frac{x^5}{5 \cdot 6!} - \frac{x^7}{7 \cdot 8!} + \frac{x^9}{9 \cdot 10!}\right]_0^1 \approx 0.4863853764,$
 $|E| \leq \frac{1}{11 \cdot 12!} \approx 1.9 \times 10^{-10}$
23. $\int_0^1 \cos t^2 dt = \int_0^1 \left(1 - \frac{t^4}{2} + \frac{t^8}{4!} - \frac{t^{12}}{6!} + \dots\right) dt = \left[t - \frac{t^5}{10} + \frac{t^9}{9 \cdot 4!} - \frac{t^{13}}{13 \cdot 6!} + \dots\right]_0^1 \Rightarrow |\text{error}| < \frac{1}{13 \cdot 6!} \approx .00011$
24. $\int_0^1 \cos \sqrt{t} dt = \int_0^1 \left(1 - \frac{t}{2} + \frac{t^2}{4!} - \frac{t^3}{6!} + \frac{t^4}{8!} - \dots\right) dt = \left[t - \frac{t^2}{4} + \frac{t^3}{3 \cdot 4!} - \frac{t^4}{4 \cdot 6!} + \frac{t^5}{5 \cdot 8!} - \dots\right]_0^1 \Rightarrow |\text{error}| < \frac{1}{5 \cdot 8!} \approx 0.000004960$
25. $F(x) = \int_0^x \left(t^2 - \frac{t^6}{3!} + \frac{t^{10}}{5!} - \frac{t^{14}}{7!} + \dots\right) dt = \left[\frac{t^3}{3} - \frac{t^7}{7 \cdot 3!} + \frac{t^{11}}{11 \cdot 5!} - \frac{t^{15}}{15 \cdot 7!} + \dots\right]_0^x \approx \frac{x^3}{3} - \frac{x^7}{7 \cdot 3!} + \frac{x^{11}}{11 \cdot 5!}$
 $\Rightarrow |\text{error}| < \frac{1}{15 \cdot 7!} \approx 0.000013$
26. $F(x) = \int_0^x \left(t^2 - t^4 + \frac{t^6}{2!} - \frac{t^8}{3!} + \frac{t^{10}}{4!} - \frac{t^{12}}{5!} + \dots\right) dt = \left[\frac{t^3}{3} - \frac{t^5}{5} + \frac{t^7}{7 \cdot 2!} - \frac{t^9}{9 \cdot 3!} + \frac{t^{11}}{11 \cdot 4!} - \frac{t^{13}}{13 \cdot 5!} + \dots\right]_0^x$
 $\approx \frac{x^3}{3} - \frac{x^5}{5} + \frac{x^7}{7 \cdot 2!} - \frac{x^9}{9 \cdot 3!} + \frac{x^{11}}{11 \cdot 4!} \Rightarrow |\text{error}| < \frac{1}{13 \cdot 5!} \approx 0.00064$
27. (a) $F(x) = \int_0^x \left(t - \frac{t^3}{3} + \frac{t^5}{5} - \frac{t^7}{7} + \dots\right) dt = \left[\frac{t^2}{2} + \frac{t^4}{12} + \frac{t^6}{30} - \dots\right]_0^x \approx \frac{x^2}{2} - \frac{x^4}{12} \Rightarrow |\text{error}| < \frac{(0.5)^6}{30} \approx .00052$
 (b) $|\text{error}| < \frac{1}{33 \cdot 34} \approx .00089$ when $F(x) \approx \frac{x^2}{2} - \frac{x^4}{3 \cdot 4} + \frac{x^6}{5 \cdot 6} - \frac{x^8}{7 \cdot 8} + \dots + (-1)^{15} \frac{x^{32}}{31 \cdot 22}$
28. (a) $F(x) = \int_0^x \left(1 - \frac{t}{2} + \frac{t^2}{3} - \frac{t^3}{4} + \dots\right) dt = \left[t - \frac{t^2}{2 \cdot 2} + \frac{t^3}{3 \cdot 3} - \frac{t^4}{4 \cdot 4} + \frac{t^5}{5 \cdot 5} - \dots\right]_0^x \approx x - \frac{x^2}{2^2} + \frac{x^3}{3^2} - \frac{x^4}{4^2} + \frac{x^5}{5^2}$
 $\Rightarrow |\text{error}| < \frac{(0.5)^6}{6^2} \approx .00043$
 (b) $|\text{error}| < \frac{1}{32^2} \approx .00097$ when $F(x) \approx x - \frac{x^2}{2^2} + \frac{x^3}{3^2} - \frac{x^4}{4^2} + \dots + (-1)^{31} \frac{x^{31}}{31^2}$
29. $\frac{1}{x^2}(e^x - (1+x)) = \frac{1}{x^2} \left(\left(1 + x + \frac{x^2}{2} + \frac{x^3}{3!} + \dots\right) - 1 - x \right) = \frac{1}{2} + \frac{x}{3!} + \frac{x^2}{4!} + \dots \Rightarrow \lim_{x \rightarrow 0} \frac{e^x - (1+x)}{x^2} = \lim_{x \rightarrow 0} \left(\frac{1}{2} + \frac{x}{3!} + \frac{x^2}{4!} + \dots \right)$
 $= \frac{1}{2}$
30. $\frac{1}{x}(e^x - e^{-x}) = \frac{1}{x} \left[\left(1 + x + \frac{x^2}{2!} + \frac{x^3}{3!} + \frac{x^4}{4!} + \dots\right) - \left(1 - x + \frac{x^2}{2!} - \frac{x^3}{3!} + \frac{x^4}{4!} - \dots\right) \right] = \frac{1}{x} \left(2x + \frac{2x^3}{3!} + \frac{2x^5}{5!} + \frac{2x^7}{7!} + \dots \right)$
 $= 2 + \frac{2x^2}{3!} + \frac{2x^4}{5!} + \frac{2x^6}{7!} + \dots \Rightarrow \lim_{x \rightarrow 0} \frac{e^x - e^{-x}}{x} = \lim_{x \rightarrow \infty} \left(2 + \frac{2x^2}{3!} + \frac{2x^4}{5!} + \frac{2x^6}{7!} + \dots \right) = 2$

$$31. \frac{1}{t^4} \left(1 - \cos t - \frac{t^2}{2} \right) = \frac{1}{t^4} \left[1 - \frac{t^2}{2} - \left(1 - \frac{t^2}{2} + \frac{t^4}{4!} - \frac{t^6}{6!} + \dots \right) \right] = -\frac{1}{4!} + \frac{t^2}{6!} - \frac{t^4}{8!} + \dots \Rightarrow \lim_{t \rightarrow 0} \frac{1 - \cos t - \left(\frac{t^2}{2} \right)}{t^4}$$

$$= \lim_{t \rightarrow 0} \left(-\frac{1}{4!} + \frac{t^2}{6!} - \frac{t^4}{8!} + \dots \right) = -\frac{1}{24}$$

$$32. \frac{1}{\theta^5} \left(-\theta + \frac{\theta^3}{6} + \sin \theta \right) = \frac{1}{\theta^5} \left(-\theta + \frac{\theta^3}{6} + \theta - \frac{\theta^3}{3!} + \frac{\theta^5}{5!} - \dots \right) = \frac{1}{5!} - \frac{\theta^2}{7!} + \frac{\theta^4}{9!} - \dots \Rightarrow \lim_{\theta \rightarrow 0} \frac{\sin \theta - \theta + \left(\frac{\theta^3}{6} \right)}{\theta^5}$$

$$= \lim_{\theta \rightarrow 0} \left(\frac{1}{5!} - \frac{\theta^2}{7!} + \frac{\theta^4}{9!} - \dots \right) = \frac{1}{120}$$

$$33. \frac{1}{y^3} \left(y - \tan^{-1} y \right) = \frac{1}{y^3} \left[y - \left(y - \frac{y^3}{3} + \frac{y^5}{5} - \dots \right) \right] = \frac{1}{3} - \frac{y^2}{5} + \frac{y^4}{7} - \dots \Rightarrow \lim_{y \rightarrow 0} \frac{y - \tan^{-1} y}{y^3} = \lim_{y \rightarrow 0} \left(\frac{1}{3} - \frac{y^2}{5} + \frac{y^4}{7} - \dots \right) = \frac{1}{3}$$

$$34. \frac{\tan^{-1} y - \sin y}{y^3 \cos y} = \frac{\left(y - \frac{y^3}{3} + \frac{y^5}{5} - \dots \right) - \left(y - \frac{y^3}{3!} + \frac{y^5}{5!} - \dots \right)}{y^3 \cos y} = \frac{\left(-\frac{y^3}{6} + \frac{23y^5}{5!} - \dots \right)}{y^3 \cos y} = \frac{\left(-\frac{1}{6} + \frac{23y^2}{5!} - \dots \right)}{\cos y}$$

$$\Rightarrow \lim_{y \rightarrow 0} \frac{\tan^{-1} y - \sin y}{y^3 \cos y} = \lim_{y \rightarrow 0} \frac{\left(-\frac{1}{6} + \frac{23y^2}{5!} - \dots \right)}{\cos y} = -\frac{1}{6}$$

$$35. x^2 \left(-1 + e^{-1/x^2} \right) = x^2 \left(-1 + 1 - \frac{1}{x^2} + \frac{1}{2x^4} - \frac{1}{6x^6} + \dots \right) = -1 + \frac{1}{2x^2} - \frac{1}{6x^4} + \dots \Rightarrow \lim_{x \rightarrow \infty} x^2 \left(e^{-1/x^2} - 1 \right)$$

$$= \lim_{x \rightarrow \infty} \left(-1 + \frac{1}{2x^2} - \frac{1}{6x^4} + \dots \right) = -1$$

$$36. (x+1) \sin \left(\frac{1}{x+1} \right) = (x+1) \left(\frac{1}{x+1} - \frac{1}{3!(x+1)^3} + \frac{1}{5!(x+1)^5} - \dots \right) = 1 - \frac{1}{3!(x+1)^2} + \frac{1}{5!(x+1)^4} - \dots$$

$$\Rightarrow \lim_{x \rightarrow \infty} (x+1) \sin \left(\frac{1}{x+1} \right) = \lim_{x \rightarrow \infty} \left(1 - \frac{1}{3!(x+1)^2} + \frac{1}{5!(x+1)^4} - \dots \right) = 1$$

$$37. \frac{\ln(1+x^2)}{1-\cos x} = \frac{\left(x^2 - \frac{x^4}{2} + \frac{x^6}{3} - \dots \right)}{1 - \left(1 - \frac{x^2}{2!} + \frac{x^4}{4!} - \dots \right)} = \frac{\left(1 - \frac{x^2}{2} + \frac{x^4}{3} - \dots \right)}{\left(\frac{1}{2!} - \frac{x^2}{4!} + \dots \right)} \Rightarrow \lim_{x \rightarrow 0} \frac{\ln(1+x^2)}{1-\cos x} = \lim_{x \rightarrow 0} \frac{\left(1 - \frac{x^2}{2} + \frac{x^4}{3} - \dots \right)}{\left(\frac{1}{2!} - \frac{x^2}{4!} + \dots \right)} = 2! = 2$$

$$38. \frac{x^2-4}{\ln(x-1)} = \frac{(x-2)(x+2)}{\left[(x-2) - \frac{(x-2)^2}{2} + \frac{(x-2)^3}{3} - \dots \right]} = \frac{x+2}{\left[1 - \frac{x-2}{2} + \frac{(x-2)^2}{3} - \dots \right]} \Rightarrow \lim_{x \rightarrow 2} \frac{x^2-4}{\ln(x-1)} = \lim_{x \rightarrow 2} \frac{x+2}{\left[1 - \frac{x-2}{2} + \frac{(x-2)^2}{3} - \dots \right]} = 4$$

$$39. \sin 3x^2 = 3x^2 - \frac{9}{2}x^6 + \frac{81}{40}x^{10} - \dots \text{ and } 1 - \cos 2x = 2x^2 - \frac{2}{3}x^4 + \frac{4}{45}x^6 - \dots$$

$$\Rightarrow \lim_{x \rightarrow 0} \frac{\sin 3x^2}{1 - \cos 2x} = \lim_{x \rightarrow 0} \frac{3x^2 - \frac{9}{2}x^6 + \frac{81}{40}x^{10} - \dots}{2x^2 - \frac{2}{3}x^4 + \frac{4}{45}x^6 - \dots} = \lim_{x \rightarrow 0} \frac{3 - \frac{9}{2}x^4 + \frac{81}{40}x^8 - \dots}{2 - \frac{2}{3}x^2 + \frac{4}{45}x^4 - \dots} = \frac{3}{2}$$

$$40. \ln(1+x^3) = x^3 - \frac{x^6}{2} + \frac{x^9}{3} - \frac{x^{12}}{4} + \dots \text{ and } x \sin x^2 = x^3 - \frac{1}{6}x^7 + \frac{1}{120}x^{11} - \frac{1}{5040}x^{15} + \dots$$

$$\Rightarrow \lim_{x \rightarrow 0} \frac{\ln(1+x^3)}{x \sin x^2} = \lim_{x \rightarrow 0} \frac{x^3 - \frac{x^6}{2} + \frac{x^9}{3} - \frac{x^{12}}{4} + \dots}{x^3 - \frac{1}{6}x^7 + \frac{1}{120}x^{11} - \frac{1}{5040}x^{15} + \dots} = \lim_{x \rightarrow 0} \frac{1 - \frac{x^3}{2} + \frac{x^6}{3} - \frac{x^9}{4} + \dots}{1 - \frac{1}{6}x^4 + \frac{1}{120}x^8 - \frac{1}{5040}x^{12} + \dots} = 1$$

$$41. 1 + 1 + \frac{1}{2!} + \frac{1}{3!} + \frac{1}{4!} + \dots = e^1 = e$$

$$42. \left(\frac{1}{4}\right)^3 + \left(\frac{1}{4}\right)^4 + \left(\frac{1}{4}\right)^5 + \dots = \left(\frac{1}{4}\right)^3 \left[1 + \left(\frac{1}{4}\right) + \left(\frac{1}{4}\right)^2 + \dots\right] = \frac{1}{64} \frac{1}{1-1/4} = \frac{1}{64} \frac{4}{3} = \frac{1}{48}$$

$$43. 1 - \frac{3^2}{4 \cdot 2!} + \frac{3^4}{4^2 \cdot 4!} - \frac{3^6}{4^3 \cdot 6!} + \dots = 1 - \frac{1}{2!} \left(\frac{3}{4}\right)^2 + \frac{1}{4!} \left(\frac{3}{4}\right)^4 - \frac{1}{6!} \left(\frac{3}{4}\right)^6 + \dots = \cos\left(\frac{3}{4}\right)$$

$$44. \frac{1}{2} - \frac{1}{2 \cdot 2^2} + \frac{1}{3 \cdot 2^3} - \frac{1}{4 \cdot 2^4} + \dots = \left(\frac{1}{2}\right) - \frac{1}{2} \left(\frac{1}{2}\right)^2 + \frac{1}{3} \left(\frac{1}{2}\right)^3 - \frac{1}{4} \left(\frac{1}{2}\right)^4 + \dots = \ln\left(1 + \frac{1}{2}\right) = \ln\left(\frac{3}{2}\right)$$

$$45. \frac{\pi}{3} - \frac{\pi^3}{3^3 \cdot 3!} + \frac{\pi^5}{3^5 \cdot 5!} - \frac{\pi^7}{3^7 \cdot 7!} + \dots = \frac{\pi}{3} - \frac{1}{3!} \left(\frac{\pi}{3}\right)^3 + \frac{1}{5!} \left(\frac{\pi}{3}\right)^5 - \frac{1}{7!} \left(\frac{\pi}{3}\right)^7 + \dots = \sin\left(\frac{\pi}{3}\right) = \frac{\sqrt{3}}{2}$$

$$46. \frac{2}{3} - \frac{2^3}{3^3 \cdot 3} + \frac{2^5}{3^5 \cdot 5} - \frac{2^7}{3^7 \cdot 7} + \dots = \left(\frac{2}{3}\right) - \frac{1}{3} \left(\frac{2}{3}\right)^3 + \frac{1}{5} \left(\frac{2}{3}\right)^5 - \frac{1}{7} \left(\frac{2}{3}\right)^7 + \dots = \tan^{-1}\left(\frac{2}{3}\right)$$

$$47. x^3 + x^4 + x^5 + x^6 + \dots = x^3 (1 + x + x^2 + x^3 + \dots) = x^3 \left(\frac{1}{1-x}\right) = \frac{x^3}{1-x}$$

$$48. 1 - \frac{3^2 x^2}{2!} + \frac{3^4 x^4}{4!} - \frac{3^6 x^6}{6!} + \dots = 1 - \frac{1}{2!} (3x)^2 + \frac{1}{4!} (3x)^4 - \frac{1}{6!} (3x)^6 + \dots = \cos(3x)$$

$$49. x^3 - x^5 + x^7 - x^9 + \dots = x^3 \left(1 - x^2 + (x^2)^2 - (x^2)^3 + \dots\right) = x^3 \left(\frac{1}{1+x^2}\right) = \frac{x^3}{1+x^2}$$

$$50. x^2 - 2x^3 + \frac{2^2 x^4}{2!} - \frac{2^2 x^5}{3!} + \frac{2^2 x^6}{4!} - \dots = x^2 \left(1 - 2x + \frac{(2x)^2}{2!} - \frac{(2x)^3}{3!} + \frac{(2x)^4}{4!} - \dots\right) = x^2 e^{-2x}$$

$$51. -1 + 2x - 3x^2 + 4x^3 - 5x^4 + \dots = \frac{d}{dx} (1 - x + x^2 - x^3 + x^4 - x^5 + \dots) = \frac{d}{dx} \left(\frac{1}{1+x}\right) = \frac{-1}{(1+x)^2}$$

$$52. 1 + \frac{x}{2} + \frac{x^2}{3} + \frac{x^3}{4} + \frac{x^4}{5} + \dots = -\frac{1}{x} \left(-x - \frac{x^2}{2} - \frac{x^3}{3} - \frac{x^4}{4} - \frac{x^5}{5} - \dots\right) = -\frac{1}{x} \ln(1-x) = -\frac{\ln(1-x)}{x}$$

$$53. \ln\left(\frac{1+x}{1-x}\right) = \ln(1+x) - \ln(1-x) = \left(x - \frac{x^2}{2} + \frac{x^3}{3} - \frac{x^4}{4} + \dots\right) - \left(-x - \frac{x^2}{2} - \frac{x^3}{3} - \frac{x^4}{4} - \dots\right) = 2\left(x + \frac{x^3}{3} + \frac{x^5}{5} + \dots\right)$$

$$54. \ln(1+x) = x - \frac{x^2}{2} + \frac{x^3}{3} - \frac{x^4}{4} + \dots + \frac{(-1)^{n-1} x^n}{n} + \dots \Rightarrow |\text{error}| = \left|\frac{(-1)^{n-1} x^n}{n}\right| = \frac{1}{n10^n} \text{ when } x = 0.1;$$

$$\frac{1}{n10^n} < \frac{1}{10^8} \Rightarrow n10^n > 10^8 \text{ when } n \geq 8 \Rightarrow 7 \text{ terms}$$

$$55. \tan^{-1} x = x - \frac{x^3}{3} + \frac{x^5}{5} - \frac{x^7}{7} + \frac{x^9}{9} - \dots + \frac{(-1)^{n-1} x^{2n-1}}{2n-1} + \dots \Rightarrow |\text{error}| = \left|\frac{(-1)^{n-1} x^{2n-1}}{2n-1}\right| = \frac{1}{2n-1} \text{ when } x = 1;$$

$$\frac{1}{2n-1} < \frac{1}{10^3} \Rightarrow n > \frac{1001}{2} = 500.5 \Rightarrow \text{the first term not used is the } 501^{\text{st}} \Rightarrow \text{we must use 500 terms}$$

$$56. \tan^{-1} x = x - \frac{x^3}{3} + \frac{x^5}{5} - \frac{x^7}{7} + \frac{x^9}{9} - \dots + \frac{(-1)^{n-1} x^{2n-1}}{2n-1} + \dots \text{ and } \lim_{n \rightarrow \infty} \left| \frac{x^{2n+1}}{2n+1} \cdot \frac{2n-1}{x^{2n-1}} \right| = x^2 \lim_{n \rightarrow \infty} \left| \frac{2n-1}{2n+1} \right| = x^2 \Rightarrow \tan^{-1} x$$

converges for $|x| < 1$; when $x = -1$ we have $\sum_{n=1}^{\infty} \frac{(-1)^n}{2n-1}$ which is a convergent series; when $x = 1$ we have

$$\sum_{n=1}^{\infty} \frac{(-1)^{n-1}}{2n-1} \text{ which is a convergent series } \Rightarrow \text{the series representing } \tan^{-1} x \text{ diverges for } |x| > 1$$

$$57. \tan^{-1} x = x - \frac{x^3}{3} + \frac{x^5}{5} - \frac{x^7}{7} + \frac{x^9}{9} - \dots + \frac{(-1)^{n-1} x^{2n-1}}{2n-1} + \dots \text{ and when the series representing } 48 \tan^{-1} \left(\frac{1}{18} \right) \text{ has an error less than } \frac{1}{3} \cdot 10^{-6}, \text{ then the series representing the sum } 48 \tan^{-1} \left(\frac{1}{18} \right) + 32 \tan^{-1} \left(\frac{1}{57} \right) - 20 \tan^{-1} \left(\frac{1}{239} \right) \text{ also}$$

has an error of magnitude less than 10^{-6} ; thus $|\text{error}| = 48 \frac{\left(\frac{1}{18}\right)^{2n-1}}{2n-1} < \frac{1}{3 \cdot 10^6} \Rightarrow n \geq 4$ using a calculator $\Rightarrow 4$ terms

$$58. \text{ (a) } f(x) = 1 + \sum_{k=1}^{\infty} \binom{m}{k} x^k \Rightarrow f'(x) = \sum_{k=1}^{\infty} \binom{m}{k} k x^{k-1} \Rightarrow (1+x) \cdot f'(x) = (1+x) \sum_{k=1}^{\infty} \binom{m}{k} k x^{k-1}$$

$$= \sum_{k=1}^{\infty} \binom{m}{k} k x^{k-1} + x \cdot \sum_{k=1}^{\infty} \binom{m}{k} k x^{k-1} = \sum_{k=1}^{\infty} \binom{m}{k} k x^{k-1} + \sum_{k=1}^{\infty} \binom{m}{k} k x^k =$$

$$\binom{m}{1} (1) x^0 + \sum_{k=2}^{\infty} \binom{m}{k} k x^{k-1} + \sum_{k=1}^{\infty} \binom{m}{k} k x^k = m + \sum_{k=2}^{\infty} \binom{m}{k} k x^{k-1} + \sum_{k=1}^{\infty} \binom{m}{k} k x^k$$

$$\text{Note that: } \sum_{k=2}^{\infty} \binom{m}{k} k x^{k-1} = \sum_{k=1}^{\infty} \binom{m}{k+1} (k+1) x^k.$$

$$\text{Thus, } (1+x) \cdot f'(x) = m + \sum_{k=2}^{\infty} \binom{m}{k} k x^{k-1} + \sum_{k=1}^{\infty} \binom{m}{k} k x^k = m + \sum_{k=1}^{\infty} \binom{m}{k+1} (k+1) x^k + \sum_{k=1}^{\infty} \binom{m}{k} k x^k$$

$$= m + \sum_{k=1}^{\infty} \left[\binom{m}{k+1} (k+1) x^k + \binom{m}{k} k x^k \right] = m + \sum_{k=1}^{\infty} \left[\left(\binom{m}{k+1} (k+1) + \binom{m}{k} k \right) x^k \right].$$

$$\text{Note that: } \binom{m}{k+1} (k+1) + \binom{m}{k} k = \frac{m \cdot (m-1) \cdot \dots \cdot (m-(k+1)+1)}{(k+1)!} (k+1) + \frac{m \cdot (m-1) \cdot \dots \cdot (m-k+1)}{k!} k$$

$$= \frac{m \cdot (m-1) \cdot \dots \cdot (m-k)}{k!} + \frac{m \cdot (m-1) \cdot \dots \cdot (m-k+1)}{k!} k = \frac{m \cdot (m-1) \cdot \dots \cdot (m-k+1)}{k!} ((m-k) + k) = m \frac{m \cdot (m-1) \cdot \dots \cdot (m-k+1)}{k!} = m \binom{m}{k}.$$

$$\text{Thus, } (1+x) \cdot f'(x) = m + \sum_{k=1}^{\infty} \left[\left(\binom{m}{k+1} (k+1) + \binom{m}{k} k \right) x^k \right] = m + \sum_{k=1}^{\infty} \left[m \binom{m}{k} x^k \right] = m + m \sum_{k=1}^{\infty} \binom{m}{k} x^k$$

$$= m \left(1 + \sum_{k=1}^{\infty} \binom{m}{k} x^k \right) = m \cdot f(x) \Rightarrow f'(x) = \frac{m \cdot f(x)}{(1+x)} \text{ if } -1 < x < 1.$$

$$\text{ (b) Let } g(x) = (1+x)^{-m} f(x) \Rightarrow g'(x) = -m(1+x)^{-m-1} f(x) + (1+x)^{-m}$$

$$f'(x) = -m(1+x)^{-m-1} f(x) + (1+x)^{-m} \cdot \frac{m \cdot f(x)}{(1+x)} = -m(1+x)^{-m-1} f(x) + (1+x)^{-m-1} \cdot m \cdot f(x) = 0.$$

$$\text{ (c) } g'(x) = 0 \Rightarrow g(x) = c \Rightarrow (1+x)^{-m} f(x) = c \Rightarrow f(x) = \frac{c}{(1+x)^{-m}} = c(1+x)^m. \text{ Since } f(x) = 1 + \sum_{k=1}^{\infty} \binom{m}{k} x^k$$

$$\Rightarrow f(0) = 1 + \sum_{k=1}^{\infty} \binom{m}{k} (0)^k = 1 + 0 = 1 \Rightarrow c(1+0)^m = 1 \Rightarrow c = 1 \Rightarrow f(x) = (1+x)^m.$$

59. (a) $(1-x^2)^{-1/2} \approx 1 + \frac{x^2}{2} + \frac{3x^4}{8} + \frac{5x^6}{16} \Rightarrow \sin^{-1} x \approx x + \frac{x^3}{6} + \frac{3x^5}{40} + \frac{5x^7}{112};$

Using the Ratio Test: $\lim_{n \rightarrow \infty} \left| \frac{1 \cdot 3 \cdot 5 \cdots (2n-1)(2n+1)x^{2n+3}}{2 \cdot 4 \cdot 6 \cdots (2n)(2n+2)(2n+3)} \cdot \frac{2 \cdot 4 \cdot 6 \cdots (2n)(2n+1)}{1 \cdot 3 \cdot 5 \cdots (2n-1)x^{2n+1}} \right| < 1 \Rightarrow x^2 \lim_{n \rightarrow \infty} \left| \frac{(2n+1)(2n+1)}{(2n+1)(2n+3)} \right| < 1$
 $\Rightarrow |x| < 1 \Rightarrow$ the radius convergence is 1. See Exercise 69.

(b) $\frac{d}{dx}(\cos^{-1} x) = -(1-x^2)^{-1/2} \Rightarrow \cos^{-1} x = \frac{\pi}{2} - \sin^{-1} x \approx \frac{\pi}{2} - \left(x + \frac{x^3}{6} + \frac{3x^5}{40} + \frac{5x^7}{112}\right) \approx \frac{\pi}{2} - x - \frac{x^3}{6} - \frac{3x^5}{40} - \frac{5x^7}{112}$

60. (a) $(1+t^2)^{-1/2} \approx (1)^{-1/2} + (-\frac{1}{2})(1)^{-3/2}(t^2) + \frac{(-\frac{1}{2})(-\frac{3}{2})(1)^{-5/2}(t^2)^2}{2!} + \frac{(-\frac{1}{2})(-\frac{3}{2})(-\frac{5}{2})(1)^{-7/2}(t^2)^3}{3!} = 1 - \frac{t^2}{2} + \frac{3t^4}{2^2 \cdot 2!} - \frac{3 \cdot 5t^6}{2^3 \cdot 3!}$
 $\Rightarrow \sinh^{-1} x \approx \int_0^x \left(1 - \frac{t^2}{2} + \frac{3t^4}{8} - \frac{5t^6}{16}\right) dt = x - \frac{x^3}{6} + \frac{3x^5}{40} - \frac{5x^7}{112}$

(b) $\sinh^{-1}(\frac{1}{4}) \approx \frac{1}{4} - \frac{1}{384} + \frac{3}{40,960} = 0.24746908$; the error is less than the absolute value of the first unused term, $\frac{5x^7}{112}$, evaluated at $t = \frac{1}{4}$ since the series is alternating $\Rightarrow |\text{error}| < \frac{5(\frac{1}{4})^7}{112} \approx 2.725 \times 10^{-6}$

61. $\frac{-1}{1+x} = -\frac{1}{1-(-x)} = -1 + x - x^2 + x^3 - \dots \Rightarrow \frac{d}{dx}\left(\frac{-1}{1+x}\right) = \frac{1}{(1+x)^2} = \frac{d}{dx}(-1 + x - x^2 + x^3 - \dots) = 1 - 2x + 3x^2 - 4x^3 + \dots$

62. $\frac{1}{1-x^2} = 1 + x^2 + x^4 + x^6 + \dots \Rightarrow \frac{d}{dx}\left(\frac{1}{1-x^2}\right) = \frac{2x}{(1-x^2)^2} = \frac{d}{dx}(1 + x^2 + x^4 + x^6 + \dots) = 2x + 4x^3 + 6x^5 + \dots$

63. Wallis' formula gives the approximation $\pi \approx 4 \left[\frac{2 \cdot 4 \cdot 4 \cdot 6 \cdot 6 \cdot 8 \cdots (2n-2) \cdot (2n)}{3 \cdot 3 \cdot 5 \cdot 5 \cdot 7 \cdot 7 \cdots (2n-1) \cdot (2n-1)} \right]$ to produce the table

n	$\sim \pi$
10	3.221088998
20	3.181104886
30	3.167880758
80	3.151425420
90	3.150331383
93	3.150049112
94	3.149959030
95	3.149870848
100	3.149456425

At $n = 1929$ we obtain the first approximation accurate to 3 decimals: 3.141999845. At $n = 30,000$ we still do not obtain accuracy to 4 decimals: 3.141617732, so the convergence to π is very slow. Here is a Maple CAS procedure to produce these approximations:

```
pie :=
proc(n)
local i, j;
a(2) := evalf(8/9)
for i from 3 to n do a(i) := evalf(2*(2*i-2)*i/(2*i-1)^2*a(i-1))od;
[[j, 4*a(j)] $ (j = n-5 .. n)]
end
```

64. (b) See Exercise 68 in Section 8.2 and the corresponding solution in this manual which shows how the formulas for definite integrals of powers of sine and of cosine can be derived from repeated application of the reduction formulas 67 and 68. The given expression for K follows from substituting $k^2 \sin^2 \theta$ for x in the binomial series for $1/\sqrt{1-x}$ and then using the formula for integrals of even powers of sine in Exercise 68 of Section 8.2.

$$\begin{aligned}
 65. \quad (1-x^2)^{-1/2} &= \left(1+(-x^2)\right)^{-1/2} = (1)^{-1/2} + \binom{-1/2}{1} (1)^{-3/2} (-x^2) + \frac{\binom{-1/2}{2} (1)^{-5/2} (-x^2)^2}{2!} + \frac{\binom{-1/2}{3} (1)^{-7/2} (-x^2)^3}{3!} + \dots \\
 &= 1 + \frac{x^2}{2} + \frac{1 \cdot 3 x^4}{2^2 \cdot 2!} + \frac{1 \cdot 3 \cdot 5 x^6}{2^3 \cdot 3!} + \dots = 1 + \sum_{n=1}^{\infty} \frac{1 \cdot 3 \cdot 5 \cdots (2n-1) x^{2n}}{2^n \cdot n!} \\
 \Rightarrow \sin^{-1} x &= \int_0^x (1-t^2)^{-1/2} dt = \int_0^x \left(1 + \sum_{n=1}^{\infty} \frac{1 \cdot 3 \cdot 5 \cdots (2n-1) t^{2n}}{2^n \cdot n!}\right) dt = x + \sum_{n=1}^{\infty} \frac{1 \cdot 3 \cdot 5 \cdots (2n-1) x^{2n+1}}{2 \cdot 4 \cdots (2n)(2n+1)}, \text{ where } |x| < 1
 \end{aligned}$$

$$\begin{aligned}
 66. \quad \left[\tan^{-1} t\right]_x^{\infty} &= \frac{\pi}{2} - \tan^{-1} x = \int_x^{\infty} \frac{dt}{1+t^2} = \int_x^{\infty} \left[\frac{\left(\frac{1}{t^2}\right)}{1+\left(\frac{1}{t^2}\right)}\right] dt = \int_x^{\infty} \left(1 - \frac{1}{t^2} + \frac{1}{t^4} - \frac{1}{t^6} + \dots\right) dt \\
 &= \int_x^{\infty} \left(\frac{1}{t^2} - \frac{1}{t^4} + \frac{1}{t^6} - \frac{1}{t^8} + \dots\right) dt = \lim_{b \rightarrow \infty} \left[-\frac{1}{t} + \frac{1}{3t^3} - \frac{1}{5t^5} + \frac{1}{7t^7} - \dots\right]_x^b = \frac{1}{x} - \frac{1}{3x^3} + \frac{1}{5x^5} - \frac{1}{7x^7} + \dots \\
 \Rightarrow \tan^{-1} x &= \frac{\pi}{2} - \frac{1}{x} + \frac{1}{3x^3} - \frac{1}{5x^5} + \dots, \quad x > 1; \quad \left[\tan^{-1} t\right]_{-\infty}^x = \tan^{-1} x + \frac{\pi}{2} = \int_{-\infty}^x \frac{dt}{1+t^2} \\
 &= \lim_{b \rightarrow -\infty} \left[-\frac{1}{t} + \frac{1}{3t^3} - \frac{1}{5t^5} + \frac{1}{7t^7} - \dots\right]_b^x = -\frac{1}{x} + \frac{1}{3x^3} - \frac{1}{5x^5} + \frac{1}{7x^7} - \dots \Rightarrow \tan^{-1} x = -\frac{\pi}{2} - \frac{1}{x} + \frac{1}{3x^3} - \frac{1}{5x^5} + \dots, \quad x < -1
 \end{aligned}$$

$$\begin{aligned}
 67. \quad (a) \quad e^{-i\pi} &= \cos(-\pi) + i \sin(-\pi) = -1 + i(0) = -1 \\
 (b) \quad e^{i\pi/4} &= \cos\left(\frac{\pi}{4}\right) + i \sin\left(\frac{\pi}{4}\right) = \frac{1}{\sqrt{2}} + \frac{i}{\sqrt{2}} = \left(\frac{1}{\sqrt{2}}\right)(1+i) \\
 (c) \quad e^{-i\pi/2} &= \cos\left(-\frac{\pi}{2}\right) + i \sin\left(-\frac{\pi}{2}\right) = 0 + i(-1) = -i
 \end{aligned}$$

$$\begin{aligned}
 68. \quad e^{i\theta} &= \cos \theta + i \sin \theta \Rightarrow e^{-i\theta} = e^{i(-\theta)} = \cos(-\theta) + i \sin(-\theta) = \cos \theta - i \sin \theta; \\
 e^{i\theta} + e^{-i\theta} &= \cos \theta + i \sin \theta + \cos \theta - i \sin \theta = 2 \cos \theta \Rightarrow \cos \theta = \frac{e^{i\theta} + e^{-i\theta}}{2}; \\
 e^{i\theta} - e^{-i\theta} &= \cos \theta + i \sin \theta - (\cos \theta - i \sin \theta) = 2i \sin \theta \Rightarrow \sin \theta = \frac{e^{i\theta} - e^{-i\theta}}{2i}
 \end{aligned}$$

$$\begin{aligned}
 69. \quad e^x &= 1 + x + \frac{x^2}{2!} + \frac{x^3}{3!} + \frac{x^4}{4!} + \dots \Rightarrow e^{i\theta} = 1 + i\theta + \frac{(i\theta)^2}{2!} + \frac{(i\theta)^3}{3!} + \frac{(i\theta)^4}{4!} + \dots \text{ and} \\
 e^{-i\theta} &= 1 - i\theta + \frac{(-i\theta)^2}{2!} + \frac{(-i\theta)^3}{3!} + \frac{(-i\theta)^4}{4!} + \dots = 1 - i\theta + \frac{(i\theta)^2}{2!} - \frac{(i\theta)^3}{3!} + \frac{(i\theta)^4}{4!} - \dots \\
 \Rightarrow \frac{e^{i\theta} + e^{-i\theta}}{2} &= \frac{\left(1 + i\theta + \frac{(i\theta)^2}{2!} + \frac{(i\theta)^3}{3!} + \frac{(i\theta)^4}{4!} + \dots\right) + \left(1 - i\theta + \frac{(i\theta)^2}{2!} - \frac{(i\theta)^3}{3!} + \frac{(i\theta)^4}{4!} - \dots\right)}{2} = 1 - \frac{\theta^2}{2!} + \frac{\theta^4}{4!} - \frac{\theta^6}{6!} + \dots = \cos \theta; \\
 \frac{e^{i\theta} - e^{-i\theta}}{2i} &= \frac{\left(1 + i\theta + \frac{(i\theta)^2}{2!} + \frac{(i\theta)^3}{3!} + \frac{(i\theta)^4}{4!} + \dots\right) - \left(1 - i\theta + \frac{(i\theta)^2}{2!} - \frac{(i\theta)^3}{3!} + \frac{(i\theta)^4}{4!} - \dots\right)}{2i} = \theta - \frac{\theta^3}{3!} + \frac{\theta^5}{5!} - \frac{\theta^7}{7!} + \dots = \sin \theta
 \end{aligned}$$

70. $e^{i\theta} = \cos \theta + i \sin \theta \Rightarrow e^{-i\theta} = e^{i(-\theta)} = \cos(-\theta) + i \sin(-\theta) = \cos \theta - i \sin \theta$
 (a) $e^{i\theta} + e^{-i\theta} = (\cos \theta + i \sin \theta) + (\cos \theta - i \sin \theta) = 2 \cos \theta \Rightarrow \cos \theta = \frac{e^{i\theta} + e^{-i\theta}}{2} = \cosh i\theta$
 (b) $e^{i\theta} - e^{-i\theta} = (\cos \theta + i \sin \theta) - (\cos \theta - i \sin \theta) = 2i \sin \theta \Rightarrow i \sin \theta = \frac{e^{i\theta} - e^{-i\theta}}{2} = \sinh i\theta$

71. $e^x \sin x = \left(1 + x + \frac{x^2}{2!} + \frac{x^3}{3!} + \frac{x^4}{4!} + \dots\right) \left(x - \frac{x^3}{3!} + \frac{x^5}{5!} - \frac{x^7}{7!} + \dots\right)$
 $= (1)x + (1)x^2 + \left(-\frac{1}{6} + \frac{1}{2}\right)x^3 + \left(-\frac{1}{6} + \frac{1}{6}\right)x^4 + \left(\frac{1}{120} - \frac{1}{12} + \frac{1}{24}\right)x^5 + \dots = x + x^2 + \frac{1}{3}x^3 - \frac{1}{30}x^5 + \dots;$
 $e^x \cdot e^{ix} = e^{(1+i)x} = e^x (\cos x + i \sin x) = e^x \cos x + i(e^x \sin x) \Rightarrow e^x \sin x$ is the series of the imaginary part
 of $e^{(1+i)x}$ which we calculate next; $e^{(1+i)x} = \sum_{n=0}^{\infty} \frac{(x+ix)^n}{n!} = 1 + (x+ix) + \frac{(x+ix)^2}{2!} + \frac{(x+ix)^3}{3!} + \frac{(x+ix)^4}{4!} + \dots$
 $= 1 + x + ix + \frac{1}{2!}(2ix^2) + \frac{1}{3!}(2ix^3 - 2x^3) + \frac{1}{4!}(-4x^4) + \frac{1}{5!}(-4ix^5 - 4ix^5) + \frac{1}{6!}(-8ix^6) + \dots \Rightarrow$ the imaginary part of
 $e^{(1+i)x}$ is $x + \frac{2}{2!}x^2 + \frac{2}{3!}x^3 - \frac{4}{5!}x^5 - \frac{8}{6!}x^6 + \dots = x + x^2 + \frac{1}{3}x^3 - \frac{1}{30}x^5 - \frac{1}{90}x^6 + \dots$ in agreement with our
 product calculation. The series for $e^x \sin x$ converges for all values of x .

72. $\frac{d}{dx}(e^{(a+ib)x}) = \frac{d}{dx}[e^{ax}(\cos bx + i \sin bx)] = ae^{ax}(\cos bx + i \sin bx) + e^{ax}(-b \sin bx + bi \cos bx)$
 $= ae^{ax}(\cos bx + i \sin bx) + bie^{ax}(\cos bx + i \sin bx) = ae^{(a+ib)x} + ibe^{(a+ib)x} = (a+ib)e^{(a+ib)x}$

73. (a) $e^{i\theta_1} e^{i\theta_2} = (\cos \theta_1 + i \sin \theta_1)(\cos \theta_2 + i \sin \theta_2)$
 $= (\cos \theta_1 \cos \theta_2 - \sin \theta_1 \sin \theta_2) + i(\sin \theta_1 \cos \theta_2 + \sin \theta_2 \cos \theta_1) = \cos(\theta_1 + \theta_2) + i \sin(\theta_1 + \theta_2) = e^{i(\theta_1 + \theta_2)}$
 (b) $e^{-i\theta} = \cos(-\theta) + i \sin(-\theta) = \cos \theta - i \sin \theta = (\cos \theta - i \sin \theta) \left(\frac{\cos \theta + i \sin \theta}{\cos \theta + i \sin \theta}\right) = \frac{1}{\cos \theta + i \sin \theta} = \frac{1}{e^{i\theta}}$

74. $\frac{a-bi}{a^2+b^2} e^{(a+bi)x} + C_1 + iC_2 = \left(\frac{a-bi}{a^2+b^2}\right) e^{ax} (\cos bx + i \sin bx) + C_1 + iC_2$
 $= \frac{e^{ax}}{a^2+b^2} (a \cos bx + ia \sin bx - ib \cos bx + b \sin bx) + C_1 + iC_2$
 $= \frac{e^{ax}}{a^2+b^2} [(a \cos bx + b \sin bx) + (a \sin bx - b \cos bx)i] + C_1 + iC_2$
 $= \frac{e^{ax}(a \cos bx + b \sin bx)}{a^2+b^2} + C_1 + \frac{ie^{ax}(a \sin bx - b \cos bx)}{a^2+b^2} + iC_2;$
 $e^{(a+bi)x} = e^{ax} e^{ibx} = e^{ax} (\cos bx + i \sin bx) = e^{ax} \cos bx + ie^{ax} \sin bx$, so that given
 $\int e^{(a+bi)x} dx = \frac{a-bi}{a^2+b^2} e^{(a+bi)x} + C_1 + iC_2$ we conclude that $\int e^{ax} \cos bx dx = \frac{e^{ax}(a \cos bx + b \sin bx)}{a^2+b^2} + C_1$ and
 $\int e^{ax} \sin bx dx = \frac{e^{ax}(a \sin bx - b \cos bx)}{a^2+b^2} + C_2$

CHAPTER 10 PRACTICE EXERCISES

1. converges to 1, since $\lim_{n \rightarrow \infty} a_n = \lim_{n \rightarrow \infty} \left(1 + \frac{(-1)^n}{n}\right) = 1$
2. converges to 0, since $0 \leq a_n \leq \frac{2}{\sqrt{n}}$, $\lim_{n \rightarrow \infty} 0 = 0$, $\lim_{n \rightarrow \infty} \frac{2}{\sqrt{n}} = 0$ using the Sandwich Theorem for Sequences
3. converges to -1 , since $\lim_{n \rightarrow \infty} a_n = \lim_{n \rightarrow \infty} \left(\frac{1-2^n}{2^n}\right) = \lim_{n \rightarrow \infty} \left(\frac{1}{2^n} - 1\right) = -1$
4. converges to 1, since $\lim_{n \rightarrow \infty} a_n = \lim_{n \rightarrow \infty} \left[1 + (0.9)^n\right] = 1 + 0 = 1$
5. diverges, since $\left\{\sin \frac{n\pi}{2}\right\} = \{0, 1, 0, -1, 0, 1, \dots\}$
6. converges to 0, since $\{\sin n\pi\} = \{0, 0, 0, \dots\}$
7. converges to 0, since $\lim_{n \rightarrow \infty} a_n = \lim_{n \rightarrow \infty} \frac{\ln n^2}{n} = 2 \lim_{n \rightarrow \infty} \frac{\left(\frac{1}{n}\right)}{1} = 0$
8. converges to 0, since $\lim_{n \rightarrow \infty} a_n = \lim_{n \rightarrow \infty} \frac{\ln(2n+1)}{n} = \lim_{n \rightarrow \infty} \frac{\left(\frac{2}{2n+1}\right)}{1} = 0$
9. converges to 1, since $\lim_{n \rightarrow \infty} a_n = \lim_{n \rightarrow \infty} \left(\frac{n+\ln n}{n}\right) = \lim_{n \rightarrow \infty} \frac{1+\left(\frac{1}{n}\right)}{1} = 1$
10. converges to 0, since $\lim_{n \rightarrow \infty} a_n = \lim_{n \rightarrow \infty} \frac{\ln(2n^3+1)}{n} = \lim_{n \rightarrow \infty} \frac{\left(\frac{6n^2}{2n^3+1}\right)}{1} = \lim_{n \rightarrow \infty} \frac{12n}{6n^2} = \lim_{n \rightarrow \infty} \frac{2}{n} = 0$
11. converges to e^{-5} , since $\lim_{n \rightarrow \infty} a_n = \lim_{n \rightarrow \infty} \left(\frac{n-5}{n}\right)^n = \lim_{n \rightarrow \infty} \left(1 + \frac{(-5)}{n}\right)^n = e^{-5}$ by Theorem 5
12. converges to $\frac{1}{e}$, since $\lim_{n \rightarrow \infty} a_n = \lim_{n \rightarrow \infty} \left(1 + \frac{1}{n}\right)^{-n} = \lim_{n \rightarrow \infty} \frac{1}{\left(1 + \frac{1}{n}\right)^n} = \frac{1}{e}$ by Theorem 5
13. converges to 3, since $\lim_{n \rightarrow \infty} a_n = \lim_{n \rightarrow \infty} \left(\frac{3^n}{n}\right)^{1/n} = \lim_{n \rightarrow \infty} \frac{3}{n^{1/n}} = \frac{3}{1} = 3$ by Theorem 5
14. converges to 1, since $\lim_{n \rightarrow \infty} a_n = \lim_{n \rightarrow \infty} \left(\frac{3}{n}\right)^{1/n} = \lim_{n \rightarrow \infty} \frac{3^{1/n}}{n^{1/n}} = \frac{1}{1} = 1$ by Theorem 5

15. converges to $\ln 2$, since $\lim_{n \rightarrow \infty} a_n = \lim_{n \rightarrow \infty} n(2^{1/n} - 1) = \lim_{n \rightarrow \infty} \frac{2^{1/n} - 1}{\left(\frac{1}{n}\right)} = \lim_{n \rightarrow \infty} \frac{\left[\frac{(-2^{1/n} \ln 2)}{n^2}\right]}{\left(\frac{-1}{n^2}\right)} = \lim_{n \rightarrow \infty} 2^{1/n} \ln 2 = 2^0 \cdot \ln 2 = \ln 2$

16. converges to 1, since $\lim_{n \rightarrow \infty} a_n = \lim_{n \rightarrow \infty} \sqrt[n]{2n+1} = \lim_{n \rightarrow \infty} \exp\left(\frac{\ln(2n+1)}{n}\right) = \lim_{n \rightarrow \infty} \exp\left(\frac{\frac{2}{2n+1}}{1}\right) = e^0 = 1$

17. diverges, since $\lim_{n \rightarrow \infty} a_n = \lim_{n \rightarrow \infty} \frac{(n+1)!}{n!} = \lim_{n \rightarrow \infty} (n+1) = \infty$

18. converges to 0, since $\lim_{n \rightarrow \infty} a_n = \lim_{n \rightarrow \infty} \frac{(-4)^n}{n!} = 0$ by Theorem 5

19. $\frac{1}{(2n-3)(2n-1)} = \frac{\left(\frac{1}{2}\right)}{2n-3} - \frac{\left(\frac{1}{2}\right)}{2n-1} \Rightarrow s_n = \left[\frac{\left(\frac{1}{2}\right)}{3} - \frac{\left(\frac{1}{2}\right)}{5}\right] + \left[\frac{\left(\frac{1}{2}\right)}{5} - \frac{\left(\frac{1}{2}\right)}{7}\right] + \dots + \left[\frac{\left(\frac{1}{2}\right)}{2n-3} - \frac{\left(\frac{1}{2}\right)}{2n-1}\right] = \frac{\left(\frac{1}{2}\right)}{3} - \frac{\left(\frac{1}{2}\right)}{2n-1}$
 $\Rightarrow \lim_{n \rightarrow \infty} s_n = \lim_{n \rightarrow \infty} \left[\frac{1}{6} - \frac{\left(\frac{1}{2}\right)}{2n-1}\right] = \frac{1}{6}$

20. $\frac{-2}{n(n+1)} = \frac{-2}{n} + \frac{2}{n+1} \Rightarrow s_n = \left(\frac{-2}{2} + \frac{2}{3}\right) + \left(\frac{-2}{3} + \frac{2}{4}\right) + \dots + \left(\frac{-2}{n} + \frac{2}{n+1}\right) = -\frac{2}{2} + \frac{2}{n+1} \Rightarrow \lim_{n \rightarrow \infty} s_n = \lim_{n \rightarrow \infty} \left(-1 + \frac{2}{n+1}\right) = -1$

21. $\frac{9}{(3n-1)(3n+2)} = \frac{3}{3n-1} - \frac{3}{3n+2} \Rightarrow s_n = \left(\frac{3}{2} - \frac{3}{5}\right) + \left(\frac{3}{5} - \frac{3}{8}\right) + \left(\frac{3}{8} - \frac{3}{11}\right) + \dots + \left(\frac{3}{3n-1} - \frac{3}{3n+2}\right) = \frac{3}{2} - \frac{3}{3n+2}$
 $\Rightarrow \lim_{n \rightarrow \infty} s_n = \lim_{n \rightarrow \infty} \left(\frac{3}{2} - \frac{3}{3n+2}\right) = \frac{3}{2}$

22. $\frac{-8}{(4n-3)(4n+1)} = \frac{-2}{4n-3} + \frac{2}{4n+1} \Rightarrow s_n = \left(\frac{-2}{9} + \frac{2}{13}\right) + \left(\frac{-2}{13} + \frac{2}{17}\right) + \left(\frac{-2}{17} + \frac{2}{21}\right) + \dots + \left(\frac{-2}{4n-3} + \frac{2}{4n+1}\right) = -\frac{2}{9} + \frac{2}{4n+1}$
 $\Rightarrow \lim_{n \rightarrow \infty} s_n = \lim_{n \rightarrow \infty} \left(-\frac{2}{9} + \frac{2}{4n+1}\right) = -\frac{2}{9}$

23. $\sum_{n=0}^{\infty} e^{-n} = \sum_{n=0}^{\infty} \frac{1}{e^n}$, a convergent geometric series with $r = \frac{1}{e}$ and $a = 1 \Rightarrow$ the sum is $\frac{1}{1 - \left(\frac{1}{e}\right)} = \frac{e}{e-1}$

24. $\sum_{n=1}^{\infty} (-1)^n \frac{3}{4^n} = \sum_{n=0}^{\infty} \left(-\frac{3}{4}\right) \left(\frac{-1}{4}\right)^n$ a convergent geometric series with $r = -\frac{1}{4}$ and $a = \frac{-3}{4} \Rightarrow$ the sum is $\frac{\left(-\frac{3}{4}\right)}{1 - \left(-\frac{1}{4}\right)} = -\frac{3}{5}$

25. diverges, a p -series with $p = \frac{1}{2}$

26. $\sum_{n=1}^{\infty} \frac{-5}{n} = -5 \sum_{n=1}^{\infty} \frac{1}{n}$, diverges since it is a nonzero multiple of the divergent harmonic series

27. Since $f(x) = \frac{1}{x^{1/2}} \Rightarrow f'(x) = -\frac{1}{2x^{3/2}} < 0 \Rightarrow f(x)$ is decreasing $\Rightarrow a_{n+1} < a_n$, and $\lim_{n \rightarrow \infty} a_n = \lim_{n \rightarrow \infty} \frac{1}{\sqrt{n}} = 0$, the series $\sum_{n=1}^{\infty} \frac{(-1)^n}{\sqrt{n}}$ converges by the Alternating Series Test. Since $\sum_{n=1}^{\infty} \frac{1}{\sqrt{n}}$ diverges, the given series converges conditionally.
28. converges absolutely by the Comparison Test since $\frac{1}{2n^3} < \frac{1}{n^3}$ for $n \geq 1$, which is the n th term of a convergent p -series
29. The given series does not converge absolutely by the Direct Comparison Test since $\frac{1}{\ln(n+1)} > \frac{1}{n+1}$, which is the n th term of a divergent series. Since $f(x) = \frac{1}{\ln(x+1)} \Rightarrow f'(x) = -\frac{1}{(\ln(x+1))^2(x+1)} < 0 \Rightarrow f(x)$ is decreasing $\Rightarrow a_{n+1} < a_n$, and $\lim_{n \rightarrow \infty} a_n = \lim_{n \rightarrow \infty} \frac{1}{\ln(n+1)} = 0$, the given series converges conditionally by the Alternating Series Test.
30. $\int_2^{\infty} \frac{1}{x(\ln x)^2} dx = \lim_{b \rightarrow \infty} \int_2^b \frac{1}{x(\ln x)^2} dx = \lim_{b \rightarrow \infty} \left[-(\ln x)^{-1} \right]_2^b = -\lim_{b \rightarrow \infty} \left(\frac{1}{\ln b} - \frac{1}{\ln 2} \right) = \frac{1}{\ln 2} \Rightarrow$ the series converges absolutely by the Integral Test
31. converges absolutely by the Direct Comparison Test since $\frac{\ln n}{n^3} < \frac{n}{n^3} = \frac{1}{n^2}$, the n th term of a convergent p -series
32. diverges by the Direct Comparison Test for $e^{n^n} > n \Rightarrow \ln(e^{n^n}) > \ln n \Rightarrow n^n > \ln n \Rightarrow \ln n^n > \ln(\ln n) \Rightarrow n \ln n > \ln(\ln n) \Rightarrow \frac{\ln n}{\ln(\ln n)} > \frac{1}{n}$, the n th term of the divergent harmonic series
33. $\lim_{n \rightarrow \infty} \frac{\left(\frac{1}{n\sqrt{n^2+1}} \right)}{\left(\frac{1}{n^2} \right)} = \sqrt{\lim_{n \rightarrow \infty} \frac{n^2}{n^2+1}} = \sqrt{1} = 1 \Rightarrow$ converges absolutely by the Limit Comparison Test
34. Since $f(x) = \frac{3x^2}{x^3+1} \Rightarrow f'(x) = \frac{3x(2-x^3)}{(x^3+1)^2} < 0$ when $x \geq 2 \Rightarrow a_{n+1} < a_n$ for $n \geq 2$ and $\lim_{n \rightarrow \infty} \frac{3n^2}{n^3+1} = 0$, the series converges by the Alternating Series Test. The series does not converge absolutely: By the Limit Comparison Test, $\lim_{n \rightarrow \infty} \frac{\left(\frac{3n^2}{n^3+1} \right)}{\left(\frac{1}{n} \right)} = \lim_{n \rightarrow \infty} \frac{3n^3}{n^3+1} = 3$. Therefore the convergence is conditional.
35. converges absolutely by the Ratio Test since $\lim_{n \rightarrow \infty} \left[\frac{n+2}{(n+1)!} \cdot \frac{n!}{n+1} \right] = \lim_{n \rightarrow \infty} \frac{n+2}{(n+1)^2} = 0 < 1$
36. diverges since $\lim_{n \rightarrow \infty} a_n = \lim_{n \rightarrow \infty} \frac{(-1)^n(n^2+1)}{2n^2+n-1}$ does not exist

37. converges absolutely by the Ratio Test since $\lim_{n \rightarrow \infty} \left[\frac{3^{n+1}}{(n+1)!} \cdot \frac{n!}{3^n} \right] = \lim_{n \rightarrow \infty} \frac{3}{n+1} = 0 < 1$

38. converges absolutely by the Root Test since $\lim_{n \rightarrow \infty} \sqrt[n]{|a_n|} = \lim_{n \rightarrow \infty} \sqrt[n]{\frac{2^n 3^n}{n^n}} = \lim_{n \rightarrow \infty} \frac{6}{n} = 0 < 1$

39. converges absolutely by the Limit Comparison Test since $\lim_{n \rightarrow \infty} \frac{\left(\frac{1}{n^{3/2}}\right)}{\left(\frac{1}{\sqrt{n(n+1)(n+2)}}\right)} = \sqrt{\lim_{n \rightarrow \infty} \frac{n(n+1)(n+2)}{n^3}} = 1$

40. converges absolutely by the Limit Comparison Test since $\lim_{n \rightarrow \infty} \frac{\left(\frac{1}{n^2}\right)}{\left(\frac{1}{n\sqrt{n^2-1}}\right)} = \sqrt{\lim_{n \rightarrow \infty} \frac{n^2(n^2-1)}{n^4}} = 1$

41. $\lim_{n \rightarrow \infty} \left| \frac{u_{n+1}}{u_n} \right| < 1 \Rightarrow \lim_{n \rightarrow \infty} \left| \frac{(x+4)^{n+1}}{(n+1)3^{n+1}} \cdot \frac{n3^n}{(x+4)^n} \right| < 1 \Rightarrow \frac{|x+4|}{3} \lim_{n \rightarrow \infty} \left(\frac{n}{n+1} \right) < 1 \Rightarrow \frac{|x+4|}{3} < 1 \Rightarrow |x+4| < 3 \Rightarrow -3 < x+4 < 3$

$\Rightarrow -7 < x < -1$; at $x = -7$ we have $\sum_{n=1}^{\infty} \frac{(-1)^n 3^n}{n3^n} = \sum_{n=1}^{\infty} \frac{(-1)^n}{n}$, the alternating harmonic series, which converges

conditionally; at $x = -1$ we have $\sum_{n=1}^{\infty} \frac{3^n}{n3^n} = \sum_{n=1}^{\infty} \frac{1}{n}$, the divergent harmonic series

(a) the radius is 3; the interval of convergence is $-7 \leq x < -1$

(b) the interval of absolute convergence is $-7 < x < -1$

(c) the series converges conditionally at $x = -7$

42. $\lim_{n \rightarrow \infty} \left| \frac{u_{n+1}}{u_n} \right| < 1 \Rightarrow \lim_{n \rightarrow \infty} \left| \frac{(x-1)^{2n}}{(2n+1)!} \cdot \frac{(2n-1)!}{(x-1)^{2n-2}} \right| < 1 \Rightarrow (x-1)^2 \lim_{n \rightarrow \infty} \frac{1}{(2n)(2n+1)} = 0 < 1$, which holds for all x

(a) the radius is ∞ ; the series converges for all x

(b) the series converges absolutely for all x

(c) there are no values for which the series converges conditionally

43. $\lim_{n \rightarrow \infty} \left| \frac{u_{n+1}}{u_n} \right| < 1 \Rightarrow \lim_{n \rightarrow \infty} \left| \frac{(3x-1)^{n+1}}{(n+1)^2} \cdot \frac{n^2}{(3x-1)^n} \right| < 1 \Rightarrow |3x-1| \lim_{n \rightarrow \infty} \frac{n^2}{(n+1)^2} < 1 \Rightarrow |3x-1| < 1 \Rightarrow -1 < 3x-1 < 1$

$\Rightarrow 0 < 3x < 2 \Rightarrow 0 < x < \frac{2}{3}$; at $x = 0$ we have $\sum_{n=1}^{\infty} \frac{(-1)^{n-1}(-1)^n}{n^2} = \sum_{n=1}^{\infty} \frac{(-1)^{2n-1}}{n^2} = -\sum_{n=1}^{\infty} \frac{1}{n^2}$, a nonzero constant

multiple of a convergent p -series which is absolutely convergent; at $x = \frac{2}{3}$ we have $\sum_{n=1}^{\infty} \frac{(-1)^{n-1}(1)^n}{n^2} = \sum_{n=1}^{\infty} \frac{(-1)^{n-1}}{n^2}$,

which converges absolutely

(a) the radius is $\frac{1}{3}$; the interval of convergence is $0 \leq x \leq \frac{2}{3}$

(b) the interval of absolute convergence is $0 \leq x \leq \frac{2}{3}$

(c) there are no values for which the series converges conditionally

$$44. \lim_{n \rightarrow \infty} \left| \frac{u_{n+1}}{u_n} \right| < 1 \Rightarrow \lim_{n \rightarrow \infty} \left| \frac{n+2}{2n+3} \cdot \frac{(2x-1)^{n+1}}{2^{n+1}} \cdot \frac{2n+1}{n+1} \cdot \frac{2^n}{(2x+1)^n} \right| < 1 \Rightarrow \frac{|2x+1|}{2} \lim_{n \rightarrow \infty} \left| \frac{n+2}{2n+3} \cdot \frac{2n+1}{n+1} \right| < 1 \Rightarrow \frac{|2x+1|}{2} (1) < 1$$

$$\Rightarrow |2x+1| < 2 \Rightarrow -2 < 2x+1 < 2 \Rightarrow -3 < 2x < 1 \Rightarrow -\frac{3}{2} < x < \frac{1}{2}; \text{ at } x = -\frac{3}{2} \text{ we have}$$

$$\sum_{n=1}^{\infty} \frac{n+1}{2n+1} \cdot \frac{(-2)^n}{2^n} = \sum_{n=1}^{\infty} \frac{(-1)^n (n+1)}{2n+1} \text{ which diverges by the } n\text{th-Term Test for Divergence since } \lim_{n \rightarrow \infty} \left(\frac{n+1}{2n+1} \right) = \frac{1}{2} \neq 0;$$

$$\text{at } x = \frac{1}{2} \text{ we have } \sum_{n=1}^{\infty} \frac{n+1}{2n+1} \cdot \frac{2^n}{2^n} = \sum_{n=1}^{\infty} \frac{n+1}{2n+1}, \text{ which diverges by the } n\text{th-Term Test}$$

(a) the radius is 1; the interval of convergence is $-\frac{3}{2} < x < \frac{1}{2}$

(b) the interval of absolute convergence is $-\frac{3}{2} < x < \frac{1}{2}$

(c) there are no values for which the series converges conditionally

$$45. \lim_{n \rightarrow \infty} \left| \frac{u_{n+1}}{u_n} \right| < 1 \Rightarrow \lim_{n \rightarrow \infty} \left| \frac{x^{n+1}}{(n+1)^{n+1}} \cdot \frac{n^n}{x^n} \right| < 1 \Rightarrow |x| \lim_{n \rightarrow \infty} \left| \left(\frac{n}{n+1} \right)^n \left(\frac{1}{n+1} \right) \right| < 1 \Rightarrow \frac{|x|}{e} \lim_{n \rightarrow \infty} \left(\frac{1}{n+1} \right) < 1 \Rightarrow \frac{|x|}{e} \cdot 0 < 1, \text{ which holds}$$

for all x

(a) the radius is ∞ ; the series converges for all x

(b) the series converges absolutely for all x

(c) there are no values for which the series converges conditionally

$$46. \lim_{n \rightarrow \infty} \left| \frac{u_{n+1}}{u_n} \right| < 1 \Rightarrow \lim_{n \rightarrow \infty} \left| \frac{x^{n+1}}{\sqrt{n+1}} \cdot \frac{\sqrt{n}}{x^n} \right| < 1 \Rightarrow |x| \lim_{n \rightarrow \infty} \sqrt{\frac{n}{n+1}} < 1 \Rightarrow |x| < 1; \text{ when } x = -1 \text{ we have } \sum_{n=1}^{\infty} \frac{(-1)^n}{\sqrt{n}}, \text{ which}$$

$$\text{converges by the Alternating Series Test; when } x = 1 \text{ we have } \sum_{n=1}^{\infty} \frac{1}{\sqrt{n}}, \text{ a divergent } p\text{-series}$$

(a) the radius is 1; the interval of convergence is $-1 \leq x < 1$

(b) the interval of absolute convergence is $-1 < x < 1$

(c) the series converges conditionally at $x = -1$

$$47. \lim_{n \rightarrow \infty} \left| \frac{u_{n+1}}{u_n} \right| < 1 \Rightarrow \lim_{n \rightarrow \infty} \left| \frac{(n+2)x^{2n+1}}{3^{n+1}} \cdot \frac{3^n}{(n+1)x^{2n-1}} \right| < 1 \Rightarrow \frac{x^2}{3} \lim_{n \rightarrow \infty} \left(\frac{n+2}{n+1} \right) < 1 \Rightarrow -\sqrt{3} < x < \sqrt{3};$$

$$\text{the series } \sum_{n=1}^{\infty} -\frac{n+1}{\sqrt{3}} \text{ and } \sum_{n=1}^{\infty} \frac{n+1}{\sqrt{3}}, \text{ obtained with } x = \pm\sqrt{3}, \text{ both diverge}$$

(a) the radius is $\sqrt{3}$; the interval of convergence is $-\sqrt{3} < x < \sqrt{3}$

(b) the interval of absolute convergence is $-\sqrt{3} < x < \sqrt{3}$

(c) there are no values for which the series converges conditionally

$$48. \lim_{n \rightarrow \infty} \left| \frac{u_{n+1}}{u_n} \right| < 1 \Rightarrow \lim_{n \rightarrow \infty} \left| \frac{(x-1)x^{2n+3}}{2n+3} \cdot \frac{2n+1}{(x-1)x^{2n+1}} \right| < 1 \Rightarrow (x-1)^2 \lim_{n \rightarrow \infty} \left(\frac{2n+1}{2n+3} \right) < 1 \Rightarrow (x-1)^2 (1) < 1 \Rightarrow (x-1)^2 < 1$$

$$\Rightarrow |x-1| < 1 \Rightarrow -1 < x-1 < 1 \Rightarrow 0 < x < 2; \text{ at } x = 0 \text{ we have } \sum_{n=1}^{\infty} \frac{(-1)^n (-1)^{2n+1}}{2n+1} = \sum_{n=1}^{\infty} \frac{(-1)^{3n+1}}{2n+1} = \sum_{n=1}^{\infty} \frac{(-1)^{n-1}}{2n+1} \text{ which}$$

$$\text{converges conditionally by the Alternating Series Test and the fact that } \sum_{n=1}^{\infty} \frac{1}{2n+1} \text{ diverges; at } x = 2 \text{ we have}$$

$$\sum_{n=1}^{\infty} \frac{(-1)^n (1)^{2n+1}}{2n+1} = \sum_{n=1}^{\infty} \frac{(-1)^n}{2n+1}, \text{ which also converges conditionally}$$

(a) the radius is 1; the interval of convergence is $0 \leq x \leq 2$

(b) the interval of absolute convergence is $0 < x < 2$

(c) the series converges conditionally at $x = 0$ and $x = 2$

$$49. \lim_{n \rightarrow \infty} \left| \frac{u_{n+1}}{u_n} \right| < 1 \Rightarrow \lim_{n \rightarrow \infty} \left| \frac{\operatorname{csch}(n+1)x^{n+1}}{\operatorname{csch}(n)x^n} \right| < 1 \Rightarrow |x| \lim_{n \rightarrow \infty} \left| \frac{\left(\frac{2}{e^{n+1} - e^{-n-1}} \right)}{\left(\frac{2}{e^n - e^{-n}} \right)} \right| < 1 \Rightarrow |x| \lim_{n \rightarrow \infty} \left| \frac{e^{-1} - e^{-2n-1}}{1 - e^{-2n-2}} \right| < 1 \Rightarrow \frac{|x|}{e} < 1$$

$\Rightarrow -e < x < e$; the series $\sum_{n=1}^{\infty} (\pm e)^n \operatorname{csch} n$, obtained with $x = \pm e$, both diverge since $\lim_{n \rightarrow \infty} (\pm e)^n \operatorname{csch} n \neq 0$

- (a) the radius is e ; the interval of convergence is $-e < x < e$
 (b) the interval of absolute convergence is $-e < x < e$
 (c) there are no values for which the series converges conditionally

$$50. \lim_{n \rightarrow \infty} \left| \frac{u_{n+1}}{u_n} \right| < 1 \Rightarrow \lim_{n \rightarrow \infty} \left| \frac{x^{n+1} \coth(n+1)}{x^n \coth(n)} \right| < 1 \Rightarrow |x| \lim_{n \rightarrow \infty} \left| \frac{1+e^{-2n-2}}{1-e^{-2n-2}} \cdot \frac{1-e^{-2n}}{1+e^{-2n}} \right| < 1 \Rightarrow |x| < 1 \Rightarrow -1 < x < 1;$$

the series $\sum_{n=1}^{\infty} (\pm 1)^n \coth n$, obtained with $x = \pm 1$, both diverge since $\lim_{n \rightarrow \infty} (\pm 1)^n \coth n \neq 0$

- (a) the radius is 1; the interval of convergence is $-1 < x < 1$
 (b) the interval of absolute convergence is $-1 < x < 1$
 (c) there are no values for which the series converges conditionally

$$51. \text{ The given series has the form } 1 - x + x^2 - x^3 + \dots + (-x)^n + \dots = \frac{1}{1+x}, \text{ where } x = \frac{1}{4}; \text{ the sum is } \frac{1}{1+(\frac{1}{4})} = \frac{4}{5}$$

$$52. \text{ The given series has the form } x - \frac{x^2}{2} + \frac{x^3}{3} - \dots + (-1)^{n-1} \frac{x^n}{n} + \dots = \ln(1+x), \text{ where } x = \frac{2}{3}; \text{ the sum is } \ln\left(\frac{5}{3}\right) \approx 0.510825624$$

$$53. \text{ The given series has the form } x - \frac{x^3}{3!} + \frac{x^5}{5!} - \dots + (-1)^n \frac{x^{2n+1}}{(2n+1)!} + \dots = \sin x, \text{ where } x = \pi; \text{ the sum is } \sin \pi = 0$$

$$54. \text{ The given series has the form } 1 - \frac{x^2}{2!} + \frac{x^4}{4!} - \dots + (-1)^n \frac{x^{2n}}{(2n)!} + \dots = \cos x, \text{ where } x = \frac{\pi}{3}; \text{ the sum is } \cos \frac{\pi}{3} = \frac{1}{2}$$

$$55. \text{ The given series has the form } 1 + x + \frac{x^2}{2!} + \frac{x^3}{3!} + \dots + \frac{x^n}{n!} + \dots = e^x, \text{ where } x = \ln 2; \text{ the sum is } e^{\ln(2)} = 2$$

$$56. \text{ The given series has the form } x - \frac{x^3}{3} + \frac{x^5}{5} - \dots + (-1)^n \frac{x^{2n-1}}{(2n-1)} + \dots = \tan^{-1} x, \text{ where } x = \frac{1}{\sqrt{3}}; \text{ the sum is } \tan^{-1}\left(\frac{1}{\sqrt{3}}\right) = \frac{\pi}{6}$$

$$57. \text{ Consider } \frac{1}{1-2x} \text{ as the sum of a convergent geometric series with } a = 1 \text{ and } r = 2x$$

$$\Rightarrow \frac{1}{1-2x} = 1 + (2x) + (2x)^2 + (2x)^3 + \dots = \sum_{n=0}^{\infty} (2x)^n = \sum_{n=0}^{\infty} 2^n x^n \text{ where } |2x| < 1 \Rightarrow |x| < \frac{1}{2}$$

$$58. \text{ Consider } \frac{1}{1-x^3} \text{ as the sum of a convergent geometric series with } a = 1 \text{ and } r = -x^3$$

$$\Rightarrow \frac{1}{1+x^3} = \frac{1}{1-(-x^3)} = 1 + (-x^3) + (-x^3)^2 + (-x^3)^3 + \dots = \sum_{n=0}^{\infty} (-1)^n x^{3n} \text{ where } |-x^3| < 1 \Rightarrow |x^3| < 1 \Rightarrow |x| < 1$$

$$59. \sin x = \sum_{n=0}^{\infty} \frac{(-1)^n x^{2n+1}}{(2n+1)!} \Rightarrow \sin \pi x = \sum_{n=0}^{\infty} \frac{(-1)^n (\pi x)^{2n+1}}{(2n+1)!} = \sum_{n=0}^{\infty} \frac{(-1)^n \pi^{2n+1} x^{2n+1}}{(2n+1)!}$$

$$60. \sin x = \sum_{n=0}^{\infty} \frac{(-1)^n x^{2n+1}}{(2n+1)!} \Rightarrow \sin \frac{2x}{3} = \sum_{n=0}^{\infty} \frac{(-1)^n \left(\frac{2x}{3}\right)^{2n+1}}{(2n+1)!} = \sum_{n=0}^{\infty} \frac{(-1)^n 2^{2n+1} x^{2n+1}}{3^{2n+1} (2n+1)!}$$

$$61. \cos x = \sum_{n=0}^{\infty} \frac{(-1)^n x^{2n}}{(2n)!} \Rightarrow \cos(x^{5/3}) = \sum_{n=0}^{\infty} \frac{(-1)^n (x^{5/3})^{2n}}{(2n)!} = \sum_{n=0}^{\infty} \frac{(-1)^n x^{10n/3}}{(2n)!}$$

$$62. \cos x = \sum_{n=0}^{\infty} \frac{(-1)^n x^{2n}}{(2n)!} \Rightarrow \cos\left(\frac{x^3}{\sqrt{5}}\right) = \sum_{n=0}^{\infty} \frac{(-1)^n \left(\frac{x^3}{\sqrt{5}}\right)^{2n}}{(2n)!} = \sum_{n=0}^{\infty} \frac{(-1)^n x^{6n}}{5^n (2n)!}$$

$$63. e^x = \sum_{n=0}^{\infty} \frac{x^n}{n!} \Rightarrow e^{(\pi x/2)} = \sum_{n=0}^{\infty} \frac{\left(\frac{\pi x}{2}\right)^n}{n!} = \sum_{n=0}^{\infty} \frac{\pi^n x^n}{2^n n!}$$

$$64. e^x = \sum_{n=0}^{\infty} \frac{x^n}{n!} \Rightarrow e^{-x^2} = \sum_{n=0}^{\infty} \frac{(-x^2)^n}{n!} = \sum_{n=0}^{\infty} \frac{(-1)^n x^{2n}}{n!}$$

$$65. f(x) = \sqrt{3+x^2} = (3+x^2)^{1/2} \Rightarrow f'(x) = x(3+x^2)^{-1/2} \Rightarrow f''(x) = -x^2(3+x^2)^{-3/2} + (3+x^2)^{-1/2} \\ \Rightarrow f'''(x) = 3x^3(3+x^2)^{-5/2} - 3x(3+x^2)^{-3/2}; \quad f(-1) = 2, f'(-1) = -\frac{1}{2}, f''(-1) = -\frac{1}{8} + \frac{1}{2} = \frac{3}{8}, \\ f'''(-1) = -\frac{3}{32} + \frac{3}{8} = \frac{9}{32} \Rightarrow \sqrt{3+x^2} = 2 - \frac{(x+1)}{2!} + \frac{3(x+1)^2}{2^3 \cdot 2!} + \frac{9(x+1)^3}{2^5 \cdot 3!} + \dots$$

$$66. f(x) = \frac{1}{1-x} = (1-x)^{-1} \Rightarrow f'(x) = (1-x)^{-2} \Rightarrow f''(x) = 2(1-x)^{-3} \Rightarrow f'''(x) = 6(1-x)^{-4}; \\ f(2) = -1, f'(2) = 1, f''(2) = -2, f'''(2) = 6 \Rightarrow \frac{1}{1-x} = -1 + (x-2) - (x-2)^2 + (x-2)^3 - \dots$$

$$67. f(x) = \frac{1}{x+1} = (x+1)^{-1} \Rightarrow f'(x) = -(x+1)^{-2} \Rightarrow f''(x) = 2(x+1)^{-3} \Rightarrow f'''(x) = -6(x+1)^{-4}; \\ f(3) = \frac{1}{4}, f'(3) = -\frac{1}{4^2}, f''(3) = \frac{2}{4^3}, f'''(3) = -\frac{6}{4^4} \Rightarrow \frac{1}{x+1} = \frac{1}{4} - \frac{1}{4^2}(x-3) + \frac{1}{4^3}(x-3)^2 - \frac{1}{4^4}(x-3)^3 + \dots$$

$$68. f(x) = \frac{1}{x} = x^{-1} \Rightarrow f'(x) = -x^{-2} \Rightarrow f''(x) = 2x^{-3} \Rightarrow f'''(x) = -6x^{-4}; \\ f(a) = \frac{1}{a}, f'(a) = -\frac{1}{a^2}, f''(a) = \frac{2}{a^3}, f'''(a) = -\frac{6}{a^4} \Rightarrow \frac{1}{x} = \frac{1}{a} - \frac{1}{a^2}(x-a) + \frac{1}{a^3}(x-a)^2 - \frac{1}{a^4}(x-a)^3 + \dots$$

$$69. \int_0^{1/2} e^{-x^3} dx = \int_0^{1/2} \left(1 - x^3 + \frac{x^6}{2!} - \frac{x^9}{3!} + \frac{x^{12}}{4!} + \dots\right) dx = \left[x - \frac{x^4}{4} + \frac{x^7}{7 \cdot 2!} - \frac{x^{10}}{10 \cdot 3!} + \frac{x^{13}}{13 \cdot 4!} - \dots\right]_0^{1/2} \\ \approx \frac{1}{2} - \frac{1}{2^4 \cdot 4} + \frac{1}{2^7 \cdot 7 \cdot 2!} - \frac{1}{2^{10} \cdot 10 \cdot 3!} + \frac{1}{2^{13} \cdot 13 \cdot 4!} - \frac{1}{2^{16} \cdot 16 \cdot 5!} \approx 0.484917143$$

$$70. \int_0^1 x \sin(x^3) dx = \int_0^1 x \left(x^3 - \frac{x^9}{3!} + \frac{x^{15}}{5!} - \frac{x^{21}}{7!} + \frac{x^{27}}{9!} + \dots \right) dx = \int_0^1 \left(x^4 - \frac{x^{10}}{3!} + \frac{x^{16}}{5!} - \frac{x^{22}}{7!} + \frac{x^{28}}{9!} - \dots \right) dx$$

$$= \left[\frac{x^5}{5} - \frac{x^{11}}{11 \cdot 3!} + \frac{x^{17}}{17 \cdot 5!} - \frac{x^{23}}{23 \cdot 7!} + \frac{x^{29}}{29 \cdot 9!} - \dots \right]_0^1 \approx 0.185330149$$

$$71. \int_1^{1/2} \frac{\tan^{-1} x}{x} dx = \int_1^{1/2} \left(1 - \frac{x^2}{3} + \frac{x^4}{5} - \frac{x^6}{7} + \frac{x^8}{9} - \frac{x^{10}}{11} + \dots \right) dx = \left[x - \frac{x^3}{9} + \frac{x^5}{25} - \frac{x^7}{49} + \frac{x^9}{81} - \frac{x^{11}}{121} + \dots \right]_0^{1/2}$$

$$\approx \frac{1}{2} - \frac{1}{9 \cdot 2^3} + \frac{1}{5^2 \cdot 2^5} - \frac{1}{7^2 \cdot 2^7} + \frac{1}{9^2 \cdot 2^9} - \frac{1}{11^2 \cdot 2^{11}} + \frac{1}{13^2 \cdot 2^{13}} - \frac{1}{15^2 \cdot 2^{15}} + \frac{1}{17^2 \cdot 2^{17}} - \frac{1}{19^2 \cdot 2^{19}} + \frac{1}{21^2 \cdot 2^{21}} \approx 0.4872223583$$

$$72. \int_0^{1/64} \frac{\tan^{-1} x}{\sqrt{x}} dx = \int_0^{1/64} \frac{1}{\sqrt{x}} \left(x - \frac{x^3}{3} + \frac{x^5}{5} - \frac{x^7}{7} + \dots \right) dx = \int_0^{1/64} \left(x^{1/2} - \frac{1}{3} x^{5/2} + \frac{1}{5} x^{9/2} - \frac{1}{7} x^{13/2} + \dots \right) dx$$

$$= \left[\frac{2}{3} x^{3/2} - \frac{2}{21} x^{7/2} + \frac{2}{55} x^{11/2} - \frac{2}{105} x^{15/2} + \dots \right]_0^{1/64} = \left(\frac{2}{3 \cdot 8^3} - \frac{2}{21 \cdot 8^7} + \frac{2}{55 \cdot 8^{11}} - \frac{2}{105 \cdot 8^{15}} + \dots \right) \approx 0.0013020379$$

$$73. \lim_{x \rightarrow 0} \frac{7 \sin x}{e^{2x} - 1} = \lim_{x \rightarrow 0} \frac{7 \left(x - \frac{x^3}{3!} + \frac{x^5}{5!} - \dots \right)}{\left(2x + \frac{2^2 x^2}{2!} + \frac{2^3 x^3}{3!} + \dots \right)} = \lim_{x \rightarrow 0} \frac{7 \left(1 - \frac{x^2}{3!} + \frac{x^4}{5!} - \dots \right)}{\left(2 + \frac{2^2 x}{2!} + \frac{2^3 x^2}{3!} + \dots \right)} = \frac{7}{2}$$

$$74. \lim_{\theta \rightarrow 0} \frac{e^\theta - e^{-\theta} - 2\theta}{\theta - \sin \theta} = \lim_{\theta \rightarrow 0} \frac{\left(1 + \theta + \frac{\theta^2}{2!} + \frac{\theta^3}{3!} + \dots \right) - \left(1 - \theta + \frac{\theta^2}{2!} - \frac{\theta^3}{3!} + \dots \right) - 2\theta}{\theta - \left(\theta - \frac{\theta^3}{3!} + \frac{\theta^5}{5!} - \dots \right)} = \lim_{\theta \rightarrow 0} \frac{2 \left(\frac{\theta^3}{3!} + \frac{\theta^5}{5!} + \dots \right)}{\left(\frac{\theta^3}{3!} - \frac{\theta^5}{5!} + \dots \right)} = \lim_{\theta \rightarrow 0} \frac{2 \left(\frac{1}{3!} + \frac{\theta^2}{5!} + \dots \right)}{\left(\frac{1}{3!} - \frac{\theta^2}{5!} + \dots \right)} = 2$$

$$75. \lim_{t \rightarrow 0} \left(\frac{1}{2 - 2 \cos t} - \frac{1}{t^2} \right) = \lim_{t \rightarrow 0} \frac{t^2 - 2 + 2 \cos t}{2t^2(1 - \cos t)} = \lim_{t \rightarrow 0} \frac{t^2 - 2 + 2 \left(1 - \frac{t^2}{2} + \frac{t^4}{4!} - \dots \right)}{2t^2 \left(1 - 1 + \frac{t^2}{2} - \frac{t^4}{4!} + \dots \right)} = \lim_{t \rightarrow 0} \frac{2 \left(\frac{t^4}{4!} - \frac{t^6}{6!} + \dots \right)}{\left(t^4 - \frac{2t^6}{4!} + \dots \right)} = \lim_{t \rightarrow 0} \frac{2 \left(\frac{1}{4!} - \frac{t^2}{6!} + \dots \right)}{\left(1 - \frac{2t^2}{4!} + \dots \right)} = \frac{1}{12}$$

$$76. = \lim_{h \rightarrow 0} \frac{\left(\frac{\sinh h}{h} \right) - \cosh h}{h^2} = \lim_{h \rightarrow 0} \frac{\left(1 - \frac{h^2}{3!} + \frac{h^4}{5!} - \dots \right) - \left(1 - \frac{h^2}{2!} + \frac{h^4}{4!} - \dots \right)}{h^2} = \lim_{h \rightarrow 0} \frac{\left(\frac{h^2}{2!} - \frac{h^2}{3!} + \frac{h^4}{5!} - \frac{h^4}{4!} + \frac{h^6}{6!} - \frac{h^6}{7!} + \dots \right)}{h^2}$$

$$= \lim_{h \rightarrow 0} \left(\frac{1}{2!} - \frac{1}{3!} + \frac{h^2}{5!} - \frac{h^2}{4!} + \frac{h^4}{6!} - \frac{h^4}{7!} + \dots \right) = \frac{1}{3}$$

$$77. \lim_{z \rightarrow 0} \frac{1 - \cos^2 z}{\ln(1-z) + \sin z} = \lim_{z \rightarrow 0} \frac{1 - \left(1 - z^2 + \frac{z^4}{3} - \dots \right)}{\left(-z - \frac{z^2}{2} + \frac{z^3}{3} - \dots \right) + \left(z - \frac{z^3}{3!} + \frac{z^5}{5!} - \dots \right)} = \lim_{z \rightarrow 0} \frac{\left(z^2 - \frac{z^4}{3} + \dots \right)}{\left(-\frac{z^2}{2} - \frac{2z^3}{3} - \frac{z^4}{4} - \dots \right)} = \lim_{z \rightarrow 0} \frac{\left(1 - \frac{z^2}{3} + \dots \right)}{\left(-\frac{1}{2} - \frac{2z}{3} - \frac{z^2}{4} - \dots \right)} = -2$$

$$78. \lim_{y \rightarrow 0} \frac{y^2}{\cos y - \cosh y} = \lim_{y \rightarrow 0} \frac{y^2}{\left(1 - \frac{y^2}{2} + \frac{y^4}{4!} - \frac{y^6}{6!} + \dots \right) - \left(1 + \frac{y^2}{2!} + \frac{y^4}{4!} + \frac{y^6}{6!} + \dots \right)} = \lim_{y \rightarrow 0} \frac{y^2}{\left(-\frac{2y^2}{2} - \frac{2y^6}{6!} - \dots \right)} = \lim_{y \rightarrow 0} \frac{1}{\left(-1 - \frac{2y^4}{6!} - \dots \right)} = -1$$

$$79. \lim_{x \rightarrow 0} \left(\frac{\sin 3x}{x^3} + \frac{r}{x^2} + s \right) = \lim_{x \rightarrow 0} \left[\frac{\left(3x - \frac{(3x)^3}{6} + \frac{(3x)^5}{120} - \dots \right)}{x^3} + \frac{r}{x^2} + s \right] = \lim_{x \rightarrow 0} \left(\frac{3}{x^2} - \frac{9}{2} + \frac{81x^2}{40} + \dots + \frac{r}{x^2} + s \right) = 0$$

$$\Rightarrow \frac{r}{x^2} + \frac{3}{x^2} = 0 \text{ and } s - \frac{9}{2} = 0 \Rightarrow r = -3 \text{ and } s = \frac{9}{2}$$

80. The approximation $\sin x \approx \frac{6x}{6+x^2}$ is better than $\sin x \approx x$.

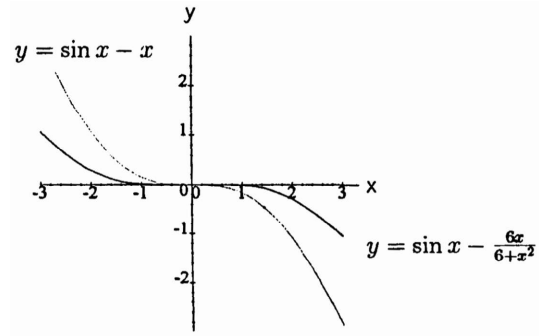

81. $\lim_{n \rightarrow \infty} \left| \frac{2 \cdot 5 \cdot 8 \cdots (3n-1)(3n+2)x^{n+1}}{2 \cdot 4 \cdot 6 \cdots (2n)(2n+2)} \cdot \frac{2 \cdot 4 \cdot 6 \cdots (2n)}{2 \cdot 5 \cdot 8 \cdots (3n-1)x^n} \right| < 1 \Rightarrow |x| \lim_{n \rightarrow \infty} \left| \frac{3n+2}{2n+2} \right| < 1 \Rightarrow |x| < \frac{2}{3} \Rightarrow$ the radius of convergence is $\frac{2}{3}$

82. $\lim_{n \rightarrow \infty} \left| \frac{3 \cdot 5 \cdot 7 \cdots (2n+1)(2n+3)(x-1)^{n+1}}{4 \cdot 9 \cdot 14 \cdots (5n-1)(5n+4)} \cdot \frac{4 \cdot 9 \cdot 14 \cdots (5n-1)}{3 \cdot 5 \cdot 7 \cdots (2n+1)x^n} \right| < 1 \Rightarrow |x| \lim_{n \rightarrow \infty} \left| \frac{2n+3}{5n+4} \right| < 1 \Rightarrow |x| < \frac{5}{2} \Rightarrow$ the radius of convergence is $\frac{5}{2}$

83.
$$\sum_{k=2}^n \ln\left(1 - \frac{1}{k^2}\right) = \sum_{k=2}^n \left[\ln\left(1 + \frac{1}{k}\right) + \ln\left(1 - \frac{1}{k}\right) \right] = \sum_{k=2}^n [\ln(k+1) - \ln k + \ln(k-1) - \ln k]$$

$$= [\ln 3 - \ln 2 + \ln 1 - \ln 2] + [\ln 4 - \ln 3 + \ln 2 - \ln 3] + [\ln 5 - \ln 4 + \ln 3 - \ln 4] + [\ln 6 - \ln 5 + \ln 4 - \ln 5]$$

$$+ \dots + [\ln(n+1) - \ln n + \ln(n-1) - \ln n] = [\ln 1 - \ln 2] + [\ln(n+1) - \ln n]$$

$$\Rightarrow \sum_{k=2}^n \ln\left(1 - \frac{1}{k^2}\right) = \ln\left(\frac{n+1}{2n}\right) \Rightarrow \sum_{k=2}^{\infty} \ln\left(1 - \frac{1}{k^2}\right) = \lim_{n \rightarrow \infty} \ln\left(\frac{n+1}{2n}\right) = \ln \frac{1}{2}$$
 is the sum

84.
$$\sum_{k=2}^n \frac{1}{k^2-1} = \frac{1}{2} \sum_{k=2}^n \left(\frac{1}{k-1} - \frac{1}{k+1} \right) = \frac{1}{2} \left[\left(\frac{1}{1} - \frac{1}{3} \right) + \left(\frac{1}{2} - \frac{1}{4} \right) + \left(\frac{1}{3} - \frac{1}{5} \right) + \left(\frac{1}{4} - \frac{1}{6} \right) + \dots + \left(\frac{1}{n-2} - \frac{1}{n} \right) + \left(\frac{1}{n-1} - \frac{1}{n+1} \right) \right]$$

$$= \frac{1}{2} \left(\frac{1}{1} + \frac{1}{2} - \frac{1}{n} - \frac{1}{n+1} \right) = \frac{1}{2} \left(\frac{3}{2} - \frac{1}{n} - \frac{1}{n+1} \right) = \frac{1}{2} \left[\frac{3n(n+1) - 2(n+1) - 2n}{2n(n+1)} \right] = \frac{3n^2 - n - 2}{4n(n+1)} \Rightarrow \sum_{k=2}^{\infty} \frac{1}{k^2-1} = \lim_{n \rightarrow \infty} \frac{1}{2} \left(\frac{3}{2} - \frac{1}{n} - \frac{1}{n+1} \right) = \frac{3}{4}$$

85. (a) $\lim_{n \rightarrow \infty} \left| \frac{1 \cdot 4 \cdot 7 \cdots (3n-2)(3n+1)x^{3n+3}}{(3n+3)!} \cdot \frac{(3n)!}{1 \cdot 4 \cdot 7 \cdots (3n-2)x^{3n}} \right| < 1 \Rightarrow |x^3| \lim_{n \rightarrow \infty} \frac{(3n+1)}{(3n+1)(3n+2)(3n+3)} = |x^3| \cdot 0 < 1$
 \Rightarrow the radius of convergence is ∞

(b) $y = 1 + \sum_{n=1}^{\infty} \frac{1 \cdot 4 \cdot 7 \cdots (3n-2)}{(3n)!} x^{3n} \Rightarrow \frac{dy}{dx} = \sum_{n=1}^{\infty} \frac{1 \cdot 4 \cdot 7 \cdots (3n-2)}{(3n-1)!} x^{3n-1} \Rightarrow \frac{d^2y}{dx^2} = \sum_{n=1}^{\infty} \frac{1 \cdot 4 \cdot 7 \cdots (3n-2)}{(3n-2)!} x^{3n-2}$
 $= x + \sum_{n=2}^{\infty} \frac{1 \cdot 4 \cdot 7 \cdots (3n-5)}{(3n-3)!} x^{3n-2} = x \left(1 + \sum_{n=1}^{\infty} \frac{1 \cdot 4 \cdot 7 \cdots (3n-2)}{(3n)!} x^{3n} \right) = xy + 0 \Rightarrow a = 1$ and $b = 0$

86. (a) $\frac{x^2}{1+x} = \frac{x^2}{1-(-x)} = x^2 + x^2(-x) + x^2(-x)^2 + x^2(-x)^3 + \dots = x^2 - x^3 + x^4 - x^5 + \dots = \sum_{n=2}^{\infty} (-1)^n x^n$

which converges absolutely for $|x| < 1$

(b) $x = 1 \Rightarrow \sum_{n=2}^{\infty} (-1)^n x^n = \sum_{n=2}^{\infty} (-1)^n$ which diverges

87. Yes, the series $\sum_{n=1}^{\infty} a_n b_n$ converges as we now show. Since $\sum_{n=1}^{\infty} a_n$ converges it follows that $a_n \rightarrow 0 \Rightarrow a_n < 1$ for $n > \text{some index } N \Rightarrow a_n b_n < b_n$ for $n > N \Rightarrow \sum_{n=1}^{\infty} a_n b_n$ converges by the Direct Comparison Test with $\sum_{n=1}^{\infty} b_n$
88. No, the series $\sum_{n=1}^{\infty} a_n b_n$ might diverge (as it would if a_n and b_n both equaled n) or it might converge (as it would if a_n and b_n both equaled $\frac{1}{n}$)
89. $\sum_{n=1}^{\infty} (x_{n+1} - x_n) = \lim_{n \rightarrow \infty} \sum_{k=1}^{\infty} (x_{k+1} - x_k) = \lim_{n \rightarrow \infty} (x_{n+1} - x_1) = \lim_{n \rightarrow \infty} (x_{n+1}) - x_1 \Rightarrow$ both the series and sequence must either converge or diverge.
90. It converges by the Limit Comparison Test since $\lim_{n \rightarrow \infty} \frac{\left(\frac{a_n}{1+a_n}\right)}{\frac{1}{1+a_n}} = \lim_{n \rightarrow \infty} \frac{a_n}{1+a_n} = 1$ because $\sum_{n=1}^{\infty} \frac{1}{1+a_n}$ converges and so $a_n \rightarrow 0$.
91. $\sum_{n=1}^{\infty} \frac{a_n}{n} = a_1 + \frac{a_2}{2} + \frac{a_3}{3} + \frac{a_4}{4} + \dots \geq a_1 + \left(\frac{1}{2}\right)a_2 + \left(\frac{1}{3} + \frac{1}{4}\right)a_4 + \left(\frac{1}{5} + \frac{1}{6} + \frac{1}{7} + \frac{1}{8}\right)a_8 + \left(\frac{1}{9} + \frac{1}{10} + \frac{1}{11} + \dots + \frac{1}{16}\right)a_{16} + \dots$
 $\geq \frac{1}{2}(a_2 + a_4 + a_8 + a_{16} + \dots)$ which is a divergent series
92. $a_n = \frac{1}{\ln n}$ for $n \geq 2 \Rightarrow a_2 \geq a_3 \geq a_4 \geq \dots$, and $\frac{1}{\ln 2} + \frac{1}{\ln 4} + \frac{1}{\ln 8} + \dots = \frac{1}{\ln 2} + \frac{1}{2\ln 2} + \frac{1}{3\ln 2} + \dots = \frac{1}{\ln 2} \left(1 + \frac{1}{2} + \frac{1}{3} + \dots\right)$
 which diverges so that $1 + \sum_{n=2}^{\infty} \frac{1}{n \ln n}$ diverges by the Integral Test.

CHAPTER 10 ADDITIONAL AND ADVANCED EXERCISES

1. converges since $\frac{1}{(3n-2)^{(2n+1)/2}} < \frac{1}{(3n-2)^{3/2}}$ and $\sum_{n=1}^{\infty} \frac{1}{(3n-2)^{3/2}}$ converges by the Limit Comparison Test:

$$\lim_{n \rightarrow \infty} \frac{\left(\frac{1}{n^{3/2}}\right)}{\left(\frac{1}{(3n-2)^{3/2}}\right)} = \lim_{n \rightarrow \infty} \left(\frac{3n-2}{n}\right)^{3/2} = 3^{3/2}$$
2. converges by the Integral Test: $\int_1^{\infty} (\tan^{-1} x)^2 \frac{dx}{x^2+1} = \lim_{b \rightarrow \infty} \left[\frac{(\tan^{-1} x)^3}{3} \right]_1^b = \lim_{b \rightarrow \infty} \left[\frac{(\tan^{-1} b)^3}{3} - \frac{\pi^3}{192} \right]$
 $= \left(\frac{\pi^3}{24} - \frac{\pi^3}{192} \right) = \frac{7\pi^3}{192}$

3. diverges by the n th-Term Test since $\lim_{n \rightarrow \infty} a_n = \lim_{n \rightarrow \infty} (-1)^n \tanh n = \lim_{b \rightarrow \infty} (-1)^n \left(\frac{1-e^{-2n}}{1+e^{-2n}} \right) = \lim_{n \rightarrow \infty} (-1)^n$ does not exist
4. converges by the Direct Comparison Test: $n! < n^n \Rightarrow \ln(n!) < n \ln(n) \Rightarrow \frac{\ln(n!)}{\ln(n)} < n \Rightarrow \log_n(n!) < n \Rightarrow \frac{\log_n(n!)}{n^3} < \frac{1}{n^2}$, which is the n th-term of a convergent p -series
5. converges by the Direct Comparison Test: $a_1 = 1 = \frac{12}{(1)(3)(2)^2}$, $a_2 = \frac{1 \cdot 2}{3 \cdot 4} = \frac{12}{(2)(4)(3)^2}$, $a_3 = \left(\frac{2 \cdot 3}{4 \cdot 5}\right) \left(\frac{1 \cdot 2}{3 \cdot 4}\right) = \frac{12}{(3)(5)(4)^2}$,
 $a_4 = \left(\frac{3 \cdot 4}{5 \cdot 6}\right) \left(\frac{2 \cdot 3}{4 \cdot 5}\right) \left(\frac{1 \cdot 2}{3 \cdot 4}\right) = \frac{12}{(4)(6)(5)^2}$, $\dots \Rightarrow 1 + \sum_{n=1}^{\infty} \frac{12}{(n+1)(n+3)(n+2)^2}$ represents the given series and
 $\frac{12}{(n+1)(n+3)(n+2)^2} < \frac{12}{n^4}$, which is the n th-term of a convergent p -series
6. converges by the Ratio Test: $\lim_{n \rightarrow \infty} \frac{a_{n+1}}{a_n} = \lim_{n \rightarrow \infty} \frac{n}{(n-1)(n+1)} = 0 < 1$
7. diverges by the n th-Term Test since if $a_n \rightarrow L$ as $n \rightarrow \infty$, then $L = \frac{1}{1+L} \Rightarrow L^2 + L - 1 = 0 \Rightarrow L = \frac{-1 \pm \sqrt{5}}{2} \neq 0$
8. Split the given series into $\sum_{n=1}^{\infty} \frac{1}{3^{2n+1}}$ and $\sum_{n=1}^{\infty} \frac{2n}{3^{2n}}$; the first subseries is a convergent geometric series and the second converges by the Root Test: $\lim_{n \rightarrow \infty} \sqrt[n]{\frac{2n}{3^{2n}}} = \lim_{n \rightarrow \infty} \frac{\sqrt[n]{2} \sqrt[n]{n}}{9} = \frac{1 \cdot 1}{9} = \frac{1}{9} < 1$
9. $f(x) = \cos x$ with $a = \frac{\pi}{3} \Rightarrow f\left(\frac{\pi}{3}\right) = 0.5$, $f'\left(\frac{\pi}{3}\right) = -\frac{\sqrt{3}}{2}$, $f''\left(\frac{\pi}{3}\right) = -0.5$, $f'''\left(\frac{\pi}{3}\right) = \frac{\sqrt{3}}{2}$, $f^{(4)}\left(\frac{\pi}{3}\right) = 0.5$;
 $\cos x = \frac{1}{2} - \frac{\sqrt{3}}{2}\left(x - \frac{\pi}{3}\right) - \frac{1}{4}\left(x - \frac{\pi}{3}\right)^2 + \frac{\sqrt{3}}{12}\left(x - \frac{\pi}{3}\right)^3 + \dots$
10. $f(x) = \sin x$ with $a = 2\pi \Rightarrow f(2\pi) = 0$, $f'(2\pi) = 1$, $f''(2\pi) = 0$, $f'''(2\pi) = -1$, $f^{(4)}(2\pi) = 0$, $f^{(5)}(2\pi) = 1$,
 $f^{(6)}(2\pi) = 0$, $f^{(7)}(2\pi) = -1$; $\sin x = (x - 2\pi) - \frac{(x - 2\pi)^3}{3!} + \frac{(x - 2\pi)^5}{5!} - \frac{(x - 2\pi)^7}{7!} + \dots$
11. $e^x = 1 + x + \frac{x^2}{2!} + \frac{x^3}{3!} + \dots$ with $a = 0$
12. $f(x) = \ln x$ with $a = 1 \Rightarrow f(1) = 0$, $f'(1) = 1$, $f''(1) = -1$, $f'''(1) = 2$, $f^{(4)}(1) = -6$;
 $\ln x = (x - 1) - \frac{(x - 1)^2}{2} + \frac{(x - 1)^3}{3} - \frac{(x - 1)^4}{4} + \dots$
13. $f(x) = \cos x$ with $a = 22\pi \Rightarrow f(22\pi) = 1$, $f'(22\pi) = 0$, $f''(22\pi) = -1$, $f'''(22\pi) = 0$, $f^{(4)}(22\pi) = 1$,
 $f^{(5)}(22\pi) = 0$, $f^{(6)}(22\pi) = -1$; $\cos x = 1 - \frac{1}{2}(x - 22\pi)^2 + \frac{1}{4!}(x - 22\pi)^4 - \frac{1}{6!}(x - 22\pi)^6 + \dots$

14. $f(x) = \tan^{-1} x$ with $a = 1 \Rightarrow f(1) = \frac{\pi}{4}, f'(1) = \frac{1}{2}, f''(1) = -\frac{1}{2}, f'''(1) = \frac{1}{2};$

$$\tan^{-1} x = \frac{\pi}{4} + \frac{(x-1)}{2} - \frac{(x-1)^2}{4} + \frac{(x-1)^3}{12} + \dots$$

15. Yes, the sequence converges: $c_n = (a^n + b^n)^{1/n} \Rightarrow c_n = b \left(\left(\frac{a}{b}\right)^n + 1 \right)^{1/n} \Rightarrow \lim_{n \rightarrow \infty} c_n = \ln b + \lim_{n \rightarrow \infty} \frac{\ln \left(\left(\frac{a}{b}\right)^n + 1 \right)}{n}$
 $= \ln b + \lim_{n \rightarrow \infty} \frac{\left(\frac{a}{b}\right)^n \ln \left(\frac{a}{b}\right)}{\left(\frac{a}{b}\right)^n + 1} = \ln b + \frac{0 \cdot \ln \left(\frac{a}{b}\right)}{0+1} = \ln b$ since $0 < a < b$. Thus, $\lim_{n \rightarrow \infty} c_n = e^{\ln b} = b$.

16. $1 + \frac{2}{10} + \frac{3}{10^2} + \frac{7}{10^3} + \frac{2}{10^4} + \frac{3}{10^5} + \frac{7}{10^6} + \dots = 1 + \sum_{n=1}^{\infty} \frac{2}{10^{3n-2}} + \sum_{n=1}^{\infty} \frac{3}{10^{3n-1}} + \sum_{n=1}^{\infty} \frac{7}{10^{3n}}$
 $= 1 + \sum_{n=0}^{\infty} \frac{2}{10^{3n+1}} + \sum_{n=0}^{\infty} \frac{3}{10^{3n+2}} + \sum_{n=0}^{\infty} \frac{7}{10^{3n+3}} = 1 + \frac{\left(\frac{2}{10}\right)}{1 - \left(\frac{1}{10}\right)^3} + \frac{\left(\frac{3}{10^2}\right)}{1 - \left(\frac{1}{10}\right)^3} + \frac{\left(\frac{7}{10^3}\right)}{1 - \left(\frac{1}{10}\right)^3} = 1 + \frac{200}{999} + \frac{30}{999} + \frac{7}{999} = \frac{999+237}{999} = \frac{412}{333}$

17. $s_n = \sum_{k=0}^{n-1} \int_k^{k+1} \frac{dx}{1+x^2} \Rightarrow s_n = \int_0^1 \frac{dx}{1+x^2} + \int_1^2 \frac{dx}{1+x^2} + \dots + \int_{n-1}^n \frac{dx}{1+x^2} \Rightarrow s_n = \int_0^n \frac{dx}{1+x^2}$
 $\Rightarrow \lim_{n \rightarrow \infty} s_n = \lim_{n \rightarrow \infty} \left(\tan^{-1} n - \tan^{-1} 0 \right) = \frac{\pi}{2}$

18. $\lim_{n \rightarrow \infty} \left| \frac{u_{n+1}}{u_n} \right| = \lim_{n \rightarrow \infty} \left| \frac{(n+1)x^{n+1}}{(n+2)(2x+1)^{n+1}} \cdot \frac{(n+1)(2x+1)^n}{nx^n} \right| = \lim_{n \rightarrow \infty} \left| \frac{x}{2x+1} \cdot \frac{(n+1)^2}{n(n+2)} \right| = \left| \frac{x}{2x+1} \right| < 1 \Rightarrow |x| < |2x+1|;$

if $x > 0, |x| < |2x+1| \Rightarrow x < 2x+1 \Rightarrow x > -1;$

if $-\frac{1}{2} < x < 0, |x| < |2x+1| \Rightarrow -x < 2x+1 \Rightarrow 3x > -1 \Rightarrow x > -\frac{1}{3};$

if $x < -\frac{1}{2}, |x| < |2x+1| \Rightarrow -x < -2x-1 \Rightarrow x < -1.$

Therefore, the series converges absolutely for $x < -1$ and $x > -\frac{1}{3}$.

19. (a) No, the limit does not appear to depend on the value of the constant a

(b) Yes, the limit depends on the value of b

(c) $s = \left(1 - \frac{\cos \left(\frac{a}{n}\right)}{n} \right)^n \Rightarrow \ln s = \frac{\ln \left(1 - \frac{\cos \left(\frac{a}{n}\right)}{n} \right)}{\left(\frac{1}{n}\right)} \Rightarrow \lim_{n \rightarrow \infty} \ln s = \frac{\left(\frac{1}{1 - \frac{\cos \left(\frac{a}{n}\right)}{n}} \right) \left(\frac{-\frac{a}{n} \sin \left(\frac{a}{n}\right) + \cos \left(\frac{a}{n}\right)}{n^2} \right)}{\left(-\frac{1}{n^2}\right)} = \lim_{n \rightarrow \infty} \frac{\frac{a}{n} \sin \left(\frac{a}{n}\right) - \cos \left(\frac{a}{n}\right)}{1 - \frac{\cos \left(\frac{a}{n}\right)}{n}}$
 $= \frac{0-1}{1-0} = -1 \Rightarrow \lim_{n \rightarrow \infty} s = e^{-1} \approx 0.3678794412;$ similarly, $\lim_{n \rightarrow \infty} \left(1 - \frac{\cos \left(\frac{a}{n}\right)}{bn} \right)^n = e^{-1/b}$

20. $\sum_{n=1}^{\infty} a_n$ converges $\Rightarrow \lim_{n \rightarrow \infty} a_n = 0; \lim_{n \rightarrow \infty} \left[\left(\frac{1 + \sin a_n}{2} \right)^n \right]^{1/n} = \lim_{n \rightarrow \infty} \left(\frac{1 + \sin a_n}{2} \right) = \frac{1 + \sin \left(\lim_{n \rightarrow \infty} a_n \right)}{2} = \frac{1 + \sin 0}{2} = \frac{1}{2}$
 \Rightarrow the series converges by the n th-Root Test

21. $\lim_{n \rightarrow \infty} \left| \frac{u_{n+1}}{u_n} \right| < 1 \Rightarrow \lim_{n \rightarrow \infty} \left| \frac{b^{n+1} x^{n+1}}{\ln(n+1)} \cdot \frac{\ln n}{b^n x^n} \right| < 1 \Rightarrow |bx| < 1 \Rightarrow -\frac{1}{b} < x < \frac{1}{b} = 5 \Rightarrow b = \pm \frac{1}{5}$

22. A polynomial has only a finite number of nonzero terms in its Taylor series, but the functions $\sin x$, $\ln x$ and e^x have infinitely many nonzero terms in their Taylor expansions.

23.
$$\lim_{x \rightarrow 0} \frac{\sin(ax) - \sin x - x}{x^3} = \lim_{x \rightarrow 0} \frac{\left(ax - \frac{a^3 x^3}{3!} + \dots\right) - \left(x - \frac{x^3}{3!} + \dots\right) - x}{x^3} = \lim_{x \rightarrow 0} \left[\frac{a-2}{x^2} - \frac{a^3}{3!} + \frac{1}{3!} - \left(\frac{a^5}{5!} - \frac{1}{5!}\right)x^2 + \dots \right]$$
 is finite
 if $a - 2 = 0 \Rightarrow a = 2$;
$$\lim_{x \rightarrow 0} \frac{\sin 2x - \sin x - x}{x^3} = -\frac{2^3}{3!} + \frac{1}{3!} = -\frac{7}{6}$$

24.
$$\lim_{x \rightarrow 0} \frac{\cos ax - b}{2x^2} = -1 \Rightarrow \lim_{x \rightarrow 0} \frac{\left(1 - \frac{a^2 x^2}{2} + \frac{a^4 x^4}{4!} - \dots\right) - b}{2x^2} = -1 \Rightarrow \lim_{x \rightarrow 0} \left(\frac{1-b}{2x^2} - \frac{a^2}{4} + \frac{a^2 x^2}{48} - \dots\right) = -1 \Rightarrow b = 1 \text{ and } a = \pm 2$$

25. (a)
$$\frac{u_n}{u_{n+1}} = \frac{(n+1)^2}{n^2} = 1 + \frac{2}{n} + \frac{1}{n^2} \Rightarrow C = 2 > 1 \text{ and } \sum_{n=1}^{\infty} \frac{1}{n^2} \text{ converges}$$

(b)
$$\frac{u_n}{u_{n+1}} = \frac{n+1}{n} = 1 + \frac{1}{n} + \frac{0}{n^2} \Rightarrow C = 1 \leq 1 \text{ and } \sum_{n=1}^{\infty} \frac{1}{n} \text{ diverges}$$

26.
$$\frac{u_n}{u_{n+1}} = \frac{2n(2n+1)}{(2n-1)^2} = \frac{4n^2+2n}{4n^2-4n+1} = 1 + \frac{\left(\frac{6}{4}\right)}{4n^2-4n+1} = 1 + \frac{\left(\frac{3}{2}\right)}{n} + \frac{\left|\frac{5n^2}{4n^2-4n+1}\right|}{n^2}$$
 after long division $\Rightarrow C = \frac{3}{2} > 1$ and

$$|f(n)| = \frac{5n^2}{4n^2-4n+1} = \frac{5}{\left(4 - \frac{4}{n} + \frac{1}{n^2}\right)} \leq 5 \Rightarrow \sum_{n=1}^{\infty} u_n \text{ converges by Raabe's Test}$$

27. (a)
$$\sum_{n=1}^{\infty} a_n = L \Rightarrow a_n^2 \leq a_n \sum_{n=1}^{\infty} a_n = a_n L \Rightarrow \sum_{n=1}^{\infty} a_n^2 \text{ converges by the Direct Comparison Test}$$

(b) converges by the Limit Comparison Test:
$$\lim_{n \rightarrow \infty} \frac{\left(\frac{a_n}{1-a_n}\right)}{a_n} = \lim_{n \rightarrow \infty} \frac{1}{1-a_n} = 1$$
 since $\sum_{n=1}^{\infty} a_n$ converges and therefore

$$\lim_{n \rightarrow \infty} a_n = 0$$

28. If $0 < a_n < 1$ then $|\ln(1 - a_n)| = -\ln(1 - a_n) = a_n + \frac{a_n^2}{2} + \frac{a_n^3}{3} + \dots < a_n + a_n^2 + a_n^3 + \dots = \frac{a_n}{1 - a_n}$, a positive term of a convergent series, by the Limit Comparison Test and Exercise 27b

29.
$$(1-x)^{-1} = 1 + \sum_{n=1}^{\infty} x^n$$
 where $|x| < 1 \Rightarrow \frac{1}{(1-x)^2} = \frac{d}{dx}(1-x)^{-1} = \sum_{n=1}^{\infty} nx^{n-1}$ and when $x = \frac{1}{2}$ we have

$$4 = 1 + 2\left(\frac{1}{2}\right) + 3\left(\frac{1}{2}\right)^2 + 4\left(\frac{1}{2}\right)^3 + \dots + n\left(\frac{1}{2}\right)^{n-1} + \dots$$

30. (a)
$$\sum_{n=1}^{\infty} x^{n+1} = \frac{x^2}{1-x} \Rightarrow \sum_{n=1}^{\infty} (n+1)x^n = \frac{2x-x^2}{(1-x)^2} \Rightarrow \sum_{n=1}^{\infty} n(n+1)x^{n-1} = \frac{2}{(1-x)^3} \Rightarrow \sum_{n=1}^{\infty} n(n+1)x^n = \frac{2x}{(1-x)^3}$$

$$\Rightarrow \sum_{n=1}^{\infty} \frac{n(n+1)}{x^n} = \frac{\frac{2}{x}}{\left(1-\frac{1}{x}\right)^3} = \frac{2x^2}{(x-1)^3}, |x| > 1$$

(b) $x = \sum_{n=1}^{\infty} \frac{n(n+1)}{x^n} \Rightarrow x = \frac{2x^2}{(x-1)^3} \Rightarrow x^3 - 3x^2 + x - 1 = 0 \Rightarrow x = 1 + \left(1 + \frac{\sqrt{57}}{9}\right)^{1/3} + \left(1 - \frac{\sqrt{57}}{9}\right)^{1/3} \approx 2.769292$, using a CAS or calculator

31. (a) $\frac{1}{(1-x)^2} = \frac{d}{dx} \left(\frac{1}{1-x} \right) = \frac{d}{dx} (1 + x + x^2 + x^3 + \dots) = 1 + 2x + 3x^2 + 4x^3 + \dots = \sum_{n=1}^{\infty} nx^{n-1}$

(b) from part (a) we have $\sum_{n=1}^{\infty} n \left(\frac{5}{6}\right)^{n-1} \left(\frac{1}{6}\right) = \left(\frac{1}{6}\right) \left[\frac{1}{1 - \left(\frac{5}{6}\right)} \right]^2 = 6$

(c) from part (a) we have $\sum_{n=1}^{\infty} np^{n-1}q = \frac{q}{(1-p)^2} = \frac{q}{q^2} = \frac{1}{q}$

32. (a) $\sum_{k=1}^{\infty} p_k = \sum_{k=1}^{\infty} 2^{-k} = \frac{\left(\frac{1}{2}\right)}{1 - \left(\frac{1}{2}\right)} = 1$ and $E(x) = \sum_{k=1}^{\infty} k p_k = \sum_{k=1}^{\infty} k 2^{-k} = \frac{1}{2} \sum_{k=1}^{\infty} k 2^{1-k} = \left(\frac{1}{2}\right) \frac{1}{\left[1 - \left(\frac{1}{2}\right)\right]^2} = 2$

by Exercise 31 (a)

(b) $\sum_{k=1}^{\infty} p_k = \sum_{k=1}^{\infty} \frac{5^{k-1}}{6^k} = \frac{1}{5} \sum_{k=1}^{\infty} \left(\frac{5}{6}\right)^k = \left(\frac{1}{5}\right) \left[\frac{\left(\frac{5}{6}\right)}{1 - \left(\frac{5}{6}\right)} \right] = 1$ and $E(x) = \sum_{k=1}^{\infty} k p_k = \sum_{k=1}^{\infty} k \frac{5^{k-1}}{6^k} = \frac{1}{6} \sum_{k=1}^{\infty} k \left(\frac{5}{6}\right)^{k-1} = \left(\frac{1}{6}\right) \frac{1}{\left[1 - \left(\frac{5}{6}\right)\right]^2} = 6$

(c) $\sum_{k=1}^{\infty} p_k = \sum_{k=1}^{\infty} \frac{1}{k(k+1)} = \sum_{k=1}^{\infty} \left(\frac{1}{k} - \frac{1}{k+1}\right) = \lim_{k \rightarrow \infty} \left(1 - \frac{1}{k+1}\right) = 1$ and $E(x) = \sum_{k=1}^{\infty} k p_k = \sum_{k=1}^{\infty} k \left(\frac{1}{k(k+1)}\right) = \sum_{k=1}^{\infty} \frac{1}{k+1}$,

a divergent series so that $E(x)$ does not exist

33. (a) $R_n = C_0 e^{-kt_0} + C_0 e^{-2kt_0} + \dots + C_0 e^{-nkt_0} = \frac{C_0 e^{-kt_0} (1 - e^{-nkt_0})}{1 - e^{-kt_0}} \Rightarrow R = \lim_{n \rightarrow \infty} R_n = \frac{C_0 e^{-kt_0}}{1 - e^{-kt_0}} = \frac{C_0}{e^{kt_0} - 1}$

(b) $R_n = \frac{e^{-1}(1 - e^{-n})}{1 - e^{-1}} \Rightarrow R_1 = e^{-1} \approx 0.36787944$ and $R_{10} = \frac{e^{-1}(1 - e^{-10})}{1 - e^{-1}} \approx 0.58195028$; $R = \frac{1}{e-1} \approx 0.58197671$;
 $R - R_{10} \approx 0.00002643 \Rightarrow \frac{R - R_{10}}{R} < 0.0001$

(c) $R_n = \frac{e^{-1}(1 - e^{-\ln n})}{1 - e^{-1}}$, $\frac{R}{2} = \frac{1}{2} \left(\frac{1}{e-1}\right) \approx 4.7541659$; $R_n > \frac{R}{2} \Rightarrow \frac{1 - e^{-\ln n}}{e-1} > \left(\frac{1}{2}\right) \left(\frac{1}{e-1}\right) \Rightarrow 1 - e^{-\ln n} > \frac{1}{2}$
 $\Rightarrow e^{-\ln n} < \frac{1}{2} \Rightarrow -\frac{n}{10} < \ln\left(\frac{1}{2}\right) \Rightarrow \frac{n}{10} > -\ln\left(\frac{1}{2}\right) \Rightarrow n > 6.93 \Rightarrow n = 7$

34. (a) $R = \frac{C_0}{e^{kt_0} - 1} \Rightarrow R e^{kt_0} = R + C_0 = C_H \Rightarrow e^{kt_0} = \frac{C_H}{C_L} \Rightarrow t_0 = \frac{1}{k} \ln\left(\frac{C_H}{C_L}\right)$

(b) $t_0 = \frac{1}{0.05} \ln e = 20$ hrs

(c) Give an initial dose that produces a concentration of 2 mg/ml followed every $t_0 = \frac{1}{0.02} \ln\left(\frac{2}{0.5}\right) \approx 69.31$ hrs by a dose that raises the concentration by 1.5 mg/ml

(d) $t_0 = \frac{1}{0.2} \ln\left(\frac{0.1}{0.03}\right) = 5 \ln\left(\frac{10}{3}\right) \approx 6$ hrs

CHAPTER 11 PARAMETRIC EQUATIONS AND POLAR COORDINATES

11.1 PARAMETRIZATIONS OF PLANE CURVES

1. $x = 3t, y = 9t^2, -\infty < t < \infty \Rightarrow y = x^2$

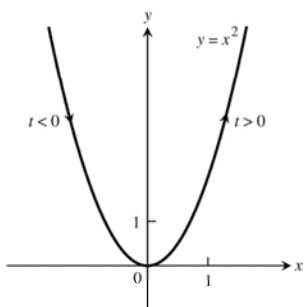

2. $x = -\sqrt{t}, y = t, t \geq 0 \Rightarrow x = -\sqrt{y}$
or $y = x^2, x \leq 0$

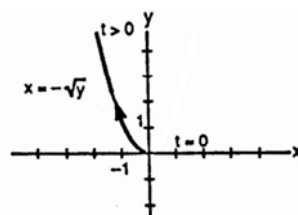

3. $x = 2t - 5, y = 4t - 7, -\infty < t < \infty$
 $\Rightarrow x + 5 = 2t \Rightarrow 2(x + 5) = 4t$
 $\Rightarrow y = 2(x + 5) - 7 \Rightarrow y = 2x + 3$

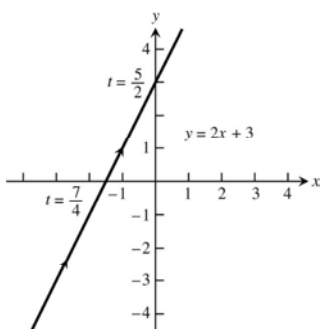

4. $x = 3 - 3t, y = 2t, 0 \leq t \leq 1 \Rightarrow \frac{y}{2} = t$
 $\Rightarrow x = 3 - 3\left(\frac{y}{2}\right) \Rightarrow 2x = 6 - 3y$
 $\Rightarrow y = 2 - \frac{2}{3}x, 0 \leq x \leq 3$

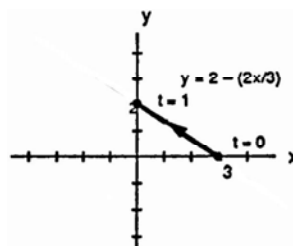

5. $x = \cos 2t, y = \sin 2t, 0 \leq t \leq \pi$
 $\Rightarrow \cos^2 2t + \sin^2 2t = 1 \Rightarrow x^2 + y^2 = 1$

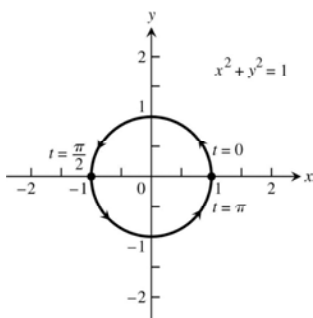

6. $x = \cos(\pi - t), y = \sin(\pi - t), 0 \leq t \leq \pi$
 $\Rightarrow \cos^2(\pi - t) + \sin^2(\pi - t) = 1$
 $\Rightarrow x^2 + y^2 = 1, y \geq 0$

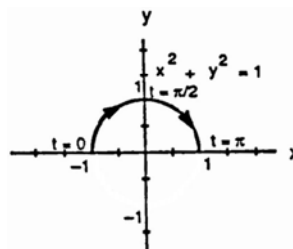

7. $x = 4 \cos t, y = 2 \sin t, 0 \leq t \leq 2\pi$

$\Rightarrow \frac{16 \cos^2 t}{16} + \frac{4 \sin^2 t}{4} = 1 \Rightarrow \frac{x^2}{16} + \frac{y^2}{4} = 1$

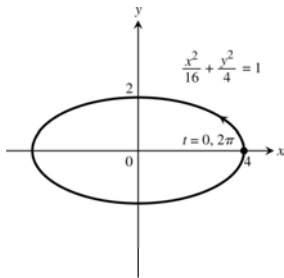

8. $x = 4 \sin t, y = 5 \cos t, 0 \leq t \leq 2\pi$

$\Rightarrow \frac{16 \sin^2 t}{16} + \frac{25 \cos^2 t}{25} = 1 \Rightarrow \frac{x^2}{16} + \frac{y^2}{25} = 1$

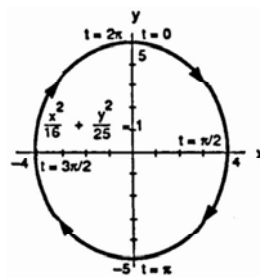

9. $x = \sin t, y = \cos 2t, -\frac{\pi}{2} \leq t \leq \frac{\pi}{2}$

$\Rightarrow y = \cos 2t = 1 - 2 \sin^2 t \Rightarrow y = 1 - 2x^2$

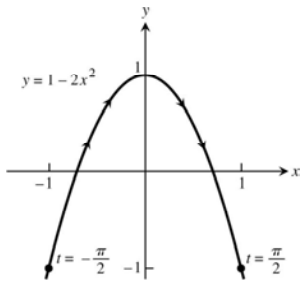

10. $x = 1 + \sin t, y = \cos t - 2, 0 \leq t \leq \pi$

$\Rightarrow \sin^2 t + \cos^2 t = 1 \Rightarrow (x-1)^2 + (y+2)^2 = 1$

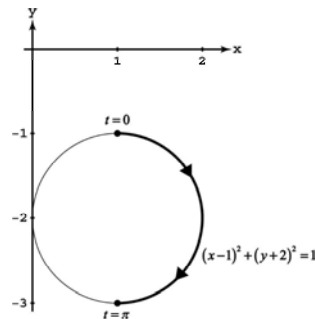

11. $x = t^2, y = t^6 - 2t^4, -\infty < t < \infty$

$\Rightarrow y = (t^2)^3 - 2(t^2)^2 \Rightarrow y = x^3 - 2x^2$

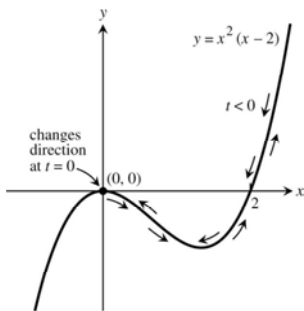

12. $x = \frac{t}{t-1}, y = \frac{t-2}{t+1}, -1 < t < 1$

$\Rightarrow t = \frac{x}{x-1}, \Rightarrow y = \frac{2-x}{2x-1}$

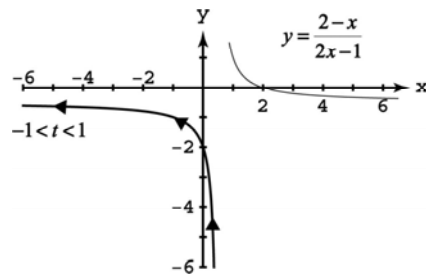

13. $x = t, y = \sqrt{1-t^2}, -1 \leq t \leq 0$

$\Rightarrow y = \sqrt{1-x^2}$

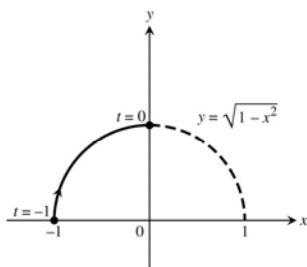

14. $x = \sqrt{t+1}, y = \sqrt{t}, t \geq 0$

$\Rightarrow y^2 = t \Rightarrow x = \sqrt{y^2 + 1}, y \geq 0$

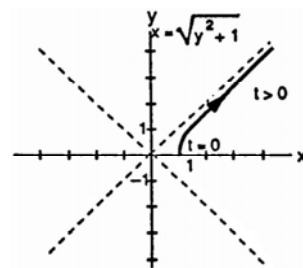

15. $x = \sec^2 t - 1, y = \tan t, -\frac{\pi}{2} < t < \frac{\pi}{2}$
 $\Rightarrow \sec^2 t - 1 = \tan^2 t \Rightarrow x = y^2$

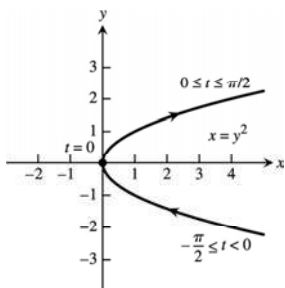

16. $x = -\sec t, y = \tan t, -\frac{\pi}{2} < t < \frac{\pi}{2}$
 $\Rightarrow \sec^2 t - \tan^2 t = 1 \Rightarrow x^2 - y^2 = 1$

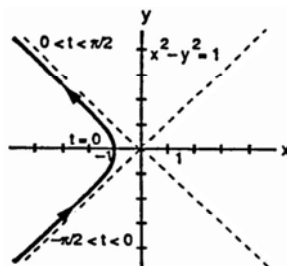

17. $x = -\cosh t, y = \sinh t, -\infty < t < \infty$
 $\Rightarrow \cosh^2 t - \sinh^2 t = 1 \Rightarrow x^2 - y^2 = 1$

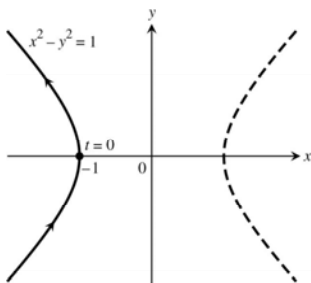

18. $x = 2 \sinh t, y = 2 \cosh t, -\infty < t < \infty$
 $\Rightarrow 4 \cosh^2 t - 4 \sinh^2 t = 4 \Rightarrow y^2 - x^2 = 4$

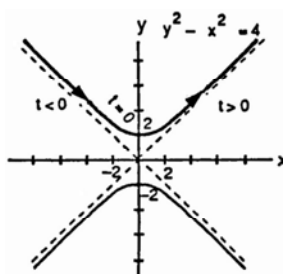

19. (a) $x = a \cos t, y = -a \sin t, 0 \leq t \leq 2\pi$
 (b) $x = a \cos t, y = a \sin t, 0 \leq t \leq 2\pi$
 (c) $x = a \cos t, y = -a \sin t, 0 \leq t \leq 4\pi$
 (d) $x = a \cos t, y = a \sin t, 0 \leq t \leq 4\pi$

20. (a) $x = a \sin t, y = b \cos t, \frac{\pi}{2} \leq t \leq \frac{5\pi}{2}$
 (b) $x = a \cos t, y = b \sin t, 0 \leq t \leq 2\pi$
 (c) $x = a \sin t, y = b \cos t, \frac{\pi}{2} \leq t \leq \frac{9\pi}{2}$
 (d) $x = a \cos t, y = b \sin t, 0 \leq t \leq 4\pi$

21. Using $(-1, -3)$ we create the parametric equations $x = -1 + at$ and $y = -3 + bt$, representing a line which goes through $(-1, -3)$ at $t = 0$. We determine a and b so that the line goes through $(4, 1)$ when $t = 1$. Since $4 = -1 + a \Rightarrow a = 5$. Since $1 = -3 + b \Rightarrow b = 4$. Therefore, one possible parameterization is $x = -1 + 5t, y = -3 + 4t, 0 \leq t \leq 1$.

22. Using $(-1, 3)$ we create the parametric equations $x = -1 + at$ and $y = 3 + bt$, representing a line which goes through $(-1, 3)$ at $t = 0$. We determine a and b so that the line goes through $(3, -2)$ when $t = 1$. Since $3 = -1 + a \Rightarrow a = 4$. Since $-2 = 3 + b \Rightarrow b = -5$. Therefore, one possible parameterization is $x = -1 + 4t, y = 3 - 5t, 0 \leq t \leq 1$.

23. The lower half of the parabola is given by $x = y^2 + 1$ for $y \leq 0$. Substituting t for y , we obtain one possible parameterization $x = t^2 + 1, y = t, t \leq 0$.

24. The vertex of the parabola is at $(-1, -1)$, so the left half of the parabola is given by $y = x^2 + 2x$ for $x \leq -1$. Substituting t for x , we obtain one possible parameterization: $x = t, y = t^2 + 2t, t \leq -1$.

25. For simplicity, we assume that x and y are linear functions of t and that the point (x, y) starts at $(2, 3)$ for $t = 0$ and passes through $(-1, -1)$ at $t = 1$. Then $x = f(t)$, where $f(0) = 2$ and $f(1) = -1$.
 Since slope $= \frac{\Delta x}{\Delta t} = \frac{-1-2}{1-0} = -3$, $x = f(t) = -3t + 2 = 2 - 3t$. Also, $y = g(t)$, where $g(0) = 3$ and $g(1) = -1$.
 Since slope $= \frac{\Delta y}{\Delta t} = \frac{-1-3}{1-0} = -4$, $y = g(t) = -4t + 3 = 3 - 4t$. One possible parameterization is: $x = 2 - 3t$,
 $y = 3 - 4t, t \geq 0$.
26. For simplicity, we assume that x and y are linear functions of t and that the point (x, y) starts at $(-1, 2)$ for $t = 0$ and passes through $(0, 0)$ at $t = 1$. Then $x = f(t)$, where $f(0) = -1$ and $f(1) = 0$.
 Since slope $= \frac{\Delta x}{\Delta t} = \frac{0-(-1)}{1-0} = 1$, $x = f(t) = 1t + (-1) = -1 + t$. Also, $y = g(t)$, where $g(0) = 2$ and $g(1) = 0$.
 Since slope $= \frac{\Delta y}{\Delta t} = \frac{0-2}{1-0} = -2$, $y = g(t) = -2t + 2 = 2 - 2t$. One possible parameterization is: $x = -1 + t$,
 $y = 2 - 2t, t \geq 0$.
27. Since we only want the top half of a circle, $y \geq 0$, so let $x = 2 \cos t, y = 2|\sin t|, 0 \leq t \leq 4\pi$
28. Since we want x to stay between -3 and 3 , let $x = 3 \sin t$, then $y = (3 \sin t)^2 = 9 \sin^2 t$, thus $x = 3 \sin t$,
 $y = 9 \sin^2 t, 0 \leq t < \infty$
29. $x^2 + y^2 = a^2 \Rightarrow 2x + 2y \frac{dy}{dx} = 0 \Rightarrow \frac{dy}{dx} = -\frac{x}{y}$; let $t = \frac{dy}{dx} \Rightarrow -\frac{x}{y} = t \Rightarrow x = -yt$. Substitution yields
 $y^2 t^2 + y^2 = a^2 \Rightarrow y = \frac{a}{\sqrt{1+t^2}}$ and $x = \frac{-at}{\sqrt{1+t^2}}, -\infty < t < \infty$
30. In terms of θ , parametric equations for the circle are $x = a \cos \theta, y = a \sin \theta, 0 \leq \theta < 2\pi$. Since $\theta = \frac{s}{a}$, the arc length parametrizations are: $x = a \cos \frac{s}{a}, y = a \sin \frac{s}{a}$, and $0 \leq \frac{s}{a} < 2\pi \Rightarrow 0 \leq s < 2\pi a$ is the interval for s .
31. Drop a vertical line from the point (x, y) to the x -axis, then θ is an angle in a right triangle, and from trigonometry we know that $\tan \theta = \frac{y}{x} \Rightarrow y = x \tan \theta$. The equation of the line through $(0, 2)$ and $(4, 0)$ is given by $y = -\frac{1}{2}x + 2$. Thus $x \tan \theta = -\frac{1}{2}x + 2 \Rightarrow x = \frac{4}{2 \tan \theta + 1}$ and $y = \frac{4 \tan \theta}{2 \tan \theta + 1}$ where $0 \leq \theta \leq \frac{\pi}{2}$.
32. Drop a vertical line from the point (x, y) to the x -axis, then θ is an angle in a right triangle, and from trigonometry we know that $\tan \theta = \frac{y}{x} \Rightarrow y = x \tan \theta$. Since $y = \sqrt{x} \Rightarrow y^2 = x \Rightarrow (x \tan \theta)^2 = x \Rightarrow x = \cot^2 \theta \Rightarrow y = \cot \theta$ where $0 < \theta \leq \frac{\pi}{2}$.
33. The equation of the circle is given by $(x-2)^2 + y^2 = 1$. Drop a vertical line from the point (x, y) on the circle to the x -axis, then θ is an angle in a right triangle. So that we can start at $(1, 0)$ and rotate in a clockwise direction, let $x = 2 - \cos \theta, y = \sin \theta, 0 \leq \theta \leq 2\pi$.
34. Drop a vertical line from the point (x, y) to the x -axis, then θ is an angle in a right triangle, whose height is y and whose base is $x + 2$. By trigonometry we have $\tan \theta = \frac{y}{x+2} \Rightarrow y = (x+2) \tan \theta$. The equation of the circle

is given by $x^2 + y^2 = 1 \Rightarrow x^2 + ((x+2)\tan\theta)^2 = 1 \Rightarrow x^2 \sec^2\theta + 4x \tan^2\theta + 4 \tan^2\theta - 1 = 0$. Solving for x we

$$\text{obtain } x = \frac{-4 \tan^2\theta \pm \sqrt{(4 \tan^2\theta)^2 - 4 \sec^2\theta(4 \tan^2\theta - 1)}}{2 \sec^2\theta} = \frac{-4 \tan^2\theta \pm 2\sqrt{1-3 \tan^2\theta}}{2 \sec^2\theta} = -2 \sin^2\theta \pm \cos\theta \sqrt{\cos^2\theta - 3 \sin^2\theta}$$

$$= -2 + 2 \cos^2\theta \pm \cos\theta \sqrt{4 \cos^2\theta - 3} \text{ and } y = \left(-2 + 2 \cos^2\theta \pm \cos\theta \sqrt{4 \cos^2\theta - 3} + 2\right) \tan\theta$$

$= 2 \sin\theta \cos\theta \pm \sin\theta \sqrt{4 \cos^2\theta - 3}$. Since we only need to go from $(1, 0)$ to $(0, 1)$, let

$x = -2 + 2 \cos^2\theta + \cos\theta \sqrt{4 \cos^2\theta - 3}$, $y = 2 \sin\theta \cos\theta + \sin\theta \sqrt{4 \cos^2\theta - 3}$, $0 \leq \theta \leq \tan^{-1}\left(\frac{1}{2}\right)$. To obtain the upper limit for θ , note that $x = 0$ and $y = 1$, using $y = (x+2)\tan\theta \Rightarrow 1 = 2 \tan\theta \Rightarrow \theta = \tan^{-1}\left(\frac{1}{2}\right)$.

35. Extend the vertical line through A to the x -axis and let C be the point of intersection. Then $OC = AQ = x$ and

$$\tan t = \frac{2}{OC} = \frac{2}{x} \Rightarrow x = \frac{2}{\tan t} = 2 \cot t; \quad \sin t = \frac{2}{OA} \Rightarrow OA = \frac{2}{\sin t}; \text{ and } (AB)(OA) = (AQ)^2 \Rightarrow AB\left(\frac{2}{\sin t}\right) = x^2$$

$$\Rightarrow AB\left(\frac{2}{\sin t}\right) = \left(\frac{2}{\tan t}\right)^2 \Rightarrow AB = \frac{2 \sin t}{\tan^2 t}. \text{ Next } y = 2 - AB \sin t \Rightarrow y = 2 - \left(\frac{2 \sin t}{\tan^2 t}\right) \sin t = 2 - \frac{2 \sin^2 t}{\tan^2 t}$$

$= 2 - 2 \cos^2 t = 2 \sin^2 t$. Therefore let $x = 2 \cot t$ and $y = 2 \sin^2 t$, $0 < t < \pi$.

36. Arc $PF =$ Arc AF since each is the distance rolled and

$$\frac{\text{Arc } PF}{b} = \angle FCP \Rightarrow \text{Arc } PF = b(\angle FCP);$$

$$\frac{\text{Arc } AF}{a} = \theta \Rightarrow \text{Arc } AF = a\theta \Rightarrow a\theta = b(\angle FCP) \Rightarrow \angle FCP = \frac{a}{b}\theta;$$

$$\angle OCG = \frac{\pi}{2} - \theta; \quad \angle OCG = \angle OCP + \angle PCE = \angle OCP + \left(\frac{\pi}{2} - \alpha\right).$$

Now $\angle OCP = \pi - \angle FCP = \pi - \frac{a}{b}\theta$. Thus $\angle OCG = \pi - \frac{a}{b}\theta + \frac{\pi}{2} - \alpha$

$$\Rightarrow \frac{\pi}{2} - \theta = \pi - \frac{a}{b}\theta + \frac{\pi}{2} - \alpha \Rightarrow \alpha = \pi - \frac{a}{b}\theta + \theta = \pi - \left(\frac{a-b}{b}\theta\right).$$

Then $x = OG - BG = OG - PE = (a-b)\cos\theta - b\cos\alpha$

$$= (a-b)\cos\theta - b\cos\left(\pi - \frac{a-b}{b}\theta\right) = (a-b)\cos\theta + b\cos\left(\frac{a-b}{b}\theta\right).$$

Also $y = EG = CG - CE = (a-b)\sin\theta - b\sin\alpha = (a-b)\sin\theta - b\sin\left(\pi - \frac{a-b}{b}\theta\right)$

$$= (a-b)\sin\theta - b\sin\left(\frac{a-b}{b}\theta\right). \text{ Therefore } x = (a-b)\cos\theta + b\cos\left(\frac{a-b}{b}\theta\right) \text{ and } y = (a-b)\sin\theta - b\sin\left(\frac{a-b}{b}\theta\right).$$

If $b = \frac{a}{4}$, then $x = \left(a - \frac{a}{4}\right)\cos\theta + \frac{a}{4}\cos\left(\frac{a - \left(\frac{a}{4}\right)}{\left(\frac{a}{4}\right)}\theta\right) = \frac{3a}{4}\cos\theta + \frac{a}{4}\cos 3\theta$

$$= \frac{3a}{4}\cos\theta + \frac{a}{4}(\cos\theta \cos 2\theta - \sin\theta \sin 2\theta) = \frac{3a}{4}\cos\theta + \frac{a}{4}\left((\cos\theta)(\cos^2\theta - \sin^2\theta) - (\sin\theta)(2 \sin\theta \cos\theta)\right)$$

$$= \frac{3a}{4}\cos\theta + \frac{a}{4}\cos^3\theta - \frac{a}{4}\cos\theta \sin^2\theta - \frac{2a}{4}\sin^2\theta \cos\theta = \frac{3a}{4}\cos\theta + \frac{a}{4}\cos^3\theta - \frac{3a}{4}(\cos\theta)(1 - \cos^2\theta)$$

$$= a \cos^3\theta; \quad y = \left(a - \frac{a}{4}\right)\sin\theta - \frac{a}{4}\sin\left(\frac{a - \left(\frac{a}{4}\right)}{\left(\frac{a}{4}\right)}\theta\right) = \frac{3a}{4}\sin\theta - \frac{a}{4}\sin 3\theta$$

$$= \frac{3a}{4}\sin\theta - \frac{a}{4}(\sin\theta \cos 2\theta + \cos\theta \sin 2\theta) = \frac{3a}{4}\sin\theta - \frac{a}{4}\left((\sin\theta)(\cos^2\theta - \sin^2\theta) + (\cos\theta)(2 \sin\theta \cos\theta)\right)$$

$$= \frac{3a}{4}\sin\theta - \frac{a}{4}\sin\theta \cos^2\theta + \frac{a}{4}\sin^3\theta - \frac{2a}{4}\cos^2\theta \sin\theta = \frac{3a}{4}\sin\theta - \frac{3a}{4}\sin\theta \cos^2\theta + \frac{a}{4}\sin^3\theta$$

$$= \frac{3a}{4}\sin\theta - \frac{3a}{4}(\sin\theta)(1 - \sin^2\theta) + \frac{a}{4}\sin^3\theta = a \sin^3\theta.$$

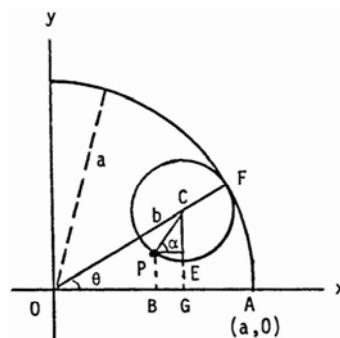

37. Draw line AM in the figure and note that $\angle AMO$ is a right angle since it is an inscribed angle which spans the diameter of a circle.

Then $AN^2 = MN^2 + AM^2$. Now, $OA = a$, $\frac{AN}{a} = \tan t$, and $\frac{AM}{a} = \sin t$. Next $MN = OP$

$$\Rightarrow OP^2 = AN^2 - AM^2 = a^2 \tan^2 t - a^2 \sin^2 t$$

$$\Rightarrow OP = \sqrt{a^2 \tan^2 t - a^2 \sin^2 t} = (a \sin t) \sqrt{\sec^2 t - 1} = \frac{a \sin^2 t}{\cos t}$$

In triangle BPO , $x = OP \sin t = \frac{a \sin^3 t}{\cos t} = a \sin^2 t \tan t$ and $y = OP \cos t = a \sin^2 t \Rightarrow x = a \sin^2 t \tan t$ and $y = a \sin^2 t$.

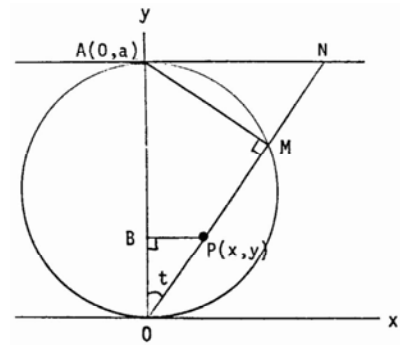

38. Let the x -axis be the line the wheel rolls along with the y -axis through a low point of the trochoid (see the accompanying figure).

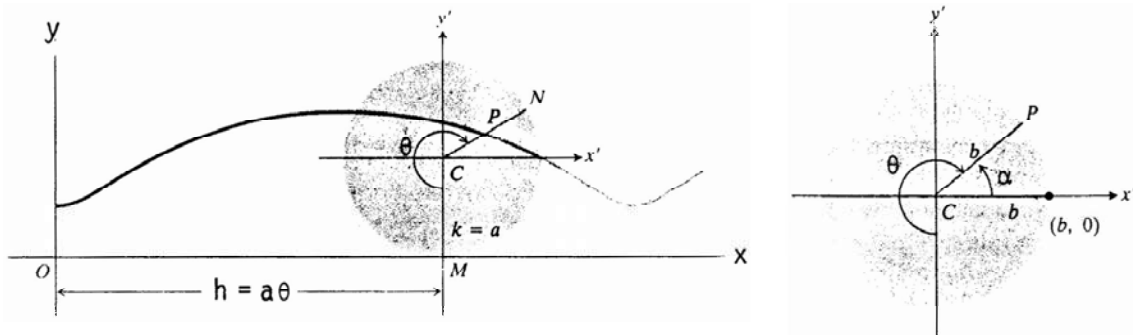

Let θ denote the angle through which the wheel turns. Then $h = a\theta$ and $k = a$. Next introduce $x'y'$ -axes parallel to the xy -axes and having their origin at the center C of the wheel. Then $x' = b \cos \alpha$ and $y' = b \sin \alpha$, where $\alpha = \frac{3\pi}{2} - \theta$. It follows that $x' = b \cos(\frac{3\pi}{2} - \theta) = -b \sin \theta$ and $y' = b \sin(\frac{3\pi}{2} - \theta) = -b \cos \theta \Rightarrow x = h + x' = a\theta - b \sin \theta$ and $y = k + y' = a - b \cos \theta$ are parametric equations of the trochoid.

39. $D = \sqrt{(x-2)^2 + (y-\frac{1}{2})^2} \Rightarrow D^2 = (x-2)^2 + (y-\frac{1}{2})^2 = (t-2)^2 + (t^2 - \frac{1}{2})^2 \Rightarrow D^2 = t^4 - 4t + \frac{17}{4}$
 $\Rightarrow \frac{d(D^2)}{dt} = 4t^3 - 4 = 0 \Rightarrow t = 1$. The second derivative is always positive for $t \neq 0 \Rightarrow t = 1$ gives a local minimum for D^2 (and hence D) which is an absolute minimum since it is the only extremum \Rightarrow the closest point on the parabola is $(1, 1)$.

40. $D = \sqrt{(2 \cos t - \frac{3}{4})^2 + (\sin t - 0)^2} \Rightarrow D^2 = (2 \cos t - \frac{3}{4})^2 + \sin^2 t$
 $\Rightarrow \frac{d(D^2)}{dt} = 2(2 \cos t - \frac{3}{4})(-2 \sin t) + 2 \sin t \cos t = (-2 \sin t)(3 \cos t - \frac{3}{2}) = 0 \Rightarrow -2 \sin t = 0$ or $3 \cos t - \frac{3}{2} = 0$
 $\Rightarrow t = 0, \pi$ or $t = \frac{\pi}{3}, \frac{5\pi}{3}$. Now $\frac{d^2(D^2)}{dt^2} = -6 \cos^2 t + 3 \cos t + 6 \sin^2 t$ so that $\frac{d^2(D^2)}{dt^2}(0) = -3 \Rightarrow$ relative maximum, $\frac{d^2(D^2)}{dt^2}(\pi) = -9 \Rightarrow$ relative maximum, $\frac{d^2(D^2)}{dt^2}(\frac{\pi}{3}) = \frac{9}{2} \Rightarrow$ relative minimum, and

$\frac{d^2(D^2)}{dt^2}\left(\frac{5\pi}{3}\right) = \frac{9}{2} \Rightarrow$ relative minimum. Therefore both $t = \frac{\pi}{3}$ and $t = \frac{5\pi}{3}$ give points on the ellipse closest to the point $\left(\frac{3}{4}, 0\right) \Rightarrow \left(1, \frac{\sqrt{3}}{2}\right)$ and $\left(1, -\frac{\sqrt{3}}{2}\right)$ are the desired points.

41. (a)

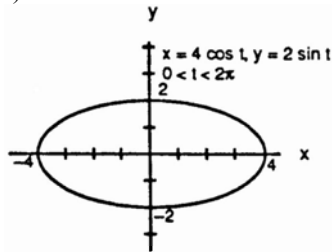

(b)

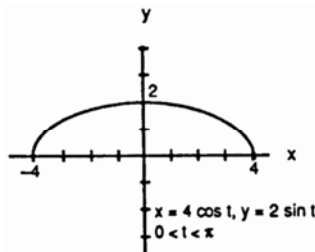

(c)

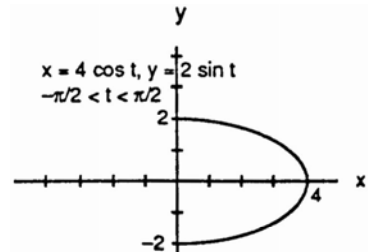

42. (a)

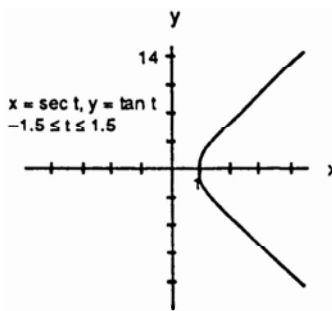

(b)

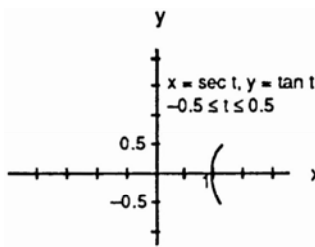

(c)

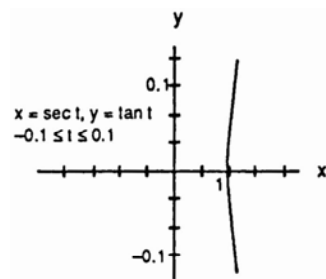

43.

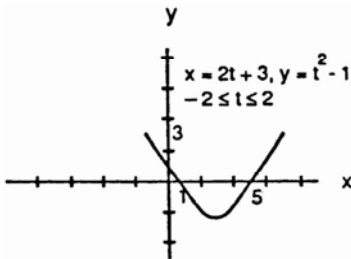

44. (a)

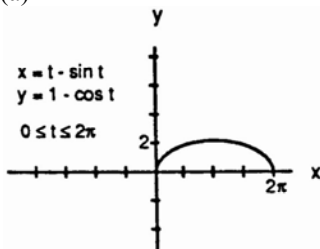

(b)

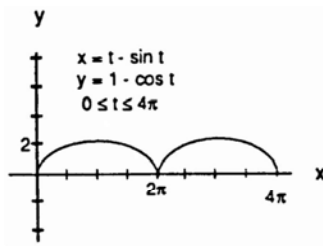

(c)

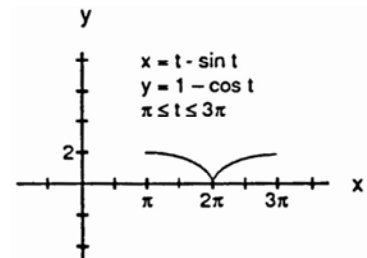

45. (a)

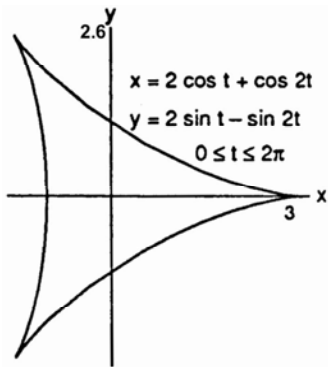

(b)

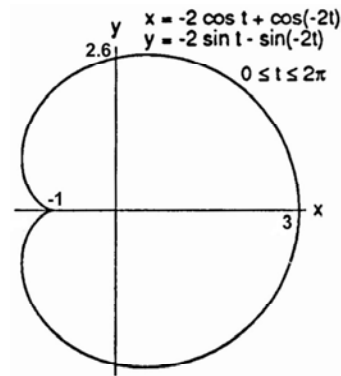

46. (a)

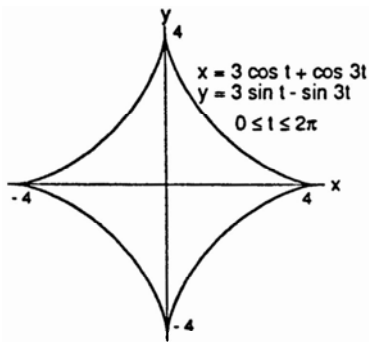

(b)

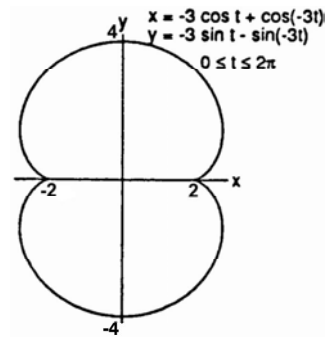

47. (a)

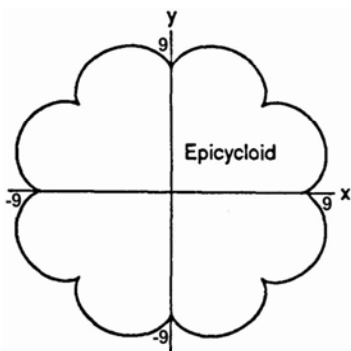

(b)

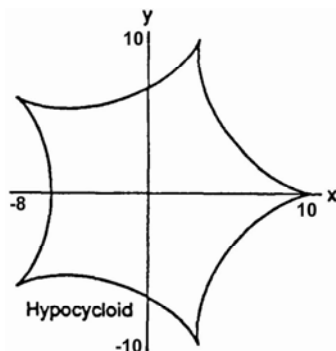

(c)

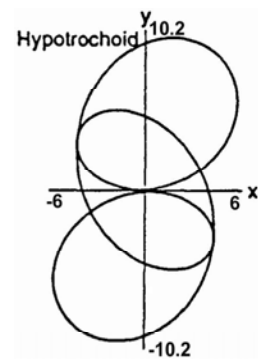

48. (a)

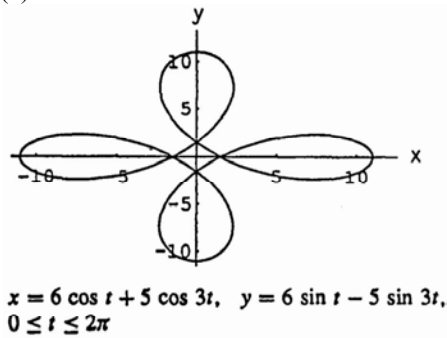

(b)

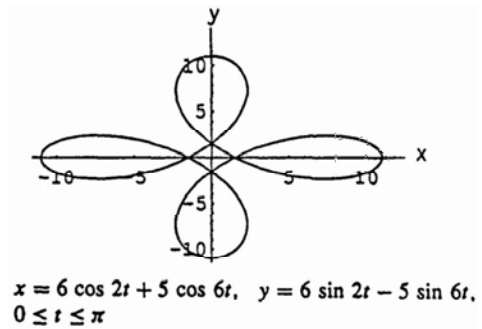

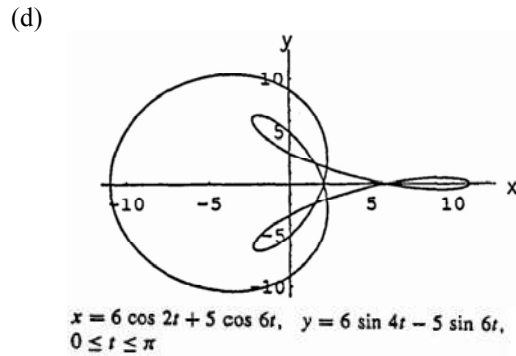
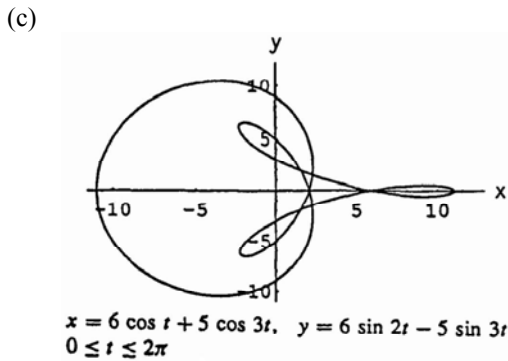

11.2 CALCULUS WITH PARAMETRIC CURVES

- $t = \frac{\pi}{4} \Rightarrow x = 2 \cos \frac{\pi}{4} = \sqrt{2}, \quad y = 2 \sin \frac{\pi}{4} = \sqrt{2}; \quad \frac{dx}{dt} = -2 \sin t, \quad \frac{dy}{dt} = 2 \cos t \Rightarrow \frac{dy}{dx} = \frac{dy/dt}{dx/dt} = \frac{2 \cos t}{-2 \sin t} = -\cot t$
 $\Rightarrow \left. \frac{dy}{dx} \right|_{t=\frac{\pi}{4}} = -\cot \frac{\pi}{4} = -1; \text{ tangent line is } y - \sqrt{2} = -1(x - \sqrt{2}) \text{ or } y = -x + 2\sqrt{2}; \quad \frac{dy'}{dt} = \csc^2 t$
 $\Rightarrow \frac{d^2y}{dx^2} = \frac{dy'/dt}{dx/dt} = \frac{\csc^2 t}{-2 \sin t} = -\frac{1}{2 \sin^3 t} \Rightarrow \left. \frac{d^2y}{dx^2} \right|_{t=\frac{\pi}{4}} = -\sqrt{2}$
- $t = -\frac{1}{6} \Rightarrow x = \sin\left(2\pi\left(-\frac{1}{6}\right)\right) = \sin\left(-\frac{\pi}{3}\right) = -\frac{\sqrt{3}}{2}, \quad y = \cos\left(2\pi\left(-\frac{1}{6}\right)\right) = \cos\left(-\frac{\pi}{3}\right) = \frac{1}{2}; \quad \frac{dx}{dt} = 2\pi \cos 2\pi t,$
 $\frac{dy}{dt} = -2\pi \sin 2\pi t \Rightarrow \frac{dy}{dx} = \frac{-2\pi \sin 2\pi t}{2\pi \cos 2\pi t} = -\tan 2\pi t \Rightarrow \left. \frac{dy}{dx} \right|_{t=-\frac{1}{6}} = -\tan\left(2\pi\left(-\frac{1}{6}\right)\right) = -\tan\left(-\frac{\pi}{3}\right) = \sqrt{3};$
 tangent line is $y - \frac{1}{2} = \sqrt{3}\left[x - \left(-\frac{\sqrt{3}}{2}\right)\right]$ or $y = \sqrt{3}x + 2; \quad \frac{dy'}{dt} = -2\pi \sec^2 2\pi t \Rightarrow \frac{d^2y}{dx^2} = \frac{-2\pi \sec^2 2\pi t}{2\pi \cos 2\pi t}$
 $= -\frac{1}{\cos^3 2\pi t} \Rightarrow \left. \frac{d^2y}{dx^2} \right|_{t=-\frac{1}{6}} = -8$
- $t = \frac{\pi}{4} \Rightarrow x = 4 \sin \frac{\pi}{4} = 2\sqrt{2}, \quad y = 2 \cos \frac{\pi}{4} = \sqrt{2}; \quad \frac{dx}{dt} = 4 \cos t, \quad \frac{dy}{dt} = -2 \sin t \Rightarrow \frac{dy}{dx} = \frac{dy/dt}{dx/dt} = \frac{-2 \sin t}{4 \cos t} = -\frac{1}{2} \tan t$
 $\Rightarrow \left. \frac{dy}{dx} \right|_{t=\frac{\pi}{4}} = -\frac{1}{2} \tan \frac{\pi}{4} = -\frac{1}{2}; \text{ tangent line is } y - \sqrt{2} = -\frac{1}{2}(x - 2\sqrt{2}) \text{ or } y = -\frac{1}{2}x + 2\sqrt{2}; \quad \frac{dy'}{dt} = -\frac{1}{2} \sec^2 t$
 $\Rightarrow \frac{d^2y}{dx^2} = \frac{dy'/dt}{dx/dt} = \frac{-\frac{1}{2} \sec^2 t}{4 \cos t} = -\frac{1}{8 \cos^3 t} \Rightarrow \left. \frac{d^2y}{dx^2} \right|_{t=\frac{\pi}{4}} = -\frac{\sqrt{2}}{4}$
- $t = \frac{2\pi}{3} \Rightarrow x = \cos \frac{2\pi}{3} = -\frac{1}{2}, \quad y = \sqrt{3} \cos \frac{2\pi}{3} = -\frac{\sqrt{3}}{2}; \quad \frac{dx}{dt} = -\sin t, \quad \frac{dy}{dt} = -\sqrt{3} \sin t \Rightarrow \frac{dy}{dx} = \frac{-\sqrt{3} \sin t}{-\sin t} = \sqrt{3}$
 $\Rightarrow \left. \frac{dy}{dx} \right|_{t=\frac{2\pi}{3}} = \sqrt{3}; \text{ tangent line is } y - \left(-\frac{\sqrt{3}}{2}\right) = \sqrt{3}\left[x - \left(-\frac{1}{2}\right)\right] \text{ or } y = \sqrt{3}x; \quad \frac{dy'}{dt} = 0 \Rightarrow \frac{d^2y}{dx^2} = \frac{0}{-\sin t} = 0$
 $\Rightarrow \left. \frac{d^2y}{dx^2} \right|_{t=\frac{2\pi}{3}} = 0$

5. $t = \frac{1}{4} \Rightarrow x = \frac{1}{4}, y = \frac{1}{2}; \frac{dx}{dt} = 1, \frac{dy}{dt} = \frac{1}{2\sqrt{t}} \Rightarrow \frac{dy}{dx} = \frac{dy/dt}{dx/dt} = \frac{1}{2\sqrt{t}} \Rightarrow \frac{dy}{dx}\bigg|_{t=\frac{1}{4}} = \frac{1}{2\sqrt{\frac{1}{4}}} = 1$; tangent line is
 $y - \frac{1}{2} = 1 \cdot (x - \frac{1}{4})$ or $y = x + \frac{1}{4}; \frac{dy'}{dt} = -\frac{1}{4}t^{-3/2} \Rightarrow \frac{d^2y}{dx^2} = \frac{dy'/dt}{dx/dt} = -\frac{1}{4}t^{-3/2} \Rightarrow \frac{d^2y}{dx^2}\bigg|_{t=\frac{1}{4}} = -2$
6. $t = -\frac{\pi}{4} \Rightarrow x = \sec^2(-\frac{\pi}{4}) - 1 = 1, y = \tan(-\frac{\pi}{4}) = -1; \frac{dx}{dt} = 2 \sec^2 t \tan t, \frac{dy}{dt} = \sec^2 t$
 $\Rightarrow \frac{dy}{dx} = \frac{\sec^2 t}{2 \sec^2 t \tan t} = \frac{1}{2 \tan t} = \frac{1}{2} \cot t \Rightarrow \frac{dy}{dx}\bigg|_{t=-\frac{\pi}{4}} = \frac{1}{2} \cot(-\frac{\pi}{4}) = -\frac{1}{2}$; tangent line is $y - (-1) = -\frac{1}{2}(x - 1)$ or
 $y = -\frac{1}{2}x - \frac{1}{2}; \frac{dy'}{dt} = -\frac{1}{2} \csc^2 t \Rightarrow \frac{d^2y}{dx^2} = \frac{-\frac{1}{2} \csc^2 t}{2 \sec^2 t \tan t} = -\frac{1}{4} \cot^3 t \Rightarrow \frac{d^2y}{dx^2}\bigg|_{t=-\frac{\pi}{4}} = \frac{1}{4}$
7. $t = \frac{\pi}{6} \Rightarrow x = \sec \frac{\pi}{6} = \frac{2}{\sqrt{3}}, y = \tan \frac{\pi}{6} = \frac{1}{\sqrt{3}}; \frac{dx}{dt} = \sec t \tan t, \frac{dy}{dt} = \sec^2 t \Rightarrow \frac{dy}{dx} = \frac{dy/dt}{dx/dt} = \frac{\sec^2 t}{\sec t \tan t} = \csc t$
 $\Rightarrow \frac{dy}{dx}\bigg|_{t=\frac{\pi}{6}} = \csc \frac{\pi}{6} = 2$; tangent line is $y - \frac{1}{\sqrt{3}} = 2(x - \frac{2}{\sqrt{3}})$ or $y = 2x - \sqrt{3}; \frac{dy'}{dt} = -\csc t \cot t$
 $\Rightarrow \frac{d^2y}{dx^2} = \frac{dy'/dt}{dx/dt} = \frac{-\csc t \cot t}{\sec t \tan t} = -\cot^3 t \Rightarrow \frac{d^2y}{dx^2}\bigg|_{t=\frac{\pi}{6}} = -3\sqrt{3}$
8. $t = 3 \Rightarrow x = -\sqrt{3+1} = -2, y = \sqrt{3(3)} = 3; \frac{dx}{dt} = -\frac{1}{2}(t+1)^{-1/2}, \frac{dy}{dt} = \frac{3}{2}(3t)^{-1/2} \Rightarrow \frac{dy}{dx} = \frac{(\frac{3}{2})(3t)^{-1/2}}{(-\frac{1}{2})(t+1)^{-1/2}} = -\frac{3\sqrt{t+1}}{\sqrt{3t}}$
 $\Rightarrow \frac{dy}{dx}\bigg|_{t=3} = \frac{-3\sqrt{3+1}}{\sqrt{3(3)}} = -2$; tangent line is $y - 3 = -2(x - (-2))$ or $y = -2x - 1$;
 $\frac{dy'}{dt} = \frac{\sqrt{3t}[-\frac{3}{2}(t+1)^{-1/2}] + 3\sqrt{t+1}[\frac{3}{2}(3t)^{-1/2}]}{3t} = \frac{3}{2t\sqrt{3t}\sqrt{t+1}} \Rightarrow \frac{d^2y}{dx^2} = \frac{(\frac{3}{2t\sqrt{3t}\sqrt{t+1}})}{(-\frac{1}{2\sqrt{t+1}})} = -\frac{3}{t\sqrt{3t}} \Rightarrow \frac{d^2y}{dx^2}\bigg|_{t=3} = -\frac{1}{3}$
9. $t = -1 \Rightarrow x = 5, y = 1; \frac{dx}{dt} = 4t, \frac{dy}{dt} = 4t^3 \Rightarrow \frac{dy}{dx} = \frac{dy/dt}{dx/dt} = \frac{4t^3}{4t} = t^2 \Rightarrow \frac{dy}{dx}\bigg|_{t=-1} = (-1)^2 = 1$; tangent line is
 $y - 1 = 1 \cdot (x - 5)$ or $y = x - 4; \frac{dy'}{dt} = 2t \Rightarrow \frac{d^2y}{dx^2} = \frac{dy'/dt}{dx/dt} = \frac{2t}{4t} = \frac{1}{2} \Rightarrow \frac{d^2y}{dx^2}\bigg|_{t=-1} = \frac{1}{2}$
10. $t = 1 \Rightarrow x = 1, y = -2; \frac{dx}{dt} = -\frac{1}{t^2}, \frac{dy}{dt} = \frac{1}{t} \Rightarrow \frac{dy}{dx} = \frac{(\frac{1}{t})}{(-\frac{1}{t^2})} = -t \Rightarrow \frac{dy}{dx}\bigg|_{t=1} = -1$; tangent line is $y - (-2) = -1(x - 1)$
or $y = -x - 1; \frac{dy'}{dt} = -1 \Rightarrow \frac{d^2y}{dx^2} = \frac{-1}{(-\frac{1}{t^2})} = t^2 \Rightarrow \frac{d^2y}{dx^2}\bigg|_{t=1} = 1$

11. $t = \frac{\pi}{3} \Rightarrow x = \frac{\pi}{3} - \sin \frac{\pi}{3} = \frac{\pi}{3} - \frac{\sqrt{3}}{2}$, $y = 1 - \cos \frac{\pi}{3} = 1 - \frac{1}{2} = \frac{1}{2}$; $\frac{dx}{dt} = 1 - \cos t$, $\frac{dy}{dt} = \sin t \Rightarrow \frac{dy}{dx} = \frac{dy/dt}{dx/dt} = \frac{\sin t}{1 - \cos t}$
 $\Rightarrow \frac{dy}{dx} \Big|_{t=\frac{\pi}{3}} = \frac{\sin(\frac{\pi}{3})}{1 - \cos(\frac{\pi}{3})} = \frac{(\frac{\sqrt{3}}{2})}{(\frac{1}{2})} = \sqrt{3}$; tangent line is $y - \frac{1}{2} = \sqrt{3} \left(x - \frac{\pi}{3} + \frac{\sqrt{3}}{2} \right) \Rightarrow y = \sqrt{3}x - \frac{\pi\sqrt{3}}{3} + 2$;
 $\frac{dy'}{dt} = \frac{(1 - \cos t)(\cos t) - (\sin t)(\sin t)}{(1 - \cos t)^2} = \frac{-1}{1 - \cos t} \Rightarrow \frac{d^2y}{dx^2} = \frac{dy'/dt}{dx/dt} = \frac{(-1)}{1 - \cos t} = \frac{-1}{(1 - \cos t)^2} \Rightarrow \frac{d^2y}{dx^2} \Big|_{t=\frac{\pi}{3}} = -4$
12. $t = \frac{\pi}{2} \Rightarrow x = \cos \frac{\pi}{2} = 0$, $y = 1 + \sin \frac{\pi}{2} = 2$; $\frac{dx}{dt} = -\sin t$, $\frac{dy}{dt} = \cos t \Rightarrow \frac{dy}{dx} = \frac{\cos t}{-\sin t} = -\cot t$
 $\Rightarrow \frac{dy}{dx} \Big|_{t=\frac{\pi}{2}} = -\cot \frac{\pi}{2} = 0$; tangent line is $y = 2$; $\frac{dy'}{dt} = \csc^2 t \Rightarrow \frac{d^2y}{dx^2} = \frac{\csc^2 t}{-\sin t} = -\csc^3 t \Rightarrow \frac{d^2y}{dx^2} \Big|_{t=\frac{\pi}{2}} = -1$
13. $t = 2 \Rightarrow x = \frac{1}{2+1} = \frac{1}{3}$, $y = \frac{2}{2-1} = 2$; $\frac{dx}{dt} = \frac{-1}{(t+1)^2}$, $\frac{dy}{dt} = \frac{-1}{(t-1)^2} \Rightarrow \frac{dy}{dx} = \frac{(t+1)^2}{(t-1)^2} \Rightarrow \frac{dy}{dx} \Big|_{t=2} = \frac{(2+1)^2}{(2-1)^2} = 9$; tangent line is
 $y = 9x - 1$; $\frac{dy'}{dt} = -\frac{4(t+1)}{(t-1)^3} \Rightarrow \frac{d^2y}{dx^2} = \frac{4(t+1)^3}{(t-1)^3} \Rightarrow \frac{d^2y}{dx^2} \Big|_{t=2} = \frac{4(2+1)^3}{(2-1)^3} = 108$
14. $t = 0 \Rightarrow x = 0 + e^0 = 1$, $y = 1 - e^0 = 0$; $\frac{dx}{dt} = 1 + e^t$, $\frac{dy}{dt} = -e^t \Rightarrow \frac{dy}{dx} = \frac{-e^t}{1+e^t} \Rightarrow \frac{dy}{dx} \Big|_{t=0} = \frac{-e^0}{1+e^0} = -\frac{1}{2}$; tangent line is
 $y = -\frac{1}{2}x + \frac{1}{2}$; $\frac{dy'}{dt} = \frac{-e^t}{(1+e^t)^2} \Rightarrow \frac{d^2y}{dx^2} = \frac{-e^t}{(1+e^t)^3} \Rightarrow \frac{d^2y}{dx^2} \Big|_{t=0} = \frac{-e^0}{(1+e^0)^3} = -\frac{1}{8}$
15. $x^3 + 2t^2 = 9 \Rightarrow 3x^2 \frac{dx}{dt} + 4t = 0 \Rightarrow 3x^2 \frac{dx}{dt} = -4t \Rightarrow \frac{dx}{dt} = \frac{-4t}{3x^2}$; $2y^3 - 3t^2 = 4 \Rightarrow 6y^2 \frac{dy}{dt} - 6t = 0$
 $\Rightarrow \frac{dy}{dx} = \frac{6t}{6y^2} = \frac{t}{y^2}$; thus $\frac{dy}{dx} = \frac{dy/dt}{dx/dt} = \frac{(\frac{t}{y^2})}{(\frac{-4t}{3x^2})} = \frac{t(3x^2)}{y^2(-4t)} = \frac{3x^2}{-4y^2}$; $t = 2 \Rightarrow x^3 + 2(2)^2 = 9 \Rightarrow x^3 + 8 = 9 \Rightarrow x^3 = 1$
 $\Rightarrow x = 1$; $t = 2 \Rightarrow 2y^3 - 3(2)^2 = 4 \Rightarrow 2y^3 = 16 \Rightarrow y^3 = 8 \Rightarrow y = 2$; therefore $\frac{dy}{dx} \Big|_{t=2} = \frac{3(1)^2}{-4(2)^2} = -\frac{3}{16}$
16. $x = \sqrt{5 - \sqrt{t}} \Rightarrow \frac{dx}{dt} = \frac{1}{2}(5 - \sqrt{t})^{-1/2} \left(-\frac{1}{2}t^{-1/2} \right) = -\frac{1}{4\sqrt{t}\sqrt{5 - \sqrt{t}}}$; $y(t-1) = \sqrt{t} \Rightarrow y + (t-1)\frac{dy}{dt} = \frac{1}{2}t^{-1/2}$
 $\Rightarrow (t-1)\frac{dy}{dt} = \frac{1}{2\sqrt{t}} - y \Rightarrow \frac{dy}{dt} = \frac{\frac{1}{2\sqrt{t}} - y}{(t-1)} = \frac{1 - 2y\sqrt{t}}{2t\sqrt{t} - 2\sqrt{t}}$; thus $\frac{dy}{dx} = \frac{dy/dt}{dx/dt} = \frac{1 - 2y\sqrt{t}}{4\sqrt{t}\sqrt{5 - \sqrt{t}}}$
 $= \frac{2(1 - 2y\sqrt{t})\sqrt{5 - \sqrt{t}}}{1 - t}$; $t = 4 \Rightarrow x = \sqrt{5 - \sqrt{4}} = \sqrt{3}$; $t = 4 \Rightarrow y \cdot 3 = \sqrt{4} \Rightarrow y = \frac{2}{3}$ therefore,
 $\frac{dy}{dx} \Big|_{t=4} = \frac{2(1 - 2(\frac{2}{3})\sqrt{4})\sqrt{5 - \sqrt{4}}}{1 - 4} = \frac{10\sqrt{3}}{9}$
17. $x + 2x^{3/2} = t^2 + t \Rightarrow \frac{dx}{dt} + 3x^{1/2} \frac{dx}{dt} = 2t + 1 \Rightarrow (1 + 3x^{1/2}) \frac{dx}{dt} = 2t + 1 \Rightarrow \frac{dx}{dt} = \frac{2t+1}{1+3x^{1/2}}$; $y\sqrt{t+1} + 2t\sqrt{y} = 4$
 $\Rightarrow \frac{dy}{dt} \sqrt{t+1} + y \left(\frac{1}{2} \right) (t+1)^{-1/2} + 2\sqrt{y} + 2t \left(\frac{1}{2} y^{-1/2} \right) \frac{dy}{dt} = 0 \Rightarrow \frac{dy}{dt} \sqrt{t+1} + \frac{y}{2\sqrt{t+1}} + 2\sqrt{y} + \left(\frac{t}{\sqrt{y}} \right) \frac{dy}{dt} = 0$

$$\Rightarrow \left(\sqrt{t+1} + \frac{t}{\sqrt{y}} \right) \frac{dy}{dt} = \frac{-y}{2\sqrt{t+1}} - 2\sqrt{y} \Rightarrow \frac{dy}{dt} = \frac{\left(\frac{-y}{2\sqrt{t+1}} - 2\sqrt{y} \right)}{\left(\sqrt{t+1} + \frac{t}{\sqrt{y}} \right)} = \frac{-y\sqrt{y} - 4y\sqrt{t+1}}{2\sqrt{y}(t+1) + 2t\sqrt{t+1}}; \text{ thus } \frac{dy}{dx} = \frac{dy/dt}{dx/dt} = \frac{\left(\frac{-y\sqrt{y} - 4y\sqrt{t+1}}{2\sqrt{y}(t+1) + 2t\sqrt{t+1}} \right)}{\left(\frac{2t+1}{1+3x^{1/2}} \right)},$$

$$t=0 \Rightarrow x+2x^{3/2}=0 \Rightarrow x(1+2x^{1/2})=0 \Rightarrow x=0; \quad t=0 \Rightarrow y\sqrt{0+1}+2(0)\sqrt{y}=4 \Rightarrow y=4;$$

$$\text{therefore } \left. \frac{dy}{dx} \right|_{t=0} = \frac{\left(\frac{-4\sqrt{4} - 4(4)\sqrt{0+1}}{2\sqrt{4}(0+1) + 2(0)\sqrt{0+1}} \right)}{\left(\frac{2(0)+1}{1+3(0)^{1/2}} \right)} = -6$$

$$18. \quad x \sin t + 2x = t \Rightarrow \frac{dx}{dt} \sin t + x \cos t + 2 \frac{dx}{dt} = 1 \Rightarrow (\sin t + 2) \frac{dx}{dt} = 1 - x \cos t \Rightarrow \frac{dx}{dt} = \frac{1-x \cos t}{\sin t + 2};$$

$$t \sin t - 2t = y \Rightarrow \sin t + t \cos t - 2 = \frac{dy}{dt}; \text{ thus } \frac{dy}{dx} = \frac{\sin t + t \cos t - 2}{\left(\frac{1-x \cos t}{\sin t + 2} \right)}; \quad t = \pi \Rightarrow x \sin \pi + 2x = \pi \Rightarrow x = \frac{\pi}{2};$$

$$\text{therefore } \left. \frac{dy}{dx} \right|_{t=\pi} = \frac{\sin \pi + \pi \cos \pi - 2}{\left(\frac{1 - \left(\frac{\pi}{2} \right) \cos \pi}{\sin \pi + 2} \right)} = \frac{-4\pi - 8}{2 + \pi} = -4$$

$$19. \quad x = t^3 + t, \quad y + 2t^3 = 2x + t^2 \Rightarrow \frac{dx}{dt} = 3t^2 + 1, \quad \frac{dy}{dt} + 6t^2 = 2 \frac{dx}{dt} + 2t \Rightarrow \frac{dy}{dt} = 2(3t^2 + 1) + 2t - 6t^2 = 2t + 2$$

$$\Rightarrow \frac{dy}{dx} = \frac{2t+2}{3t^2+1} \Rightarrow \left. \frac{dy}{dx} \right|_{t=1} = \frac{2(1)+2}{3(1)^2+1} = 1$$

$$20. \quad t = \ln(x-t), \quad y = te^t \Rightarrow 1 = \frac{1}{x-t} \left(\frac{dx}{dt} - 1 \right) \Rightarrow x-t = \frac{dx}{dt} - 1 \Rightarrow \frac{dx}{dt} = x-t+1, \quad \frac{dy}{dt} = te^t + e^t; \Rightarrow \frac{dy}{dx} = \frac{te^t + e^t}{x-t+1};$$

$$t=0 \Rightarrow 0 = \ln(x-0) \Rightarrow x=1 \Rightarrow \left. \frac{dy}{dx} \right|_{t=0} = \frac{(0)e^0 + e^0}{1-0+1} = \frac{1}{2}$$

$$21. \quad A = \int_0^{2\pi} y \, dx = \int_0^{2\pi} a(1-\cos t)a(1-\cos t) \, dt = a^2 \int_0^{2\pi} (1-\cos t)^2 \, dt = a^2 \int_0^{2\pi} (1-2\cos t + \cos^2 t) \, dt$$

$$= a^2 \int_0^{2\pi} \left(1-2\cos t + \frac{1+\cos 2t}{2} \right) \, dt = a^2 \int_0^{2\pi} \left(\frac{3}{2} - 2\cos t + \frac{1}{2} \cos 2t \right) \, dt = a^2 \left[\frac{3}{2}t - 2\sin t + \frac{1}{4} \sin 2t \right]_0^{2\pi}$$

$$= a^2(3\pi - 0 + 0) - 0 = 3\pi a^2$$

$$22. \quad A = \int_0^1 x \, dy = \int_0^1 (t-t^2)(-e^{-t}) \, dt \quad \left[u = t-t^2 \Rightarrow du = (1-2t) \, dt; \, dv = (-e^{-t}) \, dt \Rightarrow v = e^{-t} \right]$$

$$= \left[e^{-t}(t-t^2) \right]_0^1 - \int_0^1 e^{-t}(1-2t) \, dt \quad \left[u = 1-2t \Rightarrow du = -2 \, dt; \, dv = e^{-t} \, dt \Rightarrow v = -e^{-t} \right]$$

$$= \left[e^{-t}(t-t^2) \right]_0^1 - \left(\left[-e^{-t}(1-2t) \right]_0^1 - \int_0^1 2e^{-t} \, dt \right) = \left[e^{-t}(t-t^2) + e^{-t}(1-2t) - 2e^{-t} \right]_0^1$$

$$= \left(e^{-1}(0) + e^{-1}(-1) - 2e^{-1} \right) - \left(e^0(0) + e^0(1) - 2e^0 \right) = 1 - 3e^{-1} = 1 - \frac{3}{e}$$

$$23. \quad A = 2 \int_{\pi}^0 y \, dx = 2 \int_{\pi}^0 (b \sin t)(-a \sin t) \, dt = 2ab \int_0^{\pi} \sin^2 t \, dt = 2ab \int_0^{\pi} \frac{1-\cos 2t}{2} \, dt = ab \int_0^{\pi} (1-\cos 2t) \, dt$$

$$= ab \left[t - \frac{1}{2} \sin 2t \right]_0^{\pi} = ab((\pi - 0) - 0) = \pi ab$$

$$24. \text{ (a) } x = t^2, y = t^6, 0 \leq t \leq 1 \Rightarrow A = \int_0^1 y \, dx = \int_0^1 (t^6) 2t \, dt = \int_0^1 2t^7 \, dt = \left[\frac{1}{4} t^8 \right]_0^1 = \frac{1}{4} - 0 = \frac{1}{4}$$

$$\text{ (b) } x = t^3, y = t^9, 0 \leq t \leq 1 \Rightarrow A = \int_0^1 y \, dx = \int_0^1 (t^9) 3t^2 \, dt = \int_0^1 3t^{11} \, dt = \left[\frac{1}{4} t^{12} \right]_0^1 = \frac{1}{4} - 0 = \frac{1}{4}$$

$$25. \frac{dx}{dt} = -\sin t \text{ and } \frac{dy}{dt} = 1 + \cos t \Rightarrow \sqrt{\left(\frac{dx}{dt}\right)^2 + \left(\frac{dy}{dt}\right)^2} = \sqrt{(-\sin t)^2 + (1 + \cos t)^2} = \sqrt{2 + 2 \cos t}$$

$$\Rightarrow \text{Length} = \int_0^\pi \sqrt{2 + 2 \cos t} \, dt = \sqrt{2} \int_0^\pi \sqrt{\frac{1 - \cos t}{1 + \cos t}} (1 + \cos t) \, dt = \sqrt{2} \int_0^\pi \sqrt{\frac{\sin^2 t}{1 - \cos t}} \, dt = \sqrt{2} \int_0^\pi \frac{\sin t}{\sqrt{1 - \cos t}} \, dt$$

$$\text{(since } \sin t \geq 0 \text{ on } [0, \pi]); [u = 1 - \cos t \Rightarrow du = \sin t \, dt; t = 0 \Rightarrow u = 0, t = \pi \Rightarrow u = 2]$$

$$\rightarrow \sqrt{2} \int_0^2 u^{-1/2} \, du = \sqrt{2} \left[2u^{1/2} \right]_0^2 = 4$$

$$26. \frac{dx}{dt} = 3t^2 \text{ and } \frac{dy}{dt} = 3t \Rightarrow \sqrt{\left(\frac{dx}{dt}\right)^2 + \left(\frac{dy}{dt}\right)^2} = \sqrt{(3t^2)^2 + (3t)^2} = \sqrt{9t^4 + 9t^2} = 3t\sqrt{t^2 + 1} \text{ (since } t \geq 0 \text{ on } [0, \sqrt{3}])$$

$$\Rightarrow \text{Length} = \int_0^{\sqrt{3}} 3t\sqrt{t^2 + 1} \, dt; [u = t^2 + 1 \Rightarrow \frac{3}{2} du = 3t \, dt; t = 0 \Rightarrow u = 1, t = \sqrt{3} \Rightarrow u = 4]$$

$$\rightarrow \int_1^4 \frac{3}{2} u^{1/2} \, du = \left[u^{3/2} \right]_1^4 = (8 - 1) = 7$$

$$27. \frac{dx}{dt} = t \text{ and } \frac{dy}{dt} = (2t + 1)^{1/2} \Rightarrow \sqrt{\left(\frac{dx}{dt}\right)^2 + \left(\frac{dy}{dt}\right)^2} = \sqrt{t^2 + (2t + 1)} = \sqrt{(t + 1)^2} = |t + 1| = t + 1 \text{ since } 0 \leq t \leq 4$$

$$\Rightarrow \text{Length} = \int_0^4 (t + 1) \, dt = \left[\frac{t^2}{2} + t \right]_0^4 = (8 + 4) = 12$$

$$28. \frac{dx}{dt} = (2t + 3)^{1/2} \text{ and } \frac{dy}{dt} = 1 + t \Rightarrow \sqrt{\left(\frac{dx}{dt}\right)^2 + \left(\frac{dy}{dt}\right)^2} = \sqrt{(2t + 3) + (1 + t)^2} = \sqrt{t^2 + 4t + 4} = |t + 2| = t + 2$$

$$\text{since } 0 \leq t \leq 3 \Rightarrow \text{Length} = \int_0^3 (t + 2) \, dt = \left[\frac{t^2}{2} + 2t \right]_0^3 = \frac{21}{2}$$

$$29. \frac{dx}{dt} = 8t \cos t \text{ and } \frac{dy}{dt} = 8t \sin t \Rightarrow \sqrt{\left(\frac{dx}{dt}\right)^2 + \left(\frac{dy}{dt}\right)^2} = \sqrt{(8t \cos t)^2 + (8t \sin t)^2} = \sqrt{64t^2 \cos^2 t + 64t^2 \sin^2 t}$$

$$= |8t| = 8t \text{ since } 0 \leq t \leq \frac{\pi}{2} \Rightarrow \text{Length} = \int_0^{\pi/2} 8t \, dt = \left[4t^2 \right]_0^{\pi/2} = \pi^2$$

$$30. \frac{dx}{dt} = \left(\frac{1}{\sec t + \tan t} \right) (\sec t \tan t + \sec^2 t) - \cos t = \sec t - \cos t \text{ and } \frac{dy}{dt} = -\frac{dx}{dt} \Rightarrow \sqrt{\left(\frac{dx}{dt}\right)^2 + \left(\frac{dy}{dt}\right)^2}$$

$$= \sqrt{(\sec t - \cos t)^2 + (-\sin t)^2} = \sqrt{\sec^2 t - 1} = \sqrt{\tan^2 t} = |\tan t| = \tan t \text{ since } 0 \leq t \leq \frac{\pi}{3}$$

$$\Rightarrow \text{Length} = \int_0^{\pi/3} \tan t \, dt = \int_0^{\pi/3} \frac{\sin t}{\cos t} \, dt = [-\ln |\cos t|]_0^{\pi/3} = -\ln \frac{1}{2} + \ln 1 = \ln 2$$

$$31. \frac{dx}{dt} = -\sin t \text{ and } \frac{dy}{dt} = \cos t \Rightarrow \sqrt{\left(\frac{dx}{dt}\right)^2 + \left(\frac{dy}{dt}\right)^2} = \sqrt{(-\sin t)^2 + (\cos t)^2} = 1$$

$$\Rightarrow \text{Area} = \int 2\pi y \, ds = \int_0^{2\pi} 2\pi(2 + \sin t)(1)dt = 2\pi [2t - \cos t]_0^{2\pi} = 2\pi [(4\pi - 1) - (0 - 1)] = 8\pi^2$$

$$32. \frac{dx}{dt} = t^{1/2} \text{ and } \frac{dy}{dt} = t^{-1/2} \Rightarrow \sqrt{\left(\frac{dx}{dt}\right)^2 + \left(\frac{dy}{dt}\right)^2} = \sqrt{t + t^{-1}} = \sqrt{\frac{t^2 + 1}{t}} \Rightarrow \text{Area} = \int 2\pi x \, ds = \int_0^{\sqrt{3}} 2\pi \left(\frac{2}{3} t^{3/2}\right) \sqrt{\frac{t^2 + 1}{t}} dt$$

$$= \frac{4\pi}{3} \int_0^{\sqrt{3}} t \sqrt{t^2 + 1} \, dt; \left[u = t^2 + 1 \Rightarrow du = 2t \, dt; t = 0 \Rightarrow u = 1, t = \sqrt{3} \Rightarrow u = 4 \right]$$

$$\rightarrow \int_1^4 \frac{2\pi}{3} \sqrt{u} \, du = \left[\frac{4\pi}{9} u^{3/2} \right]_1^4 = \frac{28\pi}{9}$$

Note: $\int_0^{\sqrt{3}} 2\pi \left(\frac{2}{3} t^{3/2}\right) \sqrt{\frac{t^2 + 1}{t}} dt$ is an improper integral but $\lim_{t \rightarrow 0^+} f(t)$ exists and is equal to 0, where

$$f(t) = 2\pi \left(\frac{2}{3} t^{3/2}\right) \sqrt{\frac{t^2 + 1}{t}}. \text{ Thus the discontinuity is removable: define } F(t) = f(t) \text{ for } t > 0 \text{ and } F(0) = 0 \Rightarrow \int_0^{\sqrt{3}} F(t) \, dt = \frac{28\pi}{9}.$$

$$33. \frac{dx}{dt} = 1 \text{ and } \frac{dy}{dt} = t + \sqrt{2} \Rightarrow \sqrt{\left(\frac{dx}{dt}\right)^2 + \left(\frac{dy}{dt}\right)^2} = \sqrt{1^2 + (t + \sqrt{2})^2} = \sqrt{t^2 + 2\sqrt{2}t + 3}$$

$$\Rightarrow \text{Area} = \int 2\pi x \, ds = \int_{-\sqrt{2}}^{\sqrt{2}} 2\pi(t + \sqrt{2}) \sqrt{t^2 + 2\sqrt{2}t + 3} \, dt;$$

$$\left[u = t^2 + 2\sqrt{2}t + 3 \Rightarrow du = (2t + 2\sqrt{2}) dt; t = -\sqrt{2} \Rightarrow u = 1, t = \sqrt{2} \Rightarrow u = 9 \right]$$

$$\rightarrow \int_1^9 \pi \sqrt{u} \, du = \left[\frac{2}{3} \pi u^{3/2} \right]_1^9 = \frac{2\pi}{3} (27 - 1) = \frac{52\pi}{3}$$

$$34. \text{ From Exercise 30, } \sqrt{\left(\frac{dx}{dt}\right)^2 + \left(\frac{dy}{dt}\right)^2} = \tan t \Rightarrow \text{Area} = \int 2\pi y \, ds = \int_0^{\pi/3} 2\pi \cos t \tan t \, dt = 2\pi \int_0^{\pi/3} \sin t \, dt$$

$$= 2\pi [-\cos t]_0^{\pi/3} = 2\pi \left[-\frac{1}{2} - (-1)\right] = \pi$$

$$35. \frac{dx}{dt} = 2 \text{ and } \frac{dy}{dt} = 1 \Rightarrow \sqrt{\left(\frac{dx}{dt}\right)^2 + \left(\frac{dy}{dt}\right)^2} = \sqrt{2^2 + 1^2} = \sqrt{5} \Rightarrow \text{Area} = \int 2\pi y \, ds = \int_0^1 2\pi(t + 1)\sqrt{5} \, dt$$

$$= 2\pi\sqrt{5} \left[\frac{t^2}{2} + t \right]_0^1 = 3\pi\sqrt{5}. \text{ Check: slant height is } \sqrt{5} \Rightarrow \text{Area is } \pi(1 + 2)\sqrt{5} = 3\pi\sqrt{5}.$$

$$36. \frac{dx}{dt} = h \text{ and } \frac{dy}{dt} = r \Rightarrow \sqrt{\left(\frac{dx}{dt}\right)^2 + \left(\frac{dy}{dt}\right)^2} = \sqrt{h^2 + r^2} \Rightarrow \text{Area} = \int 2\pi y \, ds = \int_0^1 2\pi r t \sqrt{h^2 + r^2} \, dt$$

$$= 2\pi r \sqrt{h^2 + r^2} \int_0^1 t \, dt = 2\pi r \sqrt{h^2 + r^2} \left[\frac{t^2}{2} \right]_0^1 = \pi r \sqrt{h^2 + r^2}.$$

Check: slant height is $\sqrt{h^2 + r^2} \Rightarrow \text{Area is } \pi r \sqrt{h^2 + r^2}.$

37. Let the density be $\delta = 1$. Then $x = \cos t + t \sin t \Rightarrow \frac{dx}{dt} = t \cos t$, and $y = \sin t - t \cos t \Rightarrow \frac{dy}{dt} = t \sin t$
 $\Rightarrow dm = 1 \cdot ds = \sqrt{\left(\frac{dx}{dt}\right)^2 + \left(\frac{dy}{dt}\right)^2} dt = \sqrt{(t \cos t)^2 + (t \sin t)^2} = |t| dt = t dt$ since $0 \leq t \leq \frac{\pi}{2}$. The curve's mass is
 $M = \int dm = \int_0^{\pi/2} t dt = \frac{\pi^2}{8}$. Also $M_x = \int \tilde{y} dm = \int_0^{\pi/2} (\sin t - t \cos t) t dt = \int_0^{\pi/2} t \sin t dt - \int_0^{\pi/2} t^2 \cos t dt$
 $= [\sin t - t \cos t]_0^{\pi/2} - [t^2 \sin t - 2 \sin t + 2t \cos t]_0^{\pi/2} = 3 - \frac{\pi^2}{4}$, where we integrated by parts. Therefore,
 $\bar{y} = \frac{M_x}{M} = \frac{\left(3 - \frac{\pi^2}{4}\right)}{\left(\frac{\pi^2}{8}\right)} = \frac{24}{\pi^2} - 2$. Next, $M_y = \int \tilde{x} dm = \int_0^{\pi/2} (\cos t + t \sin t) t dt = \int_0^{\pi/2} t \cos t dt + \int_0^{\pi/2} t^2 \sin t dt$
 $= [\cos t + t \sin t]_0^{\pi/2} + [-t^2 \cos t + 2 \cos t + 2t \sin t]_0^{\pi/2} = \frac{3\pi}{2} - 3$, again integrating by parts. Hence,
 $\bar{x} = \frac{M_y}{M} = \frac{\left(\frac{3\pi}{2} - 3\right)}{\left(\frac{\pi^2}{8}\right)} = \frac{12}{\pi} - \frac{24}{\pi^2}$. Therefore $(\bar{x}, \bar{y}) = \left(\frac{12}{\pi} - \frac{24}{\pi^2}, \frac{24}{\pi^2} - 2\right)$.

38. Let the density be $\delta = 1$. Then $x = e^t \cos t \Rightarrow \frac{dx}{dt} = e^t \cos t - e^t \sin t$, and $y = e^t \sin t \Rightarrow \frac{dy}{dx} = e^t \sin t + e^t \cos t$
 $\Rightarrow dm = 1 \cdot ds = \sqrt{\left(\frac{dx}{dt}\right)^2 + \left(\frac{dy}{dt}\right)^2} dt = \sqrt{(e^t \cos t - e^t \sin t)^2 + (e^t \sin t + e^t \cos t)^2} dt = \sqrt{2e^{2t}} dt = \sqrt{2} e^t dt$.
 The curve's mass is $M = \int dm = \int_0^{\pi} \sqrt{2} e^t dt = \sqrt{2} e^{\pi} - \sqrt{2}$. Also $M_x = \int \tilde{y} dm = \int_0^{\pi} (e^t \sin t) (\sqrt{2} e^t) dt$
 $= \int_0^{\pi} \sqrt{2} e^{2t} \sin t dt = \sqrt{2} \left[\frac{e^{2t}}{5} (2 \sin t - \cos t) \right]_0^{\pi} = \sqrt{2} \left(\frac{e^{2\pi}}{5} + \frac{1}{5} \right) \Rightarrow \bar{y} = \frac{M_x}{M} = \frac{\sqrt{2} \left(\frac{e^{2\pi}}{5} + \frac{1}{5} \right)}{\sqrt{2} e^{\pi} - \sqrt{2}} = \frac{e^{2\pi} + 1}{5(e^{\pi} - 1)}$.
 Next $M_y = \int \tilde{x} dm = \int_0^{\pi} (e^t \cos t) (\sqrt{2} e^t) dt = \int_0^{\pi} \sqrt{2} e^{2t} \cos t dt = \sqrt{2} \left[\frac{e^{2t}}{5} (2 \cos t + \sin t) \right]_0^{\pi} = -\sqrt{2} \left(\frac{2e^{2\pi}}{5} + \frac{2}{5} \right)$
 $\Rightarrow \bar{x} = \frac{M_y}{M} = \frac{-\sqrt{2} \left(\frac{2e^{2\pi}}{5} + \frac{2}{5} \right)}{\sqrt{2} e^{\pi} - \sqrt{2}} = -\frac{2e^{2\pi} + 2}{5(e^{\pi} - 1)}$. Therefore $(\bar{x}, \bar{y}) = \left(-\frac{2e^{2\pi} + 2}{5(e^{\pi} - 1)}, \frac{e^{2\pi} + 1}{5(e^{\pi} - 1)} \right)$.

39. Let the density be $\delta = 1$. Then $x = \cos t \Rightarrow \frac{dx}{dt} = -\sin t$, and $y = t + \sin t \Rightarrow \frac{dy}{dt} = 1 + \cos t$
 $\Rightarrow dm = 1 \cdot ds = \sqrt{\left(\frac{dx}{dt}\right)^2 + \left(\frac{dy}{dt}\right)^2} dt = \sqrt{(-\sin t)^2 + (1 + \cos t)^2} dt = \sqrt{2 + 2 \cos t} dt$. The curve's mass is
 $M = \int dm = \int_0^{\pi} \sqrt{2 + 2 \cos t} dt = \sqrt{2} \int_0^{\pi} \sqrt{1 + \cos t} dt = \sqrt{2} \int_0^{\pi} \sqrt{2 \cos^2 \left(\frac{t}{2}\right)} dt = 2 \int_0^{\pi} \left| \cos \left(\frac{t}{2}\right) \right| dt = 2 \int_0^{\pi} \cos \left(\frac{t}{2}\right) dt$
 (since $0 \leq t \leq \pi \Rightarrow 0 \leq \frac{t}{2} \leq \frac{\pi}{2}$) $= 2 \left[2 \sin \left(\frac{t}{2}\right) \right]_0^{\pi} = 4$. Also $M_x = \int \tilde{y} dm = \int_0^{\pi} (t + \sin t) \left(2 \cos \frac{t}{2} \right) dt$
 $= \int_0^{\pi} 2t \cos \left(\frac{t}{2}\right) dt + \int_0^{\pi} 2 \sin t \cos \left(\frac{t}{2}\right) dt = 2 \left[4 \cos \left(\frac{t}{2}\right) + 2t \sin \left(\frac{t}{2}\right) \right]_0^{\pi} + 2 \left[-\frac{1}{3} \cos \left(\frac{3}{2}t\right) - \cos \left(\frac{1}{2}t\right) \right]_0^{\pi} = 4\pi - \frac{16}{3}$
 $\Rightarrow \bar{y} = \frac{M_x}{M} = \frac{4\pi - \frac{16}{3}}{4} = \pi - \frac{4}{3}$. Next $M_y = \int \tilde{x} dm = \int_0^{\pi} (\cos t) \left(2 \cos \frac{t}{2} \right) dt = 2 \int_0^{\pi} \cos t \cos \left(\frac{t}{2}\right) dt$
 $= 2 \left[\sin \left(\frac{t}{2}\right) + \frac{\sin \left(\frac{3}{2}t\right)}{3} \right]_0^{\pi} = 2 - \frac{2}{3} = \frac{4}{3} \Rightarrow \bar{x} = \frac{M_y}{M} = \frac{\left(\frac{4}{3}\right)}{4} = \frac{1}{3}$. Therefore $(\bar{x}, \bar{y}) = \left(\frac{1}{3}, \pi - \frac{4}{3}\right)$.

40. Let the density be $\delta = 1$. Then $x = t^3 \Rightarrow \frac{dx}{dt} = 3t^2$, and $y = \frac{3t^2}{2} \Rightarrow \frac{dy}{dt} = 3t \Rightarrow dm = 1 \cdot ds = \sqrt{\left(\frac{dx}{dt}\right)^2 + \left(\frac{dy}{dt}\right)^2} dt$
 $= \sqrt{(3t^2)^2 + (3t)^2} dt = 3|t|\sqrt{t^2 + 1} dt = 3t\sqrt{t^2 + 1} dt$ since $0 \leq t \leq \sqrt{3}$. The curve's mass is
 $M = \int dm = \int_0^{\sqrt{3}} 3t\sqrt{t^2 + 1} dt = \left[(t^2 + 1)^{3/2} \right]_0^{\sqrt{3}} = 7$. Also $M_x = \int \tilde{y} dm = \int_0^{\sqrt{3}} \frac{3t^2}{2} (3t\sqrt{t^2 + 1}) dt$
 $= \frac{9}{2} \int_0^{\sqrt{3}} t^3 \sqrt{t^2 + 1} dt = \frac{87}{5} = 17.4$ (by computer) $\Rightarrow \bar{y} = \frac{M_x}{M} = \frac{17.4}{7} \approx 2.49$. Next $M_y = \int \tilde{x} dm$
 $= \int_0^{\sqrt{3}} t^3 \cdot 3t\sqrt{t^2 + 1} dt = 3 \int_0^{\sqrt{3}} t^4 \sqrt{t^2 + 1} dt \approx 16.4849$ (by computer) $\Rightarrow \bar{x} = \frac{M_y}{M} = \frac{16.4849}{7} \approx 2.35$.
 Therefore, $(\bar{x}, \bar{y}) \approx (2.35, 2.49)$.

41. (a) $\frac{dx}{dt} = -2 \sin 2t$ and $\frac{dy}{dt} = 2 \cos 2t \Rightarrow \sqrt{\left(\frac{dx}{dt}\right)^2 + \left(\frac{dy}{dt}\right)^2} = \sqrt{(-2 \sin 2t)^2 + (2 \cos 2t)^2} = 2$
 $\Rightarrow \text{Length} = \int_0^{\pi/2} 2 dt = [2t]_0^{\pi/2} = \pi$
 (b) $\frac{dx}{dt} = \pi \cos \pi t$ and $\frac{dy}{dt} = -\pi \sin \pi t \Rightarrow \sqrt{\left(\frac{dx}{dt}\right)^2 + \left(\frac{dy}{dt}\right)^2} = \sqrt{(\pi \cos \pi t)^2 + (-\pi \sin \pi t)^2} = \pi$
 $\Rightarrow \text{Length} = \int_{-1/2}^{1/2} \pi dt = [\pi t]_{-1/2}^{1/2} = \pi$

42. (a) $x = g(y)$ has the parametrization $x = g(y)$ and $y = y$ for $c \leq y \leq d \Rightarrow \frac{dx}{dy} = g'(y)$ and $\frac{dy}{dy} = 1$; then

$$\text{Length} = \int_c^d \sqrt{\left(\frac{dx}{dy}\right)^2 + \left(\frac{dy}{dy}\right)^2} dy = \int_c^d \sqrt{1 + \left(\frac{dx}{dy}\right)^2} dy = \int_c^d \sqrt{1 + [g'(y)]^2} dy$$

- (b) $x = y^{3/2}$, $0 \leq y \leq \frac{4}{3} \Rightarrow \frac{dx}{dy} = \frac{3}{2} y^{1/2} \Rightarrow L = \int_0^{4/3} \sqrt{1 + \left(\frac{3}{2} y^{1/2}\right)^2} dy = \int_0^{4/3} \sqrt{1 + \frac{9}{4} y} dy = \left[\frac{4}{9} \cdot \frac{2}{3} \left(1 + \frac{9}{4} y\right)^{3/2} \right]_0^{4/3}$
 $= \frac{8}{27} (4)^{3/2} - \frac{8}{27} (1)^{3/2} = \frac{56}{27}$
 (c) $x = \frac{3}{2} y^{2/3}$, $0 \leq y \leq 1 \Rightarrow \frac{dx}{dy} = y^{-1/3} \Rightarrow L = \int_0^1 \sqrt{1 + \left(y^{-1/3}\right)^2} dy = \int_0^1 \sqrt{1 + \frac{1}{y^{2/3}}} dy = \lim_{a \rightarrow 0^+} \int_a^1 \sqrt{\frac{y^{2/3} + 1}{y^{2/3}}} dy$
 $= \lim_{a \rightarrow 0^+} \frac{3}{2} \int_a^1 \left(y^{2/3} + 1\right)^{1/2} \left(\frac{2}{3} y^{-1/3}\right) dy = \lim_{a \rightarrow 0^+} \left[\frac{3}{2} \cdot \frac{2}{3} \left(y^{2/3} + 1\right)^{3/2} \right]_a^1 = \lim_{a \rightarrow 0^+} \left((2)^{3/2} - \left(a^{2/3} + 1\right)^{3/2} \right)$
 $= 2\sqrt{2} - 1$

43. $x = (1 + 2 \sin \theta) \cos \theta$, $y = (1 + 2 \sin \theta) \sin \theta \Rightarrow \frac{dx}{d\theta} = 2 \cos^2 \theta - \sin \theta(1 + 2 \sin \theta)$,

$$\frac{dy}{d\theta} = 2 \cos \theta \sin \theta + \cos \theta(1 + 2 \sin \theta) \Rightarrow \frac{dy}{dx} = \frac{2 \cos \theta \sin \theta + \cos \theta(1 + 2 \sin \theta)}{2 \cos^2 \theta - \sin \theta(1 + 2 \sin \theta)} = \frac{4 \cos \theta \sin \theta + \cos \theta}{2 \cos^2 \theta - 2 \sin^2 \theta - \sin \theta} = \frac{2 \sin 2\theta + \cos \theta}{2 \cos 2\theta - \sin \theta}$$

(a) $x = (1 + 2 \sin(0)) \cos(0) = 1$, $y = (1 + 2 \sin(0)) \sin(0) = 0$; $\left. \frac{dy}{dx} \right|_{\theta=0} = \frac{2 \sin(2(0)) + \cos(0)}{2 \cos(2(0)) - \sin(0)} = \frac{0 + 1}{2 - 0} = \frac{1}{2}$

(b) $x = \left(1 + 2 \sin\left(\frac{\pi}{2}\right)\right) \cos\left(\frac{\pi}{2}\right) = 0$, $y = \left(1 + 2 \sin\left(\frac{\pi}{2}\right)\right) \sin\left(\frac{\pi}{2}\right) = 3$; $\left. \frac{dy}{dx} \right|_{\theta=\pi/2} = \frac{2 \sin\left(2\left(\frac{\pi}{2}\right)\right) + \cos\left(\frac{\pi}{2}\right)}{2 \cos\left(2\left(\frac{\pi}{2}\right)\right) - \sin\left(\frac{\pi}{2}\right)} = \frac{0 + 0}{-2 - 1} = 0$

(c) $x = \left(1 + 2 \sin\left(\frac{4\pi}{3}\right)\right) \cos\left(\frac{4\pi}{3}\right) = \frac{\sqrt{3}-1}{2}$, $y = \left(1 + 2 \sin\left(\frac{4\pi}{3}\right)\right) \sin\left(\frac{4\pi}{3}\right) = \frac{3-\sqrt{3}}{2}$;

$$\left. \frac{dy}{dx} \right|_{\theta=4\pi/3} = \frac{2 \sin\left(2\left(\frac{4\pi}{3}\right)\right) + \cos\left(\frac{4\pi}{3}\right)}{2 \cos\left(2\left(\frac{4\pi}{3}\right)\right) - \sin\left(\frac{4\pi}{3}\right)} = \frac{\sqrt{3} - \frac{1}{2}}{-1 + \frac{\sqrt{3}}{2}} = \frac{2\sqrt{3}-1}{\sqrt{3}-2} = -(4 + 3\sqrt{3})$$

44. $x = t, y = 1 - \cos t, 0 \leq t \leq 2\pi \Rightarrow \frac{dx}{dt} = 1, \frac{dy}{dt} = \sin t \Rightarrow \frac{dy}{dx} = \frac{\sin t}{1} = \sin t \Rightarrow \frac{d}{dt}\left(\frac{dy}{dx}\right) = \cos t \Rightarrow \frac{d^2y}{dx^2} = \frac{\cos t}{1} = \cos t.$

The maximum and minimum slope will occur at points that maximize/minimize $\frac{dy}{dx}$, in other words, points

where $\frac{d^2y}{dx^2} = 0 \Rightarrow \cos t = 0 \Rightarrow t = \frac{\pi}{2}$ or $t = \frac{3\pi}{2} \Rightarrow \frac{d^2y}{dx^2} = \begin{matrix} +++ & | & --- & | & +++ \\ \pi/2 & & & & 3\pi/2 \end{matrix}$

(a) the maximum slope is $\left. \frac{dy}{dx} \right|_{t=\pi/2} = \sin\left(\frac{\pi}{2}\right) = 1$, which occurs at $x = \frac{\pi}{2}, y = 1 - \cos\left(\frac{\pi}{2}\right) = 1$

(b) the minimum slope is $\left. \frac{dy}{dx} \right|_{t=3\pi/2} = \sin\left(\frac{3\pi}{2}\right) = -1$, which occurs at $x = \frac{3\pi}{2}, y = 1 - \cos\left(\frac{3\pi}{2}\right) = 1$

45. $\frac{dx}{dt} = \cos t$ and $\frac{dy}{dt} = 2 \cos 2t \Rightarrow \frac{dy}{dx} = \frac{dy/dt}{dx/dt} = \frac{2 \cos 2t}{\cos t} = \frac{2(2 \cos^2 t - 1)}{\cos t}$; then $\frac{dy}{dx} = 0 \Rightarrow \frac{2(2 \cos^2 t - 1)}{\cos t} = 0$

$\Rightarrow 2 \cos^2 t - 1 = 0 \Rightarrow \cos t = \pm \frac{1}{\sqrt{2}} \Rightarrow t = \frac{\pi}{4}, \frac{3\pi}{4}, \frac{5\pi}{4}, \frac{7\pi}{4}$. In the 1st quadrant: $t = \frac{\pi}{4} \Rightarrow x = \sin \frac{\pi}{4} = \frac{\sqrt{2}}{2}$ and

$y = \sin 2\left(\frac{\pi}{4}\right) = 1 \Rightarrow \left(\frac{\sqrt{2}}{2}, 1\right)$ is the point where the tangent line is horizontal. At the origin: $x = 0$ and $y = 0$

$\Rightarrow \sin t = 0 \Rightarrow t = 0$ or $t = \pi$ and $\sin 2t = 0 \Rightarrow t = 0, \frac{\pi}{2}, \pi, \frac{3\pi}{2}$; thus $t = 0$ and $t = \pi$ give the tangent lines at the

origin. Tangents at origin: $\left. \frac{dy}{dx} \right|_{t=0} = 2 \Rightarrow y = 2x$ and $\left. \frac{dy}{dx} \right|_{t=\pi} = -2 \Rightarrow y = -2x$

46. $\frac{dx}{dt} = 2 \cos 2t$ and $\frac{dy}{dt} = 3 \cos 3t \Rightarrow \frac{dy}{dx} = \frac{dy/dt}{dx/dt} = \frac{3 \cos 3t}{2 \cos 2t} = \frac{3(\cos 2t \cos t - \sin 2t \sin t)}{2(2 \cos^2 t - 1)}$
 $= \frac{3[(2 \cos^2 t - 1)(\cos t) - 2 \sin t \cos t \sin t]}{2(2 \cos^2 t - 1)} = \frac{(3 \cos t)(2 \cos^2 t - 1 - 2 \sin^2 t)}{2(2 \cos^2 t - 1)} = \frac{(3 \cos t)(4 \cos^2 t - 3)}{2(2 \cos^2 t - 1)}$;

then $\frac{dy}{dx} = 0 \Rightarrow \frac{(3 \cos t)(4 \cos^2 t - 3)}{2(2 \cos^2 t - 1)} = 0 \Rightarrow 3 \cos t = 0$ or $4 \cos^2 t - 3 = 0 : 3 \cos t = 0 \Rightarrow t = \frac{\pi}{2}, \frac{3\pi}{2}$ and

$4 \cos^2 t - 3 = 0 \Rightarrow \cos t = \pm \frac{\sqrt{3}}{2} \Rightarrow t = \frac{\pi}{6}, \frac{5\pi}{6}, \frac{7\pi}{6}, \frac{11\pi}{6}$. In the 1st quadrant: $t = \frac{\pi}{6} \Rightarrow x = \sin 2\left(\frac{\pi}{6}\right) = \frac{\sqrt{3}}{2}$ and

$y = \sin 3\left(\frac{\pi}{6}\right) = 1 \Rightarrow \left(\frac{\sqrt{3}}{2}, 1\right)$ is the point where the graph has a horizontal tangent. At the origin: $x = 0$ and

$y = 0 \Rightarrow \sin 2t = 0$ and $\sin 3t = 0 \Rightarrow t = 0, \frac{\pi}{2}, \pi, \frac{3\pi}{2}$ and $t = 0, \frac{\pi}{3}, \frac{2\pi}{3}, \pi, \frac{4\pi}{3}, \frac{5\pi}{3} \Rightarrow t = 0$ and $t = \pi$ give the

tangent lines at the origin. Tangents at the origin: $\left. \frac{dy}{dx} \right|_{t=0} = \frac{3 \cos 0}{2 \cos 0} = \frac{3}{2} \Rightarrow y = \frac{3}{2}x$, and

$\left. \frac{dy}{dx} \right|_{t=\pi} = \frac{3 \cos(3\pi)}{2 \cos(2\pi)} = -\frac{3}{2} \Rightarrow y = -\frac{3}{2}x$

47. (a) $x = a(t - \sin t), y = a(1 - \cos t), 0 \leq t \leq 2\pi \Rightarrow \frac{dx}{dt} = a(1 - \cos t), \frac{dy}{dt} = a \sin t$

$\Rightarrow \text{Length} = \int_0^{2\pi} \sqrt{(a(1 - \cos t))^2 + (a \sin t)^2} dt = \int_0^{2\pi} \sqrt{a^2 - 2a^2 \cos t + a^2 \cos^2 t + a^2 \sin^2 t} dt$

$$= a\sqrt{2} \int_0^{2\pi} \sqrt{1 - \cos t} \, dt = a\sqrt{2} \int_0^{2\pi} \sqrt{2 \sin^2\left(\frac{t}{2}\right)} \, dt = 2a \int_0^{2\pi} \sin\left(\frac{t}{2}\right) \, dt = \left[-4a \cos\left(\frac{t}{2}\right)\right]_0^{2\pi}$$

$$= -4a \cos \pi + 4a \cos(0) = 8a$$

(b) $a = 1 \Rightarrow x = t - \sin t, y = 1 - \cos t, 0 \leq t \leq 2\pi \Rightarrow \frac{dx}{dt} = 1 - \cos t, \frac{dy}{dt} = \sin t$

$$\Rightarrow \text{Surface area} = \int_0^{2\pi} 2\pi(1 - \cos t) \sqrt{(1 - \cos t)^2 + (\sin t)^2} \, dt$$

$$= \int_0^{2\pi} 2\pi(1 - \cos t) \sqrt{1 - 2\cos t + \cos^2 t + \sin^2 t} \, dt = 2\pi \int_0^{2\pi} (1 - \cos t) \sqrt{2 - 2\cos t} \, dt$$

$$= 2\sqrt{2}\pi \int_0^{2\pi} (1 - \cos t)^{3/2} \, dt = 2\sqrt{2}\pi \int_0^{2\pi} \left(1 - \cos\left(2 \cdot \frac{t}{2}\right)\right)^{3/2} \, dt = 2\sqrt{2}\pi \int_0^{2\pi} \left(2 \sin^2\left(\frac{t}{2}\right)\right)^{3/2} \, dt$$

$$= 8\pi \int_0^{2\pi} \sin^3\left(\frac{t}{2}\right) \, dt \quad \left[u = \frac{t}{2} \Rightarrow du = \frac{1}{2} dt \Rightarrow dt = 2 du; t = 0 \Rightarrow u = 0, t = 2\pi \Rightarrow u = \pi\right]$$

$$= 16\pi \int_0^{\pi} \sin^3 u \, du = 16\pi \int_0^{\pi} \sin^2 u \sin u \, du = 16\pi \int_0^{\pi} (1 - \cos^2 u) \sin u \, du$$

$$= 16\pi \int_0^{\pi} \sin u \, du - 16\pi \int_0^{\pi} \cos^2 u \sin u \, du = \left[-16\pi \cos u + \frac{16\pi}{3} \cos^3 u\right]_0^{\pi}$$

$$= \left(16\pi - \frac{16\pi}{3}\right) - \left(-16\pi + \frac{16\pi}{3}\right) = \frac{64\pi}{3}$$

48. $x = t - \sin t, y = 1 - \cos t, 0 \leq t \leq 2\pi$; Volume $= \int_0^{2\pi} \pi y^2 dx = \int_0^{2\pi} \pi(1 - \cos t)^2 (1 - \cos t) dt$

$$= \pi \int_0^{2\pi} (1 - 3\cos t + 3\cos^2 t - \cos^3 t) dt = \pi \int_0^{2\pi} \left(1 - 3\cos t + 3\left(\frac{1 + \cos 2t}{2}\right) - \cos^2 t \cos t\right) dt$$

$$= \pi \int_0^{2\pi} \left(\frac{5}{2} - 3\cos t + \frac{3}{2}\cos 2t - (1 - \sin^2 t)\cos t\right) dt = \pi \int_0^{2\pi} \left(\frac{5}{2} - 4\cos t + \frac{3}{2}\cos 2t + \sin^2 t \cos t\right) dt$$

$$= \pi \left[\frac{5}{2}t - 4\sin t + \frac{3}{4}\sin 2t + \frac{1}{3}\sin^3 t\right]_0^{2\pi} = \pi(5\pi - 0 + 0 + 0) - 0 = 5\pi^2$$

49-52. Example CAS commands:

Maple:

with(plots);

with(student);

x := t -> t^3/3;

y := t -> t^2/2;

a := 0;

b := 1;

N := [2, 4, 8];

for n in N do

tt := [seq(a+i*(b-a)/n, i=0..n)];

pts := [seq([x(t),y(t)],t=tt)];

L := simplify(add(student[distance](pts[i+1],pts[i], i=1..n)); # (b)

T := sprintf("#49(a) (Section 11.2)\nn=%3d L=%8.5f\n", n, L);

P[n] := plot([x(t),y(t),t=a..b],pts, title=T); # (a)

end do;

- (h) $x = 2\sqrt{3} \cos \frac{2\pi}{3} = -\sqrt{3}$, $y = 2\sqrt{3} \sin \frac{2\pi}{3} = 3 \Rightarrow$ Cartesian coordinates are $(-\sqrt{3}, 3)$
7. (a) $(1, 1) \Rightarrow r = \sqrt{1^2 + 1^2} = \sqrt{2}$, $\sin \theta = \frac{1}{\sqrt{2}}$ and $\cos \theta = \frac{1}{\sqrt{2}} \Rightarrow \theta = \frac{\pi}{4} \Rightarrow$ Polar coordinates are $(\sqrt{2}, \frac{\pi}{4})$
- (b) $(-3, 0) \Rightarrow r = \sqrt{(-3)^2 + 0^2} = 3$, $\sin \theta = 0$ and $\cos \theta = -1 \Rightarrow \theta = \pi \Rightarrow$ Polar coordinates are $(3, \pi)$
- (c) $(\sqrt{3}, -1) \Rightarrow r = \sqrt{(\sqrt{3})^2 + (-1)^2} = 2$, $\sin \theta = -\frac{1}{2}$ and $\cos \theta = \frac{\sqrt{3}}{2} \Rightarrow \theta = \frac{11\pi}{6} \Rightarrow$ Polar coordinates are $(2, \frac{11\pi}{6})$
- (d) $(-3, 4) \Rightarrow r = \sqrt{(-3)^2 + 4^2} = 5$, $\sin \theta = \frac{4}{5}$ and $\cos \theta = -\frac{3}{5} \Rightarrow \theta = \pi - \arctan\left(\frac{4}{3}\right) \Rightarrow$ Polar coordinates are $(5, \pi - \arctan\left(\frac{4}{3}\right))$
8. (a) $(-2, -2) \Rightarrow r = \sqrt{(-2)^2 + (-2)^2} = 2\sqrt{2}$, $\sin \theta = -\frac{1}{\sqrt{2}}$ and $\cos \theta = -\frac{1}{\sqrt{2}} \Rightarrow \theta = -\frac{3\pi}{4} \Rightarrow$ Polar coordinates are $(2\sqrt{2}, -\frac{3\pi}{4})$
- (b) $(0, 3) \Rightarrow r = \sqrt{0^2 + 3^2} = 3$, $\sin \theta = 1$ and $\cos \theta = 0 \Rightarrow \theta = \frac{\pi}{2} \Rightarrow$ Polar coordinates are $(3, \frac{\pi}{2})$
- (c) $(-\sqrt{3}, 1) \Rightarrow r = \sqrt{(-\sqrt{3})^2 + 1^2} = 2$, $\sin \theta = \frac{1}{2}$ and $\cos \theta = -\frac{\sqrt{3}}{2} \Rightarrow \theta = \frac{5\pi}{6} \Rightarrow$ Polar coordinates are $(2, \frac{5\pi}{6})$
- (d) $(5, -12) \Rightarrow r = \sqrt{5^2 + (-12)^2} = 13$, $\sin \theta = -\frac{12}{13}$ and $\cos \theta = \frac{5}{13} \Rightarrow \theta = -\arctan\left(\frac{12}{5}\right) \Rightarrow$ Polar coordinates are $(13, -\arctan\left(\frac{12}{5}\right))$
9. (a) $(3, 3) \Rightarrow r = -\sqrt{3^2 + 3^2} = -3\sqrt{2}$, $\sin \theta = -\frac{1}{\sqrt{2}}$ and $\cos \theta = -\frac{1}{\sqrt{2}} \Rightarrow \theta = \frac{5\pi}{4} \Rightarrow$ Polar coordinates are $(-3\sqrt{2}, \frac{5\pi}{4})$
- (b) $(-1, 0) \Rightarrow r = -\sqrt{(-1)^2 + 0^2} = -1$, $\sin \theta = 0$ and $\cos \theta = 1 \Rightarrow \theta = 0 \Rightarrow$ Polar coordinates are $(-1, 0)$
- (c) $(-1, \sqrt{3}) \Rightarrow r = -\sqrt{(-1)^2 + (\sqrt{3})^2} = -2$, $\sin \theta = \frac{\sqrt{3}}{2}$ and $\cos \theta = -\frac{1}{2} \Rightarrow \theta = \frac{2\pi}{3} \Rightarrow$ Polar coordinates are $(-2, \frac{2\pi}{3})$
- (d) $(4, -3) \Rightarrow r = -\sqrt{4^2 + (-3)^2} = -5$, $\sin \theta = -\frac{3}{5}$ and $\cos \theta = \frac{4}{5} \Rightarrow \theta = \pi - \arctan\left(\frac{3}{4}\right) \Rightarrow$ Polar coordinates are $(-5, \pi - \arctan\left(\frac{3}{4}\right))$
10. (a) $(-2, 0) \Rightarrow r = -\sqrt{(-2)^2 + 0^2} = -2$, $\sin \theta = 0$ and $\cos \theta = 1 \Rightarrow \theta = 0 \Rightarrow$ Polar coordinates are $(-2, 0)$
- (b) $(1, 0) \Rightarrow r = -\sqrt{1^2 + 0^2} = -1$, $\sin \theta = 0$ and $\cos \theta = -1 \Rightarrow \theta = \pi$ or $\theta = -\pi \Rightarrow$ Polar coordinates are $(-1, \pi)$ or $(-1, -\pi)$
- (c) $(0, -3) \Rightarrow r = -\sqrt{0^2 + (-3)^2} = -3$, $\sin \theta = 1$ and $\cos \theta = 0 \Rightarrow \theta = \frac{\pi}{2} \Rightarrow$ Polar coordinates are $(-3, \frac{\pi}{2})$

(d) $\left(\frac{\sqrt{3}}{2}, \frac{1}{2}\right) \Rightarrow r = -\sqrt{\left(\frac{\sqrt{3}}{2}\right)^2 + \left(\frac{1}{2}\right)^2} = -1, \sin \theta = -\frac{1}{2}$ and $\cos \theta = -\frac{\sqrt{3}}{2} \Rightarrow \theta = \frac{7\pi}{6}$ or $\theta = -\frac{5\pi}{6} \Rightarrow$ Polar coordinates are $\left(-1, \frac{7\pi}{6}\right)$ or $\left(-1, -\frac{5\pi}{6}\right)$

11.

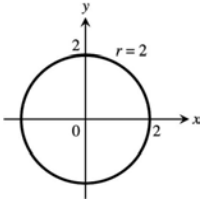

12.

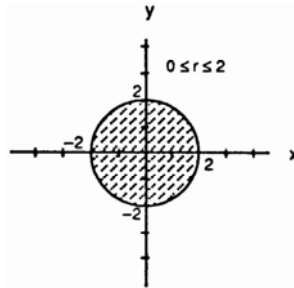

13.

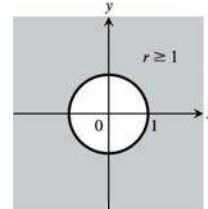

14.

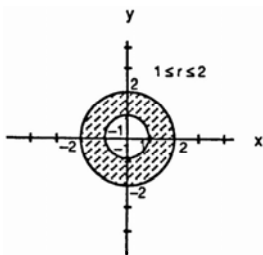

15.

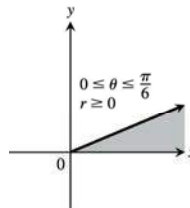

16.

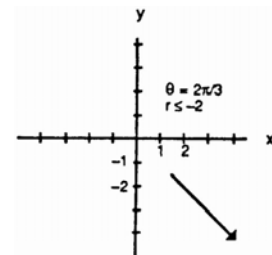

17.

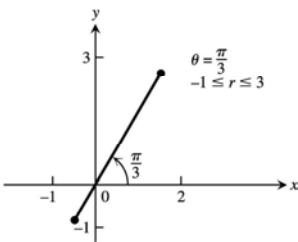

18.

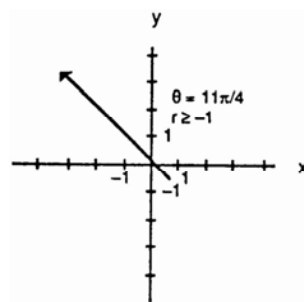

19.

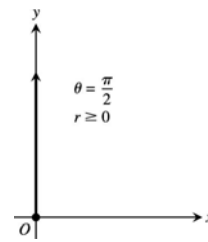

20.

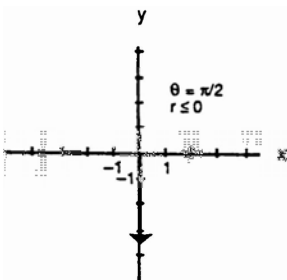

21.

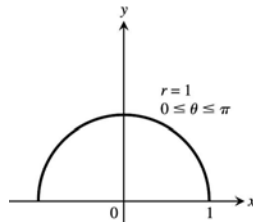

22.

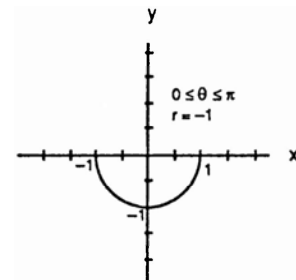

23.

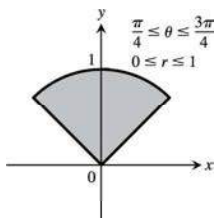

24.

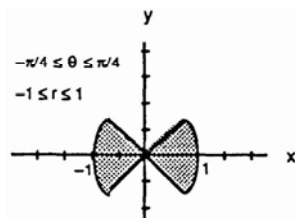

25.

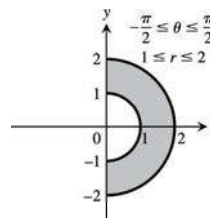

26.

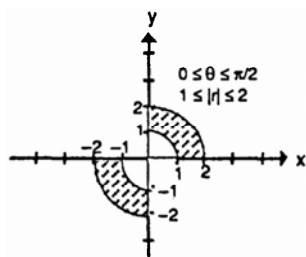

27. $r \cos \theta = 2 \Rightarrow x = 2$, vertical line through $(2, 0)$ 28. $r \sin \theta = -1 \Rightarrow y = -1$, horizontal line through $(0, -1)$

29. $r \sin \theta = 0 \Rightarrow y = 0$, the x -axis 30. $r \cos \theta = 0 \Rightarrow x = 0$, the y -axis

31. $r = 4 \csc \theta \Rightarrow r = \frac{4}{\sin \theta} \Rightarrow r \sin \theta = 4 \Rightarrow y = 4$, a horizontal line through $(0, 4)$

32. $r = -3 \sec \theta \Rightarrow r = \frac{-3}{\cos \theta} \Rightarrow r \cos \theta = -3 \Rightarrow x = -3$, a vertical line through $(-3, 0)$

33. $r \cos \theta + r \sin \theta = 1 \Rightarrow x + y = 1$, line with slope $m = -1$ and intercept $b = 1$

34. $r \sin \theta = r \cos \theta \Rightarrow y = x$, line with slope $m = 1$ and intercept $b = 0$

35. $r^2 = 1 \Rightarrow x^2 + y^2 = 1$, circle with center $C = (0, 0)$ and radius 1

36. $r^2 = 4r \sin \theta \Rightarrow x^2 + y^2 = 4y \Rightarrow x^2 + y^2 - 4y + 4 = 4 \Rightarrow x^2 + (y - 2)^2 = 4$, circle with center $C = (0, 2)$ and radius 2

37. $r = \frac{5}{\sin \theta - 2 \cos \theta} \Rightarrow r \sin \theta - 2r \cos \theta = 5 \Rightarrow y - 2x = 5$, line with slope $m = 2$ and intercept $b = 5$

38. $r^2 \sin 2\theta = 2 \Rightarrow 2r^2 \sin \theta \cos \theta = 2 \Rightarrow (r \sin \theta)(r \cos \theta) = 1 \Rightarrow xy = 1$, hyperbola with focal axis $y = x$

39. $r = \cot \theta \csc \theta = \left(\frac{\cos \theta}{\sin \theta}\right)\left(\frac{1}{\sin \theta}\right) \Rightarrow r \sin^2 \theta = \cos \theta \Rightarrow r^2 \sin^2 \theta = r \cos \theta \Rightarrow y^2 = x$, parabola with vertex $(0, 0)$ which opens to the right
40. $r = 4 \tan \theta \sec \theta \Rightarrow r = 4\left(\frac{\sin \theta}{\cos^2 \theta}\right) \Rightarrow r \cos^2 \theta = 4 \sin \theta \Rightarrow r^2 \cos^2 \theta = 4r \sin \theta \Rightarrow x^2 = 4y$, parabola with vertex $(0, 0)$ which opens upward
41. $r = (\csc \theta)e^{r \cos \theta} \Rightarrow r \sin \theta = e^{r \cos \theta} \Rightarrow y = e^x$, graph of the natural exponential function
42. $r \sin \theta = \ln r + \ln \cos \theta = \ln(r \cos \theta) \Rightarrow y = \ln x$, graph of the natural logarithmic function
43. $r^2 + 2r^2 \cos \theta \sin \theta = 1 \Rightarrow x^2 + y^2 + 2xy = 1 \Rightarrow x^2 + 2xy + y^2 = 1 \Rightarrow (x + y)^2 = 1 \Rightarrow x + y = \pm 1$, two parallel straight lines of slope -1 and y -intercepts $b = \pm 1$
44. $\cos^2 \theta = \sin^2 \theta \Rightarrow r^2 \cos^2 \theta = r^2 \sin^2 \theta \Rightarrow x^2 = y^2 \Rightarrow |x| = |y| \Rightarrow \pm x = y$, two perpendicular lines through the origin with slopes 1 and -1 , respectively.
45. $r^2 = -4r \cos \theta \Rightarrow x^2 + y^2 = -4x \Rightarrow x^2 + 4x + y^2 = 0 \Rightarrow x^2 + 4x + 4 + y^2 = 4 \Rightarrow (x + 2)^2 + y^2 = 4$, a circle with center $C(-2, 0)$ and radius 2
46. $r^2 = -6r \sin \theta \Rightarrow x^2 + y^2 = -6y \Rightarrow x^2 + y^2 + 6y = 0 \Rightarrow x^2 + y^2 + 6y + 9 = 9 \Rightarrow x^2 + (y + 3)^2 = 9$, a circle with center $C(0, -3)$ and radius 3
47. $r = 8 \sin \theta \Rightarrow r^2 = 8r \sin \theta \Rightarrow x^2 + y^2 = 8y \Rightarrow x^2 + y^2 - 8y = 0 \Rightarrow x^2 + y^2 - 8y + 16 = 16 \Rightarrow x^2 + (y - 4)^2 = 16$, a circle with center $C(0, 4)$ and radius 4
48. $r = 3 \cos \theta \Rightarrow r^2 = 3r \cos \theta \Rightarrow x^2 + y^2 = 3x \Rightarrow x^2 + y^2 - 3x = 0 \Rightarrow x^2 - 3x + \frac{9}{4} + y^2 = \frac{9}{4} \Rightarrow \left(x - \frac{3}{2}\right)^2 + y^2 = \frac{9}{4}$, a circle with center $C\left(\frac{3}{2}, 0\right)$ and radius $\frac{3}{2}$
49. $r = 2 \cos \theta + 2 \sin \theta \Rightarrow r^2 = 2r \cos \theta + 2r \sin \theta \Rightarrow x^2 + y^2 = 2x + 2y \Rightarrow x^2 - 2x + y^2 - 2y = 0 \Rightarrow (x - 1)^2 + (y - 1)^2 = 2$, a circle with center $C(1, 1)$ and radius $\sqrt{2}$
50. $r = 2 \cos \theta - \sin \theta \Rightarrow r^2 = 2r \cos \theta - r \sin \theta \Rightarrow x^2 + y^2 = 2x - y \Rightarrow x^2 - 2x + y^2 + y = 0 \Rightarrow (x - 1)^2 + \left(y + \frac{1}{2}\right)^2 = \frac{5}{4}$, a circle with center $C\left(1, -\frac{1}{2}\right)$ and radius $\frac{\sqrt{5}}{2}$
51. $r \sin\left(\theta + \frac{\pi}{6}\right) = 2 \Rightarrow r\left(\sin \theta \cos \frac{\pi}{6} + \cos \theta \sin \frac{\pi}{6}\right) = 2 \Rightarrow \frac{\sqrt{3}}{2}r \sin \theta + \frac{1}{2}r \cos \theta = 2 \Rightarrow \frac{\sqrt{3}}{2}y + \frac{1}{2}x = 2 \Rightarrow \sqrt{3}y + x = 4$, line with slope $m = -\frac{1}{\sqrt{3}}$ and intercept $b = \frac{4}{\sqrt{3}}$

11.4 GRAPHING POLAR COORDINATE EQUATIONS

1. $1 + \cos(-\theta) = 1 + \cos \theta = r \Rightarrow$ symmetric about the x -axis;
 $1 + \cos(-\theta) \neq -r$ and $1 + \cos(\pi - \theta) = 1 - \cos \theta \neq r \Rightarrow$ not symmetric
 about the y -axis; therefore not symmetric about the origin

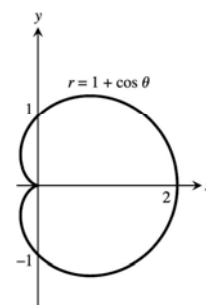

2. $2 - 2\cos(-\theta) = 2 - 2\cos \theta = r \Rightarrow$ symmetric about the x -axis;
 $2 - 2\cos(-\theta) \neq -r$ and $2 - 2\cos(\pi - \theta) = 2 + 2\cos \theta \neq r$
 \Rightarrow not symmetric about the y -axis; therefore not symmetric
 about the origin

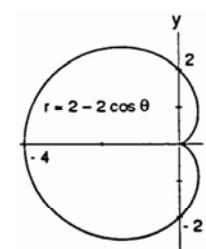

3. $1 - \sin(-\theta) = 1 + \sin \theta \neq r$ and $1 - \sin(\pi - \theta) = 1 - \sin \theta \neq -r$
 \Rightarrow not symmetric about the x -axis; $1 - \sin(\pi - \theta) = 1 - \sin \theta = r$
 \Rightarrow symmetric about the y -axis; therefore not symmetric
 about the origin

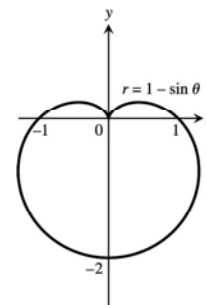

4. $1 + \sin(-\theta) = 1 - \sin \theta \neq r$ and $1 + \sin(\pi - \theta) = 1 + \sin \theta \neq -r$
 \Rightarrow not symmetric about the x -axis; $1 + \sin(\pi - \theta) = 1 + \sin \theta = r$
 \Rightarrow symmetric about the y -axis; therefore not symmetric about the origin

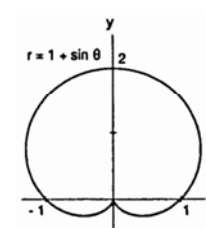

5. $2 + \sin(-\theta) = 2 - \sin \theta \neq r$ and $2 + \sin(\pi - \theta) = 2 + \sin \theta \neq -r \Rightarrow$ not
 symmetric about the x -axis; $2 + \sin(\pi - \theta) = 2 + \sin \theta = r \Rightarrow$ symmetric
 about the y -axis; therefore not symmetric about the origin

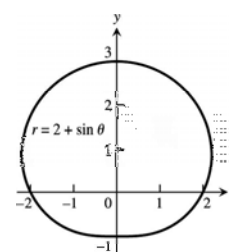

6. $1 + 2\sin(-\theta) = 1 - 2\sin\theta \neq r$ and $1 + 2\sin(\pi - \theta) = 1 + 2\sin\theta \neq -r \Rightarrow$ not symmetric about the x -axis; $1 + 2\sin(\pi - \theta) = 1 + 2\sin\theta = r \Rightarrow$ symmetric about the y -axis; therefore not symmetric about the origin

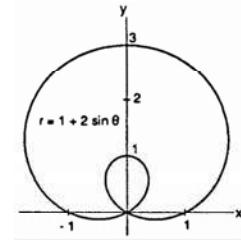

7. $\sin\left(-\frac{\theta}{2}\right) = -\sin\left(\frac{\theta}{2}\right) = -r \Rightarrow$ symmetric about the y -axis;
 $\sin\left(\frac{2\pi - \theta}{2}\right) = \sin\left(\frac{\theta}{2}\right)$, so the graph is symmetric about the x -axis, and hence the origin.

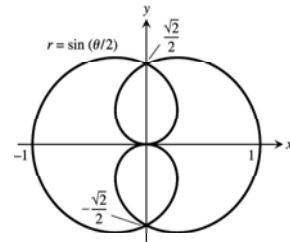

8. $\cos\left(-\frac{\theta}{2}\right) = \cos\left(\frac{\theta}{2}\right) = r \Rightarrow$ symmetric about the x -axis;
 $\cos\left(\frac{2\pi - \theta}{2}\right) = \cos\left(\frac{\theta}{2}\right)$, so the graph is symmetric about the y -axis, and hence the origin.

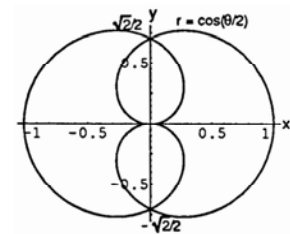

9. $\cos(-\theta) = \cos\theta = r^2 \Rightarrow (r, -\theta)$ and $(-r, -\theta)$ are on the graph when (r, θ) is on the graph \Rightarrow symmetric about the x -axis and y -axis; therefore symmetric about the origin

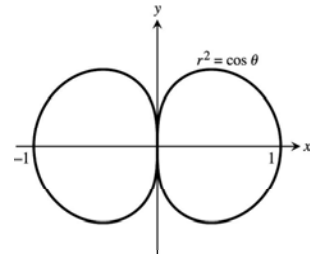

10. $\sin(\pi - \theta) = \sin\theta = r^2 \Rightarrow (r, \pi - \theta)$ and $(-r, \pi - \theta)$ are on the graph when (r, θ) is on the graph \Rightarrow symmetric about the y -axis and the x -axis; therefore symmetric about the origin

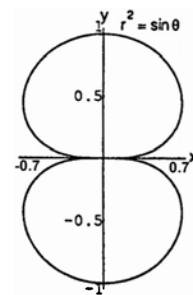

11. $-\sin(\pi - \theta) = -\sin\theta = r^2 \Rightarrow (r, \pi - \theta)$ and $(-r, \pi - \theta)$ are on the graph when (r, θ) is on the graph \Rightarrow symmetric about the y -axis and the x -axis; therefore symmetric about the origin

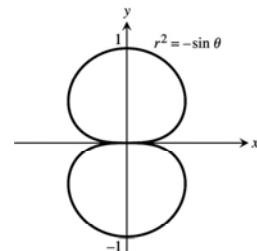

12. $-\cos(-\theta) = -\cos \theta = r^2 \Rightarrow (r, -\theta)$ and $(-r, -\theta)$ are on the graph when (r, θ) is on the graph \Rightarrow symmetric about the x -axis and the y -axis; therefore symmetric about the origin

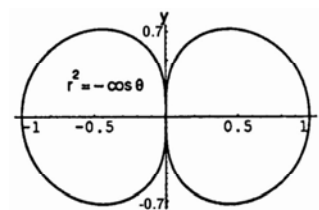

13. Since $(\pm r, -\theta)$ are on the graph when (r, θ) is on the graph, $(\pm r)^2 = 4 \cos 2(-\theta) \Rightarrow r^2 = 4 \cos 2\theta$, the graph is symmetric about the x -axis and the y -axis \Rightarrow the graph is symmetric about the origin

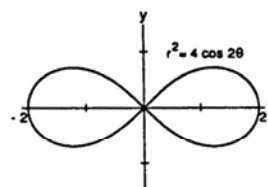

14. Since (r, θ) on the graph $\Rightarrow (-r, \theta)$ is on the graph, $(\pm r)^2 = 4 \sin 2\theta \Rightarrow r^2 = 4 \sin 2\theta$, the graph is symmetric about the origin. But $4 \sin 2(-\theta) = -4 \sin 2\theta \neq r^2$ and $4 \sin 2(\pi - \theta) = 4 \sin (2\pi - 2\theta) = 4 \sin (-2\theta) = -4 \sin 2\theta \neq r^2 \Rightarrow$ the graph is not symmetric about the x -axis; therefore the graph is not symmetric about the y -axis

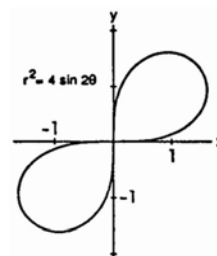

15. Since (r, θ) on the graph $\Rightarrow (-r, \theta)$ is on the graph, $(\pm r)^2 = -\sin 2\theta \Rightarrow r^2 = -\sin 2\theta$, the graph is symmetric about the origin. But $-\sin 2(-\theta) = -(-\sin 2\theta) = \sin 2\theta \neq r^2$ and $-\sin 2(\pi - \theta) = -\sin(2\pi - 2\theta) = -\sin(-2\theta) = -(-\sin 2\theta) = \sin 2\theta \neq r^2 \Rightarrow$ the graph is not symmetric about the x -axis; therefore the graph is not symmetric about the y -axis

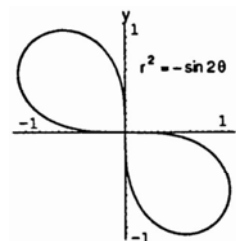

16. Since $(\pm r, -\theta)$ are on the graph when (r, θ) is on the graph, $(\pm r)^2 = -\cos 2(-\theta) \Rightarrow r^2 = -\cos 2\theta$, the graph is symmetric about the x -axis and the y -axis \Rightarrow the graph is symmetric about the origin.

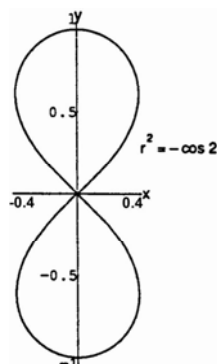

17. $\theta = \frac{\pi}{2} \Rightarrow r = -1 \Rightarrow (-1, \frac{\pi}{2})$, and $\theta = -\frac{\pi}{2} \Rightarrow r = -1 \Rightarrow (-1, -\frac{\pi}{2})$;

$$r' = \frac{dr}{d\theta} = -\sin \theta; \text{ Slope} = \frac{r' \sin \theta + r \cos \theta}{r' \cos \theta - r \sin \theta} = \frac{-\sin^2 \theta + r \cos \theta}{-\sin \theta \cos \theta - r \sin \theta}$$

$$\Rightarrow \text{Slope at } (-1, \frac{\pi}{2}) \text{ is } \frac{-\sin^2(\frac{\pi}{2}) + (-1)\cos\frac{\pi}{2}}{-\sin\frac{\pi}{2}\cos\frac{\pi}{2} - (-1)\sin\frac{\pi}{2}} = -1;$$

$$\text{Slope at } (-1, -\frac{\pi}{2}) \text{ is } \frac{-\sin^2(-\frac{\pi}{2}) + (-1)\cos(-\frac{\pi}{2})}{-\sin(-\frac{\pi}{2})\cos(-\frac{\pi}{2}) - (-1)\sin(-\frac{\pi}{2})} = 1$$

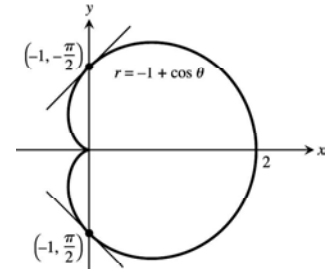

18. $\theta = 0 \Rightarrow r = -1 \Rightarrow (-1, 0)$, and $\theta = \pi \Rightarrow r = -1 \Rightarrow (-1, \pi)$;

$$r' = \frac{dr}{d\theta} = \cos \theta; \text{ Slope} = \frac{r' \sin \theta + r \cos \theta}{r' \cos \theta - r \sin \theta} = \frac{\cos \theta \sin \theta + r \cos \theta}{\cos^2 \theta \cos \theta - r \sin \theta} = \frac{\cos \theta \sin \theta + r \cos \theta}{\cos^2 \theta - r \sin \theta}$$

$$\Rightarrow \text{Slope at } (-1, 0) \text{ is } \frac{\cos 0 \sin 0 + (-1)\cos 0}{\cos^2 0 - (-1)\sin 0} = -1;$$

$$\text{Slope at } (-1, \pi) \text{ is } \frac{\cos \pi \sin \pi + (-1)\cos \pi}{\cos^2 \pi - (-1)\sin \pi} = 1$$

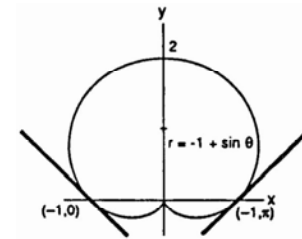

19. $\theta = \frac{\pi}{4} \Rightarrow r = 1 \Rightarrow (1, \frac{\pi}{4})$; $\theta = -\frac{\pi}{4} \Rightarrow r = -1 \Rightarrow (-1, -\frac{\pi}{4})$;

$$\theta = \frac{3\pi}{4} \Rightarrow r = -1 \Rightarrow (-1, \frac{3\pi}{4})$$
; $\theta = -\frac{3\pi}{4} \Rightarrow r = 1 \Rightarrow (1, -\frac{3\pi}{4})$;

$$r' = \frac{dr}{d\theta} = 2 \cos 2\theta; \text{ Slope} = \frac{r' \sin \theta + r \cos \theta}{r' \cos \theta - r \sin \theta} = \frac{2 \cos 2\theta \sin \theta + r \cos \theta}{2 \cos 2\theta \cos \theta - r \sin \theta}$$

$$\Rightarrow \text{Slope at } (1, \frac{\pi}{4}) \text{ is } \frac{2 \cos(\frac{\pi}{2}) \sin(\frac{\pi}{4}) + (1)\cos(\frac{\pi}{4})}{2 \cos(\frac{\pi}{2}) \cos(\frac{\pi}{4}) - (1)\sin(\frac{\pi}{4})} = -1;$$

$$\text{Slope at } (-1, -\frac{\pi}{4}) \text{ is } \frac{2 \cos(-\frac{\pi}{2}) \sin(-\frac{\pi}{4}) + (-1)\cos(-\frac{\pi}{4})}{2 \cos(-\frac{\pi}{2}) \cos(-\frac{\pi}{4}) - (-1)\sin(-\frac{\pi}{4})} = 1;$$

$$\text{Slope at } (-1, \frac{3\pi}{4}) \text{ is } \frac{2 \cos(\frac{3\pi}{2}) \sin(\frac{3\pi}{4}) + (-1)\cos(\frac{3\pi}{4})}{2 \cos(\frac{3\pi}{2}) \cos(\frac{3\pi}{4}) - (-1)\sin(\frac{3\pi}{4})} = 1;$$

$$\text{Slope at } (1, -\frac{3\pi}{4}) \text{ is } \frac{2 \cos(-\frac{3\pi}{2}) \sin(-\frac{3\pi}{4}) + (1)\cos(-\frac{3\pi}{4})}{2 \cos(-\frac{3\pi}{2}) \cos(-\frac{3\pi}{4}) - (1)\sin(-\frac{3\pi}{4})} = -1;$$

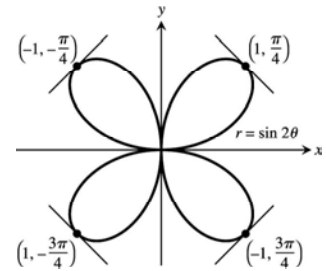

20. $\theta = 0 \Rightarrow r = 1 \Rightarrow (1, 0)$; $\theta = \frac{\pi}{2} \Rightarrow r = -1 \Rightarrow (-1, \frac{\pi}{2})$;

$$\theta = -\frac{\pi}{2} \Rightarrow r = -1 \Rightarrow (-1, -\frac{\pi}{2})$$
; $\theta = \pi \Rightarrow r = 1 \Rightarrow (1, \pi)$;

$$r' = \frac{dr}{d\theta} = -2 \sin 2\theta; \text{ Slope} = \frac{r' \sin \theta + r \cos \theta}{r' \cos \theta - r \sin \theta} = \frac{-2 \sin 2\theta \sin \theta + r \cos \theta}{-2 \sin 2\theta \cos \theta - r \sin \theta}$$

$$\Rightarrow \text{Slope at } (1, 0) \text{ is } \frac{-2 \sin 0 \sin 0 + \cos 0}{-2 \sin 0 \cos 0 - \sin 0}, \text{ which is undefined;}$$

$$\text{Slope at } (-1, \frac{\pi}{2}) \text{ is } \frac{-2 \sin 2(\frac{\pi}{2}) \sin(\frac{\pi}{2}) + (-1)\cos(\frac{\pi}{2})}{-2 \sin 2(\frac{\pi}{2}) \cos(\frac{\pi}{2}) - (-1)\sin(\frac{\pi}{2})} = 0;$$

$$\text{Slope at } (-1, -\frac{\pi}{2}) \text{ is } \frac{-2 \sin 2(-\frac{\pi}{2}) \sin(-\frac{\pi}{2}) + (-1)\cos(-\frac{\pi}{2})}{-2 \sin 2(-\frac{\pi}{2}) \cos(-\frac{\pi}{2}) - (-1)\sin(-\frac{\pi}{2})} = 0;$$

$$\text{Slope at } (1, \pi) \text{ is } \frac{-2 \sin 2\pi \sin \pi + \cos \pi}{-2 \sin 2\pi \cos \pi - \sin \pi}, \text{ which is undefined}$$

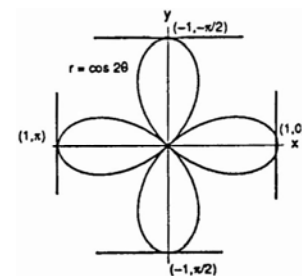

21. (a)

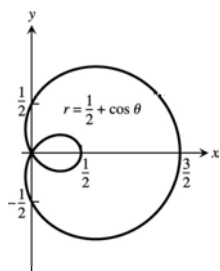

(b)

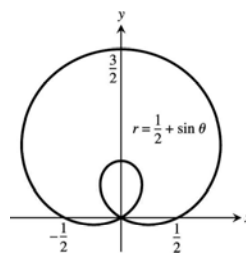

22. (a)

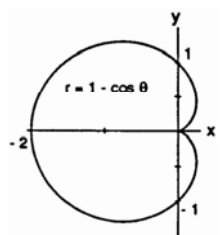

(b)

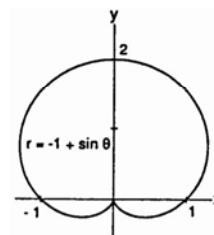

23. (a)

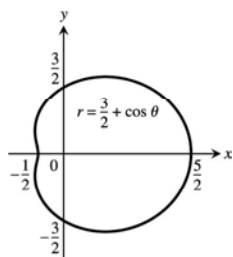

(b)

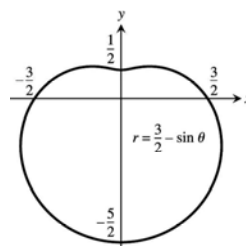

24. (a)

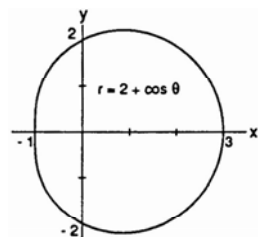

(b)

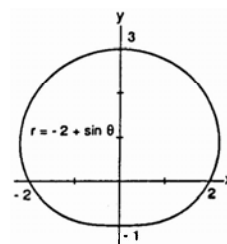

25.

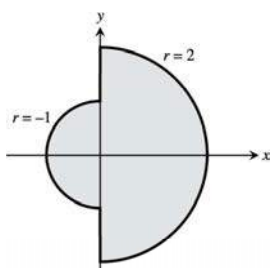

26. $r = 2 \sec \theta \Rightarrow r = \frac{2}{\cos \theta} \Rightarrow r \cos \theta = 2 \Rightarrow x = 2$

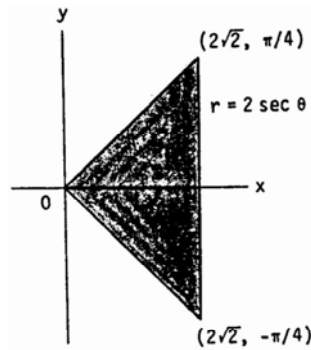

27.

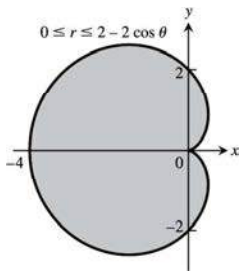

28.

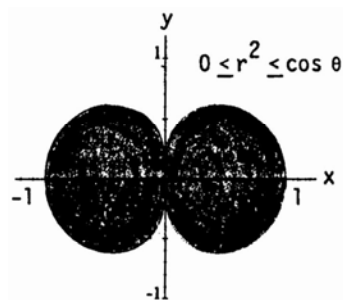

29. Note that (r, θ) and $(-r, \theta + \pi)$ describe the same point in the plane. Then $r = 1 - \cos \theta \Leftrightarrow -1 - \cos(\theta + \pi) = -1 - (\cos \theta \cos \pi - \sin \theta \sin \pi) = -1 + \cos \theta = -(1 - \cos \theta) = -r$; therefore (r, θ) is on the graph of $r = 1 - \cos \theta \Leftrightarrow (-r, \theta + \pi)$ is on the graph of $r = -1 - \cos \theta \Rightarrow$ the answer is (a).

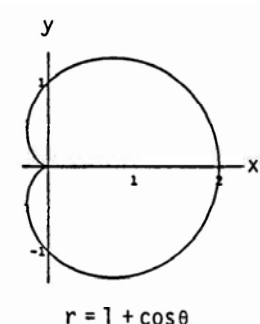
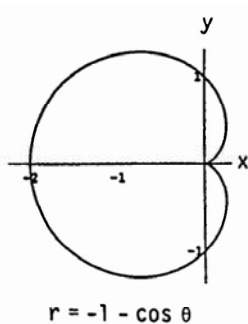
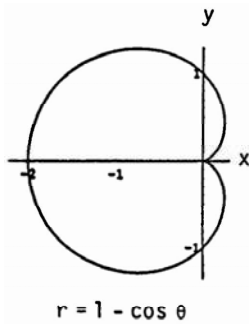

30. Note that (r, θ) and $(-r, \theta + \pi)$ describe the same point in the plane. Then $r = \cos 2\theta \Leftrightarrow -\sin\left(2(\theta + \pi) + \frac{\pi}{2}\right) = -\sin\left(2\theta + \frac{5\pi}{2}\right) = -\sin(2\theta) \cos\left(\frac{5\pi}{2}\right) - \cos(2\theta) \sin\left(\frac{5\pi}{2}\right) = -\cos 2\theta = -r$; therefore (r, θ) is on the graph of $r = -\sin\left(2\theta + \frac{\pi}{2}\right) \Rightarrow$ the answer is (a).

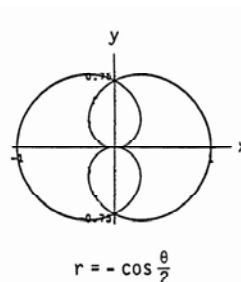
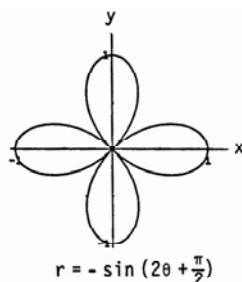
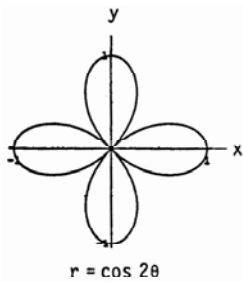

31.

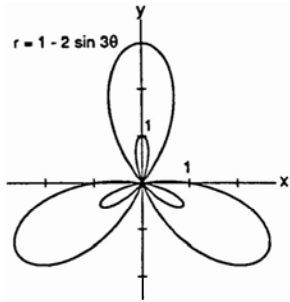

32.

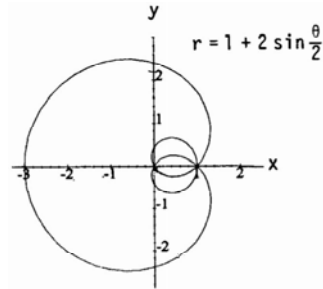

33. (a)

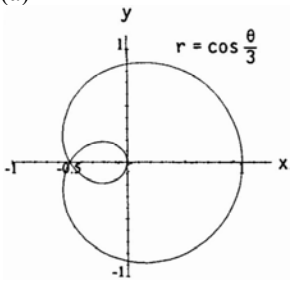

(b)

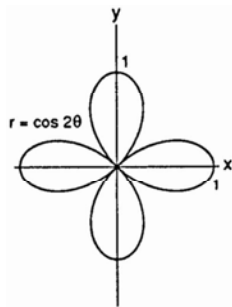

(c)

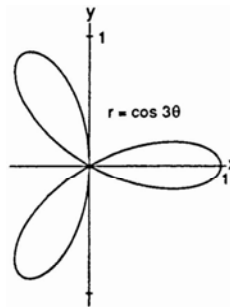

(d)

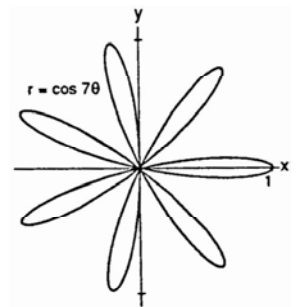

34. (a)

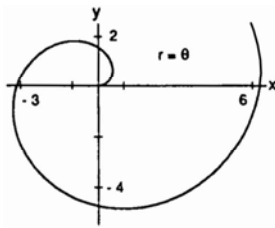

(b)

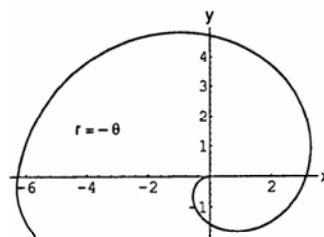

(c)

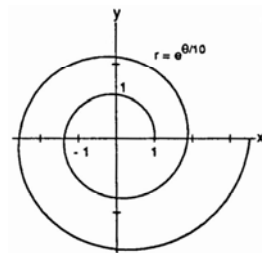

(d)

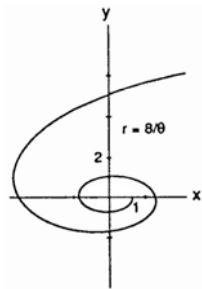

(e)

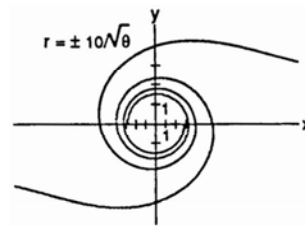

35.

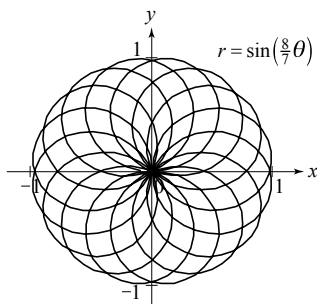

36.

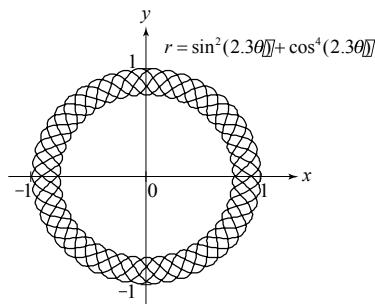

11.5 AREAS AND LENGTHS IN POLAR COORDINATES

- $$A = \int_0^{\pi} \frac{1}{2} \theta^2 d\theta = \left[\frac{1}{6} \theta^3 \right]_0^{\pi} = \frac{\pi^3}{6}$$
- $$A = \int_{\pi/4}^{\pi/2} \frac{1}{2} (2 \sin \theta)^2 d\theta = 2 \int_{\pi/4}^{\pi/2} \sin^2 \theta d\theta = 2 \int_{\pi/4}^{\pi/2} \frac{1 - \cos 2\theta}{2} d\theta = \int_{\pi/4}^{\pi/2} (1 - \cos 2\theta) d\theta = \left[\theta - \frac{1}{2} \sin 2\theta \right]_{\pi/4}^{\pi/2}$$

$$= \left(\frac{\pi}{2} - 0 \right) - \left(\frac{\pi}{4} - \frac{1}{2} \right) = \frac{\pi}{4} + \frac{1}{2}$$
- $$A = \int_0^{2\pi} \frac{1}{2} (4 + 2 \cos \theta)^2 d\theta = \int_0^{2\pi} \frac{1}{2} (16 + 16 \cos \theta + 4 \cos^2 \theta) d\theta = \int_0^{2\pi} \left[8 + 8 \cos \theta + 2 \left(\frac{1 + \cos 2\theta}{2} \right) \right] d\theta$$

$$= \int_0^{2\pi} (9 + 8 \cos \theta + \cos 2\theta) d\theta = \left[9\theta + 8 \sin \theta + \frac{1}{2} \sin 2\theta \right]_0^{2\pi} = 18\pi$$
- $$A = \int_0^{2\pi} \frac{1}{2} [a(1 + \cos \theta)]^2 d\theta = \int_0^{2\pi} \frac{1}{2} a^2 (1 + 2 \cos \theta + \cos^2 \theta) d\theta = \frac{1}{2} a^2 \int_0^{2\pi} \left(1 + 2 \cos \theta + \frac{1 + \cos 2\theta}{2} \right) d\theta$$

$$= \frac{1}{2} a^2 \int_0^{2\pi} \left(\frac{3}{2} + 2 \cos \theta + \frac{1}{2} \cos 2\theta \right) d\theta = \frac{1}{2} a^2 \left[\frac{3}{2} \theta + 2 \sin \theta + \frac{1}{4} \sin 2\theta \right]_0^{2\pi} = \frac{3}{2} \pi a^2$$
- $$A = 2 \int_0^{\pi/4} \frac{1}{2} \cos^2 2\theta d\theta = \int_0^{\pi/4} \frac{1 + \cos 4\theta}{2} d\theta = \frac{1}{2} \left[\theta + \frac{\sin 4\theta}{4} \right]_0^{\pi/4} = \frac{\pi}{8}$$
- $$A = \int_{-\pi/6}^{\pi/6} \frac{1}{2} (\cos 3\theta)^2 d\theta = \frac{1}{2} \int_{-\pi/6}^{\pi/6} \cos^2 3\theta d\theta = \frac{1}{2} \int_{-\pi/6}^{\pi/6} \frac{1 + \cos 6\theta}{2} d\theta = \frac{1}{4} \int_{-\pi/6}^{\pi/6} (1 + \cos 6\theta) d\theta$$

$$= \frac{1}{4} \left[\theta + \frac{1}{6} \sin 6\theta \right]_{-\pi/6}^{\pi/6} = \frac{1}{4} \left(\frac{\pi}{6} + 0 \right) - \frac{1}{4} \left(-\frac{\pi}{6} + 0 \right) = \frac{\pi}{12}$$
- $$A = \int_0^{\pi/2} \frac{1}{2} (4 \sin 2\theta) d\theta = \int_0^{\pi/2} 2 \sin 2\theta d\theta = [-\cos 2\theta]_0^{\pi/2} = 2$$
- $$A = (6)(2) \int_0^{\pi/6} \frac{1}{2} (2 \sin 3\theta) d\theta = 12 \int_0^{\pi/6} \sin 3\theta d\theta = 12 \left[-\frac{\cos 3\theta}{3} \right]_0^{\pi/6} = 4$$

9. $r = 2 \cos \theta$ and $r = 2 \sin \theta \Rightarrow 2 \cos \theta = 2 \sin \theta$
 $\Rightarrow \cos \theta = \sin \theta \Rightarrow \theta = \frac{\pi}{4}$; therefore

$$\begin{aligned} A &= 2 \int_0^{\pi/4} \frac{1}{2} (2 \sin \theta)^2 d\theta = \int_0^{\pi/4} 4 \sin^2 \theta d\theta \\ &= \int_0^{\pi/4} 4 \left(\frac{1 - \cos 2\theta}{2} \right) d\theta = \int_0^{\pi/4} (2 - 2 \cos 2\theta) d\theta \\ &= [2\theta - \sin 2\theta]_0^{\pi/4} = \frac{\pi}{2} - 1 \end{aligned}$$

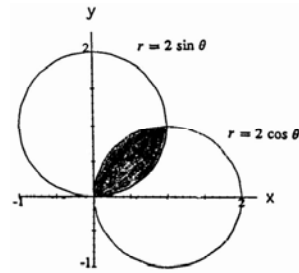

10. $r = 1$ and $r = 2 \sin \theta \Rightarrow 2 \sin \theta = 1 \Rightarrow \sin \theta = \frac{1}{2}$
 $\Rightarrow \theta = \frac{\pi}{6}$ or $\frac{5\pi}{6}$; therefore

$$\begin{aligned} A &= \pi(1)^2 - \int_{\pi/6}^{5\pi/6} \frac{1}{2} [(2 \sin \theta)^2 - 1^2] d\theta \\ &= \pi - \int_{\pi/6}^{5\pi/6} (2 \sin^2 \theta - \frac{1}{2}) d\theta = \pi - \int_{\pi/6}^{5\pi/6} (1 - \cos 2\theta - \frac{1}{2}) d\theta \\ &= \pi - \int_{\pi/6}^{5\pi/6} (\frac{1}{2} - \cos 2\theta) d\theta = \pi - \left[\frac{1}{2}\theta - \frac{\sin 2\theta}{2} \right]_{\pi/6}^{5\pi/6} \\ &= \pi - \left(\frac{5\pi}{12} - \frac{1}{2} \sin \frac{5\pi}{3} \right) + \left(\frac{\pi}{12} - \frac{1}{2} \sin \frac{\pi}{3} \right) = \frac{4\pi - 3\sqrt{3}}{6} \end{aligned}$$

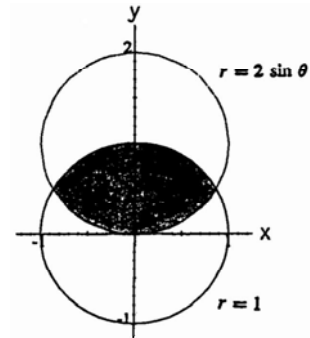

11. $r = 2$ and $r = 2(1 - \cos \theta) \Rightarrow 2 = 2(1 - \cos \theta) \Rightarrow \cos \theta = 0$
 $\Rightarrow \theta = \pm \frac{\pi}{2}$; therefore

$$\begin{aligned} A &= 2 \int_0^{\pi/2} \frac{1}{2} [2(1 - \cos \theta)]^2 d\theta + \frac{1}{2} \text{ area of the circle} \\ &= \int_0^{\pi/2} 4(1 - 2 \cos \theta + \cos^2 \theta) d\theta + \left(\frac{1}{2} \pi \right) (2)^2 \\ &= \int_0^{\pi/2} 4 \left(1 - 2 \cos \theta + \frac{1 + \cos 2\theta}{2} \right) d\theta + 2\pi \\ &= \int_0^{\pi/2} (4 - 8 \cos \theta + 2 + 2 \cos 2\theta) d\theta + 2\pi \\ &= [6\theta - 8 \sin \theta + \sin 2\theta]_0^{\pi/2} + 2\pi = 5\pi - 8 \end{aligned}$$

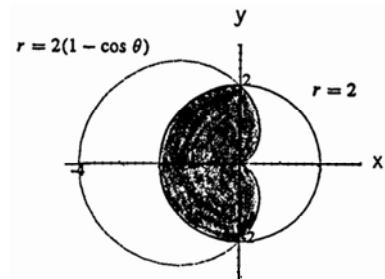

12. $r = 2(1 - \cos \theta)$ and $r = 2(1 + \cos \theta)$
 $\Rightarrow 1 - \cos \theta = 1 + \cos \theta \Rightarrow \cos \theta = 0 \Rightarrow \theta = \frac{\pi}{2}$ or $\frac{3\pi}{2}$; the graph also gives the point of intersection $(0, 0)$; therefore

$$\begin{aligned} A &= 2 \int_0^{\pi/2} \frac{1}{2} [2(1 - \cos \theta)]^2 d\theta + 2 \int_{\pi/2}^{\pi} \frac{1}{2} [2(1 + \cos \theta)]^2 d\theta \\ &= \int_0^{\pi/2} 4(1 - 2 \cos \theta + \cos^2 \theta) d\theta + \int_{\pi/2}^{\pi} 4(1 + 2 \cos \theta + \cos^2 \theta) d\theta \\ &= \int_0^{\pi/2} 4 \left(1 - 2 \cos \theta + \frac{1 + \cos 2\theta}{2} \right) d\theta + \int_{\pi/2}^{\pi} 4 \left(1 + 2 \cos \theta + \frac{1 + \cos 2\theta}{2} \right) d\theta \\ &= \int_0^{\pi/2} (6 - 8 \cos \theta + 2 \cos 2\theta) d\theta + \int_{\pi/2}^{\pi} (6 + 8 \cos \theta + 2 \cos 2\theta) d\theta \\ &= [6\theta - 8 \sin \theta + \sin 2\theta]_0^{\pi/2} + [6\theta + 8 \sin \theta + \sin 2\theta]_{\pi/2}^{\pi} = 6\pi - 16 \end{aligned}$$

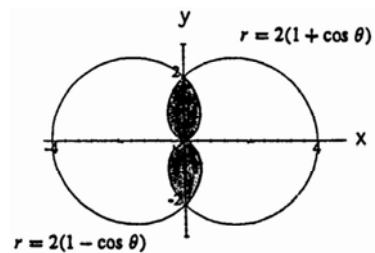

13. $r = \sqrt{3}$ and $r^2 = 6 \cos 2\theta \Rightarrow 3 = 6 \cos 2\theta \Rightarrow \cos 2\theta = \frac{1}{2}$
 $\Rightarrow \theta = \frac{\pi}{6}$ (in the 1st quadrant); we use symmetry of the graph

$$\begin{aligned} \text{to find the area, so } A &= 4 \int_0^{\pi/6} \left[\frac{1}{2}(6 \cos 2\theta) - \frac{1}{2}(\sqrt{3})^2 \right] d\theta \\ &= 2 \int_0^{\pi/6} (6 \cos 2\theta - 3) d\theta = 2 \left[3 \sin 2\theta - 3\theta \right]_0^{\pi/6} = 3\sqrt{3} - \pi \end{aligned}$$

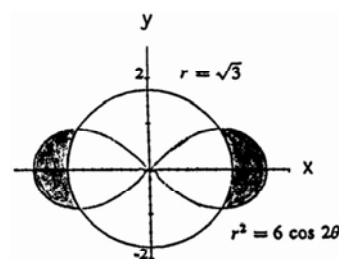

14. $r = 3a \cos \theta$ and $r = a(1 + \cos \theta) \Rightarrow 3a \cos \theta = a(1 + \cos \theta)$
 $\Rightarrow 3 \cos \theta = 1 + \cos \theta \Rightarrow \cos \theta = \frac{1}{2} \Rightarrow \theta = \frac{\pi}{3}$ or $-\frac{\pi}{3}$; the graph

$$\begin{aligned} \text{also gives the point of intersection } (0, 0); \text{ therefore} \\ A &= 2 \int_0^{\pi/3} \frac{1}{2} \left[(3a \cos \theta)^2 - a^2 (1 + \cos \theta)^2 \right] d\theta \\ &= \int_0^{\pi/3} (9a^2 \cos^2 \theta - a^2 - 2a^2 \cos \theta - a^2 \cos^2 \theta) d\theta \\ &= \int_0^{\pi/3} (8a^2 \cos^2 \theta - 2a^2 \cos \theta - a^2) d\theta \\ &= \int_0^{\pi/3} \left[4a^2 (1 + \cos 2\theta) - 2a^2 \cos \theta - a^2 \right] d\theta \\ &= \int_0^{\pi/3} (3a^2 + 4a^2 \cos 2\theta - 2a^2 \cos \theta) d\theta \\ &= \left[3a^2 \theta + 2a^2 \sin 2\theta - 2a^2 \sin \theta \right]_0^{\pi/3} \\ &= \pi a^2 + 2a^2 \left(\frac{1}{2} \right) - 2a^2 \left(\frac{\sqrt{3}}{2} \right) = a^2 (\pi + 1 - \sqrt{3}) \end{aligned}$$

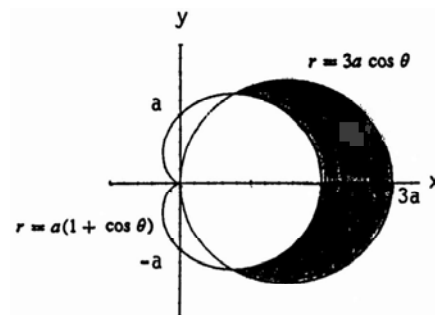

15. $r = 1$ and $r = -2 \cos \theta \Rightarrow 1 = -2 \cos \theta \Rightarrow \cos \theta = -\frac{1}{2} \Rightarrow \theta = \frac{2\pi}{3}$ in quadrant II; therefore

$$\begin{aligned} A &= 2 \int_{2\pi/3}^{\pi} \frac{1}{2} \left[(-2 \cos \theta)^2 - 1^2 \right] d\theta = \int_{2\pi/3}^{\pi} (4 \cos^2 \theta - 1) d\theta \\ &= \int_{2\pi/3}^{\pi} [2(1 + \cos 2\theta) - 1] d\theta = \int_{2\pi/3}^{\pi} (1 + 2 \cos 2\theta) d\theta \\ &= \left[\theta + \sin 2\theta \right]_{2\pi/3}^{\pi} = \frac{\pi}{3} + \frac{\sqrt{3}}{2} \end{aligned}$$

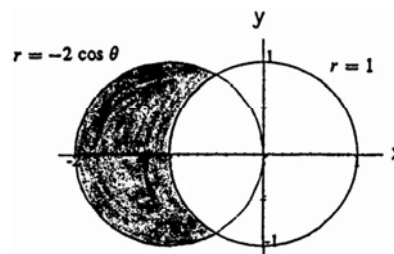

16. $r = 6$ and $r = 3 \csc \theta \Rightarrow 6 \sin \theta = 3 \Rightarrow \sin \theta = \frac{1}{2} \Rightarrow \theta = \frac{\pi}{6}$ or $\frac{5\pi}{6}$; therefore

$$\begin{aligned} A &= \int_{\pi/6}^{5\pi/6} \frac{1}{2} (6^2 - 9 \csc^2 \theta) d\theta = \int_{\pi/6}^{5\pi/6} \left(18 - \frac{9}{2} \csc^2 \theta \right) d\theta \\ &= \left[18\theta + \frac{9}{2} \cot \theta \right]_{\pi/6}^{5\pi/6} = \left(15\pi - \frac{9}{2}\sqrt{3} \right) - \left(3\pi + \frac{9}{2}\sqrt{3} \right) = 12\pi - 9\sqrt{3} \end{aligned}$$

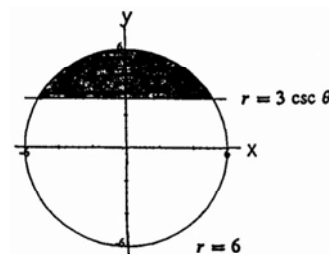

17. $r = \sec \theta$ and $r = 4 \cos \theta \Rightarrow 4 \cos \theta = \sec \theta \Rightarrow \cos^2 \theta = \frac{1}{4}$
 $\Rightarrow \theta = \frac{\pi}{3}, \frac{2\pi}{3}, \frac{4\pi}{3},$ or $\frac{5\pi}{3}$; therefore
 $A = 2 \int_0^{\pi/3} \frac{1}{2} (16 \cos^2 \theta - \sec^2 \theta) d\theta$
 $= \int_0^{\pi/3} (8 + 8 \cos 2\theta - \sec^2 \theta) d\theta = [8\theta + 4 \sin 2\theta - \tan \theta]_0^{\pi/3}$
 $= \left(\frac{8\pi}{3} + 2\sqrt{3} - \sqrt{3}\right) - (0 + 0 - 0) = \frac{8\pi}{3} + \sqrt{3}$

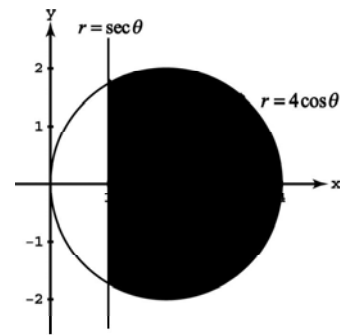

18. $r = 3 \csc \theta$ and $r = 4 \sin \theta \Rightarrow 4 \sin \theta = 3 \csc \theta \Rightarrow \sin^2 \theta = \frac{3}{4}$
 $\Rightarrow \theta = \frac{\pi}{3}, \frac{2\pi}{3}, \frac{4\pi}{3},$ or $\frac{5\pi}{3}$; therefore
 $A = 4\pi - 2 \int_{\pi/3}^{\pi/2} \frac{1}{2} (16 \sin^2 \theta - 9 \csc^2 \theta) d\theta$
 $= 4\pi - \int_{\pi/3}^{\pi/2} (8 - 8 \cos 2\theta - 9 \csc^2 \theta) d\theta$
 $= 4\pi - [8\theta - 4 \sin 2\theta + 9 \cot \theta]_{\pi/3}^{\pi/2}$
 $= 4\pi - \left[(4\pi - 0 + 0) - \left(\frac{8\pi}{3} - 2\sqrt{3} + 3\sqrt{3}\right)\right] = \frac{8\pi}{3} + \sqrt{3}$

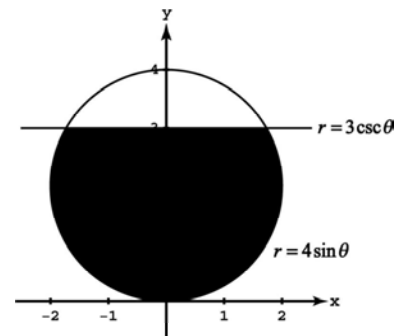

19. (a) $r = \tan \theta$ and $r = \left(\frac{\sqrt{2}}{2}\right) \csc \theta \Rightarrow \tan \theta = \left(\frac{\sqrt{2}}{2}\right) \csc \theta$
 $\Rightarrow \sin^2 \theta = \left(\frac{\sqrt{2}}{2}\right) \cos \theta \Rightarrow 1 - \cos^2 \theta = \left(\frac{\sqrt{2}}{2}\right) \cos \theta$
 $\Rightarrow \cos^2 \theta + \left(\frac{\sqrt{2}}{2}\right) \cos \theta - 1 = 0 \Rightarrow \cos \theta = -\sqrt{2}$ or $\frac{\sqrt{2}}{2}$
 (use the quadratic formula) $\Rightarrow \theta = \frac{\pi}{4}$ (the solution in the first quadrant); therefore the area of R_1 is

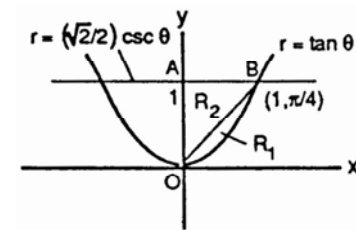

$$A_1 = \int_0^{\pi/4} \frac{1}{2} \tan^2 \theta d\theta = \frac{1}{2} \int_0^{\pi/4} (\sec^2 \theta - 1) d\theta = \frac{1}{2} [\tan \theta - \theta]_0^{\pi/4} = \frac{1}{2} \left(\tan \frac{\pi}{4} - \frac{\pi}{4}\right) = \frac{1}{2} - \frac{\pi}{8};$$

$$AO = \left(\frac{\sqrt{2}}{2}\right) \csc \frac{\pi}{2} = \frac{\sqrt{2}}{2} \text{ and } OB = \left(\frac{\sqrt{2}}{2}\right) \csc \frac{\pi}{4} = 1 \Rightarrow AB = \sqrt{1^2 - \left(\frac{\sqrt{2}}{2}\right)^2} = \frac{\sqrt{2}}{2} \Rightarrow \text{the area of } R_2 \text{ is}$$

$$A_2 = \frac{1}{2} \left(\frac{\sqrt{2}}{2}\right) \left(\frac{\sqrt{2}}{2}\right) = \frac{1}{4}; \text{ therefore the area of the region shaded in the text is } 2\left(\frac{1}{2} - \frac{\pi}{8} + \frac{1}{4}\right) = \frac{3}{2} - \frac{\pi}{4}. \text{ Note:}$$

The area must be found this way since no common interval generates the region. For example, the interval $0 \leq \theta \leq \frac{\pi}{4}$ generates the arc OB of $r = \tan \theta$ but does not generate the segment AB of the line $r = \frac{\sqrt{2}}{2} \csc \theta$.

Instead the interval generates the half-line from B to $+\infty$ on the line $r = \frac{\sqrt{2}}{2} \csc \theta$.

(b) $\lim_{\theta \rightarrow \frac{\pi}{2}^-} \tan \theta = \infty$ and the line $x = 1$ is $r = \sec \theta$ in polar coordinates; then

$$\lim_{\theta \rightarrow \frac{\pi}{2}^-} (\tan \theta - \sec \theta) = \lim_{\theta \rightarrow \frac{\pi}{2}^-} \left(\frac{\sin \theta}{\cos \theta} - \frac{1}{\cos \theta}\right) = \lim_{\theta \rightarrow \frac{\pi}{2}^-} \left(\frac{\sin \theta - 1}{\cos \theta}\right) = \lim_{\theta \rightarrow \frac{\pi}{2}^-} \left(\frac{\cos \theta}{-\sin \theta}\right) = 0 \Rightarrow r = \tan \theta \text{ approaches}$$

$r = \sec \theta$ as $\theta \rightarrow \left(\frac{\pi}{2}\right)^- \Rightarrow r = \sec \theta$ (or $x = 1$) is a vertical asymptote of $r = \tan \theta$. Similarly,

$r = -\sec \theta$ (or $x = -1$) is a vertical asymptote of $r = \tan \theta$.

20. It is not because the circle is generated twice from $\theta = 0$ to 2π . The area of the cardioid is

$$\begin{aligned} A &= 2 \int_0^\pi \frac{1}{2} (\cos \theta + 1)^2 d\theta = \int_0^\pi (\cos^2 \theta + 2 \cos \theta + 1) d\theta = \int_0^\pi \left(\frac{1 + \cos 2\theta}{2} + 2 \cos \theta + 1 \right) d\theta \\ &= \left[\frac{3\theta}{2} + \frac{\sin 2\theta}{4} + 2 \sin \theta \right]_0^\pi = \frac{3\pi}{2}. \text{ The area of the circle is } A = \pi \left(\frac{1}{2} \right)^2 = \frac{\pi}{4} \Rightarrow \text{ the area requested} \\ &\text{is actually } \frac{3\pi}{2} - \frac{\pi}{4} = \frac{5\pi}{4} \end{aligned}$$

21. $r = \theta^2, 0 \leq \theta \leq \sqrt{5} \Rightarrow \frac{dr}{d\theta} = 2\theta$; therefore Length $= \int_0^{\sqrt{5}} \sqrt{(\theta^2)^2 + (2\theta)^2} d\theta = \int_0^{\sqrt{5}} \sqrt{\theta^4 + 4\theta^2} d\theta$

$$= \int_0^{\sqrt{5}} |\theta| \sqrt{\theta^2 + 4} d\theta = \int_0^{\sqrt{5}} \theta \sqrt{\theta^2 + 4} d\theta; \text{ (since } \theta \geq 0 \text{)}$$

$$\left[u = \theta^2 + 4 \Rightarrow \frac{1}{2} du = \theta d\theta; \theta = 0 \Rightarrow u = 4, \theta = \sqrt{5} \Rightarrow u = 9 \right] \rightarrow \int_4^9 \frac{1}{2} \sqrt{u} du = \frac{1}{2} \left[\frac{2}{3} u^{3/2} \right]_4^9 = \frac{19}{3}$$

22. $r = \frac{e^\theta}{\sqrt{2}}, 0 \leq \theta \leq \pi \Rightarrow \frac{dr}{d\theta} = \frac{e^\theta}{\sqrt{2}}$; therefore Length $= \int_0^\pi \sqrt{\left(\frac{e^\theta}{\sqrt{2}} \right)^2 + \left(\frac{e^\theta}{\sqrt{2}} \right)^2} d\theta = \int_0^\pi \sqrt{2 \left(\frac{e^{2\theta}}{2} \right)} d\theta$

$$= \int_0^\pi e^\theta d\theta = \left[e^\theta \right]_0^\pi = e^\pi - 1$$

23. $r = 1 + \cos \theta \Rightarrow \frac{dr}{d\theta} = -\sin \theta$; therefore Length $= \int_0^{2\pi} \sqrt{(1 + \cos \theta)^2 + (-\sin \theta)^2} d\theta$

$$= 2 \int_0^\pi \sqrt{2 + 2 \cos \theta} d\theta = 2 \int_0^\pi \sqrt{\frac{4(1 + \cos \theta)}{2}} d\theta = 4 \int_0^\pi \sqrt{\frac{1 + \cos \theta}{2}} d\theta = 4 \int_0^\pi \cos \left(\frac{\theta}{2} \right) d\theta = 4 \left[2 \sin \frac{\theta}{2} \right]_0^\pi = 8$$

24. $r = a \sin^2 \frac{\theta}{2}, 0 \leq \theta \leq \pi, a > 0 \Rightarrow \frac{dr}{d\theta} = a \sin \frac{\theta}{2} \cos \frac{\theta}{2}$; therefore Length $= \int_0^\pi \sqrt{\left(a \sin^2 \frac{\theta}{2} \right)^2 + \left(a \sin \frac{\theta}{2} \cos \frac{\theta}{2} \right)^2} d\theta$

$$= \int_0^\pi \sqrt{a^2 \sin^4 \frac{\theta}{2} + a^2 \sin^2 \frac{\theta}{2} \cos^2 \frac{\theta}{2}} d\theta = \int_0^\pi a \left| \sin \frac{\theta}{2} \right| \sqrt{\sin^2 \frac{\theta}{2} + \cos^2 \frac{\theta}{2}} d\theta = a \int_0^\pi \sin \left(\frac{\theta}{2} \right) d\theta \text{ (since } 0 \leq \theta \leq \pi \text{)}$$

$$= \left[-2a \cos \frac{\theta}{2} \right]_0^\pi = 2a$$

25. $r = \frac{6}{1 + \cos \theta}, 0 \leq \theta \leq \frac{\pi}{2} \Rightarrow \frac{dr}{d\theta} = \frac{6 \sin \theta}{(1 + \cos \theta)^2}$; therefore Length $= \int_0^{\pi/2} \sqrt{\left(\frac{6}{1 + \cos \theta} \right)^2 + \left(\frac{6 \sin \theta}{(1 + \cos \theta)^2} \right)^2} d\theta$

$$= \int_0^{\pi/2} \sqrt{\frac{36}{(1 + \cos \theta)^2} + \frac{36 \sin^2 \theta}{(1 + \cos \theta)^4}} d\theta = 6 \int_0^{\pi/2} \frac{1}{1 + \cos \theta} \sqrt{1 + \frac{\sin^2 \theta}{(1 + \cos \theta)^2}} d\theta$$

$$= 6 \int_0^{\pi/2} \left(\frac{1}{1 + \cos \theta} \right) \sqrt{\frac{1 + 2 \cos \theta + \cos^2 \theta + \sin^2 \theta}{(1 + \cos \theta)^2}} d\theta \text{ (since } \frac{1}{1 + \cos \theta} > 0 \text{ on } 0 \leq \theta \leq \frac{\pi}{2} \text{)}$$

$$= 6 \int_0^{\pi/2} \left(\frac{1}{1 + \cos \theta} \right) \sqrt{\frac{2 + 2 \cos \theta}{(1 + \cos \theta)^2}} d\theta = 6\sqrt{2} \int_0^{\pi/2} \frac{d\theta}{(1 + \cos \theta)^{3/2}} = 6\sqrt{2} \int_0^{\pi/2} \frac{d\theta}{(2 \cos^2 \frac{\theta}{2})^{3/2}} = 3 \int_0^{\pi/2} \left| \sec^3 \frac{\theta}{2} \right| d\theta$$

$$= 3 \int_0^{\pi/2} \sec^3 \frac{\theta}{2} d\theta = 6 \int_0^{\pi/4} \sec^3 u du = 6 \left(\left[\frac{\sec u \tan u}{2} \right]_0^{\pi/4} + \frac{1}{2} \int_0^{\pi/4} \sec u du \right) \text{ (use tables)}$$

$$= 6 \left(\frac{1}{\sqrt{2}} + \left[\frac{1}{2} \ln |\sec u + \tan u| \right]_0^{\pi/4} \right) = 3 \left[\sqrt{2} + \ln(1 + \sqrt{2}) \right]$$

$$\begin{aligned}
26. \quad r &= \frac{2}{1-\cos\theta}, \frac{\pi}{2} \leq \theta \leq \pi \Rightarrow \frac{dr}{d\theta} = \frac{-2\sin\theta}{(1-\cos\theta)^2}; \text{ therefore Length} = \int_{\pi/2}^{\pi} \sqrt{\left(\frac{2}{1-\cos\theta}\right)^2 + \left(\frac{-2\sin\theta}{(1-\cos\theta)^2}\right)^2} d\theta \\
&= \int_{\pi/2}^{\pi} \sqrt{\frac{4}{(1-\cos\theta)^2} \left(1 + \frac{\sin^2\theta}{(1-\cos\theta)^2}\right)} d\theta = \int_{\pi/2}^{\pi} \frac{2}{1-\cos\theta} \sqrt{\frac{(1-\cos\theta)^2 + \sin^2\theta}{(1-\cos\theta)^2}} d\theta \\
&= 2 \int_{\pi/2}^{\pi} \frac{1}{1-\cos\theta} \sqrt{\frac{1-2\cos\theta+\cos^2\theta+\sin^2\theta}{(1-\cos\theta)^2}} d\theta \quad (\text{since } 1-\cos\theta \geq 0 \text{ on } \frac{\pi}{2} \leq \theta \leq \pi) \\
&= 2 \int_{\pi/2}^{\pi} \frac{1}{1-\cos\theta} \sqrt{\frac{2-2\cos\theta}{(1-\cos\theta)^2}} d\theta = 2\sqrt{2} \int_{\pi/2}^{\pi} \frac{d\theta}{(1-\cos\theta)^{3/2}} = 2\sqrt{2} \int_{\pi/2}^{\pi} \frac{d\theta}{(2\sin^2\frac{\theta}{2})^{3/2}} = \int_{\pi/2}^{\pi} \left| \csc^3 \frac{\theta}{2} \right| d\theta = \int_{\pi/2}^{\pi} \csc^3\left(\frac{\theta}{2}\right) d\theta \\
&(\text{since } \csc \frac{\theta}{2} \geq 0 \text{ on } \frac{\pi}{2} \leq \theta \leq \pi) = \int_{\pi/4}^{\pi/2} \csc^3 u \, du = 2 \left(\left[-\frac{\csc u \cot u}{2} \right]_{\pi/4}^{\pi/2} + \frac{1}{2} \int_{\pi/4}^{\pi/2} \csc u \, du \right) \quad (\text{use tables}) \\
&= 2 \left(\frac{1}{\sqrt{2}} - \left[\frac{1}{2} \ln |\csc u + \cot u| \right]_{\pi/4}^{\pi/2} \right) = 2 \left[\frac{1}{\sqrt{2}} + \frac{1}{2} \ln(\sqrt{2}+1) \right] = \sqrt{2} + \ln(1+\sqrt{2})
\end{aligned}$$

$$\begin{aligned}
27. \quad r &= \cos^3 \frac{\theta}{3} \Rightarrow \frac{dr}{d\theta} = -\sin \frac{\theta}{3} \cos^2 \frac{\theta}{3}; \text{ therefore Length} = \int_0^{\pi/4} \sqrt{\left(\cos^3 \frac{\theta}{3}\right)^2 + \left(-\sin \frac{\theta}{3} \cos^2 \frac{\theta}{3}\right)^2} d\theta \\
&= \int_0^{\pi/4} \sqrt{\cos^6\left(\frac{\theta}{3}\right) + \sin^2\left(\frac{\theta}{3}\right) \cos^4\left(\frac{\theta}{3}\right)} d\theta = \int_0^{\pi/4} \left(\cos^2 \frac{\theta}{3}\right) \sqrt{\cos^2\left(\frac{\theta}{3}\right) + \sin^2\left(\frac{\theta}{3}\right)} d\theta = \int_0^{\pi/4} \cos^2\left(\frac{\theta}{3}\right) d\theta \\
&= \int_0^{\pi/4} \frac{1+\cos\left(\frac{2\theta}{3}\right)}{2} d\theta = \frac{1}{2} \left[\theta + \frac{3}{2} \sin \frac{2\theta}{3} \right]_0^{\pi/4} = \frac{\pi}{8} + \frac{3}{8}
\end{aligned}$$

$$\begin{aligned}
28. \quad r &= \sqrt{1+\sin 2\theta}, 0 \leq \theta \leq \pi\sqrt{2} \Rightarrow \frac{dr}{d\theta} = \frac{1}{2}(1+\sin 2\theta)^{-1/2} (2\cos 2\theta) = (\cos 2\theta)(1+\sin 2\theta)^{-1/2}; \text{ therefore} \\
\text{Length} &= \int_0^{\pi\sqrt{2}} \sqrt{(1+\sin 2\theta) + \frac{\cos^2 2\theta}{(1+\sin 2\theta)}} d\theta = \int_0^{\pi\sqrt{2}} \sqrt{\frac{1+2\sin 2\theta + \sin^2 2\theta + \cos^2 2\theta}{1+\sin 2\theta}} d\theta = \int_0^{\pi\sqrt{2}} \sqrt{\frac{2+2\sin 2\theta}{1+\sin 2\theta}} d\theta \\
&= \int_0^{\pi\sqrt{2}} \sqrt{2} d\theta = \left[\sqrt{2}\theta \right]_0^{\pi\sqrt{2}} = 2\pi
\end{aligned}$$

$$\begin{aligned}
29. \quad \text{Let } r &= f(\theta). \text{ Then } x = f(\theta)\cos\theta \Rightarrow \frac{dx}{d\theta} = f'(\theta)\cos\theta - f(\theta)\sin\theta \Rightarrow \left(\frac{dx}{d\theta}\right)^2 = [f'(\theta)\cos\theta - f(\theta)\sin\theta]^2 \\
&= [f'(\theta)]^2 \cos^2\theta - 2f'(\theta)f(\theta)\sin\theta\cos\theta + [f(\theta)]^2 \sin^2\theta; \quad y = f(\theta)\sin\theta \Rightarrow \frac{dy}{d\theta} = f'(\theta)\sin\theta + f(\theta)\cos\theta \\
&\Rightarrow \left(\frac{dy}{d\theta}\right)^2 = [f'(\theta)\sin\theta + f(\theta)\cos\theta]^2 = [f'(\theta)]^2 \sin^2\theta + 2f'(\theta)f(\theta)\sin\theta\cos\theta + [f(\theta)]^2 \cos^2\theta. \text{ Therefore} \\
&\left(\frac{dx}{d\theta}\right)^2 + \left(\frac{dy}{d\theta}\right)^2 = [f'(\theta)]^2 (\cos^2\theta + \sin^2\theta) + [f(\theta)]^2 (\cos^2\theta + \sin^2\theta) = [f'(\theta)]^2 + [f(\theta)]^2 = r^2 + \left(\frac{dr}{d\theta}\right)^2.
\end{aligned}$$

$$\text{Thus, } L = \int_{\alpha}^{\beta} \sqrt{\left(\frac{dx}{d\theta}\right)^2 + \left(\frac{dy}{d\theta}\right)^2} d\theta = \int_{\alpha}^{\beta} \sqrt{r^2 + \left(\frac{dr}{d\theta}\right)^2} d\theta.$$

$$30. \quad (a) \quad r = a \Rightarrow \frac{dr}{d\theta} = 0; \text{ Length} = \int_0^{2\pi} \sqrt{a^2 + 0^2} d\theta = \int_0^{2\pi} |a| d\theta = [a\theta]_0^{2\pi} = 2\pi a$$

$$\begin{aligned}
(b) \quad r &= a \cos\theta \Rightarrow \frac{dr}{d\theta} = -a \sin\theta; \text{ Length} = \int_0^{\pi} \sqrt{(a \cos\theta)^2 + (-a \sin\theta)^2} d\theta = \int_0^{\pi} \sqrt{a^2 (\cos^2\theta + \sin^2\theta)} d\theta \\
&= \int_0^{\pi} |a| d\theta = [a\theta]_0^{\pi} = \pi a
\end{aligned}$$

$$\begin{aligned}
(c) \quad r &= a \sin\theta \Rightarrow \frac{dr}{d\theta} = a \cos\theta; \text{ Length} = \int_0^{\pi} \sqrt{(a \cos\theta)^2 + (a \sin\theta)^2} d\theta = \int_0^{\pi} \sqrt{a^2 (\cos^2\theta + \sin^2\theta)} d\theta \\
&= \int_0^{\pi} |a| d\theta = [a\theta]_0^{\pi} = \pi a
\end{aligned}$$

$$31. (a) r_{av} = \frac{1}{2\pi-0} \int_0^{2\pi} a(1-\cos\theta) d\theta = \frac{a}{2\pi} [\theta - \sin\theta]_0^{2\pi} = a$$

$$(b) r_{av} = \frac{1}{2\pi-0} \int_0^{2\pi} a d\theta = \frac{1}{2\pi} [a\theta]_0^{2\pi} = a$$

$$(c) r_{av} = \frac{1}{\left(\frac{\pi}{2}\right) - \left(-\frac{\pi}{2}\right)} \int_{-\pi/2}^{\pi/2} a \cos\theta d\theta = \frac{1}{\pi} [a \sin\theta]_{-\pi/2}^{\pi/2} = \frac{2a}{\pi}$$

$$32. r = 2f(\theta), \alpha \leq \theta \leq \beta \Rightarrow \frac{dr}{d\theta} = 2f'(\theta) \Rightarrow r^2 + \left(\frac{dr}{d\theta}\right)^2 = [2f(\theta)]^2 + [2f'(\theta)]^2$$

$$\Rightarrow \text{Length} = \int_{\alpha}^{\beta} \sqrt{4[f(\theta)]^2 + 4[f'(\theta)]^2} d\theta = 2 \int_{\alpha}^{\beta} \sqrt{[f(\theta)]^2 + [f'(\theta)]^2} d\theta$$

which is twice the length of the curve $r = f(\theta)$ for $\alpha \leq \theta \leq \beta$.

11.6 CONIC SECTIONS

$$1. x = \frac{y^2}{8} \Rightarrow 4p = 8 \Rightarrow p = 2; \text{ focus is } (2, 0), \text{ directrix is } x = -2$$

$$2. x = -\frac{y^2}{4} \Rightarrow 4p = 4 \Rightarrow p = 1; \text{ focus is } (-1, 0), \text{ directrix is } x = 1$$

$$3. y = -\frac{x^2}{6} \Rightarrow 4p = 6 \Rightarrow p = \frac{3}{2}; \text{ focus is } \left(0, -\frac{3}{2}\right), \text{ directrix is } y = \frac{3}{2}$$

$$4. y = \frac{x^2}{2} \Rightarrow 4p = 2 \Rightarrow p = \frac{1}{2}; \text{ focus is } \left(0, \frac{1}{2}\right), \text{ directrix is } y = -\frac{1}{2}$$

$$5. \frac{x^2}{4} - \frac{y^2}{9} = 1 \Rightarrow c = \sqrt{4+9} = \sqrt{13} \Rightarrow \text{foci are } (\pm\sqrt{13}, 0); \text{ vertices are } (\pm 2, 0); \text{ asymptotes are } y = \pm \frac{3}{2}x$$

$$6. \frac{x^2}{4} + \frac{y^2}{9} = 1 \Rightarrow c = \sqrt{9-4} = \sqrt{5} \Rightarrow \text{foci are } (0, \pm\sqrt{5}); \text{ vertices are } (0, \pm 3)$$

$$7. \frac{x^2}{2} + y^2 = 1 \Rightarrow c = \sqrt{2-1} = 1 \Rightarrow \text{foci are } (\pm 1, 0); \text{ vertices are } (\pm\sqrt{2}, 0)$$

$$8. \frac{y^2}{4} - x^2 = 1 \Rightarrow c = \sqrt{4+1} = \sqrt{5} \Rightarrow \text{foci are } (0, \pm\sqrt{5}); \text{ vertices are } (0, \pm 2); \text{ asymptotes are } y = \pm 2x$$

9. $y^2 = 12x \Rightarrow x = \frac{y^2}{12} \Rightarrow 4p = 12 \Rightarrow p = 3$;
focus is $(3, 0)$, directrix is $x = -3$

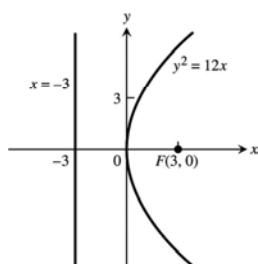

10. $x^2 = 6y \Rightarrow y = \frac{x^2}{6} \Rightarrow 4p = 6 \Rightarrow p = \frac{3}{2}$;
focus is $(0, \frac{3}{2})$, directrix is $y = -\frac{3}{2}$

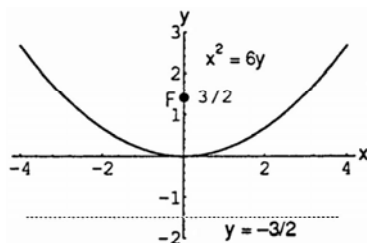

11. $x^2 = -8y \Rightarrow y = \frac{x^2}{-8} \Rightarrow 4p = 8 \Rightarrow p = 2$;
focus is $(0, -2)$, directrix is $y = 2$

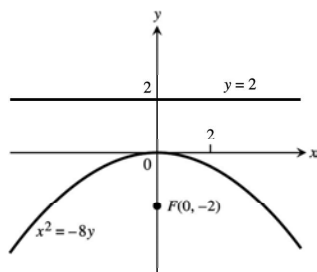

12. $y^2 = -2x \Rightarrow x = \frac{y^2}{-2} \Rightarrow 4p = 2 \Rightarrow p = \frac{1}{2}$;
focus is $(-\frac{1}{2}, 0)$, directrix is $x = \frac{1}{2}$

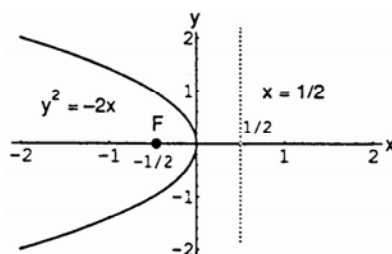

13. $y = 4x^2 \Rightarrow y = \frac{x^2}{(1/4)} \Rightarrow 4p = \frac{1}{4} \Rightarrow p = \frac{1}{16}$;
focus is $(0, \frac{1}{16})$, directrix is $y = -\frac{1}{16}$

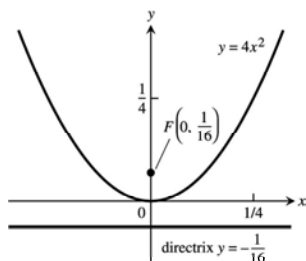

14. $y = -8x^2 \Rightarrow y = -\frac{x^2}{(1/8)} \Rightarrow 4p = \frac{1}{8} \Rightarrow p = \frac{1}{32}$;
focus is $(0, -\frac{1}{32})$, directrix is $y = \frac{1}{32}$

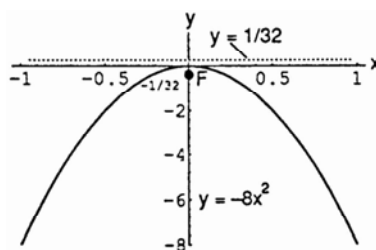

15. $x = -3y^2 \Rightarrow x = -\frac{y^2}{(1/3)} \Rightarrow 4p = \frac{1}{3} \Rightarrow p = \frac{1}{12}$;
focus is $(-\frac{1}{12}, 0)$, directrix is $x = \frac{1}{12}$

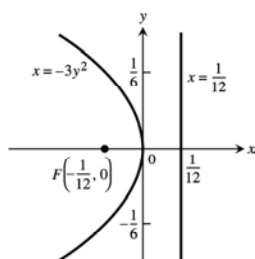

16. $x = 2y^2 \Rightarrow x = \frac{y^2}{(1/2)} \Rightarrow 4p = \frac{1}{2} \Rightarrow p = \frac{1}{8}$;
focus is $(\frac{1}{8}, 0)$, directrix is $x = -\frac{1}{8}$

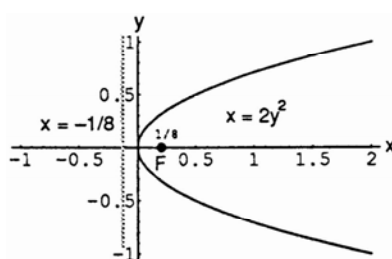

17. $16x^2 + 25y^2 = 400 \Rightarrow \frac{x^2}{25} + \frac{y^2}{16} = 1$
 $\Rightarrow c = \sqrt{a^2 - b^2} = \sqrt{25 - 16} = 3$

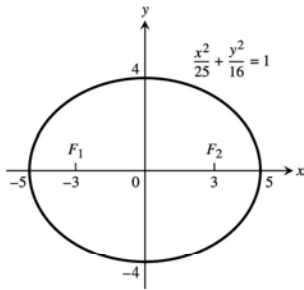

18. $7x^2 + 16y^2 = 112 \Rightarrow \frac{x^2}{16} + \frac{y^2}{7} = 1$
 $\Rightarrow c = \sqrt{a^2 - b^2} = \sqrt{16 - 7} = 3$

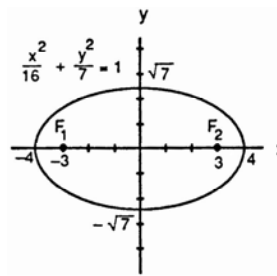

19. $2x^2 + y^2 = 2 \Rightarrow x^2 + \frac{y^2}{2} = 1$
 $\Rightarrow c = \sqrt{a^2 - b^2} = \sqrt{2 - 1} = 1$

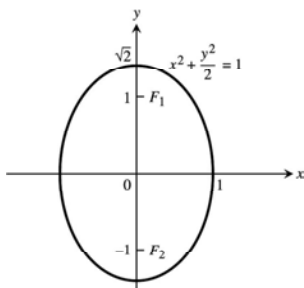

20. $2x^2 + y^2 = 4 \Rightarrow \frac{x^2}{2} + \frac{y^2}{4} = 1$
 $\Rightarrow c = \sqrt{a^2 - b^2} = \sqrt{4 - 2} = \sqrt{2}$

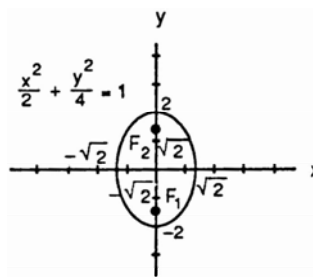

21. $3x^2 + 2y^2 = 6 \Rightarrow \frac{x^2}{2} + \frac{y^2}{3} = 1$
 $\Rightarrow c = \sqrt{a^2 - b^2} = \sqrt{3 - 2} = 1$

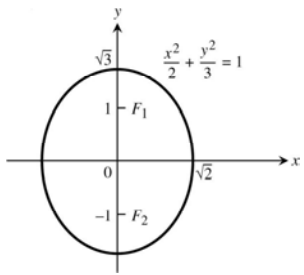

22. $9x^2 + 10y^2 = 90 \Rightarrow \frac{x^2}{10} + \frac{y^2}{9} = 1$
 $\Rightarrow c = \sqrt{a^2 - b^2} = \sqrt{10 - 9} = 1$

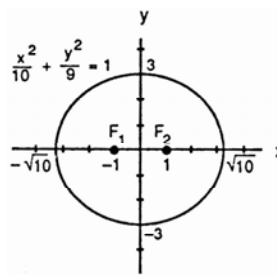

23. $6x^2 + 9y^2 = 54 \Rightarrow \frac{x^2}{9} + \frac{y^2}{6} = 1$
 $\Rightarrow c = \sqrt{a^2 - b^2} = \sqrt{9 - 6} = \sqrt{3}$

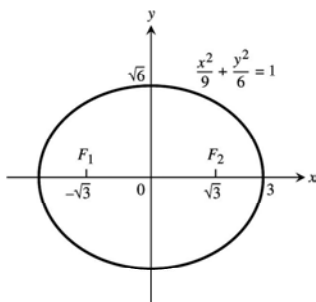

24. $169x^2 + 25y^2 = 4225 \Rightarrow \frac{x^2}{25} + \frac{y^2}{169} = 1$
 $\Rightarrow c = \sqrt{a^2 - b^2} = \sqrt{169 - 25} = 12$

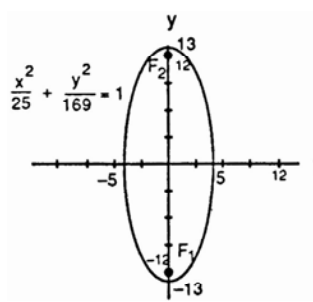

25. Foci: $(\pm\sqrt{2}, 0)$, Vertices: $(\pm 2, 0) \Rightarrow a = 2, c = \sqrt{2} \Rightarrow b^2 = a^2 - c^2 = 4 - (\sqrt{2})^2 = 2 \Rightarrow \frac{x^2}{4} + \frac{y^2}{2} = 1$

26. Foci: $(0, \pm 4)$, Vertices: $(0, \pm 5) \Rightarrow a = 5, c = 4 \Rightarrow b^2 = 25 - 16 = 9 \Rightarrow \frac{x^2}{9} + \frac{y^2}{25} = 1$

27. $x^2 - y^2 = 1 \Rightarrow c = \sqrt{a^2 + b^2} = \sqrt{1 + 1} = \sqrt{2}$;
asymptotes are $y = \pm x$

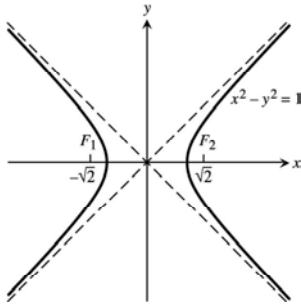

28. $9x^2 - 16y^2 = 144 \Rightarrow \frac{x^2}{16} - \frac{y^2}{9} = 1 \Rightarrow c = \sqrt{a^2 + b^2} = \sqrt{16 + 9} = 5$; asymptotes are $y = \pm \frac{3}{4}x$

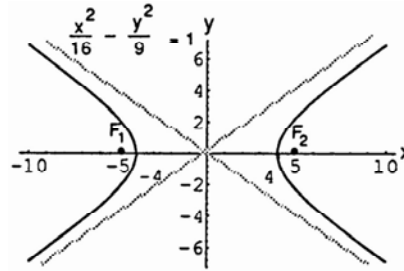

29. $y^2 - x^2 = 8 \Rightarrow \frac{y^2}{8} - \frac{x^2}{8} = 1 \Rightarrow c = \sqrt{a^2 + b^2} = \sqrt{8 + 8} = 4$; asymptotes are $y = \pm x$

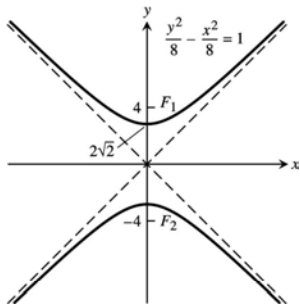

30. $y^2 - x^2 = 4 \Rightarrow \frac{y^2}{4} - \frac{x^2}{4} = 1 \Rightarrow c = \sqrt{a^2 + b^2} = \sqrt{4 + 4} = 2\sqrt{2}$; asymptotes are $y = \pm x$

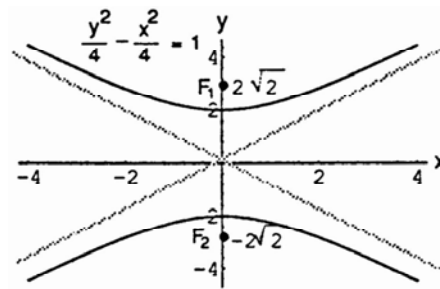

31. $8x^2 - 2y^2 = 16 \Rightarrow \frac{x^2}{2} - \frac{y^2}{8} = 1 \Rightarrow c = \sqrt{a^2 + b^2} = \sqrt{2 + 8} = \sqrt{10}$; asymptotes are $y = \pm 2x$

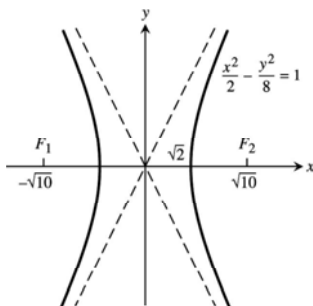

32. $y^2 - 3x^2 = 3 \Rightarrow \frac{y^2}{3} - x^2 = 1 \Rightarrow c = \sqrt{a^2 + b^2} = \sqrt{3 + 1} = 2$; asymptotes are $y = \pm\sqrt{3}x$

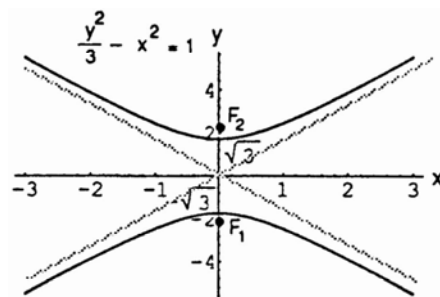

33. $8y^2 - 2x^2 = 16 \Rightarrow \frac{y^2}{2} - \frac{x^2}{8} = 1 \Rightarrow c = \sqrt{a^2 + b^2} = \sqrt{2+8} = \sqrt{10}$; asymptotes are $y = \pm \frac{x}{2}$

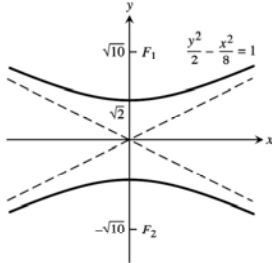

34. $64x^2 - 36y^2 = 2304 \Rightarrow \frac{x^2}{36} - \frac{y^2}{64} = 1 \Rightarrow c = \sqrt{a^2 + b^2} = \sqrt{36+64} = 10$; asymptotes are $y = \pm \frac{4}{3}x$

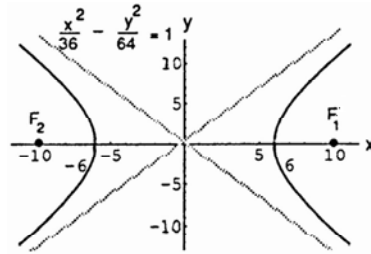

35. Foci: $(0, \pm\sqrt{2})$, Asymptotes: $y = \pm x \Rightarrow c = \sqrt{2}$ and $\frac{a}{b} = 1 \Rightarrow a = b \Rightarrow c^2 = a^2 + b^2 = 2a^2 \Rightarrow 2 = 2a^2 \Rightarrow a = 1 \Rightarrow b = 1 \Rightarrow y^2 - x^2 = 1$

36. Foci: $(\pm 2, 0)$, Asymptotes: $y = \pm \frac{1}{\sqrt{3}}x \Rightarrow c = 2$ and $\frac{b}{a} = \frac{1}{\sqrt{3}} \Rightarrow b = \frac{a}{\sqrt{3}} \Rightarrow c^2 = a^2 + b^2 = a^2 + \frac{a^2}{3} = \frac{4a^2}{3} \Rightarrow 4 = \frac{4a^2}{3} \Rightarrow a^2 = 3 \Rightarrow a = \sqrt{3} \Rightarrow b = 1 \Rightarrow \frac{x^2}{3} - y^2 = 1$

37. Vertices: $(\pm 3, 0)$, Asymptotes: $y = \pm \frac{4}{3}x \Rightarrow a = 3$ and $\frac{b}{a} = \frac{4}{3} \Rightarrow b = \frac{4}{3}(3) = 4 \Rightarrow \frac{x^2}{9} - \frac{y^2}{16} = 1$

38. Vertices: $(0, \pm 2)$, Asymptotes: $y = \pm \frac{1}{2}x \Rightarrow a = 2$ and $\frac{a}{b} = \frac{1}{2} \Rightarrow b = 2(2) = 4 \Rightarrow \frac{y^2}{4} - \frac{x^2}{16} = 1$

39. (a) $y^2 = 8x \Rightarrow 4p = 8 \Rightarrow p = 2 \Rightarrow$ directrix is $x = -2$, focus is $(2, 0)$, and vertex is $(0, 0)$; therefore the new directrix is $x = -1$, the new focus is $(3, -2)$, and the new vertex is $(1, -2)$

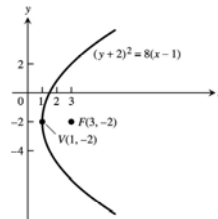

40. (a) $x^2 = -4y \Rightarrow 4p = 4 \Rightarrow p = 1 \Rightarrow$ directrix is $y = 1$, focus is $(0, -1)$ and vertex is $(0, 0)$; therefore the new directrix is $y = 4$, the new focus is $(-1, 2)$, and the new vertex is $(-1, 3)$

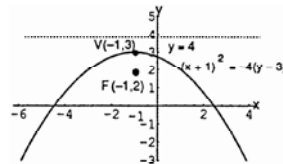

41. (a) $\frac{x^2}{16} + \frac{y^2}{9} = 1 \Rightarrow$ center is $(0, 0)$, vertices are $(-4, 0)$ and $(4, 0)$; $c = \sqrt{a^2 + b^2} = \sqrt{7} \Rightarrow$ foci are $(\sqrt{7}, 0)$ and $(-\sqrt{7}, 0)$; therefore the new center is $(4, 3)$, the new vertices are $(0, 3)$ and $(8, 3)$, and the new foci are $(4 \pm \sqrt{7}, 3)$

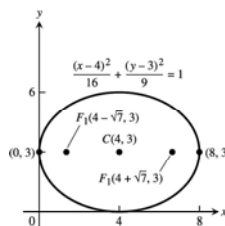

42. (a) $\frac{x^2}{9} + \frac{y^2}{25} = 1 \Rightarrow$ center is $(0, 0)$, vertices are $(0, 5)$ and $(0, -5)$; $c = \sqrt{a^2 - b^2} = \sqrt{16} = 4 \Rightarrow$ foci are $(0, 4)$ and $(0, -4)$; therefore the new center is $(-3, -2)$, the new vertices are $(-3, 3)$ and $(-3, -7)$, and the new foci are $(-3, 2)$ and $(-3, -6)$

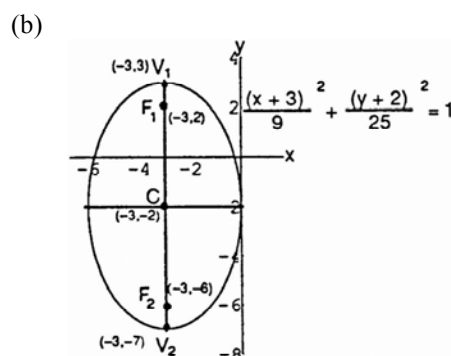

43. (a) $\frac{x^2}{16} - \frac{y^2}{9} = 1 \Rightarrow$ center is $(0, 0)$, vertices are $(-4, 0)$ and $(4, 0)$, and the asymptotes are $\frac{x}{4} = \pm \frac{y}{3}$ or $y = \pm \frac{3x}{4}$; $c = \sqrt{a^2 + b^2} = \sqrt{25} = 5 \Rightarrow$ foci are $(-5, 0)$ and $(5, 0)$; therefore the new center is $(2, 0)$, the new vertices are $(-2, 0)$ and $(6, 0)$, the new foci are $(-3, 0)$ and $(7, 0)$, and the new asymptotes are $y = \pm \frac{3(x-2)}{4}$

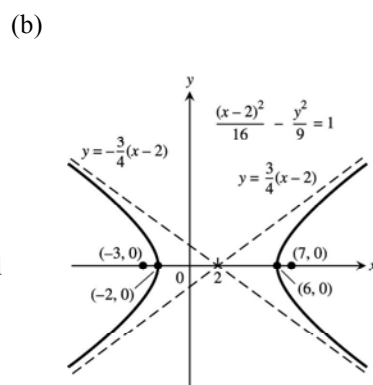

44. (a) $\frac{y^2}{4} - \frac{x^2}{5} = 1 \Rightarrow$ center is $(0, 0)$, vertices are $(0, -2)$ and $(0, 2)$, and the asymptotes are $\frac{y}{2} = \pm \frac{x}{\sqrt{5}}$ or $y = \pm \frac{2x}{\sqrt{5}}$; $c = \sqrt{a^2 + b^2} = \sqrt{9} = 3 \Rightarrow$ foci are $(0, 3)$ and $(0, -3)$; therefore the new center is $(0, -2)$, the new vertices are $(0, -4)$ and $(0, 0)$, the new foci are $(0, 1)$ and $(0, -5)$, and the new asymptotes are $y + 2 = \pm \frac{2x}{\sqrt{5}}$

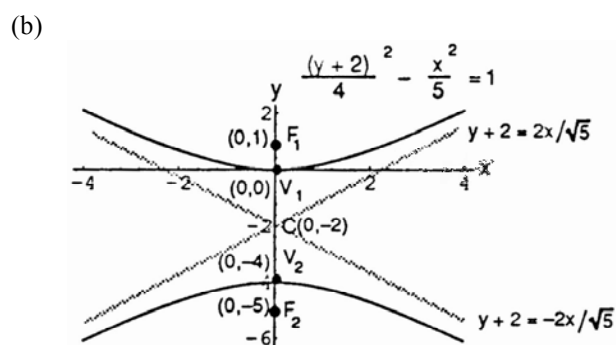

45. $y^2 = 4x \Rightarrow 4p = 4 \Rightarrow p = 1 \Rightarrow$ focus is $(1, 0)$, directrix is $x = -1$, and vertex is $(0, 0)$; therefore the new vertex is $(-2, -3)$, the new focus is $(-1, -3)$, and the new directrix is $x = -3$; the new equation is $(y+3)^2 = 4(x+2)$
46. $y^2 = -12x \Rightarrow 4p = 12 \Rightarrow p = 3 \Rightarrow$ focus is $(-3, 0)$, directrix is $x = 3$, and vertex is $(0, 0)$; therefore the new vertex is $(4, 3)$, the new focus is $(1, 3)$, and the new directrix is $x = 7$; the new equation is $(y-3)^2 = -12(x-4)$
47. $x^2 = 8y \Rightarrow 4p = 8 \Rightarrow p = 2 \Rightarrow$ focus is $(0, 2)$, directrix is $y = -2$ and vertex is $(0, 0)$; therefore the new vertex is $(1, -7)$, the new focus is $(1, -5)$, and the new directrix is $y = -9$; the new equation is $(x-1)^2 = 8(y+7)$

48. $x^2 = 6y \Rightarrow 4p = 6 \Rightarrow p = \frac{3}{2} \Rightarrow$ focus is $(0, \frac{3}{2})$, directrix is $y = -\frac{3}{2}$, and vertex is $(0, 0)$; therefore the new vertex is $(-3, -2)$, the new focus is $(-3, -\frac{1}{2})$, and the new directrix is $y = -\frac{7}{2}$; the new equation is $(x+3)^2 = 6(y+2)$
49. $\frac{x^2}{6} + \frac{y^2}{9} = 1 \Rightarrow$ center is $(0, 0)$, vertices are $(0, 3)$ and $(0, -3)$; $c = \sqrt{a^2 - b^2} = \sqrt{9-6} = \sqrt{3} \Rightarrow$ foci are $(0, \sqrt{3})$ and $(0, -\sqrt{3})$; therefore the new center is $(-2, -1)$, the new vertices are $(-2, 2)$ and $(-2, -4)$, and the new foci are $(-2, -1 \pm \sqrt{3})$; the new equation is $\frac{(x+2)^2}{6} + \frac{(y+1)^2}{9} = 1$
50. $\frac{x^2}{2} + y^2 = 1 \Rightarrow$ center is $(0, 0)$, vertices are $(\sqrt{2}, 0)$ and $(-\sqrt{2}, 0)$; $c = \sqrt{a^2 - b^2} = \sqrt{2-1} = 1 \Rightarrow$ foci are $(-1, 0)$ and $(1, 0)$; therefore the new center is $(3, 4)$, the new vertices are $(3 \pm \sqrt{2}, 4)$, and the new foci are $(2, 4)$ and $(4, 4)$; the new equation is $\frac{(x-3)^2}{2} + (y-4)^2 = 1$
51. $\frac{x^2}{3} + \frac{y^2}{2} = 1 \Rightarrow$ center is $(0, 0)$, vertices are $(\sqrt{3}, 0)$ and $(-\sqrt{3}, 0)$; $c = \sqrt{a^2 - b^2} = \sqrt{3-2} = 1 \Rightarrow$ foci are $(-1, 0)$ and $(1, 0)$; therefore the new center is $(2, 3)$, the new vertices are $(2 \pm \sqrt{3}, 3)$, and the new foci are $(1, 3)$ and $(3, 3)$; the new equation is $\frac{(x-2)^2}{3} + \frac{(y-3)^2}{2} = 1$
52. $\frac{x^2}{16} + \frac{y^2}{25} = 1 \Rightarrow$ center is $(0, 0)$, vertices are $(0, 5)$ and $(0, -5)$; $c = \sqrt{a^2 - b^2} = \sqrt{25-16} = 3 \Rightarrow$ foci are $(0, 3)$ and $(0, -3)$; therefore the new center is $(-4, -5)$, the new vertices are $(-4, 0)$ and $(-4, -10)$, and the new foci are $(-4, -2)$ and $(-4, -8)$; the new equation is $\frac{(x+4)^2}{16} + \frac{(y+5)^2}{25} = 1$
53. $\frac{x^2}{4} - \frac{y^2}{5} = 1 \Rightarrow$ center is $(0, 0)$, vertices are $(2, 0)$ and $(-2, 0)$; $c = \sqrt{a^2 + b^2} = \sqrt{4+5} = 3 \Rightarrow$ foci are $(3, 0)$ and $(-3, 0)$; the asymptotes are $\pm \frac{x}{2} = \pm \frac{y}{\sqrt{5}} \Rightarrow y = \pm \frac{\sqrt{5}x}{2}$; therefore the new center is $(2, 2)$, the new vertices are $(4, 2)$ and $(0, 2)$, and the new foci are $(5, 2)$ and $(-1, 2)$; the new asymptotes are $y-2 = \pm \frac{\sqrt{5}(x-2)}{2}$; the new equation is $\frac{(x-2)^2}{4} - \frac{(y-2)^2}{5} = 1$
54. $\frac{x^2}{16} - \frac{y^2}{9} = 1 \Rightarrow$ center is $(0, 0)$, vertices are $(4, 0)$ and $(-4, 0)$; $c = \sqrt{a^2 + b^2} = \sqrt{16+9} = 5 \Rightarrow$ foci are $(-5, 0)$ and $(5, 0)$; the asymptotes are $\pm \frac{x}{4} = \pm \frac{y}{3} \Rightarrow y = \pm \frac{3x}{4}$; therefore the new center is $(-5, -1)$, the new vertices are $(-1, -1)$ and $(-9, -1)$, and the new foci are $(-10, -1)$ and $(0, -1)$; the new asymptotes are $y+1 = \pm \frac{3(x+5)}{4}$; the new equation is $\frac{(x+5)^2}{16} - \frac{(y+1)^2}{9} = 1$
55. $y^2 - x^2 = 1 \Rightarrow$ center is $(0, 0)$, vertices are $(0, 1)$ and $(0, -1)$; $c = \sqrt{a^2 + b^2} = \sqrt{1+1} = \sqrt{2} \Rightarrow$ foci are $(0, \pm\sqrt{2})$; the asymptotes are $y = \pm x$; therefore the new center is $(-1, -1)$, the new vertices are $(-1, 0)$ and $(-1, -2)$, and the new foci are $(-1, -1 \pm \sqrt{2})$; the new asymptotes are $y+1 = \pm(x+1)$; the new equation is $(y+1)^2 - (x+1)^2 = 1$

56. $\frac{y^2}{3} - x^2 = 1 \Rightarrow$ center is $(0, 0)$, vertices are $(0, \sqrt{3})$ and $(0, -\sqrt{3})$; $c = \sqrt{a^2 + b^2} = \sqrt{3+1} = 2 \Rightarrow$ foci are $(0, 2)$ and $(0, -2)$; the asymptotes are $\pm x = \frac{y}{\sqrt{3}} \Rightarrow y = \pm\sqrt{3}x$; therefore the new center is $(1, 3)$, the new vertices are $(1, 3 \pm \sqrt{3})$, and the new foci are $(1, 5)$ and $(1, 1)$; the new asymptotes are $y - 3 = \pm\sqrt{3}(x - 1)$; the new equation is $\frac{(y-3)^2}{3} - (x-1)^2 = 1$
57. $x^2 + 4x + y^2 = 12 \Rightarrow x^2 + 4x + 4 + y^2 = 12 + 4 \Rightarrow (x+2)^2 + y^2 = 16$; this is a circle: center at $C(-2, 0)$, $a = 4$
58. $2x^2 + 2y^2 - 28x + 12y + 114 = 0 \Rightarrow x^2 - 14x + 49 + y^2 + 6y + 9 = -57 + 49 + 9 \Rightarrow (x-7)^2 + (y+3)^2 = 1$; this is a circle: center at $C(7, -3)$, $a = 1$
59. $x^2 + 2x + 4y - 3 = 0 \Rightarrow x^2 + 2x + 1 = -4y + 3 + 1 \Rightarrow (x+1)^2 = -4(y-1)$; this is a parabola: $V(-1, 1)$, $F(-1, 0)$
60. $y^2 - 4y - 8x - 12 = 0 \Rightarrow y^2 - 4y + 4 = 8x + 12 + 4 \Rightarrow (y-2)^2 = 8(x+2)$; this is a parabola: $V(-2, 2)$, $F(0, 2)$
61. $x^2 + 5y^2 + 4x = 1 \Rightarrow x^2 + 4x + 4 + 5y^2 = 5 \Rightarrow (x+2)^2 + 5y^2 = 5 \Rightarrow \frac{(x+2)^2}{5} + y^2 = 1$; this is an ellipse: the center is $(-2, 0)$, the vertices are $(-2 \pm \sqrt{5}, 0)$; $c = \sqrt{a^2 - b^2} = \sqrt{5-1} = 2 \Rightarrow$ the foci are $(-4, 0)$ and $(0, 0)$
62. $9x^2 + 6y^2 + 36y = 0 \Rightarrow 9x^2 + 6(y^2 + 6y + 9) = 54 \Rightarrow 9x^2 + 6(y+3)^2 = 54 \Rightarrow \frac{x^2}{6} + \frac{(y+3)^2}{9} = 1$; this is an ellipse: the center is $(0, -3)$ the vertices are $(0, 0)$ and $(0, -6)$; $c = \sqrt{a^2 - b^2} = \sqrt{9-6} = \sqrt{3} \Rightarrow$ the foci are $(0, -3 \pm \sqrt{3})$
63. $x^2 + 2y^2 - 2x - 4y = -1 \Rightarrow x^2 - 2x + 1 + 2(y^2 - 2y + 1) = 2 \Rightarrow (x-1)^2 + 2(y-1)^2 = 2 \Rightarrow \frac{(x-1)^2}{2} + (y-1)^2 = 1$; this is an ellipse: the center is $(1, 1)$, the vertices are $(1 \pm \sqrt{2}, 1)$; $c = \sqrt{a^2 - b^2} = \sqrt{2-1} = 1 \Rightarrow$ the foci are $(2, 1)$ and $(0, 1)$
64. $4x^2 + y^2 + 8x - 2y = -1 \Rightarrow 4(x^2 + 2x + 1) + y^2 - 2y + 1 = 4 \Rightarrow 4(x+1)^2 + (y-1)^2 = 4 \Rightarrow (x+1)^2 + \frac{(y-1)^2}{4} = 1$; this is an ellipse: the center is $(-1, 1)$ the vertices are $(-1, 3)$ and $(-1, -1)$; $c = \sqrt{a^2 - b^2} = \sqrt{4-1} = \sqrt{3} \Rightarrow$ the foci are $(-1, 1 \pm \sqrt{3})$
65. $x^2 - y^2 - 2x + 4y = 4 \Rightarrow x^2 - 2x + 1 - (y^2 - 4y + 4) = 1 \Rightarrow (x-1)^2 - (y-2)^2 = 1$; this is a hyperbola: the center is $(1, 2)$, the vertices are $(2, 2)$ and $(0, 2)$; $c = \sqrt{a^2 + b^2} = \sqrt{1+1} = \sqrt{2} \Rightarrow$ the foci are $(1 \pm \sqrt{2}, 2)$; the asymptotes are $y - 2 = \pm(x - 1)$

66. $x^2 - y^2 + 4x - 6y = 6 \Rightarrow x^2 + 4x + 4 - (y^2 + 6y + 9) = 1 \Rightarrow (x+2)^2 - (y+3)^2 = 1$; this is a hyperbola: the center is $(-2, -3)$, the vertices are $(-1, -3)$ and $(-3, -3)$; $c = \sqrt{a^2 + b^2} = \sqrt{1+1} = \sqrt{2} \Rightarrow$ the foci are $(-2 \pm \sqrt{2}, -3)$; the asymptotes are $y + 3 = \pm(x + 2)$

67. $2x^2 - y^2 + 6y = 3 \Rightarrow 2x^2 - (y^2 - 6y + 9) = -6 \Rightarrow \frac{(y-3)^2}{6} - \frac{x^2}{3} = 1$; this is a hyperbola: the center is $(0, 3)$, the vertices are $(0, 3 \pm \sqrt{6})$; $c = \sqrt{a^2 + b^2} = \sqrt{6+3} = 3 \Rightarrow$ the foci are $(0, 6)$ and $(0, 0)$; the asymptotes are $\frac{y-3}{\sqrt{6}} = \pm \frac{x}{\sqrt{3}} \Rightarrow y = \pm\sqrt{2}x + 3$

68. $y^2 - 4x^2 + 16x = 24 \Rightarrow y^2 - 4(x^2 - 4x + 4) = 8 \Rightarrow \frac{y^2}{8} - \frac{(x-2)^2}{2} = 1$; this is a hyperbola: the center is $(2, 0)$, the vertices are $(2, \pm\sqrt{8})$; $c = \sqrt{a^2 + b^2} = \sqrt{8+2} = \sqrt{10} \Rightarrow$ the foci are $(2, \pm\sqrt{10})$; the asymptotes are $\frac{y}{\sqrt{8}} = \pm \frac{x-2}{\sqrt{2}} \Rightarrow y = \pm 2(x-2)$

69. (a) $y^2 = kx \Rightarrow x = \frac{y^2}{k}$; the volume of the solid formed by revolving R_1 about the y -axis is

$$V_1 = \int_0^{\sqrt{kx}} \pi \left(\frac{y^2}{k} \right)^2 dy = \frac{\pi}{k^2} \int_0^{\sqrt{kx}} y^4 dy = \frac{\pi x^2 \sqrt{kx}}{5};$$

the volume of the right circular cylinder formed by revolving PQ about the y -axis is

$$V_2 = \pi x^2 \sqrt{kx} \Rightarrow \text{the volume of the solid formed by revolving } R_2 \text{ about the } y\text{-axis is } V_3 = V_2 - V_1 = \frac{4\pi x^2 \sqrt{kx}}{5}.$$

Therefore we can see the ratio of V_3 to V_1 is 4:1.

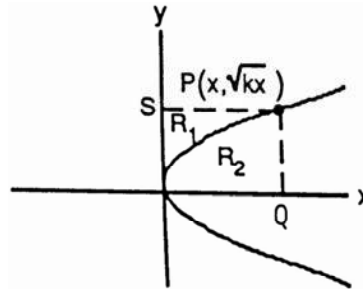

(b) The volume of the solid formed by revolving R_2 about the x -axis is $V_1 = \int_0^x \pi (\sqrt{kt})^2 dt = \pi k \int_0^x t dt = \frac{\pi kx^2}{2}$. The volume of the right circular cylinder formed by revolving PS about the x -axis is $V_2 = \pi (\sqrt{kx})^2 x = \pi kx^2 \Rightarrow$ the volume of the solid formed by revolving R_1 about the x -axis is $V_3 = V_2 - V_1 = \pi kx^2 - \frac{\pi kx^2}{2} = \frac{\pi kx^2}{2}$. Therefore the ratio of V_3 to V_1 is 1:1.

70. $y = \int \frac{w}{H} x dx = \frac{w}{H} \left(\frac{x^2}{2} \right) + C = \frac{wx^2}{2H} + C$; $y = 0$ when $x = 0 \Rightarrow 0 = \frac{w(0)^2}{2H} + C \Rightarrow C = 0$; therefore $y = \frac{wx^2}{2H}$ is the equation of the cable's curve

71. $x^2 = 4py$ and $y = p \Rightarrow x^2 = 4p^2 \Rightarrow x = \pm 2p$. Therefore the line $y = p$ cuts the parabola at points $(-2p, p)$ and $(2p, p)$, and these points are $\sqrt{[2p - (-2p)]^2 + (p - p)^2} = 4p$ units apart.

$$72. \lim_{x \rightarrow \infty} \left(\frac{b}{a}x - \frac{b}{a}\sqrt{x^2 - a^2} \right) = \frac{b}{a} \lim_{x \rightarrow \infty} \left(x - \sqrt{x^2 - a^2} \right) = \frac{b}{a} \lim_{x \rightarrow \infty} \left[\frac{(x - \sqrt{x^2 - a^2})(x + \sqrt{x^2 - a^2})}{x + \sqrt{x^2 - a^2}} \right] = \frac{b}{a} \lim_{x \rightarrow \infty} \left[\frac{x^2 - (x^2 - a^2)}{x + \sqrt{x^2 - a^2}} \right]$$

$$= \frac{b}{a} \lim_{x \rightarrow \infty} \left[\frac{a^2}{x + \sqrt{x^2 - a^2}} \right] = 0$$

73. Let $y = \sqrt{1 - \frac{x^2}{4}}$ on the interval $0 \leq x \leq 2$. The area of the inscribed rectangle is given by

$$A(x) = 2x \left(2\sqrt{1 - \frac{x^2}{4}} \right) = 4x\sqrt{1 - \frac{x^2}{4}} \quad (\text{since the length is } 2x \text{ and the height is } 2y) \Rightarrow A'(x) = 4\sqrt{1 - \frac{x^2}{4}} - \frac{x^2}{\sqrt{1 - \frac{x^2}{4}}}$$

$$\text{Thus } A'(x) = 0 \Rightarrow 4\sqrt{1 - \frac{x^2}{4}} - \frac{x^2}{\sqrt{1 - \frac{x^2}{4}}} = 0 \Rightarrow 4\left(1 - \frac{x^2}{4}\right) - x^2 = 0 \Rightarrow x^2 = 2 \Rightarrow x = \sqrt{2} \quad (\text{only the positive square}$$

root lies in the interval). Since $A(0) = A(2) = 0$ we have that $A(\sqrt{2}) = 4$ is the maximum area when the length is $2\sqrt{2}$ and the height is $\sqrt{2}$.

74. (a) Around the x -axis: $9x^2 + 4y^2 = 36 \Rightarrow y^2 = 9 - \frac{9}{4}x^2 \Rightarrow y = \pm\sqrt{9 - \frac{9}{4}x^2}$ and we use the positive root

$$\Rightarrow V = 2 \int_0^2 \pi \left(\sqrt{9 - \frac{9}{4}x^2} \right)^2 dx = 2 \int_0^2 \pi \left(9 - \frac{9}{4}x^2 \right) dx = 2\pi \left[9x - \frac{3}{4}x^3 \right]_0^2 = 24\pi$$

(b) Around the y -axis: $9x^2 + 4y^2 = 36 \Rightarrow x^2 = 4 - \frac{4}{9}y^2 \Rightarrow x = \pm\sqrt{4 - \frac{4}{9}y^2}$ and we use the positive root

$$\Rightarrow V = 2 \int_0^3 \pi \left(\sqrt{4 - \frac{4}{9}y^2} \right)^2 dy = 2 \int_0^3 \pi \left(4 - \frac{4}{9}y^2 \right) dy = 2\pi \left[4y - \frac{4}{27}y^3 \right]_0^3 = 16\pi$$

75. $9x^2 - 4y^2 = 36 \Rightarrow y^2 = \frac{9x^2 - 36}{4} \Rightarrow y = \pm\frac{3}{2}\sqrt{x^2 - 4}$ on the interval $2 \leq x \leq 4 \Rightarrow V = \int_2^4 \pi \left(\frac{3}{2}\sqrt{x^2 - 4} \right)^2 dx$

$$= \frac{9\pi}{4} \int_2^4 (x^2 - 4) dx = \frac{9\pi}{4} \left[\frac{x^3}{3} - 4x \right]_2^4 = \frac{9\pi}{4} \left[\left(\frac{64}{3} - 16 \right) - \left(\frac{8}{3} - 8 \right) \right] = \frac{9\pi}{4} \left(\frac{56}{3} - 8 \right) = \frac{3\pi}{4} (56 - 24) = 24\pi$$

76. Let $P_1(-p, y_1)$ be any point on $x = -p$, and let $P(x, y)$ be a point where a tangent intersects $y^2 = 4px$.

Now $y^2 = 4px \Rightarrow 2y \frac{dy}{dx} = 4p \Rightarrow \frac{dy}{dx} = \frac{2p}{y}$; then the slope of a tangent line from P_1 is $\frac{y - y_1}{x - (-p)} = \frac{dy}{dx} = \frac{2p}{y}$

$$\Rightarrow y^2 - yy_1 = 2px + 2p^2. \text{ Since } x = \frac{y^2}{4p}, \text{ we have } y^2 - yy_1 = 2p \left(\frac{y^2}{4p} \right) + 2p^2 \Rightarrow y^2 - yy_1 = \frac{1}{2}y^2 + 2p^2$$

$$\Rightarrow \frac{1}{2}y^2 - yy_1 - 2p^2 = 0 \Rightarrow y = \frac{2y_1 \pm \sqrt{4y_1^2 + 16p^2}}{2} = y_1 \pm \sqrt{y_1^2 + 4p^2}. \text{ Therefore the slopes of the two tangents from}$$

$$P_1 \text{ are } m_1 = \frac{2p}{y_1 + \sqrt{y_1^2 + 4p^2}} \text{ and } m_2 = \frac{2p}{y_1 - \sqrt{y_1^2 + 4p^2}} \Rightarrow m_1 m_2 = \frac{4p^2}{y_1^2 - (y_1^2 + 4p^2)} = -1 \Rightarrow \text{the lines are perpendicular}$$

77. $(x-2)^2 + (y-1)^2 = 5 \Rightarrow 2(x-2) + 2(y-1) \frac{dy}{dx} = 0 \Rightarrow \frac{dy}{dx} = -\frac{x-2}{y-1}$; $y = 0 \Rightarrow (x-2)^2 + (0-1)^2 = 5 \Rightarrow (x-2)^2 = 4$

$$\Rightarrow x = 4 \text{ or } x = 0 \Rightarrow \text{the circle crosses the } x\text{-axis at } (4, 0) \text{ and } (0, 0); \quad x = 0 \Rightarrow (0-2)^2 + (y-1)^2 = 5$$

$$\Rightarrow (y-1)^2 = 1 \Rightarrow y = 2 \text{ or } y = 0 \Rightarrow \text{the circle crosses the } y\text{-axis at } (0, 2) \text{ and } (0, 0).$$

At $(4, 0)$: $\frac{dy}{dx} = -\frac{4-2}{0-1} = 2 \Rightarrow$ the tangent line is $y = 2(x-4)$ or $y = 2x - 8$

At (0, 0): $\frac{dy}{dx} = -\frac{0-2}{0-1} = -2 \Rightarrow$ the tangent line is $y = -2x$

At (0, 2): $\frac{dy}{dx} = -\frac{0-2}{2-1} = 2 \Rightarrow$ the tangent line is $y - 2 = 2x$ or $y = 2x + 2$

78. $x^2 - y^2 = 1 \Rightarrow x = \pm\sqrt{1+y^2}$ on the interval $-3 \leq y \leq 3 \Rightarrow V = \int_{-3}^3 \pi \left(\sqrt{1+y^2}\right)^2 dy = 2 \int_0^3 \pi \left(\sqrt{1+y^2}\right)^2 dy$
 $= 2\pi \int_0^3 (1+y^2) dy = 2\pi \left[y + \frac{y^3}{3} \right]_0^3 = 24\pi$

79. Let $y = \sqrt{16 - \frac{16}{9}x^2}$ on the interval $-3 \leq x \leq 3$. Since the plate is symmetric about the y -axis, $\bar{x} = 0$.

For a vertical strip: $(\tilde{x}, \tilde{y}) = \left(x, \frac{\sqrt{16 - \frac{16}{9}x^2}}{2}\right)$, length $= \sqrt{16 - \frac{16}{9}x^2}$, width $= dx \Rightarrow$ area $= dA = \sqrt{16 - \frac{16}{9}x^2} dx$

\Rightarrow mass $= dm = \delta dA = \delta \sqrt{16 - \frac{16}{9}x^2} dx$.

Moment of the strip about the x -axis: $\tilde{y} dm = \frac{\sqrt{16 - \frac{16}{9}x^2}}{2} \left(\delta \sqrt{16 - \frac{16}{9}x^2}\right) dx = \delta \left(8 - \frac{8}{9}x^2\right) dx$ so the moment of

the plate about the x -axis is $M_x = \int \tilde{y} dm = \int_{-3}^3 \delta \left(8 - \frac{8}{9}x^2\right) dx = \delta \left[8x - \frac{8}{27}x^3\right]_{-3}^3 = 32\delta$; also the mass of the

plate is $M = \int_{-3}^3 \delta \sqrt{16 - \frac{16}{9}x^2} dx = \int_{-3}^3 4\delta \sqrt{1 - \left(\frac{1}{3}x\right)^2} dx$; $\left[u = \frac{x}{3} \Rightarrow 3 du = dx; x = -3 \Rightarrow u = -1, x = 3 \Rightarrow u = 1\right]$

$\rightarrow 4\delta \int_{-1}^1 3\sqrt{1-u^2} du = 12\delta \int_{-1}^1 \sqrt{1-u^2} du = 12\delta \left[\frac{1}{2} \left(u\sqrt{1-u^2} + \sin^{-1} u\right)\right]_{-1}^1 = 6\pi\delta \Rightarrow \bar{y} = \frac{M_x}{M} = \frac{32\delta}{6\pi\delta} = \frac{16}{3\pi}$.

Therefore the center of mass is $\left(0, \frac{16}{3\pi}\right)$.

80. $y = \sqrt{x^2 + 1} \Rightarrow \frac{dy}{dx} = \frac{1}{2}(x^2 + 1)^{-1/2} (2x) = \frac{x}{\sqrt{x^2 + 1}} \Rightarrow \left(\frac{dy}{dx}\right)^2 = \frac{x^2}{x^2 + 1} \Rightarrow \sqrt{1 + \left(\frac{dy}{dx}\right)^2} = \sqrt{1 + \frac{x^2}{x^2 + 1}} = \sqrt{\frac{2x^2 + 1}{x^2 + 1}}$

$\Rightarrow S = \int_0^{\sqrt{2}} 2\pi y \sqrt{1 + \left(\frac{dy}{dx}\right)^2} dx = \int_0^{\sqrt{2}} 2\pi \sqrt{x^2 + 1} \sqrt{\frac{2x^2 + 1}{x^2 + 1}} dx = \int_0^{\sqrt{2}} 2\pi \sqrt{2x^2 + 1} dx$; $\left[\begin{array}{l} u = \sqrt{2}x \\ du = \sqrt{2}dx \end{array} \right]$

$\rightarrow \frac{2\pi}{\sqrt{2}} \int_0^2 \sqrt{u^2 + 1} du = \frac{2\pi}{\sqrt{2}} \left[\frac{1}{2} \left(u\sqrt{u^2 + 1} + \ln(u + \sqrt{u^2 + 1}) \right) \right]_0^2 = \frac{\pi}{\sqrt{2}} [2\sqrt{5} + \ln(2 + \sqrt{5})]$

81. (a) $\tan \beta = m_L \Rightarrow \tan \beta = f'(x_0)$ where $f(x) = \sqrt{4px}$;

$f'(x) = \frac{1}{2}(4px)^{-1/2} (4p) = \frac{2p}{\sqrt{4px}}$

$\Rightarrow f'(x_0) = \frac{2p}{\sqrt{4px_0}} = \frac{2p}{y_0} \Rightarrow \tan \beta = \frac{2p}{y_0}$.

(b) $\tan \phi = m_{FP} = \frac{y_0 - 0}{x_0 - p} = \frac{y_0}{x_0 - p}$

(c) $\tan \alpha = \frac{\tan \phi - \tan \beta}{1 + \tan \phi \tan \beta} = \frac{\left(\frac{y_0}{x_0 - p} - \frac{2p}{y_0}\right)}{1 + \left(\frac{y_0}{x_0 - p}\right)\left(\frac{2p}{y_0}\right)}$

$= \frac{y_0^2 - 2p(x_0 - p)}{y_0(x_0 - p + 2p)} = \frac{4px_0 - 2px_0 + 2p^2}{y_0(x_0 + p)} = \frac{2p(x_0 + p)}{y_0(x_0 + p)} = \frac{2p}{y_0}$

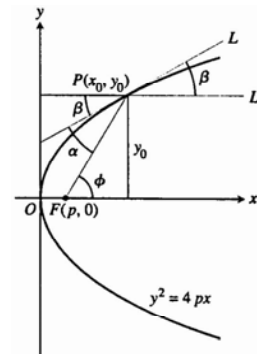

11.7 CONICS IN POLAR COORDINATES

1. $16x^2 + 25y^2 = 400 \Rightarrow \frac{x^2}{25} + \frac{y^2}{16} = 1 \Rightarrow c = \sqrt{a^2 - b^2}$
 $= \sqrt{25 - 16} = 3 \Rightarrow e = \frac{c}{a} = \frac{3}{5}; F(\pm 3, 0);$ directrices are
 $x = 0 \pm \frac{a}{e} = \pm \frac{5}{(\frac{3}{5})} = \pm \frac{25}{3}$

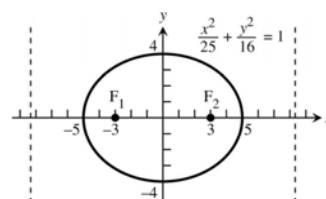

2. $7x^2 + 16y^2 = 112 \Rightarrow \frac{x^2}{16} + \frac{y^2}{7} = 1 \Rightarrow c = \sqrt{a^2 - b^2}$
 $= \sqrt{16 - 7} = 3 \Rightarrow e = \frac{c}{a} = \frac{3}{4}; F(\pm 3, 0);$
 directrices are $x = 0 \pm \frac{a}{e} = \pm \frac{4}{(\frac{3}{4})} = \pm \frac{16}{3}$

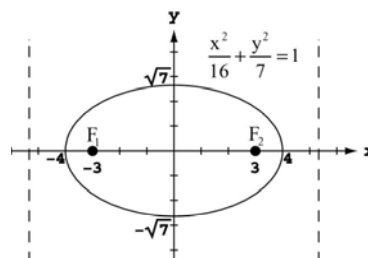

3. $2x^2 + y^2 = 2 \Rightarrow x^2 + \frac{y^2}{2} = 1 \Rightarrow c = \sqrt{a^2 - b^2}$
 $= \sqrt{2 - 1} = 1 \Rightarrow e = \frac{c}{a} = \frac{1}{\sqrt{2}}; F(0, \pm 1);$
 directrices are $y = 0 \pm \frac{a}{e} = \pm \frac{\sqrt{2}}{(\frac{1}{\sqrt{2}})} = \pm 2$

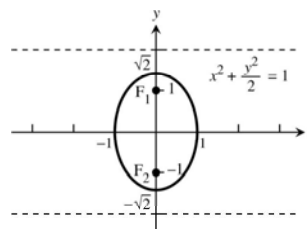

4. $2x^2 + y^2 = 4 \Rightarrow \frac{x^2}{2} + \frac{y^2}{4} = 1 \Rightarrow c = \sqrt{a^2 - b^2}$
 $= \sqrt{4 - 2} = \sqrt{2} \Rightarrow e = \frac{c}{a} = \frac{\sqrt{2}}{2}; F(0, \pm \sqrt{2});$
 directrices are $y = 0 \pm \frac{a}{e} = \pm \frac{2}{(\frac{\sqrt{2}}{2})} = \pm 2\sqrt{2}$

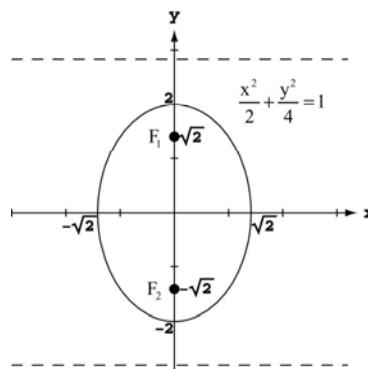

5. $3x^2 + 2y^2 = 6 \Rightarrow \frac{x^2}{2} + \frac{y^2}{3} = 1 \Rightarrow c = \sqrt{a^2 - b^2}$
 $= \sqrt{3 - 2} = 1 \Rightarrow e = \frac{c}{a} = \frac{1}{\sqrt{3}}; F(0, \pm 1);$
 directrices are $y = 0 \pm \frac{a}{e} = \pm \frac{\sqrt{3}}{(\frac{1}{\sqrt{3}})} = \pm 3$

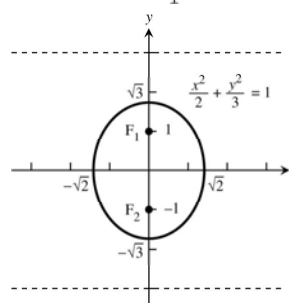

6. $9x^2 + 10y^2 = 90 \Rightarrow \frac{x^2}{10} + \frac{y^2}{9} = 1 \Rightarrow c = \sqrt{a^2 - b^2}$
 $= \sqrt{10 - 9} = 1 \Rightarrow e = \frac{c}{a} = \frac{1}{\sqrt{10}}; F(\pm 1, 0);$
 directrices are $x = 0 \pm \frac{a}{e} = \pm \frac{\sqrt{10}}{\left(\frac{1}{\sqrt{10}}\right)} = \pm 10$

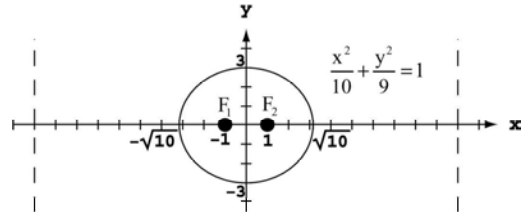

7. $6x^2 + 9y^2 = 54 \Rightarrow \frac{x^2}{9} + \frac{y^2}{6} = 1 \Rightarrow c = \sqrt{a^2 - b^2}$
 $= \sqrt{9 - 6} = \sqrt{3} \Rightarrow e = \frac{c}{a} = \frac{\sqrt{3}}{3}; F(\pm\sqrt{3}, 0);$
 directrices are $x = 0 \pm \frac{a}{e} = \pm \frac{3}{\left(\frac{\sqrt{3}}{3}\right)} = \pm 3\sqrt{3}$

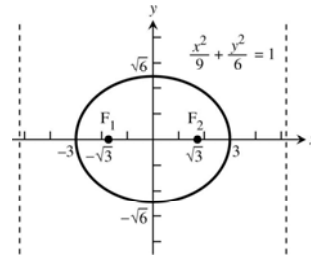

8. $169x^2 + 25y^2 = 4225 \Rightarrow \frac{x^2}{25} + \frac{y^2}{169} = 1 \Rightarrow c = \sqrt{a^2 - b^2}$
 $= \sqrt{169 - 25} = 12 \Rightarrow e = \frac{c}{a} = \frac{12}{13};$
 directrices are $y = 0 \pm \frac{a}{e} = \pm \frac{13}{\left(\frac{12}{13}\right)} = \pm \frac{169}{12}$

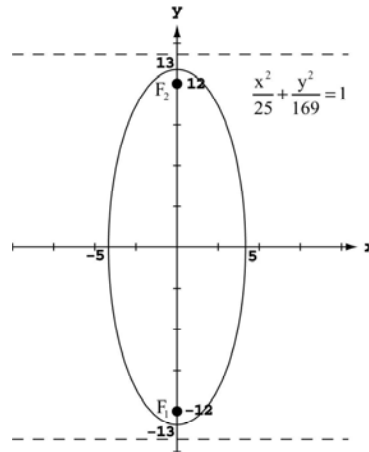

9. Foci: $(0, \pm 3), e = 0.5 \Rightarrow c = 3$ and $a = \frac{c}{e} = \frac{3}{0.5} = 6 \Rightarrow b^2 = 36 - 9 = 27 \Rightarrow \frac{x^2}{27} + \frac{y^2}{36} = 1$

10. Foci: $(\pm 8, 0), e = 0.2 \Rightarrow c = 8$ and $a = \frac{c}{e} = \frac{8}{0.2} = 40 \Rightarrow b^2 = 1600 - 64 = 1536 \Rightarrow \frac{x^2}{1600} + \frac{y^2}{1536} = 1$

11. Vertices: $(0, \pm 70), e = 0.1 \Rightarrow a = 70$ and $c = ae = 70(0.1) = 7 \Rightarrow b^2 = 4900 - 49 = 4851 \Rightarrow \frac{x^2}{4851} + \frac{y^2}{4900} = 1$

12. Vertices: $(\pm 10, 0), e = 0.24 \Rightarrow a = 10$ and $c = ae = 10(0.24) = 2.4 \Rightarrow b^2 = 100 - 5.76 = 94.24 \Rightarrow \frac{x^2}{100} + \frac{y^2}{94.24} = 1$

13. Focus: $(\sqrt{5}, 0)$, Directrix: $x = \frac{9}{\sqrt{5}} \Rightarrow c = ae = \sqrt{5}$ and $\frac{a}{e} = \frac{9}{\sqrt{5}} \Rightarrow \frac{ae}{e^2} = \frac{9}{\sqrt{5}} \Rightarrow \frac{\sqrt{5}}{e^2} = \frac{9}{\sqrt{5}} \Rightarrow e^2 = \frac{5}{9} \Rightarrow e = \frac{\sqrt{5}}{3}$.

Then $PF = \frac{\sqrt{5}}{3} PD \Rightarrow \sqrt{(x - \sqrt{5})^2 + (y - 0)^2} = \frac{\sqrt{5}}{3} \left| x - \frac{9}{\sqrt{5}} \right| \Rightarrow (x - \sqrt{5})^2 + y^2 = \frac{5}{9} \left(x - \frac{9}{\sqrt{5}} \right)^2$
 $\Rightarrow x^2 - 2\sqrt{5}x + 5 + y^2 = \frac{5}{9} \left(x^2 - \frac{18}{\sqrt{5}}x + \frac{81}{5} \right) \Rightarrow \frac{4}{9}x^2 + y^2 = 4 \Rightarrow \frac{x^2}{9} + \frac{y^2}{4} = 1$

14. Focus: $(4, 0)$, Directrix: $x = \frac{16}{3} \Rightarrow c = ae = 4$ and $\frac{a}{e} = \frac{16}{3} \Rightarrow \frac{ae}{e^2} = \frac{16}{3} \Rightarrow \frac{4}{e^2} = \frac{16}{3} \Rightarrow e^2 = \frac{3}{4} \Rightarrow e = \frac{\sqrt{3}}{2}$.

Then $PF = \frac{\sqrt{3}}{2} PD \Rightarrow \sqrt{(x-4)^2 + (y-0)^2} = \frac{\sqrt{3}}{2} |x - \frac{16}{3}| \Rightarrow (x-4)^2 + y^2 = \frac{3}{4} (x - \frac{16}{3})^2$
 $\Rightarrow x^2 - 8x + 16 + y^2 = \frac{3}{4} (x^2 - \frac{32}{3}x + \frac{256}{9}) \Rightarrow \frac{1}{4}x^2 + y^2 = \frac{16}{3} \Rightarrow \frac{x^2}{(\frac{64}{3})} + \frac{y^2}{(\frac{16}{3})} = 1$

15. Focus: $(-4, 0)$, Directrix: $x = -16 \Rightarrow c = ae = 4$ and $\frac{a}{e} = 16 \Rightarrow \frac{ae}{e^2} = 16 \Rightarrow \frac{4}{e^2} = 16 \Rightarrow e^2 = \frac{1}{4} \Rightarrow e = \frac{1}{2}$.

Then $PF = \frac{1}{2} PD \Rightarrow \sqrt{(x+4)^2 + (y-0)^2} = \frac{1}{2} |x+16| \Rightarrow (x+4)^2 + y^2 = \frac{1}{4} (x+16)^2$
 $\Rightarrow x^2 + 8x + 16 + y^2 = \frac{1}{4} (x^2 + 32x + 256) \Rightarrow \frac{3}{4}x^2 + y^2 = 48 \Rightarrow \frac{x^2}{64} + \frac{y^2}{48} = 1$

16. Focus: $(-\sqrt{2}, 0)$, Directrix: $x = -2\sqrt{2} \Rightarrow c = ae = \sqrt{2}$ and $\frac{a}{e} = 2\sqrt{2} \Rightarrow \frac{ae}{e^2} = 2\sqrt{2} \Rightarrow \frac{\sqrt{2}}{e^2} = 2\sqrt{2} \Rightarrow e^2 = \frac{1}{2}$

$\Rightarrow e = \frac{1}{\sqrt{2}}$. Then $PF = \frac{1}{\sqrt{2}} PD \Rightarrow \sqrt{(x+\sqrt{2})^2 + (y-0)^2} = \frac{1}{\sqrt{2}} |x+2\sqrt{2}| \Rightarrow (x+\sqrt{2})^2 + y^2 = \frac{1}{2} (x+2\sqrt{2})^2$
 $\Rightarrow x^2 + 2\sqrt{2}x + 2 + y^2 = \frac{1}{2} (x^2 + 4\sqrt{2}x + 8) \Rightarrow \frac{1}{2}x^2 + y^2 = 2 \Rightarrow \frac{x^2}{4} + \frac{y^2}{2} = 1$

17. $x^2 - y^2 = 1 \Rightarrow c = \sqrt{a^2 + b^2} = \sqrt{1+1} = \sqrt{2} \Rightarrow e = \frac{c}{a}$

$= \frac{\sqrt{2}}{1} = \sqrt{2}$; asymptotes are $y = \pm x$; $F(\pm\sqrt{2}, 0)$;

directrices are $x = 0 \pm \frac{a}{e} = \pm \frac{1}{\sqrt{2}}$

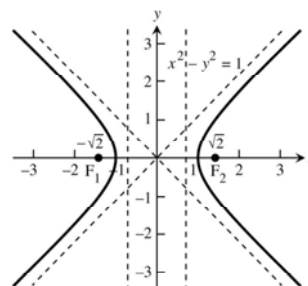

18. $9x^2 - 16y^2 = 144 \Rightarrow \frac{x^2}{16} - \frac{y^2}{9} = 1 \Rightarrow c = \sqrt{a^2 + b^2}$

$= \sqrt{16+9} = 5 \Rightarrow e = \frac{c}{a} = \frac{5}{4}$; asymptotes are $y = \pm \frac{3}{4}x$;

$F(\pm 5, 0)$; directrices are $x = 0 \pm \frac{a}{e} = \pm \frac{16}{5}$

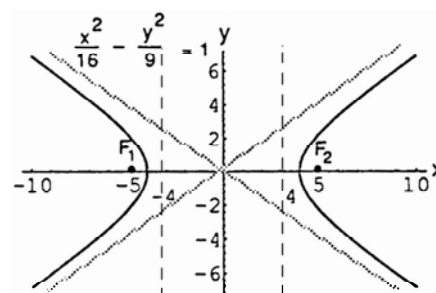

19. $y^2 - x^2 = 8 \Rightarrow \frac{y^2}{8} - \frac{x^2}{8} = 1 \Rightarrow c = \sqrt{a^2 + b^2} = \sqrt{8+8} = 4$

$\Rightarrow e = \frac{c}{a} = \frac{4}{\sqrt{8}} = \sqrt{2}$; asymptotes are $y = \pm x$; $F(0, \pm 4)$;

directrices are $y = 0 \pm \frac{a}{e} = \pm \frac{\sqrt{8}}{\sqrt{2}} = \pm 2$

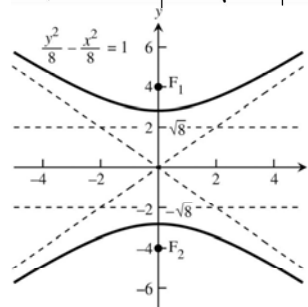

20. $y^2 - x^2 = 4 \Rightarrow \frac{y^2}{4} - \frac{x^2}{4} = 1 \Rightarrow c = \sqrt{a^2 + b^2} = \sqrt{4+4} = 2\sqrt{2}$
 $\Rightarrow e = \frac{c}{a} = \frac{2\sqrt{2}}{2} = \sqrt{2}$; asymptotes are $y = \pm x$; $F(0, \pm 2\sqrt{2})$;
 directrices are $y = 0 \pm \frac{a}{e} = \pm \frac{2}{\sqrt{2}} = \pm\sqrt{2}$

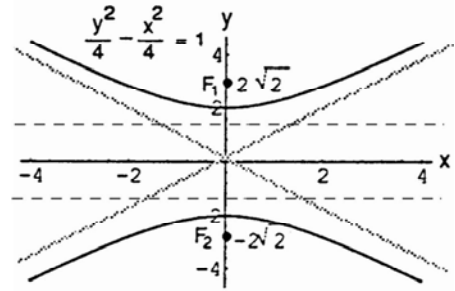

21. $8x^2 - 2y^2 = 16 \Rightarrow \frac{x^2}{2} - \frac{y^2}{8} = 1 \Rightarrow c = \sqrt{a^2 + b^2}$
 $= \sqrt{2+8} = \sqrt{10} \Rightarrow e = \frac{c}{a} = \frac{\sqrt{10}}{\sqrt{2}} = \sqrt{5}$;
 asymptotes are $y = \pm 2x$; $F(\pm\sqrt{10}, 0)$;
 directrices are $x = 0 \pm \frac{a}{e} = \pm \frac{\sqrt{2}}{\sqrt{5}} = \pm \frac{2}{\sqrt{10}}$

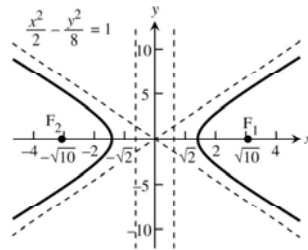

22. $y^2 - 3x^2 = 3 \Rightarrow \frac{y^2}{3} - x^2 = 1 \Rightarrow c = \sqrt{a^2 + b^2} = \sqrt{3+1} = 2$
 $\Rightarrow e = \frac{c}{a} = \frac{2}{\sqrt{3}}$; asymptotes are $y = \pm\sqrt{3}x$; $F(0, \pm 2)$;
 directrices are $y = 0 \pm \frac{a}{e} = \pm \frac{\sqrt{3}}{(2/\sqrt{3})} = \pm \frac{3}{2}$

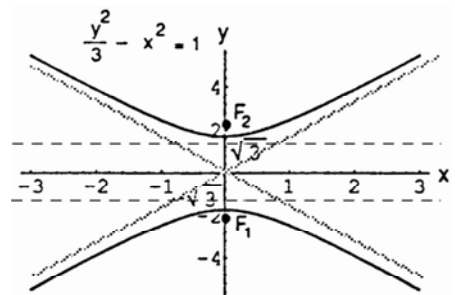

23. $8y^2 - 2x^2 = 16 \Rightarrow \frac{y^2}{2} - \frac{x^2}{8} = 1 \Rightarrow c = \sqrt{a^2 + b^2}$
 $= \sqrt{2+8} = \sqrt{10} \Rightarrow e = \frac{c}{a} = \frac{\sqrt{10}}{\sqrt{2}} = \sqrt{5}$; asymptotes are $y = \pm \frac{x}{2}$;
 $F(0, \pm\sqrt{10})$; directrices are $y = 0 \pm \frac{a}{e} = \pm \frac{\sqrt{2}}{\sqrt{5}} = \pm \frac{2}{\sqrt{10}}$

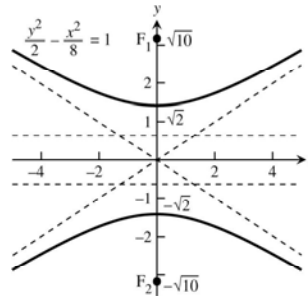

24. $64x^2 - 36y^2 = 2304 \Rightarrow \frac{x^2}{36} - \frac{y^2}{64} = 1 \Rightarrow c = \sqrt{a^2 + b^2}$
 $= \sqrt{36+64} = 10 \Rightarrow e = \frac{c}{a} = \frac{10}{6} = \frac{5}{3}$;
 asymptotes are $y = \pm \frac{4}{3}x$; $F(\pm 10, 0)$;
 directrices are $x = 0 \pm \frac{a}{e} = \pm \frac{6}{(5/3)} = \pm \frac{18}{5}$

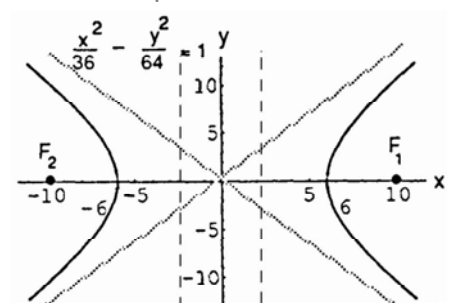

25. Vertices $(0, \pm 1)$ and $e = 3 \Rightarrow a = 1$ and $e = \frac{c}{a} = 3 \Rightarrow c = 3a = 3 \Rightarrow b^2 = c^2 - a^2 = 9 - 1 = 8 \Rightarrow y^2 - \frac{x^2}{8} = 1$

$$26. \text{ Vertices } (\pm 2, 0) \text{ and } e = 2 \Rightarrow a = 2 \text{ and } e = \frac{c}{a} = 2 \Rightarrow c = 2a = 4 \Rightarrow b^2 = c^2 - a^2 = 16 - 4 = 12 \Rightarrow \frac{x^2}{4} - \frac{y^2}{12} = 1$$

$$27. \text{ Foci } (\pm 3, 0) \text{ and } e = 3 \Rightarrow c = 3 \text{ and } e = \frac{c}{a} = 3 \Rightarrow c = 3a \Rightarrow a = 1 \Rightarrow b^2 = c^2 - a^2 = 9 - 1 = 8 \Rightarrow x^2 - \frac{y^2}{8} = 1$$

$$28. \text{ Foci } (0, \pm 5) \text{ and } e = 1.25 \Rightarrow c = 5 \text{ and } e = \frac{c}{a} = 1.25 = \frac{5}{4} \Rightarrow c = \frac{5}{4}a \Rightarrow 5 = \frac{5}{4}a \Rightarrow a = 4 \\ \Rightarrow b^2 = c^2 - a^2 = 25 - 16 = 9 \Rightarrow \frac{y^2}{16} - \frac{x^2}{9} = 1$$

$$29. e = 1, x = 2 \Rightarrow k = 2 \Rightarrow r = \frac{2(1)}{1 + (1)\cos\theta} = \frac{2}{1 + \cos\theta}$$

$$30. e = 1, y = 2 \Rightarrow k = 2 \Rightarrow r = \frac{2(1)}{1 + (1)\sin\theta} = \frac{2}{1 + \sin\theta}$$

$$31. e = 5, y = -6 \Rightarrow k = 6 \Rightarrow r = \frac{6(5)}{1 - 5\sin\theta} = \frac{30}{1 - 5\sin\theta}$$

$$32. e = 2, x = 4 \Rightarrow k = 4 \Rightarrow r = \frac{4(2)}{1 + 2\cos\theta} = \frac{8}{1 + 2\cos\theta}$$

$$33. e = \frac{1}{2}, x = 1 \Rightarrow k = 1 \Rightarrow r = \frac{(\frac{1}{2})(1)}{1 + (\frac{1}{2})\cos\theta} = \frac{1}{2 + \cos\theta}$$

$$34. e = \frac{1}{4}, x = -2 \Rightarrow k = 2 \Rightarrow r = \frac{(\frac{1}{4})(2)}{1 - (\frac{1}{4})\cos\theta} = \frac{2}{4 - \cos\theta}$$

$$35. e = \frac{1}{5}, y = -10 \Rightarrow k = 10 \Rightarrow r = \frac{(\frac{1}{5})(10)}{1 - (\frac{1}{5})\sin\theta} = \frac{10}{5 - \sin\theta}$$

$$36. e = \frac{1}{3}, y = 6 \Rightarrow k = 6 \Rightarrow r = \frac{(\frac{1}{3})(6)}{1 + (\frac{1}{3})\sin\theta} = \frac{6}{3 + \sin\theta}$$

$$37. r = \frac{1}{1 + \cos\theta} \Rightarrow e = 1, k = 1 \Rightarrow x = 1$$

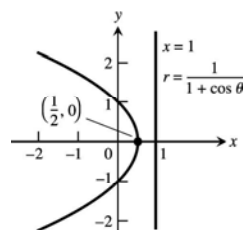

$$38. r = \frac{6}{2 + \cos\theta} = \frac{3}{1 + (\frac{1}{2})\cos\theta} \Rightarrow e = \frac{1}{2}, k = 6 \Rightarrow x = 6;$$

$$a(1 - e^2) = ke \Rightarrow a\left[1 - \left(\frac{1}{2}\right)^2\right] = 3 \Rightarrow \frac{3}{4}a = 3$$

$$\Rightarrow a = 4 \Rightarrow ea = 2$$

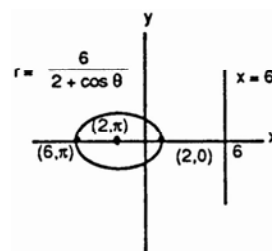

39. $r = \frac{25}{10-5\cos\theta} \Rightarrow r = \frac{(\frac{25}{10})}{1-(\frac{5}{10})\cos\theta} = \frac{(\frac{5}{2})}{1-(\frac{1}{2})\cos\theta}$
 $\Rightarrow e = \frac{1}{2}, k = 5 \Rightarrow x = -5; a(1-e^2) = ke$
 $\Rightarrow a\left[1-\left(\frac{1}{2}\right)^2\right] = \frac{5}{2} \Rightarrow \frac{3}{4}a = \frac{5}{2} \Rightarrow a = \frac{10}{3} \Rightarrow ea = \frac{5}{3}$

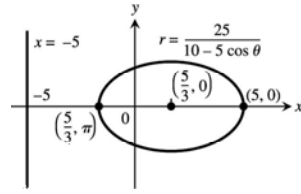

40. $r = \frac{4}{2-2\cos\theta} \Rightarrow r = \frac{2}{1-\cos\theta} \Rightarrow e = 1, k = 2 \Rightarrow x = -2$

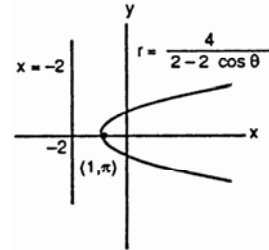

41. $r = \frac{400}{16+8\sin\theta} \Rightarrow r = \frac{(\frac{400}{16})}{1+(\frac{8}{16})\sin\theta} \Rightarrow r = \frac{25}{1+(\frac{1}{2})\sin\theta}$
 $e = \frac{1}{2}, k = 50 \Rightarrow y = 50; a(1-e^2) = ke$
 $\Rightarrow a\left[1-\left(\frac{1}{2}\right)^2\right] = 25 \Rightarrow \frac{3}{4}a = 25 \Rightarrow a = \frac{100}{3} \Rightarrow ea = \frac{50}{3}$

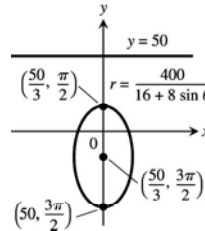

42. $r = \frac{12}{3+3\sin\theta} \Rightarrow r = \frac{4}{1+\sin\theta} \Rightarrow e = 1, k = 4 \Rightarrow y = 4$

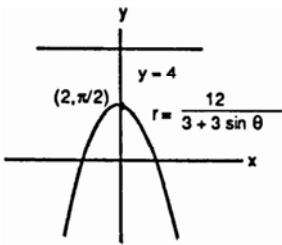

43. $r = \frac{8}{2-2\sin\theta} \Rightarrow r = \frac{4}{1-\sin\theta} \Rightarrow e = 1, k = 4 \Rightarrow y = -4$

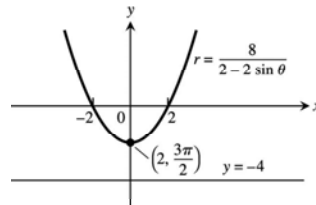

44. $r = \frac{4}{2-\sin\theta} \Rightarrow r = \frac{2}{1-(\frac{1}{2})\sin\theta} \Rightarrow e = \frac{1}{2}, k = 4 \Rightarrow y = -4;$
 $a(1-e^2) = ke \Rightarrow a\left[1-\left(\frac{1}{2}\right)^2\right] = 2$
 $\Rightarrow \frac{3}{4}a = 2 \Rightarrow a = \frac{8}{3} \Rightarrow ea = \frac{4}{3}$

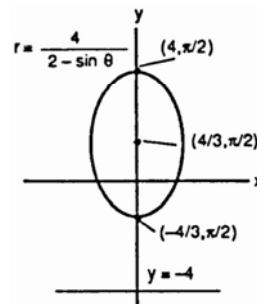

$$\begin{aligned}
 45. \quad r \cos\left(\theta - \frac{\pi}{4}\right) &= \sqrt{2} \Rightarrow r\left(\cos\theta \cos\frac{\pi}{4} + \sin\theta \sin\frac{\pi}{4}\right) = \sqrt{2} \\
 &\Rightarrow \frac{1}{\sqrt{2}}r \cos\theta + \frac{1}{\sqrt{2}}r \sin\theta = \sqrt{2} \Rightarrow \frac{1}{\sqrt{2}}x + \frac{1}{\sqrt{2}}y = \sqrt{2} \\
 &\Rightarrow x + y = 2 \Rightarrow y = 2 - x
 \end{aligned}$$

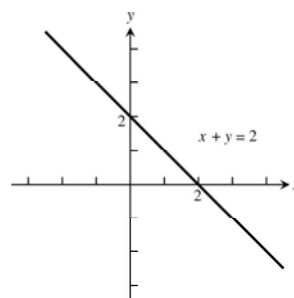

$$\begin{aligned}
 46. \quad r \cos\left(\theta + \frac{3\pi}{4}\right) &= 1 \Rightarrow r\left(\cos\theta \cos\frac{3\pi}{4} - \sin\theta \sin\frac{3\pi}{4}\right) = 1 \\
 &\Rightarrow -\frac{2}{\sqrt{2}}r \cos\theta - \frac{\sqrt{2}}{2}r \sin\theta = 1 \Rightarrow x + y = -\sqrt{2} \\
 &\Rightarrow y = -x - \sqrt{2}
 \end{aligned}$$

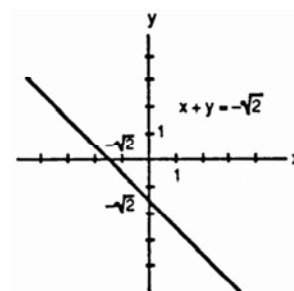

$$\begin{aligned}
 47. \quad r \cos\left(\theta - \frac{2\pi}{3}\right) &= 3 \Rightarrow r\left(\cos\theta \cos\frac{2\pi}{3} + \sin\theta \sin\frac{2\pi}{3}\right) = 3 \\
 &\Rightarrow -\frac{1}{2}r \cos\theta + \frac{\sqrt{3}}{2}r \sin\theta = 3 \Rightarrow -\frac{1}{2}x + \frac{\sqrt{3}}{2}y = 3 \\
 &\Rightarrow -x + \sqrt{3}y = 6 \Rightarrow y = \frac{\sqrt{3}}{3}x + 2\sqrt{3}
 \end{aligned}$$

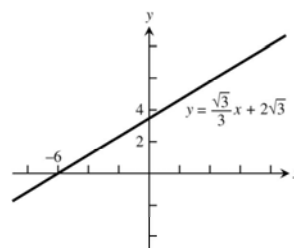

$$\begin{aligned}
 48. \quad r \cos\left(\theta + \frac{\pi}{3}\right) &= 2 \Rightarrow r\left(\cos\theta \cos\frac{\pi}{3} - \sin\theta \sin\frac{\pi}{3}\right) = 2 \\
 &\Rightarrow \frac{1}{2}r \cos\theta - \frac{\sqrt{3}}{2}r \sin\theta = 2 \Rightarrow \frac{1}{2}x - \frac{\sqrt{3}}{2}y = 2 \\
 &\Rightarrow x - \sqrt{3}y = 4 \Rightarrow y = \frac{\sqrt{3}}{3}x - \frac{4\sqrt{3}}{3}
 \end{aligned}$$

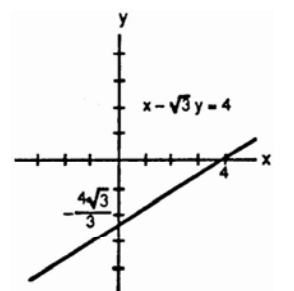

$$\begin{aligned}
 49. \quad \sqrt{2}x + \sqrt{2}y &= 6 \Rightarrow \sqrt{2}r \cos\theta + \sqrt{2}r \sin\theta = 6 \Rightarrow r\left(\frac{\sqrt{2}}{2}\cos\theta + \frac{\sqrt{2}}{2}\sin\theta\right) = 3 \Rightarrow r\left(\cos\frac{\pi}{4}\cos\theta + \sin\frac{\pi}{4}\sin\theta\right) = 3 \\
 &\Rightarrow r \cos\left(\theta - \frac{\pi}{4}\right) = 3
 \end{aligned}$$

$$\begin{aligned}
 50. \quad \sqrt{3}x - y &= 1 \Rightarrow \sqrt{3}r \cos\theta - r \sin\theta = 1 \Rightarrow r\left(\frac{\sqrt{3}}{2}\cos\theta - \frac{1}{2}\sin\theta\right) = \frac{1}{2} \Rightarrow r\left(\cos\frac{\pi}{6}\cos\theta - \sin\frac{\pi}{6}\sin\theta\right) = \frac{1}{2} \\
 &\Rightarrow r \cos\left(\theta + \frac{\pi}{6}\right) = \frac{1}{2}
 \end{aligned}$$

$$51. \quad y = -5 \Rightarrow r \sin\theta = -5 \Rightarrow -r \sin\theta = 5 \Rightarrow r \sin(-\theta) = 5 \Rightarrow r \cos\left(\frac{\pi}{2} - (-\theta)\right) = 5 \Rightarrow r \cos\left(\theta + \frac{\pi}{2}\right) = 5$$

52. $x = -4 \Rightarrow r \cos \theta = -4 \Rightarrow -r \cos \theta = 4 \Rightarrow r \cos(\theta - \pi) = 4$

53.

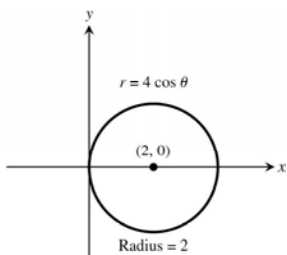

54.

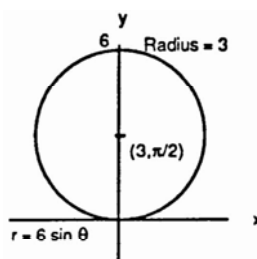

55.

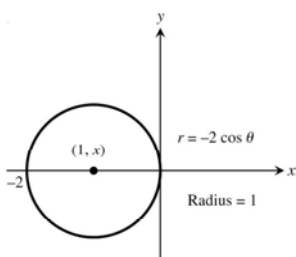

56.

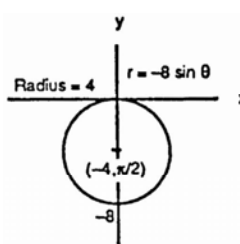

57. $(x-6)^2 + y^2 = 36 \Rightarrow C = (6, 0), a = 6$
 $\Rightarrow r = 12 \cos \theta$ is the polar equation

58. $(x+2)^2 + y^2 = 4 \Rightarrow C = (-2, 0), a = 2$
 $\Rightarrow r = -4 \cos \theta$ is the polar equation

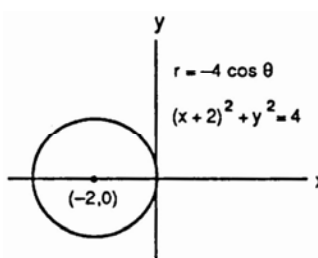
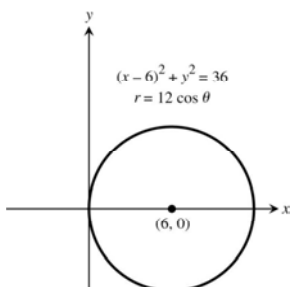

59. $x^2 + (y-5)^2 = 25 \Rightarrow C = (0, 5), a = 5$
 $\Rightarrow r = 10 \sin \theta$ is the polar equation

60. $x^2 + (y+7)^2 = 49 \Rightarrow C = (0, -7), a = 7$
 $\Rightarrow r = -14 \sin \theta$ is the polar equation

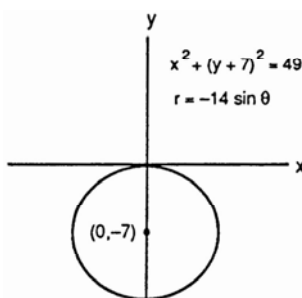
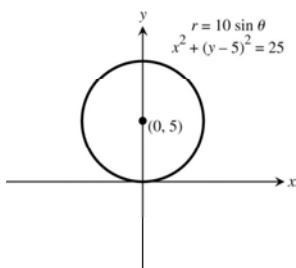

61. $x^2 + 2x + y^2 = 0 \Rightarrow (x+1)^2 + y^2 = 1$
 $\Rightarrow C = (-1, 0), a = 1 \Rightarrow r = -2 \cos \theta$
 is the polar equation

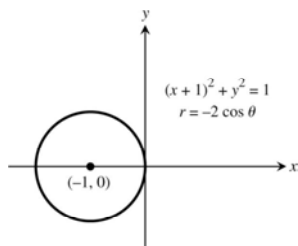

62. $x^2 - 16x + y^2 = 0 \Rightarrow (x-8)^2 + y^2 = 64$
 $\Rightarrow C = (8, 0), a = 8 \Rightarrow r = 16 \cos \theta$
 is the polar equation

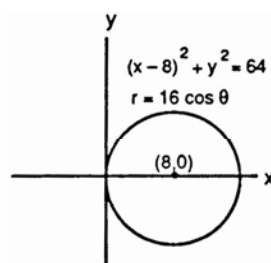

63. $x^2 + y^2 + y = 0 \Rightarrow x^2 + (y + \frac{1}{2})^2 = \frac{1}{4}$
 $\Rightarrow C = (0, -\frac{1}{2}), a = \frac{1}{2} \Rightarrow r = -\sin \theta$
 is the polar equation

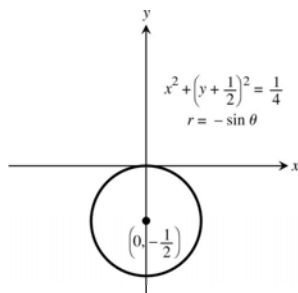

64. $x^2 + y^2 - \frac{4}{3}y = 0 \Rightarrow x^2 + (y - \frac{2}{3})^2 = \frac{4}{9}$
 $\Rightarrow C = (0, \frac{2}{3}), a = \frac{2}{3} \Rightarrow r = \frac{4}{3} \sin \theta$
 is the polar equation

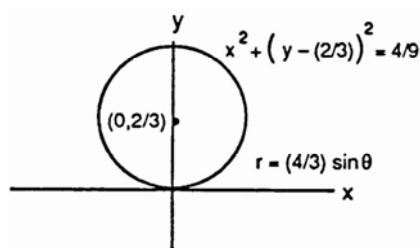

65. $r = 3 \sec(\theta - \frac{\pi}{3})$
 The graph shows a straight line in the Cartesian plane. The line passes through the y-axis at $2\sqrt{3}$ and the x-axis at 6 .

66. $r = 4 \sec(\theta + \frac{\pi}{6})$
 The graph shows a straight line in the Cartesian plane. The line passes through the y-axis at -8 and the x-axis at $\frac{8}{\sqrt{3}}$.

67. $r = 4 \sin \theta$
 The graph shows a circle in the Cartesian plane. The circle is centered at (0, 2) on the y-axis and has a radius of 2. The equation r = 4 sin theta is shown.

68. $r = -2 \cos \theta$
 The graph shows a circle in the Cartesian plane. The circle is centered at (-1, 0) on the x-axis and has a radius of 1. The equation r = -2 cos theta is shown.

69.

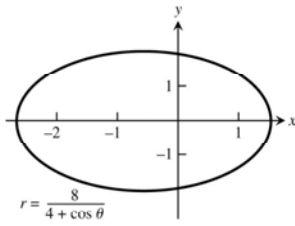

70.

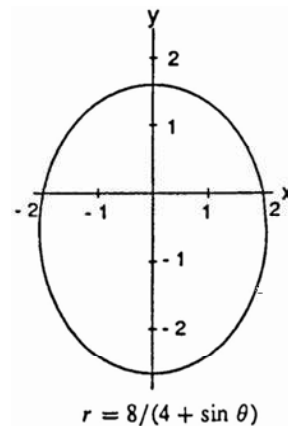

71.

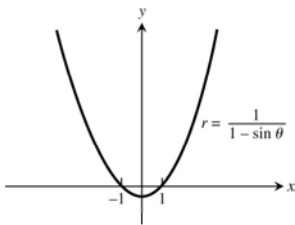

72.

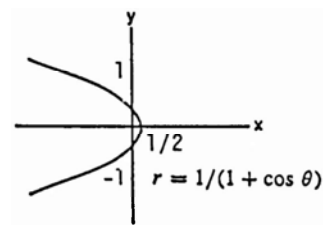

73.

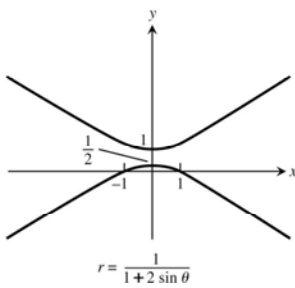

74.

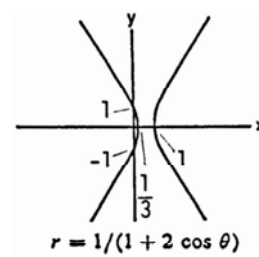

75. (a) Perihelion = $a - ae = a(1 - e)$, Aphelion = $ea + a = a(1 + e)$

(b)

Planet	Perihelion	Aphelion
Mercury	0.3075 AU	0.4667 AU
Venus	0.7184 AU	0.7282 AU
Earth	0.9833 AU	1.0167 AU
Mars	1.3817 AU	1.6663 AU
Jupiter	4.9512 AU	5.4548 AU
Saturn	9.0210 AU	10.0570 AU
Uranus	18.2977 AU	20.0623 AU
Neptune	29.8135 AU	30.3065 AU

76. Mercury: $r = \frac{(0.3871)(1 - 0.2056^2)}{1 + 0.2056 \cos \theta} = \frac{0.3707}{1 + 0.2056 \cos \theta}$

Venus: $r = \frac{(0.7233)(1 - 0.0068^2)}{1 + 0.0068 \cos \theta} = \frac{0.7233}{1 + 0.0068 \cos \theta}$

Earth: $r = \frac{1(1 - 0.0167^2)}{1 + 0.0167 \cos \theta} = \frac{0.9997}{1 + 0.0167 \cos \theta}$

Mars: $r = \frac{(1.524)(1 - 0.0934^2)}{1 + 0.0934 \cos \theta} = \frac{1.511}{1 + 0.0934 \cos \theta}$

Jupiter: $r = \frac{(5.203)(1 - 0.0484^2)}{1 + 0.0484 \cos \theta} = \frac{5.191}{1 + 0.0484 \cos \theta}$

Saturn: $r = \frac{(9.539)(1 - 0.0543^2)}{1 + 0.0543 \cos \theta} = \frac{9.511}{1 + 0.0543 \cos \theta}$

Uranus: $r = \frac{(19.18)(1 - 0.0460^2)}{1 + 0.0460 \cos \theta} = \frac{19.14}{1 + 0.0460 \cos \theta}$

Neptune: $r = \frac{(30.06)(1 - 0.0082^2)}{1 + 0.0082 \cos \theta} = \frac{30.06}{1 + 0.0082 \cos \theta}$

CHAPTER 11 PRACTICE EXERCISES

1. $x = \frac{t}{2}$ and $y = t + 1 \Rightarrow 2x = t \Rightarrow y = 2x + 1$

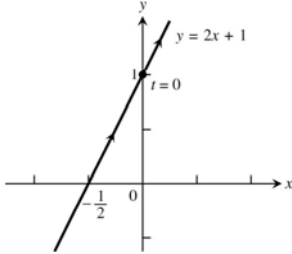

2. $x = \sqrt{t}$ and $y = 1 - \sqrt{t} \Rightarrow y = 1 - x$

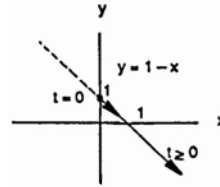

3. $x = \frac{1}{2} \tan t$ and $y = \frac{1}{2} \sec t \Rightarrow x^2 = \frac{1}{4} \tan^2 t$ and $y^2 = \frac{1}{4} \sec^2 t \Rightarrow 4x^2 = \tan^2 t$ and $4y^2 = \sec^2 t \Rightarrow 4x^2 + 1 = 4y^2 \Rightarrow 4y^2 - 4x^2 = 1$

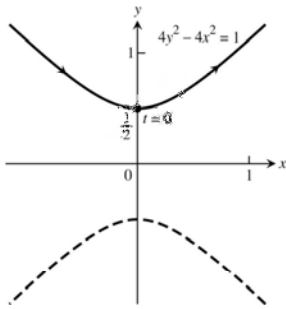

4. $x = -2 \cos t$ and $y = 2 \sin t \Rightarrow x^2 = 4 \cos^2 t$ and $y^2 = 4 \sin^2 t \Rightarrow x^2 + y^2 = 4$

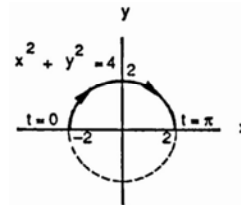

5. $x = -\cos t$ and $y = \cos^2 t \Rightarrow y = (-x)^2 = x^2$

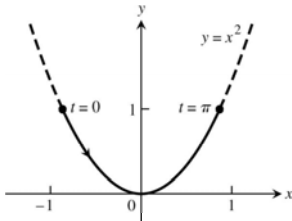

6. $x = 4 \cos t$ and $y = 9 \sin t \Rightarrow x^2 = 16 \cos^2 t$ and $y^2 = 81 \sin^2 t \Rightarrow \frac{x^2}{16} + \frac{y^2}{81} = 1$

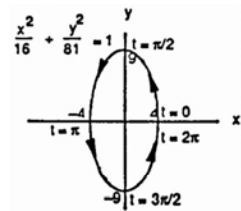

7. $16x^2 + 9y^2 = 144 \Rightarrow \frac{x^2}{9} + \frac{y^2}{16} = 1 \Rightarrow a = 3$ and $b = 4 \Rightarrow x = 3 \cos t$ and $y = 4 \sin t, 0 \leq t \leq 2\pi$

8. $x^2 + y^2 = 4 \Rightarrow x = -2 \cos t$ and $y = 2 \sin t, 0 \leq t \leq 6\pi$

9. $x = \frac{1}{2} \tan t, y = \frac{1}{2} \sec t \Rightarrow \frac{dy}{dx} = \frac{dy/dt}{dx/dt} = \frac{\frac{1}{2} \sec t \tan t}{\frac{1}{2} \sec^2 t} = \frac{\tan t}{\sec t} = \sin t \Rightarrow \frac{dy}{dx} \Big|_{t=\pi/3} = \sin \frac{\pi}{3} = \frac{\sqrt{3}}{2};$

$t = \frac{\pi}{3} \Rightarrow x = \frac{1}{2} \tan \frac{\pi}{3} = \frac{\sqrt{3}}{2}$ and $y = \frac{1}{2} \sec \frac{\pi}{3} = 1 \Rightarrow y = \frac{\sqrt{3}}{2} x + \frac{1}{4}; \frac{d^2y}{dx^2} = \frac{dy'/dt}{dx/dt} = \frac{\cos t}{\frac{1}{2} \sec^2 t} = 2 \cos^3 t$

$\Rightarrow \frac{d^2y}{dx^2} \Big|_{t=\pi/3} = 2 \cos^3 \left(\frac{\pi}{3} \right) = \frac{1}{4}$

$$10. \quad x = 1 + \frac{1}{t^2}, y = 1 - \frac{3}{t} \Rightarrow \frac{dy}{dx} = \frac{dy/dt}{dx/dt} = \frac{\left(\frac{3}{t^2}\right)}{\left(-\frac{2}{t^3}\right)} = -\frac{3}{2}t \Rightarrow \frac{dy}{dx}\bigg|_{t=2} = -\frac{3}{2}(2) = -3; t = 2 \Rightarrow x = 1 + \frac{1}{2^2} = \frac{5}{4} \text{ and}$$

$$y = 1 - \frac{3}{2} = -\frac{1}{2} \Rightarrow y = -3x + \frac{13}{4}; \frac{d^2y}{dx^2} = \frac{dy'/dt}{dx/dt} = \frac{\left(-\frac{3}{t^2}\right)}{\left(-\frac{2}{t^3}\right)} = \frac{3}{4}t^3 \Rightarrow \frac{d^2y}{dx^2}\bigg|_{t=2} = \frac{3}{4}(2)^3 = 6$$

$$11. \quad (a) \quad x = 4t^2, y = t^3 - 1 \Rightarrow t = \pm \frac{\sqrt{x}}{2} \Rightarrow y = \left(\pm \frac{\sqrt{x}}{2}\right)^3 - 1 = \pm \frac{x^{3/2}}{8} - 1$$

$$(b) \quad x = \cos t, y = \tan t \Rightarrow \sec t = \frac{1}{x} \Rightarrow \tan^2 t + 1 = \sec^2 t \Rightarrow y^2 = \frac{1}{x^2} - 1 = \frac{1-x^2}{x^2} \Rightarrow y = \pm \frac{\sqrt{1-x^2}}{x}$$

$$12. \quad (a) \quad \text{The line through } (1, -2) \text{ with slope } 3 \text{ is } y = 3x - 5 \Rightarrow x = t, y = 3t - 5, -\infty < t < \infty$$

$$(b) \quad (x-1)^2 + (y+2)^2 = 9 \Rightarrow x-1 = 3 \cos t, y+2 = 3 \sin t \Rightarrow x = 1 + 3 \cos t, y = -2 + 3 \sin t, 0 \leq t \leq 2\pi$$

$$(c) \quad y = 4x^2 - x \Rightarrow x = t, y = 4t^2 - t, -\infty < t < \infty$$

$$(d) \quad 9x^2 + 4y^2 = 36 \Rightarrow \frac{x^2}{4} + \frac{y^2}{9} = 1 \Rightarrow x = 2 \cos t, y = 3 \sin t, 0 \leq t \leq 2\pi$$

$$13. \quad y = x^{1/2} - \frac{x^{3/2}}{3} \Rightarrow \frac{dy}{dx} = \frac{1}{2}x^{-1/2} - \frac{1}{2}x^{1/2} \Rightarrow \left(\frac{dy}{dx}\right)^2 = \frac{1}{4}\left(\frac{1}{x} - 2 + x\right) \Rightarrow L = \int_1^4 \sqrt{1 + \frac{1}{4}\left(\frac{1}{x} - 2 + x\right)} dx$$

$$\Rightarrow L = \int_1^4 \sqrt{\frac{1}{4}\left(\frac{1}{x} + 2 + x\right)} dx = \int_1^4 \sqrt{\frac{1}{4}\left(x^{-1/2} + x^{1/2}\right)^2} dx = \int_1^4 \frac{1}{2}\left(x^{-1/2} + x^{1/2}\right) dx = \frac{1}{2}\left[2x^{1/2} + \frac{2}{3}x^{3/2}\right]_1^4$$

$$= \frac{1}{2}\left[\left(4 + \frac{2}{3} \cdot 8\right) - \left(2 + \frac{2}{3}\right)\right] = \frac{1}{2}\left(2 + \frac{14}{3}\right) = \frac{10}{3}$$

$$14. \quad x = y^{2/3} \Rightarrow \frac{dx}{dy} = \frac{2}{3}y^{-1/3} \Rightarrow \left(\frac{dx}{dy}\right)^2 = \frac{4y^{-2/3}}{9} \Rightarrow L = \int_1^8 \sqrt{1 + \left(\frac{dx}{dy}\right)^2} dy = \int_1^8 \sqrt{1 + \frac{4}{9y^{2/3}}} dy = \int_1^8 \sqrt{\frac{9y^{2/3} + 4}{3y^{1/3}}} dy$$

$$= \frac{1}{3} \int_1^8 \sqrt{9y^{2/3} + 4} \left(y^{-1/3}\right) dy; \left[u = 9y^{2/3} + 4 \Rightarrow du = 6y^{-1/3} dy; y = 1 \Rightarrow u = 13, y = 8 \Rightarrow u = 40\right]$$

$$\rightarrow L = \frac{1}{18} \int_{13}^{40} u^{1/2} du = \frac{1}{18} \left[\frac{2}{3}u^{3/2}\right]_{13}^{40} = \frac{1}{27} [40^{3/2} - 13^{3/2}] \approx 7.634$$

$$15. \quad y = \frac{5}{12}x^{6/5} - \frac{5}{8}x^{4/5} \Rightarrow \frac{dy}{dx} = \frac{1}{2}x^{1/5} - \frac{1}{2}x^{-1/5} \Rightarrow \left(\frac{dy}{dx}\right)^2 = \frac{1}{4}\left(x^{2/5} - 2 + x^{-2/5}\right)$$

$$\Rightarrow L = \int_1^{32} \sqrt{1 + \frac{1}{4}\left(x^{2/5} - 2 + x^{-2/5}\right)} dx \Rightarrow L = \int_1^{32} \sqrt{\frac{1}{4}\left(x^{2/5} + 2 + x^{-2/5}\right)} dx = \int_1^{32} \sqrt{\frac{1}{4}\left(x^{1/5} + x^{-1/5}\right)^2} dx$$

$$= \int_1^{32} \frac{1}{2}\left(x^{1/5} + x^{-1/5}\right) dx = \frac{1}{2}\left[\frac{5}{6}x^{6/5} + \frac{5}{4}x^{4/5}\right]_1^{32} = \frac{1}{2}\left[\left(\frac{5}{6} \cdot 2^6 + \frac{5}{4} \cdot 2^4\right) - \left(\frac{5}{6} + \frac{5}{4}\right)\right] = \frac{1}{2}\left(\frac{315}{6} + \frac{75}{4}\right)$$

$$= \frac{1}{48}(1260 + 450) = \frac{1710}{48} = \frac{285}{8}$$

$$16. \quad x = \frac{1}{12}y^3 + \frac{1}{y} \Rightarrow \frac{dx}{dy} = \frac{1}{4}y^2 - \frac{1}{y^2} \Rightarrow \left(\frac{dx}{dy}\right)^2 = \frac{1}{16}y^4 - \frac{1}{2} + \frac{1}{y^4} \Rightarrow L = \int_1^2 \sqrt{1 + \left(\frac{1}{16}y^4 - \frac{1}{2} + \frac{1}{y^4}\right)} dy$$

$$= \int_1^2 \sqrt{\frac{1}{16}y^4 + \frac{1}{2} + \frac{1}{y^4}} dy = \int_1^2 \sqrt{\left(\frac{1}{4}y^2 + \frac{1}{y^2}\right)^2} dy = \int_1^2 \left(\frac{1}{4}y^2 + \frac{1}{y^2}\right) dy = \left[\frac{1}{12}y^3 - \frac{1}{y}\right]_1^2$$

$$= \left(\frac{8}{12} - \frac{1}{2}\right) - \left(\frac{1}{12} - 1\right) = \frac{7}{12} + \frac{1}{2} = \frac{13}{12}$$

$$\begin{aligned}
17. \quad \frac{dx}{dt} &= -5 \sin t + 5 \sin 5t \text{ and } \frac{dy}{dt} = 5 \cos t - 5 \cos 5t \Rightarrow \sqrt{\left(\frac{dx}{dt}\right)^2 + \left(\frac{dy}{dt}\right)^2} \\
&= \sqrt{(-5 \sin t + 5 \sin 5t)^2 + (5 \cos t - 5 \cos 5t)^2} = 5\sqrt{\sin^2 5t - 2 \sin t \sin 5t + \sin^2 t + \cos^2 t - 2 \cos t \cos 5t + \cos^2 5t} \\
&= 5\sqrt{2 - 2(\sin t \sin 5t + \cos t \cos 5t)} = 5\sqrt{2(1 - \cos 4t)} = 5\sqrt{4\left(\frac{1}{2}\right)(1 - \cos 4t)} = 10\sqrt{\sin^2 2t} = 10|\sin 2t| \\
&= 10 \sin 2t \left(\text{since } 0 \leq t \leq \frac{\pi}{2}\right) \Rightarrow \text{Length} = \int_0^{\pi/2} 10 \sin 2t \, dt = [-5 \cos 2t]_0^{\pi/2} = (-5)(-1) - (-5)(1) = 10
\end{aligned}$$

$$\begin{aligned}
18. \quad \frac{dx}{dt} &= 3t^2 - 12t \text{ and } \frac{dy}{dt} = 3t^2 + 12t \Rightarrow \sqrt{\left(\frac{dx}{dt}\right)^2 + \left(\frac{dy}{dt}\right)^2} = \sqrt{(3t^2 - 12t)^2 + (3t^2 + 12t)^2} = \sqrt{288t^2 + 18t^4} \\
&= 3\sqrt{2} |t| \sqrt{16 + t^2} \Rightarrow \text{Length} = \int_0^1 3\sqrt{2} |t| \sqrt{16 + t^2} \, dt = 3\sqrt{2} \int_0^1 t \sqrt{16 + t^2} \, dt; \\
&\quad \left[u = 16 + t^2 \Rightarrow du = 2t \, dt \Rightarrow \frac{1}{2} du = t \, dt; t = 0 \Rightarrow u = 16; t = 1 \Rightarrow u = 17 \right]; \\
&\rightarrow \frac{3\sqrt{2}}{2} \int_{16}^{17} \sqrt{u} \, du = \frac{3\sqrt{2}}{2} \left[\frac{2}{3} u^{3/2} \right]_{16}^{17} = \frac{3\sqrt{2}}{2} \left(\frac{2}{3} (17)^{3/2} - \frac{2}{3} (16)^{3/2} \right) = \frac{3\sqrt{2}}{2} \cdot \frac{2}{3} (17)^{3/2} - 64 \\
&= \sqrt{2} \left((17)^{3/2} - 64 \right) \approx 8.617.
\end{aligned}$$

$$\begin{aligned}
19. \quad \frac{dx}{d\theta} &= -3 \sin \theta \text{ and } \frac{dy}{d\theta} = 3 \cos \theta \Rightarrow \sqrt{\left(\frac{dx}{d\theta}\right)^2 + \left(\frac{dy}{d\theta}\right)^2} = \sqrt{(-3 \sin \theta)^2 + (3 \cos \theta)^2} = \sqrt{3(\sin^2 \theta + \cos^2 \theta)} = 3 \\
&\Rightarrow \text{Length} = \int_0^{3\pi/2} 3 \, d\theta = 3 \int_0^{3\pi/2} d\theta = 3 \left(\frac{3\pi}{2} - 0 \right) = \frac{9\pi}{2}
\end{aligned}$$

$$\begin{aligned}
20. \quad x &= t^2 \text{ and } y = \frac{t^3}{3} - t, -\sqrt{3} \leq t \leq \sqrt{3} \Rightarrow \frac{dx}{dt} = 2t \text{ and } \frac{dy}{dt} = t^2 - 1 \Rightarrow \text{Length} = \int_{-\sqrt{3}}^{\sqrt{3}} \sqrt{(2t)^2 + (t^2 - 1)^2} \, dt \\
&= \int_{-\sqrt{3}}^{\sqrt{3}} \sqrt{t^4 + 2t^2 + 1} \, dt = \int_{-\sqrt{3}}^{\sqrt{3}} \sqrt{(t^2 + 1)^2} \, dt = \int_{-\sqrt{3}}^{\sqrt{3}} (t^2 + 1) \, dt = \left[\frac{t^3}{3} + t \right]_{-\sqrt{3}}^{\sqrt{3}} = 4\sqrt{3}
\end{aligned}$$

$$\begin{aligned}
21. \quad x &= \frac{t^2}{2} \text{ and } y = 2t, 0 \leq t \leq \sqrt{5} \Rightarrow \frac{dx}{dt} = t \text{ and } \frac{dy}{dt} = 2 \Rightarrow \text{Surface Area} = \int_0^{\sqrt{5}} 2\pi(2t)\sqrt{t^2 + 4} \, dt \\
&\left[u = t^2 + 4 \Rightarrow du = 2t \, dt; t = 0 \Rightarrow u = 4, t = \sqrt{5} \Rightarrow u = 9 \right] \rightarrow \int_4^9 2\pi u^{1/2} \, du = 2\pi \left[\frac{2}{3} u^{3/2} \right]_4^9 = \frac{76\pi}{3}
\end{aligned}$$

$$\begin{aligned}
22. \quad x &= t^2 + \frac{1}{2t} \text{ and } y = 4\sqrt{t}, \frac{1}{\sqrt{2}} \leq t \leq 1 \Rightarrow \frac{dx}{dt} = 2t - \frac{1}{2t^2} \text{ and } \frac{dy}{dt} = \frac{2}{\sqrt{t}} \\
&\Rightarrow \text{Surface Area} = \int_{1/\sqrt{2}}^1 2\pi \left(t^2 + \frac{1}{2t} \right) \sqrt{\left(2t - \frac{1}{2t^2} \right)^2 + \left(\frac{2}{\sqrt{t}} \right)^2} \, dt = 2\pi \int_{1/\sqrt{2}}^1 \left(t^2 + \frac{1}{2t} \right) \sqrt{\left(2t + \frac{1}{2t^2} \right)^2} \, dt \\
&= 2\pi \int_{1/\sqrt{2}}^1 \left(t^2 + \frac{1}{2t} \right) \left(2t + \frac{1}{2t^2} \right) \, dt = 2\pi \int_{1/\sqrt{2}}^1 \left(2t^3 + \frac{3}{2} + \frac{1}{4}t^{-3} \right) \, dt = 2\pi \left[\frac{1}{2}t^4 + \frac{3}{2}t - \frac{1}{8}t^{-2} \right]_{1/\sqrt{2}}^1 = 2\pi \left(2 - \frac{3\sqrt{2}}{4} \right)
\end{aligned}$$

$$\begin{aligned}
 23. \quad r \cos\left(\theta + \frac{\pi}{3}\right) &= 2\sqrt{3} \Rightarrow r\left(\cos\theta \cos\frac{\pi}{3} - \sin\theta \sin\frac{\pi}{3}\right) = 2\sqrt{3} \\
 &\Rightarrow \frac{1}{2}r \cos\theta - \frac{\sqrt{3}}{2}r \sin\theta = 2\sqrt{3} \\
 &\Rightarrow r \cos\theta - \sqrt{3}r \sin\theta = 4\sqrt{3} \Rightarrow x - \sqrt{3}y = 4\sqrt{3} \\
 &\Rightarrow y = \frac{\sqrt{3}}{3}x - 4
 \end{aligned}$$

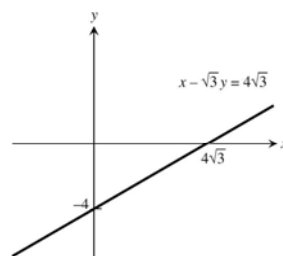

$$\begin{aligned}
 24. \quad r \cos\left(\theta - \frac{3\pi}{4}\right) &= \frac{\sqrt{2}}{2} \Rightarrow r\left(\cos\theta \cos\frac{3\pi}{4} + \sin\theta \sin\frac{3\pi}{4}\right) = \frac{\sqrt{2}}{2} \\
 &\Rightarrow -\frac{\sqrt{2}}{2}r \cos\theta + \frac{\sqrt{2}}{2}r \sin\theta = \frac{\sqrt{2}}{2} \Rightarrow -x + y = 1 \\
 &\Rightarrow y = x + 1
 \end{aligned}$$

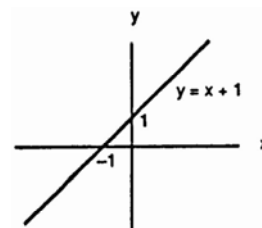

$$25. \quad r = 2 \sec\theta \Rightarrow r = \frac{2}{\cos\theta} \Rightarrow r \cos\theta = 2 \Rightarrow x = 2$$

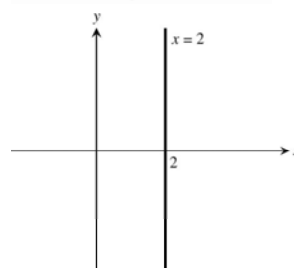

$$26. \quad r = -\sqrt{2} \sec\theta \Rightarrow r \cos\theta = -\sqrt{2} \Rightarrow x = -\sqrt{2}$$

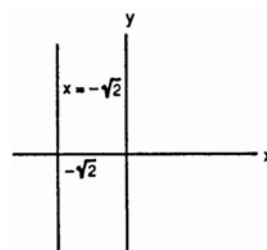

$$27. \quad r = -\frac{3}{2} \csc\theta \Rightarrow r \sin\theta = -\frac{3}{2} \Rightarrow y = -\frac{3}{2}$$

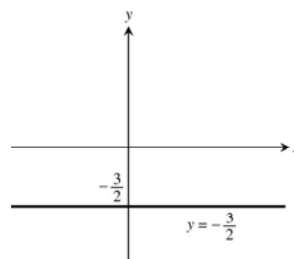

$$28. \quad r = 3\sqrt{3} \csc\theta \Rightarrow r \sin\theta = 3\sqrt{3} \Rightarrow y = 3\sqrt{3}$$

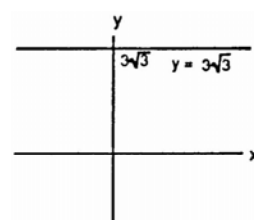

29. $r = -4 \sin \theta \Rightarrow r^2 = -4r \sin \theta \Rightarrow x^2 + y^2 + 4y = 0$
 $\Rightarrow x^2 + (y+2)^2 = 4;$
 circle with center $(0, -2)$ and radius 2.

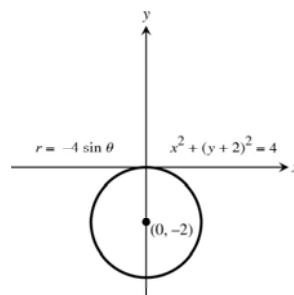

30. $r = 3\sqrt{3} \sin \theta \Rightarrow r^2 = 3\sqrt{3} r \sin \theta$
 $\Rightarrow x^2 + y^2 - 3\sqrt{3} y = 0 \Rightarrow x^2 + \left(y - \frac{3\sqrt{3}}{2}\right)^2 = \frac{27}{4};$
 circle with center $\left(0, \frac{3\sqrt{3}}{2}\right)$ and radius $\frac{3\sqrt{3}}{2}$

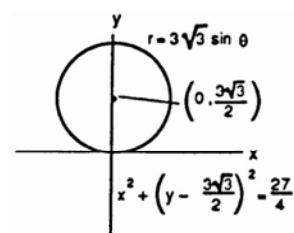

31. $r = 2\sqrt{2} \cos \theta \Rightarrow r^2 = 2\sqrt{2} r \cos \theta$
 $\Rightarrow x^2 + y^2 - 2\sqrt{2}x = 0 \Rightarrow (x - \sqrt{2})^2 + y^2 = 2;$
 circle with center $(\sqrt{2}, 0)$ and radius $\sqrt{2}$

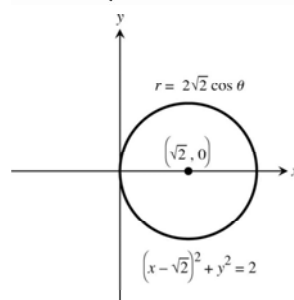

32. $r = -6 \cos \theta \Rightarrow r^2 = -6r \cos \theta \Rightarrow x^2 + y^2 + 6x = 0$
 $\Rightarrow (x+3)^2 + y^2 = 9;$
 circle with center $(-3, 0)$ and radius 3

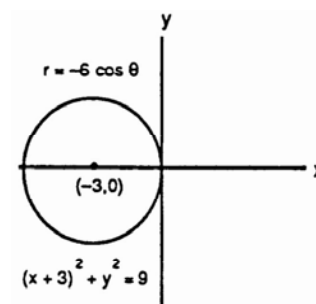

33. $x^2 + y^2 + 5y = 0 \Rightarrow x^2 + \left(y + \frac{5}{2}\right)^2 = \frac{25}{4}$
 $\Rightarrow C = \left(0, -\frac{5}{2}\right)$ and $a = \frac{5}{2};$
 $r^2 + 5r \sin \theta = 0 \Rightarrow r = -5 \sin \theta$

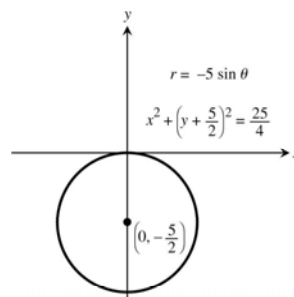

34. $x^2 + y^2 - 2y = 0 \Rightarrow x^2 + (y-1)^2 = 1$
 $\Rightarrow C = (0, 1)$ and $a = 1$;
 $r^2 - 2r \sin \theta = 0 \Rightarrow r = 2 \sin \theta$

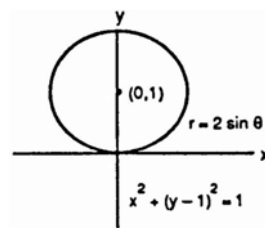

35. $x^2 + y^2 - 3x = 0 \Rightarrow (x - \frac{3}{2})^2 + y^2 = \frac{9}{4}$
 $\Rightarrow C = (\frac{3}{2}, 0)$ and $a = \frac{3}{2}$;
 $r^2 - 3r \cos \theta = 0 \Rightarrow r = 3 \cos \theta$

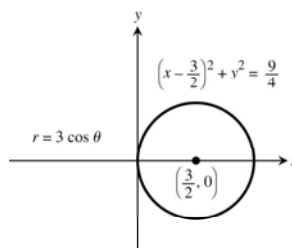

36. $x^2 + y^2 + 4x = 0 \Rightarrow (x+2)^2 + y^2 = 4$
 $\Rightarrow C = (-2, 0)$ and $a = 2$;
 $r^2 + 4r \cos \theta = 0 \Rightarrow r = -4 \cos \theta$

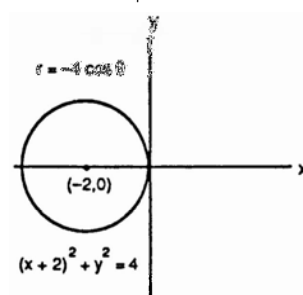

37.

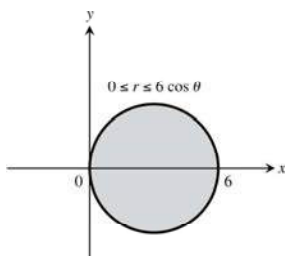

38.

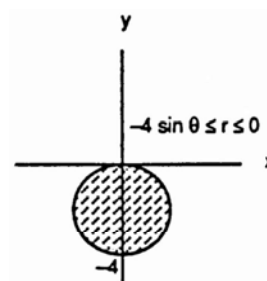

39. *d*

40. *e*

41. *l*

42. *f*

43. *k*

44. *h*

45. *i*

46. *j*

47. $A = 2 \int_0^\pi \frac{1}{2} r^2 d\theta = \int_0^\pi (2 - \cos \theta)^2 d\theta = \int_0^\pi (4 - 4 \cos \theta + \cos^2 \theta) d\theta = \int_0^\pi (4 - 4 \cos \theta + \frac{1 + \cos 2\theta}{2}) d\theta$
 $= \int_0^\pi (\frac{9}{2} - 4 \cos \theta + \frac{\cos 2\theta}{2}) d\theta = [\frac{9}{2} \theta - 4 \sin \theta + \frac{\sin 2\theta}{4}]_0^\pi = \frac{9}{2} \pi$

48. $A = \int_0^{\pi/3} \frac{1}{2} (\sin^2 3\theta) d\theta = \int_0^{\pi/3} (\frac{1 - \cos 6\theta}{2}) d\theta = \frac{1}{4} [\theta - \frac{1}{6} \sin 6\theta]_0^{\pi/3} = \frac{\pi}{12}$

49. $r = 1 + \cos 2\theta$ and $r = 1 \Rightarrow 1 = 1 + \cos 2\theta \Rightarrow 0 = \cos 2\theta \Rightarrow 2\theta = \frac{\pi}{2} \Rightarrow \theta = \frac{\pi}{4}$; therefore

$$A = 4 \int_0^{\pi/4} \frac{1}{2} [(1 + \cos 2\theta)^2 - 1^2] d\theta = 2 \int_0^{\pi/4} (1 + 2 \cos 2\theta + \cos^2 2\theta - 1) d\theta$$

$$= 2 \int_0^{\pi/4} (2 \cos 2\theta + \frac{1}{2} + \frac{\cos 4\theta}{2}) d\theta = 2 \left[\sin 2\theta + \frac{1}{2} \theta + \frac{\sin 4\theta}{8} \right]_0^{\pi/4} = 2 \left(1 + \frac{\pi}{8} + 0 \right) = 2 + \frac{\pi}{4}$$

50. The circle lies interior to the cardioid. Thus,

$$A = 2 \int_{-\pi/2}^{\pi/2} \frac{1}{2} [2(1 + \sin \theta)]^2 d\theta - \pi \quad (\text{the integral is the area of the cardioid minus the area of the circle})$$

$$= \int_{-\pi/2}^{\pi/2} 4(1 + 2 \sin \theta + \sin^2 \theta) d\theta - \pi = \int_{-\pi/2}^{\pi/2} (6 + 8 \sin \theta - 2 \cos 2\theta) d\theta - \pi = [6\theta - 8 \cos \theta - \sin 2\theta]_{-\pi/2}^{\pi/2} - \pi$$

$$= [3\pi - (-3\pi)] - \pi = 5\pi$$

51. $r = -1 + \cos \theta \Rightarrow \frac{dr}{d\theta} = -\sin \theta$; Length $= \int_0^{2\pi} \sqrt{(-1 + \cos \theta)^2 + (-\sin \theta)^2} d\theta = \int_0^{2\pi} \sqrt{2 - 2 \cos \theta} d\theta$

$$= \int_0^{2\pi} \sqrt{\frac{4(1 - \cos \theta)}{2}} d\theta = \int_0^{2\pi} 2 \sin \frac{\theta}{2} d\theta = [-4 \cos \frac{\theta}{2}]_0^{2\pi} = (-4)(-1) - (-4)(1) = 8$$

52. $r = 2 \sin \theta + 2 \cos \theta, 0 \leq \theta \leq \frac{\pi}{2} \Rightarrow \frac{dr}{d\theta} = 2 \cos \theta - 2 \sin \theta$; $r^2 + (\frac{dr}{d\theta})^2 = (2 \sin \theta + 2 \cos \theta)^2 + (2 \cos \theta - 2 \sin \theta)^2$

$$= 8(\sin^2 \theta + \cos^2 \theta) = 8 \Rightarrow L = \int_0^{\pi/2} \sqrt{8} d\theta = [2\sqrt{2}\theta]_0^{\pi/2} = 2\sqrt{2}(\frac{\pi}{2}) = \pi\sqrt{2}$$

53. $r = 8 \sin^3(\frac{\theta}{3}), 0 \leq \theta \leq \frac{\pi}{4} \Rightarrow \frac{dr}{d\theta} = 8 \sin^2(\frac{\theta}{3}) \cos(\frac{\theta}{3})$; $r^2 + (\frac{dr}{d\theta})^2 = [8 \sin^3(\frac{\theta}{3})]^2 + [8 \sin^2(\frac{\theta}{3}) \cos(\frac{\theta}{3})]^2$

$$= 64 \sin^4(\frac{\theta}{3}) \Rightarrow L = \int_0^{\pi/4} \sqrt{64 \sin^4(\frac{\theta}{3})} d\theta = \int_0^{\pi/4} 8 \sin^2(\frac{\theta}{3}) d\theta = \int_0^{\pi/4} 8 \left[\frac{1 - \cos(\frac{2\theta}{3})}{2} \right] d\theta$$

$$= \int_0^{\pi/4} [4 - 4 \cos(\frac{2\theta}{3})] d\theta = [4\theta - 6 \sin(\frac{2\theta}{3})]_0^{\pi/4} = 4(\frac{\pi}{4}) - 6 \sin(\frac{\pi}{6}) - 0 = \pi - 3$$

54. $r = \sqrt{1 + \cos 2\theta} \Rightarrow \frac{dr}{d\theta} = \frac{1}{2}(1 + \cos 2\theta)^{-1/2} (-2 \sin 2\theta) = \frac{-\sin 2\theta}{\sqrt{1 + \cos 2\theta}} \Rightarrow (\frac{dr}{d\theta})^2 = \frac{\sin^2 2\theta}{1 + \cos 2\theta}$

$$\Rightarrow r^2 + (\frac{dr}{d\theta})^2 = 1 + \cos 2\theta + \frac{\sin^2 2\theta}{1 + \cos 2\theta} = \frac{(1 + \cos 2\theta)^2 + \sin^2 2\theta}{1 + \cos 2\theta} = \frac{1 + 2 \cos 2\theta + \cos^2 2\theta + \sin^2 2\theta}{1 + \cos 2\theta}$$

$$= \frac{2 + 2 \cos 2\theta}{1 + \cos 2\theta} = 2 \Rightarrow L = \int_{-\pi/2}^{\pi/2} \sqrt{2} d\theta = \sqrt{2} \left[\frac{\pi}{2} - \left(-\frac{\pi}{2} \right) \right] = \sqrt{2}\pi$$

55. $x^2 = -4y \Rightarrow y = -\frac{x^2}{4} \Rightarrow 4p = 4 \Rightarrow p = 1$;
therefore Focus is $(0, -1)$. Directrix is $y = 1$

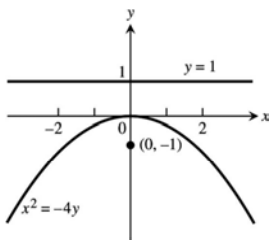

56. $x^2 = 2y \Rightarrow \frac{x^2}{2} = y \Rightarrow 4p = 2 \Rightarrow p = \frac{1}{2}$;
therefore Focus is $(0, \frac{1}{2})$; Directrix is $y = -\frac{1}{2}$

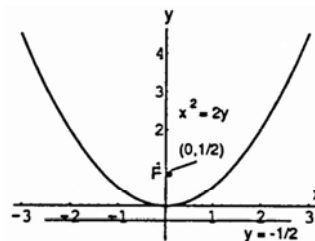

57. $y^2 = 3x \Rightarrow x = \frac{y^2}{3} \Rightarrow 4p = 3 \Rightarrow p = \frac{3}{4}$;
therefore Focus is $(\frac{3}{4}, 0)$, Directrix is $x = -\frac{3}{4}$

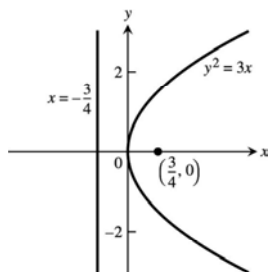

58. $y^2 = -\frac{8}{3}x \Rightarrow x = -\frac{y^2}{(8/3)} \Rightarrow 4p = \frac{8}{3} \Rightarrow p = \frac{2}{3}$;
therefore Focus is $(-\frac{2}{3}, 0)$, Directrix is $x = \frac{2}{3}$

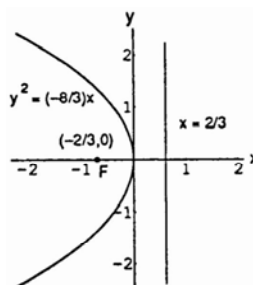

59. $16x^2 + 7y^2 = 112 \Rightarrow \frac{x^2}{7} + \frac{y^2}{16} = 1$
 $\Rightarrow c^2 = 16 - 7 = 9 \Rightarrow c = 3; e = \frac{c}{a} = \frac{3}{4}$

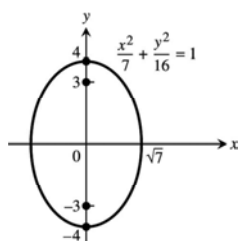

60. $x^2 + 2y^2 = 4 \Rightarrow \frac{x^2}{4} + \frac{y^2}{2} = 1 \Rightarrow c^2 = 4 - 2 = 2$
 $\Rightarrow c = \sqrt{2}; e = \frac{c}{a} = \frac{\sqrt{2}}{2}$

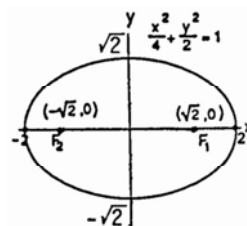

61. $3x^2 - y^2 = 3 \Rightarrow x^2 - \frac{y^2}{3} = 1 \Rightarrow c^2 = 1 + 3 = 4$
 $\Rightarrow c = 2; e = \frac{c}{a} = \frac{2}{1} = 2$;

the asymptotes are $y = \pm\sqrt{3}x$

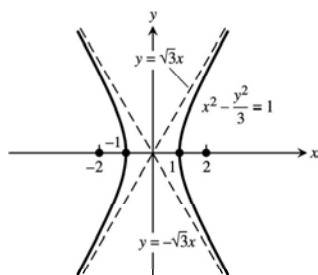

62. $5y^2 - 4x^2 = 20 \Rightarrow \frac{y^2}{4} - \frac{x^2}{5} = 1 \Rightarrow c^2 = 4 + 5 = 9$
 $\Rightarrow c = 3, e = \frac{c}{a} = \frac{3}{2}$; the asymptotes are $y = \pm\frac{2}{\sqrt{5}}x$

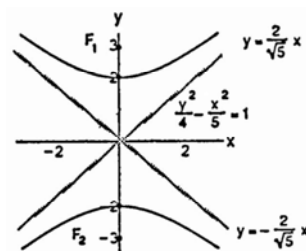

63. $x^2 = -12y \Rightarrow -\frac{x^2}{12} = y \Rightarrow 4p = 12 \Rightarrow p = 3 \Rightarrow$ focus is $(0, -3)$, directrix is $y = 3$, vertex is $(0, 0)$; therefore new vertex is $(2, 3)$, new focus is $(2, 0)$, new directrix is $y = 6$, and the new equation is $(x - 2)^2 = -12(y - 3)$

64. $y^2 = 10x \Rightarrow \frac{y^2}{10} = x \Rightarrow 4p = 10 \Rightarrow p = \frac{5}{2} \Rightarrow$ focus is $(\frac{5}{2}, 0)$, directrix is $x = -\frac{5}{2}$, vertex is $(0, 0)$; therefore new vertex is $(-\frac{1}{2}, -1)$, new focus is $(2, -1)$, new directrix is $x = -3$, and the new equation is $(y + 1)^2 = 10(x + \frac{1}{2})$

65. $\frac{x^2}{9} + \frac{y^2}{25} = 1 \Rightarrow a = 5$ and $b = 3 \Rightarrow c = \sqrt{25-9} = 4 \Rightarrow$ foci are $(0, \pm 4)$, vertices are $(0, \pm 5)$, center is $(0, 0)$; therefore the new center is $(-3, -5)$, new foci are $(-3, -1)$ and $(-3, -9)$, new vertices are $(-3, -10)$ and $(-3, 0)$, and the new equation is $\frac{(x+3)^2}{9} + \frac{(y+5)^2}{25} = 1$
66. $\frac{x^2}{169} + \frac{y^2}{144} = 1 \Rightarrow a = 13$ and $b = 12 \Rightarrow c = \sqrt{169-144} = 5 \Rightarrow$ foci are $(\pm 5, 0)$, vertices are $(\pm 13, 0)$, center is $(0, 0)$; therefore the new center is $(5, 12)$, new foci are $(10, 12)$ and $(0, 12)$, new vertices are $(18, 12)$ and $(-8, 12)$, and the new equation is $\frac{(x-5)^2}{169} + \frac{(y-12)^2}{144} = 1$
67. $\frac{y^2}{8} - \frac{x^2}{2} = 1 \Rightarrow a = 2\sqrt{2}$ and $b = \sqrt{2} \Rightarrow c = \sqrt{8+2} = \sqrt{10} \Rightarrow$ foci are $(0, \pm\sqrt{10})$, vertices are $(0, \pm 2\sqrt{2})$, center is $(0, 0)$, and the asymptotes are $y = \pm 2x$; therefore the new center is $(2, 2\sqrt{2})$, new foci are $(2, 2\sqrt{2} \pm \sqrt{10})$, new vertices are $(2, 4\sqrt{2})$ and $(2, 0)$, the new asymptotes are $y = 2x - 4 + 2\sqrt{2}$ and $y = -2x + 4 + 2\sqrt{2}$; the new equation is $\frac{(y-2\sqrt{2})^2}{8} - \frac{(x-2)^2}{2} = 1$
68. $\frac{x^2}{36} - \frac{y^2}{64} = 1 \Rightarrow a = 6$ and $b = 8 \Rightarrow c = \sqrt{36+64} = 10 \Rightarrow$ foci are $(\pm 10, 0)$, vertices are $(\pm 6, 0)$, the center is $(0, 0)$ and the asymptotes are $\frac{y}{8} = \pm \frac{x}{6}$ or $y = \pm \frac{4}{3}x$; therefore the new center is $(-10, -3)$, the new foci are $(-20, -3)$ and $(0, -3)$, the new vertices are $(-16, -3)$ and $(-4, -3)$, the new asymptotes are $y = \frac{4}{3}x + \frac{31}{3}$ and $y = -\frac{4}{3}x - \frac{49}{3}$; the new equation is $\frac{(x+10)^2}{36} - \frac{(y+3)^2}{64} = 1$
69. $x^2 - 4x - 4y^2 = 0 \Rightarrow x^2 - 4x + 4 - 4y^2 = 4 \Rightarrow (x-2)^2 - 4y^2 = 4 \Rightarrow \frac{(x-2)^2}{4} - y^2 = 1$, a hyperbola; $a = 2$ and $b = 1 \Rightarrow c = \sqrt{1+4} = \sqrt{5}$; the center is $(2, 0)$, the vertices are $(0, 0)$ and $(4, 0)$; the foci are $(2 \pm \sqrt{5}, 0)$ and the asymptotes are $y = \pm \frac{x-2}{2}$
70. $4x^2 - y^2 + 4y = 8 \Rightarrow 4x^2 - y^2 + 4y - 4 = 4 \Rightarrow 4x^2 - (y-2)^2 = 4 \Rightarrow x^2 - \frac{(y-2)^2}{4} = 1$, a hyperbola; $a = 1$ and $b = 2 \Rightarrow c = \sqrt{1+4} = \sqrt{5}$; the center is $(0, 2)$, the vertices are $(1, 2)$ and $(-1, 2)$, the foci are $(\pm\sqrt{5}, 2)$ and the asymptotes are $y = \pm 2x + 2$
71. $y^2 - 2y + 16x = -49 \Rightarrow y^2 - 2y + 1 = -16x - 48 \Rightarrow (y-1)^2 = -16(x+3)$, a parabola; the vertex is $(-3, 1)$; $4p = 16 \Rightarrow p = 4 \Rightarrow$ the focus is $(-7, 1)$ and the directrix is $x = 1$
72. $x^2 - 2x + 8y = -17 \Rightarrow x^2 - 2x + 1 = -8y - 16 \Rightarrow (x-1)^2 = -8(y+2)$, a parabola; the vertex is $(1, -2)$; $4p = 8 \Rightarrow p = 2 \Rightarrow$ the focus is $(1, -4)$ and the directrix is $y = 0$

73. $9x^2 + 16y^2 + 54x - 64y = -1 \Rightarrow 9(x^2 + 6x) + 16(y^2 - 4y) = -1 \Rightarrow 9(x^2 + 6x + 9) + 16(y^2 - 4y + 4) = 144$
 $\Rightarrow 9(x+3)^2 + 16(y-2)^2 = 144 \Rightarrow \frac{(x+3)^2}{16} + \frac{(y-2)^2}{9} = 1$, an ellipse; the center is $(-3, 2)$; $a = 4$ and $b = 3$
 $\Rightarrow c = \sqrt{16-9} = \sqrt{7}$; the foci are $(-3 \pm \sqrt{7}, 2)$; the vertices are $(1, 2)$ and $(-7, 2)$

74. $25x^2 + 9y^2 - 100x + 54y = 44 \Rightarrow 25(x^2 - 4x) + 9(y^2 + 6y) = 44 \Rightarrow 25(x^2 - 4x + 4) + 9(y^2 + 6y + 9) = 225$
 $\Rightarrow \frac{(x-2)^2}{9} + \frac{(y+3)^2}{25} = 1$, an ellipse; the center is $(2, -3)$; $a = 5$ and $b = 3 \Rightarrow c = \sqrt{25-9} = 4$; the foci are $(2, 1)$
and $(2, -7)$; the vertices are $(2, 2)$ and $(2, -8)$

75. $x^2 + y^2 - 2x - 2y = 0 \Rightarrow x^2 - 2x + 1 + y^2 - 2y + 1 = 2 \Rightarrow (x-1)^2 + (y-1)^2 = 2$, a circle with center $(1, 1)$ and
radius $= \sqrt{2}$

76. $x^2 + y^2 + 4x + 2y = 1 \Rightarrow x^2 + 4x + 4 + y^2 + 2y + 1 = 6 \Rightarrow (x+2)^2 + (y+1)^2 = 6$, a circle with center $(-2, -1)$
and radius $= \sqrt{6}$

77. $r = \frac{2}{1 + \cos \theta} \Rightarrow e = 1 \Rightarrow$ parabola with vertex at $(1, 0)$

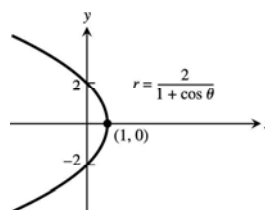

78. $r = \frac{8}{2 + \cos \theta} \Rightarrow r = \frac{4}{1 + (\frac{1}{2})\cos \theta} \Rightarrow e = \frac{1}{2} \Rightarrow$ ellipse;
 $ke = 4 \Rightarrow \frac{1}{2}k = 4 \Rightarrow k = 8$; $k = \frac{a}{e} - ea \Rightarrow 8 = \frac{a}{(\frac{1}{2})} - \frac{1}{2}a$
 $\Rightarrow a = \frac{16}{3} \Rightarrow ea = (\frac{1}{2})(\frac{16}{3}) = \frac{8}{3}$; therefore the center is
 $(\frac{8}{3}, \pi)$; vertices are $(8, \pi)$ and $(\frac{8}{3}, 0)$

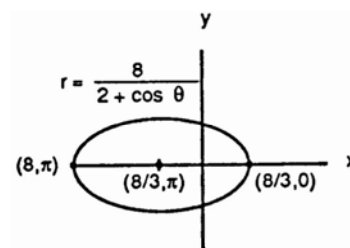

79. $r = \frac{6}{1 - 2\cos \theta} \Rightarrow e = 2 \Rightarrow$ hyperbola; $ke = 6 \Rightarrow 2k = 6$
 $\Rightarrow k = 3 \Rightarrow$ vertices are $(2, \pi)$ and $(6, \pi)$

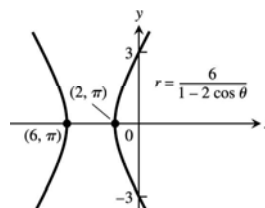

80. $r = \frac{12}{3 + \sin \theta} \Rightarrow r = \frac{4}{1 + (\frac{1}{3})\sin \theta} \Rightarrow e = \frac{1}{3}$; $ke = 4$
 $\Rightarrow \frac{1}{3}k = 4 \Rightarrow k = 12$; $a(1 - e^2)4 \Rightarrow a[1 - (\frac{1}{3})^2] = 4$
 $\Rightarrow a = \frac{9}{2} \Rightarrow ea = (\frac{1}{3})(\frac{9}{2}) = \frac{3}{2}$; therefore the center is
 $(\frac{3}{2}, \frac{3\pi}{2})$; vertices are $(3, \frac{\pi}{2})$ and $(6, \frac{3\pi}{2})$

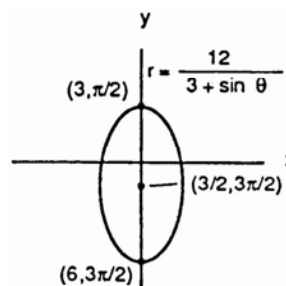

81. $e = 2$ and $r \cos \theta = 2 \Rightarrow x = 2$ is directrix $\Rightarrow k = 2$; the conic is a hyperbola; $r = \frac{ke}{1+e \cos \theta} \Rightarrow r = \frac{(2)(2)}{1+2 \cos \theta}$
 $\Rightarrow r = \frac{4}{1+2 \cos \theta}$

82. $e = 1$ and $r \cos \theta = -4 \Rightarrow x = -4$ is directrix $\Rightarrow k = 4$; the conic is a parabola; $r = \frac{ke}{1-e \cos \theta} \Rightarrow r = \frac{(4)(1)}{1-\cos \theta}$
 $\Rightarrow r = \frac{4}{1-\cos \theta}$

83. $e = \frac{1}{2}$ and $r \sin \theta = 2 \Rightarrow y = 2$ is directrix $\Rightarrow k = 2$; the conic is an ellipse; $r = \frac{ke}{1+e \sin \theta} \Rightarrow r = \frac{(2)(\frac{1}{2})}{1+(\frac{1}{2}) \sin \theta}$
 $\Rightarrow r = \frac{2}{2+\sin \theta}$

84. $e = \frac{1}{3}$ and $r \sin \theta = -6 \Rightarrow y = -6$ is directrix $\Rightarrow k = 6$; the conic is an ellipse; $r = \frac{ke}{1-e \sin \theta} \Rightarrow r = \frac{(6)(\frac{1}{3})}{1-(\frac{1}{3}) \sin \theta}$
 $\Rightarrow r = \frac{6}{3-\sin \theta}$

85. (a) Around the x -axis: $9x^2 + 4y^2 = 36 \Rightarrow y^2 = 9 - \frac{9}{4}x^2 \Rightarrow y = \pm \sqrt{9 - \frac{9}{4}x^2}$ and we use the positive root:

$$V = 2 \int_0^2 \pi \left(\sqrt{9 - \frac{9}{4}x^2} \right)^2 dx = 2 \int_0^2 \pi \left(9 - \frac{9}{4}x^2 \right) dx = 2\pi \left[9x - \frac{3}{4}x^3 \right]_0^2 = 24\pi$$

(b) Around the y -axis: $9x^2 + 4y^2 = 36 \Rightarrow x^2 = 4 - \frac{4}{9}y^2 \Rightarrow x = \pm \sqrt{4 - \frac{4}{9}y^2}$ and we use the positive root:

$$V = 2 \int_0^3 \pi \left(\sqrt{4 - \frac{4}{9}y^2} \right)^2 dy = 2 \int_0^3 \pi \left(4 - \frac{4}{9}y^2 \right) dy = 2\pi \left[4y - \frac{4}{27}y^3 \right]_0^3 = 16\pi$$

86. $9x^2 - 4y^2 = 36, x = 4 \Rightarrow y^2 = \frac{9x^2 - 36}{4} \Rightarrow y = \frac{3}{2}\sqrt{x^2 - 4}$; $V = \int_2^4 \pi \left(\frac{3}{2}\sqrt{x^2 - 4} \right)^2 dx = \frac{9\pi}{4} \int_2^4 (x^2 - 4) dx$
 $= \frac{9\pi}{4} \left[\frac{x^3}{3} - 4x \right]_2^4 = \frac{9\pi}{4} \left[\left(\frac{64}{3} - 16 \right) - \left(\frac{8}{3} - 8 \right) \right] = \frac{9\pi}{4} \left(\frac{56}{3} - \frac{24}{3} \right) = \frac{3\pi}{4} (32) = 24\pi$

87. (a) $r = \frac{k}{1+e \cos \theta} \Rightarrow r + er \cos \theta = k \Rightarrow \sqrt{x^2 + y^2} + ex = k \Rightarrow \sqrt{x^2 + y^2} = k - ex \Rightarrow x^2 + y^2 = k^2 - 2kex + e^2x^2$
 $\Rightarrow x^2 - e^2x^2 + y^2 + 2kex - k^2 = 0 \Rightarrow (1 - e^2)x^2 + y^2 + 2kex - k^2 = 0$

(b) $e = 0 \Rightarrow x^2 + y^2 - k^2 = 0 \Rightarrow x^2 + y^2 = k^2 \Rightarrow$ circle;

$0 < e < 1 \Rightarrow e^2 < 1 \Rightarrow e^2 - 1 < 0 \Rightarrow B^2 - 4AC = 0^2 - 4(1 - e^2)(1) = 4(e^2 - 1) < 0 \Rightarrow$ ellipse;

$e = 1 \Rightarrow B^2 - 4AC = 0^2 - 4(0)(1) = 0 \Rightarrow$ parabola;

$e > 1 \Rightarrow e^2 > 1 \Rightarrow B^2 - 4AC = 0^2 - 4(1 - e^2)(1) = 4e^2 - 4 > 0 \Rightarrow$ hyperbola

88. Let (r_1, θ_1) be a point on the graph where $r_1 = a\theta_1$. Let (r_2, θ_2) be on the graph where $r_2 = a\theta_2$ and $\theta_2 = \theta_1 + 2\pi$. Then r_1 and r_2 lie on the same ray on consecutive turns of the spiral and the distance between the two points is $r_2 - r_1 = a\theta_2 - a\theta_1 = a(\theta_2 - \theta_1) = 2\pi a$, which is constant.

CHAPTER 11 ADDITIONAL AND ADVANCED EXERCISES

1. Directrix $x = 3$ and focus $(4, 0) \Rightarrow$ vertex is $(\frac{7}{2}, 0)$

$\Rightarrow p = \frac{1}{2} \Rightarrow$ the equation is $x - \frac{7}{2} = \frac{y^2}{2}$

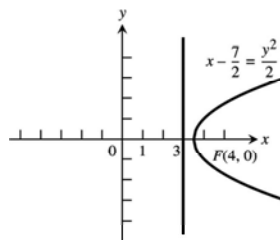

2. $x^2 - 6x - 12y + 9 = 0 \Rightarrow x^2 - 6x + 9 = 12y \Rightarrow \frac{(x-3)^2}{12} = y \Rightarrow$ vertex is $(3, 0)$ and $p = 3 \Rightarrow$ focus is $(3, 3)$ and the directrix is $y = -3$

3. $x^2 = 4y \Rightarrow$ vertex is $(0, 0)$ and $p = 1 \Rightarrow$ focus is $(0, 1)$; thus the distance from $P(x, y)$ to the vertex is $\sqrt{x^2 + y^2}$ and the distance from P to the focus is $\sqrt{x^2 + (y-1)^2} \Rightarrow \sqrt{x^2 + y^2} = 2\sqrt{x^2 + (y-1)^2}$
 $\Rightarrow x^2 + y^2 = 4[x^2 + (y-1)^2] \Rightarrow x^2 + y^2 = 4x^2 + 4y^2 - 8y + 4 \Rightarrow 3x^2 + 3y^2 - 8y + 4 = 0$, which is a circle

4. Let the segment $a + b$ intersect the y -axis in point A and intersect the x -axis in point B so that $PB = b$ and $PA = a$ (see figure). Draw the horizontal line through P and let it intersect the y -axis in point C . Let $\angle PBO = \theta$

$\Rightarrow \angle APC = \theta$. Then $\sin \theta = \frac{y}{b}$ and $\cos \theta = \frac{x}{a}$
 $\Rightarrow \frac{x^2}{a^2} + \frac{y^2}{b^2} = \cos^2 \theta + \sin^2 \theta = 1$.

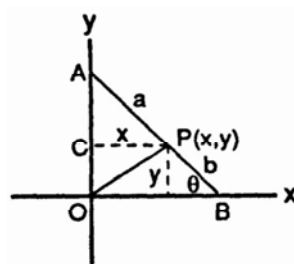

5. Vertices are $(0, \pm 2) \Rightarrow a = 2; e = \frac{c}{a} \Rightarrow 0.5 = \frac{c}{2} \Rightarrow c = 1 \Rightarrow$ foci are $(0, \pm 1)$

6. Let the center of the ellipse be $(x, 0)$; directrix $x = 2$, focus $(4, 0)$, and $e = \frac{2}{3} \Rightarrow \frac{a}{e} - c = 2 \Rightarrow \frac{a}{e} = 2 + c$
 $\Rightarrow a = \frac{2}{3}(2 + c)$. Also $c = ae = \frac{2}{3}a \Rightarrow a = \frac{2}{3}(2 + \frac{2}{3}a) \Rightarrow a = \frac{4}{3} + \frac{4}{9}a \Rightarrow \frac{5}{9}a = \frac{4}{3} \Rightarrow a = \frac{12}{5}$;

$x - 2 = \frac{a}{e} \Rightarrow x - 2 = (\frac{12}{5})(\frac{3}{2}) = \frac{18}{5} \Rightarrow x = \frac{28}{5} \Rightarrow$ the center is $(\frac{28}{5}, 0)$; $x - 4 = c \Rightarrow c = \frac{28}{5} - 4 = \frac{8}{5}$ so that

$c^2 = a^2 - b^2 = (\frac{12}{5})^2 - (\frac{8}{5})^2 = \frac{80}{25}$; therefore the equation is $\frac{(x - \frac{28}{5})^2}{(\frac{144}{25})} + \frac{y^2}{(\frac{80}{25})} = 1$ or $\frac{25(x - \frac{28}{5})^2}{144} + \frac{5y^2}{16} = 1$

7. Let the center of the hyperbola be $(0, y)$.

(a) Directrix $y = -1$, focus $(0, -7)$ and $e = 2 \Rightarrow c - \frac{a}{e} = 6 \Rightarrow \frac{a}{e} = c - 6 \Rightarrow a = 2c - 12$. Also $c = ae = 2a$
 $\Rightarrow a = 2(2a) - 12 \Rightarrow a = 4 \Rightarrow c = 8; y - (-1) = \frac{a}{e} = \frac{4}{2} = 2 \Rightarrow y = 1 \Rightarrow$ the center is $(0, 1)$;

$c^2 = a^2 + b^2 \Rightarrow b^2 = c^2 - a^2 = 64 - 16 = 48$; therefore the equation is $\frac{(y-1)^2}{16} - \frac{x^2}{48} = 1$

(b) $e = 5 \Rightarrow c - \frac{a}{e} = 6 \Rightarrow \frac{a}{e} = c - 6 \Rightarrow a = 5c - 30$. Also, $c = ae = 5a \Rightarrow a = 5(5a) - 30 \Rightarrow 24a = 30 \Rightarrow a = \frac{5}{4}$
 $\Rightarrow c = \frac{25}{4}$; $y - (-1) = \frac{a}{e} = \frac{(\frac{5}{4})}{5} = \frac{1}{4} \Rightarrow y = -\frac{3}{4} \Rightarrow$ the center is $(0, -\frac{3}{4})$; $c^2 = a^2 + b^2 \Rightarrow b^2 = c^2 - a^2$
 $= \frac{625}{16} - \frac{25}{16} = \frac{75}{2}$; therefore the equation is $\frac{(y + \frac{3}{4})^2}{(\frac{25}{16})} - \frac{x^2}{(\frac{75}{2})} = 1$ or $\frac{16(y + \frac{3}{4})^2}{25} - \frac{2x^2}{75} = 1$

8. The center is $(0, 0)$ and $c = 2 \Rightarrow 4 = a^2 + b^2 \Rightarrow b^2 = 4 - a^2$. The equation is $\frac{y^2}{a^2} - \frac{x^2}{b^2} = 1 \Rightarrow \frac{49}{a^2} - \frac{144}{b^2} = 1$
 $\Rightarrow \frac{49}{a^2} - \frac{144}{(4-a^2)} = 1 \Rightarrow 49(4-a^2) - 144a^2 = a^2(4-a^2) \Rightarrow 196 - 49a^2 - 144a^2 = 4a^2 - a^4$
 $\Rightarrow a^4 - 197a^2 + 196 = 0 \Rightarrow (a^2 - 196)(a^2 - 1) = 0 \Rightarrow a = 14$ or $a = 1$; $a = 14 \Rightarrow b^2 = 4 - (14)^2 < 0$ which is impossible; $a = 1 \Rightarrow b^2 = 4 - 1 = 3$; therefore the equation is $y^2 - \frac{x^2}{3} = 1$

9. $b^2x^2 + a^2y^2 = a^2b^2 \Rightarrow \frac{dy}{dx} = -\frac{b^2x}{a^2y}$; at (x_1, y_1) the tangent line is $y - y_1 = \left(-\frac{b^2x_1}{a^2y_1}\right)(x - x_1)$
 $\Rightarrow a^2yy_1 + b^2xx_1 = b^2x_1^2 + a^2y_1^2 = a^2b^2 \Rightarrow b^2xx_1 + a^2yy_1 - a^2b^2 = 0$

10. $b^2x^2 - a^2y^2 = a^2b^2 \Rightarrow \frac{dy}{dx} = \frac{b^2x}{a^2y}$; at (x_1, y_1) the tangent line is $y - y_1 = \left(\frac{b^2x_1}{a^2y_1}\right)(x - x_1)$
 $\Rightarrow b^2xx_1 - a^2yy_1 = b^2x_1^2 - a^2y_1^2 = a^2b^2 \Rightarrow b^2xx_1 - a^2yy_1 - a^2b^2 = 0$

11.

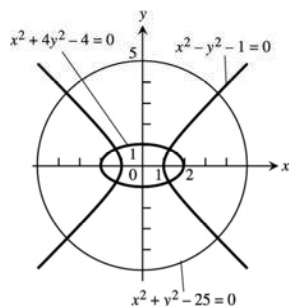

12.

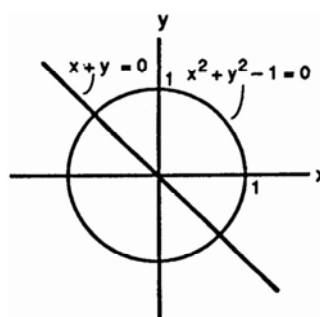

13.

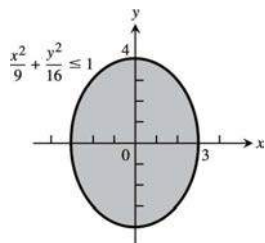

14.

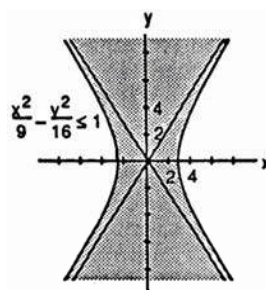

15. $(9x^2 + 4y^2 - 36)(4x^2 + 9y^2 - 16) \leq 0$
 $\Rightarrow 9x^2 + 4y^2 - 36 \leq 0$ and $4x^2 + 9y^2 - 16 \geq 0$ or
 $9x^2 + 4y^2 - 36 \geq 0$ and $4x^2 + 9y^2 - 16 \leq 0$

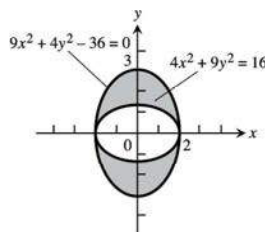

16. $(9x^2 + 4y^2 - 36)(4x^2 + 9y^2 - 16) > 0$, which is the complement of the set in Exercise 15

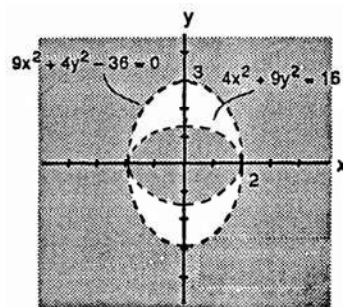

17. (a) $x = e^{2t} \cos t$ and $y = e^{2t} \sin t \Rightarrow x^2 + y^2 = e^{4t} \cos^2 t + e^{4t} \sin^2 t = e^{4t}$. Also $\frac{y}{x} = \frac{e^{2t} \sin t}{e^{2t} \cos t} = \tan t$
 $\Rightarrow t = \tan^{-1}\left(\frac{y}{x}\right) \Rightarrow x^2 + y^2 = e^{4 \tan^{-1}(y/x)}$ is the Cartesian equation. Since $r^2 = x^2 + y^2$ and $\theta = \tan^{-1}\left(\frac{y}{x}\right)$, the polar equation is $r^2 = e^{4\theta}$ or $r = e^{2\theta}$ for $r > 0$

(b) $ds^2 = r^2 d\theta^2 + dr^2; r = e^{2\theta} \Rightarrow dr = 2e^{2\theta} d\theta$
 $\Rightarrow ds^2 = r^2 d\theta^2 + (2e^{2\theta} d\theta)^2 = (e^{2\theta})^2 d\theta^2 + 4e^{4\theta} d\theta^2$
 $= 5e^{4\theta} d\theta^2 \Rightarrow ds = \sqrt{5}e^{2\theta} d\theta$
 $\Rightarrow L = \int_0^{2\pi} \sqrt{5}e^{2\theta} d\theta = \left[\frac{\sqrt{5}e^{2\theta}}{2}\right]_0^{2\pi} = \frac{\sqrt{5}}{2}(e^{4\pi} - 1)$

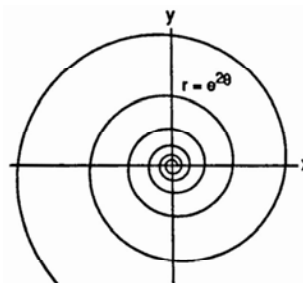

18. $r = 2 \sin^3\left(\frac{\theta}{3}\right) \Rightarrow dr = 2 \sin^2\left(\frac{\theta}{3}\right) \cos\left(\frac{\theta}{3}\right) d\theta \Rightarrow ds^2 = r^2 d\theta^2 + dr^2$
 $= \left[2 \sin^3\left(\frac{\theta}{3}\right)\right]^2 d\theta^2 + \left[2 \sin^2\left(\frac{\theta}{3}\right) \cos\left(\frac{\theta}{3}\right) d\theta\right]^2 = 4 \sin^6\left(\frac{\theta}{3}\right) d\theta^2 + 4 \sin^4\left(\frac{\theta}{3}\right) \cos^2\left(\frac{\theta}{3}\right) d\theta^2$
 $= \left[4 \sin^4\left(\frac{\theta}{3}\right)\right] \left[\sin^2\left(\frac{\theta}{3}\right) + \cos^2\left(\frac{\theta}{3}\right)\right] d\theta^2 = 4 \sin^4\left(\frac{\theta}{3}\right) d\theta^2 \Rightarrow ds = 2 \sin^2\left(\frac{\theta}{3}\right) d\theta.$

Then $L = \int_0^{3\pi} 2 \sin^2\left(\frac{\theta}{3}\right) d\theta = \int_0^{3\pi} \left[1 - \cos\left(\frac{2\theta}{3}\right)\right] d\theta = \left[\theta - \frac{3}{2} \sin\left(\frac{2\theta}{3}\right)\right]_0^{3\pi} = 3\pi$

19. $e = 2$ and $r \cos \theta = 2 \Rightarrow x = 2$ is the directrix $\Rightarrow k = 2$; the conic is a hyperbola with $r = \frac{ke}{1 + e \cos \theta}$
 $\Rightarrow r = \frac{(2)(2)}{1 + 2 \cos \theta} = \frac{4}{1 + 2 \cos \theta}$

20. $e = 1$ and $r \cos \theta = -4 \Rightarrow x = -4$ is the directrix $\Rightarrow k = 4$; the conic is a parabola with $r = \frac{ke}{1 - e \cos \theta}$

$$\Rightarrow r = \frac{(4)(1)}{1 - \cos \theta} = \frac{4}{1 - \cos \theta}$$

21. $e = \frac{1}{2}$ and $r \sin \theta = 2 \Rightarrow y = 2$ is the directrix $\Rightarrow k = 2$; the conic is an ellipse with $r = \frac{ke}{1 + e \sin \theta}$

$$\Rightarrow r = \frac{2(\frac{1}{2})}{1 + (\frac{1}{2})\sin \theta} = \frac{2}{2 + \sin \theta}$$

22. $e = \frac{1}{3}$ and $r \sin \theta = -6 \Rightarrow y = -6$ is the directrix $\Rightarrow k = 6$; the conic is an ellipse with $r = \frac{ke}{1 - e \sin \theta}$

$$\Rightarrow r = \frac{6(\frac{1}{3})}{1 - (\frac{1}{3})\sin \theta} = \frac{6}{3 - \sin \theta}$$

23. Arc $PF =$ Arc AF since each is the distance rolled;

$$\angle PCF = \frac{\text{Arc } PF}{b} \Rightarrow \text{Arc } PF = b(\angle PCF);$$

$$\theta = \frac{\text{Arc } AF}{a} \Rightarrow \text{Arc } AF = a\theta \Rightarrow a\theta = b(\angle PCF)$$

$$\Rightarrow \angle PCF = \left(\frac{a}{b}\right)\theta; \quad \angle OCB = \frac{\pi}{2} - \theta \text{ and}$$

$$\angle OCB = \angle PCF - \angle PCE = \angle PCF - \left(\frac{\pi}{2} - \alpha\right)$$

$$= \left(\frac{a}{b}\right)\theta - \left(\frac{\pi}{2} - \alpha\right) \Rightarrow \frac{\pi}{2} - \theta = \left(\frac{a}{b}\right)\theta - \left(\frac{\pi}{2} - \alpha\right)$$

$$\Rightarrow \frac{\pi}{2} - \theta = \left(\frac{a}{b}\right)\theta - \frac{\pi}{2} + \alpha \Rightarrow \alpha = \pi - \theta - \left(\frac{a}{b}\right)\theta$$

$$\Rightarrow \alpha = \pi - \left(\frac{a+b}{b}\right)\theta.$$

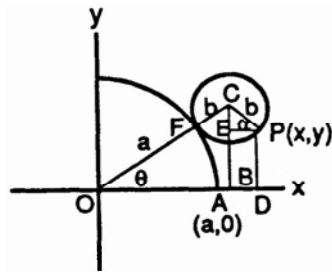

$$\text{Now } x = OB + BD = OB + EP = (a + b) \cos \theta + b \cos \alpha = (a + b) \cos \theta + b \cos \left(\pi - \left(\frac{a+b}{b}\right)\theta\right)$$

$$= (a + b) \cos \theta + b \cos \pi \cos \left(\left(\frac{a+b}{b}\right)\theta\right) + b \sin \pi \sin \left(\left(\frac{a+b}{b}\right)\theta\right) = (a + b) \cos \theta - b \cos \left(\left(\frac{a+b}{b}\right)\theta\right) \text{ and}$$

$$y = PD = CB - CE = (a + b) \sin \theta - b \sin \alpha = (a + b) \sin \theta - b \sin \left(\left(\frac{a+b}{b}\right)\theta\right)$$

$$= (a + b) \sin \theta - b \sin \pi \cos \left(\left(\frac{a+b}{b}\right)\theta\right) + b \cos \pi \sin \left(\left(\frac{a+b}{b}\right)\theta\right) = (a + b) \sin \theta - b \sin \left(\left(\frac{a+b}{b}\right)\theta\right);$$

$$\text{therefore } x = (a + b) \cos \theta - b \cos \left(\left(\frac{a+b}{b}\right)\theta\right) \text{ and } y = (a + b) \sin \theta - b \sin \left(\left(\frac{a+b}{b}\right)\theta\right)$$

24. $x = a(t - \sin t) \Rightarrow \frac{dx}{dt} = a(1 - \cos t)$ and let $\delta = 1 \Rightarrow dm = dA = y dx = y \left(\frac{dx}{dt}\right) dt = a(1 - \cos t) a(1 - \cos t) dt$

$$= a^2 (1 - \cos t)^2 dt; \text{ then } A = \int_0^{2\pi} a^2 (1 - \cos t)^2 dt = a^2 \int_0^{2\pi} (1 - 2 \cos t + \cos^2 t) dt$$

$$= a^2 \int_0^{2\pi} \left(1 - 2 \cos t + \frac{1}{2} + \frac{1}{2} \cos 2t\right) dt = a^2 \left[\frac{3}{2}t - 2 \sin t + \frac{\sin 2t}{4}\right]_0^{2\pi} = 3\pi a^2; \quad \tilde{x} = x = a(t - \sin t) \text{ and}$$

$$\tilde{y} = \frac{1}{2}y = \frac{1}{2}a(1 - \cos t) \Rightarrow M_x = \int \tilde{y} dm = \int \tilde{y} \delta dA = \int_0^{2\pi} \frac{1}{2}a(1 - \cos t) a^2 (1 - \cos t)^2 dt = \frac{1}{2}a^3 \int_0^{2\pi} (1 - \cos t)^3 dt$$

$$= \frac{a^3}{2} \int_0^{2\pi} (1 - 3 \cos t + 3 \cos^2 t - \cos^3 t) dt = \frac{a^3}{2} \int_0^{2\pi} \left[1 - 3 \cos t + \frac{3}{2} + \frac{3 \cos 2t}{2} - (1 - \sin^2 t)(\cos t)\right] dt$$

$$= \frac{a^3}{2} \left[\frac{5}{2}t - 3 \sin t + \frac{3 \sin 2t}{4} - \sin t + \frac{\sin^3 t}{3}\right]_0^{2\pi} = \frac{5\pi a^3}{2}. \text{ Therefore } \bar{y} = \frac{M_x}{M} = \frac{\left(\frac{5\pi a^3}{2}\right)}{3\pi a^2} = \frac{5}{6}a.$$

$$\begin{aligned} \text{Also, } M_y &= \int \tilde{x} dm = \int \tilde{x} \delta dA = \int_0^{2\pi} a(t - \sin t) a^2 (1 - \cos t)^2 dt \\ &= a^3 \int_0^{2\pi} (t - 2t \cos t + t \cos^2 t - \sin t + 2 \sin t \cos t - \sin t \cos^2 t) dt \\ &= a^3 \left[\frac{t^2}{2} - 2 \cos t - 2t \sin t + \frac{1}{4} t^2 + \frac{1}{8} \cos 2t + \frac{t}{4} \sin 2t + \cos t + \sin^2 t + \frac{\cos^3 t}{3} \right]_0^{2\pi} = 3\pi^2 a^3. \end{aligned}$$

Thus $\bar{x} = \frac{M_y}{M} = \frac{3\pi^2 a^3}{3\pi a^2} = \pi a \Rightarrow (\pi a, \frac{5}{6} a)$ is the center of mass.

25. $\beta = \psi_2 - \psi_1 \Rightarrow \tan \beta = \tan(\psi_2 - \psi_1) = \frac{\tan \psi_2 - \tan \psi_1}{1 + \tan \psi_2 \tan \psi_1}$;

the curves will be orthogonal when $\tan \beta$ is

undefined, or when $\tan \psi_2 = \frac{-1}{\tan \psi_1} \Rightarrow \frac{r}{g'(\theta)} = \frac{-1}{\left[\frac{r}{f'(\theta)} \right]}$

$\Rightarrow r^2 = -f'(\theta)g'(\theta)$

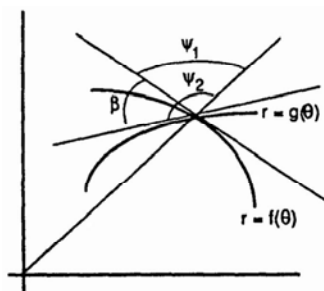

26. $r = \sin^4\left(\frac{\theta}{4}\right) \Rightarrow \frac{dr}{d\theta} = \sin^3\left(\frac{\theta}{4}\right) \cos\left(\frac{\theta}{4}\right) \Rightarrow \tan \psi = \frac{\sin^4\left(\frac{\theta}{4}\right)}{\sin^3\left(\frac{\theta}{4}\right) \cos\left(\frac{\theta}{4}\right)} = \tan\left(\frac{\theta}{4}\right)$

27. $r = 2a \sin 3\theta \Rightarrow \frac{dr}{d\theta} = 6a \cos 3\theta \Rightarrow \tan \psi = \frac{r}{\left(\frac{dr}{d\theta}\right)} = \frac{2a \sin 3\theta}{6a \cos 3\theta} = \frac{1}{3} \tan 3\theta$; when $\theta = \frac{\pi}{6}$, $\tan \psi = \frac{1}{3} \tan \frac{\pi}{2} \Rightarrow \psi = \frac{\pi}{2}$

28. (a)

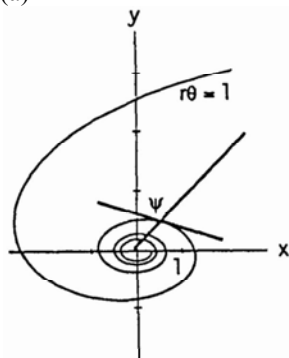

(b) $r\theta = 1 \Rightarrow r = \theta^{-1} \Rightarrow \frac{dr}{d\theta} = -\theta^{-2}$

$\Rightarrow \tan \psi |_{\theta=1} = \frac{\theta^{-1}}{-\theta^{-2}} = -\theta \Rightarrow \lim_{\theta \rightarrow \infty} \tan \psi = -\infty$

$\Rightarrow \psi \rightarrow \frac{\pi}{2}$ from the right as the spiral winds in around the origin.

29. $\tan \psi_1 = \frac{\sqrt{3} \cos \theta}{-\sqrt{3} \sin \theta} = -\cot \theta$ is $-\frac{1}{\sqrt{3}}$ at $\theta = \frac{\pi}{3}$; $\tan \psi_2 = \frac{\sin \theta}{\cos \theta} = \tan \theta$ is $\sqrt{3}$ at $\theta = \frac{\pi}{3}$; since the product of these slopes is -1 , the tangents are perpendicular

30. $\tan \psi = \frac{r}{\left(\frac{dr}{d\theta}\right)} = \frac{a(1-\cos \theta)}{a \sin \theta}$ is 1 at $\theta = \frac{\pi}{2} \Rightarrow \psi = \frac{\pi}{4}$

CHAPTER 12 VECTORS AND THE GEOMETRY OF SPACE

12.1 THREE-DIMENSIONAL COORDINATE SYSTEMS

1. The line through the point $(2, 3, 0)$ parallel to the z -axis
2. The line through the point $(-1, 0, 0)$ parallel to the y -axis
3. The x -axis
4. The line through the point $(1, 0, 0)$ parallel to the z -axis
5. The circle $x^2 + y^2 = 4$ in the xy -plane
6. The circle $x^2 + y^2 = 4$ in the plane $z = -2$
7. The circle $x^2 + z^2 = 4$ in the xz -plane
8. The circle $y^2 + z^2 = 1$ in the yz -plane
9. The circle $y^2 + z^2 = 1$ in the yz -plane
10. The circle $x^2 + z^2 = 9$ in the plane $y = -4$
11. The circle $x^2 + y^2 = 16$ in the xy -plane
12. The circle $x^2 + z^2 = 3$ in the xz -plane
13. The ellipse formed by the intersection of the cylinder $x^2 + y^2 = 4$ and the plane $z = y$.
14. The circle formed by the intersection of the sphere $x^2 + y^2 + z^2 = 4$ and the plane $y = x$.
15. The parabola $y = x^2$ in the xy -plane.
16. The parabola $z = y^2$ in the plane $x = 1$.
17. (a) The first quadrant of the xy -plane (b) The fourth quadrant of the xy -plane
18. (a) The slab bounded by the planes $x = 0$ and $x = 1$
(b) The square column bounded by the planes $x = 0, x = 1, y = 0, y = 1$
(c) The unit cube in the first octant having one vertex at the origin

19. (a) The solid ball of radius 1 centered at the origin
 (b) The exterior of the sphere of radius 1 centered at the origin
20. (a) The circumference and interior of the circle $x^2 + y^2 = 1$ in the xy -plane
 (b) The circumference and interior of the circle $x^2 + y^2 = 1$ in the plane $z = 3$
 (c) A solid cylindrical column of radius 1 whose axis is the z -axis
21. (a) The solid enclosed between the sphere of radius 1 and radius 2 centered at the origin
 (b) The solid upper hemisphere of radius 1 centered at the origin
22. (a) The line $y = x$ in the xy -plane
 (b) The plane $y = x$ consisting of all points of the form (x, x, z)
23. (a) The region on or inside the parabola $y = x^2$ in the xy -plane and all points above this region.
 (b) The region on or to the left of the parabola $x = y^2$ in the xy -plane and all points above it that are 2 units or less away from the xy -plane.
24. (a) All the points that lie on the plane $z = 1 - y$.
 (b) All points that lie on the curve $z = y^3$ in the plane $x = -2$.
25. (a) $x = 3$ (b) $y = -1$ (c) $z = -2$
26. (a) $x = 3$ (b) $y = -1$ (c) $z = 2$
27. (a) $z = 1$ (b) $x = 3$ (c) $y = -1$
28. (a) $x^2 + y^2 = 4, z = 0$ (b) $y^2 + z^2 = 4, x = 0$ (c) $x^2 + z^2 = 4, y = 0$
29. (a) $x^2 + (y - 2)^2 = 4, z = 0$ (b) $(y - 2)^2 + z^2 = 4, x = 0$ (c) $x^2 + z^2 = 4, y = 2$
30. (a) $(x + 3)^2 + (y - 4)^2 = 1, z = 1$ (b) $(y - 4)^2 + (z - 1)^2 = 1, x = -3$ (c) $(x + 3)^2 + (z - 1)^2 = 1, y = 4$
31. (a) $y = 3, z = -1$ (b) $x = 1, z = -1$ (c) $x = 1, y = 3$
32. $\sqrt{x^2 + y^2 + z^2} = \sqrt{x^2 + (y - 2)^2 + z^2} \Rightarrow x^2 + y^2 + z^2 = x^2 + (y - 2)^2 + z^2 \Rightarrow y^2 = y^2 - 4y + 4 \Rightarrow y = 1$
33. $x^2 + y^2 + z^2 = 25, z = 3 \Rightarrow x^2 + y^2 = 16$ in the plane $z = 3$
34. $x^2 + y^2 + (z - 1)^2 = 4$ and $x^2 + y^2 + (z + 1)^2 = 4 \Rightarrow x^2 + y^2 + (z - 1)^2 = x^2 + y^2 + (z + 1)^2 \Rightarrow z = 0, x^2 + y^2 = 3$
35. $0 \leq z \leq 1$ 36. $0 \leq x \leq 2, 0 \leq y \leq 2, 0 \leq z \leq 2$
37. $z \leq 0$ 38. $z = \sqrt{1 - x^2 - y^2}$

39. (a) $(x-1)^2 + (y-1)^2 + (z-1)^2 < 1$ (b) $(x-1)^2 + (y-1)^2 + (z-1)^2 > 1$
40. $1 \leq x^2 + y^2 + z^2 \leq 4$
41. $|P_1P_2| = \sqrt{(3-1)^2 + (3-1)^2 + (0-1)^2} = \sqrt{9} = 3$
42. $|P_1P_2| = \sqrt{(2+1)^2 + (5-1)^2 + (0-5)^2} = \sqrt{50} = 5\sqrt{2}$
43. $|P_1P_2| = \sqrt{(4-1)^2 + (-2-4)^2 + (7-5)^2} = \sqrt{49} = 7$
44. $|P_1P_2| = \sqrt{(2-3)^2 + (3-4)^2 + (4-5)^2} = \sqrt{3}$
45. $|P_1P_2| = \sqrt{(2-0)^2 + (-2-0)^2 + (-2-0)^2} = \sqrt{3 \cdot 4} = 2\sqrt{3}$
46. $|P_1P_2| = \sqrt{(0-5)^2 + (0-3)^2 + (0+2)^2} = \sqrt{38}$
47. center $(-2, 0, 2)$, radius $2\sqrt{2}$ 48. center $(1, -\frac{1}{2}, -3)$, radius 5
49. center $(\sqrt{2}, \sqrt{2}, -\sqrt{2})$, radius $\sqrt{2}$ 50. center $(0, -\frac{1}{3}, \frac{1}{3})$, radius $\frac{4}{3}$
51. $(x-1)^2 + (y-2)^2 + (z-3)^2 = 14$ 52. $x^2 + (y+1)^2 + (z-5)^2 = 4$
53. $(x+1)^2 + (y-\frac{1}{2})^2 + (z+\frac{2}{3})^2 = \frac{16}{81}$ 54. $x^2 + (y+7)^2 + z^2 = 49$
55. $x^2 + y^2 + z^2 + 4x - 4z = 0 \Rightarrow (x^2 + 4x + 4) + y^2 + (z^2 - 4z + 4) = 4 + 4 \Rightarrow (x+2)^2 + (y-0)^2 + (z-2)^2 = (\sqrt{8})^2$
 \Rightarrow the center is at $(-2, 0, 2)$ and the radius is $\sqrt{8}$
56. $x^2 + y^2 + z^2 - 6y + 8z = 0 \Rightarrow x^2 + (y^2 - 6y + 9) + (z^2 + 8z + 16) = 9 + 16 \Rightarrow (x-0)^2 + (y-3)^2 + (z+4)^2 = 5^2$
 \Rightarrow the center is at $(0, 3, -4)$ and the radius is 5
57. $2x^2 + 2y^2 + 2z^2 + x + y + z = 9 \Rightarrow x^2 + \frac{1}{2}x + y^2 + \frac{1}{2}y + z^2 + \frac{1}{2}z = \frac{9}{2}$
 $\Rightarrow (x^2 + \frac{1}{2}x + \frac{1}{16}) + (y^2 + \frac{1}{2}y + \frac{1}{16}) + (z^2 + \frac{1}{2}z + \frac{1}{16}) = \frac{9}{2} + \frac{3}{16} \Rightarrow (x + \frac{1}{4})^2 + (y + \frac{1}{4})^2 + (z + \frac{1}{4})^2 = (\frac{5\sqrt{3}}{4})^2$
 \Rightarrow the center is at $(-\frac{1}{4}, -\frac{1}{4}, -\frac{1}{4})$ and the radius is $\frac{5\sqrt{3}}{4}$

$$58. \quad 3x^2 + 3y^2 + 3z^2 + 2y - 2z = 9 \Rightarrow x^2 + y^2 + \frac{2}{3}y + z^2 - \frac{2}{3}z = 3 \Rightarrow x^2 + \left(y^2 + \frac{2}{3}y + \frac{1}{9}\right) + \left(z^2 - \frac{2}{3}z + \frac{1}{9}\right) = 3 + \frac{2}{9}$$

$$\Rightarrow (x-0)^2 + \left(y + \frac{1}{3}\right)^2 + \left(z - \frac{1}{3}\right)^2 = \left(\frac{\sqrt{29}}{3}\right)^2 \Rightarrow \text{the center is at } \left(0, -\frac{1}{3}, \frac{1}{3}\right) \text{ and the radius is } \frac{\sqrt{29}}{3}$$

$$59. \quad \text{(a) the distance between } (x, y, z) \text{ and } (x, 0, 0) \text{ is } \sqrt{y^2 + z^2}$$

$$\text{(b) the distance between } (x, y, z) \text{ and } (0, y, 0) \text{ is } \sqrt{x^2 + z^2}$$

$$\text{(c) the distance between } (x, y, z) \text{ and } (0, 0, z) \text{ is } \sqrt{x^2 + y^2}$$

$$60. \quad \text{(a) the distance between } (x, y, z) \text{ and } (x, y, 0) \text{ is } z$$

$$\text{(b) the distance between } (x, y, z) \text{ and } (0, y, z) \text{ is } x$$

$$\text{(c) the distance between } (x, y, z) \text{ and } (x, 0, z) \text{ is } y$$

$$61. \quad |AB| = \sqrt{(1-(-1))^2 + (-1-2)^2 + (3-1)^2} = \sqrt{4+9+4} = \sqrt{17}$$

$$|BC| = \sqrt{(3-1)^2 + (4-(-1))^2 + (5-3)^2} = \sqrt{4+25+4} = \sqrt{33}$$

$$|CA| = \sqrt{(-1-3)^2 + (2-4)^2 + (1-5)^2} = \sqrt{16+4+16} = \sqrt{36} = 6$$

Thus the perimeter of triangle ABC is $\sqrt{17} + \sqrt{33} + 6$.

$$62. \quad |PA| = \sqrt{(2-3)^2 + (-1-1)^2 + (3-2)^2} = \sqrt{1+4+1} = \sqrt{6}$$

$$|PB| = \sqrt{(4-3)^2 + (3-1)^2 + (1-2)^2} = \sqrt{1+4+1} = \sqrt{6}$$

Thus P is equidistant from A and B .

$$63. \quad \sqrt{(x-x)^2 + (y-(-1))^2 + (z-z)^2} = \sqrt{(x-x)^2 + (y-3)^2 + (z-z)^2} \Rightarrow (y+1)^2 = (y-3)^2 \Rightarrow 2y+1 = -6y+9$$

$$\Rightarrow y=1$$

$$64. \quad \sqrt{(x-0)^2 + (y-0)^2 + (z-2)^2} = \sqrt{(x-x)^2 + (y-y)^2 + (z-0)^2} \Rightarrow x^2 + y^2 + (z-2)^2 = z^2$$

$$\Rightarrow x^2 + y^2 - 4z + 4 = 0 \Rightarrow z = \frac{x^2}{4} + \frac{y^2}{4} + 1$$

$$65. \quad \text{(a) Since the entire sphere is below the } xy\text{-plane, the point on the sphere closest to the } xy\text{-plane is the point at the top of the sphere, which occurs when } x=0 \text{ and } y=3 \Rightarrow 0^2 + (3-3)^2 + (z+5)^2 = 4 \Rightarrow z = -5 \pm 2$$

$$\Rightarrow z = -3 \Rightarrow (0, 3, -3).$$

$$\text{(b) Both the center } (0, 3, -5) \text{ and the point } (0, 7, -5) \text{ lie in the plane } z = -5, \text{ so the point on the sphere closest to } (0, 7, -5) \text{ should also be in the same plane. In fact it should lie on the line segment between } (0, 3, -5) \text{ and } (0, 7, -5), \text{ thus the point occurs when } x=0 \text{ and } z = -5 \Rightarrow 0^2 + (y-3)^2 + (-5+5)^2 = 4$$

$$\Rightarrow y = 3 \pm 2 \Rightarrow y = 5 \Rightarrow (0, 5, -5).$$

$$\begin{aligned}
66. \quad & \sqrt{(x-0)^2 + (y-0)^2 + (z-0)^2} = \sqrt{(x-0)^2 + (y-4)^2 + (z-0)^2} = \sqrt{(x-3)^2 + (y-0)^2 + (z-0)^2} \\
& = \sqrt{(x-2)^2 + (y-2)^2 + (z+3)^2} \\
& \Rightarrow x^2 + y^2 + z^2 = x^2 + y^2 - 8y + 16 + z^2 = x^2 - 6x + 9 + y^2 + z^2 = x^2 - 4x + y^2 - 4y + z^2 + 6z + 17 \\
& \text{Solve: } x^2 + y^2 + z^2 = x^2 + y^2 - 8y + 16 + z^2 \Rightarrow 0 = -8y + 16 \Rightarrow y = 2 \\
& \text{Solve: } x^2 + y^2 + z^2 = x^2 - 6x + 9 + y^2 + z^2 \Rightarrow 0 = -6x + 9 \Rightarrow x = \frac{3}{2} \\
& \text{Solve: } x^2 + y^2 + z^2 = x^2 - 4x + y^2 - 4y + z^2 + 6z + 17 \Rightarrow 0 = -4x - 4y + 6z + 17 \Rightarrow 0 = -4\left(\frac{3}{2}\right) - 4(2) + 6z + 17 \\
& \Rightarrow z = -\frac{1}{2} \Rightarrow \left(\frac{3}{2}, 2, -\frac{1}{2}\right)
\end{aligned}$$

12.2 VECTORS

- $\langle 3(3), 3(-2) \rangle = \langle 9, -6 \rangle$
 - $\sqrt{9^2 + (-6)^2} = \sqrt{117} = 3\sqrt{13}$
- $\langle 3 + (-2), -2 + 5 \rangle = \langle 1, 3 \rangle$
 - $\sqrt{1^2 + 3^2} = \sqrt{10}$
- $2\mathbf{u} = \langle 2(3), 2(-2) \rangle = \langle 6, -4 \rangle$
 $3\mathbf{v} = \langle 3(-2), 3(5) \rangle = \langle -6, 15 \rangle$
 $2\mathbf{u} - 3\mathbf{v} = \langle 6 - (-6), -4 - 15 \rangle = \langle 12, -19 \rangle$
 - $\sqrt{12^2 + (-19)^2} = \sqrt{505}$
- $\frac{3}{5}\mathbf{u} = \left\langle \frac{3}{5}(3), \frac{3}{5}(-2) \right\rangle = \left\langle \frac{9}{5}, -\frac{6}{5} \right\rangle$
 $\frac{4}{5}\mathbf{v} = \left\langle \frac{4}{5}(-2), \frac{4}{5}(5) \right\rangle = \left\langle -\frac{8}{5}, 4 \right\rangle$
 $\frac{3}{5}\mathbf{u} + \frac{4}{5}\mathbf{v} = \left\langle \frac{9}{5} + \left(-\frac{8}{5}\right), -\frac{6}{5} + 4 \right\rangle = \left\langle \frac{1}{5}, \frac{14}{5} \right\rangle$
 - $\sqrt{\left(\frac{1}{5}\right)^2 + \left(\frac{14}{5}\right)^2} = \frac{\sqrt{197}}{5}$
- $-2\mathbf{u} = \langle -2(3), -2(-2) \rangle = \langle -6, 4 \rangle$
 $5\mathbf{v} = \langle 5(-2), 5(5) \rangle = \langle -10, 25 \rangle$
 $-2\mathbf{u} + 5\mathbf{v} = \langle -6 + (-10), 4 + 25 \rangle = \langle -16, 29 \rangle$
 - $\sqrt{(-16)^2 + 29^2} = \sqrt{1097}$
- $-\frac{5}{13}\mathbf{u} = \left\langle -\frac{5}{13}(3), -\frac{5}{13}(-2) \right\rangle = \left\langle -\frac{15}{13}, \frac{10}{13} \right\rangle$
 $\frac{12}{13}\mathbf{v} = \left\langle \frac{12}{13}(-2), \frac{12}{13}(5) \right\rangle = \left\langle -\frac{24}{13}, \frac{60}{13} \right\rangle$
 $-\frac{5}{13}\mathbf{u} + \frac{12}{13}\mathbf{v} = \left\langle -\frac{15}{13} + \left(-\frac{24}{13}\right), \frac{10}{13} + \frac{60}{13} \right\rangle = \left\langle -3, \frac{70}{13} \right\rangle$
 - $\sqrt{(-3)^2 + \left(\frac{70}{13}\right)^2} = \frac{\sqrt{6421}}{13}$
- $\langle 2 - 1, -1 - 3 \rangle = \langle 1, -4 \rangle$
- $\langle 0 - 2, 0 - 3 \rangle = \langle -2, -3 \rangle$
- $\overline{AB} = \langle 2 - 1, 0 - (-1) \rangle = \langle 1, 1 \rangle$, $\overline{CD} = \langle -2 - (-1), 2 - 3 \rangle = \langle -1, -1 \rangle$, $\overline{AB} + \overline{CD} = \langle 0, 0 \rangle$
- $\left\langle \cos \frac{2\pi}{3}, \sin \frac{2\pi}{3} \right\rangle = \left\langle -\frac{1}{2}, \frac{\sqrt{3}}{2} \right\rangle$
- $\left\langle \cos\left(-\frac{3\pi}{4}\right), \sin\left(-\frac{3\pi}{4}\right) \right\rangle = \left\langle -\frac{1}{\sqrt{2}}, -\frac{1}{\sqrt{2}} \right\rangle$
- This is the unit vector which makes an angle of $120^\circ + 90^\circ = 210^\circ$ with the positive x -axis;
 $\langle \cos 210^\circ, \sin 210^\circ \rangle = \left\langle -\frac{\sqrt{3}}{2}, -\frac{1}{2} \right\rangle$

16. $\langle \cos 135^\circ, \sin 135^\circ \rangle = \left\langle -\frac{1}{\sqrt{2}}, \frac{1}{\sqrt{2}} \right\rangle$

17. $\overline{P_1P_2} = (2-5)\mathbf{i} + (9-7)\mathbf{j} + (-2-(-1))\mathbf{k} = -3\mathbf{i} + 2\mathbf{j} - \mathbf{k}$

18. $\overline{P_1P_2} = (-3-1)\mathbf{i} + (0-2)\mathbf{j} + (5-0)\mathbf{k} = -4\mathbf{i} - 2\mathbf{j} + 5\mathbf{k}$

19. $\overline{AB} = (-10-(-7))\mathbf{i} + (8-(-8))\mathbf{j} + (1-1)\mathbf{k} = -3\mathbf{i} + 16\mathbf{j}$

20. $\overline{AB} = (-1-1)\mathbf{i} + (4-0)\mathbf{j} + (5-3)\mathbf{k} = -2\mathbf{i} + 4\mathbf{j} + 2\mathbf{k}$

21. $5\mathbf{u} - \mathbf{v} = 5\langle 1, 1, -1 \rangle - \langle 2, 0, 3 \rangle = \langle 5, 5, -5 \rangle - \langle 2, 0, 3 \rangle = \langle 5-2, 5-0, -5-3 \rangle = \langle 3, 5, -8 \rangle = 3\mathbf{i} + 5\mathbf{j} - 8\mathbf{k}$

22. $-2\mathbf{u} + 3\mathbf{v} = -2\langle -1, 0, 2 \rangle + 3\langle 1, 1, 1 \rangle = \langle 2, 0, -4 \rangle + \langle 3, 3, 3 \rangle = \langle 5, 3, -1 \rangle = 5\mathbf{i} + 3\mathbf{j} - \mathbf{k}$

23. The vector \mathbf{v} is horizontal and 1 in. long. The vectors \mathbf{u} and \mathbf{w} are $\frac{11}{16}$ in. long. \mathbf{w} is vertical and \mathbf{u} makes a 45° angle with the horizontal. All vectors must be drawn to scale.

(a)

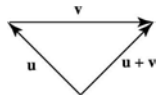

(b)

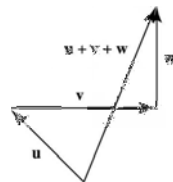

(c)

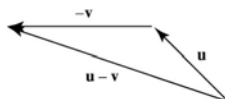

(d)

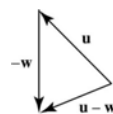

24. The angle between the vectors is 120° and vector \mathbf{u} is horizontal. They are all 1 in. long. Draw to scale.

(a)

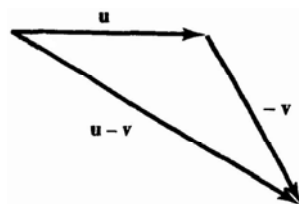

(b)

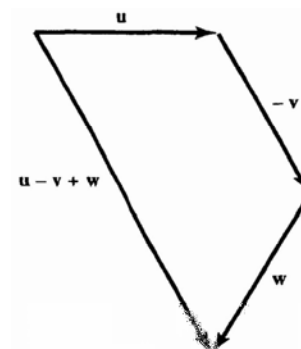

(c)

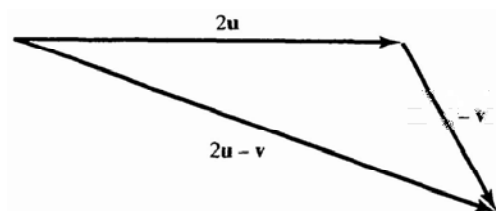

(d)

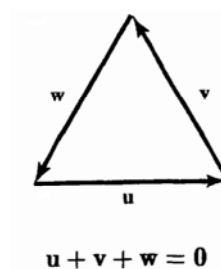

25. length = $|2\mathbf{i} + \mathbf{j} - 2\mathbf{k}| = \sqrt{2^2 + 1^2 + (-2)^2} = 3$, the direction is $\frac{2}{3}\mathbf{i} + \frac{1}{3}\mathbf{j} - \frac{2}{3}\mathbf{k} \Rightarrow 2\mathbf{i} + \mathbf{j} - 2\mathbf{k} = 3\left(\frac{2}{3}\mathbf{i} + \frac{1}{3}\mathbf{j} - \frac{2}{3}\mathbf{k}\right)$
26. length = $|9\mathbf{i} - 2\mathbf{j} + 6\mathbf{k}| = \sqrt{81 + 4 + 36} = 11$, the direction is $\frac{9}{11}\mathbf{i} - \frac{2}{11}\mathbf{j} + \frac{6}{11}\mathbf{k} \Rightarrow 9\mathbf{i} - 2\mathbf{j} + 6\mathbf{k} = 11\left(\frac{9}{11}\mathbf{i} - \frac{2}{11}\mathbf{j} + \frac{6}{11}\mathbf{k}\right)$
27. length = $|5\mathbf{k}| = \sqrt{25} = 5$, the direction is $\mathbf{k} \Rightarrow 5\mathbf{k} = 5(\mathbf{k})$
28. length = $\left|\frac{3}{5}\mathbf{i} + \frac{4}{5}\mathbf{k}\right| = \sqrt{\frac{9}{25} + \frac{16}{25}} = 1$, the direction is $\frac{3}{5}\mathbf{i} + \frac{4}{5}\mathbf{k} \Rightarrow \frac{3}{5}\mathbf{i} + \frac{4}{5}\mathbf{k} = 1\left(\frac{3}{5}\mathbf{i} + \frac{4}{5}\mathbf{k}\right)$
29. length = $\left|\frac{1}{\sqrt{6}}\mathbf{i} - \frac{1}{\sqrt{6}}\mathbf{j} - \frac{1}{\sqrt{6}}\mathbf{k}\right| = \sqrt{3\left(\frac{1}{\sqrt{6}}\right)^2} = \sqrt{\frac{1}{2}}$, the direction is $\frac{1}{\sqrt{3}}\mathbf{i} - \frac{1}{\sqrt{3}}\mathbf{j} - \frac{1}{\sqrt{3}}\mathbf{k}$
 $\Rightarrow \frac{1}{\sqrt{6}}\mathbf{i} - \frac{1}{\sqrt{6}}\mathbf{j} - \frac{1}{\sqrt{6}}\mathbf{k} = \sqrt{\frac{1}{2}}\left(\frac{1}{\sqrt{3}}\mathbf{i} - \frac{1}{\sqrt{3}}\mathbf{j} - \frac{1}{\sqrt{3}}\mathbf{k}\right)$
30. length = $\left|\frac{1}{\sqrt{3}}\mathbf{i} + \frac{1}{\sqrt{3}}\mathbf{j} + \frac{1}{\sqrt{3}}\mathbf{k}\right| = \sqrt{3\left(\frac{1}{\sqrt{3}}\right)^2} = 1$, the direction is $\frac{1}{\sqrt{3}}\mathbf{i} + \frac{1}{\sqrt{3}}\mathbf{j} + \frac{1}{\sqrt{3}}\mathbf{k}$
 $10 \Rightarrow \frac{1}{\sqrt{3}}\mathbf{i} + \frac{1}{\sqrt{3}}\mathbf{j} + \frac{1}{\sqrt{3}}\mathbf{k} = 1\left(\frac{1}{\sqrt{3}}\mathbf{i} + \frac{1}{\sqrt{3}}\mathbf{j} + \frac{1}{\sqrt{3}}\mathbf{k}\right)$
31. (a) $2\mathbf{i}$ (b) $-\sqrt{3}\mathbf{k}$ (c) $\frac{3}{10}\mathbf{j} + \frac{2}{5}\mathbf{k}$ (d) $6\mathbf{i} - 2\mathbf{j} + 3\mathbf{k}$
32. (a) $-7\mathbf{j}$ (b) $-\frac{3\sqrt{2}}{5}\mathbf{i} - \frac{4\sqrt{2}}{5}\mathbf{k}$ (c) $\frac{1}{4}\mathbf{i} - \frac{1}{3}\mathbf{j} - \mathbf{k}$ (d) $\frac{a}{\sqrt{2}}\mathbf{i} + \frac{a}{\sqrt{3}}\mathbf{j} - \frac{a}{\sqrt{6}}\mathbf{k}$
33. $|\mathbf{v}| = \sqrt{12^2 + 5^2} = \sqrt{169} = 13$; $\frac{\mathbf{v}}{|\mathbf{v}|} = \frac{1}{13}\mathbf{v} = \frac{1}{13}(12\mathbf{i} - 5\mathbf{k}) \Rightarrow$ the desired vector is $\frac{7}{13}(12\mathbf{i} - 5\mathbf{k})$
34. $|\mathbf{v}| = \sqrt{\frac{1}{4} + \frac{1}{4} + \frac{1}{4}} = \frac{\sqrt{3}}{2}$; $\frac{\mathbf{v}}{|\mathbf{v}|} = \frac{1}{\sqrt{3}}\mathbf{i} - \frac{1}{\sqrt{3}}\mathbf{j} - \frac{1}{\sqrt{3}}\mathbf{k} \Rightarrow$ the desired vector is $-3\left(\frac{1}{\sqrt{3}}\mathbf{i} - \frac{1}{\sqrt{3}}\mathbf{j} - \frac{1}{\sqrt{3}}\mathbf{k}\right)$
 $= -\sqrt{3}\mathbf{i} + \sqrt{3}\mathbf{j} + \sqrt{3}\mathbf{k}$
35. (a) $3\mathbf{i} + 4\mathbf{j} - 5\mathbf{k} = 5\sqrt{2}\left(\frac{3}{5\sqrt{2}}\mathbf{i} + \frac{4}{5\sqrt{2}}\mathbf{j} - \frac{1}{\sqrt{2}}\mathbf{k}\right) \Rightarrow$ the direction is $\frac{3}{5\sqrt{2}}\mathbf{i} + \frac{4}{5\sqrt{2}}\mathbf{j} - \frac{1}{\sqrt{2}}\mathbf{k}$
 (b) the midpoint is $\left(\frac{1}{2}, 3, \frac{5}{2}\right)$
36. (a) $3\mathbf{i} - 6\mathbf{j} + 2\mathbf{k} = 7\left(\frac{3}{7}\mathbf{i} - \frac{6}{7}\mathbf{j} + \frac{2}{7}\mathbf{k}\right) \Rightarrow$ the direction is $\frac{3}{7}\mathbf{i} - \frac{6}{7}\mathbf{j} + \frac{2}{7}\mathbf{k}$
 (b) the midpoint is $\left(\frac{5}{2}, 1, 6\right)$
37. (a) $-\mathbf{i} - \mathbf{j} - \mathbf{k} = \sqrt{3}\left(-\frac{1}{\sqrt{3}}\mathbf{i} - \frac{1}{\sqrt{3}}\mathbf{j} - \frac{1}{\sqrt{3}}\mathbf{k}\right) \Rightarrow$ the direction is $-\frac{1}{\sqrt{3}}\mathbf{i} - \frac{1}{\sqrt{3}}\mathbf{j} - \frac{1}{\sqrt{3}}\mathbf{k}$
 (b) the midpoint is $\left(\frac{5}{2}, \frac{7}{2}, \frac{9}{2}\right)$
38. (a) $2\mathbf{i} - 2\mathbf{j} - 2\mathbf{k} = 2\sqrt{3}\left(\frac{1}{\sqrt{3}}\mathbf{i} - \frac{1}{\sqrt{3}}\mathbf{j} - \frac{1}{\sqrt{3}}\mathbf{k}\right) \Rightarrow$ the direction is $\frac{1}{\sqrt{3}}\mathbf{i} - \frac{1}{\sqrt{3}}\mathbf{j} - \frac{1}{\sqrt{3}}\mathbf{k}$
 (b) the midpoint is $(1, -1, -1)$

39. $\overline{AB} = (5-a)\mathbf{i} + (1-b)\mathbf{j} + (3-c)\mathbf{k} = \mathbf{i} + 4\mathbf{j} - 2\mathbf{k} \Rightarrow 5-a=1, 1-b=4, \text{ and } 3-c=-2 \Rightarrow a=4, b=-3, \text{ and } c=15 \Rightarrow A \text{ is the point } (4, -3, 5)$
40. $\overline{AB} = (a+2)\mathbf{i} + (b+3)\mathbf{j} + (c-6)\mathbf{k} = -7\mathbf{i} + 3\mathbf{j} + 8\mathbf{k} \Rightarrow a+2=-7, b+3=3, \text{ and } c-6=8 \Rightarrow a=-9, b=0, \text{ and } c=14 \Rightarrow B \text{ is the point } (-9, 0, 14)$
41. $2\mathbf{i} + \mathbf{j} = a(\mathbf{i} + \mathbf{j}) + b(\mathbf{i} - \mathbf{j}) = (a+b)\mathbf{i} + (a-b)\mathbf{j} \Rightarrow a+b=2 \text{ and } a-b=1 \Rightarrow 2a=3 \Rightarrow a=\frac{3}{2} \text{ and } b=a-1=\frac{1}{2}$
42. $\mathbf{i} - 2\mathbf{j} = a(2\mathbf{i} + 3\mathbf{j}) + b(\mathbf{i} + \mathbf{j}) = (2a+b)\mathbf{i} + (3a+b)\mathbf{j} \Rightarrow 2a+b=1 \text{ and } 3a+b=-2 \Rightarrow a=-3 \text{ and } b=1-2a=7 \Rightarrow \mathbf{u}_1 = a(2\mathbf{i} + 3\mathbf{j}) = -6\mathbf{i} - 9\mathbf{j} \text{ and } \mathbf{u}_2 = b(\mathbf{i} + \mathbf{j}) = 7\mathbf{i} + 7\mathbf{j}$
43. $25^\circ \text{ west of north is } 90^\circ + 25^\circ = 115^\circ \text{ north of east. } 800\langle \cos 115^\circ, \sin 115^\circ \rangle \approx \langle -338.095, 725.046 \rangle$
44. Let $\mathbf{u} = \langle x, y \rangle$ represent the velocity of the plane alone, $\mathbf{v} = \langle 70 \cos 60^\circ, 70 \sin 60^\circ \rangle = \langle 35, 35\sqrt{3} \rangle$, and let the resultant $\mathbf{u} + \mathbf{v} = \langle 500, 0 \rangle$. Then $\langle x, y \rangle + \langle 35, 35\sqrt{3} \rangle = \langle 500, 0 \rangle \Rightarrow \langle x+35, y+35\sqrt{3} \rangle = \langle 500, 0 \rangle$
 $\Rightarrow x+35=500 \text{ and } y+35\sqrt{3}=0 \Rightarrow x=465 \text{ and } y=-35\sqrt{3} \Rightarrow \mathbf{u} = \langle 465, -35\sqrt{3} \rangle$
 $\Rightarrow |\mathbf{u}| = \sqrt{465^2 + (-35\sqrt{3})^2} \approx 468.9 \text{ mph, and } \tan \theta = \frac{-35\sqrt{3}}{465} \Rightarrow \theta \approx -7.4^\circ \Rightarrow 7.4^\circ \text{ south of east.}$
45. $\mathbf{F}_1 = \langle -|\mathbf{F}_1| \cos 30^\circ, |\mathbf{F}_1| \sin 30^\circ \rangle = \langle -\frac{\sqrt{3}}{2}|\mathbf{F}_1|, \frac{1}{2}|\mathbf{F}_1| \rangle$, $\mathbf{F}_2 = \langle |\mathbf{F}_2| \cos 45^\circ, |\mathbf{F}_2| \sin 45^\circ \rangle = \langle \frac{1}{\sqrt{2}}|\mathbf{F}_2|, \frac{1}{\sqrt{2}}|\mathbf{F}_2| \rangle$, and $\mathbf{w} = \langle 0, -100 \rangle$. Since $\mathbf{F}_1 + \mathbf{F}_2 = \langle 0, 100 \rangle \Rightarrow \langle -\frac{\sqrt{3}}{2}|\mathbf{F}_1| + \frac{1}{\sqrt{2}}|\mathbf{F}_2|, \frac{1}{2}|\mathbf{F}_1| + \frac{1}{\sqrt{2}}|\mathbf{F}_2| \rangle = \langle 0, 100 \rangle$
 $\Rightarrow -\frac{\sqrt{3}}{2}|\mathbf{F}_1| + \frac{1}{\sqrt{2}}|\mathbf{F}_2| = 0 \text{ and } \frac{1}{2}|\mathbf{F}_1| + \frac{1}{\sqrt{2}}|\mathbf{F}_2| = 100$. Solving the first equation for $|\mathbf{F}_2|$ results in:
 $|\mathbf{F}_2| = \frac{\sqrt{6}}{2}|\mathbf{F}_1|$. Substituting this result into the second equation gives us: $\frac{1}{2}|\mathbf{F}_1| + \frac{1}{\sqrt{2}}\left(\frac{\sqrt{6}}{2}|\mathbf{F}_1|\right) = 100$
 $\Rightarrow |\mathbf{F}_1| = \frac{200}{1+\sqrt{3}} \approx 73.205 \text{ N} \Rightarrow |\mathbf{F}_2| = \frac{100\sqrt{6}}{1+\sqrt{3}} \approx 89.658 \text{ N} \Rightarrow \mathbf{F}_1 \approx \langle -63.397, 36.603 \rangle \text{ and } \mathbf{F}_2 \approx \langle 63.397, 63.397 \rangle$
46. $\mathbf{F}_1 = \langle -35 \cos \alpha, 35 \sin \alpha \rangle$, $\mathbf{F}_2 = \langle |\mathbf{F}_2| \cos 60^\circ, |\mathbf{F}_2| \sin 60^\circ \rangle = \langle \frac{1}{2}|\mathbf{F}_2|, \frac{\sqrt{3}}{2}|\mathbf{F}_2| \rangle$, and $\mathbf{w} = \langle 0, -50 \rangle$.
 Since $\mathbf{F}_1 + \mathbf{F}_2 = \langle 0, 50 \rangle \Rightarrow \langle -35 \cos \alpha + \frac{1}{2}|\mathbf{F}_2|, 35 \sin \alpha + \frac{\sqrt{3}}{2}|\mathbf{F}_2| \rangle = \langle 0, 50 \rangle \Rightarrow -35 \cos \alpha + \frac{1}{2}|\mathbf{F}_2| = 0$ and
 $35 \sin \alpha + \frac{\sqrt{3}}{2}|\mathbf{F}_2| = 50$. Solving the first equation for $|\mathbf{F}_2|$ results in: $|\mathbf{F}_2| = 70 \cos \alpha$. Substituting this result
 into the second equation gives us: $35 \sin \alpha + 35\sqrt{3} \cos \alpha = 50 \Rightarrow \sqrt{3} \cos \alpha = \frac{10}{7} - \sin \alpha$
 $\Rightarrow 3 \cos^2 \alpha = \frac{100}{49} - \frac{20}{7} \sin \alpha + \sin^2 \alpha \Rightarrow 3(1 - \sin^2 \alpha) = \frac{100}{49} - \frac{20}{7} \sin \alpha + \sin^2 \alpha \Rightarrow 196 \sin^2 \alpha - 140 \sin \alpha - 47 = 0$
 $\Rightarrow \sin \alpha = \frac{5 \pm 6\sqrt{2}}{14}$. Since $\alpha > 0 \Rightarrow \sin \alpha > 0 \Rightarrow \sin \alpha = \frac{5+6\sqrt{2}}{14} \Rightarrow \alpha \approx 74.42^\circ$, and $|\mathbf{F}_2| = 70 \cos \alpha \approx 18.81 \text{ N}$.
47. $\mathbf{F}_1 = \langle -|\mathbf{F}_1| \cos 40^\circ, |\mathbf{F}_1| \sin 40^\circ \rangle$, $\mathbf{F}_2 = \langle 100 \cos 35^\circ, 100 \sin 35^\circ \rangle$, and $\mathbf{w} = \langle 0, -w \rangle$. Since $\mathbf{F}_1 + \mathbf{F}_2 = \langle 0, w \rangle$
 $\Rightarrow \langle -|\mathbf{F}_1| \cos 40^\circ + 100 \cos 35^\circ, |\mathbf{F}_1| \sin 40^\circ + 100 \sin 35^\circ \rangle = \langle 0, w \rangle \Rightarrow -|\mathbf{F}_1| \cos 40^\circ + 100 \cos 35^\circ = 0$ and

$|\mathbf{F}_1| \sin 40^\circ + 100 \sin 35^\circ = w$. Solving the first equation for $|\mathbf{F}_1|$ results in: $|\mathbf{F}_1| = \frac{100 \cos 35^\circ}{\cos 40^\circ} \approx 106.933$ N. Substituting this result into the second equation gives us: $w \approx 126.093$ N.

48. $\mathbf{F}_1 = \langle -|\mathbf{F}_1| \cos \alpha, |\mathbf{F}_1| \sin \alpha \rangle = \langle -75 \cos \alpha, 75 \sin \alpha \rangle$, $\mathbf{F}_2 = \langle |\mathbf{F}_2| \cos \beta, |\mathbf{F}_2| \sin \beta \rangle = \langle 75 \cos \alpha, 75 \sin \alpha \rangle$, and $\mathbf{w} = \langle 0, -25 \rangle$. Since $\mathbf{F}_1 + \mathbf{F}_2 = \langle 0, 25 \rangle \Rightarrow \langle -75 \cos \alpha + 75 \cos \alpha, 75 \sin \alpha + 75 \sin \alpha \rangle = \langle 0, 25 \rangle \Rightarrow 150 \sin \alpha = 25 \Rightarrow \alpha \approx 9.59^\circ$.

49. (a) The tree is located at the tip of the vector $\overline{OP} = (5 \cos 60^\circ)\mathbf{i} + (5 \sin 60^\circ)\mathbf{j} = \frac{5}{2}\mathbf{i} + \frac{5\sqrt{3}}{2}\mathbf{j} \Rightarrow P = \left(\frac{5}{2}, \frac{5\sqrt{3}}{2}\right)$
 (b) The telephone pole is located at the point Q , which is the tip of the vector $\overline{OP} + \overline{PQ}$
 $= \left(\frac{5}{2}\mathbf{i} + \frac{5\sqrt{3}}{2}\mathbf{j}\right) + (10 \cos 315^\circ)\mathbf{i} + (10 \sin 315^\circ)\mathbf{j} = \left(\frac{5}{2} + \frac{10\sqrt{2}}{2}\right)\mathbf{i} + \left(\frac{5\sqrt{3}}{2} - \frac{10\sqrt{2}}{2}\right)\mathbf{j} \Rightarrow Q = \left(\frac{5+10\sqrt{2}}{2}, \frac{5\sqrt{3}-10\sqrt{2}}{2}\right)$

50. Let $t = \frac{q}{p+q}$ and $s = \frac{p}{p+q}$. Choose T on $\overline{OP_1}$ so that \overline{TQ} is parallel to $\overline{OP_2}$, so that ΔTP_1Q is similar to ΔOP_1P_2 . Then $\frac{|OT|}{|OP_1|} = t \Rightarrow \overline{OT} = t\overline{OP_1}$ so that $T = (tx_1, ty_1, tz_1)$. Also, $\frac{|TQ|}{|OP_2|} = s \Rightarrow \overline{TQ} = s\overline{OP_2} = s\langle x_2, y_2, z_2 \rangle$. Letting $Q = (x, y, z)$, we have that $\overline{TQ} = \langle x - tx_1, y - ty_1, z - tz_1 \rangle = s\langle x_2, y_2, z_2 \rangle$
 Thus $x = tx_1 + sx_2$, $y = ty_1 + sy_2$, $z = tz_1 + sz_2$.

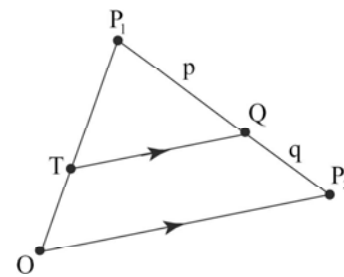

(Note that if Q is the midpoint, then $\frac{p}{q} = 1$ and $t = s = \frac{1}{2}$ so that $x = \frac{1}{2}x_1 + \frac{1}{2}x_2 = \frac{x_1+x_2}{2}$, $y = \frac{y_1+y_2}{2}$, $z = \frac{z_1+z_2}{2}$ so that this result agrees with the midpoint formula.)

51. (a) the midpoint of AB is $M\left(\frac{5}{2}, \frac{5}{2}, 0\right)$ and $\overline{CM} = \left(\frac{5}{2} - 1\right)\mathbf{i} + \left(\frac{5}{2} - 1\right)\mathbf{j} + (0 - 3)\mathbf{k} = \frac{3}{2}\mathbf{i} + \frac{3}{2}\mathbf{j} - 3\mathbf{k}$
 (b) the desired vector is $\left(\frac{2}{3}\right)\overline{CM} = \frac{2}{3}\left(\frac{3}{2}\mathbf{i} + \frac{3}{2}\mathbf{j} - 3\mathbf{k}\right) = \mathbf{i} + \mathbf{j} - 2\mathbf{k}$
 (c) the vector whose sum is the vector from the origin to C and the result of part (b) will terminate at the center of mass \Rightarrow the terminal point of $(\mathbf{i} + \mathbf{j} + 3\mathbf{k}) + (\mathbf{i} + \mathbf{j} - 2\mathbf{k}) = 2\mathbf{i} + 2\mathbf{j} + \mathbf{k}$ is the point $(2, 2, 1)$, which is the location of the center of mass

52. The midpoint of AB is $M\left(\frac{3}{2}, 0, \frac{5}{2}\right)$ and $\left(\frac{2}{3}\right)\overline{CM} = \frac{2}{3}\left[\left(\frac{3}{2} + 1\right)\mathbf{i} + (0 - 2)\mathbf{j} + \left(\frac{5}{2} + 1\right)\mathbf{k}\right] = \frac{2}{3}\left(\frac{5}{2}\mathbf{i} - 2\mathbf{j} + \frac{7}{2}\mathbf{k}\right) = \frac{5}{3}\mathbf{i} - \frac{4}{3}\mathbf{j} + \frac{7}{3}\mathbf{k}$. The vector from the origin to the point of intersection of the medians is $\left(\frac{5}{3}\mathbf{i} - \frac{4}{3}\mathbf{j} + \frac{7}{3}\mathbf{k}\right) + \overline{OC} = \left(\frac{5}{3}\mathbf{i} - \frac{4}{3}\mathbf{j} + \frac{7}{3}\mathbf{k}\right) + (-\mathbf{i} + 2\mathbf{j} - \mathbf{k}) = \frac{2}{3}\mathbf{i} + \frac{2}{3}\mathbf{j} + \frac{4}{3}\mathbf{k}$.

53. Without loss of generality we identify the vertices of the quadrilateral such that $A(0, 0, 0)$, $B(x_b, 0, 0)$, $C(x_c, y_c, 0)$ and $D(x_d, y_d, z_d) \Rightarrow$ the midpoint of AB is $M_{AB}\left(\frac{x_b}{2}, 0, 0\right)$, the midpoint of BC is $M_{BC}\left(\frac{x_b+x_c}{2}, \frac{y_c}{2}, 0\right)$, the midpoint of CD is $M_{CD}\left(\frac{x_c+x_d}{2}, \frac{y_c+y_d}{2}, \frac{z_d}{2}\right)$ and the midpoint of AD is $M_{AD}\left(\frac{x_d}{2}, \frac{y_d}{2}, \frac{z_d}{2}\right) \Rightarrow$ the midpoint of $M_{AB}M_{CD}$ is $\left(\frac{\frac{x_b}{2} + \frac{x_c+x_d}{2}}{2}, \frac{\frac{y_c}{2} + \frac{y_c+y_d}{2}}{4}, \frac{\frac{z_d}{2}}{4}\right)$ which is the same as the midpoint of $M_{AD}M_{BC} = \left(\frac{\frac{x_b+x_c}{2} + \frac{x_d}{2}}{2}, \frac{y_c+y_d}{4}, \frac{z_d}{4}\right)$.

54. Let $V_1, V_2, V_3, \dots, V_n$ be the vertices of a regular n -sided polygon and \mathbf{v}_i denote the vector from the center to V_i for $i = 1, 2, 3, \dots, n$. If $\mathbf{S} = \sum_{i=1}^n \mathbf{v}_i$ and the polygon is rotated through an angle of $\frac{i(2\pi)}{n}$ where $i = 1, 2, 3, \dots, n$, then \mathbf{S} would remain the same. Since the vector \mathbf{S} does not change with these rotations we conclude that $\mathbf{S} = \mathbf{0}$.
55. Without loss of generality we can coordinatize the vertices of the triangle such that $A(0, 0)$, $B(b, 0)$ and $C(x_c, y_c) \Rightarrow a$ is located at $(\frac{b+x_c}{2}, \frac{y_c}{2})$, b is at $(\frac{x_c}{2}, \frac{y_c}{2})$ and c is at $(\frac{b}{2}, 0)$. Therefore, $\overline{Aa} = (\frac{b}{2} + \frac{x_c}{2})\mathbf{i} + (\frac{y_c}{2})\mathbf{j}$, $\overline{Bb} = (\frac{x_c}{2} - b)\mathbf{i} + (\frac{y_c}{2})\mathbf{j}$, and $\overline{Cc} = (\frac{b}{2} - x_c)\mathbf{i} + (-y_c)\mathbf{j} \Rightarrow \overline{Aa} + \overline{Bb} + \overline{Cc} = \mathbf{0}$.
56. Let \mathbf{u} be any unit vector in the plane. If \mathbf{u} is positioned so that its initial point is at the origin and terminal point is at (x, y) , then \mathbf{u} makes an angle θ with \mathbf{i} , measured in the counter-clockwise direction. Since $|\mathbf{u}| = 1$, we have that $x = \cos \theta$ and $y = \sin \theta$. Thus $\mathbf{u} = \cos \theta \mathbf{i} + \sin \theta \mathbf{j}$. Since \mathbf{u} was assumed to be any unit vector in the plane, this holds for every unit vector in the plane.

12.3 THE DOT PRODUCT

NOTE: In Exercises 1-8 below we calculate $\text{proj}_{\mathbf{v}} \mathbf{u}$ as the vector $(\frac{|\mathbf{u}| \cos \theta}{|\mathbf{v}|})\mathbf{v}$, so the scalar multiplier of \mathbf{v} is the number in column 5 divided by the number in column 2.

	$\mathbf{v} \cdot \mathbf{u}$	$ \mathbf{v} $	$ \mathbf{u} $	$\cos \theta$	$ \mathbf{u} \cos \theta$	$\text{proj}_{\mathbf{v}} \mathbf{u}$
1.	-25	5	5	-1	-5	$-2\mathbf{i} + 4\mathbf{j} - \sqrt{5}\mathbf{k}$
2.	3	1	13	$\frac{3}{13}$	3	$3(\frac{3}{5}\mathbf{i} + \frac{4}{5}\mathbf{k})$
3.	25	15	5	$\frac{1}{3}$	$\frac{5}{3}$	$\frac{1}{9}(10\mathbf{i} + 11\mathbf{j} - 2\mathbf{k})$
4.	13	15	3	$\frac{13}{45}$	$\frac{13}{15}$	$\frac{13}{225}(2\mathbf{i} + 10\mathbf{j} - 11\mathbf{k})$
5.	2	$\sqrt{34}$	$\sqrt{3}$	$\frac{2}{\sqrt{3}\sqrt{34}}$	$\frac{2}{\sqrt{34}}$	$\frac{1}{17}(5\mathbf{j} - 3\mathbf{k})$
6.	$\sqrt{3} - \sqrt{2}$	$\sqrt{2}$	3	$\frac{\sqrt{3} - \sqrt{2}}{3\sqrt{2}}$	$\frac{\sqrt{3} - \sqrt{2}}{\sqrt{2}}$	$\frac{\sqrt{3} - \sqrt{2}}{2}(-\mathbf{i} + \mathbf{j})$
7.	$10 + \sqrt{17}$	$\sqrt{26}$	$\sqrt{21}$	$\frac{10 + \sqrt{17}}{\sqrt{546}}$	$\frac{10 + \sqrt{17}}{\sqrt{26}}$	$\frac{10 + \sqrt{17}}{26}(5\mathbf{i} + \mathbf{j})$
8.	$\frac{1}{6}$	$\frac{\sqrt{30}}{6}$	$\frac{\sqrt{30}}{6}$	$\frac{1}{5}$	$\frac{1}{\sqrt{30}}$	$\frac{1}{5}\langle \frac{1}{\sqrt{2}}, \frac{1}{\sqrt{3}} \rangle$

9. $\theta = \cos^{-1}\left(\frac{\mathbf{u} \cdot \mathbf{v}}{|\mathbf{u}||\mathbf{v}|}\right) = \cos^{-1}\left(\frac{(2)(1)+(1)(2)+(0)(-1)}{\sqrt{2^2+1^2+0^2}\sqrt{1^2+2^2+(-1)^2}}\right) = \cos^{-1}\left(\frac{4}{\sqrt{5}\sqrt{6}}\right) = \cos^{-1}\left(\frac{4}{\sqrt{30}}\right) \approx 0.75 \text{ rad}$
10. $\theta = \cos^{-1}\left(\frac{\mathbf{u} \cdot \mathbf{v}}{|\mathbf{u}||\mathbf{v}|}\right) = \cos^{-1}\left(\frac{(2)(3)+(-2)(0)+(1)(4)}{\sqrt{2^2+(-2)^2+1^2}\sqrt{3^2+0^2+4^2}}\right) = \cos^{-1}\left(\frac{10}{\sqrt{9}\sqrt{25}}\right) = \cos^{-1}\left(\frac{2}{3}\right) \approx 0.84 \text{ rad}$

$$11. \theta = \cos^{-1} \left(\frac{\mathbf{u} \cdot \mathbf{v}}{|\mathbf{u}| |\mathbf{v}|} \right) = \cos^{-1} \left(\frac{(\sqrt{3})(\sqrt{3}) + (-7)(1) + (0)(-2)}{\sqrt{(\sqrt{3})^2 + (-7)^2 + 0^2} \sqrt{(\sqrt{3})^2 + (1)^2 + (-2)^2}} \right) = \cos^{-1} \left(\frac{3-7}{\sqrt{52} \sqrt{8}} \right) = \cos^{-1} \left(\frac{-1}{\sqrt{26}} \right) \approx 1.77 \text{ rad}$$

$$12. \theta = \cos^{-1} \left(\frac{\mathbf{u} \cdot \mathbf{v}}{|\mathbf{u}| |\mathbf{v}|} \right) = \cos^{-1} \left(\frac{(1)(-1) + (\sqrt{2})(1) + (-\sqrt{2})(1)}{\sqrt{(1)^2 + (\sqrt{2})^2 + (-\sqrt{2})^2} \sqrt{(-1)^2 + (1)^2 + (1)^2}} \right) = \cos^{-1} \left(\frac{-1}{\sqrt{5} \sqrt{3}} \right) = \cos^{-1} \left(\frac{-1}{\sqrt{15}} \right) \approx 1.83 \text{ rad}$$

$$13. \overline{AB} = \langle 3, 1 \rangle, \overline{BC} = \langle -1, -3 \rangle, \text{ and } \overline{AC} = \langle 2, -2 \rangle. \overline{BA} = \langle -3, -1 \rangle, \overline{CB} = \langle 1, 3 \rangle, \overline{CA} = \langle -2, 2 \rangle.$$

$$|\overline{AB}| = |\overline{BA}| = \sqrt{10}, |\overline{BC}| = |\overline{CB}| = \sqrt{10}, |\overline{AC}| = |\overline{CA}| = 2\sqrt{2},$$

$$\text{Angle at } A = \cos^{-1} \left(\frac{\overline{AB} \cdot \overline{AC}}{|\overline{AB}| |\overline{AC}|} \right) = \cos^{-1} \left(\frac{3(2) + 1(-2)}{(\sqrt{10})(2\sqrt{2})} \right) = \cos^{-1} \left(\frac{1}{\sqrt{5}} \right) \approx 63.435^\circ$$

$$\text{Angle at } B = \cos^{-1} \left(\frac{\overline{BC} \cdot \overline{BA}}{|\overline{BC}| |\overline{BA}|} \right) = \cos^{-1} \left(\frac{(-1)(-3) + (-3)(-1)}{(\sqrt{10})(\sqrt{10})} \right) = \cos^{-1} \left(\frac{3}{5} \right) \approx 53.130^\circ, \text{ and}$$

$$\text{Angle at } C = \cos^{-1} \left(\frac{\overline{CB} \cdot \overline{CA}}{|\overline{CB}| |\overline{CA}|} \right) = \cos^{-1} \left(\frac{1(-2) + 3(2)}{(\sqrt{10})(2\sqrt{2})} \right) = \cos^{-1} \left(\frac{1}{\sqrt{5}} \right) \approx 63.435^\circ$$

$$14. \overline{AC} = \langle 2, 4 \rangle \text{ and } \overline{BD} = \langle 4, -2 \rangle. \overline{AC} \cdot \overline{BD} = 2(4) + 4(-2) = 0, \text{ so the angle measures are all } 90^\circ.$$

$$15. \text{ (a) } \cos \alpha = \frac{\mathbf{i} \cdot \mathbf{v}}{|\mathbf{i}| |\mathbf{v}|} = \frac{a}{|\mathbf{v}|}, \cos \beta = \frac{\mathbf{j} \cdot \mathbf{v}}{|\mathbf{j}| |\mathbf{v}|} = \frac{b}{|\mathbf{v}|}, \cos \gamma = \frac{\mathbf{k} \cdot \mathbf{v}}{|\mathbf{k}| |\mathbf{v}|} = \frac{c}{|\mathbf{v}|} \text{ and}$$

$$\cos^2 \alpha + \cos^2 \beta + \cos^2 \gamma = \left(\frac{a}{|\mathbf{v}|} \right)^2 + \left(\frac{b}{|\mathbf{v}|} \right)^2 + \left(\frac{c}{|\mathbf{v}|} \right)^2 = \frac{a^2 + b^2 + c^2}{|\mathbf{v}|^2} = \frac{|\mathbf{v}|^2}{|\mathbf{v}|^2} = 1$$

$$\text{ (b) } |\mathbf{v}| = 1 \Rightarrow \cos \alpha = \frac{a}{|\mathbf{v}|} = a, \cos \beta = \frac{b}{|\mathbf{v}|} = b \text{ and } \cos \gamma = \frac{c}{|\mathbf{v}|} = c \text{ are the direction cosines of } \mathbf{v}$$

$$16. \mathbf{u} = 10\mathbf{i} + 2\mathbf{k} \text{ is parallel to the pipe in the north direction and } \mathbf{v} = 10\mathbf{j} + \mathbf{k} \text{ is parallel to the pipe in the east direction. The angle between the two pipes is } \theta = \cos^{-1} \left(\frac{\mathbf{u} \cdot \mathbf{v}}{|\mathbf{u}| |\mathbf{v}|} \right) = \cos^{-1} \left(\frac{2}{\sqrt{104} \sqrt{101}} \right) \approx 1.55 \text{ rad} \approx 88.88^\circ.$$

$$17. \text{ The sum of two vectors of equal length is always orthogonal to their difference, as we can see from the equation } (\mathbf{v}_1 + \mathbf{v}_2) \cdot (\mathbf{v}_1 - \mathbf{v}_2) = \mathbf{v}_1 \cdot \mathbf{v}_1 + \mathbf{v}_2 \cdot \mathbf{v}_1 - \mathbf{v}_1 \cdot \mathbf{v}_2 - \mathbf{v}_2 \cdot \mathbf{v}_2 = |\mathbf{v}_1|^2 - |\mathbf{v}_2|^2 = 0$$

$$18. \overline{CA} \cdot \overline{CB} = (-\mathbf{v} + (-\mathbf{u})) \cdot (-\mathbf{v} + \mathbf{u}) = \mathbf{v} \cdot \mathbf{v} - \mathbf{v} \cdot \mathbf{u} + \mathbf{u} \cdot \mathbf{v} - \mathbf{u} \cdot \mathbf{u} = |\mathbf{v}|^2 - |\mathbf{u}|^2 = 0 \text{ because } |\mathbf{u}| = |\mathbf{v}|, \text{ since both equal the radius of the circle. Therefore, } \overline{CA} \text{ and } \overline{CB} \text{ are orthogonal.}$$

$$19. \text{ Let } \mathbf{u} \text{ and } \mathbf{v} \text{ be the sides of a rhombus } \Rightarrow \text{ the diagonals are } \mathbf{d}_1 = \mathbf{u} + \mathbf{v} \text{ and } \mathbf{d}_2 = -\mathbf{u} + \mathbf{v}$$

$$\Rightarrow \mathbf{d}_1 \cdot \mathbf{d}_2 = (\mathbf{u} + \mathbf{v}) \cdot (-\mathbf{u} + \mathbf{v}) = -\mathbf{u} \cdot \mathbf{u} + \mathbf{u} \cdot \mathbf{v} - \mathbf{v} \cdot \mathbf{u} + \mathbf{v} \cdot \mathbf{v} = |\mathbf{v}|^2 - |\mathbf{u}|^2 = 0 \text{ because } |\mathbf{u}| = |\mathbf{v}|, \text{ since a rhombus has equal sides.}$$

20. Suppose the diagonals of a rectangle are perpendicular, and let \mathbf{u} and \mathbf{v} be the sides of a rectangle
 \Rightarrow the diagonals are $\mathbf{d}_1 = \mathbf{u} + \mathbf{v}$ and $\mathbf{d}_2 = -\mathbf{u} + \mathbf{v}$. Since the diagonals are perpendicular we have $\mathbf{d}_1 \cdot \mathbf{d}_2 = 0$
 $\Leftrightarrow (\mathbf{u} + \mathbf{v}) \cdot (-\mathbf{u} + \mathbf{v}) = -\mathbf{u} \cdot \mathbf{u} + \mathbf{u} \cdot \mathbf{v} - \mathbf{v} \cdot \mathbf{u} + \mathbf{v} \cdot \mathbf{v} = 0 \Leftrightarrow |\mathbf{v}|^2 - |\mathbf{u}|^2 = 0 \Leftrightarrow (|\mathbf{v}| + |\mathbf{u}|)(|\mathbf{v}| - |\mathbf{u}|) = 0 \Leftrightarrow (|\mathbf{v}| + |\mathbf{u}|) = 0$
 which is not possible, or $(|\mathbf{v}| - |\mathbf{u}|) = 0$ which is equivalent to $|\mathbf{v}| = |\mathbf{u}| \Rightarrow$ the rectangle is a square.

21. Clearly the diagonals of a rectangle are equal in length. What is not as obvious is the statement that equal diagonals happen only in a rectangle. We show this is true by letting the adjacent sides of a parallelogram be the vectors $(v_1\mathbf{i} + v_2\mathbf{j})$ and $(u_1\mathbf{i} + u_2\mathbf{j})$. The equal diagonals of the parallelogram are

$$\begin{aligned} \mathbf{d}_1 &= (v_1\mathbf{i} + v_2\mathbf{j}) + (u_1\mathbf{i} + u_2\mathbf{j}) \text{ and } \mathbf{d}_2 = (v_1\mathbf{i} + v_2\mathbf{j}) - (u_1\mathbf{i} + u_2\mathbf{j}). \text{ Hence } |\mathbf{d}_1| = |\mathbf{d}_2| = |(v_1\mathbf{i} + v_2\mathbf{j}) + (u_1\mathbf{i} + u_2\mathbf{j})| \\ &= |(v_1\mathbf{i} + v_2\mathbf{j}) - (u_1\mathbf{i} + u_2\mathbf{j})| \Rightarrow |(v_1 + u_1)\mathbf{i} + (v_2 + u_2)\mathbf{j}| = |(v_1 - u_1)\mathbf{i} + (v_2 - u_2)\mathbf{j}| \Rightarrow \sqrt{(v_1 + u_1)^2 + (v_2 + u_2)^2} \\ &= \sqrt{(v_1 - u_1)^2 + (v_2 - u_2)^2} \Rightarrow v_1^2 + 2v_1u_1 + u_1^2 + v_2^2 + 2v_2u_2 + u_2^2 = v_1^2 - 2v_1u_1 + u_1^2 + v_2^2 - 2v_2u_2 + u_2^2 \\ &\Rightarrow 2(v_1u_1 + v_2u_2) = -2(v_1u_1 + v_2u_2) \Rightarrow v_1u_1 + v_2u_2 = 0 \Rightarrow (v_1\mathbf{i} + v_2\mathbf{j}) \cdot (u_1\mathbf{i} + u_2\mathbf{j}) = 0 \Rightarrow \text{the vectors } (v_1\mathbf{i} + v_2\mathbf{j}) \\ &\text{and } (u_1\mathbf{i} + u_2\mathbf{j}) \text{ are perpendicular and the parallelogram must be a rectangle.} \end{aligned}$$

22. If $|\mathbf{u}| = |\mathbf{v}|$ and $\mathbf{u} + \mathbf{v}$ is the indicated diagonal, then $(\mathbf{u} + \mathbf{v}) \cdot \mathbf{u} = \mathbf{u} \cdot \mathbf{u} + \mathbf{v} \cdot \mathbf{u} = |\mathbf{u}|^2 + \mathbf{v} \cdot \mathbf{u} = \mathbf{u} \cdot \mathbf{v} + |\mathbf{v}|^2$
 $= \mathbf{u} \cdot \mathbf{v} + \mathbf{v} \cdot \mathbf{v} = (\mathbf{u} + \mathbf{v}) \cdot \mathbf{v} \Rightarrow$ the angle $\cos^{-1}\left(\frac{(\mathbf{u} + \mathbf{v}) \cdot \mathbf{u}}{|\mathbf{u} + \mathbf{v}||\mathbf{u}|}\right)$ between the diagonal and \mathbf{u} and the angle
 $\cos^{-1}\left(\frac{(\mathbf{u} + \mathbf{v}) \cdot \mathbf{v}}{|\mathbf{u} + \mathbf{v}||\mathbf{v}|}\right)$ between the diagonal and \mathbf{v} are equal because the inverse cosine function is one-to-one.
 Therefore, the diagonal bisects the angle between \mathbf{u} and \mathbf{v} .

23. horizontal component: $1200 \cos(8^\circ) \approx 1188$ ft/s; vertical component: $1200 \sin(8^\circ) \approx 167$ ft/s

24. $|\mathbf{w}| \cos(33^\circ - 15^\circ) = 2.5$ lb, so $|\mathbf{w}| = \frac{2.5 \text{ lb}}{\cos 18^\circ}$. Then $\mathbf{w} = \frac{2.5 \text{ lb}}{\cos 18^\circ} \langle \cos 33^\circ, \sin 33^\circ \rangle \approx \langle 2.205, 1.432 \rangle$

25. (a) Since $|\cos \theta| \leq 1$, we have $|\mathbf{u} \cdot \mathbf{v}| = |\mathbf{u}||\mathbf{v}||\cos \theta| \leq |\mathbf{u}||\mathbf{v}|(1) = |\mathbf{u}||\mathbf{v}|$.
 (b) We have equality precisely when $|\cos \theta| = 1$ or when one or both of \mathbf{u} and \mathbf{v} is $\mathbf{0}$. In the case of nonzero vectors, we have equality when $\theta = 0$ or π , i.e., when the vectors are parallel.

26. $(x\mathbf{i} + y\mathbf{j}) \cdot \mathbf{v} = |x\mathbf{i} + y\mathbf{j}||\mathbf{v}|\cos \theta \leq 0$ when $\frac{\pi}{2} \leq \theta \leq \pi$.
 This means (x, y) has to be a point whose position vector makes an angle with \mathbf{v} that is a right angle or bigger.

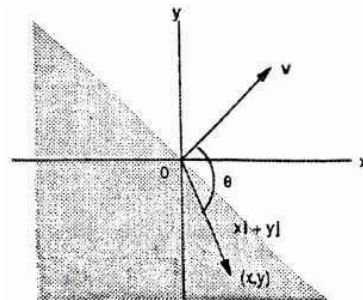

27. $\mathbf{v} \cdot \mathbf{u}_1 = (a\mathbf{u}_1 + b\mathbf{u}_2) \cdot \mathbf{u}_1 = a\mathbf{u}_1 \cdot \mathbf{u}_1 + b\mathbf{u}_2 \cdot \mathbf{u}_1 = a|\mathbf{u}_1|^2 + b(\mathbf{u}_2 \cdot \mathbf{u}_1) = a(1)^2 + b(0) = a$

28. No, \mathbf{v}_1 need not equal \mathbf{v}_2 . For example, $\mathbf{i} + \mathbf{j} \neq \mathbf{i} + 2\mathbf{j}$ but $\mathbf{i} \cdot (\mathbf{i} + \mathbf{j}) = \mathbf{i} \cdot \mathbf{i} + \mathbf{i} \cdot \mathbf{j} = 1 + 0 = 1$ and $\mathbf{i} \cdot (\mathbf{i} + 2\mathbf{j}) = \mathbf{i} \cdot \mathbf{i} + 2\mathbf{i} \cdot \mathbf{j} = 1 + 2 \cdot 0 = 1$.

29.
$$\text{proj}_{\mathbf{v}} \mathbf{u} = \frac{\mathbf{u} \cdot \mathbf{v}}{|\mathbf{v}|^2} \mathbf{v} \Rightarrow \left(\mathbf{u} - \frac{\mathbf{u} \cdot \mathbf{v}}{|\mathbf{v}|^2} \mathbf{v} \right) \cdot \left(\frac{\mathbf{u} \cdot \mathbf{v}}{|\mathbf{v}|^2} \mathbf{v} \right) = \mathbf{u} \cdot \left(\frac{\mathbf{u} \cdot \mathbf{v}}{|\mathbf{v}|^2} \mathbf{v} \right) - \left(\frac{\mathbf{u} \cdot \mathbf{v}}{|\mathbf{v}|^2} \mathbf{v} \right) \cdot \left(\frac{\mathbf{u} \cdot \mathbf{v}}{|\mathbf{v}|^2} \mathbf{v} \right) = \left(\frac{\mathbf{u} \cdot \mathbf{v}}{|\mathbf{v}|^2} \right) (\mathbf{u} \cdot \mathbf{v}) - \left(\frac{\mathbf{u} \cdot \mathbf{v}}{|\mathbf{v}|^2} \right)^2 (\mathbf{v} \cdot \mathbf{v})$$

$$= \frac{(\mathbf{u} \cdot \mathbf{v})^2}{|\mathbf{v}|^2} - \frac{(\mathbf{u} \cdot \mathbf{v})^2}{|\mathbf{v}|^4} |\mathbf{v}|^2 = 0$$

30. $\mathbf{F} = 2\mathbf{i} + \mathbf{j} - 3\mathbf{k}$ and $\mathbf{v} = 3\mathbf{i} - \mathbf{j} \Rightarrow \text{proj}_{\mathbf{v}} \mathbf{F} = \frac{\mathbf{F} \cdot \mathbf{v}}{|\mathbf{v}|^2} \mathbf{v} = \frac{5}{(\sqrt{10})^2} (3\mathbf{i} - \mathbf{j}) = \frac{3}{2} \mathbf{i} - \frac{1}{2} \mathbf{j}$ is the vector parallel to \mathbf{v} .

$\mathbf{F} - \text{proj}_{\mathbf{v}} \mathbf{F} = (2\mathbf{i} + \mathbf{j} - 3\mathbf{k}) - \left(\frac{3}{2} \mathbf{i} - \frac{1}{2} \mathbf{j} \right) = \frac{1}{2} \mathbf{i} + \frac{3}{2} \mathbf{j} - 3\mathbf{k}$ is the vector orthogonal to \mathbf{v} .

31. $P(x_1, y_1) = P\left(x_1, \frac{c}{b} - \frac{a}{b}x_1\right)$ and $Q(x_2, y_2) = Q\left(x_2, \frac{c}{b} - \frac{a}{b}x_2\right)$ and any two points P and Q on the line with $b \neq 0 \Rightarrow \overline{PQ} = (x_2 - x_1)\mathbf{i} + \frac{a}{b}(x_1 - x_2)\mathbf{j} \Rightarrow \overline{PQ} \cdot \mathbf{v} = \left[(x_2 - x_1)\mathbf{i} + \frac{a}{b}(x_1 - x_2)\mathbf{j} \right] \cdot (a\mathbf{i} + b\mathbf{j})$
 $= a(x_2 - x_1) + b\left(\frac{a}{b}\right)(x_1 - x_2) = 0 \Rightarrow \mathbf{v}$ is perpendicular to \overline{PQ} for $b \neq 0$. If $b = 0$, then $\mathbf{v} = a\mathbf{i}$ is perpendicular to the vertical line $ax = c$. Alternatively, the slope of \mathbf{v} is $\frac{b}{a}$ and the slope of the line $ax + by = c$ is $-\frac{a}{b}$, so the slopes are negative reciprocals \Rightarrow the vector \mathbf{v} and the line are perpendicular.

32. The slope of \mathbf{v} is $\frac{b}{a}$ and the slope of $bx - ay = c$ is $\frac{b}{a}$, provided that $a \neq 0$. If $a = 0$, then $\mathbf{v} = b\mathbf{j}$ is parallel to the vertical line $bx = c$. In either case, the vector \mathbf{v} is parallel to the line $bx - ay = c$.

33. $\mathbf{v} = \mathbf{i} + 2\mathbf{j}$ is perpendicular to the line $x + 2y = c$;
 $P(2, 1)$ on the line $\Rightarrow 2 + 2 = c \Rightarrow x + 2y = 4$

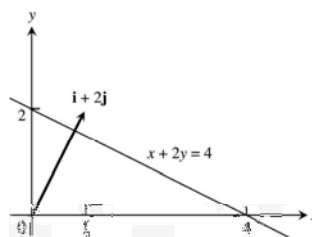

34. $\mathbf{v} = -2\mathbf{i} - \mathbf{j}$ is perpendicular to the line $-2x - y = c$;
 $P(-1, 2)$ on the line $\Rightarrow (-2)(-1) - 2 = c$
 $\Rightarrow -2x - y = 0$

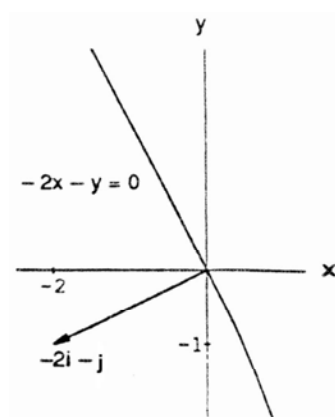

35. $\mathbf{v} = -2\mathbf{i} + \mathbf{j}$ is perpendicular to the line $-2x + y = c$;
 $P(-2, -7)$ on the line $\Rightarrow (-2)(-2) - 7 = c$
 $\Rightarrow -2x + y = -3$

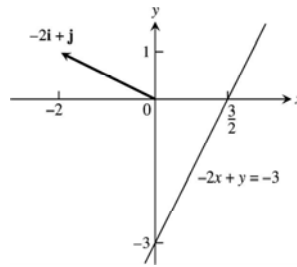

36. $\mathbf{v} = 2\mathbf{i} - 3\mathbf{j}$ is perpendicular to the line $2x - 3y = c$;
 $P(11, 10)$ on the line $\Rightarrow (2)(11) - (3)(10) = c$
 $\Rightarrow 2x - 3y = -8$

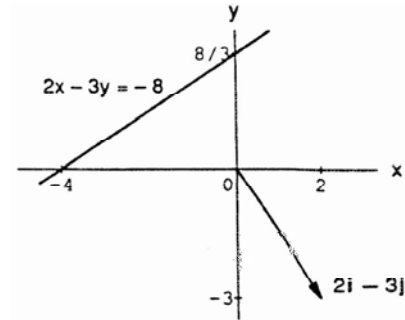

37. $\mathbf{v} = \mathbf{i} - \mathbf{j}$ is parallel to the line $-x - y = c$;
 $P(-2, 1)$ on the line $\Rightarrow -(-2) - 1 = c \Rightarrow -x - y = 1$
 or $x + y = -1$.

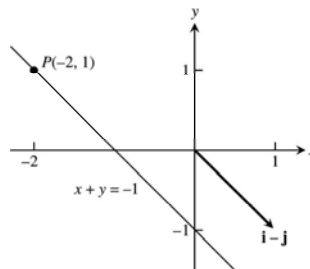

38. $\mathbf{v} = 2\mathbf{i} + 3\mathbf{j}$ is parallel to the line $3x - 2y = c$;
 $P(0, -2)$ on the line $\Rightarrow 3(0) - 2(-2) = c \Rightarrow 3x - 2y = 4$

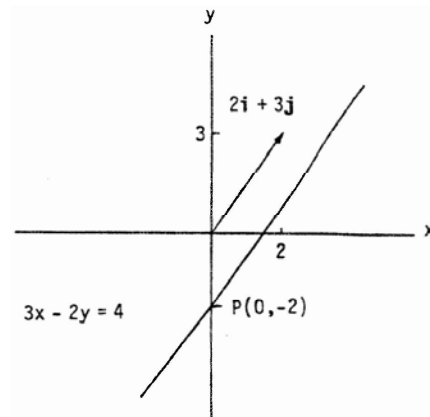

39. $\mathbf{v} = -\mathbf{i} - 2\mathbf{j}$ is parallel to the line $-2x + y = c$;
 $P(1, 2)$ on the line $\Rightarrow -2(1) + 2 = c \Rightarrow -2x + y = 0$
 or $2x - y = 0$.

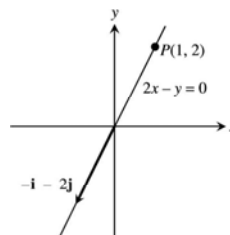

40. $\mathbf{v} = 3\mathbf{i} - 2\mathbf{j}$ is parallel to the line $-2x - 3y = c$;
 $P(1, 3)$ on the line $\Rightarrow (-2)(1) - (3)(3) = c$
 $\Rightarrow -2x - 3y = -11$ or $2x + 3y = 11$

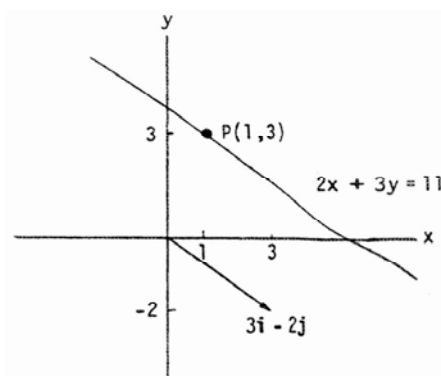

41. $P(0, 0)$, $Q(1, 1)$ and $\mathbf{F} = 5\mathbf{j} \Rightarrow \overrightarrow{PQ} = \mathbf{i} + \mathbf{j}$ and $\mathbf{W} = \mathbf{F} \cdot \overrightarrow{PQ} = (5\mathbf{j}) \cdot (\mathbf{i} + \mathbf{j}) = 5 \text{ N} \cdot \text{m} = 5 \text{ J}$
42. $\mathbf{W} = |\mathbf{F}|$ (distance) $\cos \theta = (602, 148 \text{ N})(605 \text{ km})(\cos 0) = 364, 299, 540 \text{ N} \cdot \text{km} = (364, 299, 540)(1000) \text{ N} \cdot \text{m}$
 $= 3.6429954 \times 10^{11} \text{ J}$
43. $\mathbf{W} = |\mathbf{F}| |\overrightarrow{PQ}| \cos \theta = (200)(20)(\cos 30^\circ) = 2000\sqrt{3} = 3464.10 \text{ N} \cdot \text{m} = 3464.10 \text{ J}$
44. $\mathbf{W} = |\mathbf{F}| |\overrightarrow{PQ}| \cos \theta = (1000)(5280)(\cos 60^\circ) = 2, 640, 000 \text{ ft} \cdot \text{lb}$

In Exercises 45-50 we use the fact that $\mathbf{n} = a\mathbf{i} + b\mathbf{j}$ is normal to the line $ax + by = c$.

45. $\mathbf{n}_1 = 3\mathbf{i} + \mathbf{j}$ and $\mathbf{n}_2 = 2\mathbf{i} - \mathbf{j} \Rightarrow \theta = \cos^{-1} \left(\frac{\mathbf{n}_1 \cdot \mathbf{n}_2}{|\mathbf{n}_1| |\mathbf{n}_2|} \right) = \cos^{-1} \left(\frac{6-1}{\sqrt{10}\sqrt{5}} \right) = \cos^{-1} \left(\frac{1}{\sqrt{2}} \right) = \frac{\pi}{4}$
46. $\mathbf{n}_1 = -\sqrt{3}\mathbf{i} + \mathbf{j}$ and $\mathbf{n}_2 = \sqrt{3}\mathbf{i} + \mathbf{j} \Rightarrow \theta = \cos^{-1} \left(\frac{\mathbf{n}_1 \cdot \mathbf{n}_2}{|\mathbf{n}_1| |\mathbf{n}_2|} \right) = \cos^{-1} \left(\frac{-3+1}{\sqrt{4}\sqrt{4}} \right) = \cos^{-1} \left(-\frac{1}{2} \right) = \frac{2\pi}{3}$
47. $\mathbf{n}_1 = \sqrt{3}\mathbf{i} - \mathbf{j}$ and $\mathbf{n}_2 = \mathbf{i} - \sqrt{3}\mathbf{j} \Rightarrow \theta = \cos^{-1} \left(\frac{\mathbf{n}_1 \cdot \mathbf{n}_2}{|\mathbf{n}_1| |\mathbf{n}_2|} \right) = \cos^{-1} \left(\frac{\sqrt{3}+\sqrt{3}}{\sqrt{4}\sqrt{4}} \right) = \cos^{-1} \left(\frac{\sqrt{3}}{2} \right) = \frac{\pi}{6}$
48. $\mathbf{n}_1 = \mathbf{i} + \sqrt{3}\mathbf{j}$ and $\mathbf{n}_2 = (1-\sqrt{3})\mathbf{i} + (1+\sqrt{3})\mathbf{j} \Rightarrow \theta = \cos^{-1} \left(\frac{\mathbf{n}_1 \cdot \mathbf{n}_2}{|\mathbf{n}_1| |\mathbf{n}_2|} \right) = \cos^{-1} \left(\frac{1-\sqrt{3}+\sqrt{3}+3}{\sqrt{1+3}\sqrt{1-2\sqrt{3}+3+1+2\sqrt{3}+3}} \right)$
 $= \cos^{-1} \left(\frac{4}{2\sqrt{8}} \right) = \cos^{-1} \left(\frac{1}{\sqrt{2}} \right) = \frac{\pi}{4}$
49. $\mathbf{n}_1 = 3\mathbf{i} - 4\mathbf{j}$ and $\mathbf{n}_2 = \mathbf{i} - \mathbf{j} \Rightarrow \theta = \cos^{-1} \left(\frac{\mathbf{n}_1 \cdot \mathbf{n}_2}{|\mathbf{n}_1| |\mathbf{n}_2|} \right) = \cos^{-1} \left(\frac{3-4}{\sqrt{25}\sqrt{2}} \right) = \cos^{-1} \left(\frac{-1}{5\sqrt{2}} \right) \approx 0.14 \text{ rad}$
50. $\mathbf{n}_1 = 12\mathbf{i} + 5\mathbf{j}$ and $\mathbf{n}_2 = 2\mathbf{i} - 2\mathbf{j} \Rightarrow \theta = \cos^{-1} \left(\frac{\mathbf{n}_1 \cdot \mathbf{n}_2}{|\mathbf{n}_1| |\mathbf{n}_2|} \right) = \cos^{-1} \left(\frac{24-10}{\sqrt{169}\sqrt{8}} \right) = \cos^{-1} \left(\frac{14}{26\sqrt{2}} \right) \approx 1.18 \text{ rad}$

12.4 THE CROSS PRODUCT

$$1. \mathbf{u} \times \mathbf{v} = \begin{vmatrix} \mathbf{i} & \mathbf{j} & \mathbf{k} \\ 2 & -2 & -1 \\ 1 & 0 & -1 \end{vmatrix} = 3 \left(\frac{2}{3} \mathbf{i} + \frac{1}{3} \mathbf{j} + \frac{2}{3} \mathbf{k} \right) \Rightarrow \text{length} = 3 \text{ and the direction is } \frac{2}{3} \mathbf{i} + \frac{1}{3} \mathbf{j} + \frac{2}{3} \mathbf{k};$$

$$\mathbf{v} \times \mathbf{u} = -(\mathbf{u} \times \mathbf{v}) = -3 \left(\frac{2}{3} \mathbf{i} + \frac{1}{3} \mathbf{j} + \frac{2}{3} \mathbf{k} \right) \Rightarrow \text{length} = 3 \text{ and the direction is } -\frac{2}{3} \mathbf{i} - \frac{1}{3} \mathbf{j} - \frac{2}{3} \mathbf{k}$$

$$2. \mathbf{u} \times \mathbf{v} = \begin{vmatrix} \mathbf{i} & \mathbf{j} & \mathbf{k} \\ 2 & 3 & 0 \\ -1 & 1 & 0 \end{vmatrix} = 5(\mathbf{k}) \Rightarrow \text{length} = 5 \text{ and the direction is } \mathbf{k}$$

$$\mathbf{v} \times \mathbf{u} = -(\mathbf{u} \times \mathbf{v}) = -5(\mathbf{k}) \Rightarrow \text{length} = 5 \text{ and the direction is } -\mathbf{k}$$

$$3. \mathbf{u} \times \mathbf{v} = \begin{vmatrix} \mathbf{i} & \mathbf{j} & \mathbf{k} \\ 2 & -2 & 4 \\ -1 & 1 & -2 \end{vmatrix} = \mathbf{0} \Rightarrow \text{length} = 0 \text{ and has no direction}$$

$$\mathbf{v} \times \mathbf{u} = -(\mathbf{u} \times \mathbf{v}) = \mathbf{0} \Rightarrow \text{length} = 0 \text{ and has no direction}$$

$$4. \mathbf{u} \times \mathbf{v} = \begin{vmatrix} \mathbf{i} & \mathbf{j} & \mathbf{k} \\ 1 & 1 & -1 \\ 0 & 0 & 0 \end{vmatrix} = \mathbf{0} \Rightarrow \text{length} = 0 \text{ and has no direction}$$

$$\mathbf{v} \times \mathbf{u} = -(\mathbf{u} \times \mathbf{v}) = \mathbf{0} \Rightarrow \text{length} = 0 \text{ and has no direction}$$

$$5. \mathbf{u} \times \mathbf{v} = \begin{vmatrix} \mathbf{i} & \mathbf{j} & \mathbf{k} \\ 2 & 0 & 0 \\ 0 & -3 & 0 \end{vmatrix} = -6(\mathbf{k}) \Rightarrow \text{length} = 6 \text{ and the direction is } -\mathbf{k}$$

$$\mathbf{v} \times \mathbf{u} = -(\mathbf{u} \times \mathbf{v}) = 6(\mathbf{k}) \Rightarrow \text{length} = 6 \text{ and the direction is } \mathbf{k}$$

$$6. \mathbf{u} \times \mathbf{v} = (\mathbf{i} \times \mathbf{j}) \times (\mathbf{j} \times \mathbf{k}) = \mathbf{k} \times \mathbf{i} = \begin{vmatrix} \mathbf{i} & \mathbf{j} & \mathbf{k} \\ 0 & 0 & 1 \\ 1 & 0 & 0 \end{vmatrix} = \mathbf{j} \Rightarrow \text{length} = 1 \text{ and the direction is } \mathbf{j}$$

$$\mathbf{v} \times \mathbf{u} = -(\mathbf{u} \times \mathbf{v}) = -\mathbf{j} \Rightarrow \text{length} = 1 \text{ and the direction is } -\mathbf{j}$$

$$7. \mathbf{u} \times \mathbf{v} = \begin{vmatrix} \mathbf{i} & \mathbf{j} & \mathbf{k} \\ -8 & -2 & -4 \\ 2 & 2 & 1 \end{vmatrix} = 6\mathbf{i} - 12\mathbf{k} \Rightarrow \text{length} = 6\sqrt{5} \text{ and the direction is } \frac{1}{\sqrt{5}} \mathbf{i} - \frac{2}{\sqrt{5}} \mathbf{k}$$

$$\mathbf{v} \times \mathbf{u} = -(\mathbf{u} \times \mathbf{v}) = -(6\mathbf{i} - 12\mathbf{k}) \Rightarrow \text{length} = 6\sqrt{5} \text{ and the direction is } -\frac{1}{\sqrt{5}} \mathbf{i} + \frac{2}{\sqrt{5}} \mathbf{k}$$

$$8. \mathbf{u} \times \mathbf{v} = \begin{vmatrix} \mathbf{i} & \mathbf{j} & \mathbf{k} \\ \frac{3}{2} & -\frac{1}{2} & 1 \\ 1 & 1 & 2 \end{vmatrix} = -2\mathbf{i} - 2\mathbf{j} + 2\mathbf{k} \Rightarrow \text{length} = 2\sqrt{3} \text{ and the direction is } -\frac{1}{\sqrt{3}} \mathbf{i} - \frac{1}{\sqrt{3}} \mathbf{j} + \frac{1}{\sqrt{3}} \mathbf{k}$$

$$\mathbf{v} \times \mathbf{u} = -(\mathbf{u} \times \mathbf{v}) = -(-2\mathbf{i} - 2\mathbf{j} + 2\mathbf{k}) \Rightarrow \text{length} = 2\sqrt{3} \text{ and the direction is } \frac{1}{\sqrt{3}} \mathbf{i} + \frac{1}{\sqrt{3}} \mathbf{j} - \frac{1}{\sqrt{3}} \mathbf{k}$$

9. $\mathbf{u} \times \mathbf{v} = \begin{vmatrix} \mathbf{i} & \mathbf{j} & \mathbf{k} \\ 1 & 0 & 0 \\ 0 & 1 & 0 \end{vmatrix} = \mathbf{k}$

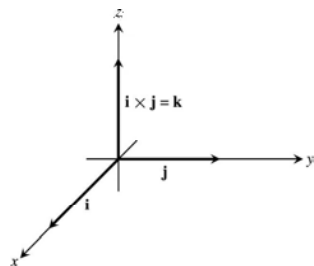

10. $\mathbf{u} \times \mathbf{v} = \begin{vmatrix} \mathbf{i} & \mathbf{j} & \mathbf{k} \\ 1 & 0 & -1 \\ 0 & 1 & 0 \end{vmatrix} = \mathbf{i} + \mathbf{k}$

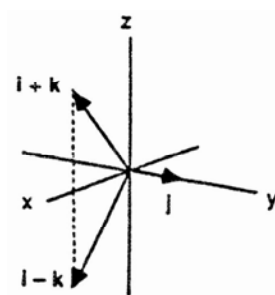

11. $\mathbf{u} \times \mathbf{v} = \begin{vmatrix} \mathbf{i} & \mathbf{j} & \mathbf{k} \\ 1 & 0 & -1 \\ 0 & 1 & 1 \end{vmatrix} = \mathbf{i} - \mathbf{j} + \mathbf{k}$

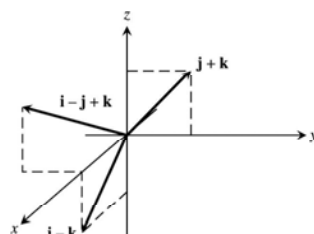

12. $\mathbf{u} \times \mathbf{v} = \begin{vmatrix} \mathbf{i} & \mathbf{j} & \mathbf{k} \\ 2 & -1 & 0 \\ 1 & 2 & 0 \end{vmatrix} = 5\mathbf{k}$

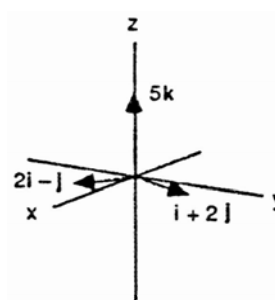

13. $\mathbf{u} \times \mathbf{v} = \begin{vmatrix} \mathbf{i} & \mathbf{j} & \mathbf{k} \\ 1 & 1 & 0 \\ 1 & -1 & 0 \end{vmatrix} = -2\mathbf{k}$

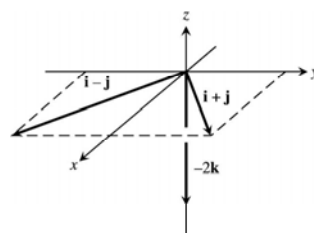

14. $\mathbf{u} \times \mathbf{v} = \begin{vmatrix} \mathbf{i} & \mathbf{j} & \mathbf{k} \\ 0 & 1 & 2 \\ 1 & 0 & 0 \end{vmatrix} = 2\mathbf{j} - \mathbf{k}$

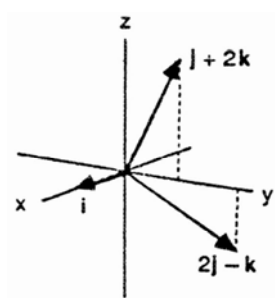

15. (a) $\overline{PQ} \times \overline{PR} = \begin{vmatrix} \mathbf{i} & \mathbf{j} & \mathbf{k} \\ 1 & 1 & -3 \\ -1 & 3 & -1 \end{vmatrix} = 8\mathbf{i} + 4\mathbf{j} + 4\mathbf{k} \Rightarrow \text{Area} = \frac{1}{2} |\overline{PQ} \times \overline{PR}| = \frac{1}{2} \sqrt{64+16+16} = 2\sqrt{6}$

(b) $\mathbf{u} = \frac{\overline{PQ} \times \overline{PR}}{|\overline{PQ} \times \overline{PR}|} = \frac{1}{\sqrt{6}} (2\mathbf{i} + \mathbf{j} + \mathbf{k})$

$$16. (a) \overline{PQ} \times \overline{PR} = \begin{vmatrix} \mathbf{i} & \mathbf{j} & \mathbf{k} \\ 1 & 0 & 2 \\ 2 & -2 & 0 \end{vmatrix} = 4\mathbf{i} + 4\mathbf{j} - 2\mathbf{k} \Rightarrow \text{Area} = \frac{1}{2} |\overline{PQ} \times \overline{PR}| = \frac{1}{2} \sqrt{16+16+4} = 3$$

$$(b) \mathbf{u} = \frac{\overline{PQ} \times \overline{PR}}{|\overline{PQ} \times \overline{PR}|} = \frac{1}{3}(2\mathbf{i} + 2\mathbf{j} - \mathbf{k})$$

$$17. (a) \overline{PQ} \times \overline{PR} = \begin{vmatrix} \mathbf{i} & \mathbf{j} & \mathbf{k} \\ 1 & 1 & 1 \\ 1 & 1 & 0 \end{vmatrix} = -\mathbf{i} + \mathbf{j} \Rightarrow \text{Area} = \frac{1}{2} |\overline{PQ} \times \overline{PR}| = \frac{1}{2} \sqrt{1+1} = \frac{\sqrt{2}}{2}$$

$$(b) \mathbf{u} = \frac{\overline{PQ} \times \overline{PR}}{|\overline{PQ} \times \overline{PR}|} = \frac{1}{\sqrt{2}}(-\mathbf{i} + \mathbf{j}) \Rightarrow -\frac{1}{\sqrt{2}}(\mathbf{i} - \mathbf{j})$$

$$18. (a) \overline{PQ} \times \overline{PR} = \begin{vmatrix} \mathbf{i} & \mathbf{j} & \mathbf{k} \\ 2 & -1 & -1 \\ 1 & 0 & -2 \end{vmatrix} = 2\mathbf{i} + 3\mathbf{j} + \mathbf{k} \Rightarrow \text{Area} = \frac{1}{2} |\overline{PQ} \times \overline{PR}| = \frac{1}{2} \sqrt{4+9+1} = \frac{\sqrt{14}}{2}$$

$$(b) \mathbf{u} = \frac{\overline{PQ} \times \overline{PR}}{|\overline{PQ} \times \overline{PR}|} = \frac{1}{\sqrt{14}}(2\mathbf{i} + 3\mathbf{j} + \mathbf{k})$$

$$19. \text{ If } \mathbf{u} = a_1\mathbf{i} + a_2\mathbf{j} + a_3\mathbf{k}, \mathbf{v} = b_1\mathbf{i} + b_2\mathbf{j} + b_3\mathbf{k}, \text{ and } \mathbf{w} = c_1\mathbf{i} + c_2\mathbf{j} + c_3\mathbf{k}, \text{ then } (\mathbf{u} \times \mathbf{v}) \cdot \mathbf{w} = \begin{vmatrix} a_1 & a_2 & a_3 \\ b_1 & b_2 & b_3 \\ c_1 & c_2 & c_3 \end{vmatrix},$$

$$(\mathbf{v} \times \mathbf{w}) \cdot \mathbf{u} = \begin{vmatrix} b_1 & b_2 & b_3 \\ c_1 & c_2 & c_3 \\ a_1 & a_2 & a_3 \end{vmatrix} \text{ and } (\mathbf{w} \times \mathbf{u}) \cdot \mathbf{v} = \begin{vmatrix} c_1 & c_2 & c_3 \\ a_1 & a_2 & a_3 \\ b_1 & b_2 & b_3 \end{vmatrix} \text{ which all have the same absolute value,}$$

since interchanging two rows in a determinant does not change its absolute value

$$\Rightarrow \text{the volume is } |(\mathbf{u} \times \mathbf{v}) \cdot \mathbf{w}| = abs \begin{vmatrix} 2 & 0 & 0 \\ 0 & 2 & 0 \\ 0 & 0 & 2 \end{vmatrix} = 8$$

$$20. |(\mathbf{u} \times \mathbf{v}) \cdot \mathbf{w}| = abs \begin{vmatrix} 1 & -1 & 1 \\ 2 & 1 & -2 \\ -1 & 2 & -1 \end{vmatrix} = 4 \text{ (for details about verification, see Exercise 19)}$$

$$21. |(\mathbf{u} \times \mathbf{v}) \cdot \mathbf{w}| = abs \begin{vmatrix} 2 & 1 & 0 \\ 2 & -1 & 1 \\ 1 & 0 & 2 \end{vmatrix} = |-7| = 7 \text{ (for details about verification, see Exercise 19)}$$

$$22. |(\mathbf{u} \times \mathbf{v}) \cdot \mathbf{w}| = abs \begin{vmatrix} 1 & 1 & -2 \\ -1 & 0 & -1 \\ 2 & 4 & -2 \end{vmatrix} = 8 \text{ (for details about verification, see Exercise 19)}$$

23. (a) $\mathbf{u} \cdot \mathbf{v} = -6$, $\mathbf{u} \cdot \mathbf{w} = -81$, $\mathbf{v} \cdot \mathbf{w} = 18 \Rightarrow$ none are perpendicular

$$(b) \mathbf{u} \times \mathbf{v} = \begin{vmatrix} \mathbf{i} & \mathbf{j} & \mathbf{k} \\ 5 & -1 & 1 \\ 0 & 1 & -5 \end{vmatrix} \neq \mathbf{0}, \mathbf{u} \times \mathbf{w} = \begin{vmatrix} \mathbf{i} & \mathbf{j} & \mathbf{k} \\ 5 & -1 & 1 \\ -15 & 3 & -3 \end{vmatrix} = \mathbf{0}, \mathbf{v} \times \mathbf{w} = \begin{vmatrix} \mathbf{i} & \mathbf{j} & \mathbf{k} \\ 0 & 1 & -5 \\ -15 & 3 & -3 \end{vmatrix} \neq \mathbf{0} \Rightarrow \mathbf{u} \text{ and } \mathbf{w} \text{ are parallel}$$

24. (a) $\mathbf{u} \cdot \mathbf{v} = 0$, $\mathbf{u} \cdot \mathbf{w} = 0$, $\mathbf{u} \cdot \mathbf{r} = -3\pi$, $\mathbf{v} \cdot \mathbf{w} = 0$, $\mathbf{v} \cdot \mathbf{r} = 0$, $\mathbf{w} \cdot \mathbf{r} = 0 \Rightarrow \mathbf{u} \perp \mathbf{v}$, $\mathbf{u} \perp \mathbf{w}$, $\mathbf{v} \perp \mathbf{w}$, $\mathbf{v} \perp \mathbf{r}$ and $\mathbf{w} \perp \mathbf{r}$

$$(b) \mathbf{u} \times \mathbf{v} = \begin{vmatrix} \mathbf{i} & \mathbf{j} & \mathbf{k} \\ 1 & 2 & -1 \\ -1 & 1 & 1 \end{vmatrix} \neq \mathbf{0}, \mathbf{u} \times \mathbf{w} = \begin{vmatrix} \mathbf{i} & \mathbf{j} & \mathbf{k} \\ 1 & 2 & -1 \\ 1 & 0 & 1 \end{vmatrix} \neq \mathbf{0}, \mathbf{u} \times \mathbf{r} = \begin{vmatrix} \mathbf{i} & \mathbf{j} & \mathbf{k} \\ 1 & 2 & -1 \\ -\frac{\pi}{2} & -\pi & \frac{\pi}{2} \end{vmatrix} = \mathbf{0}$$

$$\mathbf{v} \times \mathbf{w} = \begin{vmatrix} \mathbf{i} & \mathbf{j} & \mathbf{k} \\ -1 & 1 & 1 \\ 1 & 0 & 1 \end{vmatrix} \neq \mathbf{0}, \mathbf{v} \times \mathbf{r} = \begin{vmatrix} \mathbf{i} & \mathbf{j} & \mathbf{k} \\ -1 & 1 & 1 \\ -\frac{\pi}{2} & -\pi & \frac{\pi}{2} \end{vmatrix} \neq \mathbf{0}, \mathbf{w} \times \mathbf{r} = \begin{vmatrix} \mathbf{i} & \mathbf{j} & \mathbf{k} \\ 1 & 0 & 1 \\ -\frac{\pi}{2} & -\pi & \frac{\pi}{2} \end{vmatrix} \neq \mathbf{0} \Rightarrow \mathbf{u} \text{ and } \mathbf{r} \text{ are parallel}$$

$$25. |\overline{PQ} \times \mathbf{F}| = |\overline{PQ}| |\mathbf{F}| \sin(60^\circ) = \frac{2}{3} \cdot 30 \cdot \frac{\sqrt{3}}{2} \text{ ft} \cdot \text{lb} = 10\sqrt{3} \text{ ft} \cdot \text{lb}$$

$$26. |\overline{PQ} \times \mathbf{F}| = |\overline{PQ}| |\mathbf{F}| \sin(135^\circ) = \frac{2}{3} \cdot 30 \cdot \frac{\sqrt{2}}{2} \text{ ft} \cdot \text{lb} = 10\sqrt{2} \text{ ft} \cdot \text{lb}$$

27. (a) true, $|\mathbf{u}| = \sqrt{a_1^2 + a_2^2 + a_3^2} = \sqrt{\mathbf{u} \cdot \mathbf{u}}$

(b) not always true, $\mathbf{u} \cdot \mathbf{u} = |\mathbf{u}|^2$

$$(c) \text{ true, } \mathbf{u} \times \mathbf{0} = \begin{vmatrix} \mathbf{i} & \mathbf{j} & \mathbf{k} \\ u_1 & u_2 & u_3 \\ 0 & 0 & 0 \end{vmatrix} = 0\mathbf{i} + 0\mathbf{j} + 0\mathbf{k} = \mathbf{0} \text{ and } \mathbf{0} \times \mathbf{u} = \begin{vmatrix} \mathbf{i} & \mathbf{j} & \mathbf{k} \\ 0 & 0 & 0 \\ u_1 & u_2 & u_3 \end{vmatrix} = 0\mathbf{i} + 0\mathbf{j} + 0\mathbf{k} = \mathbf{0}$$

$$(d) \text{ true, } \mathbf{u} \times (-\mathbf{u}) = \begin{vmatrix} \mathbf{i} & \mathbf{j} & \mathbf{k} \\ u_1 & u_2 & u_3 \\ -u_1 & -u_2 & -u_3 \end{vmatrix} = (-u_2u_3 + u_2u_3)\mathbf{i} - (-u_1u_3 + u_1u_3)\mathbf{j} + (-u_1u_2 + u_1u_2)\mathbf{k} = \mathbf{0}$$

(e) not always true, $\mathbf{i} \times \mathbf{j} = \mathbf{k} \neq -\mathbf{k} = \mathbf{j} \times \mathbf{i}$ for example

(f) true, distributive property of the cross product

(g) true, $(\mathbf{u} \times \mathbf{v}) \cdot \mathbf{v} = \mathbf{u} \cdot (\mathbf{v} \times \mathbf{v}) = \mathbf{u} \cdot \mathbf{0} = 0$

(h) true, the volume of a parallelepiped with \mathbf{u} , \mathbf{v} , and \mathbf{w} along the three edges is the same whether the plane containing \mathbf{u} and \mathbf{v} or the plane containing \mathbf{v} and \mathbf{w} is used as the base plane, and the dot product is commutative.

28. (a) true, $\mathbf{u} \cdot \mathbf{v} = u_1v_1 + u_2v_2 + u_3v_3 = v_1u_1 + v_2u_2 + v_3u_3 = \mathbf{v} \cdot \mathbf{u}$

$$(b) \text{ true, } \mathbf{u} \times \mathbf{v} = \begin{vmatrix} \mathbf{i} & \mathbf{j} & \mathbf{k} \\ u_1 & u_2 & u_3 \\ v_1 & v_2 & v_3 \end{vmatrix} = -\begin{vmatrix} \mathbf{i} & \mathbf{j} & \mathbf{k} \\ v_1 & v_2 & v_3 \\ u_1 & u_2 & u_3 \end{vmatrix} = -(\mathbf{v} \times \mathbf{u})$$

$$(c) \text{ true, } (-\mathbf{u}) \times \mathbf{v} = \begin{vmatrix} \mathbf{i} & \mathbf{j} & \mathbf{k} \\ -u_1 & -u_2 & -u_3 \\ v_1 & v_2 & v_3 \end{vmatrix} = -\begin{vmatrix} \mathbf{i} & \mathbf{j} & \mathbf{k} \\ u_1 & u_2 & u_3 \\ v_1 & v_2 & v_3 \end{vmatrix} = -(\mathbf{u} \times \mathbf{v})$$

(d) true, $(c\mathbf{u}) \cdot \mathbf{v} = (cu_1)v_1 + (cu_2)v_2 + (cu_3)v_3 = u_1(cv_1) + u_2(cv_2) + u_3(cv_3) = \mathbf{u} \cdot (c\mathbf{v}) = c(u_1v_1 + u_2v_2 + u_3v_3) = c(\mathbf{u} \cdot \mathbf{v})$

(e) true, $c(\mathbf{u} \times \mathbf{v}) = c \begin{vmatrix} \mathbf{i} & \mathbf{j} & \mathbf{k} \\ u_1 & u_2 & u_3 \\ v_1 & v_2 & v_3 \end{vmatrix} = \begin{vmatrix} \mathbf{i} & \mathbf{j} & \mathbf{k} \\ cu_1 & cu_2 & cu_3 \\ v_1 & v_2 & v_3 \end{vmatrix} = (c\mathbf{u}) \times \mathbf{v} = \begin{vmatrix} \mathbf{i} & \mathbf{j} & \mathbf{k} \\ u_1 & u_2 & u_3 \\ cv_1 & cv_2 & cv_3 \end{vmatrix} = \mathbf{u} \times (c\mathbf{v})$

(f) true, $\mathbf{u} \cdot \mathbf{u} = u_1^2 + u_2^2 + u_3^2 = \left(\sqrt{u_1^2 + u_2^2 + u_3^2}\right)^2 = |\mathbf{u}|^2$

(g) true, $(\mathbf{u} \times \mathbf{u}) \cdot \mathbf{u} = \mathbf{0} \cdot \mathbf{u} = 0$

(h) true, $\mathbf{u} \times \mathbf{v} \perp \mathbf{u}$ and $\mathbf{u} \times \mathbf{v} \perp \mathbf{v} \Rightarrow (\mathbf{u} \times \mathbf{v}) \cdot \mathbf{u} = \mathbf{v} \cdot (\mathbf{u} \times \mathbf{v}) = 0$

29. (a) $\text{proj}_{\mathbf{v}} \mathbf{u} = \left(\frac{\mathbf{u} \cdot \mathbf{v}}{|\mathbf{v}|^2}\right) \mathbf{v}$ (b) $(\mathbf{u} \times \mathbf{v})$ (c) $((\mathbf{u} \times \mathbf{v}) \times \mathbf{w})$ (d) $|(\mathbf{u} \times \mathbf{v}) \cdot \mathbf{w}|$

(e) $(\mathbf{u} \times \mathbf{v}) \times (\mathbf{u} \times \mathbf{w})$ (f) $|\mathbf{u}| \frac{\mathbf{v}}{|\mathbf{v}|}$

30. $(\mathbf{i} \times \mathbf{j}) \times \mathbf{j} = \mathbf{k} \times \mathbf{j} = -\mathbf{i}$; $\mathbf{i} \times (\mathbf{j} \times \mathbf{j}) = \mathbf{i} \times \mathbf{0} = \mathbf{0}$. The cross product is not associative.

31. (a) yes, $\mathbf{u} \times \mathbf{v}$ and \mathbf{w} are both vectors (b) no, \mathbf{u} is a vector but $\mathbf{v} \cdot \mathbf{w}$ is a scalar
(c) yes, \mathbf{u} and $\mathbf{u} \times \mathbf{w}$ are both vectors (d) no, \mathbf{u} is a vector but $\mathbf{v} \cdot \mathbf{w}$ is a scalar

32. $(\mathbf{u} \times \mathbf{v}) \times \mathbf{w}$ is perpendicular to $\mathbf{u} \times \mathbf{v}$, and $\mathbf{u} \times \mathbf{v}$ is perpendicular to both \mathbf{u} and $\mathbf{v} \Rightarrow (\mathbf{u} \times \mathbf{v}) \times \mathbf{w}$ is parallel to a vector in the plane of \mathbf{u} and \mathbf{v} which means it lies in the plane determined by \mathbf{u} and \mathbf{v} . The situation is degenerate if \mathbf{u} and \mathbf{v} are parallel so $\mathbf{u} \times \mathbf{v} = \mathbf{0}$ and the vectors do not determine a plane. Similar reasoning shows that $\mathbf{u} \times (\mathbf{v} \times \mathbf{w})$ lies in the plane of \mathbf{v} and \mathbf{w} provided \mathbf{v} and \mathbf{w} are nonparallel.

33. No, \mathbf{v} need not equal \mathbf{w} . For example, $\mathbf{i} + \mathbf{j} \neq -\mathbf{i} + \mathbf{j}$, but $\mathbf{i} \times (\mathbf{i} + \mathbf{j}) = \mathbf{i} \times \mathbf{i} + \mathbf{i} \times \mathbf{j} = \mathbf{0} + \mathbf{k} = \mathbf{k}$ and $\mathbf{i} \times (-\mathbf{i} + \mathbf{j}) = \mathbf{i} \times (-\mathbf{i}) + \mathbf{i} \times \mathbf{j} = \mathbf{0} + \mathbf{k} = \mathbf{k}$.

34. Yes. If $\mathbf{u} \times \mathbf{v} = \mathbf{u} \times \mathbf{w}$ and $\mathbf{u} \cdot \mathbf{v} = \mathbf{u} \cdot \mathbf{w}$, then $\mathbf{u} \times (\mathbf{v} - \mathbf{w}) = \mathbf{0}$ and $\mathbf{u} \cdot (\mathbf{v} - \mathbf{w}) = 0$. Suppose now that $\mathbf{v} \neq \mathbf{w}$. Then $\mathbf{u} \times (\mathbf{v} - \mathbf{w}) = \mathbf{0}$ implies that $\mathbf{v} - \mathbf{w} = k\mathbf{u}$ for some real number $k \neq 0$. This in turn implies that $\mathbf{u} \cdot (\mathbf{v} - \mathbf{w}) = \mathbf{u} \cdot (k\mathbf{u}) = k|\mathbf{u}|^2 = 0$, which implies that $\mathbf{u} = \mathbf{0}$. Since $\mathbf{u} \neq \mathbf{0}$, it cannot be true that $\mathbf{v} \neq \mathbf{w}$, so $\mathbf{v} = \mathbf{w}$.

35. $\overline{AB} = -\mathbf{i} + \mathbf{j}$ and $\overline{AD} = -\mathbf{i} - \mathbf{j} \Rightarrow \overline{AB} \times \overline{AD} = \begin{vmatrix} \mathbf{i} & \mathbf{j} & \mathbf{k} \\ -1 & 1 & 0 \\ -1 & -1 & 0 \end{vmatrix} = 2\mathbf{k} \Rightarrow \text{area} = |\overline{AB} \times \overline{AD}| = 2$

36. $\overline{AB} = 7\mathbf{i} + 3\mathbf{j}$ and $\overline{AD} = 2\mathbf{i} + 5\mathbf{j} \Rightarrow \overline{AB} \times \overline{AD} = \begin{vmatrix} \mathbf{i} & \mathbf{j} & \mathbf{k} \\ 7 & 3 & 0 \\ 2 & 5 & 0 \end{vmatrix} = 29\mathbf{k} \Rightarrow \text{area} = |\overline{AB} \times \overline{AD}| = 29$

37. $\overline{AB} = 3\mathbf{i} - 2\mathbf{j}$ and $\overline{AD} = 5\mathbf{i} + \mathbf{j} \Rightarrow \overline{AB} \times \overline{AD} = \begin{vmatrix} \mathbf{i} & \mathbf{j} & \mathbf{k} \\ 3 & -2 & 0 \\ 5 & 1 & 0 \end{vmatrix} = 13\mathbf{k} \Rightarrow \text{area} = |\overline{AB} \times \overline{AD}| = 13$

$$38. \overline{AB} = 7\mathbf{i} - 4\mathbf{j} \text{ and } \overline{AD} = 2\mathbf{i} + 5\mathbf{j} \Rightarrow \overline{AB} \times \overline{AD} = \begin{vmatrix} \mathbf{i} & \mathbf{j} & \mathbf{k} \\ 7 & -4 & 0 \\ 2 & 5 & 0 \end{vmatrix} = 43\mathbf{k} \Rightarrow \text{area} = |\overline{AB} \times \overline{AD}| = 43$$

$$39. \overline{AB} = 3\mathbf{i} + 2\mathbf{j} + 4\mathbf{k} \text{ and } \overline{DC} = 3\mathbf{i} + 2\mathbf{j} + 4\mathbf{k} \Rightarrow \overline{AB} \text{ is parallel to } \overline{DC}; \overline{BC} = 2\mathbf{i} - \mathbf{j} \text{ and } \overline{AD} = 2\mathbf{i} - \mathbf{j} \Rightarrow \overline{BC} \text{ is parallel to } \overline{AD}. \overline{AB} \times \overline{BC} = \begin{vmatrix} \mathbf{i} & \mathbf{j} & \mathbf{k} \\ 3 & 2 & 4 \\ 2 & -1 & 0 \end{vmatrix} = 4\mathbf{i} + 8\mathbf{j} - 7\mathbf{k} \Rightarrow \text{area} = |\overline{AB} \times \overline{BC}| = \sqrt{129}$$

$$40. \overline{AC} = \mathbf{i} + 4\mathbf{j} \text{ and } \overline{DB} = \mathbf{i} + 4\mathbf{j} \Rightarrow \overline{AC} \text{ is parallel to } \overline{DB}; \overline{AD} = -\mathbf{i} + 3\mathbf{j} + 3\mathbf{k} \text{ and } \overline{CB} = -\mathbf{i} + 3\mathbf{j} + 3\mathbf{k} \Rightarrow \overline{AD} \text{ is parallel to } \overline{CB}. \overline{AC} \times \overline{AD} = \begin{vmatrix} \mathbf{i} & \mathbf{j} & \mathbf{k} \\ 1 & 4 & 0 \\ -1 & 3 & 3 \end{vmatrix} = 12\mathbf{i} - 3\mathbf{j} + 7\mathbf{k} \Rightarrow \text{area} = |\overline{AC} \times \overline{AD}| = \sqrt{202}$$

$$41. \overline{AB} = -2\mathbf{i} + 3\mathbf{j} \text{ and } \overline{AC} = 3\mathbf{i} + \mathbf{j} \Rightarrow \overline{AB} \times \overline{AC} = \begin{vmatrix} \mathbf{i} & \mathbf{j} & \mathbf{k} \\ -2 & 3 & 0 \\ 3 & 1 & 0 \end{vmatrix} = -11\mathbf{k} \Rightarrow \text{area} = \frac{1}{2} |\overline{AB} \times \overline{AC}| = \frac{11}{2}$$

$$42. \overline{AB} = 4\mathbf{i} + 4\mathbf{j} \text{ and } \overline{AC} = 3\mathbf{i} + 2\mathbf{j} \Rightarrow \overline{AB} \times \overline{AC} = \begin{vmatrix} \mathbf{i} & \mathbf{j} & \mathbf{k} \\ 4 & 4 & 0 \\ 3 & 2 & 0 \end{vmatrix} = -4\mathbf{k} \Rightarrow \text{area} = \frac{1}{2} |\overline{AB} \times \overline{AC}| = 2$$

$$43. \overline{AB} = 6\mathbf{i} - 5\mathbf{j} \text{ and } \overline{AC} = 11\mathbf{i} - 5\mathbf{j} \Rightarrow \overline{AB} \times \overline{AC} = \begin{vmatrix} \mathbf{i} & \mathbf{j} & \mathbf{k} \\ 6 & -5 & 0 \\ 11 & -5 & 0 \end{vmatrix} = 25\mathbf{k} \Rightarrow \text{area} = \frac{1}{2} |\overline{AB} \times \overline{AC}| = \frac{25}{2}$$

$$44. \overline{AB} = 16\mathbf{i} - 5\mathbf{j} \text{ and } \overline{AC} = 4\mathbf{i} + 4\mathbf{j} \Rightarrow \overline{AB} \times \overline{AC} = \begin{vmatrix} \mathbf{i} & \mathbf{j} & \mathbf{k} \\ 16 & -5 & 0 \\ 4 & 4 & 0 \end{vmatrix} = 84\mathbf{k} \Rightarrow \text{area} = \frac{1}{2} |\overline{AB} \times \overline{AC}| = 42$$

$$45. \overline{AB} = -\mathbf{i} + 2\mathbf{j} \text{ and } \overline{AC} = -\mathbf{i} - \mathbf{k} \Rightarrow \overline{AB} \times \overline{AC} = \begin{vmatrix} \mathbf{i} & \mathbf{j} & \mathbf{k} \\ -1 & 2 & 0 \\ -1 & 0 & -1 \end{vmatrix} = -2\mathbf{i} - \mathbf{j} + 2\mathbf{k} \Rightarrow \text{area} = \frac{1}{2} |\overline{AB} \times \overline{AC}| = \frac{3}{2}$$

$$46. \overline{AB} = -\mathbf{i} + \mathbf{j} - \mathbf{k} \text{ and } \overline{AC} = 3\mathbf{i} + 3\mathbf{k} \Rightarrow \overline{AB} \times \overline{AC} = \begin{vmatrix} \mathbf{i} & \mathbf{j} & \mathbf{k} \\ -1 & 1 & -1 \\ 3 & 0 & 3 \end{vmatrix} = 3\mathbf{i} - 3\mathbf{k} \Rightarrow \text{area} = \frac{1}{2} |\overline{AB} \times \overline{AC}| = \frac{3\sqrt{2}}{2}$$

$$47. \overline{AB} = -\mathbf{i} + 2\mathbf{j} \text{ and } \overline{AC} = \mathbf{j} - 2\mathbf{k} \Rightarrow \overline{AB} \times \overline{AC} = \begin{vmatrix} \mathbf{i} & \mathbf{j} & \mathbf{k} \\ -1 & 2 & 0 \\ 0 & 1 & -2 \end{vmatrix} = -4\mathbf{i} - 2\mathbf{j} - \mathbf{k} \Rightarrow \text{area} = \frac{1}{2} |\overline{AB} \times \overline{AC}| = \frac{\sqrt{21}}{2}$$

$$48. \quad \overline{AB} = \mathbf{i} + 2\mathbf{j}, \overline{AC} = -3\mathbf{j} + 2\mathbf{k} \text{ and } \overline{AD} = 3\mathbf{i} - 4\mathbf{j} + 5\mathbf{k} \Rightarrow (\overline{AB} \times \overline{AC}) \cdot \overline{AD} = \begin{vmatrix} 1 & 2 & 0 \\ 0 & -3 & 2 \\ 3 & -4 & 5 \end{vmatrix} = 5$$

$$\Rightarrow \text{volume} = |(\overline{AB} \times \overline{AC}) \cdot \overline{AD}| = 5$$

$$49. \quad \text{If } \mathbf{A} = a_1\mathbf{i} + a_2\mathbf{j} \text{ and } \mathbf{B} = b_1\mathbf{i} + b_2\mathbf{j}, \text{ then } \mathbf{A} \times \mathbf{B} = \begin{vmatrix} \mathbf{i} & \mathbf{j} & \mathbf{k} \\ a_1 & a_2 & 0 \\ b_1 & b_2 & 0 \end{vmatrix} = \begin{vmatrix} a_1 & a_2 \\ b_1 & b_2 \end{vmatrix} \mathbf{k} \text{ and the triangle's area is}$$

$\frac{1}{2} |\mathbf{A} \times \mathbf{B}| = \pm \frac{1}{2} \begin{vmatrix} a_1 & a_2 \\ b_1 & b_2 \end{vmatrix}$. The applicable sign is (+) if the acute angle from \mathbf{A} to \mathbf{B} runs counterclockwise in the xy -plane, and (-) if it runs clockwise, because the area must be a nonnegative number.

$$50. \quad \text{If } \mathbf{A} = a_1\mathbf{i} + a_2\mathbf{j}, \mathbf{B} = b_1\mathbf{i} + b_2\mathbf{j}, \text{ and } \mathbf{C} = c_1\mathbf{i} + c_2\mathbf{j}, \text{ then the area of the triangle is } \frac{1}{2} |\overline{AB} \times \overline{AC}|.$$

$$\text{Now, } \overline{AB} \times \overline{AC} = \begin{vmatrix} \mathbf{i} & \mathbf{j} & \mathbf{k} \\ b_1 - a_1 & b_2 - a_2 & 0 \\ c_1 - a_1 & c_2 - a_2 & 0 \end{vmatrix} = \begin{vmatrix} b_1 - a_1 & b_2 - a_2 \\ c_1 - a_1 & c_2 - a_2 \end{vmatrix} \mathbf{k} \Rightarrow \frac{1}{2} |\overline{AB} \times \overline{AC}|$$

$$= \frac{1}{2} |(b_1 - a_1)(c_2 - a_2) - (c_1 - a_1)(b_2 - a_2)| = \frac{1}{2} |a_1(b_2 - c_2) + a_2(c_1 - b_1) + (b_1c_2 - c_1b_2)| = \pm \frac{1}{2} \begin{vmatrix} a_1 & a_2 & 1 \\ b_1 & b_2 & 1 \\ c_1 & c_2 & 1 \end{vmatrix}.$$

The applicable sign ensures the area formula gives a nonnegative number.

12.5 LINES AND PLANES IN SPACE

1. The direction $\mathbf{i} + \mathbf{j} + \mathbf{k}$ and $P(3, -4, -1) \Rightarrow x = 3 + t, y = -4 + t, z = -1 + t$
2. The direction $\overline{PQ} = -2\mathbf{i} - 2\mathbf{j} + 2\mathbf{k}$ and $P(1, 2, -1) \Rightarrow x = 1 - 2t, y = 2 - 2t, z = -1 + 2t$
3. The direction $\overline{PQ} = 5\mathbf{i} + 5\mathbf{j} - 5\mathbf{k}$ and $P(-2, 0, 3) \Rightarrow x = -2 + 5t, y = 5t, z = 3 - 5t$
4. The direction $\overline{PQ} = -\mathbf{j} - \mathbf{k}$ and $P(1, 2, 0) \Rightarrow x = 1, y = 2 - t, z = -t$
5. The direction $2\mathbf{j} + \mathbf{k}$ and $P(0, 0, 0) \Rightarrow x = 0, y = 2t, z = t$
6. The direction $2\mathbf{i} - \mathbf{j} + 3\mathbf{k}$ and $P(3, -2, 1) \Rightarrow x = 3 + 2t, y = -2 - t, z = 1 + 3t$
7. The direction \mathbf{k} and $P(1, 1, 1) \Rightarrow x = 1, y = 1, z = 1 + t$
8. The direction $3\mathbf{i} + 7\mathbf{j} - 5\mathbf{k}$ and $P(2, 4, 5) \Rightarrow x = 2 + 3t, y = 4 + 7t, z = 5 - 5t$
9. The direction $\mathbf{i} + 2\mathbf{j} + 2\mathbf{k}$ and $P(0, -7, 0) \Rightarrow x = t, y = -7 + 2t, z = 2t$

10. The direction is $\mathbf{u} \times \mathbf{v} = \begin{vmatrix} \mathbf{i} & \mathbf{j} & \mathbf{k} \\ 1 & 2 & 3 \\ 3 & 4 & 5 \end{vmatrix} = -2\mathbf{i} + 4\mathbf{j} - 2\mathbf{k}$ and $P(2, 3, 0) \Rightarrow x = 2 - 2t, y = 3 + 4t, z = -2t$

11. The direction \mathbf{i} and $P(0, 0, 0) \Rightarrow x = t, y = 0, z = 0$

12. The direction \mathbf{k} and $P(0, 0, 0) \Rightarrow x = 0, y = 0, z = t$

13. The direction $\overline{PQ} = \mathbf{i} + \mathbf{j} + \frac{3}{2}\mathbf{k}$ and $P(0, 0, 0)$
 $\Rightarrow x = t, y = t, z = \frac{3}{2}t$, where $0 \leq t \leq 1$

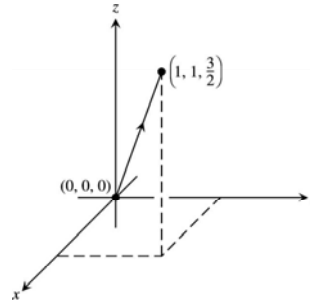

14. The direction $\overline{PQ} = \mathbf{i}$ and $P(0, 0, 0)$
 $\Rightarrow x = t, y = 0, z = 0$, where $0 \leq t \leq 1$

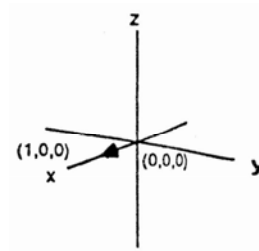

15. The direction $\overline{PQ} = \mathbf{j}$ and $P(1, 1, 0)$
 $\Rightarrow x = 1, y = 1 + t, z = 0$, where $-1 \leq t \leq 0$

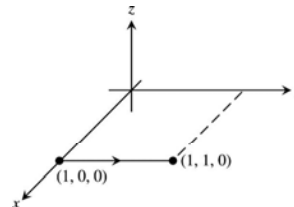

16. The direction $\overline{PQ} = \mathbf{k}$ and $P(1, 1, 0)$
 $\Rightarrow x = 1, y = 1, z = t$, where $0 \leq t \leq 1$

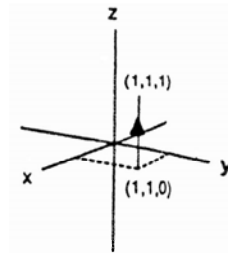

17. The direction $\overline{PQ} = -2\mathbf{j}$ and $P(0, 1, 1)$
 $\Rightarrow x = 0, y = 1 - 2t, z = 1$, where $0 \leq t \leq 1$

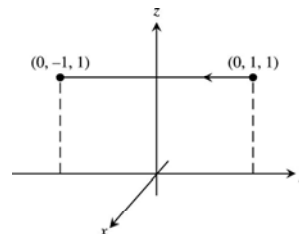

18. The direction $\overline{PQ} = 3\mathbf{i} - 2\mathbf{j}$ and $P(0, 2, 0)$
 $\Rightarrow x = 3t, y = 2 - 2t, z = 0$, where $0 \leq t \leq 1$

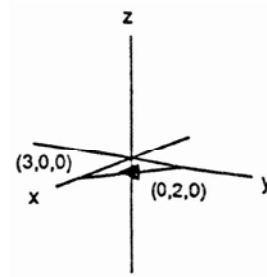

19. The direction $\overline{PQ} = -2\mathbf{i} + 2\mathbf{j} - 2\mathbf{k}$ and $P(2, 0, 2)$
 $\Rightarrow x = 2 - 2t, y = 2t, z = 2 - 2t$, where $0 \leq t \leq 1$

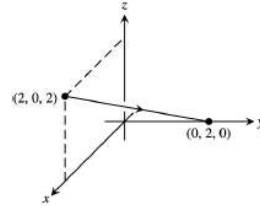

20. The direction $\overline{PQ} = -\mathbf{i} + 3\mathbf{j} + \mathbf{k}$ and $P(1, 0, -1)$
 $\Rightarrow x = 1 - t, y = 3t, z = -1 + t$, where $0 \leq t \leq 1$

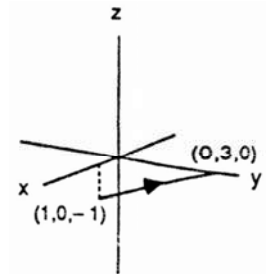

21. $3(x-0) + (-2)(y-2) + (-1)(z+1) = 0 \Rightarrow 3x - 2y - z = -3$

22. $3(x-1) + (1)(y+1) + (1)(z-3) = 0 \Rightarrow 3x + y + z = 5$

23. $\overline{PQ} = \mathbf{i} - \mathbf{j} + 3\mathbf{k}, \overline{PS} = -\mathbf{i} - 3\mathbf{j} + 2\mathbf{k} \Rightarrow \overline{PQ} \times \overline{PS} = \begin{vmatrix} \mathbf{i} & \mathbf{j} & \mathbf{k} \\ 1 & -1 & 3 \\ -1 & -3 & 2 \end{vmatrix} = 7\mathbf{i} - 5\mathbf{j} - 4\mathbf{k}$ is normal to the plane
 $\Rightarrow 7(x-2) + (-5)(y-0) + (-4)(z-2) = 0 \Rightarrow 7x - 5y - 4z = 6$

24. $\overline{PQ} = -\mathbf{i} + \mathbf{j} + 2\mathbf{k}, \overline{PS} = -3\mathbf{i} + 2\mathbf{j} + 3\mathbf{k} \Rightarrow \overline{PQ} \times \overline{PS} = \begin{vmatrix} \mathbf{i} & \mathbf{j} & \mathbf{k} \\ -1 & 1 & 2 \\ -3 & 2 & 3 \end{vmatrix} = -\mathbf{i} - 3\mathbf{j} + \mathbf{k}$ is normal to the plane
 $\Rightarrow (-1)(x-1) + (-3)(y-5) + (1)(z-7) = 0 \Rightarrow x + 3y - z = 9$

25. $\mathbf{n} = \mathbf{i} + 3\mathbf{j} + 4\mathbf{k}, P(2, 4, 5) \Rightarrow (1)(x-2) + (3)(y-4) + (4)(z-5) = 0 \Rightarrow x + 3y + 4z = 34$

26. $\mathbf{n} = \mathbf{i} - 2\mathbf{j} + \mathbf{k}, P(1, -2, 1) \Rightarrow (1)(x-1) + (-2)(y+2) + (1)(z-1) = 0 \Rightarrow x - 2y + z = 6$

27. $\begin{cases} x = 2t + 1 = s + 2 \\ y = 3t + 2 = 2s + 4 \end{cases} \Rightarrow \begin{cases} 2t - s = 1 \\ 3t - 2s = 2 \end{cases} \Rightarrow \begin{cases} 4t - 2s = 2 \\ 3t - 2s = 2 \end{cases} \Rightarrow t = 0 \text{ and } s = -1$; then $z = 4t + 3 = -4s - 1$
 $\Rightarrow 4(0) + 3 = (-4)(-1) - 1$ is satisfied \Rightarrow the lines intersect when $t = 0$ and $s = -1 \Rightarrow$ the point of intersection is $x = 1, y = 2$, and $z = 3$ or $P(1, 2, 3)$. A vector normal to the plane determined by these lines is
- $$\mathbf{n}_1 \times \mathbf{n}_2 = \begin{vmatrix} \mathbf{i} & \mathbf{j} & \mathbf{k} \\ 2 & 3 & 4 \\ 1 & 2 & -4 \end{vmatrix} = -20\mathbf{i} + 12\mathbf{j} + \mathbf{k},$$
- where \mathbf{n}_1 and \mathbf{n}_2 are directions of the lines \Rightarrow the plane containing the lines is represented by $(-20)(x-1) + (12)(y-2) + (1)(z-3) = 0 \Rightarrow -20x + 12y + z = 7$.
28. $\begin{cases} x = t = 2s + 2 \\ y = -t + 2 = s + 3 \end{cases} \Rightarrow \begin{cases} t - 2s = 2 \\ -t - s = 1 \end{cases} \Rightarrow s = -1 \text{ and } t = 0$; then $z = t + 1 = 5s + 6 \Rightarrow 0 + 1 = 5(-1) + 6$ is satisfied
 \Rightarrow the lines do intersect when $s = -1$ and $t = 0 \Rightarrow$ the point of intersection is $x = 0, y = 2$ and $z = 1$ or $P(0, 2, 1)$. A vector normal to the plane determined by these lines is $\mathbf{n}_1 \times \mathbf{n}_2 = \begin{vmatrix} \mathbf{i} & \mathbf{j} & \mathbf{k} \\ 1 & -1 & 1 \\ 2 & 1 & 5 \end{vmatrix} = -6\mathbf{i} - 3\mathbf{j} + 3\mathbf{k}$,
 when \mathbf{n}_1 and \mathbf{n}_2 are directions of the lines \Rightarrow the plane containing the lines is represented by $(-6)(x-0) + (-3)(y-2) + (3)(z-1) = 0 \Rightarrow 6x + 3y - 3z = 3$.
29. The cross product of $\mathbf{i} + \mathbf{j} - \mathbf{k}$ and $-4\mathbf{i} + 2\mathbf{j} - 2\mathbf{k}$ has the same direction as the normal to the plane
 $\Rightarrow \mathbf{n} = \begin{vmatrix} \mathbf{i} & \mathbf{j} & \mathbf{k} \\ 1 & 1 & -1 \\ -4 & 2 & -2 \end{vmatrix} = 6\mathbf{j} + 6\mathbf{k}$. Select a point on either line, such as $P(-1, 2, 1)$. Since the lines are given to intersect, the desired plane is $0(x+1) + 6(y-2) + 6(z-1) = 0 \Rightarrow 6y + 6z = 18 \Rightarrow y + z = 3$.
30. The cross product of $\mathbf{i} - 3\mathbf{j} - \mathbf{k}$ and $\mathbf{i} + \mathbf{j} + \mathbf{k}$ has the same direction as the normal to the plane
 $\mathbf{n} = \begin{vmatrix} \mathbf{i} & \mathbf{j} & \mathbf{k} \\ 1 & -3 & -1 \\ 1 & 1 & 1 \end{vmatrix} = -2\mathbf{i} - 2\mathbf{j} + 4\mathbf{k}$. Select a point on either line, such as $P(0, 3, -2)$. Since the lines are given to intersect, the desired plane is $(-2)(x-0) + (-2)(y-3) + (4)(z+2) = 0 \Rightarrow -2x - 2y + 4z = -14 \Rightarrow x + y - 2z = 7$.
31. $\mathbf{n}_1 \times \mathbf{n}_2 = \begin{vmatrix} \mathbf{i} & \mathbf{j} & \mathbf{k} \\ 2 & 1 & -1 \\ 1 & 2 & 1 \end{vmatrix} = 3\mathbf{i} - 3\mathbf{j} + 3\mathbf{k}$ is a vector in the direction of the line of intersection of the planes
 $\Rightarrow 3(x-2) + (-3)(y-1) + 3(z+1) = 0 \Rightarrow 3x - 3y + 3z = 0 \Rightarrow x - y + z = 0$ is the desired plane containing $P_0(2, 1, -1)$
32. A vector normal to the desired plane is $\overline{P_1P_2} \times \mathbf{n} = \begin{vmatrix} \mathbf{i} & \mathbf{j} & \mathbf{k} \\ 2 & 0 & -2 \\ 4 & -1 & 2 \end{vmatrix} = -2\mathbf{i} - 12\mathbf{j} - 2\mathbf{k}$; choosing $P_1(1, 2, 3)$ as a point on the plane $\Rightarrow (-2)(x-1) + (-12)(y-2) + (-2)(z-3) = 0 \Rightarrow -2x - 12y - 2z = -32 \Rightarrow x + 6y + z = 16$ is the desired plane

$$33. S(0, 0, 12), P(0, 0, 0) \text{ and } \mathbf{v} = 4\mathbf{i} - 2\mathbf{j} + 2\mathbf{k} \Rightarrow \overline{PS} \times \mathbf{v} = \begin{vmatrix} \mathbf{i} & \mathbf{j} & \mathbf{k} \\ 0 & 0 & 12 \\ 4 & -2 & 2 \end{vmatrix} = 24\mathbf{i} + 48\mathbf{j} = 24(\mathbf{i} + 2\mathbf{j})$$

$$\Rightarrow d = \frac{|\overline{PS} \times \mathbf{v}|}{|\mathbf{v}|} = \frac{24\sqrt{1+4}}{\sqrt{16+4+4}} = \frac{24\sqrt{5}}{\sqrt{24}} = \sqrt{5} \cdot 24 = 2\sqrt{30} \text{ is the distance from } S \text{ to the line}$$

$$34. S(0, 0, 0), P(5, 5, -3) \text{ and } \mathbf{v} = 3\mathbf{i} + 4\mathbf{j} - 5\mathbf{k} \Rightarrow \overline{PS} \times \mathbf{v} = \begin{vmatrix} \mathbf{i} & \mathbf{j} & \mathbf{k} \\ -5 & -5 & 3 \\ 3 & 4 & -5 \end{vmatrix} = 13\mathbf{i} - 16\mathbf{j} - 5\mathbf{k}$$

$$\Rightarrow d = \frac{|\overline{PS} \times \mathbf{v}|}{|\mathbf{v}|} = \frac{\sqrt{169+256+25}}{\sqrt{9+16+25}} = \frac{\sqrt{450}}{\sqrt{50}} = \sqrt{9} = 3 \text{ is the distance from } S \text{ to the line}$$

$$35. S(2, 1, 3), P(2, 1, 3) \text{ and } \mathbf{v} = 2\mathbf{i} + 6\mathbf{j} \Rightarrow \overline{PS} \times \mathbf{v} = \mathbf{0} \Rightarrow d = \frac{|\overline{PS} \times \mathbf{v}|}{|\mathbf{v}|} = \frac{0}{\sqrt{40}} = 0 \text{ is the distance from } S \text{ to the line}$$

(i.e., the point S lies on the line)

$$36. S(2, 1, -1), P(0, 1, 0) \text{ and } \mathbf{v} = 2\mathbf{i} + 2\mathbf{j} + 2\mathbf{k} \Rightarrow \overline{PS} \times \mathbf{v} = \begin{vmatrix} \mathbf{i} & \mathbf{j} & \mathbf{k} \\ 2 & 0 & -1 \\ 2 & 2 & 2 \end{vmatrix} = 2\mathbf{i} - 6\mathbf{j} + 4\mathbf{k}$$

$$\Rightarrow d = \frac{|\overline{PS} \times \mathbf{v}|}{|\mathbf{v}|} = \frac{\sqrt{4+36+16}}{\sqrt{4+4+4}} = \frac{\sqrt{56}}{\sqrt{12}} = \sqrt{\frac{14}{3}} \text{ is the distance from } S \text{ to the line}$$

$$37. S(3, -1, 4), P(4, 3, -5) \text{ and } \mathbf{v} = -\mathbf{i} + 2\mathbf{j} + 3\mathbf{k} \Rightarrow \overline{PS} \times \mathbf{v} = \begin{vmatrix} \mathbf{i} & \mathbf{j} & \mathbf{k} \\ -1 & -4 & 9 \\ -1 & 2 & 3 \end{vmatrix} = -30\mathbf{i} - 6\mathbf{j} - 6\mathbf{k}$$

$$\Rightarrow d = \frac{|\overline{PS} \times \mathbf{v}|}{|\mathbf{v}|} = \frac{\sqrt{900+36+36}}{\sqrt{1+4+9}} = \frac{\sqrt{972}}{\sqrt{14}} = \frac{\sqrt{486}}{\sqrt{7}} = \frac{\sqrt{81 \cdot 6}}{\sqrt{7}} = \frac{9\sqrt{42}}{7} \text{ is the distance from } S \text{ to the line}$$

$$38. S(-1, 4, 3), P(10, -3, 0) \text{ and } \mathbf{v} = 4\mathbf{i} + 4\mathbf{k} \Rightarrow \overline{PS} \times \mathbf{v} = \begin{vmatrix} \mathbf{i} & \mathbf{j} & \mathbf{k} \\ -11 & 7 & 3 \\ 4 & 0 & 4 \end{vmatrix} = 28\mathbf{i} + 56\mathbf{j} - 28\mathbf{k} = 28(\mathbf{i} + 2\mathbf{j} - \mathbf{k})$$

$$\Rightarrow d = \frac{|\overline{PS} \times \mathbf{v}|}{|\mathbf{v}|} = \frac{28\sqrt{1+4+1}}{4\sqrt{1+1}} = 7\sqrt{3} \text{ is the distance from } S \text{ to the line}$$

$$39. S(2, -3, 4), x + 2y + 2z = 13 \text{ and } P(13, 0, 0) \text{ is on the plane} \Rightarrow \overline{PS} = -11\mathbf{i} - 3\mathbf{j} + 4\mathbf{k} \text{ and } \mathbf{n} = \mathbf{i} + 2\mathbf{j} + 2\mathbf{k}$$

$$\Rightarrow d = \left| \overline{PS} \cdot \frac{\mathbf{n}}{|\mathbf{n}|} \right| = \left| \frac{-11-6+8}{\sqrt{1+4+4}} \right| = \left| \frac{-9}{\sqrt{9}} \right| = 3$$

$$40. S(0, 0, 0), 3x + 2y + 6z = 6 \text{ and } P(2, 0, 0) \text{ is on the plane} \Rightarrow \overline{PS} = -2\mathbf{i} \text{ and } \mathbf{n} = 3\mathbf{i} + 2\mathbf{j} + 6\mathbf{k}$$

$$\Rightarrow d = \left| \overline{PS} \cdot \frac{\mathbf{n}}{|\mathbf{n}|} \right| = \left| \frac{-6}{\sqrt{9+4+36}} \right| = \frac{6}{\sqrt{49}} = \frac{6}{7}$$

41. $S(0, 1, 1)$, $4y + 3z = -12$ and $P(0, -3, 0)$ is on the plane $\Rightarrow \overline{PS} = 4\mathbf{j} + \mathbf{k}$ and $\mathbf{n} = 4\mathbf{j} + 3\mathbf{k}$
 $\Rightarrow d = \left| \overline{PS} \cdot \frac{\mathbf{n}}{\|\mathbf{n}\|} \right| = \left| \frac{16+3}{\sqrt{16+9}} \right| = \frac{19}{5}$
42. $S(2, 2, 3)$, $2x + y + 2z = 4$ and $P(2, 0, 0)$ is on the plane $\Rightarrow \overline{PS} = 2\mathbf{j} + 3\mathbf{k}$ and $\mathbf{n} = 2\mathbf{i} + \mathbf{j} + 2\mathbf{k}$
 $\Rightarrow d = \left| \overline{PS} \cdot \frac{\mathbf{n}}{\|\mathbf{n}\|} \right| = \left| \frac{2+6}{\sqrt{4+1+4}} \right| = \frac{8}{3}$
43. $S(0, -1, 0)$, $2x + y + 2z = 4$ and $P(2, 0, 0)$ is on the plane $\Rightarrow \overline{PS} = -2\mathbf{i} - \mathbf{j}$ and $\mathbf{n} = 2\mathbf{i} + \mathbf{j} + 2\mathbf{k}$
 $\Rightarrow d = \left| \overline{PS} \cdot \frac{\mathbf{n}}{\|\mathbf{n}\|} \right| = \left| \frac{-4-1+0}{\sqrt{4+1+4}} \right| = \frac{5}{3}$
44. $S(1, 0, -1)$, $-4x + y + z = 4$ and $P(-1, 0, 0)$ is on the plane $\Rightarrow \overline{PS} = 2\mathbf{i} - \mathbf{k}$ and $\mathbf{n} = -4\mathbf{i} + \mathbf{j} + \mathbf{k}$
 $\Rightarrow d = \left| \overline{PS} \cdot \frac{\mathbf{n}}{\|\mathbf{n}\|} \right| = \left| \frac{-8-1}{\sqrt{16+1+1}} \right| = \frac{9}{\sqrt{18}} = \frac{3\sqrt{2}}{2}$
45. The point $P(1, 0, 0)$ is on the first plane and $S(10, 0, 0)$ is a point on the second plane $\Rightarrow \overline{PS} = 9\mathbf{i}$, and $\mathbf{n} = \mathbf{i} + 2\mathbf{j} + 6\mathbf{k}$ is normal to the first plane \Rightarrow the distance from S to the first plane is
 $d = \left| \overline{PS} \cdot \frac{\mathbf{n}}{\|\mathbf{n}\|} \right| = \left| \frac{9}{\sqrt{1+4+36}} \right| = \frac{9}{\sqrt{41}}$, which is also the distance between the planes.
46. The line is parallel to the plane since $\mathbf{v} \cdot \mathbf{n} = (\mathbf{i} + \mathbf{j} - \frac{1}{2}\mathbf{k}) \cdot (\mathbf{i} + 2\mathbf{j} + 6\mathbf{k}) = 1 + 2 - 3 = 0$. Also the point $S(1, 0, 0)$ when $t = -1$ lies on the line, and the point $P(10, 0, 0)$ lies on the plane $\Rightarrow \overline{PS} = -9\mathbf{i}$. The distance from S to the plane is $d = \left| \overline{PS} \cdot \frac{\mathbf{n}}{\|\mathbf{n}\|} \right| = \left| \frac{-9}{\sqrt{1+4+36}} \right| = \frac{9}{\sqrt{41}}$, which is also the distance from the line to the plane.
47. $\mathbf{n}_1 = \mathbf{i} + \mathbf{j}$ and $\mathbf{n}_2 = 2\mathbf{i} + \mathbf{j} - 2\mathbf{k} \Rightarrow \theta = \cos^{-1} \left(\frac{\mathbf{n}_1 \cdot \mathbf{n}_2}{\|\mathbf{n}_1\| \|\mathbf{n}_2\|} \right) = \cos^{-1} \left(\frac{2+1}{\sqrt{2}\sqrt{9}} \right) = \cos^{-1} \left(\frac{1}{\sqrt{2}} \right) = \frac{\pi}{4}$
48. $\mathbf{n}_1 = 5\mathbf{i} + \mathbf{j} - \mathbf{k}$ and $\mathbf{n}_2 = \mathbf{i} - 2\mathbf{j} + 3\mathbf{k} \Rightarrow \theta = \cos^{-1} \left(\frac{\mathbf{n}_1 \cdot \mathbf{n}_2}{\|\mathbf{n}_1\| \|\mathbf{n}_2\|} \right) = \cos^{-1} \left(\frac{5-2-3}{\sqrt{27}\sqrt{14}} \right) = \cos^{-1}(0) = \frac{\pi}{2}$
49. $\mathbf{n}_1 = 2\mathbf{i} + 2\mathbf{j} + 2\mathbf{k}$ and $\mathbf{n}_2 = 2\mathbf{i} - 2\mathbf{j} - \mathbf{k} \Rightarrow \theta = \cos^{-1} \left(\frac{\mathbf{n}_1 \cdot \mathbf{n}_2}{\|\mathbf{n}_1\| \|\mathbf{n}_2\|} \right) = \cos^{-1} \left(\frac{4-4-2}{\sqrt{12}\sqrt{9}} \right) = \cos^{-1} \left(\frac{-1}{3\sqrt{3}} \right) \approx 1.76 \text{ rad}$
50. $\mathbf{n}_1 = \mathbf{i} + \mathbf{j} + \mathbf{k}$ and $\mathbf{n}_2 = \mathbf{k} \Rightarrow \theta = \cos^{-1} \left(\frac{\mathbf{n}_1 \cdot \mathbf{n}_2}{\|\mathbf{n}_1\| \|\mathbf{n}_2\|} \right) = \cos^{-1} \left(\frac{-1}{\sqrt{3}\sqrt{1}} \right) \approx 0.96 \text{ rad}$
51. $\mathbf{n}_1 = 2\mathbf{i} + 2\mathbf{j} - \mathbf{k}$ and $\mathbf{n}_2 = \mathbf{i} + 2\mathbf{j} + \mathbf{k} \Rightarrow \theta = \cos^{-1} \left(\frac{\mathbf{n}_1 \cdot \mathbf{n}_2}{\|\mathbf{n}_1\| \|\mathbf{n}_2\|} \right) = \cos^{-1} \left(\frac{2+4-1}{\sqrt{9}\sqrt{6}} \right) = \cos^{-1} \left(\frac{5}{3\sqrt{6}} \right) \approx 0.82 \text{ rad}$
52. $\mathbf{n}_1 = 4\mathbf{j} + 3\mathbf{k}$ and $\mathbf{n}_2 = 3\mathbf{i} + 2\mathbf{j} + 6\mathbf{k} \Rightarrow \theta = \cos^{-1} \left(\frac{\mathbf{n}_1 \cdot \mathbf{n}_2}{\|\mathbf{n}_1\| \|\mathbf{n}_2\|} \right) = \cos^{-1} \left(\frac{8+18}{\sqrt{25}\sqrt{49}} \right) = \cos^{-1} \left(\frac{26}{35} \right) \approx 0.73 \text{ rad}$

53. $2x - y + 3z = 6 \Rightarrow 2(1-t) - (3t) + 3(1+t) = 6 \Rightarrow -2t + 5 = 6 \Rightarrow t = -\frac{1}{2} \Rightarrow x = \frac{3}{2}, y = -\frac{3}{2}$ and $z = \frac{1}{2}$
 $\Rightarrow \left(\frac{3}{2}, -\frac{3}{2}, \frac{1}{2}\right)$ is the point

54. $6x + 3y - 4z = -12 \Rightarrow 6(2) + 3(3+2t) - 4(-2-2t) = -12 \Rightarrow 14t + 29 = -12 \Rightarrow t = -\frac{41}{14} \Rightarrow x = 2, y = 3 - \frac{41}{7}$, and
 $z = -2 + \frac{41}{7} \Rightarrow \left(2, -\frac{20}{7}, \frac{27}{7}\right)$ is the point

55. $x + y + z = 2 \Rightarrow (1+2t) + (1+5t) + (3t) = 2 \Rightarrow 10t + 2 = 2 \Rightarrow t = 0 \Rightarrow x = 1, y = 1$ and $z = 0 \Rightarrow (1, 1, 0)$ is the point

56. $2x - 3z = 7 \Rightarrow 2(-1+3t) - 3(5t) = 7 \Rightarrow -9t - 2 = 7 \Rightarrow t = -1 \Rightarrow x = -1-3, y = -2$ and $z = -5 \Rightarrow (-4, -2, -5)$ is the point

57. $\mathbf{n}_1 = \mathbf{i} + \mathbf{j} + \mathbf{k}$ and $\mathbf{n}_2 = \mathbf{i} + \mathbf{j} \Rightarrow \mathbf{n}_1 \times \mathbf{n}_2 = \begin{vmatrix} \mathbf{i} & \mathbf{j} & \mathbf{k} \\ 1 & 1 & 1 \\ 1 & 1 & 0 \end{vmatrix} = -\mathbf{i} + \mathbf{j}$, the direction of the desired line;

$(1, 1, -1)$ is on both planes \Rightarrow the desired line is $x = 1-t, y = 1+t, z = -1$

58. $\mathbf{n}_1 = 3\mathbf{i} - 6\mathbf{j} - 2\mathbf{k}$ and $\mathbf{n}_2 = 2\mathbf{i} + \mathbf{j} - 2\mathbf{k} \Rightarrow \mathbf{n}_1 \times \mathbf{n}_2 = \begin{vmatrix} \mathbf{i} & \mathbf{j} & \mathbf{k} \\ 3 & -6 & -2 \\ 2 & 1 & -2 \end{vmatrix} = 14\mathbf{i} + 2\mathbf{j} + 15\mathbf{k}$, the direction of the desired

line; $(1, 0, 0)$ is on both planes \Rightarrow the desired line is $x = 1+14t, y = 2t, z = 15t$

59. $\mathbf{n}_1 = \mathbf{i} - 2\mathbf{j} + 4\mathbf{k}$ and $\mathbf{n}_2 = \mathbf{i} + \mathbf{j} - 2\mathbf{k} \Rightarrow \mathbf{n}_1 \times \mathbf{n}_2 = \begin{vmatrix} \mathbf{i} & \mathbf{j} & \mathbf{k} \\ 1 & -2 & 4 \\ 1 & 1 & -2 \end{vmatrix} = 6\mathbf{j} + 3\mathbf{k}$, the direction of the desired line;

$(4, 3, 1)$ is on both planes \Rightarrow the desired line is $x = 4, y = 3+6t, z = 1+3t$

60. $\mathbf{n}_1 = 5\mathbf{i} - 2\mathbf{j}$ and $\mathbf{n}_2 = 4\mathbf{j} - 5\mathbf{k} \Rightarrow \mathbf{n}_1 \times \mathbf{n}_2 = \begin{vmatrix} \mathbf{i} & \mathbf{j} & \mathbf{k} \\ 5 & -2 & 0 \\ 0 & 4 & -5 \end{vmatrix} = 10\mathbf{i} + 25\mathbf{j} + 20\mathbf{k}$, the direction of the desired line;

$(1, -3, 1)$ is on both planes \Rightarrow the desired line is $x = 1+10t, y = -3+25t, z = 1+20t$

61. L1 & L2: $\begin{cases} x = 3+2t = 1+4s \\ y = -1+4t = 1+2s \end{cases} \Rightarrow \begin{cases} 2t-4s = -2 \\ 4t-2s = 2 \end{cases} \Rightarrow \begin{cases} 2t-4s = -2 \\ 2t-s = 1 \end{cases} \Rightarrow -3s = -3 \Rightarrow s = 1$ and $t = 1$
 \Rightarrow on $L1, z = 1$ and on $L2, z = 1 \Rightarrow L1$ and $L2$ intersect at $(5, 3, 1)$.

L2 & L3: The direction of $L2$ is $\frac{1}{6}(4\mathbf{i} + 2\mathbf{j} + 4\mathbf{k}) = \frac{1}{3}(2\mathbf{i} + \mathbf{j} + 2\mathbf{k})$ which is the same as the direction $\frac{1}{3}(2\mathbf{i} + \mathbf{j} + 2\mathbf{k})$ of $L3$; hence $L2$ and $L3$ are parallel.

$$\underline{L1 \& L3}: \begin{cases} x = 3 + 2t = 3 + 2r \\ y = -1 + 4t = 2 + r \end{cases} \Rightarrow \begin{cases} 2t - 2r = 0 \\ 4t - r = 3 \end{cases} \Rightarrow \begin{cases} t - r = 0 \\ 4t - r = 3 \end{cases} \Rightarrow 3t = 3 \Rightarrow t = 1 \text{ and } r = 1 \Rightarrow \text{on } L1, z = 2$$

while on $L3$, $z = 0 \Rightarrow L1$ and $L2$ do not intersect. The direction of $L1$ is $\frac{1}{\sqrt{21}}(2\mathbf{i} + 4\mathbf{j} - \mathbf{k})$ while the direction of $L3$ is $\frac{1}{3}(2\mathbf{i} + \mathbf{j} + 2\mathbf{k})$ and neither is a multiple of the other; hence $L1$ and $L3$ are skew.

$$62. \underline{L1 \& L2}: \begin{cases} x = 1 + 2t = 2 - s \\ y = -1 - t = 3s \end{cases} \Rightarrow \begin{cases} 2t + s = 1 \\ -t - 3s = 1 \end{cases} \Rightarrow -5s = 3 \Rightarrow s = -\frac{3}{5} \text{ and } t = \frac{4}{5} \Rightarrow \text{on } L1, z = \frac{12}{5} \text{ while on } L2, z = 1 - \frac{3}{5} = \frac{2}{5} \Rightarrow L1 \text{ and } L2 \text{ do not intersect. The direction of } L1 \text{ is } \frac{1}{\sqrt{14}}(2\mathbf{i} - \mathbf{j} + 3\mathbf{k}) \text{ while the direction of } L2 \text{ is } \frac{1}{\sqrt{11}}(-\mathbf{i} + 3\mathbf{j} + \mathbf{k}) \text{ and neither is a multiple of the other; hence, } L1 \text{ and } L2 \text{ are skew.}$$

$$\underline{L2 \& L3}: \begin{cases} x = 2 - s = 5 + 2r \\ y = 3s = 1 - r \end{cases} \Rightarrow \begin{cases} -s - 2r = 3 \\ 3s + r = 1 \end{cases} \Rightarrow 5s = 5 \Rightarrow s = 1 \text{ and } r = -2 \Rightarrow \text{on } L2, z = 2 \text{ and on } L3, z = 2 \Rightarrow L2 \text{ and } L3 \text{ intersect at } (1, 3, 2).$$

$\underline{L1 \& L3}$: $L1$ and $L3$ have the same direction $\frac{1}{\sqrt{14}}(2\mathbf{i} - \mathbf{j} + 3\mathbf{k})$; hence $L1$ and $L3$ are parallel.

$$63. x = 2 + 2t, y = -4 - t, z = 7 + 3t; x = -2 - t, y = -2 + \frac{1}{2}t, z = 1 - \frac{3}{2}t$$

$$64. 1(x - 4) - 2(y - 1) + 1(z - 5) = 0 \Rightarrow x - 4 - 2y + 2 + z - 5 = 0 \Rightarrow x - 2y + z = 7; \\ -\sqrt{2}(x - 3) + 2\sqrt{2}(y + 2) - \sqrt{2}(z - 0) = 0 \Rightarrow -\sqrt{2}x + 2\sqrt{2}y - \sqrt{2}z = -7\sqrt{2}$$

$$65. x = 0 \Rightarrow t = -\frac{1}{2}, y = -\frac{1}{2}, z = -\frac{3}{2} \Rightarrow (0, -\frac{1}{2}, -\frac{3}{2}); y = 0 \Rightarrow t = -1, x = -1, z = -3 \Rightarrow (-1, 0, -3); \\ z = 0 \Rightarrow t = 0, x = 1, y = -1 \Rightarrow (1, -1, 0)$$

66. The line contains $(0, 0, 3)$ and $(\sqrt{3}, 1, 3)$ because the projection of the line onto the xy -plane contains the origin and intersects the positive x -axis at a 30° angle. The direction of the line is $\sqrt{3}\mathbf{i} + \mathbf{j} + 0\mathbf{k} \Rightarrow$ the line in question is $x = \sqrt{3}t, y = t, z = 3$.

$$67. \text{With substitution of the line into the plane we have } 2(1 - 2t) + (2 + 5t) - (-3t) = 8 \Rightarrow 2 - 4t + 2 + 5t + 3t = 8 \\ \Rightarrow 4t + 4 = 8 \Rightarrow t = 1 \Rightarrow \text{the point } (-1, 7, -3) \text{ is contained in both the line and plane, so they are not parallel.}$$

68. The planes are parallel when either vector $A_1\mathbf{i} + B_1\mathbf{j} + C_1\mathbf{k}$ or $A_2\mathbf{i} + B_2\mathbf{j} + C_2\mathbf{k}$ is a multiple of the other or when $(A_1\mathbf{i} + B_1\mathbf{j} + C_1\mathbf{k}) \times (A_2\mathbf{i} + B_2\mathbf{j} + C_2\mathbf{k}) = \mathbf{0}$. The planes are perpendicular when their normals are perpendicular, or $(A_1\mathbf{i} + B_1\mathbf{j} + C_1\mathbf{k}) \cdot (A_2\mathbf{i} + B_2\mathbf{j} + C_2\mathbf{k}) = 0$.

$$69. \text{There are many possible answers. One is found as follows: eliminate } t \text{ to get } t = x - 1 = 2 - y = \frac{z - 3}{2} \\ \Rightarrow x - 1 = 2 - y \text{ and } 2 - y = \frac{z - 3}{2} \Rightarrow x + y = 3 \text{ and } 2y + z = 7 \text{ are two such planes.}$$

70. Since the plane passes through the origin, its general equation is of the form $Ax + By + Cz = 0$. Since it meets the plane M at a right angle, their normal vectors are perpendicular $\Rightarrow 2A + 3B + C = 0$. One choice satisfying this equation is $A = 1, B = -1$ and $C = 1 \Rightarrow x - y + z = 0$. Any plane $Ax + By + Cz = 0$ with $2A + 3B + C = 0$ will pass through the origin and be perpendicular to M .
71. The points $(a, 0, 0)$, $(0, b, 0)$ and $(0, 0, c)$ are the x, y , and z intercepts of the plane. Since a, b , and c are all nonzero, the plane must intersect all three coordinate axes and cannot pass through the origin. Thus, $\frac{x}{a} + \frac{y}{b} + \frac{z}{c} = 1$ describes all planes except those through the origin or parallel to a coordinate axis.
72. Yes. If \mathbf{v}_1 and \mathbf{v}_2 are nonzero vectors parallel to the lines, then $\mathbf{v}_1 \times \mathbf{v}_2 \neq \mathbf{0}$ is perpendicular to the lines.
73. (a) $\overline{EP} = c\overline{EP}_1 \Rightarrow -x_0\mathbf{i} + y\mathbf{j} + z\mathbf{k} = c[(x_1 - x_0)\mathbf{i} + y_1\mathbf{j} + z_1\mathbf{k}] \Rightarrow -x_0 = c(x_1 - x_0), y = cy_1$ and $z = cz_1$, where c is a positive real number
- (b) At $x_1 = 0 \Rightarrow c = 1 \Rightarrow y = y_1$ and $z = z_1$; at $x_1 = x_0 \Rightarrow x_0 = 0, y = 0, z = 0$; $\lim_{x_0 \rightarrow \infty} c = \lim_{x_0 \rightarrow \infty} \frac{-x_0}{x_1 - x_0}$
 $= \lim_{x_0 \rightarrow \infty} \frac{-1}{-1} = 1 \Rightarrow c \rightarrow 1$ so that $y \rightarrow y_1$ and $z \rightarrow z_1$
74. The plane which contains the triangular plane is $x + y + z = 2$. The line containing the endpoints of the line segment is $x = 1 - t, y = 2t, z = 2t$. The plane and the line intersect at $(\frac{2}{3}, \frac{2}{3}, \frac{2}{3})$. The visible section of the line segment is $\sqrt{(\frac{1}{3})^2 + (\frac{2}{3})^2 + (\frac{2}{3})^2} = 1$ unit in length. The length of the line segment is $\sqrt{1^2 + 2^2 + 2^2} = 3 \Rightarrow \frac{2}{3}$ of the line segment is hidden from view.

12.6 CYLINDERS AND QUADRIC SURFACES

- | | | |
|----------------------|--------------------------------|--------------------------------|
| 1. d , ellipsoid | 2. i , hyperboloid | 3. a , cylinder |
| 4. g , cone | 5. l , hyperbolic paraboloid | 6. e , paraboloid |
| 7. b , cylinder | 8. j , hyperboloid | 9. k , hyperbolic paraboloid |
| 10. f , paraboloid | 11. h , cone | 12. c , ellipsoid |
| 13. $x^2 + y^2 = 4$ | 14. $z = y^2 - 1$ | 15. $x^2 + 4z^2 = 16$ |

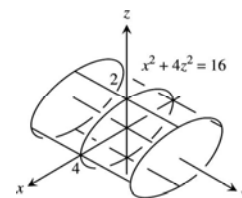
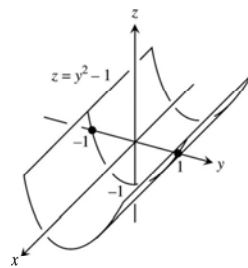
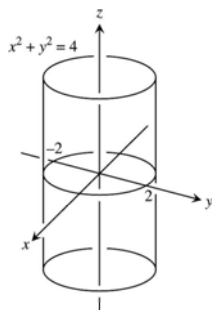

16. $4x^2 + y^2 = 36$

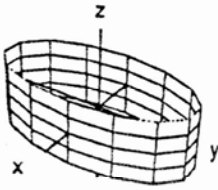

17. $9x^2 + y^2 + z^2 = 9$

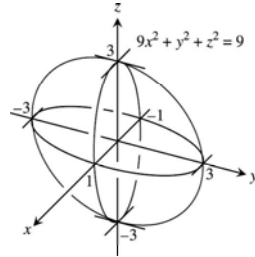

18. $4x^2 + 4y^2 + z^2 = 16$

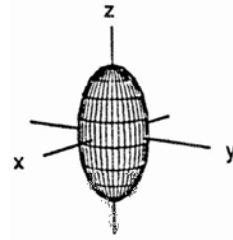

19. $4x^2 + 9y^2 + 4z^2 = 36$

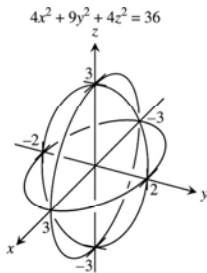

20. $9x^2 + 4y^2 + 36z^2 = 36$

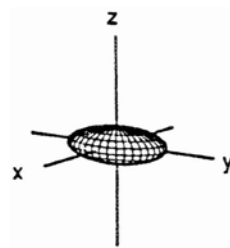

21. $x^2 + 4y^2 = z$

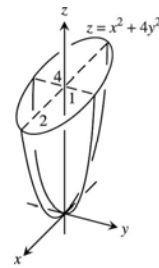

22. $z = 8 - x^2 - y^2$

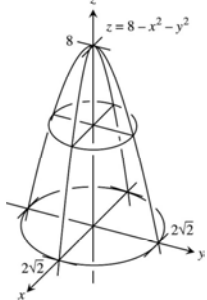

23. $x = 4 - 4y^2 - z^2$

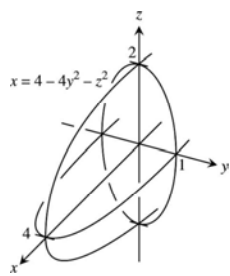

24. $y = 1 - x^2 - z^2$

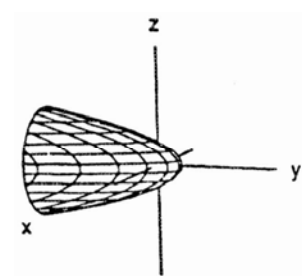

25. $x^2 + y^2 = z^2$

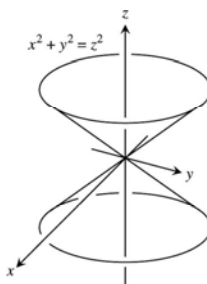

26. $4x^2 + 9z^2 = 9y^2$

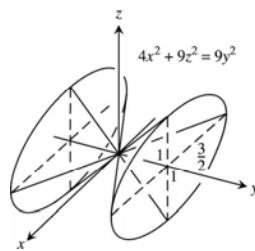

27. $x^2 + y^2 - z^2 = 1$

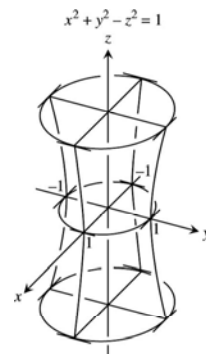

28. $y^2 + z^2 - x^2 = 1$

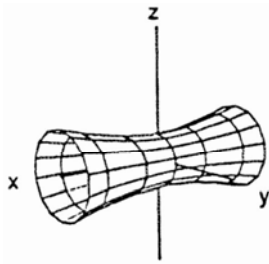

29. $z^2 - x^2 - y^2 = 1$

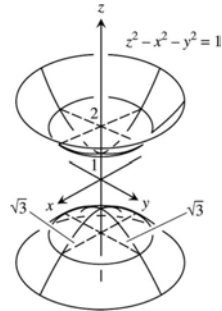

30. $\frac{y^2}{4} - \frac{x^2}{4} - z^2 = 1$

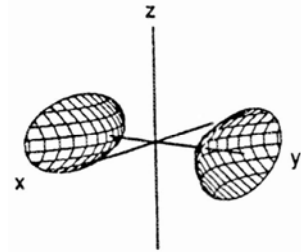

31. $y^2 - x^2 = z$

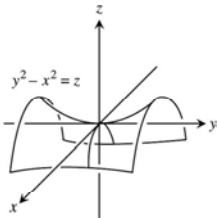

32. $x^2 - y^2 = z$

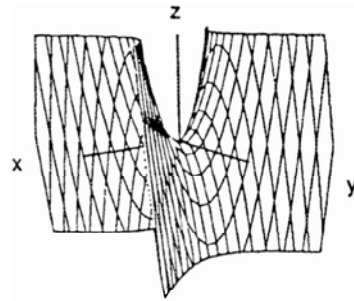

33. $z = 1 + y^2 - x^2$

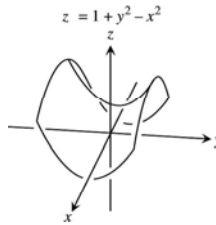

34. $4x^2 + 4y^2 = z^2$

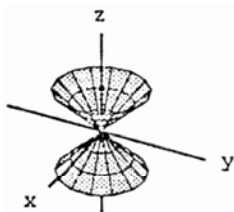

35. $y = -(x^2 + z^2)$

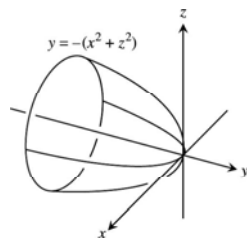

36. $16x^2 + 4y^2 = 1$

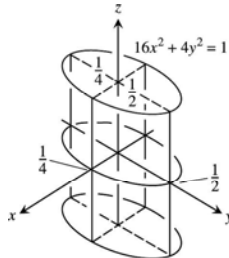

37. $x^2 + y^2 - z^2 = 4$

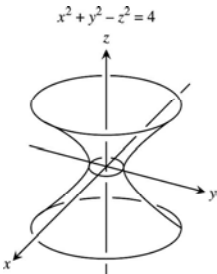

38. $x^2 + z^2 = y$

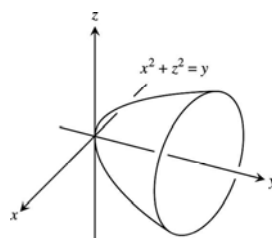

39. $x^2 + z^2 = 1$

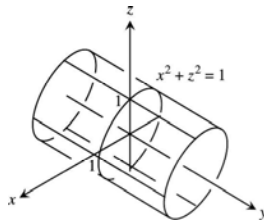

40. $16y^2 + 9z^2 = 4x^2$

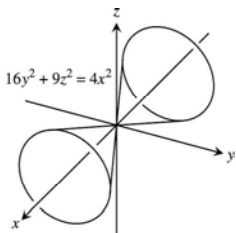

41. $z = -(x^2 + y^2)$

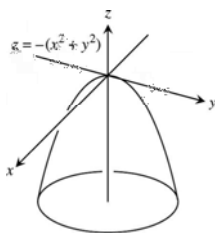

42. $y^2 - x^2 - z^2 = 1$

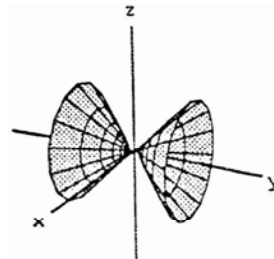

43. $4y^2 + z^2 - 4x^2 = 4$

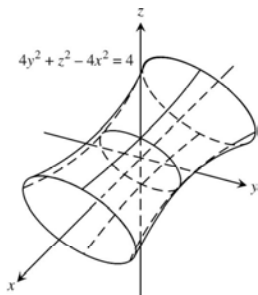

44. $x^2 + y^2 = z$

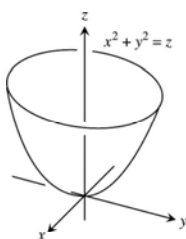

45. (a) If $x^2 + \frac{y^2}{4} + \frac{z^2}{9} = 1$ and $z = c$, then $x^2 + \frac{y^2}{4} = \frac{9-c^2}{9} \Rightarrow \frac{x^2}{\left(\frac{9-c^2}{9}\right)} + \frac{y^2}{\left[\frac{4(9-c^2)}{9}\right]} = 1 \Rightarrow A = ab\pi$

$$= \pi \left(\frac{\sqrt{9-c^2}}{3} \right) \left(\frac{2\sqrt{9-c^2}}{3} \right) = \frac{2\pi(9-c^2)}{9}$$

(b) From part (a), each slice has the area $\frac{2\pi(9-z^2)}{9}$, where $-3 \leq z \leq 3$. Thus $V = 2 \int_0^3 \frac{2\pi}{9} (9-z^2) dz$

$$= \frac{4\pi}{9} \int_0^3 (9-z^2) dz = \frac{4\pi}{9} \left[9z - \frac{z^3}{3} \right]_0^3 = \frac{4\pi}{9} (27-9) = 8\pi$$

(c) $\frac{x^2}{a^2} + \frac{y^2}{b^2} + \frac{z^2}{c^2} = 1 \Rightarrow \frac{x^2}{\left[\frac{a^2(c^2-z^2)}{c^2}\right]} + \frac{y^2}{\left[\frac{b^2(c^2-z^2)}{c^2}\right]} = 1 \Rightarrow A = \pi \left(\frac{a\sqrt{c^2-z^2}}{c} \right) \left(\frac{b\sqrt{c^2-z^2}}{c} \right)$

$$\Rightarrow V = 2 \int_0^c \frac{\pi ab}{c^2} (c^2 - z^2) dz = \frac{2\pi ab}{c^2} \left[c^2 z - \frac{z^3}{3} \right]_0^c = \frac{2\pi ab}{c^2} \left(\frac{2}{3} c^3 \right) = \frac{4\pi abc}{3}. \text{ Note that if } r = a = b = c,$$

then $V = \frac{4\pi r^3}{3}$, which is the volume of a sphere.

46. The ellipsoid has the form $\frac{x^2}{R^2} + \frac{y^2}{R^2} + \frac{z^2}{c^2} = 1$. To determine c^2 we note that the point $(0, r, h)$ lies on the surface of the barrel. Thus, $\frac{r^2}{R^2} + \frac{h^2}{c^2} = 1 \Rightarrow c^2 = \frac{h^2 R^2}{R^2 - r^2}$. We calculate the volume by the disk method:

$$V = \pi \int_{-h}^h y^2 dz. \text{ Now, } \frac{y^2}{R^2} + \frac{z^2}{c^2} = 1 \Rightarrow y^2 = R^2 \left(1 - \frac{z^2}{c^2} \right) = R^2 \left[1 - \frac{z^2(R^2 - r^2)}{h^2 R^2} \right] = R^2 - \left(\frac{R^2 - r^2}{h^2} \right) z^2$$

$$\Rightarrow V = \pi \int_{-h}^h \left[R^2 - \left(\frac{R^2 - r^2}{h^2} \right) z^2 \right] dz = \pi \left[R^2 z - \frac{1}{3} \left(\frac{R^2 - r^2}{h^2} \right) z^3 \right]_{-h}^h = 2\pi \left[R^2 h - \frac{1}{3} (R^2 - r^2) h \right] = 2\pi \left(\frac{2R^2 h}{3} + \frac{r^2 h}{3} \right)$$

$= \frac{4}{3}\pi R^2 h + \frac{2}{3}\pi r^2 h$, the volume of the barrel. If $r = R$, then $V = 2\pi R^2 h$ which is the volume of a cylinder of radius R and height $2h$. If $r = 0$ and $h = R$, then $V = \frac{4}{3}\pi R^3$ which is the volume of a sphere.

47. We calculate the volume by the slicing method, taking slices parallel to the xy -plane. For fixed z , $\frac{x^2}{a^2} + \frac{y^2}{b^2} = \frac{z}{c}$ gives the ellipse $\frac{x^2}{\left(\frac{za^2}{c}\right)} + \frac{y^2}{\left(\frac{zb^2}{c}\right)} = 1$. The area of this ellipse is $\pi\left(a\sqrt{\frac{z}{c}}\right)\left(b\sqrt{\frac{z}{c}}\right) = \frac{\pi abz}{c}$ (see Exercise 45a). Hence

the volume is given by $V = \int_0^h \frac{\pi abz}{c} dz = \left[\frac{\pi abz^2}{2c}\right]_0^h = \frac{\pi abh^2}{c}$. Now the area of the elliptic base when $z = h$ is

$A = \frac{\pi abh}{c}$, as determined previously. Thus, $V = \frac{\pi abh^2}{c} = \frac{1}{2}\left(\frac{\pi abh}{c}\right)h = \frac{1}{2}$ (base)(altitude), as claimed.

48. (a) For each fixed value of z , the hyperboloid $\frac{x^2}{a^2} + \frac{y^2}{b^2} - \frac{z^2}{c^2} = 1$ results in a cross-sectional ellipse

$\left[\frac{x^2}{\frac{a^2(c^2+z^2)}{c^2}}\right] + \left[\frac{y^2}{\frac{b^2(c^2+z^2)}{c^2}}\right] = 1$. The area of the cross-sectional ellipse (see Exercise 45a) is

$A(z) = \pi\left(\frac{a}{c}\sqrt{c^2+z^2}\right)\left(\frac{b}{c}\sqrt{c^2+z^2}\right) = \frac{\pi ab}{c^2}(c^2+z^2)$. The volume of the solid by the method of slices is

$$V = \int_0^h A(z) dz = \int_0^h \frac{\pi ab}{c^2}(c^2+z^2) dz = \frac{\pi ab}{c^2}\left[c^2z + \frac{1}{3}z^3\right]_0^h = \frac{\pi ab}{c^2}\left(c^2h + \frac{1}{3}h^3\right) = \frac{\pi abh}{3c^2}(3c^2+h^2)$$

(b) $A_0 = A(0) = \pi ab$ and $A_h = A(h) = \frac{\pi ab}{c^2}(c^2+h^2)$, from part (a) $\Rightarrow V = \frac{\pi abh}{3c^2}(3c^2+h^2)$
 $= \frac{\pi abh}{3}\left(2+1+\frac{h^2}{c^2}\right) = \frac{\pi abh}{3}\left(2+\frac{c^2+h^2}{c^2}\right) = \frac{h}{3}\left[2\pi ab + \frac{\pi ab}{c^2}(c^2+h^2)\right] = \frac{h}{3}(2A_0 + A_h)$

(c) $A_m = A\left(\frac{h}{2}\right) = \frac{\pi ab}{c^2}\left(c^2 + \frac{h^2}{4}\right) = \frac{\pi ab}{4c^2}(4c^2+h^2) \Rightarrow \frac{h}{6}(A_0 + 4A_m + A_h)$
 $= \frac{h}{6}\left[\pi ab + \frac{\pi ab}{c^2}(4c^2+h^2) + \frac{\pi ab}{c^2}(c^2+h^2)\right] = \frac{\pi abh}{6c^2}(c^2+4c^2+h^2+c^2+h^2) = \frac{\pi abh}{6c^2}(6c^2+2h^2)$
 $= \frac{\pi abh}{3c^2}(3c^2+h^2) = V$ from part (a)

49. $z = y^2$

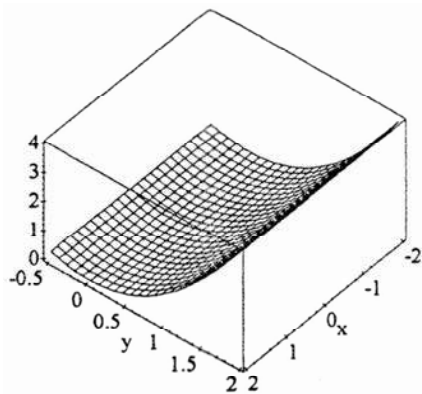

50. $z = 1 - y^2$

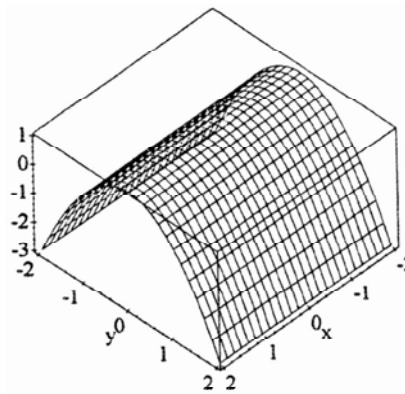

51. $z = x^2 + y^2$

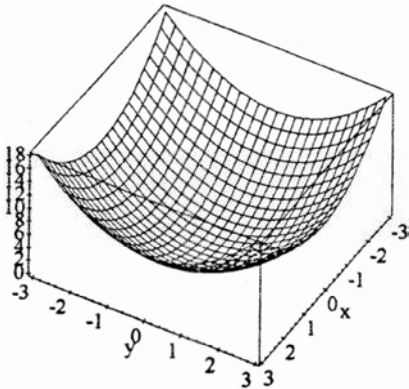

52. $z = x^2 + 2y^2$

(a)

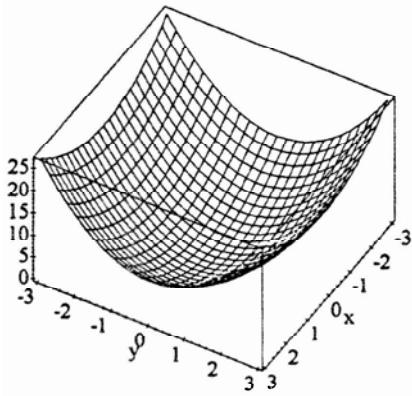

(b)

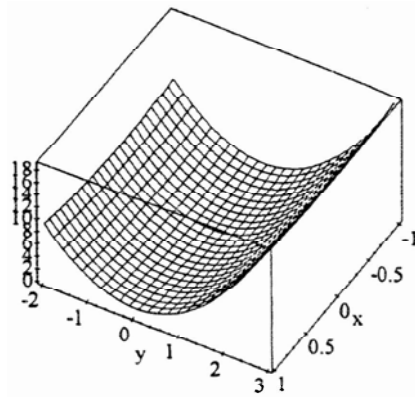

(c)

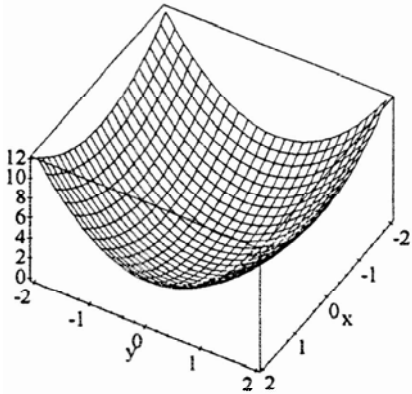

(d)

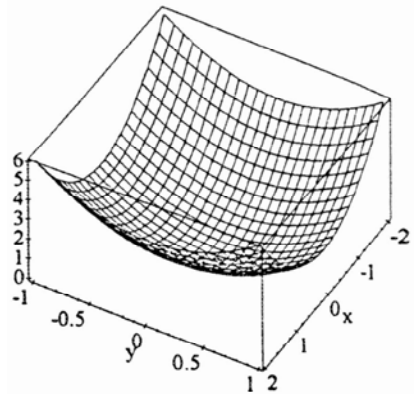

53-58. Example CAS commands:

Maple:

```
with( plots );
eq := x^2/9 + y^2/36 = 1 - z^2/25;
implicitplot3d( eq, x=-3..3, y=-6..6, z=-5..5, scaling=constrained,
                shading=zhue, axes=boxed, title="#53 (Section 12.6)");
```

Mathematica: (functions and domains may vary):

In the following chapter, you will consider contours or level curves for surfaces in three dimensions. For the purposes of plotting the functions of two variables expressed implicitly in this section, we will call upon the function **ContourPlot3D**. To insert the stated function, write all terms on the same side of the equal sign and the default contour equating that expression to zero will be plotted.

This built-in function requires the loading of a special graphics package.

```
<<Graphics`ContourPlot3D`
Clear[x, y, z]
ContourPlot3D[x^2/9 - y^2/16 - z^2/2 - 1, {x, -9, 9}, {y, -12, 12}, {z, -5, 5},
              Axes -> True, AxesLabel -> {x, y, z}, Boxed -> False,
              PlotLabel -> "Elliptic Hyperboloid of Two Sheets"]
```

Your identification of the plot may or may not be able to be done without considering the graph.

CHAPTER 12 PRACTICE EXERCISES

1. (a) $3\langle -3, 4 \rangle - 4\langle 2, -5 \rangle = \langle -9 - 8, 12 + 20 \rangle = \langle -17, 32 \rangle$
 (b) $\sqrt{17^2 + 32^2} = \sqrt{1313}$
2. (a) $\langle -3 + 2, 4 - 5 \rangle = \langle -1, -1 \rangle$
 (b) $\sqrt{(-1)^2 + (-1)^2} = \sqrt{2}$
3. (a) $\langle -2(-3), -2(4) \rangle = \langle 6, -8 \rangle$
 (b) $\sqrt{6^2 + (-8)^2} = 10$
4. (a) $\langle 5(2), 5(-5) \rangle = \langle 10, -25 \rangle$
 (b) $\sqrt{10^2 + (-25)^2} = \sqrt{725} = 5\sqrt{29}$
5. $\frac{\pi}{6}$ radians below the negative x -axis: $\left\langle -\frac{\sqrt{3}}{2}, -\frac{1}{2} \right\rangle$ [assuming counterclockwise].
6. $\left\langle \frac{\sqrt{3}}{2}, \frac{1}{2} \right\rangle$
7. $2\left(\frac{1}{\sqrt{4^2+1^2}}\right)(4\mathbf{i} - \mathbf{j}) = \left(\frac{8}{\sqrt{17}}\mathbf{i} - \frac{2}{\sqrt{17}}\mathbf{j}\right)$
8. $-5\left(\frac{1}{\sqrt{\left(\frac{3}{5}\right)^2 + \left(\frac{4}{5}\right)^2}}\right)\left(\frac{3}{5}\mathbf{i} + \frac{4}{5}\mathbf{j}\right) = -3\mathbf{i} - 4\mathbf{j}$
9. $\text{length} = \left|\sqrt{2}\mathbf{i} + \sqrt{2}\mathbf{j}\right| = \sqrt{2+2} = 2, \sqrt{2}\mathbf{i} + \sqrt{2}\mathbf{j} = 2\left(\frac{1}{\sqrt{2}}\mathbf{i} + \frac{1}{\sqrt{2}}\mathbf{j}\right) \Rightarrow$ the direction is $\frac{1}{\sqrt{2}}\mathbf{i} + \frac{1}{\sqrt{2}}\mathbf{j}$

10. $\text{length} = |-\mathbf{i} - \mathbf{j}| = \sqrt{1+1} = \sqrt{2}$, $-\mathbf{i} - \mathbf{j} = \sqrt{2}\left(-\frac{1}{\sqrt{2}}\mathbf{i} - \frac{1}{\sqrt{2}}\mathbf{j}\right) \Rightarrow$ the direction is $-\frac{1}{\sqrt{2}}\mathbf{i} - \frac{1}{\sqrt{2}}\mathbf{j}$
11. $t = \frac{\pi}{2} \Rightarrow \mathbf{v} = \left(-2 \sin \frac{\pi}{2}\right)\mathbf{i} + \left(2 \cos \frac{\pi}{2}\right)\mathbf{j} = -2\mathbf{i}$; $\text{length} = |-2\mathbf{i}| = \sqrt{4+0} = 2$; $-2\mathbf{i} = 2(-\mathbf{i}) \Rightarrow$ the direction is $-\mathbf{i}$
12. $t = \ln 2 \Rightarrow \mathbf{v} = \left(e^{\ln 2} \cos(\ln 2) - e^{\ln 2} \sin(\ln 2)\right)\mathbf{i} + \left(e^{\ln 2} \sin(\ln 2) + e^{\ln 2} \cos(\ln 2)\right)\mathbf{j}$
 $= (2\cos(\ln 2) - 2\sin(\ln 2))\mathbf{i} + (2\sin(\ln 2) + 2\cos(\ln 2))\mathbf{j} = 2[(\cos(\ln 2) - \sin(\ln 2))\mathbf{i} + (\sin(\ln 2) + \cos(\ln 2))\mathbf{j}]$
 $\text{length} = 2\sqrt{(\cos(\ln 2) - \sin(\ln 2))^2 + (\sin(\ln 2) + \cos(\ln 2))^2}$
 $= 2\sqrt{2\cos^2(\ln 2) + 2\sin^2(\ln 2)} = 2\sqrt{2}$; $2[(\cos(\ln 2) - \sin(\ln 2))\mathbf{i} + (\sin(\ln 2) + \cos(\ln 2))\mathbf{j}]$
 $= 2\sqrt{2}\left(\frac{(\cos(\ln 2) - \sin(\ln 2))\mathbf{i} + (\sin(\ln 2) + \cos(\ln 2))\mathbf{j}}{\sqrt{2}}\right) \Rightarrow$ direction $\frac{(\cos(\ln 2) - \sin(\ln 2))}{\sqrt{2}}\mathbf{i} + \frac{(\sin(\ln 2) + \cos(\ln 2))}{\sqrt{2}}\mathbf{j}$
13. $\text{length} = |2\mathbf{i} - 3\mathbf{j} + 6\mathbf{k}| = \sqrt{4+9+36} = 7$, $2\mathbf{i} - 3\mathbf{j} + 6\mathbf{k} = 7\left(\frac{2}{7}\mathbf{i} - \frac{3}{7}\mathbf{j} + \frac{6}{7}\mathbf{k}\right) \Rightarrow$ the direction is $\frac{2}{7}\mathbf{i} - \frac{3}{7}\mathbf{j} + \frac{6}{7}\mathbf{k}$
14. $\text{length} = |\mathbf{i} + 2\mathbf{j} - \mathbf{k}| = \sqrt{1+4+1} = \sqrt{6}$, $\mathbf{i} + 2\mathbf{j} - \mathbf{k} = \sqrt{6}\left(\frac{1}{\sqrt{6}}\mathbf{i} + \frac{2}{\sqrt{6}}\mathbf{j} - \frac{1}{\sqrt{6}}\mathbf{k}\right) \Rightarrow$ the direction is $\frac{1}{\sqrt{6}}\mathbf{i} + \frac{2}{\sqrt{6}}\mathbf{j} - \frac{1}{\sqrt{6}}\mathbf{k}$
15. $2\frac{\mathbf{v}}{|\mathbf{v}|} = 2 \cdot \frac{4\mathbf{i} - \mathbf{j} + 4\mathbf{k}}{\sqrt{4^2 + (-1)^2 + 4^2}} = 2 \cdot \frac{4\mathbf{i} - \mathbf{j} + 4\mathbf{k}}{\sqrt{33}} = \frac{8}{\sqrt{33}}\mathbf{i} - \frac{2}{\sqrt{33}}\mathbf{j} + \frac{8}{\sqrt{33}}\mathbf{k}$
16. $-5\frac{\mathbf{v}}{|\mathbf{v}|} = -5 \cdot \frac{\left(\frac{3}{5}\right)\mathbf{i} + \left(\frac{4}{5}\right)\mathbf{k}}{\sqrt{\left(\frac{3}{5}\right)^2 + \left(\frac{4}{5}\right)^2}} = -5 \cdot \frac{\left(\frac{3}{5}\right)\mathbf{i} + \left(\frac{4}{5}\right)\mathbf{k}}{\sqrt{\frac{9}{25} + \frac{16}{25}}} = -3\mathbf{i} - 4\mathbf{k}$
17. $|\mathbf{v}| = \sqrt{1+1} = \sqrt{2}$, $|\mathbf{u}| = \sqrt{4+1+4} = 3$, $\mathbf{v} \cdot \mathbf{u} = 3$, $\mathbf{u} \cdot \mathbf{v} = 3$, $\mathbf{v} \times \mathbf{u} = \begin{vmatrix} \mathbf{i} & \mathbf{j} & \mathbf{k} \\ 1 & 1 & 0 \\ 2 & 1 & -2 \end{vmatrix} = -2\mathbf{i} + 2\mathbf{j} - \mathbf{k}$
 $\mathbf{u} \times \mathbf{v} = -(\mathbf{v} \times \mathbf{u}) = 2\mathbf{i} - 2\mathbf{j} + \mathbf{k}$, $|\mathbf{v} \times \mathbf{u}| = \sqrt{4+4+1} = 3$, $\theta = \cos^{-1}\left(\frac{\mathbf{v} \cdot \mathbf{u}}{|\mathbf{v}||\mathbf{u}|}\right) = \cos^{-1}\left(\frac{1}{\sqrt{2}}\right) = \frac{\pi}{4}$,
 $|\mathbf{u}| \cos \theta = \frac{3}{\sqrt{2}}$, $\text{proj}_{\mathbf{v}} \mathbf{u} = \left(\frac{\mathbf{v} \cdot \mathbf{u}}{|\mathbf{v}||\mathbf{v}|}\right)\mathbf{v} = \frac{3}{2}(\mathbf{i} + \mathbf{j})$
18. $|\mathbf{v}| = \sqrt{1^2 + 1^2 + 2^2} = \sqrt{6}$, $|\mathbf{u}| = \sqrt{(-1)^2 + (-1)^2} = \sqrt{2}$, $\mathbf{v} \cdot \mathbf{u} = (1)(-1) + (1)(0) + (2)(-1) = -3$,
 $\mathbf{u} \cdot \mathbf{v} = -3$, $\mathbf{v} \times \mathbf{u} = \begin{vmatrix} \mathbf{i} & \mathbf{j} & \mathbf{k} \\ 1 & 1 & 2 \\ -1 & 0 & -1 \end{vmatrix} = -\mathbf{i} - \mathbf{j} + \mathbf{k}$, $\mathbf{u} \times \mathbf{v} = -(\mathbf{v} \times \mathbf{u}) = \mathbf{i} + \mathbf{j} - \mathbf{k}$,
 $|\mathbf{v} \times \mathbf{u}| = \sqrt{(-1)^2 + (-1)^2 + 1^2} = \sqrt{3}$, $\theta = \cos^{-1}\left(\frac{\mathbf{v} \cdot \mathbf{u}}{|\mathbf{v}||\mathbf{u}|}\right) = \cos^{-1}\left(\frac{-3}{\sqrt{6}\sqrt{2}}\right) = \cos^{-1}\left(\frac{-3}{\sqrt{12}}\right) = \cos^{-1}\left(-\frac{\sqrt{3}}{2}\right) = \frac{5\pi}{6}$,
 $|\mathbf{u}| \cos \theta = \sqrt{2} \cdot \left(\frac{-\sqrt{3}}{2}\right) = -\frac{\sqrt{6}}{2}$, $\text{proj}_{\mathbf{v}} \mathbf{u} = \left(\frac{\mathbf{v} \cdot \mathbf{u}}{|\mathbf{v}||\mathbf{v}|}\right)\mathbf{v} = \frac{-3}{6}(\mathbf{i} + \mathbf{j} + 2\mathbf{k}) = -\frac{1}{2}(\mathbf{i} + \mathbf{j} + 2\mathbf{k})$
19. $\text{proj}_{\mathbf{v}} \mathbf{u} = \left(\frac{\mathbf{v} \cdot \mathbf{u}}{|\mathbf{v}||\mathbf{v}|}\right)\mathbf{v} = \frac{4}{3}(2\mathbf{i} + \mathbf{j} + \mathbf{k})$ where $\mathbf{v} \cdot \mathbf{u} = 8$ and $\mathbf{v} \cdot \mathbf{v} = 6$

20. $\text{proj}_{\mathbf{v}}\mathbf{u} = \left(\frac{\mathbf{v}\cdot\mathbf{u}}{|\mathbf{v}|^2}\right)\mathbf{v} = -\frac{1}{3}(\mathbf{i}-2\mathbf{j})$ where $\mathbf{v}\cdot\mathbf{u} = -1$ and $\mathbf{v}\cdot\mathbf{v} = 3$

21. $\mathbf{u}\times\mathbf{v} = \begin{vmatrix} \mathbf{i} & \mathbf{j} & \mathbf{k} \\ 1 & 0 & 0 \\ 1 & 1 & 0 \end{vmatrix} = \mathbf{k}$

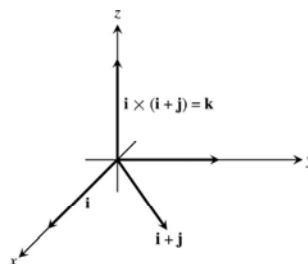

22. $\mathbf{u}\times\mathbf{v} = \begin{vmatrix} \mathbf{i} & \mathbf{j} & \mathbf{k} \\ 1 & -1 & 0 \\ 1 & 1 & 0 \end{vmatrix} = 2\mathbf{k}$

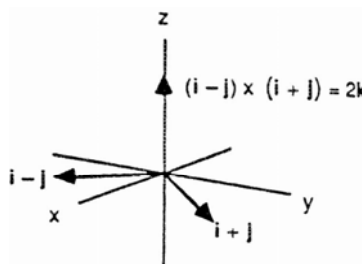

23. Let $\mathbf{v} = v_1\mathbf{i} + v_2\mathbf{j} + v_3\mathbf{k}$ and $\mathbf{w} = w_1\mathbf{i} + w_2\mathbf{j} + w_3\mathbf{k}$. Then $|\mathbf{v}-2\mathbf{w}|^2 = |(v_1\mathbf{i} + v_2\mathbf{j} + v_3\mathbf{k}) - 2(w_1\mathbf{i} + w_2\mathbf{j} + w_3\mathbf{k})|^2$
 $= |(v_1 - 2w_1)\mathbf{i} + (v_2 - 2w_2)\mathbf{j} + (v_3 - 2w_3)\mathbf{k}|^2 = \left(\sqrt{(v_1 - 2w_1)^2 + (v_2 - 2w_2)^2 + (v_3 - 2w_3)^2}\right)^2$
 $= (v_1^2 + v_2^2 + v_3^2) - 4(v_1w_1 + v_2w_2 + v_3w_3) + 4(w_1^2 + w_2^2 + w_3^2) = |\mathbf{v}|^2 - 4\mathbf{v}\cdot\mathbf{w} + 4|\mathbf{w}|^2$
 $|\mathbf{v}|^2 - 4|\mathbf{v}||\mathbf{w}|\cos\theta + 4|\mathbf{w}|^2 = 4 - 4(2)(3)\left(\cos\frac{\pi}{3}\right) + 36 = 40 - 24\left(\frac{1}{2}\right) = 40 - 12 = 28 \Rightarrow |\mathbf{v}-2\mathbf{w}| = \sqrt{28} = 2\sqrt{7}$

24. \mathbf{u} and \mathbf{v} are parallel when $\mathbf{u}\times\mathbf{v} = \mathbf{0} \Rightarrow \begin{vmatrix} \mathbf{i} & \mathbf{j} & \mathbf{k} \\ 2 & 4 & -5 \\ -4 & -8 & a \end{vmatrix} = \mathbf{0} \Rightarrow (4a-40)\mathbf{i} + (20-2a)\mathbf{j} + (0)\mathbf{k} = \mathbf{0}$
 $\Rightarrow 4a-40 = 0$ and $20-2a \Rightarrow a = 10$

25. (a) $\text{area} = |\mathbf{u}\times\mathbf{v}| = \text{abs} \begin{vmatrix} \mathbf{i} & \mathbf{j} & \mathbf{k} \\ 1 & 1 & -1 \\ 2 & 1 & 1 \end{vmatrix} = |2\mathbf{i} - 3\mathbf{j} - \mathbf{k}| = \sqrt{4+9+1} = \sqrt{14}$

(b) $\text{volume} = (\mathbf{u}\times\mathbf{v})\cdot\mathbf{w} = \begin{vmatrix} 1 & 1 & -1 \\ 2 & 1 & 1 \\ -1 & -2 & 3 \end{vmatrix} = 1(3+2) - 1(6-(-1)) - 1(-4+1) = 1$

26. (a) $\text{area} = |\mathbf{u}\times\mathbf{v}| = \text{abs} \begin{vmatrix} \mathbf{i} & \mathbf{j} & \mathbf{k} \\ 1 & 1 & 0 \\ 0 & 1 & 0 \end{vmatrix} = |\mathbf{k}| = 1$

(b) $\text{volume} = (\mathbf{u}\times\mathbf{v})\cdot\mathbf{w} = \begin{vmatrix} 1 & 1 & 0 \\ 0 & 1 & 0 \\ 1 & 1 & 1 \end{vmatrix} = 1(1-0) - 1(0-0) + 0 = 1$

27. The desired vector is $\mathbf{n} \times \mathbf{v}$ or $\mathbf{v} \times \mathbf{n}$ since $\mathbf{n} \times \mathbf{v}$ is perpendicular to both \mathbf{n} and \mathbf{v} and, therefore, also parallel to the plane.
28. If $a = 0$ and $b \neq 0$, then the line $by = c$ and \mathbf{i} are parallel. If $a \neq 0$ and $b = 0$, then the line $ax = c$ and \mathbf{j} are parallel. If a and b are both $\neq 0$, then $ax + by = c$ contains the points $(\frac{c}{a}, 0)$ and $(0, \frac{c}{b}) \Rightarrow$ the vector $ab(\frac{c}{a}\mathbf{i} - \frac{c}{b}\mathbf{j}) = c(b\mathbf{i} - a\mathbf{j})$ and the line are parallel. Therefore, the vector $b\mathbf{i} - a\mathbf{j}$ is parallel to the line $ax + by = c$ in every case.
29. The line L passes through the point $P(0, 0, -1)$ parallel to $\mathbf{v} = -\mathbf{i} + \mathbf{j} + \mathbf{k}$. With $\overline{PS} = 2\mathbf{i} + 2\mathbf{j} + \mathbf{k}$ and
- $$\overline{PS} \times \mathbf{v} = \begin{vmatrix} \mathbf{i} & \mathbf{j} & \mathbf{k} \\ 2 & 2 & 1 \\ -1 & 1 & 1 \end{vmatrix} = (2-1)\mathbf{i} - (2+1)\mathbf{j} + (2+2)\mathbf{k} = \mathbf{i} - 3\mathbf{j} + 4\mathbf{k},$$
- we find the distance $d = \frac{|\overline{PS} \times \mathbf{v}|}{|\mathbf{v}|} = \frac{\sqrt{1+9+16}}{\sqrt{1+1+1}}$
- $$= \frac{\sqrt{26}}{\sqrt{3}} = \frac{\sqrt{78}}{3}.$$
30. The line L passes through the point $P(2, 2, 0)$ parallel to $\mathbf{v} = \mathbf{i} + \mathbf{j} + \mathbf{k}$. With $\overline{PS} = -2\mathbf{i} + 2\mathbf{j} + \mathbf{k}$ and
- $$\overline{PS} \times \mathbf{v} = \begin{vmatrix} \mathbf{i} & \mathbf{j} & \mathbf{k} \\ -2 & 2 & 1 \\ 1 & 1 & 1 \end{vmatrix} = (2-1)\mathbf{i} - (-2-1)\mathbf{j} + (-2-2)\mathbf{k} = \mathbf{i} + 3\mathbf{j} - 4\mathbf{k},$$
- we find the distance $d = \frac{|\overline{PS} \times \mathbf{v}|}{|\mathbf{v}|} = \frac{\sqrt{1+9+16}}{\sqrt{1+1+1}}$
- $$= \frac{\sqrt{26}}{\sqrt{3}} = \frac{\sqrt{78}}{3}.$$
31. Parametric equations for the line are $x = 1 - 3t, y = 2, z = 3 + 7t$.
32. The line is parallel to $\overline{PQ} = 0\mathbf{i} + \mathbf{j} - \mathbf{k}$ and contains the point $P(1, 2, 0) \Rightarrow$ parametric equations are $x = 1, y = 2 + t, z = -t$ for $0 \leq t \leq 1$.
33. The point $P(4, 0, 0)$ lies on the plane $x - y = 4$, and $\overline{PS} = (6-4)\mathbf{i} + 0\mathbf{j} + (-6+0)\mathbf{k} = 2\mathbf{i} - 6\mathbf{k}$ with $\mathbf{n} = \mathbf{i} - \mathbf{j} \Rightarrow d = \frac{|\mathbf{n} \cdot \overline{PS}|}{|\mathbf{n}|} = \frac{|2+0+0|}{\sqrt{1+1+0}} = \frac{2}{\sqrt{2}} = \sqrt{2}$.
34. The point $P(0, 0, 2)$ lies on the plane $2x + 3y + z = 2$, and $\overline{PS} = (3-0)\mathbf{i} + (0-0)\mathbf{j} + (10-2)\mathbf{k} = 3\mathbf{i} + 8\mathbf{k}$ with $\mathbf{n} = 2\mathbf{i} + 3\mathbf{j} + \mathbf{k} \Rightarrow d = \frac{|\mathbf{n} \cdot \overline{PS}|}{|\mathbf{n}|} = \frac{|6+0+8|}{\sqrt{4+9+1}} = \frac{14}{\sqrt{14}} = \sqrt{14}$.
35. $P(3, -2, 1)$ and $\mathbf{n} = 2\mathbf{i} + \mathbf{j} + \mathbf{k} \Rightarrow (2)(x-3) + (1)(y-(-2)) + (1)(z-1) = 0 \Rightarrow 2x + y + z = 5$
36. $P(-1, 6, 0)$ and $\mathbf{n} = \mathbf{i} - 2\mathbf{j} + 3\mathbf{k} \Rightarrow (1)(x-(-1)) + (-2)(y-6) + (3)(z-0) = 0 \Rightarrow x - 2y + 3z = -13$

37. $P(1, -1, 2), Q(2, 1, 3)$ and $R(-1, 2, -1) \Rightarrow \overline{PQ} = \mathbf{i} + 2\mathbf{j} + \mathbf{k}, \overline{PR} = -2\mathbf{i} + 3\mathbf{j} - 3\mathbf{k}$ and

$$\overline{PQ} \times \overline{PR} = \begin{vmatrix} \mathbf{i} & \mathbf{j} & \mathbf{k} \\ 1 & 2 & 1 \\ -2 & 3 & -3 \end{vmatrix} = -9\mathbf{i} + \mathbf{j} + 7\mathbf{k} \text{ is normal to the plane } \Rightarrow (-9)(x-1) + (1)(y+1) + (7)(z-2) = 0$$

$$\Rightarrow -9x + y + 7z = 4$$

38. $P(1, 0, 0), Q(0, 1, 0)$ and $R(0, 0, 1) \Rightarrow \overline{PQ} = -\mathbf{i} + \mathbf{j}, \overline{PR} = -\mathbf{i} + \mathbf{k}$ and $\overline{PQ} \times \overline{PR} = \begin{vmatrix} \mathbf{i} & \mathbf{j} & \mathbf{k} \\ -1 & 1 & 0 \\ -1 & 0 & 1 \end{vmatrix} = \mathbf{i} + \mathbf{j} + \mathbf{k}$ is

normal to the plane $\Rightarrow (1)(x-1) + (1)(y-0) + (1)(z-0) = 0 \Rightarrow x + y + z = 1$

39. $(0, -\frac{1}{2}, -\frac{3}{2})$, since $t = -\frac{1}{2}, y = -\frac{1}{2}$ and $z = -\frac{3}{2}$ when $x = 0$; $(-1, 0, -3)$, since $t = -1, x = -1$ and $z = -3$ when $y = 0$; $(1, -1, 0)$, since $t = 0, x = 1$ and $y = -1$ when $z = 0$

40. $x = 2t, y = -t, z = -t$ represents a line containing the origin and perpendicular to the plane $2x - y - z = 4$; this line intersects the plane $3x - 5y + 2z = 6$ when t is the solution of $3(2t) - 5(-t) + 2(-t) = 6 \Rightarrow t = \frac{2}{3}$
 $\Rightarrow (\frac{4}{3}, -\frac{2}{3}, -\frac{2}{3})$ is the point of intersection

41. $\mathbf{n}_1 = \mathbf{i}$ and $\mathbf{n}_2 = \mathbf{i} + \mathbf{j} + \sqrt{2}\mathbf{k} \Rightarrow$ the desired angle is $\cos^{-1}\left(\frac{\mathbf{n}_1 \cdot \mathbf{n}_2}{|\mathbf{n}_1||\mathbf{n}_2|}\right) = \cos^{-1}\left(\frac{1}{2}\right) = \frac{\pi}{3}$

42. $\mathbf{n}_1 = \mathbf{i} + \mathbf{j}$ and $\mathbf{n}_2 = \mathbf{j} + \mathbf{k} \Rightarrow$ the desired angle is $\cos^{-1}\left(\frac{\mathbf{n}_1 \cdot \mathbf{n}_2}{|\mathbf{n}_1||\mathbf{n}_2|}\right) = \cos^{-1}\left(\frac{1}{2}\right) = \frac{\pi}{3}$

43. The direction of the line is $\mathbf{n}_1 \times \mathbf{n}_2 = \begin{vmatrix} \mathbf{i} & \mathbf{j} & \mathbf{k} \\ 1 & 2 & 1 \\ 1 & -1 & 2 \end{vmatrix} = 5\mathbf{i} - \mathbf{j} - 3\mathbf{k}$. Since the point $(-5, 3, 0)$ is on both planes, the desired line is $x = -5 + 5t, y = 3 - t, z = -3t$.

44. The direction of the intersection is $\mathbf{n}_1 \times \mathbf{n}_2 = \begin{vmatrix} \mathbf{i} & \mathbf{j} & \mathbf{k} \\ 1 & 2 & -2 \\ 5 & -2 & -1 \end{vmatrix} = -6\mathbf{i} - 9\mathbf{j} - 12\mathbf{k} = -3(2\mathbf{i} + 3\mathbf{j} + 4\mathbf{k})$ and is the same as the direction of the given line.

45. (a) The corresponding normals are $\mathbf{n}_1 = 3\mathbf{i} + 6\mathbf{k}$ and $\mathbf{n}_2 = 2\mathbf{i} + 2\mathbf{j} - \mathbf{k}$ and since $\mathbf{n}_1 \cdot \mathbf{n}_2 = (3)(2) + (0)(2) + (6)(-1) = 6 + 0 - 6 = 0$, we have that the plans are orthogonal

(b) The line of intersection is parallel to $\mathbf{n}_1 \times \mathbf{n}_2 = \begin{vmatrix} \mathbf{i} & \mathbf{j} & \mathbf{k} \\ 3 & 0 & 6 \\ 2 & 2 & -1 \end{vmatrix} = -12\mathbf{i} + 15\mathbf{j} + 6\mathbf{k}$. Now to find a point in the

intersection, solve $\begin{cases} 3x + 6z = 1 \\ 2x + 2y - z = 3 \end{cases} \Rightarrow \begin{cases} 3x + 6z = 1 \\ 12x + 12y - 6z = 18 \end{cases} \Rightarrow 15x + 12y = 19 \Rightarrow x = 0 \text{ and } y = \frac{19}{12}$
 $\Rightarrow (0, \frac{19}{12}, \frac{1}{6})$ is a point on the line we seek. Therefore, the line is $x = -12t, y = \frac{19}{12} + 15t$ and $z = \frac{1}{6} + 6t$.

46. A vector in the direction of the plane's normal is $\mathbf{n} = \mathbf{u} \times \mathbf{v} = \begin{vmatrix} \mathbf{i} & \mathbf{j} & \mathbf{k} \\ 2 & 3 & 1 \\ 1 & -1 & 2 \end{vmatrix} = 7\mathbf{i} - 3\mathbf{j} - 5\mathbf{k}$ and $P(1, 2, 3)$ on the plane $\Rightarrow 7(x-1) - 3(y-2) - 5(z-3) = 0 \Rightarrow 7x - 3y - 5z = -14$.

47. Yes; $\mathbf{v} \cdot \mathbf{n} = (2\mathbf{i} - 4\mathbf{j} + \mathbf{k}) \cdot (7\mathbf{i} - 3\mathbf{j} - 5\mathbf{k}) = 2 \cdot 7 - 4 \cdot (-3) + 1 \cdot (-5) = 14 + 12 - 5 = 21 \neq 0 \Rightarrow$ the vector is not orthogonal to the plane's normal $\Rightarrow \mathbf{v}$ is not parallel to the plane

48. $\mathbf{n} \cdot \overline{PP_0} > 0$ represents the half-space of points lying on one side of the plane in the direction which the normal \mathbf{n} points

49. A normal to the plane is $\mathbf{n} = \overline{AB} \times \overline{AC} = \begin{vmatrix} \mathbf{i} & \mathbf{j} & \mathbf{k} \\ 2 & 0 & -1 \\ 2 & -1 & 0 \end{vmatrix} = -\mathbf{i} - 2\mathbf{j} - 2\mathbf{k} \Rightarrow$ the distance is

$$d = \left| \frac{\overline{AP} \cdot \mathbf{n}}{|\mathbf{n}|} \right| = \left| \frac{(1+4\mathbf{j}) \cdot (-\mathbf{i} - 2\mathbf{j} - 2\mathbf{k})}{\sqrt{1+4+4}} \right| = \left| \frac{-1-8+0}{3} \right| = 3$$

50. $P(0, 0, 0)$ lies on the plane $2x + 3y + 5z = 0$, and $\overline{PS} = 2\mathbf{i} + 2\mathbf{j} + 3\mathbf{k}$ with $\mathbf{n} = 2\mathbf{i} + 3\mathbf{j} + 5\mathbf{k}$

$$\Rightarrow d = \left| \frac{\mathbf{n} \cdot \overline{PS}}{|\mathbf{n}|} \right| = \left| \frac{4+6+15}{\sqrt{4+9+25}} \right| = \frac{25}{\sqrt{38}}$$

51. $\mathbf{n} = 2\mathbf{i} - \mathbf{j} - \mathbf{k}$ is normal to the plane $\Rightarrow \mathbf{n} \times \mathbf{v} = \begin{vmatrix} \mathbf{i} & \mathbf{j} & \mathbf{k} \\ 2 & -1 & -1 \\ 1 & 1 & 1 \end{vmatrix} = 0\mathbf{i} - 3\mathbf{j} + 3\mathbf{k} = -3\mathbf{j} + 3\mathbf{k}$ is orthogonal to \mathbf{v} and parallel to the plane

52. The vector $\mathbf{B} \times \mathbf{C}$ is normal to the plane of \mathbf{B} and $\mathbf{C} \Rightarrow \mathbf{A} \times (\mathbf{B} \times \mathbf{C})$ is orthogonal to \mathbf{A} and parallel to the plane of \mathbf{B} and \mathbf{C} :

$$\mathbf{B} \times \mathbf{C} = \begin{vmatrix} \mathbf{i} & \mathbf{j} & \mathbf{k} \\ 1 & 2 & 1 \\ 1 & 1 & -2 \end{vmatrix} = -5\mathbf{i} + 3\mathbf{j} - \mathbf{k} \text{ and } \mathbf{A} \times (\mathbf{B} \times \mathbf{C}) = \begin{vmatrix} \mathbf{i} & \mathbf{j} & \mathbf{k} \\ 2 & -1 & 1 \\ -5 & 3 & -1 \end{vmatrix} = -2\mathbf{i} - 3\mathbf{j} + \mathbf{k}$$

$$\Rightarrow |\mathbf{A} \times (\mathbf{B} \times \mathbf{C})| = \sqrt{4+9+1} = \sqrt{14} \text{ and } \mathbf{u} = \frac{1}{\sqrt{14}}(-2\mathbf{i} - 3\mathbf{j} + \mathbf{k}) \text{ is the desired unit vector.}$$

53. A vector parallel to the line of intersection is $\mathbf{v} = \mathbf{n}_1 \times \mathbf{n}_2 = \begin{vmatrix} \mathbf{i} & \mathbf{j} & \mathbf{k} \\ 1 & 2 & 1 \\ 1 & -1 & 2 \end{vmatrix} = 5\mathbf{i} - \mathbf{j} - 3\mathbf{k} \Rightarrow |\mathbf{v}| = \sqrt{25+1+9} = \sqrt{35}$

$$\Rightarrow 2 \left(\frac{\mathbf{v}}{|\mathbf{v}|} \right) = \frac{2}{\sqrt{35}}(5\mathbf{i} - \mathbf{j} - 3\mathbf{k}) \text{ is the desired vector.}$$

54. The line containing $(0, 0, 0)$ normal to the plane is represented by $x = 2t$, $y = -t$, and $z = -t$. This line intersects the plane $3x - 5y + 2z = 6$ when $3(2t) - 5(-t) + 2(-t) = 6 \Rightarrow t = \frac{2}{3} \Rightarrow$ the point is $\left(\frac{4}{3}, -\frac{2}{3}, -\frac{2}{3}\right)$.

55. The line is represented by $x = 3 + 2t$, $y = 2 - t$, and $z = 1 + 2t$. It meets the plane $2x - y + 2z = -2$ when $2(3 + 2t) - (2 - t) + 2(1 + 2t) = -2 \Rightarrow t = -\frac{8}{9} \Rightarrow$ the point is $(\frac{11}{9}, \frac{26}{9}, -\frac{7}{9})$.

56. The direction of the intersection is $\mathbf{v} = \mathbf{n}_1 \times \mathbf{n}_2 = \begin{vmatrix} \mathbf{i} & \mathbf{j} & \mathbf{k} \\ 2 & 1 & -1 \\ 1 & 1 & 2 \end{vmatrix} = 3\mathbf{i} - 5\mathbf{j} + \mathbf{k}$

$$\Rightarrow \theta = \cos^{-1}\left(\frac{\mathbf{v} \cdot \mathbf{i}}{|\mathbf{v}|}\right) = \cos^{-1}\left(\frac{3}{\sqrt{35}}\right) \approx 59.5^\circ$$

57. The intersection occurs when $(3 + 2t) + 3(2t) - t = -4 \Rightarrow t = -1 \Rightarrow$ the point is $(1, -2, -1)$. The required line must be perpendicular to both the given line and to the normal, and hence is parallel to

$$\begin{vmatrix} \mathbf{i} & \mathbf{j} & \mathbf{k} \\ 2 & 2 & 1 \\ 1 & 3 & -1 \end{vmatrix} = -5\mathbf{i} + 3\mathbf{j} + 4\mathbf{k} \Rightarrow \text{the line is represented by } x = 1 - 5t, y = -2 + 3t, \text{ and } z = -1 + 4t.$$

58. If $P(a, b, c)$ is a point on the line of intersection, then P lies in both planes $\Rightarrow a - 2b + c + 3 = 0$ and $2a - b - c + 1 = 0 \Rightarrow (a - 2b + c + 3) + k(2a - b - c + 1) = 0$ for all k .

59. The vector $\overline{AB} \times \overline{CD} = \begin{vmatrix} \mathbf{i} & \mathbf{j} & \mathbf{k} \\ 3 & -2 & 4 \\ \frac{26}{5} & 0 & -\frac{26}{5} \end{vmatrix} = \frac{26}{5}(2\mathbf{i} + 7\mathbf{j} + 2\mathbf{k})$ is normal to the plane and $A(-2, 0, -3)$ lies on the plane $\Rightarrow 2(x + 2) + 7(y - 0) + 2(z - (-3)) = 0 \Rightarrow 2x + 7y + 2z + 10 = 0$ is an equation of the plane.

60. Yes; the line's direction vector is $2\mathbf{i} + 3\mathbf{j} - 5\mathbf{k}$ which is parallel to the line and also parallel to the normal $-4\mathbf{i} - 6\mathbf{j} + 10\mathbf{k}$ to the plane \Rightarrow the line is orthogonal to the plane.

61. The vector $\overline{PQ} \times \overline{PR} = \begin{vmatrix} \mathbf{i} & \mathbf{j} & \mathbf{k} \\ 2 & -1 & 3 \\ -3 & 0 & 1 \end{vmatrix} = -\mathbf{i} - 11\mathbf{j} - 3\mathbf{k}$ is normal to the plane.

- (a) No, the plane is not orthogonal to $\overline{PQ} \times \overline{PR}$.
- (b) No, these equations represent a line, not a plane.
- (c) No, the plane $(x + 2) + 11(y - 1) - 3z = 0$ has normal $\mathbf{i} + 11\mathbf{j} - 3\mathbf{k}$ which is not parallel to $\overline{PQ} \times \overline{PR}$.
- (d) No, this vector equation is equivalent to the equations $3y + 3z = 3, 3x - 2z = -6$, and $3x + 2y = -4 \Rightarrow x = -\frac{4}{3} - \frac{2}{3}t, y = t, z = 1 - t$, which represents a line, not a plane.
- (e) yes, this is a plane containing the point $R(-2, 1, 0)$ with normal $\overline{PQ} \times \overline{PR}$.

62. (a) The line through A and B is $x = 1 + t, y = -t, z = -1 + 5t$; the line through C and D must be parallel and is $L_1: x = 1 + t, y = 2 - t, z = 3 + 5t$. The line through B and C is $x = 1, y = 2 + 2s, z = 3 + 4s$; the line through A and D must be parallel and is $L_2: x = 2, y = -1 + 2s, z = 4 + 4s$. The lines L_1 and L_2 intersect at $D(2, 1, 8)$ where $t = 1$ and $s = 1$.

(b) $\cos \theta = \frac{(2\mathbf{j} + 4\mathbf{k}) \cdot (\mathbf{i} - \mathbf{j} + 5\mathbf{k})}{\sqrt{20}\sqrt{27}} = \frac{3}{\sqrt{15}}$

- (c) $\left(\frac{\overline{BA} \cdot \overline{BC}}{\overline{BC} \cdot \overline{BC}}\right) \overline{BC} = \frac{18}{20} \overline{BC} = \frac{9}{5}(\mathbf{j} + 2\mathbf{k})$ where $\overline{BA} = \mathbf{i} - \mathbf{j} + 5\mathbf{k}$ and $\overline{BC} = 2\mathbf{j} + 4\mathbf{k}$
- (d) $\text{area} = |(2\mathbf{j} + 4\mathbf{k}) \times (\mathbf{i} - \mathbf{j} + 5\mathbf{k})| = |14\mathbf{i} + 4\mathbf{j} - 2\mathbf{k}| = 6\sqrt{6}$
- (e) From part (d), $\mathbf{n} = 14\mathbf{i} + 4\mathbf{j} - 2\mathbf{k}$ is normal to the plane $\Rightarrow 14(x-1) + 4(y-0) - 2(z+1) = 0$
 $\Rightarrow 7x + 2y - z = 8.$
- (f) From part (d), $\mathbf{n} = 14\mathbf{i} + 4\mathbf{j} - 2\mathbf{k} \Rightarrow$ the area of the projection on the yz -plane is $|\mathbf{n} \cdot \mathbf{i}| = 14$; the area of the projection on the xz -plane is $|\mathbf{n} \cdot \mathbf{j}| = 4$; and the area of the projection on the xy -plane is $|\mathbf{n} \cdot \mathbf{k}| = 2.$

63. $\overline{AB} = -2\mathbf{i} + \mathbf{j} + \mathbf{k}, \overline{CD} = \mathbf{i} + 4\mathbf{j} - \mathbf{k},$ and $\overline{AC} = 2\mathbf{i} + \mathbf{j} \Rightarrow \mathbf{n} = \begin{vmatrix} \mathbf{i} & \mathbf{j} & \mathbf{k} \\ -2 & 1 & 1 \\ 1 & 4 & -1 \end{vmatrix} = -5\mathbf{i} - \mathbf{j} - 9\mathbf{k} \Rightarrow$ the distance is

$$d = \frac{|(2\mathbf{i} + \mathbf{j}) \cdot (-5\mathbf{i} - \mathbf{j} - 9\mathbf{k})|}{\sqrt{25 + 1 + 81}} = \frac{11}{\sqrt{107}}$$

64. $\overline{AB} = -2\mathbf{i} + 4\mathbf{j} - \mathbf{k}, \overline{CD} = \mathbf{i} - \mathbf{j} + 2\mathbf{k},$ and $\overline{AC} = -3\mathbf{i} + 3\mathbf{j} \Rightarrow \mathbf{n} = \begin{vmatrix} \mathbf{i} & \mathbf{j} & \mathbf{k} \\ -2 & 4 & -1 \\ 1 & -1 & 2 \end{vmatrix} = 7\mathbf{i} + 3\mathbf{j} - 2\mathbf{k} \Rightarrow$ the distance is

$$d = \frac{|(-3\mathbf{i} + 3\mathbf{j}) \cdot (7\mathbf{i} + 3\mathbf{j} - 2\mathbf{k})|}{\sqrt{49 + 9 + 4}} = \frac{12}{\sqrt{62}}$$

65. $x^2 + y^2 + z^2 = 4$

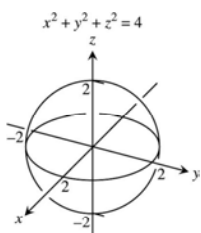

66. $x^2 + (y-1)^2 + z^2 = 1$

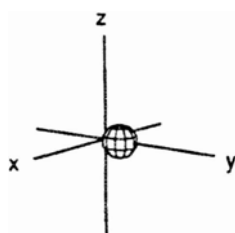

67. $4x^2 + 4y^2 + z^2 = 4$



68. $36x^2 + 9y^2 + 4z^2 = 36$

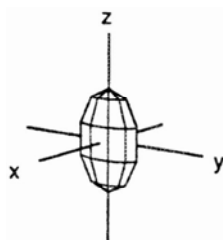

69. $z = -(x^2 + y^2)$

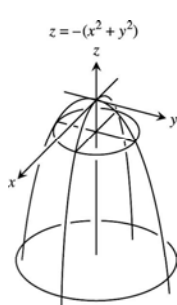

70. $y = -(x^2 + z^2)$

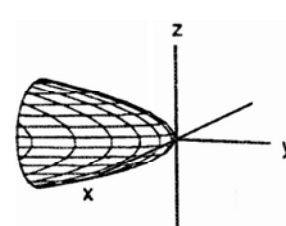

71. $x^2 + y^2 = z^2$

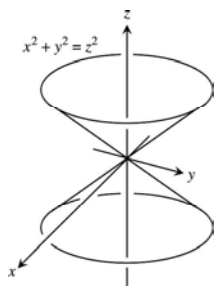

72. $x^2 + z^2 = y^2$

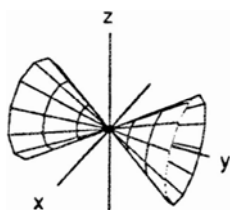

73. $x^2 - y^2 - z^2 = 4$

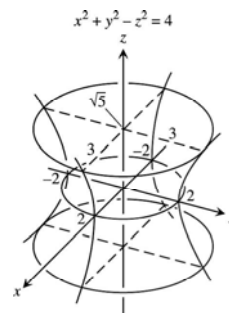

74. $4y^2 + z^2 - 4x^2 = 4$

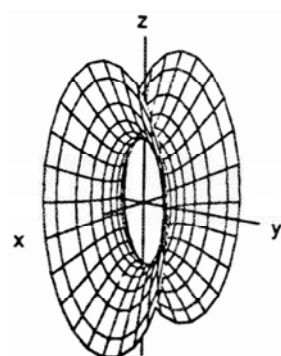

75. $y^2 - x^2 - z^2 = 1$

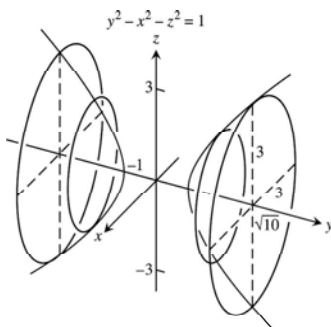

76. $z^2 - x^2 - y^2 = 1$

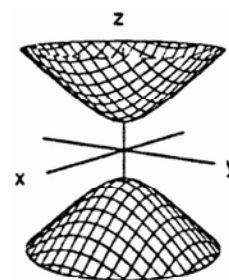

CHAPTER 12 ADDITIONAL AND ADVANCED EXERCISES

- Information from ship A indicates the submarine is now on the line $L_1: x = 4 + 2t, y = 3t, z = -\frac{1}{3}t$; information from ship B indicates the submarine is now on the line $L_2: x = 18s, y = 5 - 6s, z = -s$. The current position of the sub is $(6, 3, -\frac{1}{3})$ and occurs when the lines intersect at $t = 1$ and $s = \frac{1}{3}$. The straight line path of the submarine contains both point $P(2, -1, -\frac{1}{3})$ and $Q(6, 3, -\frac{1}{3})$; the line representing this path is $L: x = 2 + 4t, y = -1 + 4t, z = -\frac{1}{3}$. The submarine traveled the distance between P and Q in 4 minutes \Rightarrow a speed of $\frac{|PQ|}{4} = \frac{\sqrt{32}}{4} = \sqrt{2}$ thousand ft/min. In 20 minutes the submarine will move $20\sqrt{2}$ thousand ft from Q along the line $L \Rightarrow 20\sqrt{2} = \sqrt{(2 + 4t - 6)^2 + (-1 + 4t - 3)^2 + 0^2} \Rightarrow 800 = 16(t - 1)^2 + 16(t - 1)^2 = 32(t - 1)^2 \Rightarrow (t - 1)^2 = \frac{800}{32} = 25 \Rightarrow t = 6 \Rightarrow$ the submarine will be located at $(26, 23, -\frac{1}{3})$ in 20 minutes.
- H_2 stops its flight when $6 + 110t = 446 \Rightarrow t = 4$ hours. After 6 hours, H_1 is at $P(246, 57, 9)$ while H_2 is at $(446, 13, 0)$. The distance between P and Q is $\sqrt{(246 - 446)^2 + (57 - 13)^2 + (9 - 0)^2} \approx 204.98$ miles. At 150 mph, it would take about 1.37 hours for H_1 to reach H_2 .
- Torque $= |\overrightarrow{PQ} \times \mathbf{F}| \Rightarrow 15 \text{ ft}\cdot\text{lb} = |\overrightarrow{PQ}| |\mathbf{F}| \sin \frac{\pi}{2} = \frac{3}{4} \text{ ft} \cdot |\mathbf{F}| \Rightarrow |\mathbf{F}| = 20 \text{ lb}$

4. Let $\mathbf{a} = \mathbf{i} + \mathbf{j} + \mathbf{k}$ be the vector from O to A and $\mathbf{b} = \mathbf{i} + 3\mathbf{j} + 2\mathbf{k}$ be the vector from O to B . The vector \mathbf{v} orthogonal to \mathbf{a} and $\mathbf{b} \Rightarrow \mathbf{v}$ is parallel to $\mathbf{b} \times \mathbf{a}$ (since the rotation is clockwise). Now $\mathbf{b} \times \mathbf{a} = \mathbf{i} + \mathbf{j} - 2\mathbf{k}$; $\text{proj}_{\mathbf{a}} \mathbf{b} = \left(\frac{\mathbf{a} \cdot \mathbf{b}}{\mathbf{a} \cdot \mathbf{a}}\right) \mathbf{a} = 2\mathbf{i} + 2\mathbf{j} + 2\mathbf{k} \Rightarrow (2, 2, 2)$ is the center of the circular path (1, 3, 2) takes \Rightarrow radius $= \sqrt{1^2 + (-1)^2 + 0^2} = \sqrt{2} \Rightarrow$ arc length per second covered by the point is $\frac{3}{2}\sqrt{2}$ units/sec $= |\mathbf{v}|$ (velocity is constant). A unit vector in the direction of \mathbf{v} is $\frac{\mathbf{b} \times \mathbf{a}}{|\mathbf{b} \times \mathbf{a}|} = \frac{1}{\sqrt{6}}\mathbf{i} + \frac{1}{\sqrt{6}}\mathbf{j} - \frac{2}{\sqrt{6}}\mathbf{k}$ $\Rightarrow \mathbf{v} = |\mathbf{v}| \left(\frac{\mathbf{b} \times \mathbf{a}}{|\mathbf{b} \times \mathbf{a}|}\right) = \frac{3}{2}\sqrt{2} \left(\frac{1}{\sqrt{6}}\mathbf{i} + \frac{1}{\sqrt{6}}\mathbf{j} - \frac{2}{\sqrt{6}}\mathbf{k}\right) = \frac{\sqrt{3}}{2}\mathbf{i} + \frac{\sqrt{3}}{2}\mathbf{j} - \sqrt{3}\mathbf{k}$

5. (a) By the Law of Cosines we have $\cos \alpha = \frac{3^2 + 5^2 - 4^2}{2(3)(5)} = \frac{3}{5}$ and $\cos \beta = \frac{4^2 + 5^2 - 3^2}{2(4)(5)} = \frac{4}{5} \Rightarrow \sin \alpha = \frac{4}{5}$ and $\sin \beta = \frac{3}{5}$ $\Rightarrow \mathbf{F}_1 = \langle -|\mathbf{F}_1| \cos \alpha, |\mathbf{F}_1| \sin \alpha \rangle = \langle -\frac{3}{5}|\mathbf{F}_1|, \frac{4}{5}|\mathbf{F}_1| \rangle$, $\mathbf{F}_2 = \langle |\mathbf{F}_2| \cos \beta, |\mathbf{F}_2| \sin \beta \rangle = \langle \frac{4}{5}|\mathbf{F}_2|, \frac{3}{5}|\mathbf{F}_2| \rangle$, and $\mathbf{w} = \langle 0, -100 \rangle$. Since $\mathbf{F}_1 + \mathbf{F}_2 = \langle 0, 100 \rangle \Rightarrow \langle -\frac{3}{5}|\mathbf{F}_1| + \frac{4}{5}|\mathbf{F}_2|, \frac{4}{5}|\mathbf{F}_1| + \frac{3}{5}|\mathbf{F}_2| \rangle = \langle 0, 100 \rangle \Rightarrow -\frac{3}{5}|\mathbf{F}_1| + \frac{4}{5}|\mathbf{F}_2| = 0$ and $\frac{4}{5}|\mathbf{F}_1| + \frac{3}{5}|\mathbf{F}_2| = 100$. Solving the first equation for $|\mathbf{F}_2|$ results in: $|\mathbf{F}_2| = \frac{3}{4}|\mathbf{F}_1|$. Substituting this result into the second equation gives us: $\frac{4}{5}|\mathbf{F}_1| + \frac{9}{20}|\mathbf{F}_1| = 100 \Rightarrow |\mathbf{F}_1| = 80$ lb. $\Rightarrow |\mathbf{F}_2| = 60$ lb. $\Rightarrow \mathbf{F}_1 = \langle -48, 64 \rangle$ and $\mathbf{F}_2 = \langle 48, 36 \rangle$, and $\alpha = \tan^{-1}\left(\frac{4}{3}\right)$ and $\beta = \tan^{-1}\left(\frac{3}{4}\right)$

(b) By the Law of Cosines we have $\cos \alpha = \frac{5^2 + 13^2 - 12^2}{2(5)(13)} = \frac{5}{13}$ and $\cos \beta = \frac{12^2 + 13^2 - 5^2}{2(12)(13)} = \frac{12}{13} \Rightarrow \sin \alpha = \frac{12}{13}$ and $\sin \beta = \frac{5}{13} \Rightarrow \mathbf{F}_1 = \langle -|\mathbf{F}_1| \cos \alpha, |\mathbf{F}_1| \sin \alpha \rangle = \langle -\frac{5}{13}|\mathbf{F}_1|, \frac{12}{13}|\mathbf{F}_1| \rangle$, $\mathbf{F}_2 = \langle |\mathbf{F}_2| \cos \beta, |\mathbf{F}_2| \sin \beta \rangle = \langle \frac{12}{13}|\mathbf{F}_2|, \frac{5}{13}|\mathbf{F}_2| \rangle$, and $\mathbf{w} = \langle 0, -200 \rangle$. Since $\mathbf{F}_1 + \mathbf{F}_2 = \langle 0, 200 \rangle \Rightarrow \langle -\frac{5}{13}|\mathbf{F}_1| + \frac{12}{13}|\mathbf{F}_2|, \frac{12}{13}|\mathbf{F}_1| + \frac{5}{13}|\mathbf{F}_2| \rangle = \langle 0, 200 \rangle \Rightarrow -\frac{5}{13}|\mathbf{F}_1| + \frac{12}{13}|\mathbf{F}_2| = 0$ and $\frac{12}{13}|\mathbf{F}_1| + \frac{5}{13}|\mathbf{F}_2| = 200$. Solving the first equation for $|\mathbf{F}_2|$ results in: $|\mathbf{F}_2| = \frac{5}{12}|\mathbf{F}_1|$. Substituting this result into the second equation gives us: $\frac{12}{13}|\mathbf{F}_1| + \frac{25}{156}|\mathbf{F}_1| = 200 \Rightarrow |\mathbf{F}_1| = \frac{2400}{13} \approx 184.615$ lb. $\Rightarrow |\mathbf{F}_2| = \frac{1000}{13} \approx 76.923$ lb. $\Rightarrow \mathbf{F}_1 = \langle -\frac{12000}{1169}, \frac{28800}{1169} \rangle \approx \langle -71.006, 170.414 \rangle$ and $\mathbf{F}_2 = \langle \frac{12000}{1169}, \frac{5000}{1169} \rangle \approx \langle 71.006, 29.586 \rangle$.

6. (a) $\mathbf{T}_1 = \langle -|\mathbf{T}_1| \cos \alpha, |\mathbf{T}_1| \sin \alpha \rangle$, $\mathbf{T}_2 = \langle |\mathbf{T}_2| \cos \beta, |\mathbf{T}_2| \sin \beta \rangle$, and $\mathbf{w} = \langle 0, -w \rangle$. Since $\mathbf{T}_1 + \mathbf{T}_2 = \langle 0, w \rangle \Rightarrow \langle -|\mathbf{T}_1| \cos \alpha + |\mathbf{T}_2| \cos \beta, |\mathbf{T}_1| \sin \alpha + |\mathbf{T}_2| \sin \beta \rangle = \langle 0, w \rangle \Rightarrow -|\mathbf{T}_1| \cos \alpha + |\mathbf{T}_2| \cos \beta = 0$ and $|\mathbf{T}_1| \sin \alpha + |\mathbf{T}_2| \sin \beta = w$. Solving the first equation for $|\mathbf{T}_2|$ results in: $|\mathbf{T}_2| = \frac{\cos \alpha}{\cos \beta} |\mathbf{T}_1|$. Substituting this

result into the second equation gives us: $|\mathbf{T}_1| \sin \alpha + \frac{\cos \alpha \sin \beta}{\cos \beta} |\mathbf{T}_1| = w$ $\Rightarrow |\mathbf{T}_1| = \frac{w \cos \beta}{\sin \alpha \cos \beta + \cos \alpha \sin \beta} = \frac{w \cos \beta}{\sin(\alpha + \beta)}$ and $|\mathbf{T}_2| = \frac{w \cos \beta}{\sin(\alpha + \beta)}$

(b) $\frac{d}{d\alpha} (|\mathbf{T}_1|) = \frac{d}{d\alpha} \left(\frac{w \cos \beta}{\sin(\alpha + \beta)} \right) = \frac{-w \cos \beta \cos(\alpha + \beta)}{\sin^2(\alpha + \beta)}$; $\frac{d}{d\alpha} (|\mathbf{T}_1|) = 0 \Rightarrow -w \cos \beta \cos(\alpha + \beta) = 0 \Rightarrow \cos(\alpha + \beta) = 0$

$\Rightarrow \alpha + \beta = \frac{\pi}{2} \Rightarrow \alpha = \frac{\pi}{2} - \beta$; $\frac{d^2}{d\alpha^2} (|\mathbf{T}_1|) = \frac{d}{d\alpha} \left(\frac{-w \cos \beta \cos(\alpha + \beta)}{\sin^2(\alpha + \beta)} \right) = \frac{w \cos \beta (\cos^2(\alpha + \beta) + 1)}{\sin^3(\alpha + \beta)}$;

$\frac{d^2}{d\alpha^2} (|\mathbf{T}_1|) \Big|_{\alpha = \frac{\pi}{2} - \beta} = w \cos \beta > 0 \Rightarrow$ local minimum when $\alpha = \frac{\pi}{2} - \beta$

$$(c) \frac{d}{d\beta}(|\mathbf{T}_2|) = \frac{d}{d\beta} \left(\frac{w \cos \alpha}{\sin(\alpha + \beta)} \right) = \frac{-w \cos \alpha \cos(\alpha + \beta)}{\sin^2(\alpha + \beta)}; \quad \frac{d}{d\beta}(|\mathbf{T}_2|) = 0 \Rightarrow -w \cos \alpha \cos(\alpha + \beta) = 0$$

$$\Rightarrow \cos(\alpha + \beta) = 0 \Rightarrow \alpha + \beta = \frac{\pi}{2} \Rightarrow \beta = \frac{\pi}{2} - \alpha; \quad \frac{d^2}{d\beta^2}(|\mathbf{T}_2|) = \frac{d}{d\beta} \left(\frac{-w \cos \alpha \cos(\alpha + \beta)}{\sin^2(\alpha + \beta)} \right) = \frac{w \cos \alpha (\cos^2(\alpha + \beta) + 1)}{\sin^3(\alpha + \beta)};$$

$$\frac{d^2}{d\alpha^2}(|\mathbf{T}_2|) \Big|_{\beta = \frac{\pi}{2} - \alpha} = w \cos \alpha > 0 \Rightarrow \text{local minimum when } \beta = \frac{\pi}{2} - \alpha$$

7. (a) If $P(x, y, z)$ is a point in the plane determined by the three points $P_1(x_1, y_1, z_1)$, $P_2(x_2, y_2, z_2)$ and $P_3(x_3, y_3, z_3)$, then the vectors $\overline{PP_1}$, $\overline{PP_2}$ and $\overline{PP_3}$ all lie in the plane. Thus $\overline{PP_1} \cdot (\overline{PP_2} \times \overline{PP_3}) = 0$

$$\Rightarrow \begin{vmatrix} x_1 - x & y_1 - y & z_1 - z \\ x_2 - x & y_2 - y & z_2 - z \\ x_3 - x & y_3 - y & z_3 - z \end{vmatrix} = 0 \text{ by the determinant formula for the triple scalar product in Section 12.4.}$$

- (b) Subtract row 1 from rows 2, 3, and 4 and evaluate the resulting determinant (which has the same value as the given determinant) by cofactor expansion about column 4. This expansion is exactly the determinant in part (a) so we have all points $P(x, y, z)$ in the plane determined by $P_1(x_1, y_1, z_1)$, $P_2(x_2, y_2, z_2)$, and $P_3(x_3, y_3, z_3)$.

8. Let $L_1: x = a_1s + b_1, y = a_2s + b_2, z = a_3s + b_3$ and $L_2: x = c_1t + d_1, y = c_2t + d_2, z = c_3t + d_3$. If $L_1 \parallel L_2$, then for

some $k, a_i = kc_i, i = 1, 2, 3$ and the determinant $\begin{vmatrix} a_1 & c_1 & b_1 - d_1 \\ a_2 & c_2 & b_2 - d_2 \\ a_3 & c_3 & b_3 - d_3 \end{vmatrix} = \begin{vmatrix} kc_1 & c_1 & b_1 - d_1 \\ kc_2 & c_2 & b_2 - d_2 \\ kc_3 & c_3 & b_3 - d_3 \end{vmatrix} = 0$, since the first

column is a multiple of the second column. The lines L_1 and L_2 intersect if and only if the system

$$\begin{cases} a_1s - c_1t + (b_1 - d_1) = 0 \\ a_2s - c_2t + (b_2 - d_2) = 0 \\ a_3s - c_3t + (b_3 - d_3) = 0 \end{cases} \text{ has a nontrivial solution } \Leftrightarrow \text{the determinant of the coefficients is zero.}$$

9. (a) Place the tetrahedron so that A is at $(0, 0, 0)$, the point P is on the y -axis, and $\triangle ABC$ lies in the xy -plane. Since $\triangle ABC$ is an equilateral triangle, all the angles in the triangle are 60° and since AP bisects $BC \Rightarrow \triangle ABP$ is a $30^\circ - 60^\circ - 90^\circ$ triangle. Thus the coordinates of P are $(0, \sqrt{3}, 0)$, the coordinates of B are $(1, \sqrt{3}, 0)$, and the coordinates of C are $(-1, \sqrt{3}, 0)$. Let the coordinates of D be given by (a, b, c) . Since all of the faces are equilateral triangles \Rightarrow all the angles in each of the triangles are $60^\circ \Rightarrow \cos(\angle DAB) = \cos(60^\circ) = \frac{\overline{AD} \cdot \overline{AB}}{|\overline{AD}| |\overline{AB}|} = \frac{a + b\sqrt{3}}{(2)(2)} = \frac{1}{2} \Rightarrow a + b\sqrt{3} = 2$ and $\cos(\angle DAC) = \cos(60^\circ) = \frac{\overline{AD} \cdot \overline{AC}}{|\overline{AD}| |\overline{AC}|} = \frac{-a + b\sqrt{3}}{(2)(2)} = \frac{1}{2} \Rightarrow -a + b\sqrt{3} = 2$. Add the two equations to obtain: $2b\sqrt{3} = 4 \Rightarrow b = \frac{2}{\sqrt{3}}$.

Substituting this value for b in the first equation gives us: $a + \left(\frac{2}{\sqrt{3}}\right)\sqrt{3} = 2 \Rightarrow a = 0$. Since

$$|\overline{AD}| = \sqrt{a^2 + b^2 + c^2} = 2 \Rightarrow 0^2 + \left(\frac{2}{\sqrt{3}}\right)^2 + c^2 = 4 \Rightarrow c = \frac{2\sqrt{2}}{\sqrt{3}}. \text{ Thus the coordinates of } D \text{ are } \left(0, \frac{2}{\sqrt{3}}, \frac{2\sqrt{2}}{\sqrt{3}}\right).$$

$$\cos \theta = \cos(\angle DAP) = \frac{\overline{AD} \cdot \overline{AP}}{|\overline{AD}| |\overline{AP}|} = \frac{2}{2\sqrt{3}} \Rightarrow \theta = \cos^{-1}\left(\frac{1}{\sqrt{3}}\right) \Rightarrow 57.74^\circ$$

- (b) Since $\triangle ABC$ lies in the xy -plane \Rightarrow the normal to the face given by $\triangle ABC$ is $\mathbf{n}_1 = \mathbf{k}$. The face given by $\triangle BCD$ is an adjacent face. The vectors $\overline{DB} = \mathbf{i} + \frac{1}{\sqrt{3}}\mathbf{j} - \frac{2\sqrt{2}}{\sqrt{3}}\mathbf{k}$ and $\overline{DC} = -\mathbf{i} + \frac{1}{\sqrt{3}}\mathbf{j} - \frac{2\sqrt{2}}{\sqrt{3}}\mathbf{k}$ both lie in the

plane containing $\triangle BCD$. The normal to this plane is given by $\mathbf{n}_2 = \begin{vmatrix} \mathbf{i} & \mathbf{j} & \mathbf{k} \\ 1 & \frac{1}{\sqrt{3}} & -\frac{2\sqrt{2}}{\sqrt{3}} \\ -1 & \frac{1}{\sqrt{3}} & -\frac{2\sqrt{2}}{\sqrt{3}} \end{vmatrix} = \frac{4\sqrt{2}}{\sqrt{3}}\mathbf{j} + \frac{2}{\sqrt{3}}\mathbf{k}$.

The angle θ between two adjacent faces is given by $\cos \theta = \cos(\angle DAP) = \frac{\mathbf{n}_1 \cdot \mathbf{n}_2}{|\mathbf{n}_1||\mathbf{n}_2|} = \frac{2/\sqrt{3}}{(1)(6/\sqrt{3})}$

$$\Rightarrow \theta = \cos^{-1}\left(\frac{1}{3}\right) \approx 70.53^\circ.$$

10. Extend \overline{CD} to \overline{CG} so that $\overline{CD} = \overline{DG}$. Then $\overline{CG} = t\overline{CF} = \overline{CB} + \overline{BG}$ and $t\overline{CF} = 3\overline{CE} + \overline{CA}$, since $ACBG$ is a parallelogram. If $t\overline{CF} - 3\overline{CE} = \overline{CA} = \mathbf{0}$, then $t - 3 - 1 = 0 \Rightarrow t = 4$, since F, E , and A are collinear. Therefore, $\overline{CG} = 4\overline{CF} \Rightarrow \overline{CD} = 2\overline{CF} \Rightarrow F$ is the midpoint of \overline{CD} .
11. If $Q(x, y)$ is a point on the line $ax + by = c$, then $\overline{P_1Q} = (x - x_1)\mathbf{i} + (y - y_1)\mathbf{j}$, and $\mathbf{n} = a\mathbf{i} + b\mathbf{j}$ is normal to the line. The distance is $|\text{proj}_{\mathbf{n}} \overline{P_1Q}| = \left| \frac{[(x - x_1)\mathbf{i} + (y - y_1)\mathbf{j}] \cdot (a\mathbf{i} + b\mathbf{j})}{\sqrt{a^2 + b^2}} \right| = \frac{|a(x - x_1) + b(y - y_1)|}{\sqrt{a^2 + b^2}} = \frac{|ax_1 + by_1 - c|}{\sqrt{a^2 + b^2}}$, since $c = ax + by$.
12. (a) Let $Q(x, y, z)$ be any point on $Ax + By + Cz - D = 0$. Let $\overline{QP_1} = (x - x_1)\mathbf{i} + (y - y_1)\mathbf{j} + (z - z_1)\mathbf{k}$, and $\mathbf{n} = \frac{A\mathbf{i} + B\mathbf{j} + C\mathbf{k}}{\sqrt{A^2 + B^2 + C^2}}$. The distance is $|\text{proj}_{\mathbf{n}} \overline{QP_1}| = \left| \frac{[(x - x_1)\mathbf{i} + (y - y_1)\mathbf{j} + (z - z_1)\mathbf{k}] \cdot \left(\frac{A\mathbf{i} + B\mathbf{j} + C\mathbf{k}}{\sqrt{A^2 + B^2 + C^2}}\right)}{\sqrt{A^2 + B^2 + C^2}} \right| = \frac{|Ax_1 + By_1 + Cz_1 - D|}{\sqrt{A^2 + B^2 + C^2}}$.
- (b) Since both tangent planes are parallel, one-half of the distance between them is equal to the radius of the sphere, i. e., $r = \frac{1}{2} \frac{|3 - 9|}{\sqrt{1 + 1 + 1}} = \sqrt{3}$ (see also Exercise 12a). Clearly, the points $(1, 2, 3)$ and $(-1, -2, -3)$ are on the line containing the sphere's center. Hence, the line containing the center is $x = 1 + 2t$, $y = 2 + 4t$, $z = 3 + 6t$. The distance from the plane $x + y + z - 3 = 0$ to the center is $\sqrt{3} \Rightarrow \frac{|(1 + 2t) + (2 + 4t) + (3 + 6t) - 3|}{\sqrt{1 + 1 + 1}} = \sqrt{3}$ from part (a) $\Rightarrow t = 0 \Rightarrow$ the center is at $(1, 2, 3)$. Therefore an equation of the sphere is $(x - 1)^2 + (y - 2)^2 + (z - 3)^2 = 3$.
13. (a) If (x_1, y_1, z_1) is on the plane $Ax + By + Cz = D_1$, then the distance d between the planes is $d = \frac{|Ax_1 + By_1 + Cz_1 - D_2|}{\sqrt{A^2 + B^2 + C^2}} = \frac{|D_1 - D_2|}{|A\mathbf{i} + B\mathbf{j} + C\mathbf{k}|}$, since $Ax_1 + By_1 + Cz_1 = D_1$, by Exercise 12(a).
- (b) $d = \frac{|12 - 6|}{\sqrt{4 + 9 + 1}} = \frac{6}{\sqrt{14}}$
- (c) $\frac{|2(3) + (-1)(2) + 2(-1) + 4|}{\sqrt{14}} = \frac{|2(3) + (-1)(2) + 2(-1) - D|}{\sqrt{14}} \Rightarrow D = 8$ or $-4 \Rightarrow$ the desired plane is $2x - y + 2z = 8$
- (d) Choose the point $(2, 0, 1)$ on the plane. Then $\frac{|3 - D|}{\sqrt{6}} = 5 \Rightarrow D = 3 \pm 5\sqrt{6} \Rightarrow$ the desired planes are $x - 2y + z = 3 + 5\sqrt{6}$ and $x - 2y + z = 3 - 5\sqrt{6}$.

14. Let $\mathbf{n} = \overline{AB} \times \overline{BC}$ and $D(x, y, z)$ be any point in the plane determined by A, B and C . Then the point D lies in this plane if and only if $\overline{AD} \cdot \mathbf{n} = 0 \Leftrightarrow \overline{AD} \cdot (\overline{AB} \times \overline{BC}) = 0$.

15. $\mathbf{n} = \mathbf{i} + 2\mathbf{j} + 6\mathbf{k}$ is normal to the plane $x + 2y + 6z = 6$; $\mathbf{v} \times \mathbf{n} = \begin{vmatrix} \mathbf{i} & \mathbf{j} & \mathbf{k} \\ 1 & 1 & 1 \\ 1 & 2 & 6 \end{vmatrix} = 4\mathbf{i} - 5\mathbf{j} + \mathbf{k}$ is parallel to the plane and

perpendicular to the plane of \mathbf{v} and $\mathbf{n} \Rightarrow \mathbf{w} = \mathbf{n} \times (\mathbf{v} \times \mathbf{n}) = \begin{vmatrix} \mathbf{i} & \mathbf{j} & \mathbf{k} \\ 1 & 2 & 6 \\ 4 & -5 & 1 \end{vmatrix} = 32\mathbf{i} + 23\mathbf{j} - 13\mathbf{k}$ is a vector parallel to the

plane $x + 2y + 6z = 6$ in the direction of the projection vector $\text{proj}_P \mathbf{v}$. Therefore,

$$\text{proj}_P \mathbf{v} = \text{proj}_{\mathbf{w}} \mathbf{v} = \left(\mathbf{v} \cdot \frac{\mathbf{w}}{|\mathbf{w}|} \right) \frac{\mathbf{w}}{|\mathbf{w}|} = \left(\frac{\mathbf{v} \cdot \mathbf{w}}{|\mathbf{w}|^2} \right) \mathbf{w} = \left(\frac{32+23-13}{32^2+23^2+13^2} \right) \mathbf{w} = \frac{42}{1722} \mathbf{w} = \frac{1}{41} \mathbf{w} = \frac{32}{41} \mathbf{i} + \frac{23}{41} \mathbf{j} - \frac{13}{41} \mathbf{k}$$

16. $\text{proj}_z \mathbf{w} = -\text{proj}_z \mathbf{v}$ and $\mathbf{w} - \text{proj}_z \mathbf{w} = \mathbf{v} - \text{proj}_z \mathbf{v} \Rightarrow \mathbf{w} = (\mathbf{w} - \text{proj}_z \mathbf{w}) + \text{proj}_z \mathbf{w} = (\mathbf{v} - \text{proj}_z \mathbf{v}) + \text{proj}_z \mathbf{w}$
 $= \mathbf{v} - 2 \text{proj}_z \mathbf{v} = \mathbf{v} - 2 \left(\frac{\mathbf{v} \cdot \mathbf{z}}{|\mathbf{z}|^2} \right) \mathbf{z}$

17. (a) $\mathbf{u} \times \mathbf{v} = 2\mathbf{i} \times 2\mathbf{j} = 4\mathbf{k} \Rightarrow (\mathbf{u} \times \mathbf{v}) \times \mathbf{w} = \mathbf{0}; (\mathbf{u} \cdot \mathbf{w})\mathbf{v} - (\mathbf{v} \cdot \mathbf{w})\mathbf{u} = 0\mathbf{v} - 0\mathbf{u} = \mathbf{0}; \mathbf{v} \times \mathbf{w} = 4\mathbf{i} \Rightarrow \mathbf{u} \times (\mathbf{v} \times \mathbf{w}) = \mathbf{0};$
 $(\mathbf{u} \cdot \mathbf{w})\mathbf{v} - (\mathbf{v} \cdot \mathbf{w})\mathbf{u} = 0\mathbf{v} - 0\mathbf{u} = \mathbf{0}$

(b) $\mathbf{u} \times \mathbf{v} = \begin{vmatrix} \mathbf{i} & \mathbf{j} & \mathbf{k} \\ 1 & -1 & 1 \\ 2 & 1 & -2 \end{vmatrix} = \mathbf{i} + 4\mathbf{j} + 3\mathbf{k} \Rightarrow (\mathbf{u} \times \mathbf{v}) \times \mathbf{w} = \begin{vmatrix} \mathbf{i} & \mathbf{j} & \mathbf{k} \\ 1 & 4 & 3 \\ -1 & 2 & -1 \end{vmatrix} = -10\mathbf{i} - 2\mathbf{j} + 6\mathbf{k};$

$$(\mathbf{u} \cdot \mathbf{w})\mathbf{v} - (\mathbf{v} \cdot \mathbf{w})\mathbf{u} = -4(2\mathbf{i} + \mathbf{j} - 2\mathbf{k}) - 2(\mathbf{i} - \mathbf{j} + \mathbf{k}) = -10\mathbf{i} - 2\mathbf{j} + 6\mathbf{k};$$

$$\mathbf{v} \times \mathbf{w} = \begin{vmatrix} \mathbf{i} & \mathbf{j} & \mathbf{k} \\ 2 & 1 & -2 \\ -1 & 2 & -1 \end{vmatrix} = 3\mathbf{i} + 4\mathbf{j} + 5\mathbf{k} \Rightarrow \mathbf{u} \times (\mathbf{v} \times \mathbf{w}) = \begin{vmatrix} \mathbf{i} & \mathbf{j} & \mathbf{k} \\ 1 & -1 & 1 \\ 3 & 4 & 5 \end{vmatrix} = -9\mathbf{i} - 2\mathbf{j} + 7\mathbf{k};$$

$$(\mathbf{u} \cdot \mathbf{w})\mathbf{v} - (\mathbf{v} \cdot \mathbf{w})\mathbf{u} = -4(2\mathbf{i} + \mathbf{j} - 2\mathbf{k}) - (-1)(-\mathbf{i} + 2\mathbf{j} - \mathbf{k}) = -9\mathbf{i} - 2\mathbf{j} + 7\mathbf{k}$$

(c) $\mathbf{u} \times \mathbf{v} = \begin{vmatrix} \mathbf{i} & \mathbf{j} & \mathbf{k} \\ 2 & 1 & 0 \\ 2 & -1 & 1 \end{vmatrix} = \mathbf{i} - 2\mathbf{j} - 4\mathbf{k} \Rightarrow (\mathbf{u} \times \mathbf{v}) \times \mathbf{w} = \begin{vmatrix} \mathbf{i} & \mathbf{j} & \mathbf{k} \\ 1 & -2 & -4 \\ 1 & 0 & 2 \end{vmatrix} = -4\mathbf{i} - 6\mathbf{j} + 2\mathbf{k};$

$$(\mathbf{u} \cdot \mathbf{w})\mathbf{v} - (\mathbf{v} \cdot \mathbf{w})\mathbf{u} = 2(2\mathbf{i} - \mathbf{j} + \mathbf{k}) - 4(2\mathbf{i} + \mathbf{j}) = -4\mathbf{i} - 6\mathbf{j} + 2\mathbf{k};$$

$$\mathbf{v} \times \mathbf{w} = \begin{vmatrix} \mathbf{i} & \mathbf{j} & \mathbf{k} \\ 2 & -1 & 1 \\ 1 & 0 & 2 \end{vmatrix} = -2\mathbf{i} - 3\mathbf{j} + \mathbf{k} \Rightarrow \mathbf{u} \times (\mathbf{v} \times \mathbf{w}) = \begin{vmatrix} \mathbf{i} & \mathbf{j} & \mathbf{k} \\ 2 & 1 & 0 \\ -2 & -3 & 1 \end{vmatrix} = \mathbf{i} - 2\mathbf{j} - 4\mathbf{k};$$

$$(\mathbf{u} \cdot \mathbf{w})\mathbf{v} - (\mathbf{v} \cdot \mathbf{w})\mathbf{u} = 2(2\mathbf{i} - \mathbf{j} + \mathbf{k}) - 3(\mathbf{i} + 2\mathbf{k}) = \mathbf{i} - 2\mathbf{j} - 4\mathbf{k}$$

(d) $\mathbf{u} \times \mathbf{v} = \begin{vmatrix} \mathbf{i} & \mathbf{j} & \mathbf{k} \\ 1 & 1 & -2 \\ -1 & 0 & -1 \end{vmatrix} = -\mathbf{i} + 3\mathbf{j} + \mathbf{k} \Rightarrow (\mathbf{u} \times \mathbf{v}) \times \mathbf{w} = \begin{vmatrix} \mathbf{i} & \mathbf{j} & \mathbf{k} \\ -1 & 3 & 1 \\ 2 & 4 & -2 \end{vmatrix} = -10\mathbf{i} - 10\mathbf{k};$

$$(\mathbf{u} \cdot \mathbf{w})\mathbf{v} - (\mathbf{v} \cdot \mathbf{w})\mathbf{u} = 10(-\mathbf{i} - \mathbf{k}) - 0(\mathbf{i} + \mathbf{j} - 2\mathbf{k}) = -10\mathbf{i} - 10\mathbf{k};$$

$$\mathbf{v} \times \mathbf{w} = \begin{vmatrix} \mathbf{i} & \mathbf{j} & \mathbf{k} \\ -1 & 0 & -1 \\ 2 & 4 & -2 \end{vmatrix} = 4\mathbf{i} - 4\mathbf{j} - 4\mathbf{k} \Rightarrow \mathbf{u} \times (\mathbf{v} \times \mathbf{w}) = \begin{vmatrix} \mathbf{i} & \mathbf{j} & \mathbf{k} \\ 1 & 1 & -2 \\ 4 & -4 & -4 \end{vmatrix} = -12\mathbf{i} - 4\mathbf{j} - 8\mathbf{k};$$

$$(\mathbf{u} \cdot \mathbf{w})\mathbf{v} - (\mathbf{u} \cdot \mathbf{v})\mathbf{w} = 10(-\mathbf{i} - \mathbf{k}) - 1(2\mathbf{i} + 4\mathbf{j} - 2\mathbf{k}) = -12\mathbf{i} - 4\mathbf{j} - 8\mathbf{k}$$

18. (a) $\mathbf{u} \times (\mathbf{v} \times \mathbf{w}) + \mathbf{v} \times (\mathbf{w} \times \mathbf{u}) + \mathbf{w} \times (\mathbf{u} \times \mathbf{v}) = (\mathbf{u} \cdot \mathbf{w})\mathbf{v} - (\mathbf{u} \cdot \mathbf{v})\mathbf{w} + (\mathbf{v} \cdot \mathbf{u})\mathbf{w} - (\mathbf{v} \cdot \mathbf{w})\mathbf{u} + (\mathbf{w} \cdot \mathbf{v})\mathbf{u} - (\mathbf{w} \cdot \mathbf{u})\mathbf{v} = \mathbf{0}$

(b) $[\mathbf{u} \cdot (\mathbf{v} \times \mathbf{i})]\mathbf{i} + [\mathbf{u} \cdot (\mathbf{v} \times \mathbf{j})]\mathbf{j} + [\mathbf{u} \cdot (\mathbf{v} \times \mathbf{k})]\mathbf{k} = [(\mathbf{u} \times \mathbf{v}) \cdot \mathbf{i}]\mathbf{i} + [(\mathbf{u} \times \mathbf{v}) \cdot \mathbf{j}]\mathbf{j} + [(\mathbf{u} \times \mathbf{v}) \cdot \mathbf{k}]\mathbf{k} = \mathbf{u} \times \mathbf{v}$

(c) $(\mathbf{u} \times \mathbf{v}) \cdot (\mathbf{w} \times \mathbf{r}) = \mathbf{u} \cdot [\mathbf{v} \times (\mathbf{w} \times \mathbf{r})] = \mathbf{u} \cdot [(\mathbf{v} \cdot \mathbf{r})\mathbf{w} - (\mathbf{v} \cdot \mathbf{w})\mathbf{r}] = (\mathbf{u} \cdot \mathbf{w})(\mathbf{v} \cdot \mathbf{r}) - (\mathbf{u} \cdot \mathbf{r})(\mathbf{v} \cdot \mathbf{w}) = \begin{vmatrix} \mathbf{u} \cdot \mathbf{w} & \mathbf{v} \cdot \mathbf{w} \\ \mathbf{u} \cdot \mathbf{r} & \mathbf{v} \cdot \mathbf{r} \end{vmatrix}$

19. The formula is always true; $\mathbf{u} \times [\mathbf{u} \times (\mathbf{u} \times \mathbf{v})] \cdot \mathbf{w} = \mathbf{u} \times [(\mathbf{u} \cdot \mathbf{v})\mathbf{u} - (\mathbf{u} \cdot \mathbf{u})\mathbf{v}] \cdot \mathbf{w} = [(\mathbf{u} \cdot \mathbf{v})\mathbf{u} \times \mathbf{u} - (\mathbf{u} \cdot \mathbf{u})\mathbf{u} \times \mathbf{v}] \cdot \mathbf{w} = -|\mathbf{u}|^2 \mathbf{u} \times \mathbf{v} \cdot \mathbf{w} = -|\mathbf{u}|^2 \mathbf{u} \cdot \mathbf{v} \times \mathbf{w}$

20. If $\mathbf{u} = (\cos B)\mathbf{i} + (\sin B)\mathbf{j}$ and $\mathbf{v} = (\cos A)\mathbf{i} + (\sin A)\mathbf{j}$, where $A > B$, then $\mathbf{u} \times \mathbf{v} = [|\mathbf{u}||\mathbf{v}|\sin(A - B)]\mathbf{k}$

$$= \begin{vmatrix} \mathbf{i} & \mathbf{j} & \mathbf{k} \\ \cos B & \sin B & 0 \\ \cos A & \sin A & 0 \end{vmatrix} = (\cos B \sin A - \sin B \cos A)\mathbf{k} \Rightarrow \sin(A - B) = \cos B \sin A - \sin B \cos A, \text{ since}$$

$$|\mathbf{u}| = 1 \text{ and } |\mathbf{v}| = 1.$$

21. If $\mathbf{u} = a\mathbf{i} + b\mathbf{j}$ and $\mathbf{v} = c\mathbf{i} + d\mathbf{j}$, then $\mathbf{u} \cdot \mathbf{v} = |\mathbf{u}||\mathbf{v}|\cos\theta \Rightarrow ac + bd = \sqrt{a^2 + b^2}\sqrt{c^2 + d^2}\cos\theta$
 $\Rightarrow (ac + bd)^2 = (a^2 + b^2)(c^2 + d^2)\cos^2\theta \Rightarrow (ac + bd)^2 \leq (a^2 + b^2)(c^2 + d^2)$, since $\cos^2\theta \leq 1$.

22. If $\mathbf{u} = a\mathbf{i} + b\mathbf{j} + c\mathbf{k}$, then $\mathbf{u} \cdot \mathbf{u} = a^2 + b^2 + c^2 \geq 0$ and $\mathbf{u} \cdot \mathbf{u} = 0$ iff $a = b = c = 0$.

23. $|\mathbf{u} + \mathbf{v}|^2 = (\mathbf{u} + \mathbf{v}) \cdot (\mathbf{u} + \mathbf{v}) = \mathbf{u} \cdot \mathbf{u} + 2\mathbf{u} \cdot \mathbf{v} + \mathbf{v} \cdot \mathbf{v} \leq |\mathbf{u}|^2 + 2|\mathbf{u}||\mathbf{v}| + |\mathbf{v}|^2 = (|\mathbf{u}| + |\mathbf{v}|)^2 \Rightarrow |\mathbf{u} + \mathbf{v}| \leq |\mathbf{u}| + |\mathbf{v}|$

24. Let α denote the angle between \mathbf{w} and \mathbf{u} , and β the angle between \mathbf{w} and \mathbf{v} . Let $a = |\mathbf{u}|$ and $b = |\mathbf{v}|$.

Then $\cos\alpha = \frac{\mathbf{w} \cdot \mathbf{u}}{|\mathbf{w}||\mathbf{u}|} = \frac{(a\mathbf{v} + b\mathbf{u}) \cdot \mathbf{u}}{|\mathbf{w}||\mathbf{u}|} = \frac{(a\mathbf{v} \cdot \mathbf{u} + b\mathbf{u} \cdot \mathbf{u})}{|\mathbf{w}||\mathbf{u}|} = \frac{(a\mathbf{v} \cdot \mathbf{u} + ba^2)}{|\mathbf{w}||\mathbf{u}|} = \frac{\mathbf{v} \cdot \mathbf{u} + ba}{|\mathbf{w}|}$, and likewise, $\cos\beta = \frac{\mathbf{u} \cdot \mathbf{v} + ba}{|\mathbf{w}|}$.

Since the angle between \mathbf{u} and \mathbf{v} is always $\leq \frac{\pi}{2}$ and $\cos\alpha = \cos\beta$, we have that $\alpha = \beta \Rightarrow \mathbf{w}$ bisects the angle between \mathbf{u} and \mathbf{v} .

25. $(|\mathbf{u}|\mathbf{v} + |\mathbf{v}|\mathbf{u}) \cdot (|\mathbf{v}|\mathbf{u} - |\mathbf{u}|\mathbf{v}) = |\mathbf{u}||\mathbf{v}| \cdot |\mathbf{v}||\mathbf{u}| + |\mathbf{v}||\mathbf{u}| \cdot |\mathbf{v}||\mathbf{u}| - |\mathbf{u}||\mathbf{v}| \cdot |\mathbf{u}|\mathbf{v} - |\mathbf{v}||\mathbf{u}| \cdot |\mathbf{u}|\mathbf{v}$
 $= |\mathbf{v}||\mathbf{u}| \cdot |\mathbf{u}|\mathbf{v} + |\mathbf{v}|^2 \mathbf{u} \cdot \mathbf{u} - |\mathbf{u}|^2 \mathbf{v} \cdot \mathbf{v} - |\mathbf{v}||\mathbf{u}| \cdot |\mathbf{u}|\mathbf{v} = |\mathbf{v}|^2|\mathbf{u}|^2 - |\mathbf{u}|^2|\mathbf{v}|^2 = 0$

CHAPTER 13 VECTOR-VALUED FUNCTIONS AND MOTION IN SPACE

13.1 CURVES IN SPACE AND THEIR TANGENTS

1. $x = t + 1$ and $y = t^2 - 1 \Rightarrow y = (x - 1)^2 - 1 = x^2 - 2x$; $\mathbf{v} = \frac{d\mathbf{r}}{dt} = \mathbf{i} + 2t\mathbf{j} \Rightarrow \mathbf{a} = \frac{d\mathbf{v}}{dt} = 2\mathbf{j} \Rightarrow \mathbf{v} = \mathbf{i} + 2\mathbf{j}$ and $\mathbf{a} = 2\mathbf{j}$ at $t = 1$

2. $x = \frac{t}{t+1}$ and $y = \frac{1}{t} \Rightarrow x = \frac{\frac{1}{y}}{\frac{1}{y} + 1} = \frac{1}{1+y} \Rightarrow y = \frac{1}{x} - 1$; $\mathbf{v} = \frac{d\mathbf{r}}{dt} = \frac{1}{(t+1)^2}\mathbf{i} - \frac{1}{t^2}\mathbf{j} \Rightarrow \mathbf{a} = \frac{d\mathbf{v}}{dt} = -\frac{2}{(t+1)^3}\mathbf{i} + \frac{2}{t^3}\mathbf{j}$
 $\Rightarrow \mathbf{v} = 4\mathbf{i} - 4\mathbf{j}$ and $\mathbf{a} = -16\mathbf{i} - 16\mathbf{j}$ at $t = -\frac{1}{2}$

3. $x = e^t$ and $y = \frac{2}{9}e^{2t} \Rightarrow y = \frac{2}{9}x^2$; $\mathbf{v} = \frac{d\mathbf{r}}{dt} = e^t\mathbf{i} + \frac{4}{9}e^{2t}\mathbf{j} \Rightarrow \mathbf{a} = e^t\mathbf{i} + \frac{8}{9}e^{2t}\mathbf{j} \Rightarrow \mathbf{v} = 3\mathbf{i} + 4\mathbf{j}$ and $\mathbf{a} = 3\mathbf{i} + 8\mathbf{j}$ at $t = \ln 3$

4. $x = \cos 2t$ and $y = 3 \sin 2t \Rightarrow x^2 + \frac{1}{9}y^2 = 1$; $\mathbf{v} = \frac{d\mathbf{r}}{dt} = (-2 \sin 2t)\mathbf{i} + (6 \cos 2t)\mathbf{j}$
 $\Rightarrow \mathbf{a} = \frac{d\mathbf{v}}{dt} = (-4 \cos 2t)\mathbf{i} + (-12 \sin 2t)\mathbf{j} \Rightarrow \mathbf{v} = 6\mathbf{j}$ and $\mathbf{a} = -4\mathbf{i}$ at $t = 0$

5. $\mathbf{v} = \frac{d\mathbf{r}}{dt} = (\cos t)\mathbf{i} - (\sin t)\mathbf{j}$ and $\mathbf{a} = \frac{d\mathbf{v}}{dt} = -(\sin t)\mathbf{i} - (\cos t)\mathbf{j}$
 \Rightarrow for $t = \frac{\pi}{4}$, $\mathbf{v}(\frac{\pi}{4}) = \frac{\sqrt{2}}{2}\mathbf{i} - \frac{\sqrt{2}}{2}\mathbf{j}$ and $\mathbf{a}(\frac{\pi}{4}) = -\frac{\sqrt{2}}{2}\mathbf{i} - \frac{\sqrt{2}}{2}\mathbf{j}$;
 for $t = \frac{\pi}{2}$, $\mathbf{v}(\frac{\pi}{2}) = -\mathbf{j}$ and $\mathbf{a}(\frac{\pi}{2}) = -\mathbf{i}$

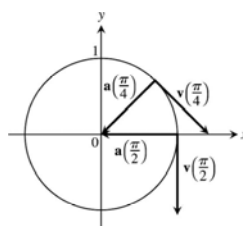

6. $\mathbf{v} = \frac{d\mathbf{r}}{dt} = (-2 \sin \frac{t}{2})\mathbf{i} + (2 \cos \frac{t}{2})\mathbf{j}$ and $\mathbf{a} = \frac{d\mathbf{v}}{dt} = (-\cos \frac{t}{2})\mathbf{i} + (-\sin \frac{t}{2})\mathbf{j}$
 \Rightarrow for $t = \pi$, $\mathbf{v}(\pi) = -2\mathbf{i}$ and $\mathbf{a}(\pi) = -\mathbf{j}$;
 for $t = \frac{3\pi}{2}$, $\mathbf{v}(\frac{3\pi}{2}) = -\sqrt{2}\mathbf{i} - \sqrt{2}\mathbf{j}$ and $\mathbf{a}(\frac{3\pi}{2}) = \frac{\sqrt{2}}{2}\mathbf{i} - \frac{\sqrt{2}}{2}\mathbf{j}$

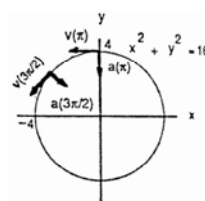

7. $\mathbf{v} = \frac{d\mathbf{r}}{dt} = (1 - \cos t)\mathbf{i} + (\sin t)\mathbf{j}$ and $\mathbf{a} = \frac{d\mathbf{v}}{dt} = (\sin t)\mathbf{i} + (\cos t)\mathbf{j}$
 \Rightarrow for $t = \pi$, $\mathbf{v}(\pi) = 2\mathbf{i}$ and $\mathbf{a}(\pi) = -\mathbf{j}$;
 for $t = \frac{3\pi}{2}$, $\mathbf{v}(\frac{3\pi}{2}) = \mathbf{i} - \mathbf{j}$ and $\mathbf{a}(\frac{3\pi}{2}) = -\mathbf{i}$

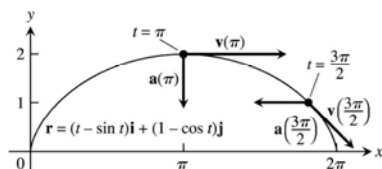

8. $\mathbf{v} = \frac{d\mathbf{r}}{dt} = \mathbf{i} + 2t\mathbf{j}$ and $\mathbf{a} = \frac{d\mathbf{v}}{dt} = 2\mathbf{j} \Rightarrow$ for $t = -1$, $\mathbf{v}(-1) = \mathbf{i} - 2\mathbf{j}$ and $\mathbf{a}(-1) = 2\mathbf{j}$; for $t = 0$, $\mathbf{v}(0) = \mathbf{i}$ and $\mathbf{a}(0) = 2\mathbf{j}$;
 for $t = 1$, $\mathbf{v}(1) = \mathbf{i} + 2\mathbf{j}$ and $\mathbf{a}(1) = 2\mathbf{j}$

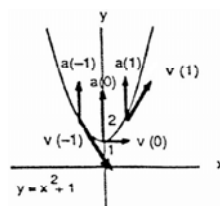

9. $\mathbf{r} = (t+1)\mathbf{i} + (t^2 - 1)\mathbf{j} + 2t\mathbf{k} \Rightarrow \mathbf{v} = \frac{d\mathbf{r}}{dt} = \mathbf{i} + 2t\mathbf{j} + 2\mathbf{k} \Rightarrow \mathbf{a} = \frac{d^2\mathbf{r}}{dt^2} = 2\mathbf{j}$; Speed: $|\mathbf{v}(1)| = \sqrt{1^2 + (2(1))^2 + 2^2} = 3$;
 Direction: $\frac{\mathbf{v}(1)}{|\mathbf{v}(1)|} = \frac{\mathbf{i} + 2(1)\mathbf{j} + 2\mathbf{k}}{3} = \frac{1}{3}\mathbf{i} + \frac{2}{3}\mathbf{j} + \frac{2}{3}\mathbf{k} \Rightarrow \mathbf{v}(1) = 3\left(\frac{1}{3}\mathbf{i} + \frac{2}{3}\mathbf{j} + \frac{2}{3}\mathbf{k}\right)$
10. $\mathbf{r} = (1+t)\mathbf{i} + \frac{t^2}{\sqrt{2}}\mathbf{j} + \frac{t^3}{3}\mathbf{k} \Rightarrow \mathbf{v} = \frac{d\mathbf{r}}{dt} = \mathbf{i} + \frac{2t}{\sqrt{2}}\mathbf{j} + t^2\mathbf{k} \Rightarrow \mathbf{a} = \frac{d^2\mathbf{r}}{dt^2} = \frac{2}{\sqrt{2}}\mathbf{j} + 2t\mathbf{k}$;
 Speed: $|\mathbf{v}(1)| = \sqrt{1^2 + \left(\frac{2(1)}{\sqrt{2}}\right)^2 + (1^2)^2} = 2$;
 Direction: $\frac{\mathbf{v}(1)}{|\mathbf{v}(1)|} = \frac{\mathbf{i} + \frac{2(1)}{\sqrt{2}}\mathbf{j} + (1^2)\mathbf{k}}{2} = \frac{1}{2}\mathbf{i} + \frac{1}{\sqrt{2}}\mathbf{j} + \frac{1}{2}\mathbf{k} \Rightarrow \mathbf{v}(1) = 2\left(\frac{1}{2}\mathbf{i} + \frac{1}{\sqrt{2}}\mathbf{j} + \frac{1}{2}\mathbf{k}\right)$
11. $\mathbf{r} = (2 \cos t)\mathbf{i} + (3 \sin t)\mathbf{j} + 4t\mathbf{k} \Rightarrow \mathbf{v} = \frac{d\mathbf{r}}{dt} = (-2 \sin t)\mathbf{i} + (3 \cos t)\mathbf{j} + 4\mathbf{k} \Rightarrow \mathbf{a} = \frac{d^2\mathbf{r}}{dt^2} = (-2 \cos t)\mathbf{i} - (3 \sin t)\mathbf{j}$;
 Speed: $|\mathbf{v}\left(\frac{\pi}{2}\right)| = \sqrt{(-2 \sin \frac{\pi}{2})^2 + (3 \cos \frac{\pi}{2})^2 + 4^2} = 2\sqrt{5}$;
 Direction: $\frac{\mathbf{v}\left(\frac{\pi}{2}\right)}{|\mathbf{v}\left(\frac{\pi}{2}\right)|} = \left(-\frac{2}{2\sqrt{5}} \sin \frac{\pi}{2}\right)\mathbf{i} + \left(\frac{3}{2\sqrt{5}} \cos \frac{\pi}{2}\right)\mathbf{j} + \frac{4}{2\sqrt{5}}\mathbf{k} = -\frac{1}{\sqrt{5}}\mathbf{i} + \frac{2}{\sqrt{5}}\mathbf{k} \Rightarrow \mathbf{v}\left(\frac{\pi}{2}\right) = 2\sqrt{5}\left(-\frac{1}{\sqrt{5}}\mathbf{i} + \frac{2}{\sqrt{5}}\mathbf{k}\right)$
12. $\mathbf{r} = (\sec t)\mathbf{i} + (\tan t)\mathbf{j} + \frac{4}{3}t\mathbf{k} \Rightarrow \mathbf{v} = \frac{d\mathbf{r}}{dt} = (\sec t \tan t)\mathbf{i} + (\sec^2 t)\mathbf{j} + \frac{4}{3}\mathbf{k}$
 $\Rightarrow \mathbf{a} = \frac{d^2\mathbf{r}}{dt^2} = (\sec t \tan^2 t + \sec^3 t)\mathbf{i} + (2 \sec^2 t \tan t)\mathbf{j}$;
 Speed: $|\mathbf{v}\left(\frac{\pi}{6}\right)| = \sqrt{(\sec \frac{\pi}{6} \tan \frac{\pi}{6})^2 + (\sec^2 \frac{\pi}{6})^2 + \left(\frac{4}{3}\right)^2} = 2$;
 Direction: $\frac{\mathbf{v}\left(\frac{\pi}{6}\right)}{|\mathbf{v}\left(\frac{\pi}{6}\right)|} = \frac{(\sec \frac{\pi}{6} \tan \frac{\pi}{6})\mathbf{i} + (\sec^2 \frac{\pi}{6})\mathbf{j} + \frac{4}{3}\mathbf{k}}{2} = \frac{1}{3}\mathbf{i} + \frac{2}{3}\mathbf{j} + \frac{2}{3}\mathbf{k} \Rightarrow \mathbf{v}\left(\frac{\pi}{6}\right) = 2\left(\frac{1}{3}\mathbf{i} + \frac{2}{3}\mathbf{j} + \frac{2}{3}\mathbf{k}\right)$
13. $\mathbf{r} = (2 \ln(t+1))\mathbf{i} + t^2\mathbf{j} + \frac{t^2}{2}\mathbf{k} \Rightarrow \mathbf{v} = \frac{d\mathbf{r}}{dt} = \left(\frac{2}{t+1}\right)\mathbf{i} + 2t\mathbf{j} + t\mathbf{k} \Rightarrow \mathbf{a} = \frac{d^2\mathbf{r}}{dt^2} = \left[\frac{-2}{(t+1)^2}\right]\mathbf{i} + 2\mathbf{j} + \mathbf{k}$;
 Speed: $|\mathbf{v}(1)| = \sqrt{\left(\frac{2}{1+1}\right)^2 + (2(1))^2 + 1^2} = \sqrt{6}$;
 Direction: $\frac{\mathbf{v}(1)}{|\mathbf{v}(1)|} = \frac{\left(\frac{2}{1+1}\right)\mathbf{i} + 2(1)\mathbf{j} + (1)\mathbf{k}}{\sqrt{6}} = \frac{1}{\sqrt{6}}\mathbf{i} + \frac{2}{\sqrt{6}}\mathbf{j} + \frac{1}{\sqrt{6}}\mathbf{k} \Rightarrow \mathbf{v}(1) = \sqrt{6}\left(\frac{1}{\sqrt{6}}\mathbf{i} + \frac{2}{\sqrt{6}}\mathbf{j} + \frac{1}{\sqrt{6}}\mathbf{k}\right)$
14. $\mathbf{r} = (e^{-t})\mathbf{i} + (2 \cos 3t)\mathbf{j} + (2 \sin 3t)\mathbf{k} \Rightarrow \mathbf{v} = \frac{d\mathbf{r}}{dt} = (-e^{-t})\mathbf{i} - (6 \sin 3t)\mathbf{j} + (6 \cos 3t)\mathbf{k}$
 $\Rightarrow \mathbf{a} = \frac{d^2\mathbf{r}}{dt^2} = (e^{-t})\mathbf{i} - (18 \cos 3t)\mathbf{j} - (18 \sin 3t)\mathbf{k}$;
 Speed: $|\mathbf{v}(0)| = \sqrt{(-e^0)^2 + (-6 \sin 3(0))^2 + (6 \cos 3(0))^2} = \sqrt{37}$;
 Direction: $\frac{\mathbf{v}(0)}{|\mathbf{v}(0)|} = \frac{(-e^0)\mathbf{i} - 6 \sin 3(0)\mathbf{j} + 6 \cos 3(0)\mathbf{k}}{\sqrt{37}} = -\frac{1}{\sqrt{37}}\mathbf{i} + \frac{6}{\sqrt{37}}\mathbf{k} \Rightarrow \mathbf{v}(0) = \sqrt{37}\left(-\frac{1}{\sqrt{37}}\mathbf{i} + \frac{6}{\sqrt{37}}\mathbf{k}\right)$
15. $\mathbf{v} = 3\mathbf{i} + \sqrt{3}\mathbf{j} + 2t\mathbf{k}$ and $\mathbf{a} = 2\mathbf{k} \Rightarrow \mathbf{v}(0) = 3\mathbf{i} + \sqrt{3}\mathbf{j}$ and $\mathbf{a}(0) = 2\mathbf{k} \Rightarrow |\mathbf{v}(0)| = \sqrt{3^2 + (\sqrt{3})^2 + 0^2} = \sqrt{12}$ and
 $|\mathbf{a}(0)| = \sqrt{2^2} = 2$; $\mathbf{v}(0) \cdot \mathbf{a}(0) = 0 \Rightarrow \cos \theta = 0 \Rightarrow \theta = \frac{\pi}{2}$

16. $\mathbf{v} = \frac{\sqrt{2}}{2}\mathbf{i} + \left(\frac{\sqrt{2}}{2} - 32t\right)\mathbf{j}$ and $\mathbf{a} = -32\mathbf{j} \Rightarrow \mathbf{v}(0) = \frac{\sqrt{2}}{2}\mathbf{i} + \frac{\sqrt{2}}{2}\mathbf{j}$ and $\mathbf{a}(0) = -32\mathbf{j} \Rightarrow |\mathbf{v}(0)| = \sqrt{\left(\frac{\sqrt{2}}{2}\right)^2 + \left(\frac{\sqrt{2}}{2}\right)^2} = 1$ and $|\mathbf{a}(0)| = \sqrt{(-32)^2} = 32; \mathbf{v}(0) \cdot \mathbf{a}(0) = \left(\frac{\sqrt{2}}{2}\right)(-32) = -16\sqrt{2} \Rightarrow \cos \theta = \frac{-16\sqrt{2}}{1(32)} = -\frac{\sqrt{2}}{2} \Rightarrow \theta = \frac{3\pi}{4}$
17. $\mathbf{v} = \left(\frac{2t}{t^2+1}\right)\mathbf{i} + \left(\frac{1}{t^2+1}\right)\mathbf{j} + t(t^2+1)^{-1/2}\mathbf{k}$ and $\mathbf{a} = \left[\frac{-2t^2+2}{(t^2+1)^2}\right]\mathbf{i} - \left[\frac{2t}{(t^2+1)^2}\right]\mathbf{j} + \left[\frac{1}{(t^2+1)^{3/2}}\right]\mathbf{k} \Rightarrow \mathbf{v}(0) = \mathbf{j}$ and $\mathbf{a}(0) = 2\mathbf{i} + \mathbf{k} \Rightarrow |\mathbf{v}(0)| = 1$ and $|\mathbf{a}(0)| = \sqrt{2^2 + 1^2} = \sqrt{5}; \mathbf{v}(0) \cdot \mathbf{a}(0) = 0 \Rightarrow \cos \theta = 0 \Rightarrow \theta = \frac{\pi}{2}$
18. $\mathbf{v} = \frac{2}{3}(1+t)^{1/2}\mathbf{i} - \frac{2}{3}(1-t)^{1/2}\mathbf{j} + \frac{1}{3}\mathbf{k}$ and $\mathbf{a} = \frac{1}{3}(1+t)^{-1/2}\mathbf{i} + \frac{1}{3}(1-t)^{-1/2}\mathbf{j} \Rightarrow \mathbf{v}(0) = \frac{2}{3}\mathbf{i} - \frac{2}{3}\mathbf{j} + \frac{1}{3}\mathbf{k}$ and $\mathbf{a}(0) = \frac{1}{3}\mathbf{i} + \frac{1}{3}\mathbf{j} \Rightarrow |\mathbf{v}(0)| = \sqrt{\left(\frac{2}{3}\right)^2 + \left(-\frac{2}{3}\right)^2 + \left(\frac{1}{3}\right)^2} = 1$ and $|\mathbf{a}(0)| = \sqrt{\left(\frac{1}{3}\right)^2 + \left(\frac{1}{3}\right)^2} = \frac{\sqrt{2}}{3}; \mathbf{v}(0) \cdot \mathbf{a}(0) = \frac{2}{9} - \frac{2}{9} = 0 \Rightarrow \cos \theta = 0 \Rightarrow \theta = \frac{\pi}{2}$
19. $\mathbf{r}(t) = (\sin t)\mathbf{i} + (t^2 - \cos t)\mathbf{j} + e^t\mathbf{k} \Rightarrow \mathbf{v}(t) = (\cos t)\mathbf{i} + (2t + \sin t)\mathbf{j} + e^t\mathbf{k}; t_0 = 0 \Rightarrow \mathbf{v}(t_0) = \mathbf{i} + \mathbf{k}$ and $\mathbf{r}(t_0) = P_0 = (0, -1, 1) \Rightarrow x = 0 + t = t, y = -1, \text{ and } z = 1 + t$ are parametric equations of the tangent line
20. $\mathbf{r}(t) = t^2\mathbf{i} + (2t-1)\mathbf{j} + t^3\mathbf{k} \Rightarrow \mathbf{v}(t) = 2t\mathbf{i} + 2\mathbf{j} + 3t^2\mathbf{k}; t_0 = 2 \Rightarrow \mathbf{v}(2) = 4\mathbf{i} + 2\mathbf{j} + 12\mathbf{k}$ and $\mathbf{r}(t_0) = P_0 = (4, 3, 8) \Rightarrow x = 4 + 4t, y = 3 + 2t, \text{ and } z = 8 + 12t$ are parametric equations of the tangent line
21. $\mathbf{r}(t) = (\ln t)\mathbf{i} + \frac{t-1}{t+2}\mathbf{j} + (t \ln t)\mathbf{k} \Rightarrow \mathbf{v}(t) = \frac{1}{t}\mathbf{i} + \frac{3}{(t+2)^2}\mathbf{j} + (\ln t + 1)\mathbf{k}; t_0 = 1 \Rightarrow \mathbf{v}(1) = \mathbf{i} + \frac{1}{3}\mathbf{j} + \mathbf{k}$ and $\mathbf{r}(t_0) = P_0 = (0, 0, 0) \Rightarrow x = 0 + t = t, y = 0 + \frac{1}{3}t = \frac{1}{3}t, \text{ and } z = 0 + t = t$ are parametric equations of the tangent line
22. $\mathbf{r}(t) = (\cos t)\mathbf{i} + (\sin t)\mathbf{j} + (\sin 2t)\mathbf{k} \Rightarrow \mathbf{v}(t) = (-\sin t)\mathbf{i} + (\cos t)\mathbf{j} + (2 \cos 2t)\mathbf{k}; t_0 = \frac{\pi}{2} \Rightarrow \mathbf{v}(t_0) = -\mathbf{i} - 2\mathbf{k}$ and $\mathbf{r}(t_0) = P_0 = (0, 1, 0) \Rightarrow x = 0 - t = -t, y = 1, \text{ and } z = 0 - 2t = -2t$ are parametric equations of the tangent line
23. (a) $\mathbf{v}(t) = -(\sin t)\mathbf{i} + (\cos t)\mathbf{j} \Rightarrow \mathbf{a}(t) = -(\cos t)\mathbf{i} - (\sin t)\mathbf{j};$
 (i) $|\mathbf{v}(t)| = \sqrt{(-\sin t)^2 + (\cos t)^2} = 1 \Rightarrow$ constant speed;
 (ii) $\mathbf{v} \cdot \mathbf{a} = (\sin t)(\cos t) - (\cos t)(\sin t) = 0 \Rightarrow$ yes, orthogonal;
 (iii) counterclockwise movement;
 (iv) yes, $\mathbf{r}(0) = \mathbf{i} + 0\mathbf{j}$
- (b) $\mathbf{v}(t) = -(2 \sin 2t)\mathbf{i} + (2 \cos 2t)\mathbf{j} \Rightarrow \mathbf{a}(t) = -(4 \cos 2t)\mathbf{i} - (4 \sin 2t)\mathbf{j};$
 (i) $|\mathbf{v}(t)| = \sqrt{4 \sin^2 2t + 4 \cos^2 2t} = 2 \Rightarrow$ constant speed;
 (ii) $\mathbf{v} \cdot \mathbf{a} = 8 \sin 2t \cos 2t - 8 \cos 2t \sin 2t = 0 \Rightarrow$ yes, orthogonal;
 (iii) counterclockwise movement;
 (iv) yes, $\mathbf{r}(0) = \mathbf{i} + 0\mathbf{j}$
- (c) $\mathbf{v}(t) = -\sin\left(t - \frac{\pi}{2}\right)\mathbf{i} + \cos\left(t - \frac{\pi}{2}\right)\mathbf{j} \Rightarrow \mathbf{a}(t) = -\cos\left(t - \frac{\pi}{2}\right)\mathbf{i} - \sin\left(t - \frac{\pi}{2}\right)\mathbf{j};$
 (i) $|\mathbf{v}(t)| = \sqrt{\sin^2\left(t - \frac{\pi}{2}\right) + \cos^2\left(t - \frac{\pi}{2}\right)} = 1 \Rightarrow$ constant speed;

- (ii) $\mathbf{v} \cdot \mathbf{a} = \sin\left(t - \frac{\pi}{2}\right) \cos\left(t - \frac{\pi}{2}\right) - \cos\left(t - \frac{\pi}{2}\right) \sin\left(t - \frac{\pi}{2}\right) = 0 \Rightarrow$ yes, orthogonal;
 - (iii) counterclockwise movement;
 - (iv) no, $\mathbf{r}(0) = 0\mathbf{i} - \mathbf{j}$ instead of $\mathbf{i} + 0\mathbf{j}$
- (d) $\mathbf{v}(t) = -(\sin t)\mathbf{i} - (\cos t)\mathbf{j} \Rightarrow \mathbf{a}(t) = -(\cos t)\mathbf{i} + (\sin t)\mathbf{j}$;
- (i) $|\mathbf{v}(t)| = \sqrt{(-\sin t)^2 + (-\cos t)^2} = 1 \Rightarrow$ constant speed;
 - (ii) $\mathbf{v} \cdot \mathbf{a} = (\sin t)(\cos t) - (\cos t)(\sin t) = 0 \Rightarrow$ yes, orthogonal;
 - (iii) clockwise movement;
 - (iv) yes, $\mathbf{r}(0) = \mathbf{i} - 0\mathbf{j}$
- (e) $\mathbf{v}(t) = -(2t \sin t)\mathbf{i} + (2t \cos t)\mathbf{j} \Rightarrow \mathbf{a}(t) = -(2 \sin t + 2t \cos t)\mathbf{i} + (2 \cos t - 2t \sin t)\mathbf{j}$;
- (i) $|\mathbf{v}(t)| = \sqrt{(-2t \sin t)^2 + (2t \cos t)^2} = \sqrt{4t^2(\sin^2 t + \cos^2 t)} = 2|t| = 2t, t \geq 0 \Rightarrow$ variable speed;
 - (ii) $\mathbf{v} \cdot \mathbf{a} = 4(t \sin^2 t + t^2 \sin t \cos t) + 4(t \cos^2 t - t^2 \cos t \sin t) = 4t \neq 0$ in general \Rightarrow not orthogonal in general;
 - (iii) counterclockwise movement;
 - (iv) yes, $\mathbf{r}(0) = \mathbf{i} + 0\mathbf{j}$

24. Let $\mathbf{p} = 2\mathbf{i} + 2\mathbf{j} + \mathbf{k}$ denote the position vector of the point $(2, 2, 1)$ and let, $\mathbf{u} = \frac{1}{\sqrt{2}}\mathbf{i} - \frac{1}{\sqrt{2}}\mathbf{j}$ and $\mathbf{v} = \frac{1}{\sqrt{3}}\mathbf{i} + \frac{1}{\sqrt{3}}\mathbf{j} + \frac{1}{\sqrt{3}}\mathbf{k}$. Then $\mathbf{r}(t) = \mathbf{p} + (\cos t)\mathbf{u} + (\sin t)\mathbf{v}$. Note that $(2, 2, 1)$ is a point on the plane and $\mathbf{n} = \mathbf{i} + \mathbf{j} - 2\mathbf{k}$ is normal to the plane. Moreover, \mathbf{u} and \mathbf{v} are orthogonal unit vectors with $\mathbf{u} \cdot \mathbf{n} = \mathbf{v} \cdot \mathbf{n} = 0 \Rightarrow \mathbf{u}$ and \mathbf{v} are parallel to the plane. Therefore, $\mathbf{r}(t)$ identifies a point that lies in the plane for each t . Also, for each t , $(\cos t)\mathbf{u} + (\sin t)\mathbf{v}$ is a unit vector. Starting at the point $(2 + \frac{1}{\sqrt{2}}, 2 - \frac{1}{\sqrt{2}}, 1)$ the vector $\mathbf{r}(t)$ traces out a circle of radius 1 and center $(2, 2, 1)$ in the plane $x + y - 2z = 2$.

25. The velocity vector is tangent to the graph of $y^2 = 2x$ at the point $(2, 2)$, has length 5, and a positive \mathbf{i} component. Now, $y^2 = 2x \Rightarrow 2y \frac{dy}{dx} = 2 \Rightarrow \frac{dy}{dx}\bigg|_{(2,2)} = \frac{2}{2 \cdot 2} = \frac{1}{2} \Rightarrow$ the tangent vector lies in the direction of the vector $\mathbf{i} + \frac{1}{2}\mathbf{j} \Rightarrow$ the velocity vector is $\mathbf{v} = \frac{5}{\sqrt{1 + \frac{1}{4}}}(\mathbf{i} + \frac{1}{2}\mathbf{j}) = \frac{5}{(\frac{\sqrt{5}}{2})}(\mathbf{i} + \frac{1}{2}\mathbf{j}) = 2\sqrt{5}\mathbf{i} + \sqrt{5}\mathbf{j}$

26. (a)

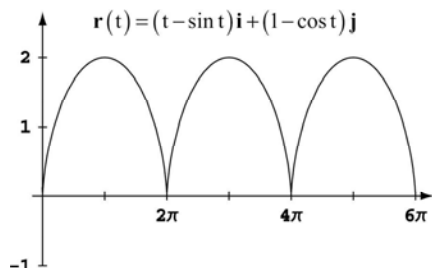

- (b) $\mathbf{v} = (1 - \cos t)\mathbf{i} + (\sin t)\mathbf{j}$ and $\mathbf{a} = (\sin t)\mathbf{i} + (\cos t)\mathbf{j}$; $|\mathbf{v}|^2 = (1 - \cos t)^2 + \sin^2 t = 2 - 2 \cos t \Rightarrow |\mathbf{v}|^2$ is at a max when $\cos t = -1 \Rightarrow t = \pi, 3\pi, 5\pi$, etc., and at these values of t , $|\mathbf{v}|^2 = 4 \Rightarrow \max |\mathbf{v}| = \sqrt{4} = 2$; $|\mathbf{v}|^2$ is at a min when $\cos t = 1 \Rightarrow t = 0, 2\pi, 4\pi$, etc., and at these values of t , $|\mathbf{v}|^2 = 0 \Rightarrow \min |\mathbf{v}| = 0$;
- $|\mathbf{a}|^2 = \sin^2 t + \cos^2 t = 1$ for every $t \Rightarrow \max |\mathbf{a}| = \min |\mathbf{a}| = \sqrt{1} = 1$

27. $\frac{d}{dt}(\mathbf{r} \cdot \mathbf{r}) = \mathbf{r} \cdot \frac{d\mathbf{r}}{dt} + \frac{d\mathbf{r}}{dt} \cdot \mathbf{r} = 2\mathbf{r} \cdot \frac{d\mathbf{r}}{dt} = 2 \cdot 0 = 0 \Rightarrow \mathbf{r} \cdot \mathbf{r}$ is a constant $\Rightarrow |\mathbf{r}| = \sqrt{\mathbf{r} \cdot \mathbf{r}}$ is constant

28. (a) $\frac{d}{dt}(\mathbf{u} \cdot \mathbf{v} \times \mathbf{w}) = \frac{d\mathbf{u}}{dt} \cdot (\mathbf{v} \times \mathbf{w}) + \mathbf{u} \cdot \frac{d}{dt}(\mathbf{v} \times \mathbf{w}) = \frac{d\mathbf{u}}{dt} \cdot (\mathbf{v} \times \mathbf{w}) + \mathbf{u} \cdot \left(\frac{d\mathbf{v}}{dt} \times \mathbf{w} + \mathbf{v} \times \frac{d\mathbf{w}}{dt} \right)$
 $= \frac{d\mathbf{u}}{dt} \cdot (\mathbf{v} \times \mathbf{w}) + \mathbf{u} \cdot \frac{d\mathbf{v}}{dt} \times \mathbf{w} + \mathbf{u} \cdot \mathbf{v} \times \frac{d\mathbf{w}}{dt}$

(b) $\frac{d}{dt} \left[\mathbf{r} \cdot \left(\frac{d\mathbf{r}}{dt} \times \frac{d^2\mathbf{r}}{dt^2} \right) \right] = \frac{d\mathbf{r}}{dt} \cdot \left(\frac{d\mathbf{r}}{dt} \times \frac{d^2\mathbf{r}}{dt^2} \right) + \mathbf{r} \cdot \left(\frac{d^2\mathbf{r}}{dt^2} \times \frac{d^2\mathbf{r}}{dt^2} \right) + \mathbf{r} \cdot \left(\frac{d\mathbf{r}}{dt} \times \frac{d^3\mathbf{r}}{dt^3} \right) = \mathbf{r} \cdot \left(\frac{d\mathbf{r}}{dt} \times \frac{d^3\mathbf{r}}{dt^3} \right)$, since $\mathbf{A} \cdot (\mathbf{A} \times \mathbf{B}) = 0$
 and $\mathbf{A} \cdot (\mathbf{B} \times \mathbf{B}) = 0$ for any vectors \mathbf{A} and \mathbf{B}

29. (a) $\mathbf{u} = f(t)\mathbf{i} + g(t)\mathbf{j} + h(t)\mathbf{k} \Rightarrow c\mathbf{u} = cf(t)\mathbf{i} + cg(t)\mathbf{j} + ch(t)\mathbf{k} \Rightarrow \frac{d}{dt}(c\mathbf{u}) = c \frac{df}{dt}\mathbf{i} + c \frac{dg}{dt}\mathbf{j} + c \frac{dh}{dt}\mathbf{k}$
 $= c \left(\frac{df}{dt}\mathbf{i} + \frac{dg}{dt}\mathbf{j} + \frac{dh}{dt}\mathbf{k} \right) = c \frac{d\mathbf{u}}{dt}$

(b) $\mathbf{u} = x(t)\mathbf{i} + y(t)\mathbf{j} + z(t)\mathbf{k} \Rightarrow f(t)\mathbf{u} = f(t)x(t)\mathbf{i} + f(t)y(t)\mathbf{j} + f(t)z(t)\mathbf{k}$
 $\Rightarrow \frac{d}{dt}(f(t)\mathbf{u}) = \left[\frac{df}{dt}x(t) + f(t)\frac{dx}{dt} \right] \mathbf{i} + \left[\frac{df}{dt}y(t) + f(t)\frac{dy}{dt} \right] \mathbf{j} + \left[\frac{df}{dt}z(t) + f(t)\frac{dz}{dt} \right] \mathbf{k}$
 $= \frac{df}{dt} [x(t)\mathbf{i} + y(t)\mathbf{j} + z(t)\mathbf{k}] + f(t) \left[\frac{dx}{dt}\mathbf{i} + \frac{dy}{dt}\mathbf{j} + \frac{dz}{dt}\mathbf{k} \right] = \frac{df}{dt}\mathbf{u} + f(t) \frac{d\mathbf{u}}{dt}$

30. Let $\mathbf{u} = f_1(t)\mathbf{i} + f_2(t)\mathbf{j} + f_3(t)\mathbf{k}$ and $\mathbf{v} = g_1(t)\mathbf{i} + g_2(t)\mathbf{j} + g_3(t)\mathbf{k}$.

Then $\mathbf{u} + \mathbf{v} = [f_1(t) + g_1(t)]\mathbf{i} + [f_2(t) + g_2(t)]\mathbf{j} + [f_3(t) + g_3(t)]\mathbf{k}$
 $\Rightarrow \frac{d}{dt}(\mathbf{u} + \mathbf{v}) = [f_1'(t) + g_1'(t)]\mathbf{i} + [f_2'(t) + g_2'(t)]\mathbf{j} + [f_3'(t) + g_3'(t)]\mathbf{k}$
 $= [f_1'(t)\mathbf{i} + f_2'(t)\mathbf{j} + f_3'(t)\mathbf{k}] + [g_1'(t)\mathbf{i} + g_2'(t)\mathbf{j} + g_3'(t)\mathbf{k}] = \frac{d\mathbf{u}}{dt} + \frac{d\mathbf{v}}{dt}$;
 $\mathbf{u} - \mathbf{v} = [f_1(t) - g_1(t)]\mathbf{i} + [f_2(t) - g_2(t)]\mathbf{j} + [f_3(t) - g_3(t)]\mathbf{k}$
 $\Rightarrow \frac{d}{dt}(\mathbf{u} - \mathbf{v}) = [f_1'(t) - g_1'(t)]\mathbf{i} + [f_2'(t) - g_2'(t)]\mathbf{j} + [f_3'(t) - g_3'(t)]\mathbf{k}$
 $= [f_1'(t)\mathbf{i} + f_2'(t)\mathbf{j} + f_3'(t)\mathbf{k}] - [g_1'(t)\mathbf{i} + g_2'(t)\mathbf{j} + g_3'(t)\mathbf{k}] = \frac{d\mathbf{u}}{dt} - \frac{d\mathbf{v}}{dt}$

31. Suppose \mathbf{r} is continuous at $t = t_0$. Then $\lim_{t \rightarrow t_0} \mathbf{r}(t) = \mathbf{r}(t_0) \Leftrightarrow \lim_{t \rightarrow t_0} [f(t)\mathbf{i} + g(t)\mathbf{j} + h(t)\mathbf{k}]$
 $= f(t_0)\mathbf{i} + g(t_0)\mathbf{j} + h(t_0)\mathbf{k} \Leftrightarrow \lim_{t \rightarrow t_0} f(t) = f(t_0), \lim_{t \rightarrow t_0} g(t) = g(t_0), \text{ and } \lim_{t \rightarrow t_0} h(t) = h(t_0) \Leftrightarrow f, g, \text{ and } h$ are
 continuous at $t = t_0$.

32. $\lim_{t \rightarrow t_0} [\mathbf{r}_1(t) \times \mathbf{r}_2(t)] = \lim_{t \rightarrow t_0} \begin{vmatrix} \mathbf{i} & \mathbf{j} & \mathbf{k} \\ f_1(t) & f_2(t) & f_3(t) \\ g_1(t) & g_2(t) & g_3(t) \end{vmatrix} = \begin{vmatrix} \mathbf{i} & \mathbf{j} & \mathbf{k} \\ \lim_{t \rightarrow t_0} f_1(t) & \lim_{t \rightarrow t_0} f_2(t) & \lim_{t \rightarrow t_0} f_3(t) \\ \lim_{t \rightarrow t_0} g_1(t) & \lim_{t \rightarrow t_0} g_2(t) & \lim_{t \rightarrow t_0} g_3(t) \end{vmatrix} = \lim_{t \rightarrow t_0} \mathbf{r}_1(t) \times \lim_{t \rightarrow t_0} \mathbf{r}_2(t)$
 $= \mathbf{A} \times \mathbf{B}$

33. $r'(t_0)$ exists $\Rightarrow f'(t_0)\mathbf{i} + g'(t_0)\mathbf{j} + h'(t_0)\mathbf{k}$ exists $\Rightarrow f'(t_0), g'(t_0), h'(t_0)$ all exist $\Rightarrow f, g, \text{ and } h$ are
 continuous at $t = t_0 \Rightarrow \mathbf{r}(t)$ is continuous at $t = t_0$

$$34. \quad \mathbf{u} = \mathbf{C} = a\mathbf{i} + b\mathbf{j} + c\mathbf{k} \text{ with } a, b, c \text{ real constants} \Rightarrow \frac{d\mathbf{u}}{dt} = \frac{da}{dt}\mathbf{i} + \frac{db}{dt}\mathbf{j} + \frac{dc}{dt}\mathbf{k} = 0\mathbf{i} + 0\mathbf{j} + 0\mathbf{k} = \mathbf{0}$$

35-38. Example CAS commands:

Maple:

```
> with( plots );
r := t -> [sin(t)-t*cos(t),cos(t)+t*sin(t),t^2];
t0 := 3*Pi/2;
l0 := 0;
hi := 6*Pi;
P1 := spacecurve( r(t), t=l0..hi, axes=boxed, thickness=3 ):
display( P1, title="#35(a) (Section 13.1)" );
Dr := unapply( diff(r(t),t), t );           # (b)
Dr(t0);                                   # (c)
q1 := expand( r(t0) + Dr(t0)*(t-t0) );
T := unapply( q1, t );
P2 := spacecurve( T(t), t=l0..hi, axes=boxed, thickness=3, color=black ):
display( [P1,P2], title="#35(d) (Section 13.1)" );
```

39-40. Example CAS commands:

Maple:

```
a := 'a'; b := 'b';
r := (a,b,t) -> [cos(a*t),sin(a*t),b*t];
Dr := unapply( diff(r(a,b,t),t), (a,b,t) );
t0 := 3*Pi/2;
q1 := expand( r(a,b,t0) + Dr(a,b,t0)*(t-t0) );
T := unapply( q1, (a,b,t) );
l0 := 0;
hi := 4*Pi;
P := NULL:
for a in [ 1, 2, 4, 6 ] do
    P1 := spacecurve( r(a,1,t), t=l0..hi, thickness=3 ):
    P2 := spacecurve( T(a,1,t), t=l0..hi, thickness=3, color=black ):
    P := P, display( [P1,P2], axes=boxed, title=sprintf("#39 (Section 13.1)\n a=%a",a) );
end do:
display( [P], insequence=true );
```

35-40. Example CAS commands:

Mathematica: (assigned functions, parameters, and intervals will vary)

The x-y-z components for the curve are entered as a list of functions of t. The unit vectors \mathbf{i} , \mathbf{j} , \mathbf{k} are not inserted.

If a graph is too small, highlight it and drag out a corner or side to make it larger.

Only the components of $\mathbf{r}[t]$ and values for t_0 , t_{\min} , and t_{\max} require alteration for each problem.

```
Clear[r, v, t, x, y, z]
```

```
r[t_]= { Sin[t] - t Cos[t], Cos[t] + t Sin[t], t^2 }
```

```
t0= 3π/2; tmin= 0; tmax= 6π;
```

```
ParametricPlot3D[Evaluate[r[t]], {t, tmin, tmax}, AxesLabel -> {x, y, z}];
```

```
v[t_]= r'[t]
```

```
tanline[t_]= v[t0]t + r[t0]
```

```
ParametricPlot3D[Evaluate[{r[t], tanline[t]}], {t, tmin, tmax}, AxesLabel -> {x, y, z}];
```

For 39 and 40, the curve can be defined as a function of t, a, and b. Leave a space between a and t and b and t.

```
Clear[r, v, t, x, y, z, a, b]
```

```
r[t_,a_,b_]= { Cos[a t], Sin[a t], b t }
```

```
t0= 3π/2; tmin= 0; tmax= 4π;
```

```
v[t_,a_,b_]= D[r[t, a, b], t]
```

```
tanline[t_,a_,b_]= v[t0, a, b]t + r[t0, a, b]
```

```
pa1=ParametricPlot3D[Evaluate[{r[t, 1, 1], tanline[t, 1, 1]}], {t,tmin, tmax}, AxesLabel -> {x, y, z}];
```

```
pa2=ParametricPlot3D[Evaluate[{r[t, 2, 1], tanline[t, 2, 1]}], {t,tmin, tmax}, AxesLabel -> {x, y, z}];
```

```
pa4=ParametricPlot3D[Evaluate[{r[t, 4, 1], tanline[t, 4, 1]}], {t,tmin, tmax}, AxesLabel -> {x, y, z}];
```

```
pa6=ParametricPlot3D[Evaluate[{r[t, 6, 1], tanline[t, 6, 1]}], {t,tmin, tmax}, AxesLabel -> {x, y, z}];
```

```
Show[GraphicsRow[{pa1, pa2, pa4, pa6}]]
```

13.2 INTEGRALS OF VECTOR FUNCTIONS; PROJECTILE MOTION

- $$\int_0^1 [t^3 \mathbf{i} + 7\mathbf{j} + (t+1)\mathbf{k}] dt = \left[\frac{t^4}{4} \right]_0^1 \mathbf{i} + [7t]_0^1 \mathbf{j} + \left[\frac{t^2}{2} + t \right]_0^1 \mathbf{k} = \frac{1}{4} \mathbf{i} + 7\mathbf{j} + \frac{3}{2} \mathbf{k}$$
- $$\int_1^2 [(6-6t)\mathbf{i} + 3\sqrt{t}\mathbf{j} + \left(\frac{4}{t^2}\right)\mathbf{k}] dt = [6t - 3t^2]_1^2 \mathbf{i} + [2t^{3/2}]_1^2 \mathbf{j} + [-4t^{-1}]_1^2 \mathbf{k} = -3\mathbf{i} + (4\sqrt{2} - 2)\mathbf{j} + 2\mathbf{k}$$
- $$\int_{-\pi/4}^{\pi/4} [(\sin t)\mathbf{i} + (1 + \cos t)\mathbf{j} + (\sec^2 t)\mathbf{k}] dt = [-\cos t]_{-\pi/4}^{\pi/4} \mathbf{i} + [t + \sin t]_{-\pi/4}^{\pi/4} \mathbf{j} + [\tan t]_{-\pi/4}^{\pi/4} \mathbf{k} = \left(\frac{\pi+2\sqrt{2}}{2}\right)\mathbf{j} + 2\mathbf{k}$$
- $$\int_0^{\pi/3} [(\sec t \tan t)\mathbf{i} + (\tan t)\mathbf{j} + (2 \sin t \cos t)\mathbf{k}] dt = \int_0^{\pi/3} [(\sec t \tan t)\mathbf{i} + (\tan t)\mathbf{j} + (\sin 2t)\mathbf{k}] dt$$

$$= [\sec t]_0^{\pi/3} \mathbf{i} + [-\ln(\cos t)]_0^{\pi/3} \mathbf{j} + \left[-\frac{1}{2} \cos 2t\right]_0^{\pi/3} \mathbf{k} = \mathbf{i} + (\ln 2)\mathbf{j} + \frac{3}{4} \mathbf{k}$$
- $$\int_1^4 \left(\frac{1}{t}\mathbf{i} + \frac{1}{5-t}\mathbf{j} + \frac{1}{2t}\mathbf{k}\right) dt = [\ln t]_1^4 \mathbf{i} + [-\ln(5-t)]_1^4 \mathbf{j} + \left[\frac{1}{2} \ln t\right]_1^4 \mathbf{k} = (\ln 4)\mathbf{i} + (\ln 4)\mathbf{j} + (\ln 2)\mathbf{k}$$

6. $\int_0^1 \left(\frac{2}{\sqrt{1-t^2}} \mathbf{i} + \frac{\sqrt{3}}{1+t^2} \mathbf{k} \right) dt = \left[2 \sin^{-1} t \right]_0^1 \mathbf{i} + \left[\sqrt{3} \tan^{-1} t \right]_0^1 \mathbf{k} = \pi \mathbf{i} + \frac{\pi\sqrt{3}}{4} \mathbf{k}$
7. $\int_0^1 (te^t \mathbf{i} + e^{-t} \mathbf{j} + \mathbf{k}) dt = \left[\frac{1}{2} e^{2t} \right]_0^1 \mathbf{i} - \left[e^{-t} \right]_0^1 \mathbf{j} + [t]_0^1 \mathbf{k} = \frac{e-1}{2} \mathbf{i} + \frac{e-1}{e} \mathbf{j} + \mathbf{k}$
8. $\int_1^{\ln 3} (te^t \mathbf{i} + e^t \mathbf{j} + \ln t \mathbf{k}) dt = \left[te^t - e^t \right]_1^{\ln 3} \mathbf{i} - \left[e^t \right]_1^{\ln 3} \mathbf{j} + [t \ln t - t]_1^{\ln 3} \mathbf{k}$
 $= 3(\ln 3 - 1) \mathbf{i} + (3 - e) \mathbf{j} + (\ln 3(\ln(\ln 3) - 1) + 1) \mathbf{k}$
9. $\int_0^{\pi/2} [(\cos t) \mathbf{i} - (\sin 2t) \mathbf{j} + (\sin^2 t) \mathbf{k}] dt = \int_0^{\pi/2} [(\cos t) \mathbf{i} - (\sin 2t) \mathbf{j} + (\frac{1}{2} - \frac{1}{2} \cos 2t) \mathbf{k}] dt$
 $= [\sin t]_0^{\pi/2} \mathbf{i} + \left[\frac{1}{2} \cos t \right]_0^{\pi/2} \mathbf{j} + \left[\frac{1}{2} t - \frac{1}{4} \sin 2t \right]_0^{\pi/2} \mathbf{k} = \mathbf{i} - \mathbf{j} + \frac{\pi}{4} \mathbf{k}$
10. $\int_0^{\pi/4} [(\sec t) \mathbf{i} + (\tan^2 t) \mathbf{j} - (t \sin t) \mathbf{k}] dt = \int_0^{\pi/4} [(\sec t) \mathbf{i} + (\sec^2 t - 1) \mathbf{j} - (t \sin t) \mathbf{k}] dt$
 $= [\ln(\sec t + \tan t)]_0^{\pi/4} \mathbf{i} + [\tan t - t]_0^{\pi/4} \mathbf{j} + [t \cos t - \sin t]_0^{\pi/4} \mathbf{k} = \ln(1 + \sqrt{2}) \mathbf{i} + \left(1 - \frac{\pi}{4}\right) \mathbf{j} + \left(\frac{\pi}{4\sqrt{2}} - \frac{1}{\sqrt{2}}\right) \mathbf{k}$
11. $\mathbf{r} = \int (-t \mathbf{i} - t \mathbf{j} - t \mathbf{k}) dt = -\frac{t^2}{2} \mathbf{i} - \frac{t^2}{2} \mathbf{j} - \frac{t^2}{2} \mathbf{k} + \mathbf{C}$; $\mathbf{r}(0) = 0 \mathbf{i} - 0 \mathbf{j} - 0 \mathbf{k} + \mathbf{C} = \mathbf{i} + 2 \mathbf{j} + 3 \mathbf{k} \Rightarrow \mathbf{C} = \mathbf{i} + 2 \mathbf{j} + 3 \mathbf{k}$
 $\Rightarrow \mathbf{r} = \left(-\frac{t^2}{2} + 1\right) \mathbf{i} + \left(-\frac{t^2}{2} + 2\right) \mathbf{j} + \left(-\frac{t^2}{2} + 3\right) \mathbf{k}$
12. $\mathbf{r} = \int [(180t) \mathbf{i} + (180t - 16t^2) \mathbf{j}] dt = 90t^2 \mathbf{i} + \left(90t^2 - \frac{16}{3}t^3\right) \mathbf{j} + \mathbf{C}$; $\mathbf{r}(0) = 90(0)^2 \mathbf{i} + \left[90(0)^2 - \frac{16}{3}(0)^3\right] \mathbf{j} + \mathbf{C} = 100 \mathbf{j}$
 $\Rightarrow \mathbf{C} = 100 \mathbf{j} \Rightarrow \mathbf{r} = 90t^2 \mathbf{i} + \left(90t^2 - \frac{16}{3}t^3 + 100\right) \mathbf{j}$
13. $\mathbf{r} = \int \left[\left(\frac{3}{2}(t+1)^{1/2}\right) \mathbf{i} + e^{-t} \mathbf{j} + \left(\frac{1}{t+1}\right) \mathbf{k} \right] dt = (t+1)^{3/2} \mathbf{i} - e^{-t} \mathbf{j} + \ln(t+1) \mathbf{k} + \mathbf{C}$;
 $\mathbf{r}(0) = (0+1)^{3/2} \mathbf{i} - e^{-0} \mathbf{j} + \ln(0+1) \mathbf{k} + \mathbf{C} = \mathbf{k} \Rightarrow \mathbf{C} = -\mathbf{i} + \mathbf{j} + \mathbf{k} \Rightarrow \mathbf{r} = \left[(t+1)^{3/2} - 1\right] \mathbf{i} + (1 - e^{-t}) \mathbf{j} + [1 + \ln(t+1)] \mathbf{k}$
14. $\mathbf{r} = \int \left[(t^3 + 4t) \mathbf{i} + t \mathbf{j} + 2t^2 \mathbf{k} \right] dt = \left(\frac{t^4}{4} + 2t^2\right) \mathbf{i} + \frac{t^2}{2} \mathbf{j} + \frac{2t^3}{3} \mathbf{k} + \mathbf{C}$; $\mathbf{r}(0) = \left(\frac{0^4}{4} + 2(0)^2\right) \mathbf{i} + \frac{0^2}{2} \mathbf{j} + \frac{2(0)^3}{3} \mathbf{k} + \mathbf{C} = \mathbf{i} + \mathbf{j}$
 $\Rightarrow \mathbf{C} = \mathbf{i} + \mathbf{j} \Rightarrow \mathbf{r} = \left(\frac{t^4}{4} + 2t^2 + 1\right) \mathbf{i} + \left(\frac{t^2}{2} + 1\right) \mathbf{j} + \frac{2t^3}{3} \mathbf{k}$
15. $\frac{d\mathbf{r}}{dt} = \int (-32\mathbf{k}) dt = -32t \mathbf{k} + \mathbf{C}_1$; $\frac{d\mathbf{r}}{dt}(0) = 8\mathbf{i} + 8\mathbf{j} \Rightarrow -32(0)\mathbf{k} + \mathbf{C}_1 = 8\mathbf{i} + 8\mathbf{j} \Rightarrow \mathbf{C}_1 = 8\mathbf{i} + 8\mathbf{j} \Rightarrow \frac{d\mathbf{r}}{dt} = 8\mathbf{i} + 8\mathbf{j} - 32t\mathbf{k}$;
 $\mathbf{r} = \int (8\mathbf{i} + 8\mathbf{j} - 32t\mathbf{k}) dt = 8t \mathbf{i} + 8t \mathbf{j} - 16t^2 \mathbf{k} + \mathbf{C}_2$; $\mathbf{r}(0) = 100\mathbf{k} \Rightarrow 8(0)\mathbf{i} + 8(0)\mathbf{j} - 16(0)^2 \mathbf{k} + \mathbf{C}_2 = 100\mathbf{k}$
 $\Rightarrow \mathbf{C}_2 = 100\mathbf{k} \Rightarrow \mathbf{r} = 8t \mathbf{i} + 8t \mathbf{j} + (100 - 16t^2) \mathbf{k}$

16. $\frac{d\mathbf{r}}{dt} = \int -(\mathbf{i} + \mathbf{j} + \mathbf{k}) dt = -(t\mathbf{i} + t\mathbf{j} + t\mathbf{k}) + \mathbf{C}_1$; $\frac{d\mathbf{r}}{dt}(0) = \mathbf{0} \Rightarrow -(0\mathbf{i} + 0\mathbf{j} + 0\mathbf{k}) + \mathbf{C}_1 = \mathbf{0} \Rightarrow \mathbf{C}_1 = \mathbf{0}$
 $\Rightarrow \frac{d\mathbf{r}}{dt} = -(t\mathbf{i} + t\mathbf{j} + t\mathbf{k})$; $\mathbf{r} = \int -(t\mathbf{i} + t\mathbf{j} + t\mathbf{k}) dt = -\left(\frac{t^2}{2}\mathbf{i} + \frac{t^2}{2}\mathbf{j} + \frac{t^2}{2}\mathbf{k}\right) + \mathbf{C}_2$; $\mathbf{r}(0) = 10\mathbf{i} + 10\mathbf{j} + 10\mathbf{k}$
 $\Rightarrow -\left(\frac{0^2}{2}\mathbf{i} + \frac{0^2}{2}\mathbf{j} + \frac{0^2}{2}\mathbf{k}\right) + \mathbf{C}_2 = 10\mathbf{i} + 10\mathbf{j} + 10\mathbf{k} \Rightarrow \mathbf{C}_2 = 10\mathbf{i} + 10\mathbf{j} + 10\mathbf{k}$
 $\Rightarrow \mathbf{r} = \left(-\frac{t^2}{2} + 10\right)\mathbf{i} + \left(-\frac{t^2}{2} + 10\right)\mathbf{j} + \left(-\frac{t^2}{2} + 10\right)\mathbf{k}$
17. $\frac{d\mathbf{v}}{dt} = \mathbf{a} = 3\mathbf{i} - \mathbf{j} + \mathbf{k} \Rightarrow \mathbf{v}(t) = 3t\mathbf{i} - t\mathbf{j} + t\mathbf{k} + \mathbf{C}_1$; the particle travels in the direction of the vector
 $(4-1)\mathbf{i} + (1-2)\mathbf{j} + (4-3)\mathbf{k} = 3\mathbf{i} - \mathbf{j} + \mathbf{k}$ (since it travels in a straight line), and at time $t = 0$ it has speed 2
 $\Rightarrow \mathbf{v}(0) = \frac{2}{\sqrt{9+1+1}}(3\mathbf{i} - \mathbf{j} + \mathbf{k}) = \mathbf{C}_1 \Rightarrow \frac{d\mathbf{r}}{dt} = \mathbf{v}(t) = \left(3t + \frac{6}{\sqrt{11}}\right)\mathbf{i} - \left(t + \frac{2}{\sqrt{11}}\right)\mathbf{j} + \left(t + \frac{2}{\sqrt{11}}\right)\mathbf{k}$
 $\Rightarrow \mathbf{r}(t) = \left(\frac{3}{2}t^2 + \frac{6}{\sqrt{11}}t\right)\mathbf{i} - \left(\frac{1}{2}t^2 + \frac{2}{\sqrt{11}}t\right)\mathbf{j} + \left(\frac{1}{2}t^2 + \frac{2}{\sqrt{11}}t\right)\mathbf{k} + \mathbf{C}_2$; $\mathbf{r}(0) = \mathbf{i} + 2\mathbf{j} + 3\mathbf{k} = \mathbf{C}_2$
 $\Rightarrow \mathbf{r}(t) = \left(\frac{3}{2}t^2 + \frac{6}{\sqrt{11}}t + 1\right)\mathbf{i} - \left(\frac{1}{2}t^2 + \frac{2}{\sqrt{11}}t - 2\right)\mathbf{j} + \left(\frac{1}{2}t^2 + \frac{2}{\sqrt{11}}t + 3\right)\mathbf{k} = \left(\frac{1}{2}t^2 + \frac{2}{\sqrt{11}}t\right)(3\mathbf{i} - \mathbf{j} + \mathbf{k}) + (\mathbf{i} - 2\mathbf{j} + 3\mathbf{k})$
18. $\frac{d\mathbf{v}}{dt} = \mathbf{a} = 2\mathbf{i} + \mathbf{j} + \mathbf{k} \Rightarrow \mathbf{v}(t) = 2t\mathbf{i} + t\mathbf{j} + t\mathbf{k} + \mathbf{C}_1$; the particle travels in the direction of the vector
 $(3-1)\mathbf{i} + (0-(-1))\mathbf{j} + (3-2)\mathbf{k} = 2\mathbf{i} + \mathbf{j} + \mathbf{k}$ (since it travels in a straight line), and at time $t = 0$ it has speed 2
 $\Rightarrow \mathbf{v}(0) = \frac{2}{\sqrt{4+1+1}}(2\mathbf{i} + \mathbf{j} + \mathbf{k}) = \mathbf{C}_1 \Rightarrow \frac{d\mathbf{r}}{dt} = \mathbf{v}(t) = \left(2t + \frac{4}{\sqrt{6}}\right)\mathbf{i} + \left(t + \frac{2}{\sqrt{6}}\right)\mathbf{j} + \left(t + \frac{2}{\sqrt{6}}\right)\mathbf{k}$
 $\Rightarrow \mathbf{r}(t) = \left(t^2 + \frac{6}{\sqrt{6}}t\right)\mathbf{i} + \left(\frac{1}{2}t^2 + \frac{2}{\sqrt{6}}t\right)\mathbf{j} + \left(\frac{1}{2}t^2 + \frac{2}{\sqrt{6}}t\right)\mathbf{k} + \mathbf{C}_2$; $\mathbf{r}(0) = \mathbf{i} - \mathbf{j} + 2\mathbf{k} = \mathbf{C}_2$
 $\Rightarrow \mathbf{r}(t) = \left(t^2 + \frac{4}{\sqrt{6}}t + 1\right)\mathbf{i} + \left(\frac{1}{2}t^2 + \frac{2}{\sqrt{6}}t - 1\right)\mathbf{j} + \left(\frac{1}{2}t^2 + \frac{2}{\sqrt{6}}t + 2\right)\mathbf{k} = \left(\frac{1}{2}t^2 + \frac{2}{\sqrt{6}}t\right)(2\mathbf{i} + \mathbf{j} + \mathbf{k}) + (\mathbf{i} - \mathbf{j} + 2\mathbf{k})$
19. $x = (v_0 \cos \alpha)t \Rightarrow (21 \text{ km})\left(\frac{1000 \text{ m}}{1 \text{ km}}\right) = (840 \text{ m/s})(\cos 60^\circ)t \Rightarrow t = \frac{21,000 \text{ m}}{(840 \text{ m/s})(\cos 60^\circ)} = 50 \text{ seconds}$
20. $R = \frac{v_0^2}{g} \sin 2\alpha$ and maximum R occurs when $\alpha = 45^\circ \Rightarrow 24.5 \text{ km} = \left(\frac{v_0^2}{9.8 \text{ m/s}^2}\right)(\sin 90^\circ)$
 $\Rightarrow v_0 = \sqrt{(9.8)(24,500) \text{ m}^2/\text{s}^2} = 490 \text{ m/s}$
21. (a) $t = \frac{2v_0 \sin \alpha}{g} = \frac{2(500 \text{ m/s})(\sin 45^\circ)}{9.8 \text{ m/s}^2} \approx 72.2 \text{ seconds}$; $R = \frac{v_0^2}{g} \sin 2\alpha = \frac{(500 \text{ m/s})^2}{9.8 \text{ m/s}^2}(\sin 90^\circ) \approx 25,510.2 \text{ m}$
 (b) $x = (v_0 \cos \alpha)t \Rightarrow 5000 \text{ m} = (500 \text{ m/s})(\cos 45^\circ)t \Rightarrow t = \frac{5000 \text{ m}}{(500 \text{ m/s})(\cos 45^\circ)} \approx 14.14 \text{ s}$; thus,
 $y = (v_0 \sin \alpha)t - \frac{1}{2}gt^2 \Rightarrow y \approx (500 \text{ m/s})(\sin 45^\circ)(14.14 \text{ s}) - \frac{1}{2}(9.8 \text{ m/s}^2)(14.14 \text{ s})^2 \approx 4020 \text{ m}$
 (c) $y_{\max} = \frac{(v_0 \sin \alpha)^2}{2g} = \frac{((500 \text{ m/s})(\sin 45^\circ))^2}{2(9.8 \text{ m/s}^2)} \approx 6378 \text{ m}$
22. $y = y_0 + (v_0 \sin \alpha)t - \frac{1}{2}gt^2 \Rightarrow y = 32 \text{ ft} + (32 \text{ ft/sec})(\sin 30^\circ)t - \frac{1}{2}(32 \text{ ft/sec}^2)t^2 \Rightarrow y = 32 + 16t - 16t^2$;
 the ball hits the ground when $y = 0 \Rightarrow 0 = 32 + 16t - 16t^2 \Rightarrow t = -1$ or $t = 2 \Rightarrow t = 2 \text{ sec}$ since $t > 0$; thus,
 $x = (v_0 \cos \alpha)t \Rightarrow x = (32 \text{ ft/sec})(\cos 30^\circ)t = 32\left(\frac{\sqrt{3}}{2}\right)(2) \approx 55.4 \text{ ft}$

23. (a) $R = \frac{v_0^2}{g} \sin 2\alpha \Rightarrow 10 \text{ m} = \left(\frac{v_0^2}{9.8 \text{ m/s}^2}\right)(\sin 90^\circ) \Rightarrow v_0^2 = 98 \text{ m}^2/\text{s}^2 \Rightarrow v_0 \approx 9.9 \text{ m/s};$

(b) $6 \text{ m} \approx \frac{(9.9 \text{ m/s}^2)}{9.8 \text{ m/s}^2}(\sin 2\alpha) \Rightarrow \sin 2\alpha \approx 0.59999 \Rightarrow 2\alpha \approx 36.87^\circ \text{ or } 143.12^\circ \Rightarrow \alpha \approx 18.4^\circ \text{ or } 71.6^\circ$

24. $v_0 = 5 \times 10^6 \text{ m/s}$ and $x = 40 \text{ cm} = 0.4 \text{ m}$; thus $x = (v_0 \cos \alpha)t \Rightarrow 0.4 \text{ m} = (5 \times 10^6 \text{ m/s})(\cos 0^\circ)t$
 $\Rightarrow t = 0.08 \times 10^{-6} \text{ s} = 8 \times 10^{-8} \text{ s}$; also, $y = y_0 + (v_0 \sin \alpha)t - \frac{1}{2}gt^2$

$\Rightarrow y = (5 \times 10^6 \text{ m/s})(\sin 0^\circ)(8 \times 10^{-8} \text{ s}) - \frac{1}{2}(9.8 \text{ m/s}^2)(8 \times 10^{-8} \text{ s})^2 = -3.136 \times 10^{-14} \text{ m}$ or $-3.136 \times 10^{-12} \text{ cm}$.

Therefore, it drops $3.136 \times 10^{-12} \text{ cm}$.

25. $R = \frac{v_0^2}{g} \sin 2\alpha \Rightarrow 16,000 \text{ m} = \frac{(400 \text{ m/s})^2}{9.8 \text{ m/s}^2} \sin 2\alpha \Rightarrow \sin 2\alpha = 0.98 \Rightarrow 2\alpha \approx 78.5^\circ \text{ or } 2\alpha \approx 101.5^\circ \Rightarrow \alpha \approx 39.3^\circ$
 or 50.7°

26. (a) $R = \frac{(2v_0)^2}{g} \sin 2\alpha = \frac{4v_0^2}{g} \sin 2\alpha = 4\left(\frac{v_0^2}{g} \sin 2\alpha\right)$ or 4 times the original range.

(b) Now, let the initial range be $R = \frac{v_0^2}{g} \sin 2\alpha$. Then we want the factor p so that pv_0 will double the range

$\Rightarrow \frac{(pv_0)^2}{g} \sin 2\alpha = 2\left(\frac{v_0^2}{g} \sin 2\alpha\right) \Rightarrow p^2 = 2 \Rightarrow p = \sqrt{2}$ or about 141%. The same percentage will

approximately double the height: $\frac{(pv_0 \sin \alpha)^2}{2g} = \frac{2(v_0 \sin \alpha)^2}{2g} \Rightarrow p^2 = 2 \Rightarrow p = \sqrt{2}$.

27. The projectile reaches its maximum height when its vertical component of velocity is zero

$\Rightarrow \frac{dy}{dt} = v_0 \sin \alpha - gt = 0 \Rightarrow t = \frac{v_0 \sin \alpha}{g} \Rightarrow y_{\max} = (v_0 \sin \alpha)\left(\frac{v_0 \sin \alpha}{g}\right) - \frac{1}{2}g\left(\frac{v_0 \sin \alpha}{g}\right)^2 = \frac{(v_0 \sin \alpha)^2}{g} - \frac{(v_0 \sin \alpha)^2}{2g}$

$= \frac{(v_0 \sin \alpha)^2}{2g}$. To find the flight time we find the time when the projectile lands: $(v_0 \sin \alpha)t - \frac{1}{2}gt^2 = 0$

$\Rightarrow t(v_0 \sin \alpha - \frac{1}{2}gt) = 0 \Rightarrow t = 0$ or $t = \frac{2v_0 \sin \alpha}{g}$. Since $t = 0$ is the time when the projectile is fired, then

$t = \frac{2v_0 \sin \alpha}{g}$ is the time when the projectile strikes the ground. The range is the value of the horizontal

component when $t = \frac{2v_0 \sin \alpha}{g} \Rightarrow R = x = (v_0 \cos \alpha)\left(\frac{2v_0 \sin \alpha}{g}\right) = \frac{v_0^2}{g}(2 \sin \alpha \cos \alpha) = \frac{v_0^2}{g} \sin 2\alpha$. The range is

largest when $2\alpha = 1 \Rightarrow \alpha = 45^\circ$.

28. When marble A is located R units downrange, we have $x = (v_0 \cos \alpha)t \Rightarrow R = (v_0 \cos \alpha)t \Rightarrow t = \frac{R}{v_0 \cos \alpha}$. At that

time the height of marble A is $y = y_0 + (v_0 \sin \alpha)t - \frac{1}{2}gt^2 = (v_0 \sin \alpha)\left(\frac{R}{v_0 \cos \alpha}\right) - \frac{1}{2}g\left(\frac{R}{v_0 \cos \alpha}\right)^2$

$\Rightarrow y = R \tan \alpha - \frac{1}{2}g\left(\frac{R^2}{v_0^2 \cos^2 \alpha}\right)$. The height of marble B at the same time $t = \frac{R}{v_0 \cos \alpha}$ seconds is

$h = R \tan \alpha - \frac{1}{2}gt^2 = R \tan \alpha - \frac{1}{2}g\left(\frac{R^2}{v_0^2 \cos^2 \alpha}\right)$. Since the heights are the same, the marbles collide regardless of

the initial velocity v_0 .

29. $\frac{d\mathbf{r}}{dt} = \int (-g\mathbf{j})dt = -gt\mathbf{j} + \mathbf{C}_1$ and $\frac{d\mathbf{r}}{dt}(0) = (v_0 \cos \alpha)\mathbf{i} + (v_0 \sin \alpha)\mathbf{j} \Rightarrow -g(0)\mathbf{j} - \mathbf{C}_1 = (v_0 \cos \alpha)\mathbf{i} + (v_0 \sin \alpha)\mathbf{j}$
 $\Rightarrow \mathbf{C}_1 = (v_0 \cos \alpha)\mathbf{i} + (v_0 \sin \alpha)\mathbf{j} \Rightarrow \frac{d\mathbf{r}}{dt} = (v_0 \cos \alpha)\mathbf{i} + (v_0 \sin \alpha - gt)\mathbf{j}$; $\mathbf{r} = \int [(v_0 \cos \alpha)\mathbf{i} + (v_0 \sin \alpha - gt)\mathbf{j}] dt$
 $= (v_0 t \cos \alpha)\mathbf{i} + (v_0 t \sin \alpha - \frac{1}{2}gt^2)\mathbf{j} + \mathbf{C}_2$ and $\mathbf{r}(0) = x_0\mathbf{i} + y_0\mathbf{j} \Rightarrow [v_0(0) \cos \alpha]\mathbf{i} + [v_0(0) \sin \alpha - \frac{1}{2}g(0)^2]\mathbf{j} + \mathbf{C}_2$
 $= x_0\mathbf{i} + y_0\mathbf{j} \Rightarrow \mathbf{C}_2 = x_0\mathbf{i} + y_0\mathbf{j} \Rightarrow \mathbf{r} = (x_0 + v_0 t \cos \alpha)\mathbf{i} + (y_0 + v_0 t \sin \alpha - \frac{1}{2}gt^2)\mathbf{j} \Rightarrow x = x_0 + v_0 t \cos \alpha$ and
 $y = y_0 + v_0 t \sin \alpha - \frac{1}{2}gt^2$

30. The maximum height is $y = \frac{(v_0 \sin \alpha)^2}{2g}$ and this occurs for $x = \frac{v_0^2}{2g} \sin 2\alpha = \frac{v_0^2 \sin \alpha \cos \alpha}{g}$. These equations describe parametrically the points on a curve in the xy -plane associated with the maximum heights on the parabolic trajectories in terms of the parameter (launch angle) α . Eliminating the parameter α , we have

$$x^2 = \frac{v_0^4 \sin^2 \alpha \cos^2 \alpha}{g^2} = \frac{(v_0^4 \sin^2 \alpha)(1 - \sin^2 \alpha)}{g^2} = \frac{v_0^4 \sin^2 \alpha}{g^2} - \frac{v_0^4 \sin^4 \alpha}{g^2} = \frac{v_0^2}{g} (2y) - (2y)^2 \Rightarrow x^2 + 4y^2 - \left(\frac{2v_0^2}{g}\right)y = 0$$

$$\Rightarrow x^2 + 4\left[y^2 - \left(\frac{v_0^2}{2g}\right)y + \frac{v_0^4}{16g^2}\right] = \frac{v_0^4}{4g^2} \Rightarrow x^2 + 4\left(y - \frac{v_0^2}{4g}\right)^2 = \frac{v_0^4}{4g^2}, \text{ where } x \geq 0.$$

31. (a) At the time t when the projectile hits the line OR

we have $\tan \beta = \frac{y}{x}$; $x = [v_0 \cos(\alpha - \beta)]t$ and

$y = [v_0 \sin(\alpha - \beta)]t - \frac{1}{2}gt^2 < 0$ since R is

below level ground. Therefore let

$|y| = \frac{1}{2}gt^2 - [v_0 \sin(\alpha - \beta)]t > 0$ so that

$$\tan \beta = \frac{[\frac{1}{2}gt^2 - v_0 \sin(\alpha - \beta)]t}{[v_0 \cos(\alpha - \beta)]t} = \frac{[\frac{1}{2}gt - v_0 \sin(\alpha - \beta)]}{v_0 \cos(\alpha - \beta)}$$

$$\Rightarrow v_0 \cos(\alpha - \beta) \tan \beta = \frac{1}{2}gt - v_0 \sin(\alpha - \beta)$$

$$\Rightarrow t = \frac{2v_0 \sin(\alpha - \beta) + 2v_0 \cos(\alpha - \beta) \tan \beta}{g},$$

which is the time when the projectile hits the downhill slope. Therefore,

$$x = [v_0 \cos(\alpha - \beta)] \left[\frac{2v_0 \sin(\alpha - \beta) + 2v_0 \cos(\alpha - \beta) \tan \beta}{g} \right] = \frac{2v_0^2}{g} [\cos^2(\alpha - \beta) \tan \beta + \sin(\alpha - \beta) \cos(\alpha - \beta)].$$

If x is maximized, then OR is maximized: $\frac{dx}{d\alpha} = \frac{2v_0^2}{g} [-\sin 2(\alpha - \beta) \tan \beta + \cos 2(\alpha - \beta)] = 0$

$$\Rightarrow -\sin 2(\alpha - \beta) \tan \beta + \cos 2(\alpha - \beta) = 0 \Rightarrow \tan \beta = \cot 2(\alpha - \beta) \Rightarrow 2(\alpha - \beta) = 90^\circ - \beta$$

$$\Rightarrow \alpha - \beta = \frac{1}{2}(90^\circ - \beta) \Rightarrow \alpha = \frac{1}{2}(90^\circ + \beta) = \frac{1}{2} \text{ of } \angle AOR.$$

(b) At the time t when the projectile hits OR we have

$\tan \beta = \frac{y}{x}$; $x = [v_0 \cos(\alpha + \beta)]t$ and

$y = [v_0 \sin(\alpha + \beta)]t - \frac{1}{2}gt^2$

$$\Rightarrow \tan \beta = \frac{[v_0 \sin(\alpha + \beta)]t - \frac{1}{2}gt^2}{[v_0 \cos(\alpha + \beta)]t} = \frac{[v_0 \sin(\alpha + \beta) - \frac{1}{2}gt]}{v_0 \cos(\alpha + \beta)}$$

$$\Rightarrow v_0 \cos(\alpha + \beta) \tan \beta = v_0 \sin(\alpha + \beta) - \frac{1}{2}gt$$

$$\Rightarrow t = \frac{2v_0 \sin(\alpha + \beta) - 2v_0 \cos(\alpha + \beta) \tan \beta}{g}, \text{ which is the}$$

time when the projectile hits the uphill slope.

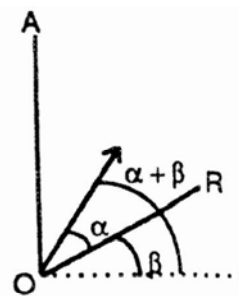
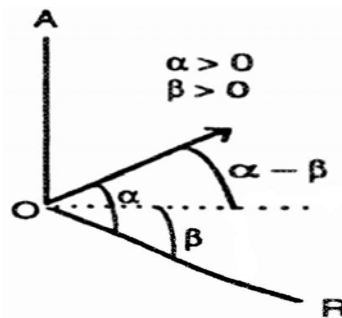

Therefore, $x = [v_0 \cos(\alpha + \beta)] \left[\frac{2v_0 \sin(\alpha + \beta) - 2v_0 \cos(\alpha + \beta) \tan \beta}{g} \right]$
 $= \frac{2v_0^2}{g} [\sin(\alpha + \beta) \cos(\alpha + \beta) - \cos^2(\alpha + \beta) \tan \beta]$. If x is maximized, then OR is maximized:
 $\frac{dx}{d\alpha} = \frac{2v_0^2}{g} [\cos 2(\alpha + \beta) + \sin 2(\alpha + \beta) \tan \beta] = 0 \Rightarrow \cos 2(\alpha + \beta) + \sin 2(\alpha + \beta) \tan \beta = 0$
 $\Rightarrow \cot 2(\alpha + \beta) + \tan \beta = 0 \Rightarrow \cot 2(\alpha + \beta) = -\tan \beta = \tan(-\beta) \Rightarrow 2(\alpha + \beta) = 90^\circ - (-\beta) = 90^\circ + \beta$
 $\Rightarrow \alpha = \frac{1}{2}(90^\circ - \beta) = \frac{1}{2}$ of $\angle AOR$. Therefore v_0 would bisect $\angle AOR$ for maximum range uphill.

32. $v_0 = 116$ ft/sec, $\alpha = 45^\circ$, and $x = (v_0 \cos \alpha)t$

$\Rightarrow 369 = (116 \cos 45^\circ)t \Rightarrow t \approx 4.50$ sec;

also $y = (v_0 \sin \alpha)t - \frac{1}{2}gt^2$

$\Rightarrow y = (116 \sin 45^\circ)(4.50) - \frac{1}{2}(32)(4.50)^2 \approx 45.11$ ft.

It will take the ball 4.50 sec to travel 369 ft. At that time the ball will be 45.11 ft in the air and will hit the green past the pin.

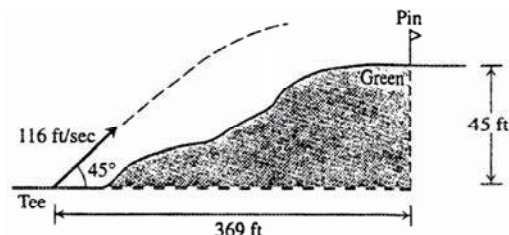

33. (a) (Assuming that "x" is zero at the point of impact:)

$\mathbf{r}(t) = (x(t))\mathbf{i} + (y(t))\mathbf{j}$; where $x(t) = (35 \cos 27^\circ)t$ and $y(t) = 4 + (35 \sin 27^\circ)t - 16t^2$.

(b) $y_{\max} = \frac{(v_0 \sin \alpha)^2}{2g} + 4 = \frac{(35 \sin 27^\circ)^2}{64} + 4 \approx 7.945$ feet, which is reached at $t = \frac{v_0 \sin \alpha}{g} = \frac{35 \sin 27^\circ}{32} \approx 0.497$ seconds.

(c) For the time, solve $y = 4 + (35 \sin 27^\circ)t - 16t^2 = 0$ for t , using the quadratic formula

$t = \frac{35 \sin 27^\circ + \sqrt{(-35 \sin 27^\circ)^2 + 256}}{32} \approx 1.201$ sec. Then the range is about $x(1.201) = (35 \cos 27^\circ)(1.201) \approx 37.453$ feet.

(d) For the time, solve $y = 4 + (35 \sin 27^\circ)t - 16t^2 = 7$ for t , using the quadratic formula

$t = \frac{35 \sin 27^\circ + \sqrt{(-35 \sin 27^\circ)^2 - 192}}{32} \approx 0.254$ and 0.740 seconds. At those times the ball is about $x(0.254) = (35 \cos 27^\circ)(0.254) \approx 7.921$ feet and $x(0.740) = (35 \cos 27^\circ)(0.740) \approx 23.077$ feet from the impact point, or about $37.453 - 7.921 \approx 29.532$ feet and $37.453 - 23.077 \approx 14.376$ feet from the landing spot.

(e) Yes. It changes things because the ball won't clear the net ($y_{\max} \approx 7.945$).

34. $x = x_0 + (v_0 \cos \alpha)t = 0 + (v_0 \cos 40^\circ)t \approx 0.766 v_0 t$ and $y = y_0 + (v_0 \sin \alpha)t - \frac{1}{2}gt^2 = 6.5 + (v_0 \sin 40^\circ)t - 16t^2$
 $\approx 6.5 + 0.643 v_0 t - 16t^2$; now the shot went 73.833 ft $\Rightarrow 73.833 = 0.766 v_0 t \Rightarrow t \approx \frac{96.383}{v_0}$ sec; the shot lands when $y = 0 \Rightarrow 0 = 6.5 + (0.643)(96.383) - 16 \left(\frac{96.383}{v_0} \right)^2 \Rightarrow 0 \approx 68.474 - \frac{148.635}{v_0^2} \Rightarrow v_0 \approx \sqrt{\frac{148.635}{68.474}} \approx 46.6$ ft/sec, the shot's initial speed

35. Flight time = 1 sec and the measure of the angle of elevation is about 64° (using a protractor) so that

$t = \frac{2v_0 \sin \alpha}{g} \Rightarrow 1 = \frac{2v_0 \sin 64^\circ}{32} \Rightarrow v_0 \approx 17.80$ ft/sec. Then $y_{\max} = \frac{(17.80 \sin 64^\circ)^2}{2(32)} \approx 4.00$ ft and $R = \frac{v_0^2}{g} \sin 2\alpha$

$\Rightarrow R = \frac{(17.80)^2}{32} \sin 128^\circ \approx 7.80 \text{ ft} \Rightarrow$ the engine traveled about 7.80 ft in 1 sec \Rightarrow the engine velocity was about 7.80 ft/sec

36. (a) $\mathbf{r}(t) = (x(t))\mathbf{i} + (y(t))\mathbf{j}$; where $x(t) = (145 \cos 23^\circ - 14)t$ and $y(t) = 2.5 + (145 \sin 23^\circ)t - 16t^2$.
 (b) $y_{\max} = \frac{(v_0 \sin \alpha)^2}{2g} + 2.5 = \frac{(145 \sin 23^\circ)^2}{64} + 2.5 \approx 52.655$ feet, which is reached at $t = \frac{v_0 \sin \alpha}{g} = \frac{145 \sin 23^\circ}{32} \approx 1.771$ seconds.
 (c) For the time, solve $y = 2.5 + (145 \sin 23^\circ)t - 16t^2 = 0$ for t , using the quadratic formula
 $t = \frac{145 \sin 23^\circ + \sqrt{(145 \sin 23^\circ)^2 + 160}}{32} \approx 3.585$ sec. Then the range at $t \approx 3.585$ is about
 $x = (145 \cos 23^\circ - 14)(3.585) \approx 428.311$ feet.
 (d) For the time, solve $y = 2.5 + (145 \sin 23^\circ)t - 16t^2 = 20$ for t , using the quadratic formula
 $t = \frac{145 \sin 23^\circ + \sqrt{(145 \sin 23^\circ)^2 - 1120}}{32} \approx 0.342$ and 3.199 seconds. At those times the ball is about
 $x(0.342) = (145 \cos 23^\circ - 14)(0.342) \approx 40.860$ feet from home plate and
 $x(3.199) = (145 \cos 23^\circ - 14)(3.199) \approx 382.195$ feet from home plate.
 (e) Yes. According to part (d), the ball is still 20 feet above the ground when it is 382 feet from home plate.

37. $\frac{d^2\mathbf{r}}{dt^2} + k \frac{d\mathbf{r}}{dt} = -g\mathbf{j} \Rightarrow P(t) = k$ and $\mathbf{Q}(t) = -g\mathbf{j} \Rightarrow \int P(t) dt = kt \Rightarrow v(t) = e^{\int P(t) dt} = e^{kt} \Rightarrow \frac{d\mathbf{r}}{dt} = \frac{1}{v(t)} \int v(t)\mathbf{Q}(t) dt$
 $= -ge^{-kt} \int e^{kt} \mathbf{j} dt = -ge^{-kt} \left[\frac{e^{kt}}{k} \mathbf{j} + \mathbf{C}_1 \right] = -\frac{g}{k} \mathbf{j} + \mathbf{C}e^{-kt}$, where $\mathbf{C} = -g\mathbf{C}_1$; apply the initial condition:
 $\frac{d\mathbf{r}}{dt} \Big|_{t=0} = (v_0 \cos \alpha)\mathbf{i} + (v_0 \sin \alpha)\mathbf{j} = -\frac{g}{k} \mathbf{j} + \mathbf{C} \Rightarrow \mathbf{C} = (v_0 \cos \alpha)\mathbf{i} + \left(\frac{g}{k} + v_0 \sin \alpha \right)\mathbf{j}$
 $\Rightarrow \frac{d\mathbf{r}}{dt} = (v_0 e^{-kt} \cos \alpha)\mathbf{i} + \left(-\frac{g}{k} + e^{-kt} \left(\frac{g}{k} + v_0 \sin \alpha \right) \right)\mathbf{j}$, $\mathbf{r} = \int \left[(v_0 e^{-kt} \cos \alpha)\mathbf{i} + \left(-\frac{g}{k} + e^{-kt} \left(\frac{g}{k} + v_0 \sin \alpha \right) \right)\mathbf{j} \right] dt$
 $= \left(-\frac{v_0}{k} e^{-kt} \cos \alpha \right)\mathbf{i} + \left(-\frac{gt}{k} - \frac{e^{-kt}}{k} \left(\frac{g}{k} + v_0 \sin \alpha \right) \right)\mathbf{j} + \mathbf{C}_2$; apply the initial condition:
 $\mathbf{r}(0) = \mathbf{0} = \left(-\frac{v_0}{k} \cos \alpha \right)\mathbf{i} + \left(-\frac{g}{k^2} - \frac{v_0 \sin \alpha}{k} \right)\mathbf{j} + \mathbf{C}_2 \Rightarrow \mathbf{C}_2 = \left(\frac{v_0}{k} \cos \alpha \right)\mathbf{i} + \left(\frac{g}{k^2} + \frac{v_0 \sin \alpha}{k} \right)\mathbf{j}$
 $\Rightarrow \mathbf{r}(t) = \left(\frac{v_0}{k} (1 - e^{-kt}) \cos \alpha \right)\mathbf{i} + \left(\frac{v_0}{k} (1 - e^{-kt}) \sin \alpha + \frac{g}{k^2} (1 - kt - e^{-kt}) \right)\mathbf{j}$

38. (a) $\mathbf{r}(t) = (x(t))\mathbf{i} + (y(t))\mathbf{j}$; where $x(t) = \left(\frac{152}{0.12} \right) (1 - e^{-0.12t}) (\cos 20^\circ)$ and
 $y(t) = 3 + \left(\frac{152}{0.12} \right) (1 - e^{-0.12t}) (\sin 20^\circ) + \left(\frac{32}{0.12^2} \right) (1 - 0.12t - e^{-0.12t})$
 (b) Solve graphically using a calculator or CAS: At $t \approx 1.484$ seconds the ball reaches a maximum height of about 40.435 feet.
 (c) Use a graphing calculator or CAS to find that $y = 0$ when the ball has traveled for ≈ 3.126 seconds. The range is about $x(3.126) = \left(\frac{152}{0.12} \right) (1 - e^{-0.12(3.126)}) (\cos 20^\circ) \approx 372.311$ feet.
 (d) Use a graphing calculator or CAS to find that $y = 30$ for $t \approx 0.689$ and 2.305 seconds, at which times the ball is about $x(0.689) \approx 94.454$ feet and $x(2.305) \approx 287.621$ feet from home plate.
 (e) Yes, the batter has hit a home run since a graph of the trajectory shows that the ball is more than 14 feet above the ground when it passes over the fence.

39. (a)
$$\int_a^b k\mathbf{r}(t) dt = \int_a^b [kf(t)\mathbf{i} + kg(t)\mathbf{j} + kh(t)\mathbf{k}] dt = \int_a^b [kf(t)] dt \mathbf{i} + \int_a^b [kg(t)] dt \mathbf{j} + \int_a^b [kh(t)] dt \mathbf{k}$$

$$= k \left(\int_a^b f(t) dt \mathbf{i} + \int_a^b g(t) dt \mathbf{j} + \int_a^b h(t) dt \mathbf{k} \right) = k \int_a^b \mathbf{r}(t) dt$$

(b)
$$\int_a^b [\mathbf{r}_1(t) \pm \mathbf{r}_2(t)] dt = \int_a^b ([f_1(t)\mathbf{i} + g_1(t)\mathbf{j} + h_1(t)\mathbf{k}] \pm [f_2(t)\mathbf{i} + g_2(t)\mathbf{j} + h_2(t)\mathbf{k}]) dt$$

$$= \int_a^b ([f_1(t) \pm f_2(t)]\mathbf{i} + [g_1(t) \pm g_2(t)]\mathbf{j} + [h_1(t) \pm h_2(t)]\mathbf{k}) dt$$

$$= \int_a^b [f_1(t) \pm f_2(t)] dt \mathbf{i} + \int_a^b [g_1(t) \pm g_2(t)] dt \mathbf{j} + \int_a^b [h_1(t) \pm h_2(t)] dt \mathbf{k}$$

$$= \left[\int_a^b f_1(t) dt \mathbf{i} \pm \int_a^b f_2(t) dt \mathbf{i} \right] + \left[\int_a^b g_1(t) dt \mathbf{j} \pm \int_a^b g_2(t) dt \mathbf{j} \right] + \left[\int_a^b h_1(t) dt \mathbf{k} \pm \int_a^b h_2(t) dt \mathbf{k} \right]$$

$$= \int_a^b \mathbf{r}_1(t) dt \pm \int_a^b \mathbf{r}_2(t) dt$$

(c) Let $\mathbf{C} = c_1\mathbf{i} + c_2\mathbf{j} + c_3\mathbf{k}$. Then
$$\int_a^b \mathbf{C} \cdot \mathbf{r}(t) dt = \int_a^b [c_1f(t) + c_2g(t) + c_3h(t)] dt$$

$$= c_1 \int_a^b f(t) dt + c_2 \int_a^b g(t) dt + c_3 \int_a^b h(t) dt = \mathbf{C} \cdot \int_a^b \mathbf{r}(t) dt;$$

$$\int_a^b \mathbf{C} \times \mathbf{r}(t) dt = \int_a^b [c_2h(t) - c_3g(t)]\mathbf{i} + [c_3f(t) - c_1h(t)]\mathbf{j} + [c_1g(t) - c_2f(t)]\mathbf{k} dt$$

$$= \left[c_2 \int_a^b h(t) dt - c_3 \int_a^b g(t) dt \right] \mathbf{i} + \left[c_3 \int_a^b f(t) dt - c_1 \int_a^b h(t) dt \right] \mathbf{j} + \left[c_1 \int_a^b g(t) dt - c_2 \int_a^b f(t) dt \right] \mathbf{k}$$

$$= \mathbf{C} \times \int_a^b \mathbf{r}(t) dt$$

40. (a) Let u and \mathbf{r} be continuous on $[a, b]$. Then
$$\lim_{t \rightarrow t_0} u(t)\mathbf{r}(t) = \lim_{t \rightarrow t_0} [u(t)f(t)\mathbf{i} + u(t)g(t)\mathbf{j} + u(t)h(t)\mathbf{k}]$$

$$= u(t_0)f(t_0)\mathbf{i} + u(t_0)g(t_0)\mathbf{j} + u(t_0)h(t_0)\mathbf{k} = u(t_0)\mathbf{r}(t_0) \Rightarrow u\mathbf{r}$$
 is continuous for every t_0 in $[a, b]$.

(b) Let u and \mathbf{r} be differentiable. Then
$$\frac{d}{dt}(u\mathbf{r}) = \frac{d}{dt}[u(t)f(t)\mathbf{i} + u(t)g(t)\mathbf{j} + u(t)h(t)\mathbf{k}]$$

$$= \left(\frac{du}{dt}f(t) + u(t)\frac{df}{dt} \right) \mathbf{i} + \left(\frac{du}{dt}g(t) + u(t)\frac{dg}{dt} \right) \mathbf{j} + \left(\frac{du}{dt}h(t) + u(t)\frac{dh}{dt} \right) \mathbf{k}$$

$$= [f(t)\mathbf{i} + g(t)\mathbf{j} + h(t)\mathbf{k}] \frac{du}{dt} + u(t) \left(\frac{df}{dt}\mathbf{i} + \frac{dg}{dt}\mathbf{j} + \frac{dh}{dt}\mathbf{k} \right) = \mathbf{r} \frac{du}{dt} + u \frac{d\mathbf{r}}{dt}$$

41. (a) If $\mathbf{R}_1(t)$ and $\mathbf{R}_2(t)$ have identical derivatives on I , then
$$\frac{d\mathbf{R}_1}{dt} = \frac{df_1}{dt}\mathbf{i} + \frac{dg_1}{dt}\mathbf{j} + \frac{dh_1}{dt}\mathbf{k} = \frac{df_2}{dt}\mathbf{i} + \frac{dg_2}{dt}\mathbf{j} + \frac{dh_2}{dt}\mathbf{k}$$

$$= \frac{d\mathbf{R}_2}{dt} \Rightarrow \frac{df_1}{dt} = \frac{df_2}{dt}, \frac{dg_1}{dt} = \frac{dg_2}{dt}, \frac{dh_1}{dt} = \frac{dh_2}{dt} \Rightarrow f_1(t) = f_2(t) + c_1, g_1(t) = g_2(t) + c_2, h_1(t) = h_2(t) + c_3$$

$$\Rightarrow f_1(t)\mathbf{i} + g_1(t)\mathbf{j} + h_1(t)\mathbf{k} = [f_2(t) + c_1]\mathbf{i} + [g_2(t) + c_2]\mathbf{j} + [h_2(t) + c_3]\mathbf{k} \Rightarrow \mathbf{R}_1(t) = \mathbf{R}_2(t) + \mathbf{C},$$
 where $\mathbf{C} = c_1\mathbf{i} + c_2\mathbf{j} + c_3\mathbf{k}$.

(b) Let $\mathbf{R}(t)$ be an antiderivative of $\mathbf{r}(t)$ on I . Then $\mathbf{R}'(t) = \mathbf{r}(t)$. If $\mathbf{U}(t)$ is an antiderivative of $\mathbf{r}(t)$ on I , then $\mathbf{U}'(t) = \mathbf{r}(t)$. Thus $\mathbf{U}'(t) = \mathbf{R}'(t)$ on $I \Rightarrow \mathbf{U}(t) = \mathbf{R}(t) + \mathbf{C}$.

42.
$$\frac{d}{dt} \int_a^t \mathbf{r}(\tau) d\tau = \frac{d}{dt} \int_a^t [f(\tau)\mathbf{i} + g(\tau)\mathbf{j} + h(\tau)\mathbf{k}] d\tau = \frac{d}{dt} \int_a^t f(\tau) d\tau \mathbf{i} + \frac{d}{dt} \int_a^t g(\tau) d\tau \mathbf{j} + \frac{d}{dt} \int_a^t h(\tau) d\tau \mathbf{k}$$

$$= f(t)\mathbf{i} + g(t)\mathbf{j} + h(t)\mathbf{k} = \mathbf{r}(t).$$
 Since $\frac{d}{dt} \int_a^t \mathbf{r}(\tau) d\tau = \mathbf{r}(t)$, we have that $\int_a^t \mathbf{r}(\tau) d\tau$ is an antiderivative of \mathbf{r} .

If \mathbf{R} is any antiderivative of \mathbf{r} , then $\mathbf{R}(t) = \int_a^t \mathbf{r}(\tau) d\tau + \mathbf{C}$ by Exercise 41(b). Then $\mathbf{R}(a) = \int_a^a \mathbf{r}(\tau) d\tau + \mathbf{C} = \mathbf{0} + \mathbf{C} \Rightarrow \mathbf{C} = \mathbf{R}(a) \Rightarrow \int_a^t \mathbf{r}(\tau) d\tau = \mathbf{R}(t) - \mathbf{C} = \mathbf{R}(t) - \mathbf{R}(a) \Rightarrow \int_a^b \mathbf{r}(\tau) d\tau = \mathbf{R}(b) - \mathbf{R}(a)$.

43. (a) $\mathbf{r}(t) = (x(t))\mathbf{i} + (y(t))\mathbf{j}$; where $x(t) = \left(\frac{1}{0.08}\right)(1 - e^{-0.08t})(152 \cos 20^\circ - 17.6)$ and $y(t) = 3 + \left(\frac{152}{0.08}\right)(1 - e^{-0.08t})(\sin 20^\circ) + \left(\frac{32}{0.08^2}\right)(1 - 0.08t - e^{-0.08t})$
- (b) Solve graphically using a calculator or CAS: At $t \approx 1.527$ seconds the ball reaches a maximum height of about 41.893 feet.
- (c) Use a graphing calculator or CAS to find that $y = 0$ when the ball has traveled for ≈ 3.181 seconds. The range is about $x(3.181) = \left(\frac{1}{0.08}\right)(1 - e^{-0.08(3.181)})(152 \cos 20^\circ - 17.6) \approx 351.734$ feet.
- (d) Use a graphing calculator or CAS to find that $y = 35$ for $t \approx 0.877$ and 2.190 seconds, at which times the ball is about $x(0.877) \approx 106.028$ feet and $x(2.190) \approx 251.530$ feet from home plate.
- (e) No; the range is less than 380 feet. To find the wind needed for a home run, first use the method of part (d) to find that $y = 20$ at $t \approx 0.376$ and 2.716 seconds. Then define $x(w) = \left(\frac{1}{0.08}\right)(1 - e^{-0.08(2.716)})(152 \cos 20^\circ + w)$, and solve $x(w) = 380$ to find $w \approx 12.846$ ft/sec.

44. $y_{\max} = \frac{(v_0 \sin \alpha)^2}{2g} \Rightarrow \frac{3}{4} y_{\max} = \frac{3(v_0 \sin \alpha)^2}{8g}$ and $y = (v_0 \sin \alpha)t - \frac{1}{2}gt^2 \Rightarrow \frac{3(v_0 \sin \alpha)^2}{8g} = (v_0 \sin \alpha)t - \frac{1}{2}gt^2$
 $\Rightarrow 3(v_0 \sin \alpha)^2 = (8gv_0 \sin \alpha)t - 4g^2t^2 \Rightarrow 4g^2t^2 - (8gv_0 \sin \alpha)t + 3(v_0 \sin \alpha)^2 = 0 \Rightarrow 2gt - 3v_0 \sin \alpha = 0$ or $2gt - v_0 \sin \alpha = 0 \Rightarrow t = \frac{3v_0 \sin \alpha}{2g}$ or $t = \frac{v_0 \sin \alpha}{2g}$. Since the time it takes to reach y_{\max} is $t_{\max} = \frac{v_0 \sin \alpha}{g}$, then the time it takes the projectile to reach $\frac{3}{4}$ of y_{\max} is the shorter time $t = \frac{v_0 \sin \alpha}{2g}$ or half the time it takes to reach the maximum height.

13.3 ARC LENGTH IN SPACE

1. $\mathbf{r} = (2 \cos t)\mathbf{i} + (2 \sin t)\mathbf{j} + \sqrt{5}t\mathbf{k} \Rightarrow \mathbf{v} = (-2 \sin t)\mathbf{i} + (2 \cos t)\mathbf{j} + \sqrt{5}\mathbf{k} \Rightarrow |\mathbf{v}| = \sqrt{(-2 \sin t)^2 + (2 \cos t)^2 + (\sqrt{5})^2} = \sqrt{4 \sin^2 t + 4 \cos^2 t + 5} = 3$; $\mathbf{T} = \frac{\mathbf{v}}{|\mathbf{v}|} = \left(-\frac{2}{3} \sin t\right)\mathbf{i} + \left(\frac{2}{3} \cos t\right)\mathbf{j} + \frac{\sqrt{5}}{3}\mathbf{k}$ and Length $= \int_0^\pi |\mathbf{v}| dt = \int_0^\pi 3 dt = [3t]_0^\pi = 3\pi$
2. $\mathbf{r} = (6 \sin 2t)\mathbf{i} + (6 \cos 2t)\mathbf{j} + 5t\mathbf{k} \Rightarrow \mathbf{v} = (12 \cos 2t)\mathbf{i} + (-12 \sin 2t)\mathbf{j} + 5\mathbf{k}$
 $\Rightarrow |\mathbf{v}| = \sqrt{(12 \cos 2t)^2 + (-12 \sin 2t)^2 + 5^2} = \sqrt{144 \cos^2 2t + 144 \sin^2 2t + 25} = 13$;
 $\mathbf{T} = \frac{\mathbf{v}}{|\mathbf{v}|} = \left(\frac{12}{13} \cos 2t\right)\mathbf{i} - \left(\frac{12}{13} \sin 2t\right)\mathbf{j} + \frac{5}{13}\mathbf{k}$ and Length $= \int_0^\pi |\mathbf{v}| dt = \int_0^\pi 13 dt = [13t]_0^\pi = 13\pi$
3. $\mathbf{r} = t\mathbf{i} + \frac{2}{3}t^{3/2}\mathbf{k} \Rightarrow \mathbf{v} = \mathbf{i} + t^{1/2}\mathbf{k} \Rightarrow |\mathbf{v}| = \sqrt{1^2 + (t^{1/2})^2} = \sqrt{1+t}$; $\mathbf{T} = \frac{\mathbf{v}}{|\mathbf{v}|} = \frac{1}{\sqrt{1+t}}\mathbf{i} + \frac{\sqrt{t}}{\sqrt{1+t}}\mathbf{k}$ and Length $= \int_0^8 \sqrt{1+t} dt = \left[\frac{2}{3}(1+t)^{3/2}\right]_0^8 = \frac{52}{3}$

4. $\mathbf{r} = (2+t)\mathbf{i} - (t+1)\mathbf{j} + t\mathbf{k} \Rightarrow \mathbf{v} = \mathbf{i} - \mathbf{j} + \mathbf{k} \Rightarrow |\mathbf{v}| = \sqrt{1^2 + (-1)^2 + 1^2} = \sqrt{3}$; $\mathbf{T} = \frac{\mathbf{v}}{|\mathbf{v}|} = \frac{1}{\sqrt{3}}\mathbf{i} - \frac{1}{\sqrt{3}}\mathbf{j} + \frac{1}{\sqrt{3}}\mathbf{k}$ and
 Length $= \int_0^3 \sqrt{3} dt = [\sqrt{3}t]_0^3 = 3\sqrt{3}$
5. $\mathbf{r} = (\cos^3 t)\mathbf{j} + (\sin^3 t)\mathbf{k} \Rightarrow \mathbf{v} = (-3\cos^2 t \sin t)\mathbf{j} + (3\sin^2 t \cos t)\mathbf{k}$
 $\Rightarrow |\mathbf{v}| = \sqrt{(-3\cos^2 t \sin t)^2 + (3\sin^2 t \cos t)^2} = \sqrt{(9\cos^2 t \sin^2 t)(\cos^2 t + \sin^2 t)} = 3|\cos t \sin t|$;
 $\mathbf{T} = \frac{\mathbf{v}}{|\mathbf{v}|} = \frac{-3\cos^2 t \sin t}{3|\cos t \sin t|}\mathbf{j} + \frac{3\sin^2 t \cos t}{3|\cos t \sin t|}\mathbf{k} = (-\cos t)\mathbf{j} + (\sin t)\mathbf{k}$, if $0 \leq t \leq \frac{\pi}{2}$, and
 Length $= \int_0^{\pi/2} 3|\cos t \sin t| dt = \int_0^{\pi/2} 3 \cos t \sin t dt = \int_0^{\pi/2} \frac{3}{2} \sin 2t dt = \left[-\frac{3}{4} \cos 2t\right]_0^{\pi/2} = \frac{3}{2}$
6. $\mathbf{r} = 6t^3\mathbf{i} - 2t^3\mathbf{j} - 3t^3\mathbf{k} \Rightarrow \mathbf{v} = 18t^2\mathbf{i} - 6t^2\mathbf{j} - 9t^2\mathbf{k} \Rightarrow |\mathbf{v}| = \sqrt{(18t^2)^2 + (-6t^2)^2 + (-9t^2)^2} = \sqrt{441t^4} = 21t^2$;
 $\mathbf{T} = \frac{\mathbf{v}}{|\mathbf{v}|} = \frac{18t^2}{21t^2}\mathbf{i} - \frac{6t^2}{21t^2}\mathbf{j} - \frac{9t^2}{21t^2}\mathbf{k} = \frac{6}{7}\mathbf{i} - \frac{2}{7}\mathbf{j} - \frac{3}{7}\mathbf{k}$ and Length $= \int_1^2 21t^2 dt = \left[7t^3\right]_1^2 = 49$
7. $\mathbf{r} = (t \cos t)\mathbf{i} + (t \sin t)\mathbf{j} + \frac{2\sqrt{2}}{3}t^{3/2}\mathbf{k} \Rightarrow \mathbf{v} = (\cos t - t \sin t)\mathbf{i} + (\sin t + t \cos t)\mathbf{j} + (\sqrt{2}t^{1/2})\mathbf{k}$
 $\Rightarrow |\mathbf{v}| = \sqrt{(\cos t - t \sin t)^2 + (\sin t + t \cos t)^2 + (\sqrt{2}t)^2} = \sqrt{1 + t^2 + 2t} = \sqrt{(t+1)^2} = |t+1| = t+1$, if $t \geq 0$;
 $\mathbf{T} = \frac{\mathbf{v}}{|\mathbf{v}|} = \left(\frac{\cos t - t \sin t}{t+1}\right)\mathbf{i} + \left(\frac{\sin t + t \cos t}{t+1}\right)\mathbf{j} + \left(\frac{\sqrt{2}t^{1/2}}{t+1}\right)\mathbf{k}$ and Length $= \int_0^\pi (t+1) dt = \left[\frac{t^2}{2} + t\right]_0^\pi = \frac{\pi^2}{2} + \pi$
8. $\mathbf{r} = (t \sin t + \cos t)\mathbf{i} + (t \cos t - \sin t)\mathbf{j} \Rightarrow \mathbf{v} = (\sin t + t \cos t - \sin t)\mathbf{i} + (\cos t - t \sin t - \cos t)\mathbf{j}$
 $= (t \cos t)\mathbf{i} - (t \sin t)\mathbf{j} \Rightarrow |\mathbf{v}| = \sqrt{(t \cos t)^2 + (-t \sin t)^2} = \sqrt{t^2} = |t| = t$ if $\sqrt{2} \leq t \leq 2$;
 $\mathbf{T} = \frac{\mathbf{v}}{|\mathbf{v}|} = \left(\frac{t \cos t}{t}\right)\mathbf{i} - \left(\frac{t \sin t}{t}\right)\mathbf{j} = (\cos t)\mathbf{i} - (\sin t)\mathbf{j}$ and Length $= \int_{\sqrt{2}}^2 t dt = \left[\frac{t^2}{2}\right]_{\sqrt{2}}^2 = 1$
9. Let $P(t_0)$ denote the point. Then $\mathbf{v} = (5 \cos t)\mathbf{i} - (5 \sin t)\mathbf{j} + 12\mathbf{k}$ and $26\pi = \int_0^{t_0} \sqrt{25 \cos^2 t + 25 \sin^2 t + 144} dt$
 $= \int_0^{t_0} 13 dt = 13t_0 \Rightarrow t_0 = 2\pi$, and the point is $P(2\pi) = (5 \sin 2\pi, 5 \cos 2\pi, 24\pi) = (0, 5, 24\pi)$
10. Let $P(t_0)$ denote the point. Then $\mathbf{v} = (12 \cos t)\mathbf{i} + (12 \sin t)\mathbf{j} + 5\mathbf{k}$ and
 $-13\pi = \int_0^{t_0} \sqrt{144 \cos^2 t + 144 \sin^2 t + 25} dt = \int_0^{t_0} 13 dt = 13t_0 \Rightarrow t_0 = -\pi$, and the point is
 $P(-\pi) = (12 \sin(-\pi), -12 \cos(-\pi), -5\pi) = (0, 12, -5\pi)$
11. $\mathbf{r} = (4 \cos t)\mathbf{i} + (4 \sin t)\mathbf{j} + 3t\mathbf{k} \Rightarrow \mathbf{v} = (-4 \sin t)\mathbf{i} + (4 \cos t)\mathbf{j} + 3\mathbf{k} \Rightarrow |\mathbf{v}| = \sqrt{(-4 \sin t)^2 + (4 \cos t)^2 + 3^2}$
 $= \sqrt{25} = 5 \Rightarrow s(t) = \int_0^t 5 d\tau = 5t \Rightarrow \text{Length} = s\left(\frac{\pi}{2}\right) = \frac{5\pi}{2}$

12. $\mathbf{r} = (\cos t + t \sin t)\mathbf{i} + (\sin t - t \cos t)\mathbf{j} \Rightarrow \mathbf{v} = (-\sin t + \sin t + t \cos t)\mathbf{i} + (\cos t - \cos t + t \sin t)\mathbf{j}$
 $= (t \cos t)\mathbf{i} + (t \sin t)\mathbf{j} \Rightarrow |\mathbf{v}| = \sqrt{(t \cos t)^2 + (t \sin t)^2} = \sqrt{t^2} = t$, since $\frac{\pi}{2} \leq t \leq \pi \Rightarrow s(t) = \int_0^t \tau \, d\tau = \frac{t^2}{2}$
 $\Rightarrow \text{Length} = s(\pi) - s\left(\frac{\pi}{2}\right) = \frac{\pi^2}{2} - \frac{\left(\frac{\pi}{2}\right)^2}{2} = \frac{3\pi^2}{8}$
13. $\mathbf{r} = (e^t \cos t)\mathbf{i} + (e^t \sin t)\mathbf{j} + e^t\mathbf{k} \Rightarrow \mathbf{v} = (e^t \cos t - e^t \sin t)\mathbf{i} + (e^t \sin t + e^t \cos t)\mathbf{j} + e^t\mathbf{k}$
 $\Rightarrow |\mathbf{v}| = \sqrt{(e^t \cos t - e^t \sin t)^2 + (e^t \sin t + e^t \cos t)^2 + (e^t)^2} = \sqrt{3e^{2t}} = \sqrt{3}e^t \Rightarrow s(t) = \int_0^t \sqrt{3}e^\tau \, d\tau = \sqrt{3}e^t - \sqrt{3}$
 $\Rightarrow \text{Length} = s(0) - s(-\ln 4) = 0 - (\sqrt{3}e^{-\ln 4} - \sqrt{3}) = \frac{3\sqrt{3}}{4}$

14. $\mathbf{r} = (1 + 2t)\mathbf{i} + (1 + 3t)\mathbf{j} + (6 - 6t)\mathbf{k} \Rightarrow \mathbf{v} = 2\mathbf{i} + 3\mathbf{j} - 6\mathbf{k} \Rightarrow |\mathbf{v}| = \sqrt{2^2 + 3^2 + (-6)^2} = 7 \Rightarrow s(t) = \int_0^t 7 \, d\tau = 7t$
 $\Rightarrow \text{Length} = s(0) - s(-1) = 0 - (-7) = 7$

15. $\mathbf{r} = (\sqrt{2}t)\mathbf{i} + (\sqrt{2}t)\mathbf{j} + (1 - t^2)\mathbf{k} \Rightarrow \mathbf{v} = \sqrt{2}\mathbf{i} + \sqrt{2}\mathbf{j} - 2t\mathbf{k} \Rightarrow |\mathbf{v}| = \sqrt{(\sqrt{2})^2 + (\sqrt{2})^2 + (-2t)^2} = \sqrt{4 + 4t^2}$
 $= 2\sqrt{1 + t^2} \Rightarrow \text{Length} = \int_0^1 2\sqrt{1 + t^2} \, dt = \left[2\left(\frac{t}{2}\sqrt{1 + t^2} + \frac{1}{2}\ln\left(t + \sqrt{1 + t^2}\right)\right) \right]_0^1 = \sqrt{2} + \ln(1 + \sqrt{2})$

16. Let the helix make one complete turn from $t = 0$ to $t = 2\pi$. Note that the radius of the cylinder is 1
 \Rightarrow the circumference of the base is 2π . When $t = 2\pi$, the point P is
 $(\cos 2\pi, \sin 2\pi, 2\pi) = (1, 0, 2\pi) \Rightarrow$ the cylinder is 2π units high. Cut the cylinder along PQ and flatten. The resulting rectangle has a width equal to the circumference of the cylinder $= 2\pi$ and a height equal to 2π , the height of the cylinder. Therefore, the rectangle is a square and the portion of the helix from $t = 0$ to $t = 2\pi$ is its diagonal.

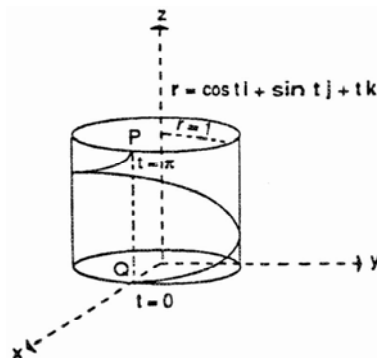

17. (a) $\mathbf{r} = (\cos t)\mathbf{i} + (\sin t)\mathbf{j} + (1 - \cos t)\mathbf{k}$, $0 \leq t \leq 2\pi \Rightarrow x = \cos t, y = \sin t, z = 1 - \cos t$
 $\Rightarrow x^2 + y^2 = \cos^2 t + \sin^2 t = 1$, a right circular cylinder with the z -axis as the axis and radius $= 1$.
 Therefore $P(\cos t, \sin t, 1 - \cos t)$ lies on the cylinder $x^2 + y^2 = 1$; $t = 0 \Rightarrow P(1, 0, 0)$ is on the curve;
 $t = \frac{\pi}{2} \Rightarrow Q(0, 1, 1)$ is on the curve; $t = \pi \Rightarrow R(-1, 0, 2)$ is on the curve. Then $\overline{PQ} = -\mathbf{i} + \mathbf{j} + \mathbf{k}$ and
 $\overline{PR} = -2\mathbf{i} + 2\mathbf{k} \Rightarrow \overline{PQ} \times \overline{PR} = \begin{bmatrix} \mathbf{i} & \mathbf{j} & \mathbf{k} \\ -1 & 1 & 1 \\ -2 & 0 & 2 \end{bmatrix} = 2\mathbf{i} + 2\mathbf{k}$ is a vector normal to the plane of P, Q , and R . Then

the plane containing P, Q , and R has an equation $2x + 2z = 2(1) + 2(0)$ or $x + z = 1$. Any point on the curve will satisfy this equation since $x + z = \cos t + (1 - \cos t) = 1$. Therefore, any point on the curve lies on the intersection of the cylinder $x^2 + y^2 = 1$ and the plane $x + z = 1 \Rightarrow$ the curve is an ellipse.

(b) $\mathbf{v} = (-\sin t)\mathbf{i} + (\cos t)\mathbf{j} + (\sin t)\mathbf{k} \Rightarrow |\mathbf{v}| = \sqrt{\sin^2 t + \cos^2 t + \sin^2 t} = \sqrt{1 + \sin^2 t}$
 $\Rightarrow \mathbf{T} = \frac{\mathbf{v}}{|\mathbf{v}|} = \frac{(-\sin t)\mathbf{i} + (\cos t)\mathbf{j} + (\sin t)\mathbf{k}}{\sqrt{1 + \sin^2 t}} \Rightarrow \mathbf{T}(0) = \mathbf{j}, \mathbf{T}\left(\frac{\pi}{2}\right) = \frac{-\mathbf{i} + \mathbf{k}}{\sqrt{2}}, \mathbf{T}(\pi) = -\mathbf{j}, \mathbf{T}\left(\frac{3\pi}{2}\right) = \frac{\mathbf{i} - \mathbf{k}}{\sqrt{2}}$

(c) $\mathbf{a} = (-\cos t)\mathbf{i} - (\sin t)\mathbf{j} + (\cos t)\mathbf{k}; \mathbf{n} = \mathbf{i} + \mathbf{k}$ is normal to the plane $x + z = 1$
 $\Rightarrow \mathbf{n} \cdot \mathbf{a} = -\cos t + \cos t = 0$
 $\Rightarrow \mathbf{a}$ is orthogonal to \mathbf{n}
 $\Rightarrow \mathbf{a}$ is parallel to the plane;
 $\mathbf{a}(0) = -\mathbf{i} + \mathbf{k}, \mathbf{a}\left(\frac{\pi}{2}\right) = -\mathbf{j}, \mathbf{a}(\pi) = \mathbf{i} - \mathbf{k}, \mathbf{a}\left(\frac{3\pi}{2}\right) = \mathbf{j}$

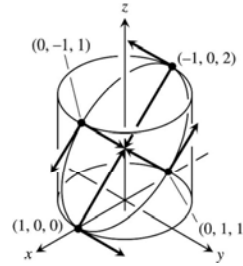

(d) $|\mathbf{v}| = \sqrt{1 + \sin^2 t}$ (See part (b)) $\Rightarrow L = \int_0^{2\pi} \sqrt{1 + \sin^2 t} dt$

(e) $L \approx 7.64$ (by *Mathematica*)

18. (a) $\mathbf{r} = (\cos 4t)\mathbf{i} + (\sin 4t)\mathbf{j} + 4t\mathbf{k} \Rightarrow \mathbf{v} = (-4\sin 4t)\mathbf{i} + (4\cos 4t)\mathbf{j} + 4\mathbf{k}$
 $\Rightarrow |\mathbf{v}| = \sqrt{(-4\sin 4t)^2 + (4\cos 4t)^2 + 4^2} = \sqrt{32} = 4\sqrt{2} \Rightarrow \text{Length} = \int_0^{\pi/2} 4\sqrt{2} dt = [4\sqrt{2}t]_0^{\pi/2} = 2\pi\sqrt{2}$

(b) $\mathbf{r} = \left(\cos \frac{t}{2}\right)\mathbf{i} + \left(\sin \frac{t}{2}\right)\mathbf{j} + \frac{t}{2}\mathbf{k} \Rightarrow \mathbf{v} = \left(-\frac{1}{2}\sin \frac{t}{2}\right)\mathbf{i} + \left(\frac{1}{2}\cos \frac{t}{2}\right)\mathbf{j} + \frac{1}{2}\mathbf{k}$
 $\Rightarrow |\mathbf{v}| = \sqrt{\left(-\frac{1}{2}\sin \frac{t}{2}\right)^2 + \left(\frac{1}{2}\cos \frac{t}{2}\right)^2 + \left(\frac{1}{2}\right)^2} = \sqrt{\frac{1}{4} + \frac{1}{4}} = \frac{\sqrt{2}}{2} \Rightarrow \text{Length} = \int_0^{4\pi} \frac{\sqrt{2}}{2} dt = \left[\frac{\sqrt{2}}{2}t\right]_0^{4\pi} = 2\pi\sqrt{2}$

(c) $\mathbf{r} = (\cos t)\mathbf{i} - (\sin t)\mathbf{j} - t\mathbf{k} \Rightarrow \mathbf{v} = (-\sin t)\mathbf{i} - (\cos t)\mathbf{j} - \mathbf{k} \Rightarrow |\mathbf{v}| = \sqrt{(-\sin t)^2 + (-\cos t)^2 + (-1)^2} = \sqrt{1 + 1} = \sqrt{2} \Rightarrow \text{Length} = \int_{-2\pi}^0 \sqrt{2} dt = [\sqrt{2}t]_{-2\pi}^0 = 2\pi\sqrt{2}$

19. $\angle PQB = \angle QOB = t$ and $PQ = \text{arc}(AQ) = t$ since $PQ = \text{length of the unwound string} = \text{length of arc}(AQ)$; thus $x = OB + BC = OB + DP = \cos t + t \sin t$, and $y = PC = QB - QD = \sin t - t \cos t$

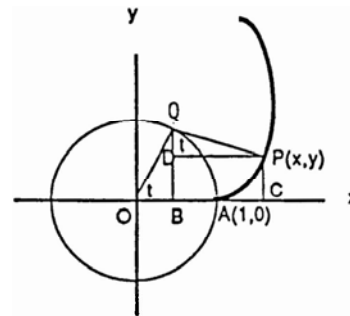

20. $\mathbf{r} = (\cos t + t \sin t)\mathbf{i} + (\sin t + t \cos t)\mathbf{j} \Rightarrow \mathbf{v} = (-\sin t + t \cos t + \sin t)\mathbf{i} + (\cos t - (t(-\sin t) + \cos t))\mathbf{j}$
 $= (t \cos t)\mathbf{i} + (t \sin t)\mathbf{j} \Rightarrow |\mathbf{v}| = \sqrt{(t \cos t)^2 + (t \sin t)^2} = \sqrt{t^2} = |t| = t, t \geq 0$
 $\Rightarrow \mathbf{T} = \frac{\mathbf{v}}{|\mathbf{v}|} = \frac{t \cos t}{t}\mathbf{i} + \frac{t \sin t}{t}\mathbf{j} = \cos t \mathbf{i} + \sin t \mathbf{j}$

21. $\mathbf{v} = \frac{d}{dt}(x_0 + t u_1)\mathbf{i} + \frac{d}{dt}(y_0 + t u_2)\mathbf{j} + \frac{d}{dt}(z_0 + t u_3)\mathbf{k} = u_1\mathbf{i} + u_2\mathbf{j} + u_3\mathbf{k} = \mathbf{u}$, so
 $s(t) = \int_0^t |\mathbf{v}| dt = \int_0^t |\mathbf{u}| d\tau = \int_0^t 1 d\tau = t$

22. $\mathbf{r}(t) = t\mathbf{i} + t^2\mathbf{j} + t^3\mathbf{k} \Rightarrow \mathbf{v}(t) = \mathbf{i} + 2t\mathbf{j} + 3t^2\mathbf{k} \Rightarrow |\mathbf{v}(t)| = \sqrt{(1)^2 + (2t)^2 + (3t^2)^2} = \sqrt{1 + 4t^2 + 9t^4}$. $(0, 0, 0) \Rightarrow t = 0$
 and $(2, 4, 8) \Rightarrow t = 2$. Thus $L = \int_0^2 |\mathbf{v}(t)| dt = \int_0^2 \sqrt{1 + 4t^2 + 9t^4} dt$. Using Simpson's rule with $n = 10$ and $\Delta x = \frac{2-0}{10} = 0.2$
 $\Rightarrow L \approx \frac{0.2}{3} (|\mathbf{v}(0)| + 4|\mathbf{v}(0.2)| + 2|\mathbf{v}(0.4)| + 4|\mathbf{v}(0.6)| + 2|\mathbf{v}(0.8)| + 4|\mathbf{v}(1)| + 2|\mathbf{v}(1.2)| + 4|\mathbf{v}(1.4)| + 2|\mathbf{v}(1.6)| + 4|\mathbf{v}(1.8)| + |\mathbf{v}(2)|)$
 $\approx \frac{0.2}{3} (1 + 4(1.0837) + 2(1.3676) + 4(1.8991) + 2(2.6919) + 4(3.7417) + 2(5.0421) + 4(6.5890) + 2(8.3800) + 4(10.4134) + 12.6886) = \frac{0.2}{3} (143.5594) \approx 9.5706$

13.4 CURVATURE AND NORMAL VECTORS OF A CURVE

1. $\mathbf{r} = t\mathbf{i} + \ln(\cos t)\mathbf{j} \Rightarrow \mathbf{v} = \mathbf{i} + \left(\frac{-\sin t}{\cos t}\right)\mathbf{j} = \mathbf{i} - (\tan t)\mathbf{j} \Rightarrow |\mathbf{v}| = \sqrt{1^2 + (-\tan t)^2} = \sqrt{\sec^2 t} = |\sec t| = \sec t$,
 since $-\frac{\pi}{2} < t < \frac{\pi}{2} \Rightarrow \mathbf{T} = \frac{\mathbf{v}}{|\mathbf{v}|} = \left(\frac{1}{\sec t}\right)\mathbf{i} - \left(\frac{\tan t}{\sec t}\right)\mathbf{j} = (\cos t)\mathbf{i} - (\sin t)\mathbf{j}$; $\frac{d\mathbf{T}}{dt} = (-\sin t)\mathbf{i} - (\cos t)\mathbf{j}$
 $\Rightarrow \left|\frac{d\mathbf{T}}{dt}\right| = \sqrt{(-\sin t)^2 + (-\cos t)^2} = 1 \Rightarrow \mathbf{N} = \frac{\left(\frac{d\mathbf{T}}{dt}\right)}{\left|\frac{d\mathbf{T}}{dt}\right|} = (-\sin t)\mathbf{i} - (\cos t)\mathbf{j}$; $\kappa = \frac{1}{|\mathbf{v}|} \cdot \left|\frac{d\mathbf{T}}{dt}\right| = \frac{1}{\sec t} \cdot 1 = \cos t$.

2. $\mathbf{r} = \ln(\sec t)\mathbf{i} + t\mathbf{j} \Rightarrow \mathbf{v} = \left(\frac{\sec t \tan t}{\sec t}\right)\mathbf{i} + \mathbf{j} = (\tan t)\mathbf{i} + \mathbf{j} \Rightarrow |\mathbf{v}| = \sqrt{(\tan t)^2 + 1^2} = \sqrt{\sec^2 t} = |\sec t| = \sec t$,
 since $-\frac{\pi}{2} < t < \frac{\pi}{2} \Rightarrow \mathbf{T} = \frac{\mathbf{v}}{|\mathbf{v}|} = \left(\frac{\tan t}{\sec t}\right)\mathbf{i} + \left(\frac{1}{\sec t}\right)\mathbf{j} = (\sin t)\mathbf{i} + (\cos t)\mathbf{j}$; $\frac{d\mathbf{T}}{dt} = (\cos t)\mathbf{i} - (\sin t)\mathbf{j}$
 $\Rightarrow \left|\frac{d\mathbf{T}}{dt}\right| = \sqrt{(\cos t)^2 + (\sin t)^2} = 1 \Rightarrow \mathbf{N} = \frac{\left(\frac{d\mathbf{T}}{dt}\right)}{\left|\frac{d\mathbf{T}}{dt}\right|} = (\cos t)\mathbf{i} - (\sin t)\mathbf{j}$; $\kappa = \frac{1}{|\mathbf{v}|} \cdot \left|\frac{d\mathbf{T}}{dt}\right| = \frac{1}{\sec t} \cdot 1 = \cos t$.

3. $\mathbf{r} = (2t+3)\mathbf{i} + (5-t^2)\mathbf{j} \Rightarrow \mathbf{v} = 2\mathbf{i} - 2t\mathbf{j} \Rightarrow |\mathbf{v}| = \sqrt{2^2 + (-2t)^2} = 2\sqrt{1+t^2} \Rightarrow \mathbf{T} = \frac{\mathbf{v}}{|\mathbf{v}|} = \frac{2}{2\sqrt{1+t^2}}\mathbf{i} + \frac{-2t}{2\sqrt{1+t^2}}\mathbf{j}$
 $= \frac{1}{\sqrt{1+t^2}}\mathbf{i} - \frac{t}{\sqrt{1+t^2}}\mathbf{j}$; $\frac{d\mathbf{T}}{dt} = \frac{-t}{(\sqrt{1+t^2})^3}\mathbf{i} - \frac{1}{(\sqrt{1+t^2})^3}\mathbf{j} \Rightarrow \left|\frac{d\mathbf{T}}{dt}\right| = \sqrt{\left(\frac{-t}{(\sqrt{1+t^2})^3}\right)^2 + \left(\frac{-1}{(\sqrt{1+t^2})^3}\right)^2} = \sqrt{\frac{1}{(1+t^2)^2}} = \frac{1}{1+t^2}$
 $\Rightarrow \mathbf{N} = \frac{\left(\frac{d\mathbf{T}}{dt}\right)}{\left|\frac{d\mathbf{T}}{dt}\right|} = \frac{-t}{\sqrt{1+t^2}}\mathbf{i} - \frac{1}{\sqrt{1+t^2}}\mathbf{j}$; $\kappa = \frac{1}{|\mathbf{v}|} \cdot \left|\frac{d\mathbf{T}}{dt}\right| = \frac{1}{2\sqrt{1+t^2}} \cdot \frac{1}{1+t^2} = \frac{1}{2(1+t^2)^{3/2}}$

4. $\mathbf{r} = (\cos t + t \sin t)\mathbf{i} + (\sin t - t \cos t)\mathbf{j} \Rightarrow \mathbf{v} = (t \cos t)\mathbf{i} + (t \sin t)\mathbf{j} \Rightarrow |\mathbf{v}| = \sqrt{(t \cos t)^2 + (t \sin t)^2} = \sqrt{t^2} = |t| = t$,
 since $t > 0 \Rightarrow \mathbf{T} = \frac{\mathbf{v}}{|\mathbf{v}|} = \frac{(t \cos t)\mathbf{i} + (t \sin t)\mathbf{j}}{t} = (\cos t)\mathbf{i} + (\sin t)\mathbf{j}$; $\frac{d\mathbf{T}}{dt} = (-\sin t)\mathbf{i} + (\cos t)\mathbf{j}$
 $\Rightarrow \left|\frac{d\mathbf{T}}{dt}\right| = \sqrt{(-\sin t)^2 + (\cos t)^2} = 1 \Rightarrow \mathbf{N} = \frac{\left(\frac{d\mathbf{T}}{dt}\right)}{\left|\frac{d\mathbf{T}}{dt}\right|} = (-\sin t)\mathbf{i} + (\cos t)\mathbf{j}$; $\kappa = \frac{1}{|\mathbf{v}|} \cdot \left|\frac{d\mathbf{T}}{dt}\right| = \frac{1}{t} \cdot 1 = \frac{1}{t}$

5. (a) $\kappa(x) = \frac{1}{|\mathbf{v}(x)|} \left| \frac{d\mathbf{T}(x)}{dt} \right|$. Now, $\mathbf{v} = \mathbf{i} + f'(x)\mathbf{j} \Rightarrow |\mathbf{v}(x)| = \sqrt{1 + [f'(x)]^2}$
 $\Rightarrow \mathbf{T} = \frac{\mathbf{v}}{|\mathbf{v}|} = \left(1 + [f'(x)]^2\right)^{-1/2} \mathbf{i} + f'(x) \left(1 + [f'(x)]^2\right)^{-1/2} \mathbf{j}$. Thus $\frac{d\mathbf{T}}{dt}(x) = \frac{-f'(x)f''(x)}{\left(1 + [f'(x)]^2\right)^{3/2}} \mathbf{i} + \frac{f''(x)}{\left(1 + [f'(x)]^2\right)^{3/2}} \mathbf{j}$
 $\Rightarrow \left| \frac{d\mathbf{T}(x)}{dt} \right| = \sqrt{\left[\frac{-f'(x)f''(x)}{\left(1 + [f'(x)]^2\right)^{3/2}} \right]^2 + \left[\frac{f''(x)}{\left(1 + [f'(x)]^2\right)^{3/2}} \right]^2} = \sqrt{\frac{[f''(x)]^2 \left(1 + [f'(x)]^2\right)}{\left(1 + [f'(x)]^2\right)^3}} = \frac{|f''(x)|}{\left(1 + [f'(x)]^2\right)^{3/2}}$
 Thus $\kappa(x) = \frac{1}{\left(1 + [f'(x)]^2\right)^{1/2}} \cdot \frac{|f''(x)|}{\left(1 + [f'(x)]^2\right)^{3/2}} = \frac{|f''(x)|}{\left(1 + [f'(x)]^2\right)^2}$
- (b) $y = \ln(\cos x) \Rightarrow \frac{dy}{dx} = \left(\frac{1}{\cos x}\right)(-\sin x) = -\tan x \Rightarrow \frac{d^2y}{dx^2} = -\sec^2 x \Rightarrow \kappa = \frac{|\sec^2 x|}{\left[1 + (-\tan x)^2\right]^{3/2}} = \frac{\sec^2 x}{|\sec^3 x|}$
 $= \frac{1}{\sec x} = \cos x$, since $-\frac{\pi}{2} < x < \frac{\pi}{2}$
- (c) Note that $f''(x) = 0$ at an inflection point.

6. (a) $\mathbf{r} = f(t)\mathbf{i} + g(t)\mathbf{j} = x\mathbf{i} + y\mathbf{j} \Rightarrow \mathbf{v} = \dot{x}\mathbf{i} + \dot{y}\mathbf{j} \Rightarrow |\mathbf{v}| = \sqrt{\dot{x}^2 + \dot{y}^2} \Rightarrow \mathbf{T} = \frac{\mathbf{v}}{|\mathbf{v}|} = \frac{\dot{x}}{\sqrt{\dot{x}^2 + \dot{y}^2}} \mathbf{i} + \frac{\dot{y}}{\sqrt{\dot{x}^2 + \dot{y}^2}} \mathbf{j}$
 $\frac{d\mathbf{T}}{dt} = \frac{\dot{y}(\dot{y}\ddot{x} - \dot{x}\ddot{y})}{(\dot{x}^2 + \dot{y}^2)^{3/2}} \mathbf{i} + \frac{\dot{x}(\dot{x}\ddot{y} - \dot{y}\ddot{x})}{(\dot{x}^2 + \dot{y}^2)^{3/2}} \mathbf{j} \Rightarrow \left| \frac{d\mathbf{T}}{dt} \right| = \sqrt{\left[\frac{\dot{y}(\dot{y}\ddot{x} - \dot{x}\ddot{y})}{(\dot{x}^2 + \dot{y}^2)^{3/2}} \right]^2 + \left[\frac{\dot{x}(\dot{x}\ddot{y} - \dot{y}\ddot{x})}{(\dot{x}^2 + \dot{y}^2)^{3/2}} \right]^2} = \sqrt{\frac{(\dot{y}^2 + \dot{x}^2)(\dot{y}\ddot{x} - \dot{x}\ddot{y})^2}{(\dot{x}^2 + \dot{y}^2)^3}} = \frac{|\dot{y}\ddot{x} - \dot{x}\ddot{y}|}{\dot{x}^2 + \dot{y}^2}$
 $\kappa = \frac{1}{|\mathbf{v}|} \cdot \left| \frac{d\mathbf{T}}{dt} \right| = \frac{1}{\sqrt{\dot{x}^2 + \dot{y}^2}} \cdot \frac{|\dot{y}\ddot{x} - \dot{x}\ddot{y}|}{\dot{x}^2 + \dot{y}^2} = \frac{|\dot{y}\ddot{x} - \dot{x}\ddot{y}|}{(\dot{x}^2 + \dot{y}^2)^{3/2}}$
- (b) $\mathbf{r}(t) = t\mathbf{i} + \ln(\sin t)\mathbf{j}$, $0 < t < \pi \Rightarrow x = t$ and $y = \ln(\sin t) \Rightarrow \dot{x} = 1, \ddot{x} = 0; \dot{y} = \frac{\cos t}{\sin t} = \cot t, \ddot{y} = -\csc^2 t$
 $\Rightarrow \kappa = \frac{|-\csc^2 t - 0|}{(1 + \cot^2 t)^{3/2}} = \frac{\csc^2 t}{\csc^3 t} = \sin t$
- (c) $\mathbf{r}(t) = \tan^{-1}(\sinh t)\mathbf{i} + \ln(\cosh t)\mathbf{j} \Rightarrow x = \tan^{-1}(\sinh t)$ and $y = \ln(\cosh t) \Rightarrow \dot{x} = \frac{\cosh t}{1 + \sinh^2 t} = \frac{1}{\cosh t}$
 $= \operatorname{sech} t, \ddot{x} = -\operatorname{sech} t \tanh t; \dot{y} = \frac{\sinh t}{\cosh t} = \tanh t, \ddot{y} = \operatorname{sech}^2 t \Rightarrow \kappa = \frac{|\operatorname{sech}^3 t + \operatorname{sech} t \tanh^2 t|}{(\operatorname{sech}^2 t + \tanh^2 t)} = |\operatorname{sech} t| = \operatorname{sech} t$

7. (a) $\mathbf{r}(t) = f(t)\mathbf{i} + g(t)\mathbf{j} \Rightarrow \mathbf{v} = f'(t)\mathbf{i} + g'(t)\mathbf{j}$ is tangent to the curve at the point $(f(t), g(t))$;
 $\mathbf{n} \cdot \mathbf{v} = [-g'(t)\mathbf{i} + f'(t)\mathbf{j}] \cdot [f'(t)\mathbf{i} + g'(t)\mathbf{j}] = -g'(t)f'(t) + f'(t)g'(t) = 0; -\mathbf{n} \cdot \mathbf{v} = -(\mathbf{n} \cdot \mathbf{v}) = 0$; thus, \mathbf{n} and $-\mathbf{n}$ are both normal to the curve at the point
- (b) $\mathbf{r}(t) = t\mathbf{i} + e^{2t}\mathbf{j} \Rightarrow \mathbf{v} = \mathbf{i} + 2e^{2t}\mathbf{j} \Rightarrow \mathbf{n} = -2e^{2t}\mathbf{i} + \mathbf{j}$ points toward the concave side of the curve; $\mathbf{N} = \frac{\mathbf{n}}{|\mathbf{n}|}$ and
 $|\mathbf{n}| = \sqrt{4e^{4t} + 1} \Rightarrow \mathbf{N} = \frac{-2e^{2t}}{\sqrt{4e^{4t} + 1}} \mathbf{i} + \frac{1}{\sqrt{4e^{4t} + 1}} \mathbf{j}$
- (c) $\mathbf{r}(t) = \sqrt{4-t^2}\mathbf{i} + t\mathbf{j} \Rightarrow \mathbf{v} = \frac{-t}{\sqrt{4-t^2}} \mathbf{i} + \mathbf{j} \Rightarrow \mathbf{n} = -\mathbf{i} - \frac{t}{\sqrt{4-t^2}} \mathbf{j}$ points toward the concave side of the curve;
 $\mathbf{N} = \frac{\mathbf{n}}{|\mathbf{n}|}$ and $|\mathbf{n}| = \sqrt{1 + \frac{t^2}{4-t^2}} = \frac{2}{\sqrt{4-t^2}} \Rightarrow \mathbf{N} = -\frac{1}{2} \left(\sqrt{4-t^2} \mathbf{i} + t \mathbf{j} \right)$

8. (a) $\mathbf{r}(t) = t\mathbf{i} + \frac{1}{3}t^3\mathbf{j} \Rightarrow \mathbf{v} = \mathbf{i} + t^2\mathbf{j} \Rightarrow \mathbf{n} = t^2\mathbf{i} - \mathbf{j}$ points toward the concave side of the curve when $t < 0$ and $-\mathbf{n} = -t^2\mathbf{i} + \mathbf{j}$ points toward the concave side when $t > 0 \Rightarrow \mathbf{N} = \frac{1}{\sqrt{1+t^4}}(t^2\mathbf{i} - \mathbf{j})$ for $t < 0$ and $\mathbf{N} = \frac{1}{\sqrt{1+t^4}}(-t^2\mathbf{i} + \mathbf{j})$ for $t > 0$
- (b) From part (a), $|\mathbf{v}| = \sqrt{1+t^4} \Rightarrow \mathbf{T} = \frac{1}{\sqrt{1+t^4}}\mathbf{i} + \frac{t^2}{\sqrt{1+t^4}}\mathbf{j} \Rightarrow \frac{d\mathbf{T}}{dt} = \frac{-2t^3}{(1+t^4)^{3/2}}\mathbf{i} + \frac{2t}{(1+t^4)^{3/2}}\mathbf{j} \Rightarrow \left| \frac{d\mathbf{T}}{dt} \right| = \sqrt{\frac{4t^6+4t^2}{(1+t^4)^3}} = \frac{2|t|}{1+t^4}$; $\mathbf{N} = \frac{\left(\frac{d\mathbf{T}}{dt}\right)}{\left|\frac{d\mathbf{T}}{dt}\right|} = \frac{1+t^4}{2|t|} \left(\frac{-2t^3}{(1+t^4)^{3/2}}\mathbf{i} + \frac{2t}{(1+t^4)^{3/2}}\mathbf{j} \right) = \frac{-t^3}{|t|\sqrt{1+t^4}}\mathbf{i} + \frac{t}{|t|\sqrt{1+t^4}}\mathbf{j}$; $t \neq 0$. \mathbf{N} does not exist at $t = 0$, where the curve has a point of inflection; $\left. \frac{d\mathbf{T}}{dt} \right|_{t=0} = 0$ so the curvature $\kappa = \left| \frac{d\mathbf{T}}{ds} \right| = \left| \frac{d\mathbf{T}}{ds} \cdot \frac{dt}{ds} \right| = 0$ at $t = 0 \Rightarrow \mathbf{N} = \frac{1}{\kappa} \frac{d\mathbf{T}}{ds}$ is undefined. Since $x = t$ and $y = \frac{1}{3}t^3 \Rightarrow y = \frac{1}{3}x^3$, the curve is the cubic power curve which is concave down for $x = t < 0$ and concave up for $x = t > 0$.

9. $\mathbf{r} = (3\sin t)\mathbf{i} + (3\cos t)\mathbf{j} + 4t\mathbf{k} \Rightarrow \mathbf{v} = (3\cos t)\mathbf{i} + (-3\sin t)\mathbf{j} + 4\mathbf{k} \Rightarrow |\mathbf{v}| = \sqrt{(3\cos t)^2 + (-3\sin t)^2 + 4^2} = \sqrt{25} = 5$
 $\Rightarrow \mathbf{T} = \frac{\mathbf{v}}{|\mathbf{v}|} = \left(\frac{3}{5}\cos t\right)\mathbf{i} - \left(\frac{3}{5}\sin t\right)\mathbf{j} + \frac{4}{5}\mathbf{k} \Rightarrow \frac{d\mathbf{T}}{dt} = \left(-\frac{3}{5}\sin t\right)\mathbf{i} - \left(\frac{3}{5}\cos t\right)\mathbf{j} \Rightarrow \left| \frac{d\mathbf{T}}{dt} \right| = \sqrt{\left(-\frac{3}{5}\sin t\right)^2 + \left(-\frac{3}{5}\cos t\right)^2} = \frac{3}{5}$
 $\Rightarrow \mathbf{N} = \frac{\left(\frac{d\mathbf{T}}{dt}\right)}{\left|\frac{d\mathbf{T}}{dt}\right|} = (-\sin t)\mathbf{i} - (\cos t)\mathbf{j}$; $\kappa = \frac{1}{5} \cdot \frac{3}{5} = \frac{3}{25}$

10. $\mathbf{r} = (\cos t + t\sin t)\mathbf{i} + (\sin t - t\cos t)\mathbf{j} + 3t\mathbf{k} \Rightarrow \mathbf{v} = (t\cos t)\mathbf{i} + (t\sin t)\mathbf{j} \Rightarrow |\mathbf{v}| = \sqrt{(t\cos t)^2 + (t\sin t)^2} = \sqrt{t^2} = |t| = t$, if $t > 0 \Rightarrow \mathbf{T} = \frac{\mathbf{v}}{|\mathbf{v}|} = (\cos t)\mathbf{i} - (\sin t)\mathbf{j}$, $t > 0 \Rightarrow \frac{d\mathbf{T}}{dt} = (-\sin t)\mathbf{i} + (\cos t)\mathbf{j}$
 $\Rightarrow \left| \frac{d\mathbf{T}}{dt} \right| = \sqrt{(-\sin t)^2 + (\cos t)^2} = 1 \Rightarrow \mathbf{N} = \frac{\left(\frac{d\mathbf{T}}{dt}\right)}{\left|\frac{d\mathbf{T}}{dt}\right|} = (-\sin t)\mathbf{i} + (\cos t)\mathbf{j}$; $\kappa = \frac{1}{t} \cdot 1 = \frac{1}{t}$

11. $\mathbf{r} = (e^t \cos t)\mathbf{i} + (e^t \sin t)\mathbf{j} + 2t\mathbf{k} \Rightarrow \mathbf{v} = (e^t \cos t - e^t \sin t)\mathbf{i} + (e^t \sin t + e^t \cos t)\mathbf{j}$
 $\Rightarrow |\mathbf{v}| = \sqrt{(e^t \cos t - e^t \sin t)^2 + (e^t \sin t + e^t \cos t)^2} = \sqrt{2e^{2t}} = e^t \sqrt{2}$; $\mathbf{T} = \frac{\mathbf{v}}{|\mathbf{v}|} = \left(\frac{\cos t - \sin t}{\sqrt{2}}\right)\mathbf{i} + \left(\frac{\sin t + \cos t}{\sqrt{2}}\right)\mathbf{j}$
 $\Rightarrow \frac{d\mathbf{T}}{dt} = \left(\frac{-\sin t - \cos t}{\sqrt{2}}\right)\mathbf{i} + \left(\frac{\cos t - \sin t}{\sqrt{2}}\right)\mathbf{j} \Rightarrow \left| \frac{d\mathbf{T}}{dt} \right| = \sqrt{\left(\frac{-\sin t - \cos t}{\sqrt{2}}\right)^2 + \left(\frac{\cos t - \sin t}{\sqrt{2}}\right)^2} = 1$
 $\Rightarrow \mathbf{N} = \frac{\left(\frac{d\mathbf{T}}{dt}\right)}{\left|\frac{d\mathbf{T}}{dt}\right|} = \left(\frac{-\cos t - \sin t}{\sqrt{2}}\right)\mathbf{i} + \left(\frac{-\sin t + \cos t}{\sqrt{2}}\right)\mathbf{j}$; $\kappa = \frac{1}{|\mathbf{v}|} \cdot \left| \frac{d\mathbf{T}}{dt} \right| = \frac{1}{e^t \sqrt{2}} \cdot 1 = \frac{1}{e^t \sqrt{2}}$

12. $\mathbf{r} = (6\sin 2t)\mathbf{i} + (6\cos 2t)\mathbf{j} + 5t\mathbf{k} \Rightarrow \mathbf{v} = (12\cos 2t)\mathbf{i} - (12\sin 2t)\mathbf{j} + 5\mathbf{k} \Rightarrow |\mathbf{v}| = \sqrt{(12\cos 2t)^2 + (-12\sin 2t)^2 + 5^2} = \sqrt{169} = 13 \Rightarrow \mathbf{T} = \frac{\mathbf{v}}{|\mathbf{v}|} = \left(\frac{12}{13}\cos 2t\right)\mathbf{i} - \left(\frac{12}{13}\sin 2t\right)\mathbf{j} + \frac{5}{13}\mathbf{k} \Rightarrow \frac{d\mathbf{T}}{dt} = \left(-\frac{24}{13}\sin 2t\right)\mathbf{i} - \left(\frac{24}{13}\cos 2t\right)\mathbf{j}$
 $\Rightarrow \left| \frac{d\mathbf{T}}{dt} \right| = \sqrt{\left(-\frac{24}{13}\sin 2t\right)^2 + \left(-\frac{24}{13}\cos 2t\right)^2} = \frac{24}{13} \Rightarrow \mathbf{N} = \frac{\left(\frac{d\mathbf{T}}{dt}\right)}{\left|\frac{d\mathbf{T}}{dt}\right|} = (-\sin 2t)\mathbf{i} - (\cos 2t)\mathbf{j}$; $\kappa = \frac{1}{|\mathbf{v}|} \cdot \left| \frac{d\mathbf{T}}{dt} \right| = \frac{1}{13} \cdot \frac{24}{13} = \frac{24}{169}$.

$$13. \mathbf{r} = \left(\frac{t^3}{3}\right)\mathbf{i} + \left(\frac{t^2}{2}\right)\mathbf{j}, t > 0 \Rightarrow \mathbf{v} = t^2\mathbf{i} + t\mathbf{j} \Rightarrow |\mathbf{v}| = \sqrt{t^4 + t^2} = t\sqrt{t^2 + 1}, \text{ since } t > 0 \Rightarrow \mathbf{T} = \frac{\mathbf{v}}{|\mathbf{v}|} = \frac{t}{\sqrt{t^2+1}}\mathbf{i} + \frac{1}{\sqrt{t^2+1}}\mathbf{j}$$

$$\Rightarrow \frac{d\mathbf{T}}{dt} = \frac{1}{(t^2+1)^{3/2}}\mathbf{i} - \frac{t}{(t^2+1)^{3/2}}\mathbf{j} \Rightarrow \left|\frac{d\mathbf{T}}{dt}\right| = \sqrt{\left(\frac{1}{(t^2+1)^{3/2}}\right)^2 + \left(\frac{-t}{(t^2+1)^{3/2}}\right)^2} = \sqrt{\frac{1+t^2}{(t^2+1)^3}} = \frac{1}{t^2+1}$$

$$\Rightarrow \mathbf{N} = \frac{\left(\frac{d\mathbf{T}}{dt}\right)}{\left|\frac{d\mathbf{T}}{dt}\right|} = \frac{1}{\sqrt{t^2+1}}\mathbf{i} - \frac{t}{\sqrt{t^2+1}}\mathbf{j}; \quad \kappa = \frac{1}{|\mathbf{v}|} \cdot \left|\frac{d\mathbf{T}}{dt}\right| = \frac{1}{t\sqrt{t^2+1}} \cdot \frac{1}{t^2+1} = \frac{1}{t(t^2+1)^{3/2}}.$$

$$14. \mathbf{r} = (\cos^3 t)\mathbf{i} + (\sin^3 t)\mathbf{j}, 0 < t < \frac{\pi}{2} \Rightarrow \mathbf{v} = (-3\cos^2 t \sin t)\mathbf{i} + (3\sin^2 t \cos t)\mathbf{j}$$

$$\Rightarrow |\mathbf{v}| = \sqrt{(-3\cos^2 t \sin t)^2 + (3\sin^2 t \cos t)^2} = \sqrt{9\cos^4 t \sin^2 t + 9\sin^4 t \cos^2 t} = 3\cos t \sin t, \text{ since } 0 < t < \frac{\pi}{2}$$

$$\Rightarrow \mathbf{T} = \frac{\mathbf{v}}{|\mathbf{v}|} = (-\cos t)\mathbf{i} + (\sin t)\mathbf{j} \Rightarrow \frac{d\mathbf{T}}{dt} = (-\sin t)\mathbf{i} + (\cos t)\mathbf{j} \Rightarrow \left|\frac{d\mathbf{T}}{dt}\right| = \sqrt{\sin^2 t + \cos^2 t} = 1$$

$$\Rightarrow \mathbf{N} = \frac{\left(\frac{d\mathbf{T}}{dt}\right)}{\left|\frac{d\mathbf{T}}{dt}\right|} = (-\sin t)\mathbf{i} + (\cos t)\mathbf{j}; \quad \kappa = \frac{1}{|\mathbf{v}|} \cdot \left|\frac{d\mathbf{T}}{dt}\right| = \frac{1}{3\cos t \sin t} \cdot 1 = \frac{1}{3\cos t \sin t}.$$

$$15. \mathbf{r} = t\mathbf{i} + \left(a \cosh \frac{t}{a}\right)\mathbf{j}, a > 0 \Rightarrow \mathbf{v} = \mathbf{i} + \left(\sinh \frac{t}{a}\right)\mathbf{j} \Rightarrow |\mathbf{v}| = \sqrt{1 + \sinh^2 \left(\frac{t}{a}\right)} = \sqrt{\cosh^2 \left(\frac{t}{a}\right)} = \cosh \frac{t}{a}$$

$$\Rightarrow \mathbf{T} = \frac{\mathbf{v}}{|\mathbf{v}|} = \left(\operatorname{sech} \frac{t}{a}\right)\mathbf{i} + \left(\tanh \frac{t}{a}\right)\mathbf{j} \Rightarrow \frac{d\mathbf{T}}{dt} = \left(-\frac{1}{a}\operatorname{sech} \frac{t}{a} \tanh \frac{t}{a}\right)\mathbf{i} + \left(\frac{1}{a}\operatorname{sech}^2 \frac{t}{a}\right)\mathbf{j}$$

$$\Rightarrow \left|\frac{d\mathbf{T}}{dt}\right| = \sqrt{\frac{1}{a^2}\operatorname{sech}^2 \left(\frac{t}{a}\right) \tanh^2 \left(\frac{t}{a}\right) + \frac{1}{a^2}\operatorname{sech}^4 \left(\frac{t}{a}\right)} = \frac{1}{a}\operatorname{sech} \left(\frac{t}{a}\right) \Rightarrow \mathbf{N} = \frac{\left(\frac{d\mathbf{T}}{dt}\right)}{\left|\frac{d\mathbf{T}}{dt}\right|} = \left(-\tanh \frac{t}{a}\right)\mathbf{i} + \left(\operatorname{sech} \frac{t}{a}\right)\mathbf{j};$$

$$\kappa = \frac{1}{|\mathbf{v}|} \cdot \left|\frac{d\mathbf{T}}{dt}\right| = \frac{1}{\cosh \frac{t}{a}} \cdot \frac{1}{a}\operatorname{sech} \left(\frac{t}{a}\right) = \frac{1}{a}\operatorname{sech}^2 \left(\frac{t}{a}\right).$$

$$16. \mathbf{r} = (\cosh t)\mathbf{i} - (\sinh t)\mathbf{j} + t\mathbf{k} \Rightarrow \mathbf{v} = (\sinh t)\mathbf{i} - (\cosh t)\mathbf{j} + \mathbf{k} \Rightarrow |\mathbf{v}| = \sqrt{\sinh^2 t + (-\cosh t)^2 + 1} = \sqrt{2} \cosh t$$

$$\Rightarrow \mathbf{T} = \frac{\mathbf{v}}{|\mathbf{v}|} = \left(\frac{1}{\sqrt{2}}\tanh t\right)\mathbf{i} - \frac{1}{\sqrt{2}}\mathbf{j} + \left(\frac{1}{\sqrt{2}}\operatorname{sech} t\right)\mathbf{k} \Rightarrow \frac{d\mathbf{T}}{dt} = \left(\frac{1}{\sqrt{2}}\operatorname{sech}^2 t\right)\mathbf{i} - \left(\frac{1}{\sqrt{2}}\operatorname{sech} t \tanh t\right)\mathbf{k}$$

$$\Rightarrow \left|\frac{d\mathbf{T}}{dt}\right| = \sqrt{\frac{1}{2}\operatorname{sech}^4 t + \frac{1}{2}\operatorname{sech}^2 t \tanh^2 t} = \frac{1}{\sqrt{2}}\operatorname{sech} t \Rightarrow \mathbf{N} = \frac{\left(\frac{d\mathbf{T}}{dt}\right)}{\left|\frac{d\mathbf{T}}{dt}\right|} = (\operatorname{sech} t)\mathbf{i} - (\tanh t)\mathbf{k};$$

$$\kappa = \frac{1}{|\mathbf{v}|} \cdot \left|\frac{d\mathbf{T}}{dt}\right| = \frac{1}{\sqrt{2}\cosh t} \cdot \frac{1}{\sqrt{2}}\operatorname{sech} t = \frac{1}{2}\operatorname{sech}^2 t.$$

$$17. y = ax^2 \Rightarrow y' = 2ax \Rightarrow y'' = 2a; \text{ from Exercise 5(a), } \kappa(x) = \frac{|2a|}{(1+4a^2x^2)^{3/2}} = |2a|(1+4a^2x^2)^{-3/2}$$

$\Rightarrow \kappa'(x) = -\frac{3}{2}|2a|(1+4a^2x^2)^{-5/2}(8a^2x)$; thus, $\kappa'(x) = 0 \Rightarrow x = 0$. Now, $\kappa'(x) > 0$ for $x < 0$ and $\kappa'(x) < 0$ for $x > 0$ so that $\kappa(x)$ has an absolute maximum at $x = 0$ which is the vertex of the parabola. Since $x = 0$ is the only critical point for $\kappa(x)$, the curvature has no minimum value.

18. $\mathbf{r} = (a \cos t)\mathbf{i} + (b \sin t)\mathbf{j} \Rightarrow \mathbf{v} = (-a \sin t)\mathbf{i} + (b \cos t)\mathbf{j} \Rightarrow \mathbf{a} = (-a \cos t)\mathbf{i} - (b \sin t)\mathbf{j}$
 $\Rightarrow \mathbf{v} \times \mathbf{a} = \begin{vmatrix} \mathbf{i} & \mathbf{j} & \mathbf{k} \\ -a \sin t & b \cos t & 0 \\ -a \cos t & -b \sin t & 0 \end{vmatrix} = ab\mathbf{k} \Rightarrow |\mathbf{v} \times \mathbf{a}| = |ab| = ab$, since $a > b > 0$; $\kappa(t) = \frac{|\mathbf{v} \times \mathbf{a}|}{|\mathbf{v}|^3}$
 $= ab(a^2 \sin^2 t + b^2 \cos^2 t)^{-3/2}$; $\kappa'(t) = -\frac{3}{2}(ab)(a^2 \sin^2 t + b^2 \cos^2 t)^{-5/2}(2a^2 \sin t \cos t - 2b^2 \sin t \cos t)$
 $= -\frac{3}{2}(ab)(a^2 - b^2)(\sin t)(a^2 \sin^2 t + b^2 \cos^2 t)^{-5/2}$; thus, $\kappa'(t) = 0 \Rightarrow \sin 2t = 0 \Rightarrow t = 0, \pi$ identifying points on the major axis, or $t = \frac{\pi}{2}, \frac{3\pi}{2}$ identifying points on the minor axis. Furthermore, $\kappa'(t) < 0$ for $0 < t < \frac{\pi}{2}$ and for $\pi < t < \frac{3\pi}{2}$; $\kappa'(t) > 0$ for $\frac{\pi}{2} < t < \pi$ and $\frac{3\pi}{2} < t < 2\pi$. Therefore, the points associated with $t = 0$ and $t = \pi$ on the major axis give absolute maximum curvature and the points associated with $t = \frac{\pi}{2}$ and $t = \frac{3\pi}{2}$ on the minor axis give absolute minimum curvature.

19. $\kappa = \frac{a}{a^2 + b^2} \Rightarrow \frac{d\kappa}{da} = \frac{-a^2 + b^2}{(a^2 + b^2)^2}$; $\frac{d\kappa}{da} = 0 \Rightarrow -a^2 + b^2 = 0 \Rightarrow a = \pm b \Rightarrow a = b$ since $a, b \geq 0$. Now, $\frac{d\kappa}{da} > 0$ if $a < b$ and $\frac{d\kappa}{da} < 0$ if $a > b \Rightarrow \kappa$ is at a maximum for $a = b$ and $\kappa(b) = \frac{b}{b^2 + b^2} = \frac{1}{2b}$ is the maximum value of κ .

20. (a) From Example 5, the curvature of the helix $\mathbf{r}(t) = (a \cos t)\mathbf{i} + (a \sin t)\mathbf{j} + bt\mathbf{k}$, $a, b \geq 0$ is $\kappa = \frac{a}{a^2 + b^2}$; also $|\mathbf{v}| = \sqrt{a^2 + b^2}$. For the helix $\mathbf{r}(t) = (3 \cos t)\mathbf{i} + (3 \sin t)\mathbf{j} + t\mathbf{k}$, $0 \leq t \leq 4\pi$, $a = 3$ and $b = 1 \Rightarrow \kappa = \frac{3}{3^2 + 1^2} = \frac{3}{10}$ and $|\mathbf{v}| = \sqrt{10} \Rightarrow K = \int_0^{4\pi} \frac{3}{10} \sqrt{10} dt = \left[\frac{3}{\sqrt{10}} t \right]_0^{4\pi} = \frac{12\pi}{\sqrt{10}}$

(b) $y = x^2 \Rightarrow x = t$ and $y = t^2$, $-\infty < t < \infty \Rightarrow \mathbf{r}(t) = t\mathbf{i} + t^2\mathbf{j} \Rightarrow \mathbf{v} = \mathbf{i} + 2t\mathbf{j} \Rightarrow |\mathbf{v}| = \sqrt{1 + 4t^2}$;
 $\mathbf{T} = \frac{1}{\sqrt{1 + 4t^2}}\mathbf{i} + \frac{2t}{\sqrt{1 + 4t^2}}\mathbf{j}$; $\frac{d\mathbf{T}}{dt} = \frac{-4t}{(1 + 4t^2)^{3/2}}\mathbf{i} + \frac{2}{(1 + 4t^2)^{3/2}}\mathbf{j}$; $\left| \frac{d\mathbf{T}}{dt} \right| = \sqrt{\frac{16t^2 + 4}{(1 + 4t^2)^3}} = \frac{2}{1 + 4t^2}$. Thus $\kappa = \frac{1}{\sqrt{1 + 4t^2}} \cdot \frac{2t}{1 + 4t^2}$
 $= \frac{2}{(\sqrt{1 + 4t^2})^3}$. Then $K = \int_{-\infty}^{\infty} \frac{2}{(\sqrt{1 + 4t^2})^3} (\sqrt{1 + 4t^2}) dt = \int_{-\infty}^{\infty} \frac{2}{1 + 4t^2} dt = \lim_{a \rightarrow -\infty} \int_a^0 \frac{2}{1 + 4t^2} dt + \lim_{b \rightarrow \infty} \int_0^b \frac{2}{1 + 4t^2} dt$
 $= \lim_{a \rightarrow -\infty} \left[\tan^{-1} 2t \right]_a^0 + \lim_{b \rightarrow \infty} \left[\tan^{-1} 2t \right]_0^b = \lim_{a \rightarrow -\infty} (-\tan^{-1} 2a) + \lim_{b \rightarrow \infty} (\tan^{-1} 2b) = \frac{\pi}{2} + \frac{\pi}{2} = \pi$

21. $\mathbf{r} = t\mathbf{i} + (\sin t)\mathbf{j} \Rightarrow \mathbf{v} = \mathbf{i} + (\cos t)\mathbf{j} \Rightarrow |\mathbf{v}| = \sqrt{1^2 + (\cos t)^2} = \sqrt{1 + \cos^2 t} \Rightarrow \left| \mathbf{v} \left(\frac{\pi}{2} \right) \right| = \sqrt{1 + \cos^2 \left(\frac{\pi}{2} \right)} = 1$;
 $\mathbf{T} = \frac{\mathbf{v}}{|\mathbf{v}|} = \frac{\mathbf{i} + (\cos t)\mathbf{j}}{\sqrt{1 + \cos^2 t}} \Rightarrow \frac{d\mathbf{T}}{dt} = \frac{-\sin t \cos t}{(1 + \cos^2 t)^{3/2}}\mathbf{i} + \frac{-\sin t}{(1 + \cos^2 t)^{3/2}}\mathbf{j} \Rightarrow \left| \frac{d\mathbf{T}}{dt} \right| = \frac{|\sin t|}{1 + \cos^2 t}$; $\left| \frac{d\mathbf{T}}{dt} \right|_{t=\frac{\pi}{2}} = \frac{|\sin \frac{\pi}{2}|}{1 + \cos^2 \left(\frac{\pi}{2} \right)} = \frac{1}{1} = 1$. Thus $\kappa \left(\frac{\pi}{2} \right) = \frac{1}{1} \cdot 1 = 1 \Rightarrow \rho = \frac{1}{1} = 1$ and the center is $\left(\frac{\pi}{2}, 0 \right) \Rightarrow \left(x - \frac{\pi}{2} \right)^2 + y^2 = 1$

22. $\mathbf{r} = (2 \ln t)\mathbf{i} - \left(t + \frac{1}{t} \right)\mathbf{j} \Rightarrow \mathbf{v} = \left(\frac{2}{t} \right)\mathbf{i} - \left(1 - \frac{1}{t^2} \right)\mathbf{j} \Rightarrow |\mathbf{v}| = \sqrt{\frac{4}{t^2} + \left(1 - \frac{1}{t^2} \right)^2} = \frac{t^2 + 1}{t^2} \Rightarrow \mathbf{T} = \frac{\mathbf{v}}{|\mathbf{v}|} = \frac{2t}{t^2 + 1}\mathbf{i} - \frac{t^2 - 1}{t^2 + 1}\mathbf{j}$;
 $\frac{d\mathbf{T}}{dt} = \frac{-2(t^2 - 1)}{(t^2 + 1)^2}\mathbf{i} - \frac{4t}{(t^2 + 1)^2}\mathbf{j} \Rightarrow \left| \frac{d\mathbf{T}}{dt} \right| = \sqrt{\frac{4(t^2 - 1)^2 + 16t^2}{(t^2 + 1)^4}} = \frac{2}{t^2 + 1}$. Thus $\kappa = \frac{1}{|\mathbf{v}|} \cdot \left| \frac{d\mathbf{T}}{dt} \right| = \frac{t^2}{t^2 + 1} \cdot \frac{2}{t^2 + 1} = \frac{2t^2}{(t^2 + 1)^2}$

$\Rightarrow \kappa(1) = \frac{2}{2^2} = \frac{1}{2} \Rightarrow \rho = \frac{1}{\kappa} = 2$. The circle of curvature is tangent to the curve at $P(0, -2) \Rightarrow$ circle has same tangent as the curve $\Rightarrow \mathbf{v}(1) = 2\mathbf{i}$ is tangent to the circle \Rightarrow the center lies on the y -axis. If $t \neq 1 (t > 0)$, then $(t-1)^2 > 0 \Rightarrow t^2 - 2t + 1 > 0 \Rightarrow t^2 + 1 > 2t \Rightarrow \frac{t^2+1}{t} > 2$ since $t > 0 \Rightarrow t + \frac{1}{t} > 2 \Rightarrow -(t + \frac{1}{t}) < -2 \Rightarrow y < -2$ on both sides of $(0, -2) \Rightarrow$ the curve is concave down \Rightarrow center of circle of curvature is $(0, -4) \Rightarrow x^2 + (y+4)^2 = 4$ is an equation of the circle of curvature

23. $y = x^2 \Rightarrow f'(x) = 2x$ and $f''(x) = 2$

$$\Rightarrow \kappa = \frac{|2|}{(1+(2x)^2)^{3/2}} = \frac{2}{(1+4x^2)^{3/2}}$$

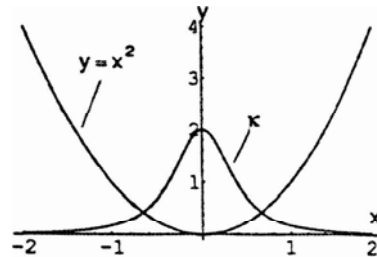

24. $y = \frac{x^4}{4} \Rightarrow f'(x) = x^3$ and $f''(x) = 3x^2$

$$\Rightarrow \kappa = \frac{|3x^2|}{(1+(x^3)^2)^{3/2}} = \frac{3x^2}{(1+x^6)^{3/2}}$$

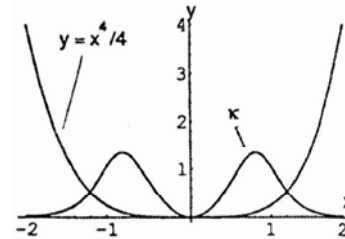

25. $y = \sin x \Rightarrow f'(x) = \cos x$ and $f''(x) = -\sin x$

$$\Rightarrow \kappa = \frac{|-\sin x|}{(1+\cos^2 x)^{3/2}} = \frac{|\sin x|}{(1+\cos^2 x)^{3/2}}$$

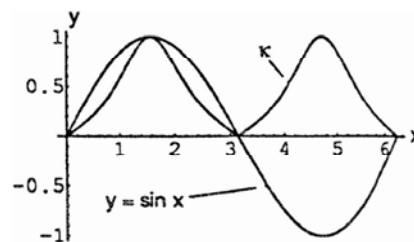

26. $y = e^x \Rightarrow f'(x) = e^x$ and $f''(x) = e^x$

$$\Rightarrow \kappa = \frac{|e^x|}{(1+(e^x)^2)^{3/2}} = \frac{e^x}{(1+e^{2x})^{3/2}}$$

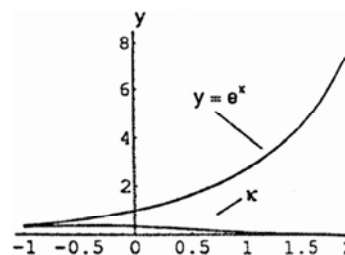

27. We will use the formula $\kappa = \frac{1}{|\mathbf{v}(a)|} \left| \frac{d\mathbf{T}}{dt}(a) \right|$ to find the curvature at the point (a, a^2) .

By Example 4 in Section 13.4,

$$\mathbf{v}(t) = \sqrt{1+4t^2} \text{ and } \frac{d\mathbf{T}}{dt} = 2(1+4t^2)^{-3/2}(-2t\mathbf{i} + \mathbf{j}).$$

At $t = a$ this gives $\kappa = \frac{1}{|\mathbf{v}(a)|} \left| \frac{d\mathbf{T}}{dt}(a) \right| = \frac{2}{\sqrt{1+4a^2}} (1+4a^2)^{-3/2} \sqrt{1+4a^2} = \frac{2}{(1+4a^2)^{3/2}}$. Thus the radius of

the osculating circle is $r = \frac{1}{2}(1+4a^2)^{3/2}$. To show that the given formulas for center and radius are correct we must first show that the distance between (a, a^2) and $(-4a^3, 3a^2 + \frac{1}{2})$ is r . This distance is

$$\sqrt{\left(-4a^3 - a\right)^2 + \left(3a^2 + \frac{1}{2} - a^2\right)^2} = \sqrt{16a^6 + 12a^4 + 3a^2 + \frac{1}{4}} = \frac{1}{2}\sqrt{\left(1+4a^2\right)^3}$$
 as required. Finally we must show

that the line containing the points $(-4a^3, 3a^2 + \frac{1}{2})$ and (a, a^2) is perpendicular to the tangent line at (a, a^2) ,

which has slope $2a$. This requires that $\frac{3a^2 + \frac{1}{2} - a^2}{-4a^3 - a} = -\frac{1}{2a}$, which is correct.

28. By Exercise 27, for $a = 1$, the center of the osculating circle is at $(-4, \frac{7}{2})$ and its radius is $\frac{5\sqrt{5}}{2}$. A

parametrization of this circle is $x(\theta) = -4 + \frac{5\sqrt{5}}{2}\cos\theta$, $y(\theta) = \frac{7}{2} + \frac{5\sqrt{5}}{2}\sin\theta$.

29-36. Example CAS commands:

Maple:

```
with( plots );
r := t -> [3*cos(t),5*sin(t)];
lo := 0;
hi := 2*Pi;
t0 := Pi/4;
P1 := plot( [r(t)[], t=lo..hi] );
display( P1, scaling=constrained, title="#29(a) (Section 13.4)" );
CURVATURE := (x,y,t) -> simplify(abs(diff(x,t)*diff(y,t,t)-diff(y,t)*diff(x,t,t))/
(diff(x,t)^2+diff(y,t)^2)^(3/2));
kappa := eval(CURVATURE(r(t)[],t),t=t0);
UnitNormal := (x,y,t) -> expand( [-diff(y,t),diff(x,t)]/sqrt(diff(x,t)^2+diff(y,t)^2) );
N := eval( UnitNormal(r(t)[],t), t=t0 );
C := expand( r(t0) + N/kappa );
OscCircle := (x-C[1])^2+(y-C[2])^2 = 1/kappa^2;
evalf( OscCircle );
P2 := implicitplot( (x-C[1])^2+(y-C[2])^2 = 1/kappa^2, x=-7.4, y=-4..6, color=blue );
display( [P1,P2], scaling=constrained, title="#27(e) (Section 13.4)" );
```

Mathematica: (assigned functions and parameters may vary)

In Mathematica, the dot product can be applied either with a period "." or with the word, "Dot". Similarly, the cross product can be applied either with a very small "x" (in the palette next to the arrow) or with the word, "Cross". However, the Cross command assumes the vectors are in three dimensions. For the purposes of applying the cross product command, we will define the position vector r as a three dimensional vector with zero for its z -component. For graphing, we will use only the first two components.

```

Clear[r, t, x, y]
r[t_]= {3 Cos[t], 5 Sin[t]}
t0= π/4; tmin= 0; tmax= 2π;
r2[t_]= {r[t][[1]], r[t][[2]]}
pp=ParametricPlot[r2[t], {t, tmin, tmax}];
mag[v_]=Sqrt[v.v]
vel[t_]= r'[t]
speed[t_]=mag[vel[t]]
acc[t_]= vel'[t]

curv[t_]= mag[Cross[vel[t],acc[t]]]/speed[t]^3//Simplify
unittan[t_]= vel[t]/speed[t]//Simplify
unitnorm[t_]= unittan'[t]/ mag[unittan'[t]]
ctr= r[t0]+(1/curv[t0]) unitnorm[t0]//Simplify
{a,b}= {ctr[[1]], ctr[[2]]}

```

To plot the osculating circle, load a graphics package and then plot it, and show it together with the original curve.

```

<< Graphics`ImplicitPlot`
pc=ImplicitPlot[(x - a)^2 + (y - b)^2 == 1/curv[t0]^2, {x, -8, 8}, {y, -8, 8}]
radius=Graphics[Line[{a, b}, r2[t0]}]
Show[pp, pc, radius, AspectRatio -> 1]

```

13.5 TANGENTIAL AND NORMAL COMPONENTS OF ACCELERATION

- $$\mathbf{r} = (a \cos t)\mathbf{i} + (a \sin t)\mathbf{j} + b\mathbf{k} \Rightarrow \mathbf{v} = (-a \sin t)\mathbf{i} + (a \cos t)\mathbf{j} + b\mathbf{k} \Rightarrow |\mathbf{v}| = \sqrt{(-a \sin t)^2 + (a \cos t)^2 + b^2}$$

$$= \sqrt{a^2 + b^2} \Rightarrow a_T = \frac{d}{dt}|\mathbf{v}| = 0; \quad \mathbf{a} = (-a \cos t)\mathbf{i} + (-a \sin t)\mathbf{j} \Rightarrow |\mathbf{a}| = \sqrt{(-a \cos t)^2 + (-a \sin t)^2} = \sqrt{a^2} = |a|$$

$$\Rightarrow a_N = \sqrt{|\mathbf{a}|^2 - a_T^2} = \sqrt{|\mathbf{a}|^2 - 0^2} = |\mathbf{a}| = |a| \Rightarrow \mathbf{a} = (0)\mathbf{T} + |a|\mathbf{N} = |a|\mathbf{N}$$
- $$\mathbf{r} = (1 + 3t)\mathbf{i} + (t - 2)\mathbf{j} - 3t\mathbf{k} \Rightarrow \mathbf{v} = 3\mathbf{i} + \mathbf{j} - 3\mathbf{k} \Rightarrow |\mathbf{v}| = \sqrt{3^2 + 1^2 + (-3)^2} = \sqrt{19} \Rightarrow a_T = \frac{d}{dt}|\mathbf{v}| = 0;$$

$$\mathbf{a} = \mathbf{0} \Rightarrow a_N = \sqrt{|\mathbf{a}|^2 - a_T^2} = 0 \Rightarrow \mathbf{a} = (0)\mathbf{T} + (0)\mathbf{N} = \mathbf{0}$$
- $$\mathbf{r} = (t + 1)\mathbf{i} + 2t\mathbf{j} + t^2\mathbf{k} \Rightarrow \mathbf{v} = \mathbf{i} + 2\mathbf{j} + 2t\mathbf{k} \Rightarrow |\mathbf{v}| = \sqrt{1^2 + 2^2 + (2t)^2} = \sqrt{5 + 4t^2} \Rightarrow a_T = \frac{1}{2}(5 + 4t^2)^{-1/2} (8t)$$

$$= 4t(5 + 4t^2)^{-1/2} \Rightarrow a_T(1) = \frac{4}{\sqrt{9}} = \frac{4}{3}; \quad \mathbf{a} = 2\mathbf{k} \Rightarrow \mathbf{a}(1) = 2\mathbf{k} \Rightarrow |\mathbf{a}(1)| = 2$$

$$\Rightarrow a_N = \sqrt{|\mathbf{a}|^2 - a_T^2} = \sqrt{2^2 - \left(\frac{4}{3}\right)^2} = \sqrt{\frac{20}{9}} = \frac{2\sqrt{5}}{3} \Rightarrow \mathbf{a}(1) = \frac{4}{3}\mathbf{T} + \frac{2\sqrt{5}}{3}\mathbf{N}$$

4. $\mathbf{r} = (t \cos t)\mathbf{i} + (t \sin t)\mathbf{j} + t^2\mathbf{k} \Rightarrow \mathbf{v} = (\cos t - t \sin t)\mathbf{i} + (\sin t + t \cos t)\mathbf{j} + 2t\mathbf{k}$
 $\Rightarrow |\mathbf{v}| = \sqrt{(\cos t - t \sin t)^2 + (\sin t + t \cos t)^2 + (2t)^2} = \sqrt{5t^2 + 1} \Rightarrow a_T = \frac{1}{2}(5t^2 + 1)^{-1/2} (10t) = \frac{5t}{\sqrt{5t^2 + 1}}$
 $\Rightarrow a_T(0) = 0; \mathbf{a} = (-2 \sin t - t \cos t)\mathbf{i} + (2 \cos t - t \sin t)\mathbf{j} + 2\mathbf{k} \Rightarrow \mathbf{a}(0) = 2\mathbf{j} + 2\mathbf{k} \Rightarrow |\mathbf{a}(0)| = \sqrt{2^2 + 2^2} = 2\sqrt{2}$
 $\Rightarrow a_N = \sqrt{|\mathbf{a}|^2 - a_T^2} = \sqrt{(2\sqrt{2})^2 - 0^2} = 2\sqrt{2} \Rightarrow \mathbf{a}(0) = (0)\mathbf{T} + 2\sqrt{2}\mathbf{N} = 2\sqrt{2}\mathbf{N}$
5. $\mathbf{r} = t^2\mathbf{i} + (t + \frac{1}{3}t^3)\mathbf{j} + (t - \frac{1}{3}t^3)\mathbf{k} \Rightarrow \mathbf{v} = 2t\mathbf{i} + (1 + t^2)\mathbf{j} + (1 - t^2)\mathbf{k} \Rightarrow |\mathbf{v}| = \sqrt{(2t)^2 + (1 + t^2)^2 + (1 - t^2)^2}$
 $= \sqrt{2(t^4 + 2t^2 + 1)} = \sqrt{2}(1 + t^2) \Rightarrow a_T = 2t\sqrt{2} \Rightarrow a_T(0) = 0; \mathbf{a} = 2\mathbf{i} + 2t\mathbf{j} - 2t\mathbf{k} \Rightarrow \mathbf{a}(0) = 2\mathbf{i} \Rightarrow |\mathbf{a}(0)| = 2$
 $\Rightarrow a_N = \sqrt{|\mathbf{a}|^2 - a_T^2} = \sqrt{2^2 - 0^2} = 2 \Rightarrow \mathbf{a}(0) = (0)\mathbf{T} + 2\mathbf{N} = 2\mathbf{N}$
6. $\mathbf{r} = (e^t \cos t)\mathbf{i} + (e^t \sin t)\mathbf{j} + \sqrt{2}e^t\mathbf{k} \Rightarrow \mathbf{v} = (e^t \cos t - e^t \sin t)\mathbf{i} + (e^t \sin t + e^t \cos t)\mathbf{j} + \sqrt{2}e^t\mathbf{k}$
 $\Rightarrow |\mathbf{v}| = \sqrt{(e^t \cos t - e^t \sin t)^2 + (e^t \sin t + e^t \cos t)^2 + (\sqrt{2}e^t)^2} = \sqrt{4e^{2t}} = 2e^t \Rightarrow a_T = 2e^t \Rightarrow a_T(0) = 2;$
 $\mathbf{a} = (e^t \cos t - e^t \sin t - e^t \sin t - e^t \cos t)\mathbf{i} + (e^t \sin t + e^t \cos t + e^t \cos t - e^t \sin t)\mathbf{j} + \sqrt{2}e^t\mathbf{k}$
 $= (-2e^t \sin t)\mathbf{i} + (2e^t \cos t)\mathbf{j} + \sqrt{2}e^t\mathbf{k} \Rightarrow \mathbf{a}(0) = 2\mathbf{j} + \sqrt{2}\mathbf{k} \Rightarrow |\mathbf{a}(0)| = \sqrt{2^2 + (\sqrt{2})^2} = \sqrt{6}$
 $\Rightarrow a_N = \sqrt{|\mathbf{a}|^2 - a_T^2} = \sqrt{(\sqrt{6})^2 - 2^2} = \sqrt{2} \Rightarrow \mathbf{a}(0) = 2\mathbf{T} + \sqrt{2}\mathbf{N}$
7. $\mathbf{r} = (\cos t)\mathbf{i} + (\sin t)\mathbf{j} - \mathbf{k} \Rightarrow \mathbf{v} = (-\sin t)\mathbf{i} + (\cos t)\mathbf{j} \Rightarrow |\mathbf{v}| = \sqrt{(-\sin t)^2 + (\cos t)^2} = 1$
 $\Rightarrow \mathbf{T} = \frac{\mathbf{v}}{|\mathbf{v}|} = (-\sin t)\mathbf{i} + (\cos t)\mathbf{j} \Rightarrow \mathbf{T}\left(\frac{\pi}{4}\right) = -\frac{\sqrt{2}}{2}\mathbf{i} + \frac{\sqrt{2}}{2}\mathbf{j}; \frac{d\mathbf{T}}{dt} = (-\cos t)\mathbf{i} - (\sin t)\mathbf{j}$
 $\Rightarrow \left|\frac{d\mathbf{T}}{dt}\right| \sqrt{(-\cos t)^2 + (-\sin t)^2} = 1 \Rightarrow \mathbf{N} = \frac{\left(\frac{d\mathbf{T}}{dt}\right)}{\left|\frac{d\mathbf{T}}{dt}\right|} = (-\cos t)\mathbf{i} - (\sin t)\mathbf{j} \Rightarrow \mathbf{N}\left(\frac{\pi}{4}\right) = -\frac{\sqrt{2}}{2}\mathbf{i} - \frac{\sqrt{2}}{2}\mathbf{j};$
 $\mathbf{B} = \mathbf{T} \times \mathbf{N} = \begin{vmatrix} \mathbf{i} & \mathbf{j} & \mathbf{k} \\ -\sin t & \cos t & 0 \\ -\cos t & -\sin t & 0 \end{vmatrix} = \mathbf{k} \Rightarrow \mathbf{B}\left(\frac{\pi}{4}\right) = \mathbf{k}, \text{ the normal to the osculating plane; } \mathbf{r}\left(\frac{\pi}{4}\right) = \frac{\sqrt{2}}{2}\mathbf{i} + \frac{\sqrt{2}}{2}\mathbf{j} - \mathbf{k}$
 $\Rightarrow P = \left(\frac{\sqrt{2}}{2}, \frac{\sqrt{2}}{2}, -1\right)$ lies on the osculating plane $\Rightarrow 0\left(x - \frac{\sqrt{2}}{2}\right) + 0\left(y - \frac{\sqrt{2}}{2}\right) + (z - (-1)) = 0 \Rightarrow z = -1$ is the
 osculating plane; \mathbf{T} is normal to the normal plane $\Rightarrow \left(-\frac{\sqrt{2}}{2}\right)\left(x - \frac{\sqrt{2}}{2}\right) + \left(\frac{\sqrt{2}}{2}\right)\left(y - \frac{\sqrt{2}}{2}\right) + 0(z - (-1)) = 0$
 $\Rightarrow -\frac{\sqrt{2}}{2}x + \frac{\sqrt{2}}{2}y = 0 \Rightarrow -x + y = 0$ is the normal plane; \mathbf{N} is normal to the rectifying plane
 $\Rightarrow \left(-\frac{\sqrt{2}}{2}\right)\left(x - \frac{\sqrt{2}}{2}\right) + \left(-\frac{\sqrt{2}}{2}\right)\left(y - \frac{\sqrt{2}}{2}\right) + 0(z - (-1)) = 0 \Rightarrow -\frac{\sqrt{2}}{2}x - \frac{\sqrt{2}}{2}y = -1 \Rightarrow x + y = \sqrt{2}$ is the rectifying
 plane.

$$\begin{aligned}
 8. \quad \mathbf{r} &= (\cos t)\mathbf{i} + (\sin t)\mathbf{j} + t\mathbf{k} \Rightarrow \mathbf{v} = (-\sin t)\mathbf{i} + (\cos t)\mathbf{j} + \mathbf{k} \Rightarrow |\mathbf{v}| = \sqrt{\sin^2 t + \cos^2 t + 1} = \sqrt{2} \\
 &\Rightarrow \mathbf{T} = \frac{\mathbf{v}}{|\mathbf{v}|} = \left(-\frac{1}{\sqrt{2}}\sin t\right)\mathbf{i} + \left(\frac{1}{\sqrt{2}}\cos t\right)\mathbf{j} + \frac{1}{\sqrt{2}}\mathbf{k} \Rightarrow \frac{d\mathbf{T}}{dt} = \left(-\frac{1}{\sqrt{2}}\cos t\right)\mathbf{i} + \left(-\frac{1}{\sqrt{2}}\sin t\right)\mathbf{j} \\
 &\Rightarrow \left|\frac{d\mathbf{T}}{dt}\right| = \sqrt{\frac{1}{2}\cos^2 t + \frac{1}{2}\sin^2 t} = \frac{1}{\sqrt{2}} \Rightarrow \mathbf{N} = \frac{\left(\frac{d\mathbf{T}}{dt}\right)}{\left|\frac{d\mathbf{T}}{dt}\right|} = (-\cos t)\mathbf{i} - (\sin t)\mathbf{j}; \text{ thus } \mathbf{T}(0) = \frac{1}{\sqrt{2}}\mathbf{j} + \frac{1}{\sqrt{2}}\mathbf{k} \text{ and } \mathbf{N}(0) = -\mathbf{i}
 \end{aligned}$$

$$\Rightarrow \mathbf{B}(0) = \begin{vmatrix} \mathbf{i} & \mathbf{j} & \mathbf{k} \\ 0 & \frac{1}{\sqrt{2}} & \frac{1}{\sqrt{2}} \\ -1 & 0 & 0 \end{vmatrix} = -\frac{1}{\sqrt{2}}\mathbf{j} + \frac{1}{\sqrt{2}}\mathbf{k}, \text{ the normal to the osculating plane; } \mathbf{r}(0) = \mathbf{i} \Rightarrow P(1, 0, 0) \text{ lies on the}$$

osculating plane $\Rightarrow 0(x-1) - \frac{1}{\sqrt{2}}(y-0) + \frac{1}{\sqrt{2}}(z-0) = 0 \Rightarrow y-z=0$ is the osculating plane; \mathbf{T} is normal to the normal plane $\Rightarrow 0(x-1) + \frac{1}{\sqrt{2}}(y-0) + \frac{1}{\sqrt{2}}(z-0) = 0 \Rightarrow y+z=0$ is the normal plane; \mathbf{N} is normal to the rectifying plane $\Rightarrow -1(x-1) + 0(y-0) + 0(z-0) = 0 \Rightarrow x=1$ is the rectifying plane.

9. By Exercise 9 in Section 13.4, $\mathbf{T} = \left(\frac{3}{5}\cos t\right)\mathbf{i} + \left(-\frac{3}{5}\sin t\right)\mathbf{j} + \frac{4}{5}\mathbf{k}$ and $\mathbf{N} = (-\sin t)\mathbf{i} - (\cos t)\mathbf{j}$ so that

$$\mathbf{B} = \mathbf{T} \times \mathbf{N} = \begin{vmatrix} \mathbf{i} & \mathbf{j} & \mathbf{k} \\ \frac{3}{5}\cos t & -\frac{3}{5}\sin t & \frac{4}{5} \\ -\sin t & -\cos t & 0 \end{vmatrix} = \left(\frac{4}{5}\cos t\right)\mathbf{i} - \left(\frac{4}{5}\sin t\right)\mathbf{j} - \frac{3}{5}\mathbf{k}. \text{ Also } \mathbf{v} = (3\cos t)\mathbf{i} + (-3\sin t)\mathbf{j} + 4\mathbf{k}$$

$$\Rightarrow \mathbf{a} = (-3\sin t)\mathbf{i} + (-3\cos t)\mathbf{j} \Rightarrow \frac{d\mathbf{a}}{dt} = (-3\cos t)\mathbf{i} + (3\sin t)\mathbf{j} \text{ and } \mathbf{v} \times \mathbf{a} = \begin{vmatrix} \mathbf{i} & \mathbf{j} & \mathbf{k} \\ 3\cos t & -3\sin t & 4 \\ -3\sin t & -3\cos t & 0 \end{vmatrix}$$

$$= (12\cos t)\mathbf{i} - (12\sin t)\mathbf{j} - 9\mathbf{k} \Rightarrow |\mathbf{v} \times \mathbf{a}|^2 = (12\cos t)^2 + (-12\sin t)^2 + (-9)^2 = 225. \text{ Thus}$$

$$\tau = \frac{\begin{vmatrix} 3\cos t & -3\sin t & 4 \\ -3\sin t & -3\cos t & 0 \\ -3\cos t & 3\sin t & 0 \end{vmatrix}}{225} = \frac{4(-9\sin^2 t - 9\cos^2 t)}{225} = \frac{-36}{225} = -\frac{4}{25}$$

10. By Exercise 10 in Section 13.4, $\mathbf{T} = (\cos t)\mathbf{i} + (\sin t)\mathbf{j}$ and $\mathbf{N} = (-\sin t)\mathbf{i} + (\cos t)\mathbf{j}$; thus

$$\mathbf{B} = \mathbf{T} \times \mathbf{N} = \begin{vmatrix} \mathbf{i} & \mathbf{j} & \mathbf{k} \\ \cos t & \sin t & 0 \\ -\sin t & \cos t & 0 \end{vmatrix} = (\cos^2 t + \sin^2 t)\mathbf{k} = \mathbf{k}. \text{ Also } \mathbf{v} = (t\cos t)\mathbf{i} + (t\sin t)\mathbf{j}$$

$$\Rightarrow \mathbf{a} = (t(-\sin t) + \cos t)\mathbf{i} + (t\cos t + \sin t)\mathbf{j} \Rightarrow \frac{d\mathbf{a}}{dt} = (-t\cos t - \sin t - \sin t)\mathbf{i} + (-t\sin t + \cos t + \cos t)\mathbf{j}$$

$$= (-t\cos t - 2\sin t)\mathbf{i} + (2\cos t - t\sin t)\mathbf{j}. \text{ Thus } \mathbf{v} \times \mathbf{a} = \begin{vmatrix} \mathbf{i} & \mathbf{j} & \mathbf{k} \\ t\cos t & t\sin t & 0 \\ -t\sin t + \cos t & t\cos t + \sin t & 0 \end{vmatrix}$$

$$= [(t\cos t)(t\cos t + \sin t) - (t\sin t)(-t\sin t + \cos t)]\mathbf{k} = t^2\mathbf{k} \Rightarrow |\mathbf{v} \times \mathbf{a}|^2 = (t^2)^2 = t^4.$$

$$\text{Thus } \tau = \frac{\begin{vmatrix} t\cos t & t\sin t & 0 \\ \cos t - t\sin t & \sin t + \cos t & 0 \\ -2\sin t - t\cos t & 2\cos t - \sin t & 0 \end{vmatrix}}{t^4} = \frac{0}{t^4} = 0$$

11. By Exercise 11 in Section 13.4, $\mathbf{T} = \left(\frac{\cos t - \sin t}{\sqrt{2}}\right)\mathbf{i} + \left(\frac{\sin t + \cos t}{\sqrt{2}}\right)\mathbf{j}$ and $\mathbf{N} = \left(\frac{-\cos t - \sin t}{\sqrt{2}}\right)\mathbf{i} + \left(\frac{-\sin t + \cos t}{\sqrt{2}}\right)\mathbf{j}$; Thus

$$\mathbf{B} = \mathbf{T} \times \mathbf{N} = \begin{vmatrix} \mathbf{i} & \mathbf{j} & \mathbf{k} \\ \frac{\cos t - \sin t}{\sqrt{2}} & \frac{\sin t + \cos t}{\sqrt{2}} & 0 \\ \frac{-\cos t - \sin t}{\sqrt{2}} & \frac{-\sin t + \cos t}{\sqrt{2}} & 0 \end{vmatrix} = \left[\left(\frac{\cos^2 t - 2\cos t \sin t + \sin^2 t}{2} \right) + \left(\frac{\sin^2 t + 2\sin t \cos t + \cos^2 t}{2} \right) \right] \mathbf{k}$$

$$= \left[\left(\frac{1 - \sin(2t)}{2} \right) + \left(\frac{1 + \sin(2t)}{2} \right) \right] \mathbf{k} = \mathbf{k}. \text{ Also, } \mathbf{v} = (e^t \cos t - e^t \sin t)\mathbf{i} + (e^t \sin t + e^t \cos t)\mathbf{j}$$

$$\Rightarrow \mathbf{a} = [e^t(-\sin t - \cos t) + e^t(\cos t - \sin t)]\mathbf{i} + [e^t(\cos t - \sin t) + e^t(\sin t + \cos t)]\mathbf{j}$$

$$= (-2e^t \sin t)\mathbf{i} + (2e^t \cos t)\mathbf{j} \Rightarrow \frac{d\mathbf{a}}{dt} = -2e^t(\cos t + \sin t)\mathbf{i} + 2e^t(-\sin t + \cos t)\mathbf{j}.$$

$$\text{Thus } \mathbf{v} \times \mathbf{a} = \begin{vmatrix} \mathbf{i} & \mathbf{j} & \mathbf{k} \\ e^t(\cos t - \sin t) & e^t(\sin t + \cos t) & 0 \\ -2e^t \sin t & 2e^t \cos t & 0 \end{vmatrix} = 2e^{2t}\mathbf{k} \Rightarrow |\mathbf{v} \times \mathbf{a}|^2 = (2e^{2t})^2 = 4e^{4t}.$$

$$\text{Thus } \tau = \frac{\begin{vmatrix} e^t(\cos t - \sin t) & e^t(\sin t + \cos t) & 0 \\ -2e^t \sin t & 2e^t \cos t & 0 \\ -2e^t(\cos t + \sin t) & 2e^t(-\sin t + \cos t) & 0 \end{vmatrix}}{4e^{4t}} = 0$$

12. By Exercise 12 in Section 13.4, $\mathbf{T} = \left(\frac{12}{13} \cos 2t\right)\mathbf{i} - \left(\frac{12}{13} \sin 2t\right)\mathbf{j} + \frac{5}{13}\mathbf{k}$ and $\mathbf{N} = (-\sin 2t)\mathbf{i} - (\cos 2t)\mathbf{j}$ Thus

$$\mathbf{B} = \mathbf{T} \times \mathbf{N} = \begin{vmatrix} \mathbf{i} & \mathbf{j} & \mathbf{k} \\ \frac{12}{13} \cos 2t & -\frac{12}{13} \sin 2t & \frac{5}{13} \\ -\sin 2t & -\cos 2t & 0 \end{vmatrix} = \left(\frac{5}{13} \cos 2t\right)\mathbf{i} - \left(\frac{5}{13} \sin 2t\right)\mathbf{j} - \frac{12}{13}\mathbf{k}.$$

$$\text{Also, } \mathbf{v} = (12 \cos 2t)\mathbf{i} - (12 \sin 2t)\mathbf{j} + 5\mathbf{k} \Rightarrow \mathbf{a} = (-24 \sin 2t)\mathbf{i} - (24 \cos 2t)\mathbf{j} \text{ and } \frac{d\mathbf{a}}{dt} = (-48 \cos 2t)\mathbf{i} + (48 \sin 2t)\mathbf{j}$$

$$\mathbf{v} \times \mathbf{a} = \begin{vmatrix} \mathbf{i} & \mathbf{j} & \mathbf{k} \\ 12 \cos 2t & -12 \sin 2t & 5 \\ -24 \sin 2t & -24 \cos 2t & 0 \end{vmatrix} = (120 \cos 2t)\mathbf{i} - (120 \sin 2t)\mathbf{j} - 288\mathbf{k}$$

$$\Rightarrow |\mathbf{v} \times \mathbf{a}|^2 = (120 \cos 2t)^2 + (-120 \sin 2t)^2 + (-288)^2 = 120^2(\cos^2 2t + \sin^2 2t) + 288^2 = 97344. \text{ Thus}$$

$$\tau = \frac{\begin{vmatrix} 12 \cos 2t & -12 \sin 2t & 5 \\ -24 \sin 2t & -24 \cos 2t & 0 \\ -48 \cos 2t & 48 \sin 2t & 0 \end{vmatrix}}{97344} = \frac{5 \cdot (-24 \cdot 48)}{97344} = -\frac{10}{169}$$

13. By Exercise 13 in Section 13.4, $\mathbf{T} = \frac{t}{\sqrt{t^2+1}}\mathbf{i} + \frac{1}{\sqrt{t^2+1}}\mathbf{j}$ and $\mathbf{N} = \frac{1}{\sqrt{t^2+1}}\mathbf{i} - \frac{t}{\sqrt{t^2+1}}\mathbf{j}$ so that

$$\mathbf{B} = \mathbf{T} \times \mathbf{N} = \begin{vmatrix} \mathbf{i} & \mathbf{j} & \mathbf{k} \\ \frac{t}{\sqrt{t^2+1}} & \frac{1}{\sqrt{t^2+1}} & 0 \\ \frac{1}{\sqrt{t^2+1}} & \frac{-t}{\sqrt{t^2+1}} & 0 \end{vmatrix} = -\mathbf{k}. \text{ Also, } \mathbf{v} = t^2\mathbf{i} + t\mathbf{j} \Rightarrow \mathbf{a} = 2t\mathbf{i} + \mathbf{j} \Rightarrow \frac{d\mathbf{a}}{dt} = 2\mathbf{i} \text{ so that } \begin{vmatrix} t^2 & t & 0 \\ 2t & 1 & 0 \\ 2 & 0 & 0 \end{vmatrix} = 0 \Rightarrow \tau = 0$$

14. By Exercise 14 in Section 13.4, $\mathbf{T} = (-\cos t)\mathbf{i} + (\sin t)\mathbf{j}$ and $\mathbf{N} = (\sin t)\mathbf{i} + (\cos t)\mathbf{j}$ so that

$$\mathbf{B} = \mathbf{T} \times \mathbf{N} = \begin{vmatrix} \mathbf{i} & \mathbf{j} & \mathbf{k} \\ -\cos t & \sin t & 0 \\ \sin t & \cos t & 0 \end{vmatrix} = -\mathbf{k}. \text{ Also, } \mathbf{v} = (-3\cos^2 t \sin t)\mathbf{i} + (3\sin^2 t \cos t)\mathbf{j}$$

$$\Rightarrow \mathbf{a} = \frac{d}{dt}(-3\cos^2 t \sin t)\mathbf{i} + \frac{d}{dt}(3\sin^2 t \cos t)\mathbf{j} \Rightarrow \frac{d\mathbf{a}}{dt} = \frac{d}{dt} \left[\frac{d}{dt}(-3\cos^2 t \sin t) \right] \mathbf{i} + \frac{d}{dt} \left[\frac{d}{dt}(3\sin^2 t \cos t) \right] \mathbf{j}$$

$$\Rightarrow \begin{vmatrix} -3\cos^2 t \sin t & 3\sin^2 t \cos t & 0 \\ \frac{d}{dt}(-3\cos^2 t \sin t) & \frac{d}{dt}(3\sin^2 t \cos t) & 0 \\ \frac{d}{dt} \left[\frac{d}{dt}(-3\cos^2 t \sin t) \right] & \frac{d}{dt} \left[\frac{d}{dt}(3\sin^2 t \cos t) \right] & 0 \end{vmatrix} = 0 \Rightarrow \tau = 0$$

15. By Exercise 15 in Section 13.4, $\mathbf{T} = \frac{\mathbf{v}}{|\mathbf{v}|} = (\operatorname{sech} \frac{t}{a})\mathbf{i} + (\tanh \frac{t}{a})\mathbf{j}$ and $\mathbf{N} = (-\tanh \frac{t}{a})\mathbf{i} + (\operatorname{sech} \frac{t}{a})\mathbf{j}$ so that

$$\mathbf{B} = \mathbf{T} \times \mathbf{N} = \begin{vmatrix} \mathbf{i} & \mathbf{j} & \mathbf{k} \\ \operatorname{sech}(\frac{t}{a}) & \tanh(\frac{t}{a}) & 0 \\ -\tanh(\frac{t}{a}) & \operatorname{sech}(\frac{t}{a}) & 0 \end{vmatrix} = \mathbf{k}. \text{ Also, } \mathbf{v} = \mathbf{i} + (\sinh \frac{t}{a})\mathbf{j} \Rightarrow \mathbf{a} = (\frac{1}{a} \cosh \frac{t}{a})\mathbf{j} \Rightarrow \frac{d\mathbf{a}}{dt} = \frac{1}{a^2} \sinh(\frac{t}{a})\mathbf{j} \text{ so}$$

$$\text{that } \begin{vmatrix} 1 & \sinh(\frac{t}{a}) & 0 \\ 0 & \frac{1}{a} \cosh(\frac{t}{a}) & 0 \\ 0 & \frac{1}{a^2} \sinh(\frac{t}{a}) & 0 \end{vmatrix} = 0 \Rightarrow \tau = 0$$

16. By Exercise 16 in Section 13.4, $\mathbf{T} = (\frac{1}{\sqrt{2}} \tanh t)\mathbf{i} - \frac{1}{\sqrt{2}}\mathbf{j} + (\frac{1}{\sqrt{2}} \operatorname{sech} t)\mathbf{k}$ and $\mathbf{N} = (\operatorname{sech} t)\mathbf{i} - (\tanh t)\mathbf{k}$ so that

$$\mathbf{B} = \mathbf{T} \times \mathbf{N} = \begin{vmatrix} \mathbf{i} & \mathbf{j} & \mathbf{k} \\ \frac{1}{\sqrt{2}} \tanh t & -\frac{1}{\sqrt{2}} & \frac{1}{\sqrt{2}} \operatorname{sech} t \\ \operatorname{sech} t & 0 & -\tanh t \end{vmatrix} = (\frac{1}{\sqrt{2}} \tanh t)\mathbf{i} + \frac{1}{\sqrt{2}}\mathbf{j} + (\frac{1}{\sqrt{2}} \operatorname{sech} t)\mathbf{k}. \text{ Also, } \mathbf{v} = (\sinh t)\mathbf{i} - (\cosh t)\mathbf{j} + \mathbf{k}$$

$$\mathbf{a} = (\cosh t)\mathbf{i} - (\sinh t)\mathbf{j} \Rightarrow \frac{d\mathbf{a}}{dt} = (\sinh t)\mathbf{i} - (\cosh t)\mathbf{j} \text{ and } \mathbf{v} \times \mathbf{a} = \begin{vmatrix} \mathbf{i} & \mathbf{j} & \mathbf{k} \\ \sinh t & -\cosh t & 1 \\ \cosh t & -\sinh t & 0 \end{vmatrix}$$

$$= (\sinh t)\mathbf{i} + (\cosh t)\mathbf{j} + (\cosh^2 t - \sinh^2 t)\mathbf{k} = (\sinh t)\mathbf{i} + (\cosh t)\mathbf{j} + \mathbf{k} \Rightarrow |\mathbf{v} \times \mathbf{a}|^2 = \sinh^2 t + \cosh^2 t + 1. \text{ Thus}$$

$$\tau = \frac{\begin{vmatrix} \sinh t & -\cosh t & 1 \\ \cosh t & -\sinh t & 0 \\ \sinh t & -\cosh t & 0 \end{vmatrix}}{\sinh^2 t + \cosh^2 t + 1} = \frac{-1}{\sinh^2 t + \cosh^2 t + 1} = \frac{-1}{2\cosh^2 t}.$$

17. Yes. If the car is moving along a curved path, then $\kappa \neq 0$ and $a_N = \kappa |\mathbf{v}|^2 \neq 0 \Rightarrow \mathbf{a} = a_T \mathbf{T} + a_N \mathbf{N} \neq \mathbf{0}$.

18. $|\mathbf{v}|$ constant $\Rightarrow a_T = \frac{d}{dt}|\mathbf{v}| = 0 \Rightarrow \mathbf{a} = a_N \mathbf{N}$ is orthogonal to $\mathbf{T} \Rightarrow$ the acceleration is normal to the path

19. $\mathbf{a} \perp \mathbf{v} \Rightarrow \mathbf{a} \perp \mathbf{T} \Rightarrow a_T = 0 \Rightarrow \frac{d}{dt}|\mathbf{v}| = 0 \Rightarrow |\mathbf{v}|$ is constant

20. $\mathbf{a}(t) = a_T \mathbf{T} + a_N \mathbf{N}$, where $a_T = \frac{d}{dt}|\mathbf{v}| = \frac{d}{dt}(10) = 0$ and $a_N = \kappa|\mathbf{v}|^2 = 100\kappa \Rightarrow \mathbf{a} = 0\mathbf{T} + 100\kappa \mathbf{N}$. Now, from Exercise 5(a) Section 13.4, we find for $y = f(x) = x^2$ that $\kappa = \frac{|f''(x)|}{(1+[f'(x)]^2)^{3/2}} = \frac{2}{[1+(2x)^2]^{3/2}} = \frac{2}{(1+4x^2)^{3/2}}$; also, $\mathbf{r}(t) = t\mathbf{i} + t^2\mathbf{j}$ is the position vector of the moving mass $\Rightarrow \mathbf{v} = \mathbf{i} + 2t\mathbf{j} \Rightarrow |\mathbf{v}| = \sqrt{1+4t^2} \Rightarrow \mathbf{T} = \frac{1}{\sqrt{1+4t^2}}(\mathbf{i} + 2t\mathbf{j})$. At $(0, 0)$: $\mathbf{T}(0) = \mathbf{i}$, $\mathbf{N}(0) = \mathbf{j}$ and $\kappa(0) = 2 \Rightarrow \mathbf{F} = m\mathbf{a} = m(100\kappa)\mathbf{N} = 200m \mathbf{j}$;
 At $(\sqrt{2}, 2)$: $\mathbf{T}(\sqrt{2}) = \frac{1}{3}(\mathbf{i} + 2\sqrt{2}\mathbf{j}) = \frac{1}{3}\mathbf{i} + \frac{2\sqrt{2}}{3}\mathbf{j}$, $\mathbf{N}(\sqrt{2}) = -\frac{2\sqrt{2}}{3}\mathbf{i} + \frac{1}{3}\mathbf{j}$, and $\kappa(\sqrt{2}) = \frac{2}{27}$
 $\Rightarrow \mathbf{F} = m\mathbf{a} = m(100\kappa)\mathbf{N} = \left(\frac{200}{27}m\right)\left(-\frac{2\sqrt{2}}{3}\mathbf{i} + \frac{1}{3}\mathbf{j}\right) = -\frac{400\sqrt{2}}{81}m\mathbf{i} + \frac{200}{81}m\mathbf{j}$

21. $\mathbf{r} = (x_0 + At)\mathbf{i} + (y_0 + Bt)\mathbf{j} + (z_0 + Ct)\mathbf{k} \Rightarrow \mathbf{v} = A\mathbf{i} + B\mathbf{j} + C\mathbf{k} \Rightarrow \mathbf{a} = \mathbf{0} \Rightarrow \mathbf{v} \times \mathbf{a} = \mathbf{0} \Rightarrow \kappa = 0$. Since the curve is a plane curve, $\tau = 0$.

22. $a_N = 0 \Rightarrow \kappa|\mathbf{v}|^2 = 0 \Rightarrow \kappa = 0$ (since the particle is moving, we cannot have zero speed) \Rightarrow the curvature is zero so the particle is moving along a straight line

23. From Example 1, $|\mathbf{v}| = t$ and $a_N = t$ so that $a_N = \kappa|\mathbf{v}|^2 \Rightarrow \kappa = \frac{a_N}{|\mathbf{v}|^2} = \frac{t}{t^2} = \frac{1}{t}$, $t \neq 0 \Rightarrow \rho = \frac{1}{\kappa} = t$

24. If a plane curve is sufficiently differentiable the torsion is zero as the following argument shows:

$$\mathbf{r} = f(t)\mathbf{i} + g(t)\mathbf{j} \Rightarrow \mathbf{v} = f'(t)\mathbf{i} + g'(t)\mathbf{j} \Rightarrow \mathbf{a} = f''(t)\mathbf{i} + g''(t)\mathbf{j} \Rightarrow \frac{d\mathbf{a}}{dt} = f'''(t)\mathbf{i} + g'''(t)\mathbf{j} \Rightarrow \tau = \frac{\begin{vmatrix} f'(t) & g'(t) & 0 \\ f''(t) & g''(t) & 0 \\ f'''(t) & g'''(t) & 0 \end{vmatrix}}{|\mathbf{v} \times \mathbf{a}|^2} = 0$$

25. $\mathbf{r}(t) = f(t)\mathbf{i} + g(t)\mathbf{j} + h(t)\mathbf{k} \Rightarrow \mathbf{v} = f'(t)\mathbf{i} + g'(t)\mathbf{j} + h'(t)\mathbf{k}$; $\mathbf{v} \cdot \mathbf{k} = 0 \Rightarrow h'(t) = 0 \Rightarrow h(t) = C$
 $\Rightarrow \mathbf{r}(t) = f(t)\mathbf{i} + g(t)\mathbf{j} + C\mathbf{k}$ and $\mathbf{r}(a) = f(a)\mathbf{i} + g(a)\mathbf{j} + C\mathbf{k} = \mathbf{0} \Rightarrow f(a) = 0, g(a) = 0$ and $C = 0 \Rightarrow h(t) = 0$.

26. From Example 2, $\mathbf{v} = -(a \sin t)\mathbf{i} + (a \cos t)\mathbf{j} + b\mathbf{k} \Rightarrow |\mathbf{v}| = \sqrt{a^2 + b^2}$

$$\Rightarrow \mathbf{T} = \frac{\mathbf{v}}{|\mathbf{v}|} = \frac{1}{\sqrt{a^2 + b^2}}[-(a \sin t)\mathbf{i} + (a \cos t)\mathbf{j} + b\mathbf{k}]; \quad \frac{d\mathbf{T}}{dt} = \frac{1}{\sqrt{a^2 + b^2}}[-(a \cos t)\mathbf{i} - (a \sin t)\mathbf{j}]$$

$$\Rightarrow \mathbf{N} = \frac{\left(\frac{d\mathbf{T}}{dt}\right)}{\left|\frac{d\mathbf{T}}{dt}\right|} = -(\cos t)\mathbf{i} - (\sin t)\mathbf{j}; \quad \mathbf{B} = \mathbf{T} \times \mathbf{N} = \begin{vmatrix} \mathbf{i} & \mathbf{j} & \mathbf{k} \\ \frac{-a \sin t}{\sqrt{a^2 + b^2}} & \frac{a \cos t}{\sqrt{a^2 + b^2}} & \frac{b}{\sqrt{a^2 + b^2}} \\ -\cos t & -\sin t & 0 \end{vmatrix} = \frac{b \sin t}{\sqrt{a^2 + b^2}}\mathbf{i} - \frac{b \cos t}{\sqrt{a^2 + b^2}}\mathbf{j} + \frac{a}{\sqrt{a^2 + b^2}}\mathbf{k}$$

$$\Rightarrow \frac{d\mathbf{B}}{dt} = \frac{1}{\sqrt{a^2 + b^2}}[(b \cos t)\mathbf{i} + (b \sin t)\mathbf{j}] \Rightarrow \frac{d\mathbf{B}}{dt} \cdot \mathbf{N} = -\frac{b}{\sqrt{a^2 + b^2}} \Rightarrow \tau = -\frac{1}{|\mathbf{v}|} \left(\frac{d\mathbf{B}}{dt} \cdot \mathbf{N}\right) = \left(-\frac{1}{\sqrt{a^2 + b^2}}\right) \left(-\frac{b}{\sqrt{a^2 + b^2}}\right) = \frac{b}{a^2 + b^2},$$

which is consistent with the result in Example 2.

27-30. Example CAS commands:

Maple:

```
with( LinearAlgebra );
r := <t*cos(t) | t*sin(t) | t >;
t0 := sqrt(3);
rr := eval( r, t=t0 );
v := map( diff, r, t );
vv := eval( v, t=t0 );
a := map( diff, v, t );
aa := eval( a, t=t0 );
s := simplify(Norm( v, 2 )) assuming t::real;
ss := eval( s, t=t0 );
T := v/s;
TT := vv/ss ;
q1 := map( diff, simplify(T), t );
NN := simplify(eval( q1/Norm(q1,2), t=t0 ));
BB := CrossProduct( TT, NN );
kappa := Norm(CrossProduct(vv,aa),2)/ss^3;
tau := simplify( Determinant(< vv, aa, eval(map(diff,a,t),t=t0) >)/Norm(CrossProduct(vv,aa),2)^3 );
a_t := eval( diff( s, t ), t=t0 );
a_n := evalf[4]( kappa*ss^2 );
```

Mathematica: (assigned functions and value for t0 will vary)

```
Clear[t, v, a, t]
mag[vector_]:=Sqrt[vector.vector]
Print["The position vector is",r[t_]={t Cos[t], t Sin[t], t}]
Print["The velocity vector is",v[t_]=r'[t]]
Print["The acceleration vector is",a[t_]=v'[t]]
Print["The speed is",speed[t_]= mag[v[t]]//Simplify]
Print["The unit tangent vector is",utan[t_]= v[t]/speed[t]//Simplify]
Print["The curvature is",curv[t_]= mag[Cross[v[t],a[t]]] / speed[t]^3 //Simplify]
Print["The torsion is",torsion[t_]= Det[{v[t], a[t], a'[t]}] / mag[Cross[v[t],a[t]]]^2 //Simplify]
Print["The unit normal vector is",unorm[t_]= utan'[t] / mag[utan[t]]//Simplify]
Print["The unit binormal vector is",ubinorm[t_]= Cross[utan[t],unorm[t]]//Simplify]
Print["The tangential component of the acceleration is",at[t_]=a[t].utan[t]//Simplify]
Print["The normal component of the acceleration is",an[t_]=a[t].unorm[t]//Simplify]
```

You can evaluate any of these functions at a specified value of t.

```
t0= Sqrt[3]
{ utan[t0], unorm[t0], ubinorm[t0] }
N[ { utan[t0], unorm[t0], ubinorm[t0] } ]
{ curv[t0], torsion[t0] }
```

$$N[\{\text{curv}[t0], \text{torsion}[t0]\}]$$

$$\{\text{at}[t0], \text{an}[t0]\}$$

$$N[\{\text{at}[t0], \text{an}[t0]\}]$$

To verify that the tangential and normal components of the acceleration agree with the formulas in the book:

$$\text{at}[t]==\text{speed}[t]//\text{Simplify}$$

$$\text{an}[t]==\text{curv}[t]\text{speed}[t]^2//\text{Simplify}$$

13.6 VELOCITY AND ACCELERATION IN POLAR COORDINATES

- $$\frac{d\theta}{dt} = 3 = \dot{\theta} \Rightarrow \ddot{\theta} = 0, \quad r = a(1 - \cos \theta) \Rightarrow \dot{r} = a \sin \theta \frac{d\theta}{dt} = 3a \sin \theta \Rightarrow \ddot{r} = 3a \cos \theta \frac{d\theta}{dt} = 9a \cos \theta$$

$$\mathbf{v} = (3a \sin \theta) \mathbf{u}_r + (a(1 - \cos \theta))(3) \mathbf{u}_\theta = (3a \sin \theta) \mathbf{u}_r + 3a(1 - \cos \theta) \mathbf{u}_\theta$$

$$\mathbf{a} = (9a \cos \theta - a(1 - \cos \theta)(3)^2) \mathbf{u}_r + (a(1 - \cos \theta) \cdot 0 + 2(3a \sin \theta)(3)) \mathbf{u}_\theta$$

$$= (9a \cos \theta - 9a + 9a \cos \theta) \mathbf{u}_r + (18a \sin \theta) \mathbf{u}_\theta = 9a(2 \cos \theta - 1) \mathbf{u}_r + (18a \sin \theta) \mathbf{u}_\theta$$
- $$\frac{d\theta}{dt} 2t = \dot{\theta} \Rightarrow \ddot{\theta} = 2, \quad r = a \sin 2\theta \Rightarrow \dot{r} = a \cos 2\theta \cdot 2 \frac{d\theta}{dt} = 4ta \cos 2\theta \Rightarrow \ddot{r} = 4ta(-\sin 2\theta \cdot 2 \frac{d\theta}{dt}) + 4a \cos 2\theta$$

$$= -16t^2 a \sin 2\theta + 4a \cos 2\theta; \quad \mathbf{v} = (4ta \cos 2\theta) \mathbf{u}_r + (a \sin 2\theta)(2t) \mathbf{u}_\theta = (4ta \cos 2\theta) \mathbf{u}_r + (2ta \sin 2\theta) \mathbf{u}_\theta$$

$$\mathbf{a} = \left[(-16t^2 a \sin 2\theta + 4a \cos 2\theta) - (a \sin 2\theta)(2t)^2 \right] \mathbf{u}_r + \left[(a \sin 2\theta)(2) + 2(4ta \cos 2\theta)(2t) \right] \mathbf{u}_\theta$$

$$= \left[-16t^2 a \sin 2\theta + 4a \cos 2\theta - 4t^2 a \sin 2\theta \right] \mathbf{u}_r + \left[2a \sin 2\theta + 16t^2 a \cos 2\theta \right] \mathbf{u}_\theta$$

$$= \left[-20t^2 a \sin 2\theta + 4a \cos 2\theta \right] \mathbf{u}_r + \left[2a \sin 2\theta + 16t^2 a \cos 2\theta \right] \mathbf{u}_\theta$$

$$= 4a(\cos 2\theta - 5t^2 \sin 2\theta) \mathbf{u}_r + 2a(\sin 2\theta + 8t^2 \cos 2\theta) \mathbf{u}_\theta$$
- $$\frac{d\theta}{dt} = 2 = \dot{\theta} \Rightarrow \ddot{\theta} = 0, \quad r = e^{a\theta} \Rightarrow \dot{r} = e^{a\theta} \cdot a \frac{d\theta}{dt} = 2a e^{a\theta} \Rightarrow \ddot{r} = 2a e^{a\theta} \cdot a \frac{d\theta}{dt} = 4a^2 e^{a\theta}$$

$$\mathbf{v} = (2a e^{a\theta}) \mathbf{u}_r + (e^{a\theta})(2) \mathbf{u}_\theta = (2a e^{a\theta}) \mathbf{u}_r + (2e^{a\theta}) \mathbf{u}_\theta$$

$$\mathbf{a} = \left[(4a^2 e^{a\theta}) - (e^{a\theta})(2)^2 \right] \mathbf{u}_r + \left[(e^{a\theta})(0) + 2(2a e^{a\theta})(2) \right] \mathbf{u}_\theta = [4a^2 e^{a\theta} - 4e^{a\theta}] \mathbf{u}_r + [0 + 8a e^{a\theta}] \mathbf{u}_\theta$$

$$= 4e^{a\theta}(a^2 - 1) \mathbf{u}_r + (8a e^{a\theta}) \mathbf{u}_\theta$$
- $$\theta = 1 - e^{-t} \Rightarrow \dot{\theta} = e^{-t} \Rightarrow \ddot{\theta} = -e^{-t}, \quad r = a(1 + \sin t) \Rightarrow \dot{r} = a \cos t \Rightarrow \ddot{r} = -a \sin t$$

$$\mathbf{v} = (a \cos t) \mathbf{u}_r + (a(1 + \sin t))(e^{-t}) \mathbf{u}_\theta = (a \cos t) \mathbf{u}_r + a e^{-t} (1 + \sin t) \mathbf{u}_\theta$$

$$\mathbf{a} = \left[(-a \sin t) - (a(1 + \sin t))(e^{-t})^2 \right] \mathbf{u}_r + \left[(a(1 + \sin t))(e^{-t}) + 2(a \cos t)(e^{-t}) \right] \mathbf{u}_\theta$$

$$= \left[-a \sin t - a e^{-2t} (1 + \sin t) \right] \mathbf{u}_r + \left[-a e^{-t} (1 + \sin t) + 2a e^{-t} \cos t \right] \mathbf{u}_\theta$$

$$= -a(\sin t + e^{-2t} (1 + \sin t)) \mathbf{u}_r + a e^{-t} (-(1 + \sin t) + 2 \cos t) \mathbf{u}_\theta$$

$$= -a(\sin t + e^{-2t} (1 + \sin t)) \mathbf{u}_r + a e^{-t} (2 \cos t - 1 - \sin t) \mathbf{u}_\theta$$

$$\begin{aligned}
 5. \quad \theta = 2t \Rightarrow \dot{\theta} = 2 \Rightarrow \ddot{\theta} = 0, \quad r = 2 \cos 4t \Rightarrow \dot{r} = -8 \sin 4t \Rightarrow \ddot{r} = -32 \cos 4t \\
 \mathbf{v} = (-8 \sin 4t) \mathbf{u}_r + (2 \cos 4t)(2) \mathbf{u}_\theta = -8(\sin 4t) \mathbf{u}_r + 4(\cos 4t) \mathbf{u}_\theta \\
 \mathbf{a} = \left((-32 \cos 4t) - (2 \cos 4t)(2)^2 \right) \mathbf{u}_r + \left((2 \cos 4t) \cdot 0 + 2(-8 \sin 4t)(2) \right) \mathbf{u}_\theta \\
 = (-32 \cos 4t - 8 \cos 4t) \mathbf{u}_r + (0 - 32 \sin 4t) \mathbf{u}_\theta = -40(\cos 4t) \mathbf{u}_r - 32(\sin 4t) \mathbf{u}_\theta
 \end{aligned}$$

$$6. \quad e = \frac{r_0 v_0^2}{GM} - 1 \Rightarrow v_0^2 = \frac{GM(e+1)}{r_0} \Rightarrow v_0 = \sqrt{\frac{GM(e+1)}{r_0}};$$

$$\text{Circle: } e = 0 \Rightarrow v_0 = \sqrt{\frac{GM}{r_0}}$$

$$\text{Ellipse: } 0 < e < 1 \Rightarrow \sqrt{\frac{GM}{r_0}} < v_0 < \sqrt{\frac{2GM}{r_0}}$$

$$\text{Parabola: } e = 1 \Rightarrow v_0 = \sqrt{\frac{2GM}{r_0}}$$

$$\text{Hyperbola: } e > 1 \Rightarrow v_0 > \sqrt{\frac{2GM}{r_0}}$$

$$7. \quad r = \frac{GM}{v^2} \Rightarrow v^2 = \frac{GM}{r} \Rightarrow v = \sqrt{\frac{GM}{r}} \text{ which is constant since } G, M, \text{ and } r \text{ (the radius of orbit) are constant}$$

$$\begin{aligned}
 8. \quad \Delta A = \frac{1}{2} |\mathbf{r}(t + \Delta t) \times \mathbf{r}(t)| \Rightarrow \frac{\Delta A}{\Delta t} = \frac{1}{2} \left| \frac{\mathbf{r}(t + \Delta t) - \mathbf{r}(t)}{\Delta t} \times \mathbf{r}(t) \right| = \frac{1}{2} \left| \frac{\mathbf{r}(t + \Delta t) - \mathbf{r}(t) + \mathbf{r}(t)}{\Delta t} \times \mathbf{r}(t) \right| = \frac{1}{2} \left| \frac{\mathbf{r}(t + \Delta t) - \mathbf{r}(t)}{\Delta t} \times \mathbf{r}(t) + \frac{1}{\Delta t} \mathbf{r}(t) \times \mathbf{r}(t) \right| \\
 = \frac{1}{2} \left| \frac{\mathbf{r}(t + \Delta t) - \mathbf{r}(t)}{\Delta t} \times \mathbf{r}(t) \right| \Rightarrow \frac{dA}{dt} = \lim_{\Delta t \rightarrow 0} \frac{1}{2} \left| \frac{\mathbf{r}(t + \Delta t) - \mathbf{r}(t)}{\Delta t} \times \mathbf{r}(t) \right| = \frac{1}{2} \left| \frac{d\mathbf{r}}{dt} \times \mathbf{r}(t) \right| = \frac{1}{2} \left| \mathbf{r}(t) \times \frac{d\mathbf{r}}{dt} \right| = \frac{1}{2} |\mathbf{r} \times \dot{\mathbf{r}}|
 \end{aligned}$$

$$\begin{aligned}
 9. \quad T = \left(\frac{2\pi a^2}{r_0^2 v_0^2} \right) \sqrt{1 - e^2} \Rightarrow T^2 = \left(\frac{4\pi^2 a^4}{r_0^2 v_0^2} \right) (1 - e^2) = \left(\frac{4\pi^2 a^4}{r_0^2 v_0^2} \right) \left[1 - \left(\frac{r_0 v_0^2}{GM} - 1 \right)^2 \right] \text{ (from Equation 5)} \\
 = \left(\frac{4\pi^2 a^4}{r_0^2 v_0^2} \right) \left[-\frac{r_0^2 v_0^4}{G^2 M^2} + 2 \left(\frac{r_0 v_0^2}{GM} \right) \right] = \left(\frac{4\pi^2 a^4}{r_0^2 v_0^2} \right) \left[\frac{2GM r_0 v_0^2 - r_0^2 v_0^4}{G^2 M^2} \right] = \frac{(4\pi^2 a^4)(2GM - r_0 v_0^2)}{r_0 G^2 M^2} = (4\pi^2 a^4) \left(\frac{2GM - r_0 v_0^2}{2r_0 GM} \right) \left(\frac{2}{GM} \right) \\
 = (4\pi^2 a^4) \left(\frac{1}{2a} \right) \left(\frac{2}{GM} \right) \text{ (from Equation 10)} \Rightarrow T^2 = \frac{4\pi^2 a^3}{GM} \Rightarrow \frac{T^2}{a^3} = \frac{4\pi^2}{GM}
 \end{aligned}$$

10. For each of the planets listed we form the ratio $\frac{T^2 / a^3}{(4\pi^2) / (GM)}$. The values we obtain are

Mercury	1.00225
Venus	1.00288
Mars	1.00252
Saturn	1.00019

These values are all close to 1, so they support Kepler's third law.

$$11. \quad \text{Solve Kepler's third law for } a \text{ and double this result: } 2 \cdot \left(\frac{(365.256 \text{ days})^2}{(4\pi^2) / (GM)} \right)^{1/3} \approx 29.925 \times 10^{10} \text{ m}$$

$$12. \quad \text{Solve Kepler's third law for } a \text{ and double this result: } 2 \cdot \left(\frac{(84 \text{ years})^2}{(4\pi^2) / (GM)} \right)^{1/3} \approx 573.95 \times 10^{10} \text{ m}$$

13. Assuming Earth has a circular orbit with radius 150×10^6 km, the rate of change of area is

$$\frac{\pi(150 \times 10^6 \text{ km})^2}{365.256 \text{ days}} \approx 2.24 \times 10^9 \text{ km}^2/\text{sec}.$$

14. Solving Kepler's third law for T we find $T = \sqrt{\frac{4\pi^2}{GM}(77.8 \times 10^{10} \text{ m})^3} \approx 11.857$ years.

15. Solving Kepler's third law for the mass M of the body around which Io is orbiting we find

$$M = 4\pi^2 \frac{a^3}{T^2 G} = 4\pi^2 \frac{(0.042 \times 10^{10} \text{ m})^3}{(1.769 \text{ days})^2 G} \approx 1.876 \times 10^{27} \text{ kg}.$$

16. To solve this we need a value for the mass of Earth, which is approximately $M = 5.972 \times 10^{24}$ kg. Solving Kepler's third law for the orbital radius we get

$$a = (4\pi^2)^{-1/3} (T^2 GM)^{1/3} = (4\pi^2)^{-1/3} \left((2.36055 \times 10^6 \text{ sec}) G (5.972 \times 10^{24} \text{ kg}) \right)^{1/3} \approx 3.831 \times 10^5 \text{ km}.$$

Since Earth's radius is about 6371, the orbit of the moon is about $383,143 - 6371 = 376,772$ km from the surface, assuming a circular orbit for the moon.

CHAPTER 13 PRACTICE EXERCISES

1. $\mathbf{r}(t) = (4 \cos t)\mathbf{i} + (\sqrt{2} \sin t)\mathbf{j}$

$\Rightarrow x = 4 \cos t$ and $y = \sqrt{2} \sin t \Rightarrow \frac{x^2}{16} + \frac{y^2}{2} = 1;$

$\mathbf{v} = (-4 \sin t)\mathbf{i} + (\sqrt{2} \cos t)\mathbf{j}$ and

$\mathbf{a} = (-4 \cos t)\mathbf{i} - (\sqrt{2} \sin t)\mathbf{j};$

$\mathbf{r}(0) = 4\mathbf{i}, \mathbf{v}(0) = \sqrt{2}\mathbf{j}, \mathbf{a}(0) = -4\mathbf{i};$

$\mathbf{r}(\frac{\pi}{4}) = 2\sqrt{2}\mathbf{i} + \mathbf{j}, \mathbf{v}(\frac{\pi}{4}) = -2\sqrt{2}\mathbf{i} + \mathbf{j}, \mathbf{a}(\frac{\pi}{4}) = -2\sqrt{2}\mathbf{i} - \mathbf{j}; |\mathbf{v}| = \sqrt{16 \sin^2 t + 2 \cos^2 t}$

$\Rightarrow a_T = \frac{d}{dt}|\mathbf{v}| = \frac{14 \sin t \cos t}{\sqrt{16 \sin^2 t + 2 \cos^2 t}}; \text{ at } t=0: a_T = 0, a_N = \sqrt{|\mathbf{a}|^2 - 0} = 4, \mathbf{a} = 0\mathbf{T} + 4\mathbf{N} = 4\mathbf{N},$

$\kappa = \frac{a_N}{|\mathbf{v}|^2} = \frac{4}{2} = 2; \text{ at } t = \frac{\pi}{4}: a_T = \frac{7}{\sqrt{8+1}} = \frac{7}{3}, a_N = \sqrt{9 - \frac{49}{9}} = \frac{4\sqrt{2}}{3}, \mathbf{a} = \frac{7}{3}\mathbf{T} + \frac{4\sqrt{2}}{3}\mathbf{N}, \kappa = \frac{a_N}{|\mathbf{v}|^2} = \frac{4\sqrt{2}}{27}$

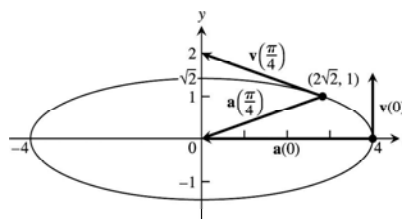

2. $\mathbf{r}(t) = (\sqrt{3} \sec t)\mathbf{i} + (\sqrt{3} \tan t)\mathbf{j} \Rightarrow x = \sqrt{3} \sec t$ and $y = \sqrt{3} \tan t \Rightarrow \frac{x^2}{3} - \frac{y^2}{3} = \sec^2 t - \tan^2 t = 1 \Rightarrow x^2 - y^2 = 3;$

$\mathbf{v} = (\sqrt{3} \sec t \tan t)\mathbf{i} + (\sqrt{3} \sec^2 t)\mathbf{j}$ and

$\mathbf{a} = (\sqrt{3} \sec t \tan^2 t + \sqrt{3} \sec^3 t)\mathbf{i} - (2\sqrt{3} \sec^2 t \tan t)\mathbf{j};$

$\mathbf{r}(0) = \sqrt{3}\mathbf{i}, \mathbf{v}(0) = \sqrt{3}\mathbf{j}, \mathbf{a}(0) = \sqrt{3}\mathbf{i};$

$|\mathbf{v}| = \sqrt{3 \sec^2 t \tan^2 t + 3 \sec^4 t}$

$\Rightarrow a_T = \frac{d}{dt}|\mathbf{v}| = \frac{6 \sec^2 t \tan^3 t + 18 \sec^4 t \tan t}{2\sqrt{3} \sec^2 t \tan^2 t + 3 \sec^4 t};$

at $t=0: a_T = 0, a_N = \sqrt{|\mathbf{a}|^2 - 0} = \sqrt{3},$

$\mathbf{a} = 0\mathbf{T} + \sqrt{3}\mathbf{N} = \sqrt{3}\mathbf{N}, \kappa = \frac{a_N}{|\mathbf{v}|^2} = \frac{\sqrt{3}}{3} = \frac{1}{\sqrt{3}}$

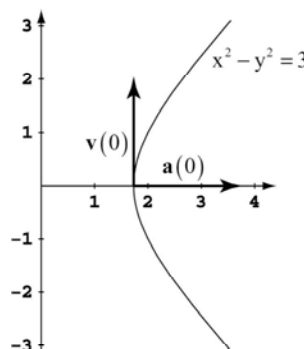

3. $\mathbf{r} = \frac{1}{\sqrt{1+t^2}}\mathbf{i} + \frac{t}{\sqrt{1+t^2}}\mathbf{j} \Rightarrow \mathbf{v} = -t(1+t^2)^{-3/2}\mathbf{i} + (1+t^2)^{-3/2}\mathbf{j} \Rightarrow |\mathbf{v}| = \sqrt{[-t(1+t^2)^{-3/2}]^2 + [(1+t^2)^{-3/2}]^2} = \frac{1}{1+t^2}.$

We want to maximize $|\mathbf{v}|: \frac{d|\mathbf{v}|}{dt} = \frac{-2t}{(1+t^2)^2}$ and $\frac{d|\mathbf{v}|}{dt} = 0 \Rightarrow \frac{-2t}{(1+t^2)^2} = 0 \Rightarrow t = 0.$ For $t < 0, \frac{-2t}{(1+t^2)^2} > 0;$ for $t > 0,$

$\frac{-2t}{(1+t^2)^2} < 0 \Rightarrow |\mathbf{v}|_{\max}$ occurs when $t = 0 \Rightarrow |\mathbf{v}|_{\max} = 1$

4. $\mathbf{r} = (e^t \cos t)\mathbf{i} + (e^t \sin t)\mathbf{j} \Rightarrow \mathbf{v} = (e^t \cos t - e^t \sin t)\mathbf{i} + (e^t \sin t + e^t \cos t)\mathbf{j}$

$\Rightarrow \mathbf{a} = (e^t \cos t - e^t \sin t - e^t \sin t - e^t \cos t)\mathbf{i} + (e^t \sin t + e^t \cos t + e^t \cos t - e^t \sin t)\mathbf{j} = (-2e^t \sin t)\mathbf{i} + (2e^t \cos t)\mathbf{j}.$

Let θ be the angle between \mathbf{r} and $\mathbf{a}.$ Then $\theta = \cos^{-1}\left(\frac{\mathbf{r} \cdot \mathbf{a}}{|\mathbf{r}||\mathbf{a}|}\right) = \cos^{-1}\left(\frac{-2e^{2t} \sin t \cos t + 2e^{2t} \sin t \cos t}{\sqrt{(e^t \cos t)^2 + (e^t \sin t)^2} \sqrt{(-2e^t \sin t)^2 + (2e^t \cos t)^2}}\right)$

$= \cos^{-1}\left(\frac{0}{2e^{2t}}\right) = \cos^{-1} 0 = \frac{\pi}{2}$ for all t

5. $\mathbf{v} = 3\mathbf{i} + 4\mathbf{j}$ and $\mathbf{a} = 5\mathbf{i} + 15\mathbf{j} \Rightarrow \mathbf{v} \times \mathbf{a} = \begin{vmatrix} \mathbf{i} & \mathbf{j} & \mathbf{k} \\ 3 & 4 & 0 \\ 5 & 15 & 0 \end{vmatrix} = 25\mathbf{k} \Rightarrow |\mathbf{v} \times \mathbf{a}| = 25$; $|\mathbf{v}| = \sqrt{3^2 + 4^2} = 5 \Rightarrow \kappa = \frac{|\mathbf{v} \times \mathbf{a}|}{|\mathbf{v}|^3} = \frac{25}{5^3} = \frac{1}{5}$

6. $\kappa = \frac{|y''|}{[1+(y')^2]^{3/2}} = e^x (1+e^{2x})^{-3/2} \Rightarrow \frac{d\kappa}{dx} = e^x (1+e^{2x})^{-3/2} + e^x \left[-\frac{3}{2}(1+e^{2x})^{-5/2} (2e^{2x}) \right]$
 $= e^x (1+e^{2x})^{-3/2} - 3e^{3x} (1+e^{2x})^{-5/2} = e^x (1+e^{2x})^{-5/2} [(1+e^{2x}) - 3e^{2x}] = e^x (1+e^{2x})^{-5/2} (1-2e^{2x})$;
 $\frac{d\kappa}{dx} = 0 \Rightarrow (1-2e^{2x}) = 0 \Rightarrow e^{2x} = \frac{1}{2} \Rightarrow 2x = -\ln 2 \Rightarrow x = -\frac{1}{2} \ln 2 = -\ln \sqrt{2} \Rightarrow y = \frac{1}{\sqrt{2}}$; therefore κ is at a maximum at the point $(-\ln \sqrt{2}, \frac{1}{\sqrt{2}})$

7. $\mathbf{r} = x\mathbf{i} + y\mathbf{j} \Rightarrow \mathbf{v} = \frac{dx}{dt}\mathbf{i} + \frac{dy}{dt}\mathbf{j}$ and $\mathbf{v} \cdot \mathbf{i} = y \Rightarrow \frac{dx}{dt} = y$. Since the particle moves around the unit circle $x^2 + y^2 = 1$, $2x \frac{dx}{dt} + 2y \frac{dy}{dt} = 0 \Rightarrow \frac{dy}{dt} = -\frac{x}{y} \frac{dx}{dt} \Rightarrow \frac{dy}{dt} = -\frac{x}{y}(y) = -x$. Since $\frac{dx}{dt} = y$ and $\frac{dy}{dt} = -x$, we have $\mathbf{v} = y\mathbf{i} - x\mathbf{j} \Rightarrow$ at $(1, 0)$, $\mathbf{v} = -\mathbf{j}$ and the motion is clockwise.

8. $9y = x^3 \Rightarrow 9 \frac{dy}{dt} = 3x^2 \frac{dx}{dt} \Rightarrow \frac{dy}{dt} = \frac{1}{3} x^2 \frac{dx}{dt}$. If $\mathbf{r} = x\mathbf{i} + y\mathbf{j}$, where x and y are differentiable functions of t , then $\mathbf{v} = \frac{dx}{dt}\mathbf{i} + \frac{dy}{dt}\mathbf{j}$. Hence $\mathbf{v} \cdot \mathbf{i} = 4 \Rightarrow \frac{dx}{dt} = 4$ and $\mathbf{v} \cdot \mathbf{j} = \frac{dy}{dt} = \frac{1}{3} x^2 \frac{dx}{dt} = \frac{1}{3} (3)^2 (4) = 12$ at $(3, 3)$.
 Also, $\mathbf{a} = \frac{d^2x}{dt^2}\mathbf{i} + \frac{d^2y}{dt^2}\mathbf{j}$ and $\frac{d^2y}{dt^2} = \left(\frac{2}{3}x\right)\left(\frac{dx}{dt}\right) + \left(\frac{1}{3}x^2\right)\frac{d^2x}{dt^2}$. Hence $\mathbf{a} \cdot \mathbf{i} = -2 \Rightarrow \frac{d^2x}{dt^2} = -2$ and $\mathbf{a} \cdot \mathbf{j} = \frac{d^2y}{dt^2} = \frac{2}{3}(3)(4)^2 + \frac{1}{3}(3)^2(-2) = 26$ at the point $(x, y) = (3, 3)$.

9. $\frac{d\mathbf{r}}{dt}$ orthogonal to $\mathbf{r} \Rightarrow 0 = \frac{d\mathbf{r}}{dt} \cdot \mathbf{r} = \frac{1}{2} \frac{d\mathbf{r}}{dt} \cdot \mathbf{r} + \frac{1}{2} \mathbf{r} \cdot \frac{d\mathbf{r}}{dt} = \frac{1}{2} \frac{d}{dt}(\mathbf{r} \cdot \mathbf{r}) \Rightarrow \mathbf{r} \cdot \mathbf{r} = K$, a constant. If $\mathbf{r} = x\mathbf{i} + y\mathbf{j}$, where x and y are differentiable functions of t , then $\mathbf{r} \cdot \mathbf{r} = x^2 + y^2 \Rightarrow x^2 + y^2 = K$, which is the equation of a circle centered at the origin.

10. (a)

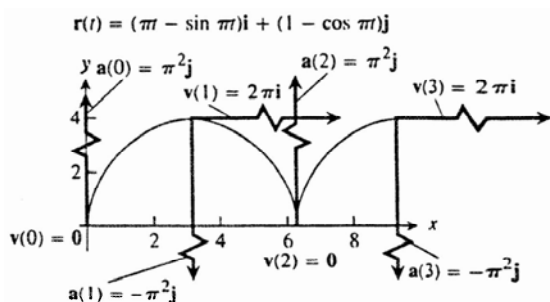

(b) $\mathbf{v} = (\pi - \pi \cos \pi t)\mathbf{i} + (\pi \sin \pi t)\mathbf{j}$
 $\Rightarrow \mathbf{a} = (\pi^2 \sin \pi t)\mathbf{i} + (\pi^2 \cos \pi t)\mathbf{j}$;
 $\mathbf{v}(0) = \mathbf{0}$ and $\mathbf{a}(0) = \pi^2 \mathbf{j}$;
 $\mathbf{v}(1) = 2\pi \mathbf{i}$ and $\mathbf{a}(1) = -\pi^2 \mathbf{j}$;
 $\mathbf{v}(2) = \mathbf{0}$ and $\mathbf{a}(2) = \pi^2 \mathbf{j}$;
 $\mathbf{v}(3) = 2\pi \mathbf{i}$; and $\mathbf{a}(3) = -\pi^2 \mathbf{j}$

(c) Forward speed at the topmost point is $|\mathbf{v}(1)| = |\mathbf{v}(3)| = 2\pi$ ft/sec; since the circle makes $\frac{1}{2}$ revolution per second, the center moves π ft parallel to the x -axis each second \Rightarrow the forward speed of C is π ft/sec.

11. $y = y_0 + (v_0 \sin \alpha)t - \frac{1}{2}gt^2 \Rightarrow y = 6.5 + (44 \text{ ft/sec})(\sin 45^\circ)(3 \text{ sec}) - \frac{1}{2}(32 \text{ ft/sec}^2)(3 \text{ sec})^2 = 6.5 + 66\sqrt{2} - 144$
 $\approx -44.16 \text{ ft} \Rightarrow$ the shot put is on the ground. Now, $y = 0 \Rightarrow 6.5 + 22\sqrt{2}t - 16t^2 = 0 \Rightarrow t \approx 2.13 \text{ sec}$ (the positive root) $\Rightarrow x \approx (44 \text{ ft/sec})(\cos 45^\circ)(2.13 \text{ sec}) \approx 66.27 \text{ ft}$ or about 66 ft, 3 in. from the stopboard

12. $y_{\max} = y_0 + \frac{(v_0 \sin \alpha)^2}{2g} = 7 \text{ ft} + \frac{[(80 \text{ ft/sec})(\sin 45^\circ)]^2}{(2)(32 \text{ ft/sec}^2)} \approx 57 \text{ ft}$

13. $x = (v_0 \cos \alpha)t$ and $y = (v_0 \sin \alpha)t - \frac{1}{2}gt^2 \Rightarrow \tan \phi = \frac{y}{x} = \frac{(v_0 \sin \alpha)t - \frac{1}{2}gt^2}{(v_0 \cos \alpha)t} = \frac{(v_0 \sin \alpha) - \frac{1}{2}gt}{v_0 \cos \alpha}$
 $\Rightarrow v_0 \cos \alpha \tan \phi = v_0 \sin \alpha - \frac{1}{2}gt \Rightarrow t = \frac{2v_0 \sin \alpha - 2v_0 \cos \alpha \tan \phi}{g}$, which is the time when the golf ball hits the upward slope. At this time $x = (v_0 \cos \alpha)\left(\frac{2v_0 \sin \alpha - 2v_0 \cos \alpha \tan \phi}{g}\right) = \left(\frac{2}{g}\right)(v_0^2 \sin \alpha \cos \alpha - v_0^2 \cos^2 \alpha \tan \phi)$. Now

$$OR = \frac{x}{\cos \phi} \Rightarrow OR = \left(\frac{2}{g}\right)\left(\frac{v_0^2 \sin \alpha \cos \alpha - v_0^2 \cos^2 \alpha \tan \phi}{\cos \phi}\right)$$

$$= \left(\frac{2v_0^2 \cos \alpha}{g}\right)\left(\frac{\sin \alpha}{\cos \phi} - \frac{\cos \alpha \tan \phi}{\cos \phi}\right) = \left(\frac{2v_0^2 \cos \alpha}{g}\right)\left(\frac{\sin \alpha \cos \phi - \cos \alpha \sin \phi}{\cos^2 \phi}\right)$$

$$= \left(\frac{2v_0^2 \cos \alpha}{g \cos^2 \phi}\right)[\sin(\alpha - \phi)].$$
 The distance OR is maximized when x

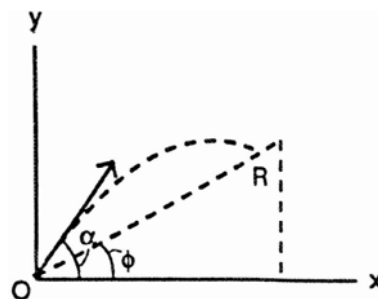

is maximized: $\frac{dx}{d\alpha} = \left(\frac{2v_0^2}{g}\right)(\cos 2\alpha + \sin 2\alpha \tan \phi) = 0$

$$\Rightarrow (\cos 2\alpha + \sin 2\alpha \tan \phi) = 0 \Rightarrow \cot 2\alpha + \tan \phi = 0 \Rightarrow \cot 2\alpha = \tan(-\phi) \Rightarrow 2\alpha = \frac{\pi}{2} + \phi \Rightarrow \alpha = \frac{\phi}{2} + \frac{\pi}{4}$$

14. (a) $x = v_0(\cos 40^\circ)t$ and $y = 6.5 + v_0(\sin 40^\circ)t - \frac{1}{2}gt^2 = 6.5 + v_0(\sin 40^\circ)t - 16t^2$; $x = 262\frac{5}{12} \text{ ft}$ and

$$y = 0 \text{ ft} \Rightarrow 262\frac{5}{12} = v_0(\cos 40^\circ)t \text{ or } v_0 = \frac{262.4167}{(\cos 40^\circ)t} \text{ and } 0 = 6.5 + \left[\frac{262.4167}{(\cos 40^\circ)t}\right](\sin 40^\circ)t - 16t^2$$

$$\Rightarrow t^2 = 14.1684 \Rightarrow t \approx 3.764 \text{ sec. Therefore, } 262.4167 \approx v_0(\cos 40^\circ)(3.764 \text{ sec})$$

$$\Rightarrow v_0 \approx \frac{262.4167}{(\cos 40^\circ)(3.764 \text{ sec})} \Rightarrow v_0 \approx 91 \text{ ft/sec}$$

(b) $y_{\max} = y_0 + \frac{(v_0 \sin \alpha)^2}{2g} \approx 6.5 + \frac{(91)(\sin 40^\circ)^2}{(2)(32)} \approx 60 \text{ ft}$

15. $\mathbf{r} = (2 \cos t)\mathbf{i} + (2 \sin t)\mathbf{j} + t^2\mathbf{k} \Rightarrow \mathbf{v} = (-2 \sin t)\mathbf{i} + (2 \cos t)\mathbf{j} + 2t\mathbf{k} \Rightarrow |\mathbf{v}| = \sqrt{(-2 \sin t)^2 + (2 \cos t)^2 + (2t)^2}$
 $= 2\sqrt{1+t^2} \Rightarrow \text{Length} = \int_0^{\pi/4} 2\sqrt{1+t^2} dt = \left[t\sqrt{1+t^2} + \ln|t + \sqrt{1+t^2}| \right]_0^{\pi/4} = \frac{\pi}{4}\sqrt{1 + \frac{\pi^2}{16}} + \ln\left(\frac{\pi}{4} + \sqrt{1 + \frac{\pi^2}{16}}\right)$

16. $\mathbf{r} = (3 \cos t)\mathbf{i} + (3 \sin t)\mathbf{j} + 2t^{3/2}\mathbf{k} \Rightarrow \mathbf{v} = (-3 \sin t)\mathbf{i} + (3 \cos t)\mathbf{j} + 3t^{1/2}\mathbf{k} \Rightarrow |\mathbf{v}| = \sqrt{(-3 \sin t)^2 + (3 \cos t)^2 + (3t^{1/2})^2}$
 $= \sqrt{9+9t} = 3\sqrt{1+t} \Rightarrow \text{Length} = \int_0^3 3\sqrt{1+t} dt = \left[2(1+t)^{3/2} \right]_0^3 = 14$

$$\begin{aligned}
 17. \quad \mathbf{r} &= \frac{4}{9}(1+t)^{3/2} \mathbf{i} + \frac{4}{9}(1-t)^{3/2} \mathbf{j} + \frac{1}{3}t\mathbf{k} \Rightarrow \mathbf{v} = \frac{2}{3}(1+t)^{1/2} \mathbf{i} - \frac{2}{3}(1-t)^{1/2} \mathbf{j} + \frac{1}{3}\mathbf{k} \\
 &\Rightarrow |\mathbf{v}| = \sqrt{\left[\frac{2}{3}(1+t)^{1/2}\right]^2 + \left[-\frac{2}{3}(1-t)^{1/2}\right]^2 + \left(\frac{1}{3}\right)^2} = 1 \Rightarrow \mathbf{T} = \frac{2}{3}(1+t)^{1/2} \mathbf{i} - \frac{2}{3}(1-t)^{1/2} \mathbf{j} + \frac{1}{3}\mathbf{k} \\
 &\Rightarrow \mathbf{T}(0) = \frac{2}{3}\mathbf{i} - \frac{2}{3}\mathbf{j} + \frac{1}{3}\mathbf{k}; \quad \frac{d\mathbf{T}}{dt} = \frac{1}{3}(1+t)^{-1/2} \mathbf{i} + \frac{1}{3}(1-t)^{-1/2} \mathbf{j} \Rightarrow \left.\frac{d\mathbf{T}}{dt}\right|(0) = \frac{1}{3}\mathbf{i} + \frac{1}{3}\mathbf{j} \Rightarrow \left|\left.\frac{d\mathbf{T}}{dt}\right|(0)\right| = \frac{\sqrt{2}}{3} \\
 &\Rightarrow \mathbf{N}(0) = \frac{1}{\sqrt{2}}\mathbf{i} + \frac{1}{\sqrt{2}}\mathbf{j}; \quad \mathbf{B}(0) = \mathbf{T}(0) \times \mathbf{N}(0) = \begin{vmatrix} \mathbf{i} & \mathbf{j} & \mathbf{k} \\ \frac{2}{3} & -\frac{2}{3} & \frac{1}{3} \\ \frac{1}{\sqrt{2}} & \frac{1}{\sqrt{2}} & 0 \end{vmatrix} = -\frac{1}{3\sqrt{2}}\mathbf{i} + \frac{1}{3\sqrt{2}}\mathbf{j} + \frac{4}{3\sqrt{2}}\mathbf{k}; \\
 &\mathbf{a} = \frac{1}{3}(1+t)^{-1/2} \mathbf{i} + \frac{1}{3}(1-t)^{-1/2} \mathbf{j} \Rightarrow \mathbf{a}(0) = \frac{1}{3}\mathbf{i} + \frac{1}{3}\mathbf{j} \text{ and } \mathbf{v}(0) = \frac{2}{3}\mathbf{i} - \frac{2}{3}\mathbf{j} + \frac{1}{3}\mathbf{k} \Rightarrow \mathbf{v}(0) \times \mathbf{a}(0) = \begin{vmatrix} \mathbf{i} & \mathbf{j} & \mathbf{k} \\ \frac{2}{3} & -\frac{2}{3} & \frac{1}{3} \\ \frac{1}{3} & \frac{1}{3} & 0 \end{vmatrix} \\
 &= -\frac{1}{9}\mathbf{i} + \frac{1}{9}\mathbf{j} + \frac{4}{9}\mathbf{k} \Rightarrow |\mathbf{v} \times \mathbf{a}| = \frac{\sqrt{2}}{3} \Rightarrow \kappa(0) = \frac{|\mathbf{v} \times \mathbf{a}|}{|\mathbf{v}|^3} = \frac{\left(\frac{\sqrt{2}}{3}\right)}{1^3} = \frac{\sqrt{2}}{3}; \\
 &\dot{\mathbf{a}} = -\frac{1}{6}(1+t)^{-3/2} \mathbf{i} + \frac{1}{6}(1-t)^{-3/2} \mathbf{j} \Rightarrow \dot{\mathbf{a}}(0) = -\frac{1}{6}\mathbf{i} + \frac{1}{6}\mathbf{j} \Rightarrow \tau(0) = \frac{\begin{vmatrix} \frac{2}{3} & -\frac{2}{3} & \frac{1}{3} \\ \frac{1}{3} & \frac{1}{3} & 0 \\ -\frac{1}{6} & \frac{1}{6} & 0 \end{vmatrix}}{|\mathbf{v} \times \mathbf{a}|^2} = \frac{\left(\frac{1}{3}\right)\left(\frac{2}{18}\right)}{\left(\frac{\sqrt{2}}{3}\right)^2} = \frac{1}{6}
 \end{aligned}$$

$$\begin{aligned}
 18. \quad \mathbf{r} &= (e^t \sin 2t)\mathbf{i} + (e^t \cos 2t)\mathbf{j} + 2e^t\mathbf{k} \Rightarrow \mathbf{v} = (e^t \sin 2t + 2e^t \cos 2t)\mathbf{i} + (e^t \cos 2t - 2e^t \sin 2t)\mathbf{j} + 2e^t\mathbf{k} \\
 &\Rightarrow |\mathbf{v}| = \sqrt{(e^t \sin 2t + 2e^t \cos 2t)^2 + (e^t \cos 2t - 2e^t \sin 2t)^2 + (2e^t)^2} = 3e^t \\
 &\Rightarrow \mathbf{T} = \frac{\mathbf{v}}{|\mathbf{v}|} = \left(\frac{1}{3} \sin 2t + \frac{2}{3} \cos 2t\right)\mathbf{i} + \left(\frac{1}{3} \cos 2t - \frac{2}{3} \sin 2t\right)\mathbf{j} + \frac{2}{3}\mathbf{k} \Rightarrow \mathbf{T}(0) = \frac{2}{3}\mathbf{i} + \frac{1}{3}\mathbf{j} + \frac{2}{3}\mathbf{k}; \\
 &\frac{d\mathbf{T}}{dt} = \left(\frac{2}{3} \cos 2t - \frac{4}{3} \sin 2t\right)\mathbf{i} + \left(-\frac{2}{3} \sin 2t - \frac{4}{3} \cos 2t\right)\mathbf{j} \Rightarrow \left.\frac{d\mathbf{T}}{dt}\right|(0) = \frac{2}{3}\mathbf{i} - \frac{4}{3}\mathbf{j} \Rightarrow \left|\left.\frac{d\mathbf{T}}{dt}\right|(0)\right| = \frac{2}{3}\sqrt{5} \\
 &\Rightarrow \mathbf{N}(0) = \frac{\left(\frac{2}{3}\mathbf{i} - \frac{4}{3}\mathbf{j}\right)}{\left(\frac{2\sqrt{5}}{3}\right)} = \frac{1}{\sqrt{5}}\mathbf{i} - \frac{2}{\sqrt{5}}\mathbf{j}; \quad \mathbf{B}(0) = \mathbf{T}(0) \times \mathbf{N}(0) = \begin{vmatrix} \mathbf{i} & \mathbf{j} & \mathbf{k} \\ \frac{2}{3} & \frac{1}{3} & \frac{2}{3} \\ \frac{1}{\sqrt{5}} & -\frac{2}{\sqrt{5}} & 0 \end{vmatrix} = \frac{4}{3\sqrt{5}}\mathbf{i} + \frac{2}{3\sqrt{5}}\mathbf{j} - \frac{5}{3\sqrt{5}}\mathbf{k}; \\
 &\mathbf{a} = (4e^t \cos 2t - 3e^t \sin 2t)\mathbf{i} + (-3e^t \cos 2t - 4e^t \sin 2t)\mathbf{j} + 2e^t\mathbf{k} \Rightarrow \mathbf{a}(0) = 4\mathbf{i} - 3\mathbf{j} + 2\mathbf{k} \text{ and} \\
 &\mathbf{v}(0) = 2\mathbf{i} + \mathbf{j} + 2\mathbf{k} \Rightarrow \mathbf{v}(0) \times \mathbf{a}(0) = \begin{vmatrix} \mathbf{i} & \mathbf{j} & \mathbf{k} \\ 2 & 1 & 2 \\ 4 & -3 & 2 \end{vmatrix} = 8\mathbf{i} + 4\mathbf{j} - 10\mathbf{k} \Rightarrow |\mathbf{v} \times \mathbf{a}| = \sqrt{64 + 16 + 100} = 6\sqrt{5} \text{ and} \\
 &|\mathbf{v}(0)| = 3 \Rightarrow \kappa(0) = \frac{6\sqrt{5}}{3^3} = \frac{2\sqrt{5}}{9}; \\
 &\dot{\mathbf{a}} = (4e^t \cos 2t - 8e^t \sin 2t - 3e^t \sin 2t - 6e^t \cos 2t)\mathbf{i} + (-3e^t \cos 2t + 6e^t \sin 2t - 4e^t \sin 2t - 8e^t \cos 2t)\mathbf{j} + 2e^t\mathbf{k} \\
 &= (-2e^t \cos 2t - 11e^t \sin 2t)\mathbf{i} + (-11e^t \cos 2t + 2e^t \sin 2t)\mathbf{j} + 2e^t\mathbf{k} \Rightarrow \dot{\mathbf{a}}(0) = -2\mathbf{i} - 11\mathbf{j} + 2\mathbf{k} \\
 &\Rightarrow \tau(0) = \frac{\begin{vmatrix} 2 & 1 & 2 \\ 4 & -3 & 2 \\ -2 & -11 & 2 \end{vmatrix}}{|\mathbf{v} \times \mathbf{a}|^2} = \frac{-80}{180} = -\frac{4}{9}
 \end{aligned}$$

19. $\mathbf{r} = t\mathbf{i} + \frac{1}{2}e^{2t}\mathbf{j} \Rightarrow \mathbf{v} = \mathbf{i} + e^{2t}\mathbf{j} \Rightarrow |\mathbf{v}| = \sqrt{1+e^{4t}} \Rightarrow \mathbf{T} = \frac{1}{\sqrt{1+e^{4t}}}\mathbf{i} + \frac{e^{2t}}{\sqrt{1+e^{4t}}}\mathbf{j} \Rightarrow \mathbf{T}(\ln 2) = \frac{1}{\sqrt{17}}\mathbf{i} + \frac{4}{\sqrt{17}}\mathbf{j};$

$\frac{d\mathbf{T}}{dt} = \frac{-2e^{4t}}{(1+e^{4t})^{3/2}}\mathbf{i} + \frac{2e^{2t}}{(1+e^{4t})^{3/2}}\mathbf{j} \Rightarrow \frac{d\mathbf{T}}{dt}(\ln 2) = \frac{-32}{17\sqrt{17}}\mathbf{i} + \frac{8}{17\sqrt{17}}\mathbf{j} \Rightarrow \mathbf{N}(\ln 2) = -\frac{4}{\sqrt{17}}\mathbf{i} + \frac{1}{17}\mathbf{j};$

$\mathbf{B}(\ln 2) = \mathbf{T}(\ln 2) \times \mathbf{N}(\ln 2) = \begin{vmatrix} \mathbf{i} & \mathbf{j} & \mathbf{k} \\ \frac{1}{\sqrt{17}} & \frac{4}{\sqrt{17}} & 0 \\ -\frac{4}{\sqrt{17}} & \frac{1}{\sqrt{17}} & 0 \end{vmatrix} = \mathbf{k}; \mathbf{a} = 2e^{2t}\mathbf{j} \Rightarrow \mathbf{a}(\ln 2) = 8\mathbf{j} \text{ and } \mathbf{v}(\ln 2) = \mathbf{i} + 4\mathbf{j}$

$\Rightarrow \mathbf{v}(\ln 2) \times \mathbf{a}(\ln 2) = \begin{vmatrix} \mathbf{i} & \mathbf{j} & \mathbf{k} \\ 1 & 4 & 0 \\ 0 & 8 & 0 \end{vmatrix} = 8\mathbf{k} \Rightarrow |\mathbf{v} \times \mathbf{a}| = 8 \text{ and } |\mathbf{v}(\ln 2)| = \sqrt{17} \Rightarrow \kappa(\ln 2) = \frac{8}{17\sqrt{17}};$

$\dot{\mathbf{a}} = 4e^{2t}\mathbf{j} \Rightarrow \dot{\mathbf{a}}(\ln 2) = 16\mathbf{j} \Rightarrow \tau(\ln 2) = \frac{\begin{vmatrix} 1 & 4 & 0 \\ 0 & 8 & 0 \\ 0 & 16 & 0 \end{vmatrix}}{|\mathbf{v} \times \mathbf{a}|^2} = 0$

20. $r = (3 \cosh 2t)\mathbf{i} + (3 \sinh 2t)\mathbf{j} + 6t\mathbf{k} \Rightarrow \mathbf{v} = (6 \sinh 2t)\mathbf{i} + (6 \cosh 2t)\mathbf{j} + 6\mathbf{k}$

$\Rightarrow |\mathbf{v}| = \sqrt{36 \sinh^2 2t + 36 \cosh^2 2t + 36} = 6\sqrt{2} \cosh 2t \Rightarrow \mathbf{T} = \frac{\mathbf{v}}{|\mathbf{v}|} = \left(\frac{1}{\sqrt{2}} \tanh 2t\right)\mathbf{i} + \frac{1}{\sqrt{2}}\mathbf{j} + \left(\frac{1}{\sqrt{2}} \operatorname{sech} 2t\right)\mathbf{k}$

$\Rightarrow \mathbf{T}(\ln 2) = \frac{5}{17\sqrt{2}}\mathbf{i} + \frac{1}{\sqrt{2}}\mathbf{j} + \frac{8}{17\sqrt{2}}\mathbf{k}; \frac{d\mathbf{T}}{dt} = \left(\frac{2}{\sqrt{2}} \operatorname{sech}^2 2t\right)\mathbf{i} - \left(\frac{2}{\sqrt{2}} \operatorname{sech} 2t \tanh 2t\right)\mathbf{k}$

$\Rightarrow \frac{d\mathbf{T}}{dt}(\ln 2) = \left(\frac{2}{\sqrt{2}}\right)\left(\frac{8}{17}\right)^2\mathbf{i} - \left(\frac{2}{\sqrt{2}}\right)\left(\frac{8}{17}\right)\left(\frac{15}{17}\right)\mathbf{k} = \frac{128}{289\sqrt{2}}\mathbf{i} - \frac{240}{289\sqrt{2}}\mathbf{k} \Rightarrow \left|\frac{d\mathbf{T}}{dt}(\ln 2)\right| = \sqrt{\left(\frac{128}{289\sqrt{2}}\right)^2 + \left(-\frac{240}{289\sqrt{2}}\right)^2} = \frac{8\sqrt{2}}{17}$

$\Rightarrow \mathbf{N}(\ln 2) = \frac{8}{17}\mathbf{i} - \frac{15}{17}\mathbf{k}; \mathbf{B}(\ln 2) = \mathbf{T}(\ln 2) \times \mathbf{N}(\ln 2) = \begin{vmatrix} \mathbf{i} & \mathbf{j} & \mathbf{k} \\ \frac{15}{17\sqrt{2}} & \frac{1}{\sqrt{2}} & \frac{8}{17\sqrt{2}} \\ \frac{8}{17} & 0 & -\frac{15}{17} \end{vmatrix} = -\frac{15}{17\sqrt{2}}\mathbf{i} + \frac{1}{\sqrt{2}}\mathbf{j} - \frac{8}{17\sqrt{2}}\mathbf{k};$

$\mathbf{a} = (12 \cosh 2t)\mathbf{i} + (12 \sinh 2t)\mathbf{j} \Rightarrow \mathbf{a}(\ln 2) = 12\left(\frac{17}{8}\right)\mathbf{i} + 12\left(\frac{15}{8}\right)\mathbf{j} = \frac{51}{2}\mathbf{i} + \frac{45}{2}\mathbf{j} \text{ and } \mathbf{v}(\ln 2) = 6\left(\frac{15}{8}\right)\mathbf{i} + 6\left(\frac{17}{8}\right)\mathbf{j} + 6\mathbf{k}$

$= \frac{45}{4}\mathbf{i} + \frac{51}{4}\mathbf{j} + 6\mathbf{k} \Rightarrow \mathbf{v}(\ln 2) \times \mathbf{a}(\ln 2) = \begin{vmatrix} \mathbf{i} & \mathbf{j} & \mathbf{k} \\ \frac{45}{4} & \frac{51}{4} & 6 \\ \frac{51}{2} & \frac{45}{2} & 0 \end{vmatrix} = -135\mathbf{i} + 153\mathbf{j} - 72\mathbf{k} \Rightarrow |\mathbf{v} \times \mathbf{a}| = 153\sqrt{2} \text{ and } |\mathbf{v}(\ln 2)| = \frac{51}{4}\sqrt{2}$

$\Rightarrow \kappa(\ln 2) = \frac{153\sqrt{2}}{\left(\frac{51}{4}\sqrt{2}\right)^3} = \frac{32}{867}; \dot{\mathbf{a}} = (24 \sinh 2t)\mathbf{i} + (24 \cosh 2t)\mathbf{j} \Rightarrow \dot{\mathbf{a}}(\ln 2) = 45\mathbf{i} + 51\mathbf{j} \Rightarrow \tau(\ln 2) = \frac{\begin{vmatrix} \frac{45}{4} & \frac{51}{4} & 6 \\ \frac{51}{2} & \frac{45}{2} & 0 \\ 45 & 51 & 0 \end{vmatrix}}{|\mathbf{v} \times \mathbf{a}|^2} = \frac{32}{867}$

21. $\mathbf{r} = (2 + 3t + 3t^2)\mathbf{i} + (4t + 4t^2)\mathbf{j} - (6 \cos t)\mathbf{k} \Rightarrow \mathbf{v} = (3 + 6t)\mathbf{i} + (4 + 8t)\mathbf{j} + (6 \sin t)\mathbf{k}$

$\Rightarrow |\mathbf{v}| = \sqrt{(3 + 6t)^2 + (4 + 8t)^2 + (6 \sin t)^2} = \sqrt{25 + 100t + 100t^2 + 36 \sin^2 t}$

$\Rightarrow \frac{d|\mathbf{v}|}{dt} = \frac{1}{2}(25 + 100t + 100t^2 + 36 \sin^2 t)^{-1/2} (100 + 200t + 72 \sin t \cos t) \xrightarrow{t=0} a_T(0) = \frac{d|\mathbf{v}|}{dt}(0) = 10;$

$$\mathbf{a} = 6\mathbf{i} + 8\mathbf{j} + (6\cos t)\mathbf{k} \Rightarrow |\mathbf{a}| = \sqrt{6^2 + 8^2 + (6\cos t)^2} = \sqrt{100 + 36\cos^2 t} \Rightarrow |\mathbf{a}(0)| = \sqrt{136}$$

$$\Rightarrow a_N = \sqrt{|\mathbf{a}|^2 - a_T^2} = \sqrt{136 - 10^2} = \sqrt{36} = 6 \Rightarrow \mathbf{a}(0) = 10\mathbf{T} + 6\mathbf{N}$$

22. $\mathbf{r} = (2+t)\mathbf{i} + (t+2t^2)\mathbf{j} + (1+t^2)\mathbf{k} \Rightarrow \mathbf{v} = \mathbf{i} + (1+4t)\mathbf{j} + 2t\mathbf{k} \Rightarrow |\mathbf{v}| = \sqrt{1^2 + (1+4t)^2 + (2t)^2} = \sqrt{2+8t+20t^2}$

$$\Rightarrow \frac{d|\mathbf{v}|}{dt} = \frac{1}{2}(2+8t+20t^2)^{-1/2}(8+40t) \Rightarrow a_T = \frac{d|\mathbf{v}|}{dt}(0) = 2\sqrt{2}; \quad \mathbf{a} = 4\mathbf{j} + 2\mathbf{k} \Rightarrow |\mathbf{a}| = \sqrt{4^2 + 2^2} = \sqrt{20}$$

$$\Rightarrow a_N = \sqrt{|\mathbf{a}|^2 - a_T^2} = \sqrt{20 - (2\sqrt{2})^2} = \sqrt{12} = 2\sqrt{3} \Rightarrow \mathbf{a}(0) = 2\sqrt{2}\mathbf{T} + 2\sqrt{3}\mathbf{N}$$

23. $\mathbf{r} = (\sin t)\mathbf{i} + (\sqrt{2}\cos t)\mathbf{j} + (\sin t)\mathbf{k} \Rightarrow \mathbf{v} = (\cos t)\mathbf{i} - (\sqrt{2}\sin t)\mathbf{j} + (\cos t)\mathbf{k}$

$$\Rightarrow |\mathbf{v}| = \sqrt{(\cos t)^2 + (-\sqrt{2}\sin t)^2 + (\cos t)^2} = \sqrt{2} \Rightarrow \mathbf{T} = \frac{\mathbf{v}}{|\mathbf{v}|} = \left(\frac{1}{\sqrt{2}}\cos t\right)\mathbf{i} - (\sin t)\mathbf{j} + \left(\frac{1}{\sqrt{2}}\cos t\right)\mathbf{k};$$

$$\frac{d\mathbf{T}}{dt} = \left(-\frac{1}{\sqrt{2}}\sin t\right)\mathbf{i} - (\cos t)\mathbf{j} - \left(\frac{1}{\sqrt{2}}\sin t\right)\mathbf{k} \Rightarrow \left|\frac{d\mathbf{T}}{dt}\right| = \sqrt{\left(-\frac{1}{\sqrt{2}}\sin t\right)^2 + (-\cos t)^2 + \left(-\frac{1}{\sqrt{2}}\sin t\right)^2} = 1$$

$$\Rightarrow \mathbf{N} = \frac{\frac{d\mathbf{T}}{dt}}{\left|\frac{d\mathbf{T}}{dt}\right|} = \left(-\frac{1}{\sqrt{2}}\sin t\right)\mathbf{i} - (\cos t)\mathbf{j} - \left(\frac{1}{\sqrt{2}}\sin t\right)\mathbf{k}; \quad \mathbf{B} = \mathbf{T} \times \mathbf{N} = \begin{vmatrix} \mathbf{i} & \mathbf{j} & \mathbf{k} \\ \frac{1}{\sqrt{2}}\cos t & -\sin t & \frac{1}{\sqrt{2}}\cos t \\ -\frac{1}{\sqrt{2}}\sin t & -\cos t & -\frac{1}{\sqrt{2}}\sin t \end{vmatrix} = \frac{1}{\sqrt{2}}\mathbf{i} - \frac{1}{\sqrt{2}}\mathbf{k};$$

$$\mathbf{a} = (-\sin t)\mathbf{i} - (\sqrt{2}\cos t)\mathbf{j} - (\sin t)\mathbf{k} \Rightarrow \mathbf{v} \times \mathbf{a} = \begin{vmatrix} \mathbf{i} & \mathbf{j} & \mathbf{k} \\ \cos t & -\sqrt{2}\sin t & \cos t \\ -\sin t & -\sqrt{2}\cos t & -\sin t \end{vmatrix} = \sqrt{2}\mathbf{i} - \sqrt{2}\mathbf{k}$$

$$\Rightarrow |\mathbf{v} \times \mathbf{a}| = \sqrt{4} = 2 \Rightarrow \kappa = \frac{|\mathbf{v} \times \mathbf{a}|}{|\mathbf{v}|^3} = \frac{2}{(\sqrt{2})^3} = \frac{1}{\sqrt{2}}; \quad \dot{\mathbf{a}} = (-\cos t)\mathbf{i} + (\sqrt{2}\sin t)\mathbf{j} - (\cos t)\mathbf{k}$$

$$\Rightarrow \tau = \frac{\begin{vmatrix} \cos t & -\sqrt{2}\sin t & \cos t \\ -\sin t & -\sqrt{2}\cos t & -\sin t \\ -\cos t & \sqrt{2}\sin t & -\cos t \end{vmatrix}}{|\mathbf{v} \times \mathbf{a}|^2} = \frac{(\cos t)(\sqrt{2}) - (\sqrt{2}\sin t)(0) + (\cos t)(-\sqrt{2})}{4} = 0$$

24. $\mathbf{r} = \mathbf{i} + (5\cos t)\mathbf{j} + (3\sin t)\mathbf{k} \Rightarrow \mathbf{v} = (-5\sin t)\mathbf{j} + (3\cos t)\mathbf{k} \Rightarrow \mathbf{a} = (-5\cos t)\mathbf{j} - (3\sin t)\mathbf{k}$

$$\Rightarrow \mathbf{v} \cdot \mathbf{a} = 25\sin t \cos t - 9\sin t \cos t = 16\sin t \cos t; \quad \mathbf{v} \cdot \mathbf{a} = 0 \Rightarrow 16\sin t \cos t = 0 \Rightarrow \sin t = 0 \text{ or } \cos t = 0$$

$$\Rightarrow t = 0, \frac{\pi}{2} \text{ or } \pi$$

25. $\mathbf{r} = 2\mathbf{i} + \left(4\sin \frac{t}{2}\right)\mathbf{j} + \left(3 - \frac{t}{\pi}\right)\mathbf{k} \Rightarrow 0 = \mathbf{r} \cdot (\mathbf{i} - \mathbf{j}) = 2(1) + \left(4\sin \frac{t}{2}\right)(-1) \Rightarrow 0 = 2 - 4\sin \frac{t}{2} \Rightarrow \sin \frac{t}{2} = \frac{1}{2}$

$$\Rightarrow \frac{t}{2} = \frac{\pi}{6} \Rightarrow t = \frac{\pi}{3} \text{ (for the first time)}$$

26. $\mathbf{r}(t) = t\mathbf{i} + t^2\mathbf{j} + t^3\mathbf{k} \Rightarrow \mathbf{v} = \mathbf{i} + 2t\mathbf{j} + 3t^2\mathbf{k} \Rightarrow |\mathbf{v}| = \sqrt{1+4t^2+9t^4} \Rightarrow |\mathbf{v}(1)| = \sqrt{14} \Rightarrow \mathbf{T}(1) = \frac{1}{\sqrt{14}}\mathbf{i} + \frac{2}{\sqrt{14}}\mathbf{j} + \frac{3}{\sqrt{14}}\mathbf{k},$

which is normal to the normal plane $\Rightarrow \frac{1}{\sqrt{14}}(x-1) + \frac{2}{\sqrt{14}}(y-1) + \frac{3}{\sqrt{14}}(z-1) = 0$ or $x + 2y + 3z = 6$ is an equation of the normal plane. Next we calculate $\mathbf{N}(1)$ which is normal to the rectifying plane. Now, $\mathbf{a} = 2\mathbf{j} + 6t\mathbf{k}$

$$\Rightarrow \mathbf{a}(1) = 2\mathbf{j} + 6\mathbf{k} \Rightarrow \mathbf{v}(1) \times \mathbf{a}(1) = \begin{vmatrix} \mathbf{i} & \mathbf{j} & \mathbf{k} \\ 1 & 2 & 3 \\ 0 & 2 & 6 \end{vmatrix} = 6\mathbf{i} - 6\mathbf{j} + 2\mathbf{k} \Rightarrow |\mathbf{v}(1) \times \mathbf{a}(1)| = \sqrt{76} \Rightarrow \kappa(1) = \frac{\sqrt{76}}{(\sqrt{14})^3} = \frac{\sqrt{19}}{7\sqrt{14}};$$

$$\frac{ds}{dt} = |\mathbf{v}(t)| \Rightarrow \left. \frac{d^2s}{dt^2} \right|_{t=1} = \frac{1}{2}(1+4t^2+9t^4)^{-1/2} (8t+36t^3) \Big|_{t=1} = \frac{22}{\sqrt{14}}, \text{ so } \mathbf{a} = \frac{d^2s}{dt^2} \mathbf{T} + \kappa \left(\frac{ds}{dt} \right)^2 \mathbf{N}$$

$$\Rightarrow 2\mathbf{j} + 6\mathbf{k} = \frac{22}{\sqrt{14}} \left(\frac{\mathbf{i} + 2\mathbf{j} + 3\mathbf{k}}{\sqrt{14}} \right) + \frac{\sqrt{19}}{7\sqrt{14}} (\sqrt{14})^2 \mathbf{N} \Rightarrow \mathbf{N} = \frac{\sqrt{14}}{2\sqrt{19}} \left(-\frac{11}{7}\mathbf{i} - \frac{8}{7}\mathbf{j} + \frac{9}{7}\mathbf{k} \right)$$

$\Rightarrow -\frac{11}{7}(x-1) - \frac{8}{7}(y-1) + \frac{9}{7}(z-1) = 0$ or $11x + 8y - 9z = 10$ is an equation of the rectifying plane. Finally,

$$\mathbf{B}(1) = \mathbf{T}(1) \times \mathbf{N}(1) = \left(\frac{\sqrt{14}}{2\sqrt{19}} \right) \left(\frac{1}{\sqrt{14}} \right) \left(\frac{1}{7} \right) \begin{vmatrix} \mathbf{i} & \mathbf{j} & \mathbf{k} \\ 1 & 2 & 3 \\ -11 & -8 & 9 \end{vmatrix} = \frac{1}{\sqrt{19}} (3\mathbf{i} - 3\mathbf{j} + \mathbf{k}) \Rightarrow 3(x-1) - 3(y-1) + (z-1) = 0 \text{ or}$$

$3x - 3y + z = 1$ is an equation of the osculating plane.

27. $\mathbf{r} = e^t \mathbf{i} + (\sin t)\mathbf{j} + \ln(1-t)\mathbf{k} \Rightarrow \mathbf{v} = e^t \mathbf{i} + (\cos t)\mathbf{j} - \left(\frac{1}{1-t} \right) \mathbf{k} \Rightarrow \mathbf{v}(0) = \mathbf{i} + \mathbf{j} - \mathbf{k}; \mathbf{r}(0) = \mathbf{i} \Rightarrow (1, 0, 0)$ is on the line $\Rightarrow x = 1+t, y = t,$ and $z = -t$ are parametric equations of the line

28. $\mathbf{r} = (\sqrt{2} \cos t)\mathbf{i} + (\sqrt{2} \sin t)\mathbf{j} + t\mathbf{k} \Rightarrow \mathbf{v} = (-\sqrt{2} \sin t)\mathbf{i} + (\sqrt{2} \cos t)\mathbf{j} + \mathbf{k}$

$\Rightarrow \mathbf{v}\left(\frac{\pi}{4}\right) = (-\sqrt{2} \sin \frac{\pi}{4})\mathbf{i} + (\sqrt{2} \cos \frac{\pi}{4})\mathbf{j} + \mathbf{k} = -\mathbf{i} + \mathbf{j} + \mathbf{k}$ is a vector tangent to the helix when $t = \frac{\pi}{4} \Rightarrow$ the tangent line is parallel to $\mathbf{v}\left(\frac{\pi}{4}\right)$; also $\mathbf{r}\left(\frac{\pi}{4}\right) = (\sqrt{2} \cos \frac{\pi}{4})\mathbf{i} + (\sqrt{2} \sin \frac{\pi}{4})\mathbf{j} + \frac{\pi}{4}\mathbf{k} \Rightarrow$ the point $(1, 1, \frac{\pi}{4})$ is on the line $\Rightarrow x = 1-t, y = 1+t,$ and $z = \frac{\pi}{4} + t$ are parametric equations of the line

29. $x^2 = (v_0^2 \cos^2 \alpha)t^2$ and $(y + \frac{1}{2}gt^2)^2 = (v_0^2 \sin^2 \alpha)t^2 \Rightarrow x^2 + (y + \frac{1}{2}gt^2)^2 = v_0^2 t^2$

30. $\ddot{s} = \frac{d}{dt} \sqrt{\dot{x}^2 + \dot{y}^2} = \frac{\dot{x}\ddot{x} + \dot{y}\ddot{y}}{\sqrt{\dot{x}^2 + \dot{y}^2}} \Rightarrow \ddot{x}^2 + \ddot{y}^2 - \ddot{s}^2 = \ddot{x}^2 + \ddot{y}^2 - \frac{(\dot{x}\ddot{x} + \dot{y}\ddot{y})^2}{\dot{x}^2 + \dot{y}^2} = \frac{(\dot{x}^2 + \dot{y}^2)(\ddot{x}^2 + \ddot{y}^2) - (\dot{x}\ddot{x} + \dot{y}\ddot{y})^2}{\dot{x}^2 + \dot{y}^2}$
 $= \frac{\dot{x}^2\ddot{y}^2 + \dot{y}^2\ddot{x}^2 - 2\dot{x}\dot{y}\ddot{x}\ddot{y}}{\dot{x}^2 + \dot{y}^2} = \frac{(\dot{x}\ddot{y} - \dot{y}\ddot{x})^2}{\dot{x}^2 + \dot{y}^2} \Rightarrow \sqrt{\ddot{x}^2 + \ddot{y}^2 - \ddot{s}^2} = \frac{|\dot{x}\ddot{y} - \dot{y}\ddot{x}|}{\sqrt{\dot{x}^2 + \dot{y}^2}} \Rightarrow \frac{\dot{x}^2 + \dot{y}^2}{\sqrt{\dot{x}^2 + \dot{y}^2 - \ddot{s}^2}} = \frac{(\dot{x}^2 + \dot{y}^2)^{3/2}}{|\dot{x}\ddot{y} - \dot{y}\ddot{x}|} = \frac{1}{\kappa} = \rho$

31. $s = a\theta \Rightarrow \theta = \frac{s}{a} \Rightarrow \phi = \frac{s}{a} + \frac{\pi}{2} \Rightarrow \frac{d\phi}{ds} = \frac{1}{a} \Rightarrow \kappa = \left| \frac{1}{a} \right| = \frac{1}{a}$ since $a > 0$

32. (1) $\Delta SOT \approx \Delta TOD \Rightarrow \frac{DO}{OT} = \frac{OT}{SO}$

$$\Rightarrow \frac{y_0}{6380} = \frac{6380}{6380+437} \Rightarrow y_0 = \frac{6380^2}{6817}$$

$$\Rightarrow y_0 \approx 5971 \text{ km};$$

(2) $VA = \int_{5971}^{6380} 2\pi x \sqrt{1 + \left(\frac{dx}{dy} \right)^2} dy$
 $= 2\pi \int_{5971}^{6380} \sqrt{6380^2 - y^2} \left(\frac{6380}{\sqrt{6380^2 - y^2}} \right) dy$
 $= 2\pi \int_{5971}^{6380} 6380 dy = 2\pi [6380y]_{5971}^{6380}$
 $= 16,395,469 \text{ km}^2 \approx 1.639 \times 10^7 \text{ km}^2;$

(3) percentage visible $\approx \frac{16,395,469 \text{ km}^2}{4\pi(6380 \text{ km})^2} \approx 3.21\%$

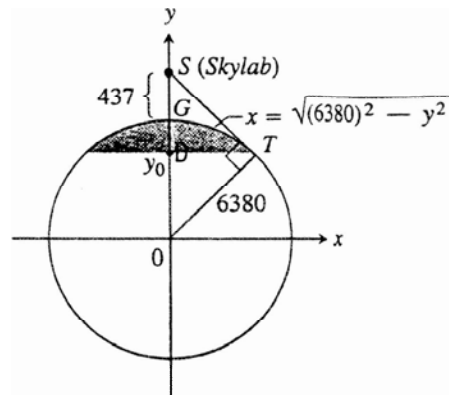

CHAPTER 13 ADDITIONAL AND ADVANCED EXERCISES

1. (a) $\mathbf{r}(\theta) = (a \cos \theta)\mathbf{i} + (a \sin \theta)\mathbf{j} + b\theta\mathbf{k} \Rightarrow \frac{d\mathbf{r}}{dt} = [(-a \sin \theta)\mathbf{i} + (a \cos \theta)\mathbf{j} + b\mathbf{k}] \frac{d\theta}{dt}$;
 $|\mathbf{v}| = \sqrt{2gz} = \left| \frac{d\mathbf{r}}{dt} \right| = \sqrt{a^2 + b^2} \frac{d\theta}{dt} \Rightarrow \frac{d\theta}{dt} = \sqrt{\frac{2gz}{a^2 + b^2}} = \sqrt{\frac{2gb\theta}{a^2 + b^2}} \Rightarrow \frac{d\theta}{dt} \Big|_{\theta=2\pi} = \sqrt{\frac{4\pi gb}{a^2 + b^2}} = 2\sqrt{\frac{\pi gb}{a^2 + b^2}}$
- (b) $\frac{d\theta}{dt} = \sqrt{\frac{2gb\theta}{a^2 + b^2}} \Rightarrow \frac{d\theta}{\sqrt{\theta}} = \sqrt{\frac{2gb}{a^2 + b^2}} dt \Rightarrow 2\theta^{1/2} = \sqrt{\frac{2gb}{a^2 + b^2}} t + C$; $t = 0 \Rightarrow \theta = 0 \Rightarrow C = 0 \Rightarrow 2\theta^{1/2} = \sqrt{\frac{2gb}{a^2 + b^2}} t$
 $\Rightarrow \theta = \frac{gbt^2}{2(a^2 + b^2)}$; $z = b\theta \Rightarrow z = \frac{gb^2 t^2}{2(a^2 + b^2)}$
- (c) $\mathbf{v}(t) = \frac{d\mathbf{r}}{dt} = [(-a \sin \theta)\mathbf{i} + (a \cos \theta)\mathbf{j} + b\mathbf{k}] \frac{d\theta}{dt} = [(-a \sin \theta)\mathbf{i} + (a \cos \theta)\mathbf{j} + b\mathbf{k}] \left(\frac{gbt}{a^2 + b^2} \right)$, from part (b)
 $\Rightarrow \mathbf{v}(t) = \left[\frac{(-a \sin \theta)\mathbf{i} + (a \cos \theta)\mathbf{j} + b\mathbf{k}}{\sqrt{a^2 + b^2}} \right] \left(\frac{gbt}{\sqrt{a^2 + b^2}} \right) = \frac{gbt}{\sqrt{a^2 + b^2}} \mathbf{T}$;
 $\frac{d^2\mathbf{r}}{dt^2} = [(-a \cos \theta)\mathbf{i} - (a \sin \theta)\mathbf{j}] \left(\frac{d\theta}{dt} \right)^2 + [(-a \sin \theta)\mathbf{i} + (a \cos \theta)\mathbf{j} + b\mathbf{k}] \frac{d^2\theta}{dt^2}$
 $= \left(\frac{gbt}{a^2 + b^2} \right)^2 [(-a \cos \theta)\mathbf{i} - (a \sin \theta)\mathbf{j}] + [(-a \sin \theta)\mathbf{i} + (a \cos \theta)\mathbf{j} + b\mathbf{k}] \left(\frac{gb}{a^2 + b^2} \right)$
 $= \left[\frac{(-a \sin \theta)\mathbf{i} + (a \cos \theta)\mathbf{j} + b\mathbf{k}}{\sqrt{a^2 + b^2}} \right] \left(\frac{gb}{\sqrt{a^2 + b^2}} \right) + a \left(\frac{gbt}{a^2 + b^2} \right) [(-\cos \theta)\mathbf{i} - (\sin \theta)\mathbf{j}] = \frac{gb}{\sqrt{a^2 + b^2}} \mathbf{T} + a \left(\frac{gbt}{a^2 + b^2} \right)^2 \mathbf{N}$ (there is no component in the direction of \mathbf{B}).
2. (a) $\mathbf{r}(\theta) = (a\theta \cos \theta)\mathbf{i} + (a\theta \sin \theta)\mathbf{j} + b\theta\mathbf{k} \Rightarrow \frac{d\mathbf{r}}{dt} = [(a \cos \theta - a\theta \sin \theta)\mathbf{i} + (a \sin \theta + a\theta \cos \theta)\mathbf{j} + b\mathbf{k}] \frac{d\theta}{dt}$;
 $|\mathbf{v}| = \sqrt{2gz} = \left| \frac{d\mathbf{r}}{dt} \right| = (a^2 + a^2\theta^2 + b^2)^{1/2} \left(\frac{d\theta}{dt} \right) \Rightarrow \frac{d\theta}{dt} = \frac{\sqrt{2gb\theta}}{\sqrt{a^2 + a^2\theta^2 + b^2}}$
- (b) $s = \int_0^t |\mathbf{v}| dt = \int_0^t (a^2 + a^2\theta^2 + b^2)^{1/2} \frac{d\theta}{dt} dt = \int_0^t (a^2 + a^2\theta^2 + b^2)^{1/2} d\theta = \int_0^\theta (a^2 + a^2u^2 + b^2)^{1/2} du$
 $= \int_0^\theta a \sqrt{\frac{a^2 + b^2}{a^2} + u^2} du = a \int_0^\theta a \sqrt{c^2 + u^2} du$, where $c = \frac{\sqrt{a^2 + b^2}}{|a|} \Rightarrow s = a \left[\frac{u}{2} \sqrt{c^2 + u^2} + \frac{c^2}{2} \ln \left| u + \sqrt{c^2 + u^2} \right| \right]_0^\theta$
 $= \frac{a}{2} \left(\theta \sqrt{c^2 + \theta^2} + c^2 \ln \left| \theta + \sqrt{c^2 + \theta^2} \right| - c^2 \ln c \right)$
3. $r = \frac{(1+e)r_0}{1+e \cos \theta} \Rightarrow \frac{dr}{d\theta} = \frac{(1+e)r_0(e \sin \theta)}{(1+e \cos \theta)^2}$; $\frac{dr}{d\theta} = 0 \Rightarrow \frac{(1+e)r_0(e \sin \theta)}{(1+e \cos \theta)^2} = 0 \Rightarrow (1+e)r_0(e \sin \theta) = 0 \Rightarrow \sin \theta = 0$
 $\Rightarrow \theta = 0$ or π . Note that $\frac{dr}{d\theta} > 0$ when $\sin \theta > 0$ and $\frac{dr}{d\theta} < 0$ when $\sin \theta < 0$. Since $\sin \theta < 0$ on $-\pi < \theta < 0$ and $\sin \theta > 0$ on $0 < \theta < \pi$, r is a minimum when $\theta = 0$ and $r(0) = \frac{(1+e)r_0}{1+e \cos 0} = r_0$
4. (a) $f(x) = x - 1 - \frac{1}{2} \sin x = 0 \Rightarrow f(0) = -1$ and $f(2) = 2 - 1 - \frac{1}{2} \sin 2 \geq \frac{1}{2}$ since $|\sin 2| \leq 1$; since f is continuous on $[0, 2]$, the Intermediate Value Theorem implies there is a root between 0 and 2
 (b) Root ≈ 1.4987011335179
5. (a) $\mathbf{v} = \dot{x} \mathbf{i} + \dot{y} \mathbf{j}$ and $\mathbf{v} = \dot{r} \mathbf{u}_r + r\dot{\theta} \mathbf{u}_\theta = (\dot{r}) [(\cos \theta)\mathbf{i} + (\sin \theta)\mathbf{j}] + (r\dot{\theta}) [(-\sin \theta)\mathbf{i} + (\cos \theta)\mathbf{j}] \Rightarrow \mathbf{v} \cdot \mathbf{i} = \dot{x}$ and $\mathbf{v} \cdot \mathbf{j} = \dot{y}$
 $\mathbf{v} \cdot \mathbf{i} = \dot{r} \cos \theta - r\dot{\theta} \sin \theta \Rightarrow \dot{x} = \dot{r} \cos \theta - r\dot{\theta} \sin \theta$; $\mathbf{v} \cdot \mathbf{j} = \dot{y}$ and $\mathbf{v} \cdot \mathbf{j} = \dot{r} \sin \theta + r\dot{\theta} \cos \theta \Rightarrow \dot{y} = \dot{r} \sin \theta + r\dot{\theta} \cos \theta$

- (b) $\mathbf{u}_r = (\cos \theta)\mathbf{i} + (\sin \theta)\mathbf{j} \Rightarrow \mathbf{v} \cdot \mathbf{u}_r = \dot{x} \cos \theta + \dot{y} \sin \theta = (\dot{r} \cos \theta - r\dot{\theta} \sin \theta)(\cos \theta) + (\dot{r} \sin \theta + r\dot{\theta} \cos \theta)(\sin \theta)$
 by part (a), $\Rightarrow \mathbf{v} \cdot \mathbf{u}_r = \dot{r}$; therefore, $\dot{r} = \dot{x} \cos \theta + \dot{y} \sin \theta$; $\mathbf{u}_\theta = -(\sin \theta)\mathbf{i} + (\cos \theta)\mathbf{j}$
 $\Rightarrow \mathbf{v} \cdot \mathbf{u}_\theta = -\dot{x} \sin \theta + \dot{y} \cos \theta = (\dot{r} \cos \theta - r\dot{\theta} \sin \theta)(-\sin \theta) + (\dot{r} \sin \theta + r\dot{\theta} \cos \theta)(\cos \theta)$ by part (a)
 $\Rightarrow \mathbf{v} \cdot \mathbf{u}_\theta = r\dot{\theta}$; therefore, $r\dot{\theta} = -\dot{x} \sin \theta + \dot{y} \cos \theta$

6. $r = f(\theta) \Rightarrow \frac{dr}{dt} = f'(\theta) \frac{d\theta}{dt} \Rightarrow \frac{d^2r}{dt^2} = f''(\theta) \left(\frac{d\theta}{dt}\right)^2 + f'(\theta) \frac{d^2\theta}{dt^2}$;

$\mathbf{v} = \frac{dr}{dt} \mathbf{u}_r + r \frac{d\theta}{dt} \mathbf{u}_\theta = \left(\cos \theta \frac{dr}{dt} - r \sin \theta \frac{d\theta}{dt}\right) \mathbf{i} + \left(\sin \theta \frac{dr}{dt} + r \cos \theta \frac{d\theta}{dt}\right) \mathbf{j}$

$\Rightarrow |\mathbf{v}| = \left[\left(\frac{dr}{dt}\right)^2 + r^2 \left(\frac{d\theta}{dt}\right)^2 \right]^{1/2} = \left[(f')^2 + f^2 \right]^{1/2} \left(\frac{d\theta}{dt}\right)$; $|\mathbf{v} \times \mathbf{a}| = |\dot{x} \ddot{y} - \dot{y} \ddot{x}|$,

where $x = r \cos \theta$ and $y = r \sin \theta$. Then $\frac{dx}{dt} = (-r \sin \theta) \frac{d\theta}{dt} + (\cos \theta) \frac{dr}{dt}$

$\Rightarrow \frac{d^2x}{dt^2} = (-2 \sin \theta) \frac{d\theta}{dt} \frac{dr}{dt} - (r \cos \theta) \left(\frac{d\theta}{dt}\right)^2 - (r \sin \theta) \frac{d^2\theta}{dt^2} + (\cos \theta) \frac{d^2r}{dt^2}$; $\frac{dy}{dt} = (r \cos \theta) \frac{d\theta}{dt} + (\sin \theta) \frac{dr}{dt}$

$\Rightarrow \frac{d^2y}{dt^2} = (2 \cos \theta) \frac{d\theta}{dt} \frac{dr}{dt} - (r \sin \theta) \left(\frac{d\theta}{dt}\right)^2 + (r \cos \theta) \frac{d^2\theta}{dt^2} + (\sin \theta) \frac{d^2r}{dt^2}$. Then, after much algebra $|\mathbf{v} \times \mathbf{a}|$

$= r^2 \left(\frac{d\theta}{dt}\right)^3 + r \frac{d^2\theta}{dt^2} \frac{dr}{dt} - r \frac{d\theta}{dt} \frac{d^2r}{dt^2} + 2 \frac{d\theta}{dt} \left(\frac{dr}{dt}\right)^2 = \left(\frac{d\theta}{dt}\right)^3 (f^2 - f \cdot f'' + 2(f')^2) \Rightarrow \kappa_{3/2} \frac{|\mathbf{v} \times \mathbf{a}|}{|\mathbf{v}|} = \frac{f^2 - f \cdot f'' + 2(f')^2}{[(f')^2 + f^2]^{3/2}}$

7. (a) Let $r = 2 - t$ and $\theta = 3t \Rightarrow \frac{dr}{dt} = -1$ and $\frac{d\theta}{dt} = 3 \Rightarrow \frac{d^2r}{dt^2} = \frac{d^2\theta}{dt^2} = 0$. The halfway point is $(1, 3) \Rightarrow t = 1$;

$\mathbf{v} = \frac{dr}{dt} \mathbf{u}_r + r \frac{d\theta}{dt} \mathbf{u}_\theta \Rightarrow \mathbf{v}(1) = -\mathbf{u}_r + 3\mathbf{u}_\theta$; $\mathbf{a} = \left[\frac{d^2r}{dt^2} - r \left(\frac{d\theta}{dt}\right)^2\right] \mathbf{u}_r + \left[r \frac{d^2\theta}{dt^2} + 2 \frac{dr}{dt} \frac{d\theta}{dt}\right] \mathbf{u}_\theta$

$\Rightarrow \mathbf{a}(1) = -9\mathbf{u}_r - 6\mathbf{u}_\theta$

- (b) It takes the beetle 2 min to crawl to the origin \Rightarrow the rod has revolved 6 radians

$\Rightarrow L = \int_0^6 \sqrt{[f(\theta)]^2 + [f'(\theta)]^2} d\theta = \int_0^6 \sqrt{\left(2 - \frac{\theta}{3}\right)^2 + \left(-\frac{1}{3}\right)^2} d\theta = \int_0^6 \sqrt{4 - \frac{4\theta}{3} + \frac{\theta^2}{9} + \frac{1}{9}} d\theta$

$= \int_0^6 \sqrt{\frac{37 - 12\theta + \theta^2}{9}} d\theta = \frac{1}{3} \int_0^6 \sqrt{(\theta - 6)^2 + 1} d\theta = \frac{1}{3} \left[\frac{(\theta - 6)}{2} \sqrt{(\theta - 6)^2 + 1} + \frac{1}{2} \ln \left| \theta - 6 + \sqrt{(\theta - 6)^2 + 1} \right| \right]_0^6$

$= \sqrt{37} - \frac{1}{6} \ln(\sqrt{37} - 6) \approx 6.5$ in.

8. (a) $x = r \cos \theta \Rightarrow dx = \cos \theta dr - r \sin \theta d\theta$; $y = r \sin \theta \Rightarrow dy = \sin \theta dr + r \cos \theta d\theta$; thus

$dx^2 = \cos^2 \theta dr^2 - 2r \sin \theta \cos \theta dr d\theta + r^2 \sin^2 \theta d\theta^2$ and

$dy^2 = \sin^2 \theta dr^2 + 2r \sin \theta \cos \theta dr d\theta + r^2 \cos^2 \theta d\theta^2 \Rightarrow ds^2 = dx^2 + dy^2 + dz^2 = dr^2 + r^2 d\theta^2 + dz^2$

- (c) $r = e^\theta \Rightarrow dr = e^\theta d\theta$

$\Rightarrow L = \int_0^{\ln 8} \sqrt{dr^2 + r^2 d\theta^2 + dz^2}$

$= \int_0^{\ln 8} \sqrt{e^{2\theta} + e^{2\theta} + e^{2\theta}} d\theta$

$= \int_0^{\ln 8} \sqrt{3} e^\theta d\theta = \left[\sqrt{3} e^\theta \right]_0^{\ln 8}$

$= 8\sqrt{3} - \sqrt{3} = 7\sqrt{3}$

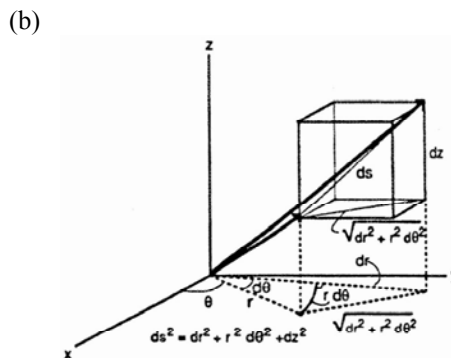

$$9. \text{ (a) } \mathbf{u}_r \times \mathbf{u}_\theta = \begin{vmatrix} \mathbf{i} & \mathbf{j} & \mathbf{k} \\ \cos \theta & \sin \theta & 0 \\ -\sin \theta & \cos \theta & 0 \end{vmatrix} = \mathbf{k} \Rightarrow a \text{ right-handed frame of unit vectors}$$

$$\text{(b) } \frac{d\mathbf{u}_r}{d\theta} = (-\sin \theta)\mathbf{i} + (\cos \theta)\mathbf{j} = \mathbf{u}_\theta \text{ and } \frac{d\mathbf{u}_\theta}{d\theta} = (-\cos \theta)\mathbf{i} - (\sin \theta)\mathbf{j} = -\mathbf{u}_r$$

$$\text{(c) From Eq. (7), } \mathbf{v} = \dot{r}\mathbf{u}_r + r\dot{\theta}\mathbf{u}_\theta + \dot{z}\mathbf{k} \Rightarrow \mathbf{a} = \dot{\mathbf{v}} = (\dot{r}\dot{\mathbf{u}}_r + \ddot{r}\mathbf{u}_r) + (\dot{r}\dot{\theta}\mathbf{u}_\theta + r\ddot{\theta}\mathbf{u}_\theta + r\dot{\theta}\dot{\mathbf{u}}_\theta) + \ddot{z}\mathbf{k} \\ = (\ddot{r} - r\dot{\theta}^2)\mathbf{u}_r + (r\ddot{\theta} + 2\dot{r}\dot{\theta})\mathbf{u}_\theta + \ddot{z}\mathbf{k}$$

$$10. \mathbf{L}(t) = \mathbf{r}(t) \times m\mathbf{v}(t) \Rightarrow \frac{d\mathbf{L}}{dt} = \left(\frac{d\mathbf{r}}{dt} \times m\mathbf{v}\right) + \left(\mathbf{r} \times m\frac{d^2\mathbf{r}}{dt^2}\right) \Rightarrow \frac{d\mathbf{L}}{dt} = (\mathbf{v} \times m\mathbf{v}) + (\mathbf{r} \times m\mathbf{a}) = \mathbf{r} \times m\mathbf{a};$$

$$\mathbf{F} = m\mathbf{a} \Rightarrow -\frac{c}{|\mathbf{r}|^3}\mathbf{r} = m\mathbf{a} \Rightarrow \frac{d\mathbf{L}}{dt} = \mathbf{r} \times m\mathbf{a} = \mathbf{r} \times \left(-\frac{c}{|\mathbf{r}|^3}\mathbf{r}\right) = -\frac{c}{|\mathbf{r}|^3}(\mathbf{r} \times \mathbf{r}) = \mathbf{0} \Rightarrow \mathbf{L} = \text{constant vector}$$

CHAPTER 14 PARTIAL DERIVATIVES

14.1 FUNCTIONS OF SEVERAL VARIABLES

- $f(0, 0) = 0$
 - $f(-3, -2) = 33$
- $f(2, \frac{\pi}{2}) = \frac{\sqrt{3}}{2}$
 - $f(-\frac{\pi}{2}, -7) = -1$
- $f(3, -1, 2) = \frac{4}{5}$
 - $f(2, 2, 100) = 0$
- $f(0, 0, 0) = 7$
 - $f(\frac{4}{\sqrt{2}}, \frac{5}{\sqrt{2}}, \frac{6}{\sqrt{2}}) = \sqrt{\frac{21}{2}}$

(b) $f(-1, 1) = 0$

(c) $f(2, 3) = 58$

(b) $f(-3, \frac{\pi}{12}) = -\frac{1}{\sqrt{2}}$

(c) $f(\pi, \frac{1}{4}) = \frac{1}{\sqrt{2}}$

(b) $f(1, \frac{1}{2}, -\frac{1}{4}) = \frac{8}{5}$

(c) $f(0, -\frac{1}{3}, 0) = 3$

(b) $f(2, -3, 6) = 0$

(c) $f(-1, 2, 3) = \sqrt{35}$

5. Domain: all points (x, y) on or above the line $y = x + 2$

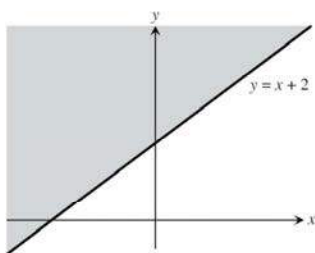

6. Domain: all points (x, y) outside the circle $x^2 + y^2 = 4$

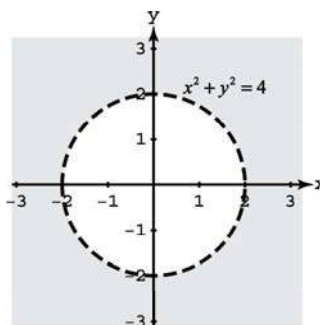

7. Domain: all points (x, y) not lying on the graph of $y = x$ or $y = x^3$

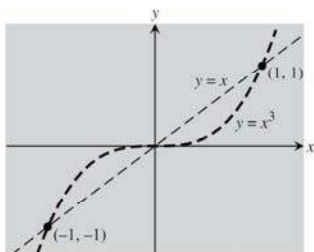

8. Domain: all points (x, y) not lying on the graph of $x^2 + y^2 = 25$

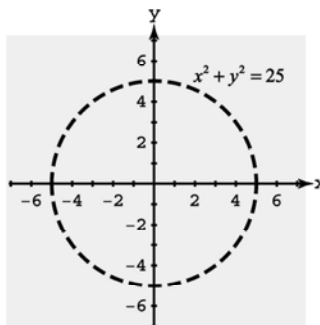

9. Domain: all points (x, y) satisfying $x^2 - 1 \leq y \leq x^2 + 1$

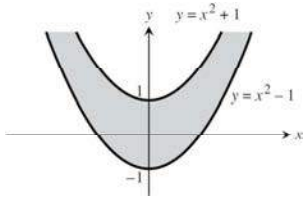

10. Domain: all points (x, y) satisfying $(x-1)(y+1) > 0$

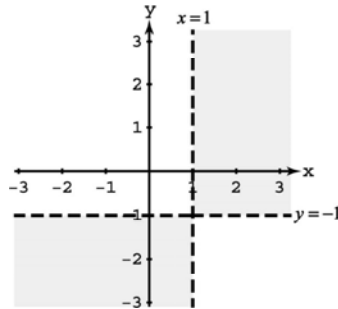

11. Domain: all points (x, y) satisfying $(x-2)(x+2)(y-3)(y+3) \geq 0$

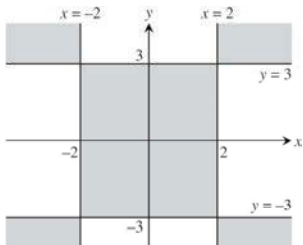

12. Domain: all points (x, y) inside the circle $x^2 + y^2 = 4$ such that $x^2 + y^2 \neq 3$

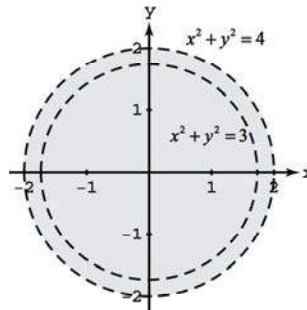

- 13.

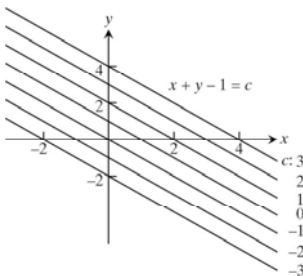

- 14.

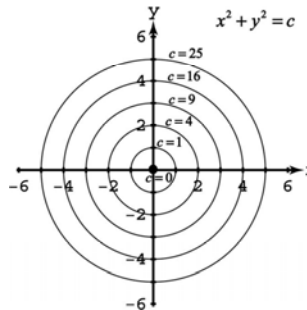

- 15.

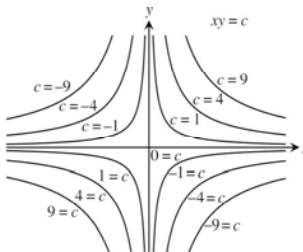

- 16.

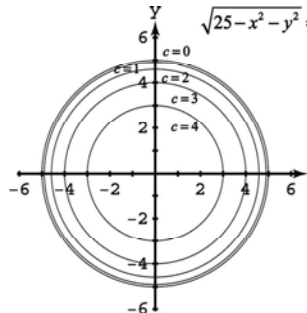

17. (a) Domain: all points in the xy -plane
 (b) Range: all real numbers
 (c) level curves are straight lines $y - x = c$ parallel to the line $y = x$
 (d) no boundary points
 (e) both open and closed
 (f) unbounded
18. (a) Domain: set of all (x, y) so that $y - x \geq 0 \Rightarrow y \geq x$
 (b) Range: $z \geq 0$
 (c) level curves are straight lines of the form $y - x = c$ where $c \geq 0$
 (d) boundary is $\sqrt{y - x} = 0 \Rightarrow y = x$, a straight line
 (e) closed
 (f) unbounded
19. (a) Domain: all points in the xy -plane
 (b) Range: $z \geq 0$
 (c) level curves: for $f(x, y) = 0$, the origin; for $f(x, y) = c > 0$, ellipses with center $(0, 0)$ and major and minor axes along the x - and y -axes, respectively
 (d) no boundary points
 (e) both open and closed
 (f) unbounded
20. (a) Domain: all points in the xy -plane
 (b) Range: all real numbers
 (c) level curves: for $f(x, y) = 0$, the union of the lines $y = \pm x$; for $f(x, y) = c \neq 0$, hyperbolas centered at $(0, 0)$ with foci on the x -axis if $c > 0$ and on the y -axis if $c < 0$
 (d) no boundary points
 (e) both open and closed
 (f) unbounded
21. (a) Domain: all points in the xy -plane
 (b) Range: all real numbers
 (c) level curves are hyperbolas with the x - and y -axes as asymptotes when $f(x, y) \neq 0$, and the x - and y -axes when $f(x, y) = 0$
 (d) no boundary points
 (e) both open and closed
 (f) unbounded
22. (a) Domain: all $(x, y) \neq (0, y)$
 (b) Range: all real numbers
 (c) level curves: for $f(x, y) = 0$, the x -axis minus the origin; for $f(x, y) = c \neq 0$, the parabolas $y = cx^2$ minus the origin
 (d) boundary is the line $x = 0$
 (e) open
 (f) unbounded

23. (a) Domain: all (x, y) satisfying $x^2 + y^2 < 16$
 (b) Range: $z \geq \frac{1}{4}$
 (c) level curves are circles centered at the origin with radii $r < 4$
 (d) boundary is the circle $x^2 + y^2 = 16$
 (e) open
 (f) bounded
24. (a) Domain: all (x, y) satisfying $x^2 + y^2 \leq 9$
 (b) Range: $0 \leq z \leq 3$
 (c) level curves are circles centered at the origin with radii $r \leq 3$
 (d) boundary is the circle $x^2 + y^2 = 9$
 (e) closed
 (f) bounded
25. (a) Domain: $(x, y) \neq (0, 0)$
 (b) Range: all real numbers
 (c) level curves are circles with center $(0, 0)$ and radii $r > 0$
 (d) boundary is the single point $(0, 0)$
 (e) open
 (f) unbounded
26. (a) Domain: all points in the xy -plane
 (b) Range: $0 < z \leq 1$
 (c) level curves are the origin itself and the circles with center $(0, 0)$ and radii $r > 0$
 (d) no boundary points
 (e) both open and closed
 (f) unbounded
27. (a) Domain: all (x, y) satisfying $-1 \leq y - x \leq 1$
 (b) Range: $-\frac{\pi}{2} \leq z \leq \frac{\pi}{2}$
 (c) level curves are straight lines of the form $y - x = c$ where $-1 \leq c \leq 1$
 (d) boundary is the two straight lines $y = 1 + x$ and $y = -1 + x$
 (e) closed
 (f) unbounded
28. (a) Domain: all $(x, y), x \neq 0$
 (b) Range: $-\frac{\pi}{2} < z < \frac{\pi}{2}$
 (c) level curves are the straight lines of the form $y = cx, c$ any real number and $x \neq 0$
 (d) boundary is the line $x = 0$
 (e) open
 (f) unbounded
29. (a) Domain: all points (x, y) outside the circle $x^2 + y^2 = 1$
 (b) Range: all reals
 (c) Circles centered at the origin with radii $r > 1$
 (d) Boundary: the circle $x^2 + y^2 = 1$
 (e) open
 (f) unbounded

30. (a) Domain: all points (x, y) inside the circle $x^2 + y^2 = 9$
 (b) Range: $z < \ln 9$
 (c) Circles centered at the origin with radii $r < 9$
 (d) Boundary: the circle $x^2 + y^2 = 9$
 (e) open
 (f) bounded

31. f

32. e

33. a

34. c

35. d

36. b

37. (a)

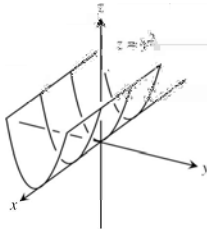

(b)

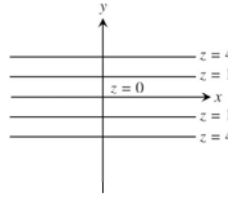

38. (a)

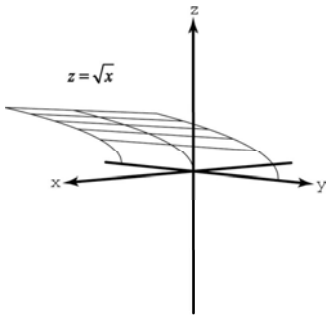

(b)

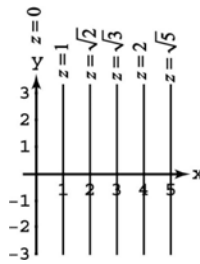

39. (a)

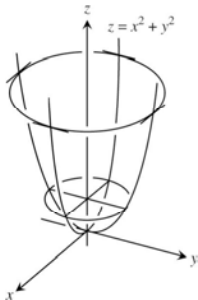

(b)

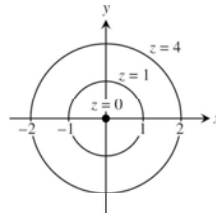

40. (a)

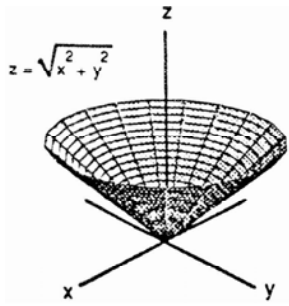

(b)

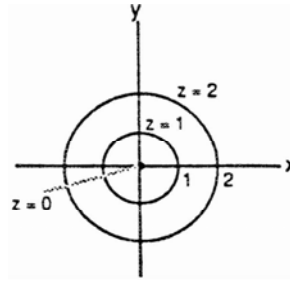

41. (a)

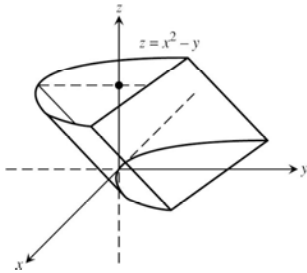

(b)

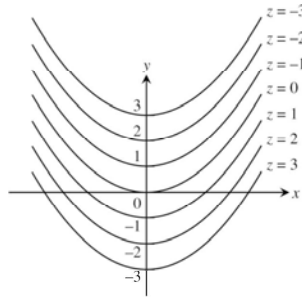

42. (a)

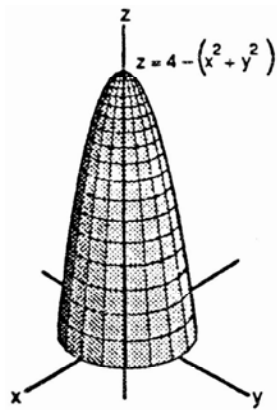

(b)

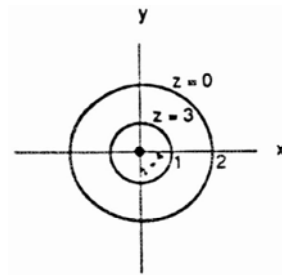

43. (a)

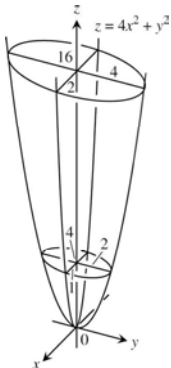

(b)

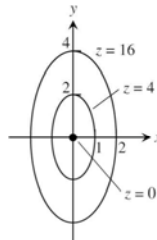

44. (a)

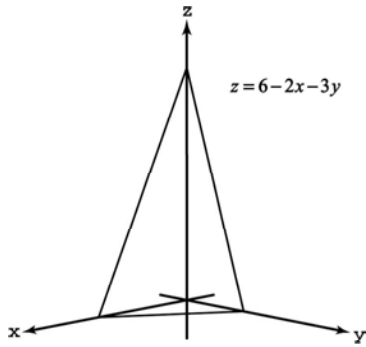

(b)

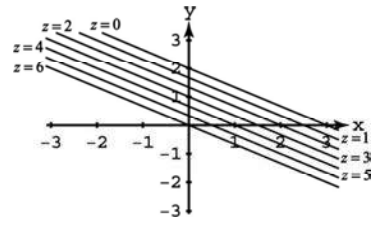

45. (a)

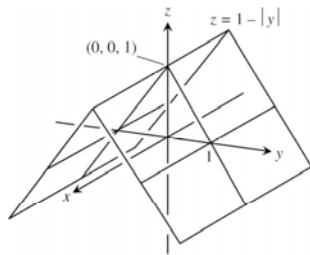

(b)

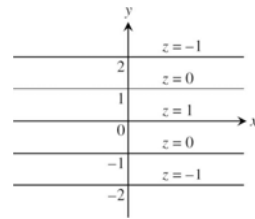

46. (a)

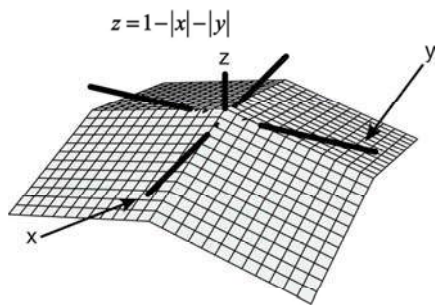

(b)

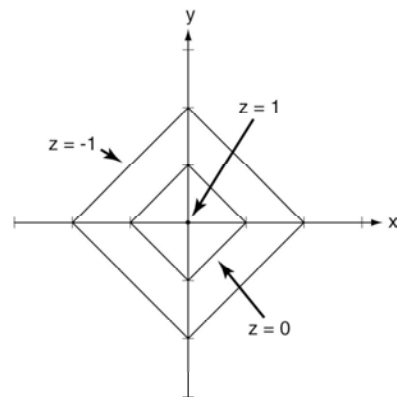

47. (a)

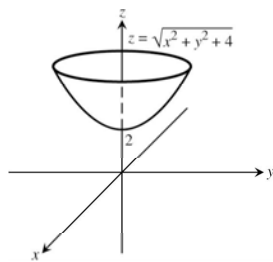

(b)

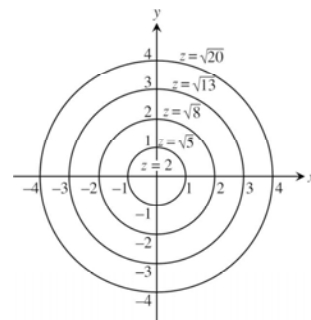

48. (a)

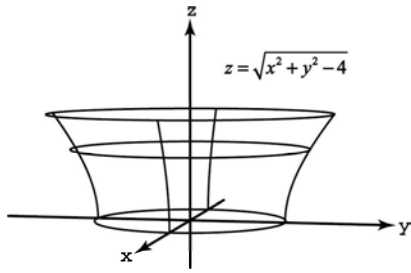

(b)

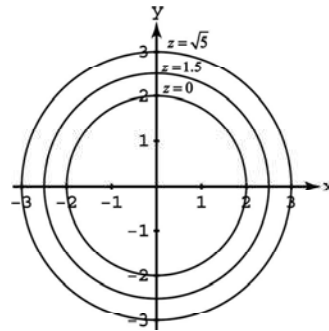

49. $f(x, y) = 16 - x^2 - y^2$ and $(2\sqrt{2}, \sqrt{2}) \Rightarrow z = 16 - (2\sqrt{2})^2 - (\sqrt{2})^2 = 6 \Rightarrow 6 = 16 - x^2 - y^2 \Rightarrow x^2 + y^2 = 10$

50. $f(x, y) = \sqrt{x^2 - 1}$ and $(1, 0) \Rightarrow z = \sqrt{1^2 - 1} = 0 \Rightarrow x^2 - 1 = 0 \Rightarrow x = 1$ or $x = -1$

51. $f(x, y) = \sqrt{x + y^2 - 3}$ and $(3, -1) \Rightarrow z = \sqrt{3 + (-1)^2 - 3} = 1 \Rightarrow x + y^2 - 3 = 1 \Rightarrow x + y^2 = 4$

52. $f(x, y) = \frac{2y-x}{x+y+1}$ and $(-1, 1) \Rightarrow z = \frac{2(1)-(-1)}{(-1)+1+1} = 3 \Rightarrow 3 = \frac{2y-x}{x+y+1} \Rightarrow y = -4x - 3$

53.

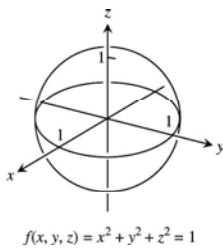

54.

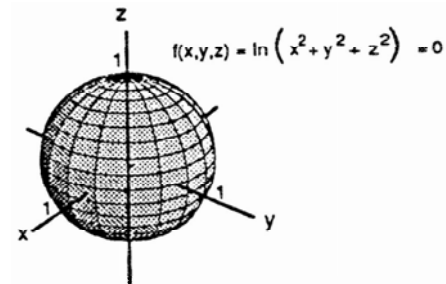

55.

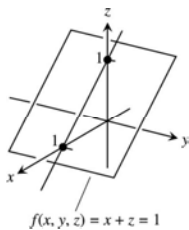

56.

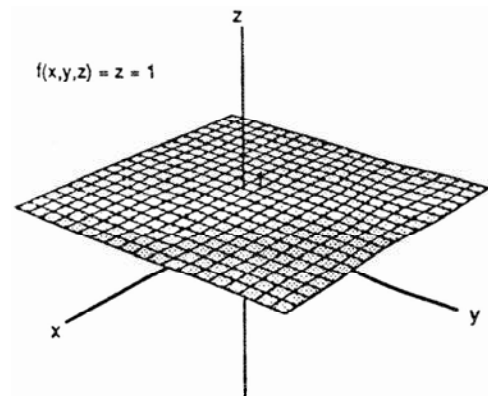

57.

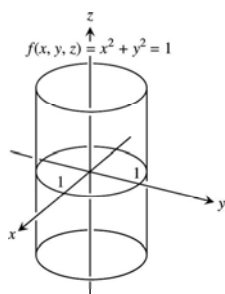

58.

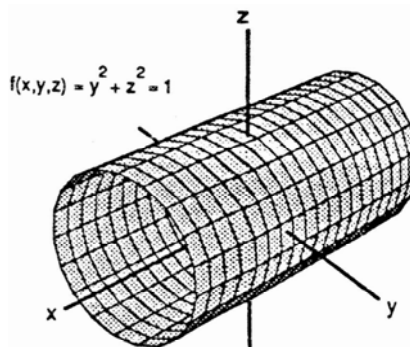

59.

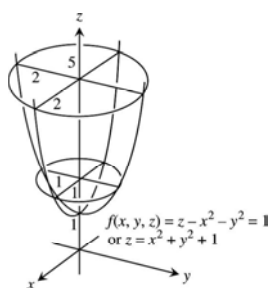

60.

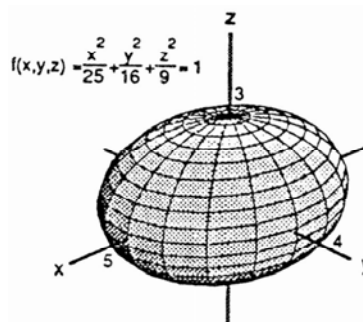

61. $f(x, y, z) = \sqrt{x-y} - \ln z$ at $(3, -1, 1) \Rightarrow w = \sqrt{x-y} - \ln z$; at $(3, -1, 1) \Rightarrow w = \sqrt{3-(-1)} - \ln 1 = 2$
 $\Rightarrow \sqrt{x-y} - \ln z = 2$

62. $f(x, y, z) = \ln(x^2 + y + z^2)$ at $(-1, 2, 1) \Rightarrow w = \ln(x^2 + y + z^2)$; at $(-1, 2, 1) \Rightarrow w = \ln(1 + 2 + 1) = \ln 4$
 $\Rightarrow \ln 4 = \ln(x^2 + y + z^2) \Rightarrow x^2 + y + z^2 = 4$

63. $g(x, y, z) = \sqrt{x^2 + y^2 + z^2}$ at $(1, -1, \sqrt{2}) \Rightarrow w = \sqrt{x^2 + y^2 + z^2}$; at $(1, -1, \sqrt{2}) \Rightarrow w = \sqrt{1^2 + (-1)^2 + (\sqrt{2})^2} = 2$
 $\Rightarrow 2 = \sqrt{x^2 + y^2 + z^2} \Rightarrow x^2 + y^2 + z^2 = 4$

64. $g(x, y, z) = \frac{x-y+z}{2x+y-z}$ at $(1, 0, -2) \Rightarrow w = \frac{x-y+z}{2x+y-z}$; at $(1, 0, -2) \Rightarrow w = \frac{1-0+(-2)}{2(1)+0-(-2)} = -\frac{1}{4} \Rightarrow -\frac{1}{4} = \frac{x-y+z}{2x+y-z}$
 $\Rightarrow 2x - y + z = 0$

65. $f(x, y) = \sum_{n=0}^{\infty} \left(\frac{x}{y}\right)^n = \frac{1}{1-\left(\frac{x}{y}\right)} = \frac{y}{y-x}$ for $\left|\frac{x}{y}\right| < 1$
 \Rightarrow Domain: all points (x, y) satisfying $|x| < |y|$;
 at $(1, 2) \Rightarrow$ since $\left|\frac{1}{2}\right| < 1 \Rightarrow z = \frac{2}{2-1} = 2$
 $\Rightarrow \frac{y}{y-x} = 2 \Rightarrow y = 2x$

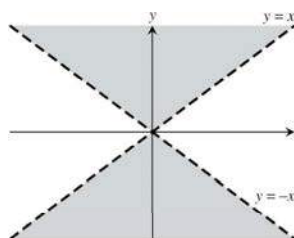

66. $g(x, y, z) = \sum_{n=0}^{\infty} \frac{(x+y)^n}{n!z^n} = e^{(x+y)/z} \Rightarrow$ Domain: all points (x, y, z) satisfying $z \neq 0$;
 at $(\ln 4, \ln 9, 2) \Rightarrow w = e^{(\ln 4 + \ln 9)/2} = e^{(\ln 36)/2} = e^{\ln 6} = 6 \Rightarrow 6 = e^{(x+y)/z} \Rightarrow \frac{x+y}{z} = \ln 6$

67. $f(x, y) = \int_x^y \frac{d\theta}{\sqrt{1-\theta^2}} = \sin^{-1} y - \sin^{-1} x$
 \Rightarrow Domain: all points (x, y) satisfying $-1 \leq x \leq 1$ and $-1 \leq y \leq 1$;
 at $(0, 1) \Rightarrow \sin^{-1} 1 - \sin^{-1} 0 = \frac{\pi}{2} \Rightarrow \sin^{-1} y - \sin^{-1} x = \frac{\pi}{2}$.
 Since $-\frac{\pi}{2} \leq \sin^{-1} y \leq \frac{\pi}{2}$ and $-\frac{\pi}{2} \leq \sin^{-1} x \leq \frac{\pi}{2}$, in order for $\sin^{-1} y - \sin^{-1} x$ to equal $\frac{\pi}{2}$, $0 \leq \sin^{-1} y \leq \frac{\pi}{2}$ and $-\frac{\pi}{2} \leq \sin^{-1} x \leq 0$; that is $0 \leq y \leq 1$ and $-1 \leq x \leq 0$. Thus
 $y = \sin\left(\frac{\pi}{2} + \sin^{-1} x\right) = \sqrt{1-x^2}, x \leq 0$

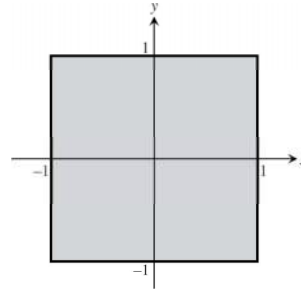

68. $g(x, y, z) = \int_x^y \frac{dt}{1+t^2} + \int_0^z \frac{d\theta}{\sqrt{4-\theta^2}} = \tan^{-1} y - \tan^{-1} x + \sin^{-1}\left(\frac{z}{2}\right) \Rightarrow$ Domain: all points (x, y, z) satisfying $-2 \leq z \leq 2$; at $(0, 1, \sqrt{3}) \Rightarrow \tan^{-1} 1 - \tan^{-1} 0 + \sin^{-1}\left(\frac{\sqrt{3}}{2}\right) = \frac{7\pi}{12} \Rightarrow \tan^{-1} y - \tan^{-1} x + \sin^{-1}\left(\frac{z}{2}\right) = \frac{7\pi}{12}$. Since $-\frac{\pi}{2} \leq \sin^{-1}\left(\frac{z}{2}\right) \leq \frac{\pi}{2}$, $\frac{\pi}{12} \leq \tan^{-1} y - \tan^{-1} x \leq \frac{13\pi}{12} \Rightarrow z = 2 \sin\left(\frac{7\pi}{12} - \tan^{-1} y + \tan^{-1} x\right)$,
 $\frac{\pi}{12} \leq \tan^{-1} y - \tan^{-1} x \leq \frac{13\pi}{12}$

69-72. Example CAS commands:

Maple:

```
with(plots);
f:=(x,y)->x*sin(y/2)+y*sin(2*x);
xdomain:=x=0..5*Pi;
ydomain:=y=0..5*Pi;
x0,y0:=3*Pi,3*Pi;
plot3d(f(x,y), xdomain, ydomain, axes=boxed, style=patch, shading=zhue, title="#69(a) (Section 14.1)");
plot3d(f(x,y), xdomain, ydomain, grid=[50,50], axes=boxed, shading=zhue, style=patchcontour,
orientation=[-90,0], title="#69(b) (Section 14.1)"); # (b)
L:=evalf(f(x0,y0)); # (c)
plot3d(f(x,y), xdomain, ydomain, grid=[50,50], axes=boxed, shading=zhue, style=patchcontour,
contours=[L], orientation=[-90,0], title="#69(c) (Section 14.1)");
```

73-76. Example CAS commands:

Maple:

```
eq:=4*ln(x^2+y^2+z^2)=1;
```

```
implicitplot3d(eq, x=-2..2, y=-2..2, z=-2..2, grid=[30,30,30], axes=boxed, title="#73 (Section 14.1)");
```

77-80. Example CAS commands:

Maple:

```
x:= (u,v) -> u*cos(v);
y:= (u,v) -> u*sin(v);
z:= (u,v) -> u;
plot3d( [x(u,v),y(u,v),z(u,v)],u=0..2, v=0..2*Pi, axes=boxed, style=patchcontour, contours=[($0..4)/2],
        shading=zhue, title="#77(Section 14.1)");
```

69-80. Example CAS commands:

Mathematica: (assigned functions and bounds will vary)

For 69 - 72, the command **ContourPlot** draws 2-dimensional contours that are z-level curves of surfaces $z = f(x,y)$.

```
Clear[x, y, f]
f[x_,y_]:= x Sin[y/2] + y Sin[2x]
xmin=0; xmax= 5π; ymin=0; ymax= 5π; {x0, y0}={3π, 3π};
cp= ContourPlot[f[x,y], {x, xmin, xmax}, {y, ymin, ymax}, ContourShading -> False];
cp0= ContourPlot[{f[x,y], {x, xmin, xmax}, {y, ymin, ymax}, Contours -> [f[x0,y0]},
                ContourShading -> False, PlotStyle -> {RGBColor[1,0,0]}];
Show[cp, cp0]
```

For 73 - 76, the command **ContourPlot3D** will be used. Write the function $f[x, y, z]$ so that when it is equated to zero, it represents the level surface given.

For 73, the problem associated with $\text{Log}[0]$ can be avoided by rewriting the function as $x^2 + y^2 + z^2 - e^{1/4}$

```
Clear[x, y, z, f]
f[x_,y_,z_]:= x2 + y2 + z2 - Exp[1/4]
ContourPlot3D[f[x, y, z], {x, -5, 5}, {y, -5, 5}, {z, -5, 5}, PlotPoints -> (7, 7)];
```

For 77 - 80, the command **ParametricPlot3D** will be used. To get the z-level curves here, we solve x and y in terms of z and either u or v (v here), create a table of level curves, then plot that table.

```
Clear[x, y, z, u, v]
ParametricPlot3D[{u Cos[v], u Sin[v], u}, {u, 0, 2}, {v, 0, 2Pi}];
zlevel=Table[{z Cos[v], z Sin[v]}, {z, 0, 2, .1}];
ParametricPlot[Evaluate[zlevel], {v, 0, 2π}];
```

14.2 LIMITS AND CONTINUITY IN HIGHER DIMENSIONS

1.
$$\lim_{(x,y) \rightarrow (0,0)} \frac{3x^2 - y^2 + 5}{x^2 + y^2 + 2} = \frac{3(0)^2 - 0^2 + 5}{0^2 + 0^2 + 2} = \frac{5}{2}$$
2.
$$\lim_{(x,y) \rightarrow (0,4)} \frac{x}{\sqrt{y}} = \frac{0}{\sqrt{4}} = 0$$
3.
$$\lim_{(x,y) \rightarrow (3,4)} \sqrt{x^2 + y^2 - 1} = \sqrt{3^2 + 4^2 - 1} = \sqrt{24} = 2\sqrt{6}$$
4.
$$\lim_{(x,y) \rightarrow (2,-3)} \left(\frac{1}{x} + \frac{1}{y} \right)^2 = \left(\frac{1}{2} + \left(\frac{1}{-3} \right) \right)^2 = \left(\frac{1}{6} \right)^2 = \frac{1}{36}$$
5.
$$\lim_{(x,y) \rightarrow (0, \frac{\pi}{4})} \sec x \tan y = (\sec 0) \left(\tan \frac{\pi}{4} \right) = (1)(1) = 1$$
6.
$$\lim_{(x,y) \rightarrow (0,0)} \cos \left(\frac{x^2 + y^3}{x + y + 1} \right) = \cos \left(\frac{0^2 + 0^3}{0 + 0 + 1} \right) = \cos 0 = 1$$
7.
$$\lim_{(x,y) \rightarrow (0, \ln 2)} e^{x-y} = e^{0 - \ln 2} = e^{\ln(\frac{1}{2})} = \frac{1}{2}$$
8.
$$\lim_{(x,y) \rightarrow (1,1)} \ln |1 + x^2 y^2| = \ln |1 + (1)^2 (1)^2| = \ln 2$$
9.
$$\lim_{(x,y) \rightarrow (0,0)} \frac{e^y \sin x}{x} = \lim_{(x,y) \rightarrow (0,0)} (e^y) \left(\frac{\sin x}{x} \right) = e^0 \cdot \lim_{x \rightarrow 0} \left(\frac{\sin x}{x} \right) = 1 \cdot 1 = 1$$
10.
$$\lim_{(x,y) \rightarrow (1/27, \pi^3)} \cos \sqrt[3]{xy} = \cos \sqrt[3]{\left(\frac{1}{27} \right) \pi^3} = \cos \left(\frac{\pi}{3} \right) = \frac{1}{2}$$
11.
$$\lim_{(x,y) \rightarrow (1, \pi/6)} \frac{x \sin y}{x^2 + 1} = \frac{1 \cdot \sin(\frac{\pi}{6})}{1^2 + 1} = \frac{1/2}{2} = \frac{1}{4}$$
12.
$$\lim_{(x,y) \rightarrow (\frac{\pi}{2}, 0)} \frac{\cos y + 1}{y - \sin x} = \frac{(\cos 0) + 1}{0 - \sin(\frac{\pi}{2})} = \frac{1 + 1}{-1} = -2$$
13.
$$\lim_{\substack{(x,y) \rightarrow (1,1) \\ x \neq y}} \frac{x^2 - 2xy + y^2}{x - y} = \lim_{(x,y) \rightarrow (1,1)} \frac{(x-y)^2}{x-y} = \lim_{(x,y) \rightarrow (1,1)} (x-y) = (1-1) = 0$$
14.
$$\lim_{\substack{(x,y) \rightarrow (1,1) \\ x \neq y}} \frac{x^2 - y^2}{x - y} = \lim_{(x,y) \rightarrow (1,1)} \frac{(x+y)(x-y)}{x-y} = \lim_{(x,y) \rightarrow (1,1)} (x+y) = (1+1) = 2$$

$$15. \lim_{\substack{(x,y) \rightarrow (1,1) \\ x \neq 1}} \frac{xy - y - 2x + 2}{x-1} = \lim_{\substack{(x,y) \rightarrow (1,1) \\ x \neq 1}} \frac{(x-1)(y-2)}{x-1} = \lim_{(x,y) \rightarrow (1,1)} (y-2) = (1-2) = -1$$

$$16. \lim_{\substack{(x,y) \rightarrow (2,-4) \\ y \neq -4, x \neq x^2}} \frac{y+4}{x^2 y - xy + 4x^2 - 4x} = \lim_{\substack{(x,y) \rightarrow (2,-4) \\ y \neq -4, x \neq x^2}} \frac{y+4}{x(x-1)(y+4)} = \lim_{\substack{(x,y) \rightarrow (2,-4) \\ x \neq x^2}} \frac{1}{x(x-1)} = \frac{1}{2(2-1)} = \frac{1}{2}$$

$$17. \lim_{\substack{(x,y) \rightarrow (0,0) \\ x \neq y}} \frac{x-y+2\sqrt{x}-2\sqrt{y}}{\sqrt{x}-\sqrt{y}} = \lim_{\substack{(x,y) \rightarrow (0,0) \\ x \neq y}} \frac{(\sqrt{x}-\sqrt{y})(\sqrt{x}+\sqrt{y}+2)}{\sqrt{x}-\sqrt{y}} = \lim_{(x,y) \rightarrow (0,0)} (\sqrt{x}+\sqrt{y}+2) = (\sqrt{0}+\sqrt{0}+2) = 2$$

Note: (x, y) must approach $(0, 0)$ through the first quadrant only with $x \neq y$.

$$18. \lim_{\substack{(x,y) \rightarrow (2,2) \\ x+y \neq 4}} \frac{x+y-4}{\sqrt{x+y}-2} = \lim_{\substack{(x,y) \rightarrow (2,2) \\ x+y \neq 4}} \frac{(\sqrt{x+y}+2)(\sqrt{x+y}-2)}{\sqrt{x+y}-2} = \lim_{\substack{(x,y) \rightarrow (2,2) \\ x+y \neq 4}} (\sqrt{x+y}+2) = (\sqrt{2+2}+2) = 2+2 = 4$$

$$19. \lim_{\substack{(x,y) \rightarrow (2,0) \\ 2x-y \neq 4}} \frac{\sqrt{2x-y}-2}{2x-y-4} = \lim_{\substack{(x,y) \rightarrow (2,0) \\ 2x-y \neq 4}} \frac{\sqrt{2x-y}-2}{(\sqrt{2x-y}+2)(\sqrt{2x-y}-2)} = \lim_{(x,y) \rightarrow (2,0)} \frac{1}{\sqrt{2x-y}+2} = \frac{1}{\sqrt{(2)(2)-0}+2} = \frac{1}{4} = \frac{1}{4}$$

$$20. \lim_{\substack{(x,y) \rightarrow (4,3) \\ x-y \neq 1}} \frac{\sqrt{x}-\sqrt{y+1}}{x-y-1} = \lim_{\substack{(x,y) \rightarrow (4,3) \\ x-y \neq 1}} \frac{\sqrt{x}-\sqrt{y+1}}{(\sqrt{x}+\sqrt{y+1})(\sqrt{x}-\sqrt{y+1})} = \lim_{(x,y) \rightarrow (4,3)} \frac{1}{\sqrt{x}+\sqrt{y+1}} = \frac{1}{\sqrt{4}+\sqrt{3+4}} = \frac{1}{4+\sqrt{7}}$$

$$21. \lim_{(x,y) \rightarrow (0,0)} \frac{\sin(x^2+y^2)}{x^2+y^2} = \lim_{r \rightarrow 0} \frac{\sin(r^2)}{r^2} = \lim_{r \rightarrow 0} \frac{2r \cdot \cos(r^2)}{2r} = \lim_{r \rightarrow 0} \cos(r^2) = 1$$

$$22. \lim_{(x,y) \rightarrow (0,0)} \frac{1-\cos(xy)}{xy} = \lim_{u \rightarrow 0} \frac{1-\cos u}{u} = \lim_{u \rightarrow 0} \frac{\sin u}{1} = 0$$

$$23. \lim_{(x,y) \rightarrow (1,-1)} \frac{x^3+y^3}{x+y} = \lim_{(x,y) \rightarrow (1,-1)} \frac{(x+y)(x^2-xy+y^2)}{x+y} = \lim_{(x,y) \rightarrow (1,-1)} (x^2-xy+y^2) = (1^2 - (1)(-1) + (-1)^2) = 3$$

$$24. \lim_{(x,y) \rightarrow (2,2)} \frac{x-y}{x^4-y^4} = \lim_{(x,y) \rightarrow (2,2)} \frac{x-y}{(x+y)(x-y)(x^2+y^2)} = \lim_{(x,y) \rightarrow (2,2)} \frac{1}{(x+y)(x^2+y^2)} = \frac{1}{(2+2)(2^2+2^2)} = \frac{1}{32}$$

$$25. \lim_{P \rightarrow (1,3,4)} \left(\frac{1}{x} + \frac{1}{y} + \frac{1}{z} \right) = \frac{1}{1} + \frac{1}{3} + \frac{1}{4} = \frac{12+4+3}{12} = \frac{19}{12}$$

$$26. \lim_{P \rightarrow (1,-1,-1)} \frac{2xy+yz}{x^2+z^2} = \frac{2(1)(-1)+(-1)(-1)}{1^2+(-1)^2} = \frac{-2+1}{1+1} = -\frac{1}{2}$$

$$27. \lim_{P \rightarrow (3,3,0)} (\sin^2 x + \cos^2 y + \sec^2 z) = (\sin^2 3 + \cos^2 3 + \sec^2 0) = 1 + 1^2 = 2$$

$$28. \lim_{P \rightarrow \left(-\frac{1}{4}, \frac{\pi}{2}, 2\right)} \tan^{-1}(xyz) = \tan^{-1}\left(-\frac{1}{4} \cdot \frac{\pi}{2} \cdot 2\right) = \tan^{-1}\left(-\frac{\pi}{4}\right)$$

29. $\lim_{P \rightarrow (\pi, 0, 3)} ze^{-2y} \cos 2x = 3e^{-2(0)} \cos 2\pi = (3)(1)(1) = 3$
30. $\lim_{P \rightarrow (2, -3, 6)} \ln \sqrt{x^2 + y^2 + z^2} = \ln \sqrt{2^2 + (-3)^2 + 6^2} = \ln \sqrt{49} = \ln 7$
31. (a) All (x, y) (b) All (x, y) except $(0, 0)$
32. (a) All (x, y) so that $x \neq y$ (b) All (x, y)
33. (a) All (x, y) except where $x = 0$ or $y = 0$ (b) All (x, y)
34. (a) All (x, y) so that $x^2 - 3x + 2 \neq 0 \Rightarrow (x - 2)(x - 1) \neq 0 \Rightarrow x \neq 2$ and $x \neq 1$
 (b) All (x, y) so that $y \neq x^2$
35. (a) All (x, y, z) (b) All (x, y, z) except the interior of the cylinder $x^2 + y^2 = 1$
36. (a) All (x, y, z) so that $xyz > 0$ (b) All (x, y, z)
37. (a) All (x, y, z) with $z \neq 0$ (b) All (x, y, z) with $x^2 + z^2 \neq 1$
38. (a) All (x, y, z) except $(x, 0, 0)$ (b) All (x, y, z) except $(0, y, 0)$ or $(x, 0, 0)$
39. (a) All (x, y, z) such that $z > x^2 + y^2 + 1$ (b) All (x, y, z) such that $z \neq \sqrt{x^2 + y^2}$
40. (a) All (x, y, z) such that $x^2 + y^2 + z^2 \leq 4$ (b) All (x, y, z) such that $x^2 + y^2 + z^2 \geq 9$ except when $x^2 + y^2 + z^2 = 25$
41. $\lim_{\substack{(x, y) \rightarrow (0, 0) \\ \text{along } y=x \\ x > 0}} -\frac{x}{\sqrt{x^2 + y^2}} = \lim_{x \rightarrow 0^+} -\frac{x}{\sqrt{x^2 + x^2}} = \lim_{x \rightarrow 0^+} -\frac{x}{\sqrt{2}|x|} = \lim_{x \rightarrow 0^+} -\frac{x}{\sqrt{2}x} = \lim_{x \rightarrow 0^+} -\frac{1}{\sqrt{2}} = -\frac{1}{\sqrt{2}};$
 $\lim_{\substack{(x, y) \rightarrow (0, 0) \\ \text{along } y=x \\ x < 0}} -\frac{x}{\sqrt{x^2 + y^2}} = \lim_{x \rightarrow 0^-} -\frac{x}{\sqrt{2}|x|} = \lim_{x \rightarrow 0^-} -\frac{x}{\sqrt{2}(-x)} = \lim_{x \rightarrow 0^-} \frac{1}{\sqrt{2}} = \frac{1}{\sqrt{2}}$
42. $\lim_{\substack{(x, y) \rightarrow (0, 0) \\ \text{along } y=0}} \frac{x^4}{x^4 + y^2} = \lim_{x \rightarrow 0} \frac{x^4}{x^4 + 0^2} = 1;$ $\lim_{\substack{(x, y) \rightarrow (0, 0) \\ \text{along } y=x^2}} \frac{x^4}{x^4 + y^2} = \lim_{x \rightarrow 0} \frac{x^4}{x^4 + (x^2)^2} = \lim_{x \rightarrow 0} \frac{x^4}{2x^4} = \frac{1}{2}$
43. $\lim_{\substack{(x, y) \rightarrow (0, 0) \\ \text{along } y=kx^2}} \frac{x^4 - y^2}{x^4 + y^2} = \lim_{x \rightarrow 0} \frac{x^4 - (kx^2)^2}{x^4 + (kx^2)^2} = \lim_{x \rightarrow 0} \frac{x^4 - k^2x^4}{x^4 + k^2x^4} = \frac{1 - k^2}{1 + k^2} \Rightarrow$ different limits for different values of k

44. $\lim_{\substack{(x,y) \rightarrow (0,0) \\ \text{along } y=kx \\ k \neq 0}} \frac{xy}{|xy|} = \lim_{x \rightarrow 0} \frac{x(kx)}{|x(kx)|} = \lim_{x \rightarrow 0} \frac{kx^2}{|kx^2|} = \lim_{x \rightarrow 0} \frac{k}{|k|}$; if $k > 0$, the limit is 1; but if $k < 0$, the limit is -1

45. $\lim_{\substack{(x,y) \rightarrow (0,0) \\ \text{along } y=kx \\ k \neq -1}} \frac{x-y}{x+y} = \lim_{x \rightarrow 0} \frac{x-kx}{x+kx} = \frac{1-k}{1+k} \Rightarrow$ different limits for different values of $k, k \neq -1$

46. $\lim_{\substack{(x,y) \rightarrow (0,0) \\ \text{along } y=kx \\ k \neq 1}} \frac{x^2-y}{x-y} = \lim_{x \rightarrow 0} \frac{x^2-kx}{x-kx} = \lim_{x \rightarrow 0} \frac{x-k}{1-k} = \frac{-k}{1-k} \Rightarrow$ different limits for different values of $k, k \neq 1$

47. $\lim_{\substack{(x,y) \rightarrow (0,0) \\ \text{along } y=kx^2 \\ k \neq 0}} \frac{x^2+y}{y} = \lim_{x \rightarrow 0} \frac{x^2+kx^2}{kx^2} = \frac{1+k}{k} \Rightarrow$ different limits for different values of $k, k \neq 0$

48. $\lim_{\substack{(x,y) \rightarrow (0,0) \\ \text{along } y=kx^2}} \frac{x^2y}{x^4+y^2} = \lim_{x \rightarrow 0} \frac{kx^4}{x^4+k^2x^4} = \frac{k}{1+k^2} \Rightarrow$ different limits for different values of k

49. $\lim_{\substack{(x,y) \rightarrow (1,1) \\ \text{along } x=1}} \frac{xy^2-1}{y-1} = \lim_{y \rightarrow 1} \frac{y^2-1}{y-1} = \lim_{y \rightarrow 1} (y+1) = 2$; $\lim_{\substack{(x,y) \rightarrow (1,1) \\ \text{along } y=x}} \frac{xy^2-1}{y-1} = \lim_{y \rightarrow 1} \frac{y^3-1}{y-1} = \lim_{y \rightarrow 1} (y^2+y+1) = 3$

50. $\lim_{\substack{(x,y) \rightarrow (1,-1) \\ \text{along } y=-1}} \frac{xy+1}{x^2-y^2} = \lim_{x \rightarrow 1} \frac{-x+1}{x^2-1} = \lim_{x \rightarrow 1} \frac{-1}{x+1} = -\frac{1}{2}$ $\lim_{\substack{(x,y) \rightarrow (1,-1) \\ \text{along } y=-x^2}} \frac{xy+1}{x^2-y^2} = \lim_{x \rightarrow 1} \frac{-x^3+1}{x^2-x^4} = \lim_{x \rightarrow 1} \frac{x^2+x+1}{(x+1)(x^2+1)} = \frac{3}{2}$

51. $f(x,y) = \begin{cases} 1 & \text{if } y \geq x^4 \\ 1 & \text{if } y \leq 0 \\ 0 & \text{otherwise} \end{cases}$

(a) $\lim_{(x,y) \rightarrow (0,1)} f(x,y) = 1$ since any path through $(0,1)$ that is close to $(0,1)$ satisfies $y \geq x^4$

(b) $\lim_{(x,y) \rightarrow (2,3)} f(x,y) = 0$ since any path through $(2,3)$ that is close to $(2,3)$ does not satisfy either $y \geq x^4$ or $y \leq 0$

(c) $\lim_{\substack{(x,y) \rightarrow (0,0) \\ \text{along } x=0}} f(x,y) = 1$ and $\lim_{\substack{(x,y) \rightarrow (0,0) \\ \text{along } y=x^2}} f(x,y) = 0 \Rightarrow \lim_{(x,y) \rightarrow (0,0)} f(x,y)$ does not exist

52. $f(x,y) = \begin{cases} x^2 & \text{if } x \geq 0 \\ x^3 & \text{if } x < 0 \end{cases}$

(a) $\lim_{(x,y) \rightarrow (3,-2)} f(x,y) = 3^2 = 9$ since any path through $(3,-2)$ that is close to $(3,-2)$ satisfies $x \geq 0$

(b) $\lim_{(x,y) \rightarrow (-2,1)} f(x,y) = (-2)^3 = -8$ since any path through $(-2,1)$ that is close to $(-2,1)$ satisfies $x < 0$

(c) $\lim_{(x,y) \rightarrow (0,0)} f(x,y) = 0$ since the limit is 0 along any path through $(0,0)$ with $x < 0$ and the limit is also zero along any path through $(0,0)$ with $x \geq 0$

53. First consider the vertical line $x = 0 \Rightarrow \lim_{\substack{(x,y) \rightarrow (0,0) \\ \text{along } x=0}} \frac{2x^2y}{x^4+y^2} = \lim_{y \rightarrow 0} \frac{2(0)^2y}{(0)^4+y^2} = \lim_{y \rightarrow 0} 0 = 0$. Now consider any

nonvertical line through $(0,0)$. The equation of any line through $(0,0)$ is of the form $y = mx$

$$\Rightarrow \lim_{\substack{(x,y) \rightarrow (0,0) \\ \text{along } y=mx}} f(x,y) = \lim_{\substack{(x,y) \rightarrow (0,0) \\ \text{along } y=mx}} \frac{2x^2y}{x^4+y^2} = \lim_{x \rightarrow 0} \frac{2x^2(mx)}{x^4+(mx)^2} = \lim_{x \rightarrow 0} \frac{2mx^3}{x^4+m^2x^2} = \lim_{x \rightarrow 0} \frac{2mx^3}{x^2(x^2+m^2)} = \lim_{x \rightarrow 0} \frac{2mx}{x^2+m^2} = 0.$$

Thus $\lim_{\substack{(x,y) \rightarrow (0,0) \\ \text{any line through } (0,0)}} \frac{2x^2y}{x^4+y^2} = 0$.

54. If f is continuous at (x_0, y_0) , then $\lim_{(x,y) \rightarrow (x_0,y_0)} f(x,y)$ must equal $f(x_0, y_0) = 3$. If f is not continuous at (x_0, y_0) , the limit could have any value different from 3, and need not even exist.

55. $\lim_{(x,y) \rightarrow (0,0)} \left(1 - \frac{x^2y^2}{3}\right) = 1$ and $\lim_{(x,y) \rightarrow (0,0)} 1 = 1 \Rightarrow \lim_{(x,y) \rightarrow (0,0)} \frac{\tan^{-1}xy}{xy} = 1$ by the Sandwich Theorem

56. If $xy > 0$, $\lim_{(x,y) \rightarrow (0,0)} \frac{2|xy| - \left(\frac{x^2y^2}{6}\right)}{|xy|} = \lim_{(x,y) \rightarrow (0,0)} \frac{2xy - \left(\frac{x^2y^2}{6}\right)}{xy} = \lim_{(x,y) \rightarrow (0,0)} \left(2 - \frac{xy}{6}\right) = 2$ and $\lim_{(x,y) \rightarrow (0,0)} \frac{2|xy|}{|xy|} = 2$; if $xy < 0$, $\lim_{(x,y) \rightarrow (0,0)} \frac{2|xy| - \left(\frac{x^2y^2}{6}\right)}{|xy|} = \lim_{(x,y) \rightarrow (0,0)} \frac{-2xy - \left(\frac{x^2y^2}{6}\right)}{-xy} = \lim_{(x,y) \rightarrow (0,0)} \left(2 + \frac{xy}{6}\right) = 2$ and $\lim_{(x,y) \rightarrow (0,0)} \frac{2|xy|}{|xy|} = 2 \Rightarrow \lim_{(x,y) \rightarrow (0,0)} \frac{4 - 4\cos\sqrt{|xy|}}{|xy|} = 2$, by the Sandwich Theorem

57. The limit is 0 since $\left|\sin\left(\frac{1}{x}\right)\right| \leq 1 \Rightarrow -1 \leq \sin\left(\frac{1}{x}\right) \leq 1 \Rightarrow -y \leq y \sin\left(\frac{1}{x}\right) \leq y$ for $y \geq 0$, and $-y \geq y \sin\left(\frac{1}{x}\right) \geq y$ for $y \leq 0$. Thus as $(x,y) \rightarrow (0,0)$, both $-y$ and y approach 0 $\Rightarrow y \sin\left(\frac{1}{x}\right) \rightarrow 0$, by the Sandwich Theorem.

58. The limit is 0 since $\left|\cos\left(\frac{1}{y}\right)\right| \leq 1 \Rightarrow -1 \leq \cos\left(\frac{1}{y}\right) \leq 1 \Rightarrow -x \leq x \cos\left(\frac{1}{y}\right) \leq x$ and $-x \geq x \cos\left(\frac{1}{y}\right) \geq x$ for $x \leq 0$. Thus as $(x,y) \rightarrow (0,0)$, both $-x$ and x approach 0 $\Rightarrow x \cos\left(\frac{1}{y}\right) \rightarrow 0$, by the Sandwich Theorem.

59. (a) $f(x,y)|_{y=mx} = \frac{2m}{1+m^2} = \frac{2 \tan \theta}{1+\tan^2 \theta} = \sin 2\theta$. The value of $f(x,y) = \sin 2\theta$ varies with θ , which is the line's angle of inclination.

(b) Since $f(x,y)|_{y=mx} = \sin 2\theta$ and since $-1 \leq \sin 2\theta \leq 1$ for every θ , $\lim_{(x,y) \rightarrow (0,0)} f(x,y)$ varies from -1 to 1 along $y = mx$.

60. $\left|xy(x^2 - y^2)\right| = |xy||x^2 - y^2| \leq |x||y||x^2 + y^2| = \sqrt{x^2}\sqrt{y^2}|x^2 + y^2| \leq \sqrt{x^2 + y^2}\sqrt{x^2 + y^2}|x^2 + y^2|$
 $= (x^2 + y^2)^2 \Rightarrow \left|\frac{xy(x^2 - y^2)}{x^2 + y^2}\right| \leq \frac{(x^2 + y^2)^2}{x^2 + y^2} = x^2 + y^2 \Rightarrow -(x^2 + y^2) \leq \frac{xy(x^2 - y^2)}{x^2 + y^2} \leq (x^2 + y^2)$
 $\Rightarrow \lim_{(x,y) \rightarrow (0,0)} \left(\frac{xy(x^2 - y^2)}{x^2 + y^2}\right) = 0$ by the Sandwich Theorem, since $\lim_{(x,y) \rightarrow (0,0)} \pm(x^2 + y^2) = 0$; thus, define $f(0,0) = 0$

61.
$$\lim_{(x,y) \rightarrow (0,0)} \frac{x^3 - xy^2}{x^2 + y^2} = \lim_{r \rightarrow 0} \frac{r^3 \cos^3 \theta - (r \cos \theta)(r^2 \sin^2 \theta)}{r^2} = \lim_{r \rightarrow 0} \frac{r(\cos^3 \theta - \cos \theta \sin^2 \theta)}{1} = 0$$

62.
$$\lim_{(x,y) \rightarrow (0,0)} \cos\left(\frac{x^3 - y^3}{x^2 + y^2}\right) = \lim_{r \rightarrow 0} \cos\left(\frac{r^3 \cos^3 \theta - r^3 \sin^3 \theta}{r^2}\right) = \lim_{r \rightarrow 0} \cos\left(\frac{r(\cos^3 \theta - \sin^3 \theta)}{1}\right) = \cos 0 = 1$$

63.
$$\lim_{(x,y) \rightarrow (0,0)} \frac{y^2}{x^2 + y^2} = \lim_{r \rightarrow 0} \frac{r^2 \sin^2 \theta}{r^2} = \lim_{r \rightarrow 0} (\sin^2 \theta) = \sin^2 \theta$$
; the limit does not exist since $\sin^2 \theta$ is between 0 and 1 depending on θ

64.
$$\lim_{(x,y) \rightarrow (0,0)} \frac{2x}{x^2 + xy^2} = \lim_{r \rightarrow 0} \frac{2r \cos \theta}{r^2 + r \cos \theta} = \lim_{r \rightarrow 0} \frac{2 \cos \theta}{r + \cos \theta} = \frac{2 \cos \theta}{\cos \theta}$$
; the limit does not exist for $\cos \theta = 0$

65.
$$\lim_{(x,y) \rightarrow (0,0)} \tan^{-1} \left[\frac{|x| + |y|}{x^2 + y^2} \right] = \lim_{r \rightarrow 0} \tan^{-1} \left[\frac{|r \cos \theta| + |r \sin \theta|}{r^2} \right] = \lim_{r \rightarrow 0} \tan^{-1} \left[\frac{|r|(|\cos \theta| + |\sin \theta|)}{r^2} \right]$$
; if $r \rightarrow 0^+$, then
$$\lim_{r \rightarrow 0^+} \tan^{-1} \left[\frac{|r|(|\cos \theta| + |\sin \theta|)}{r^2} \right] = \lim_{r \rightarrow 0^+} \tan^{-1} \left[\frac{|\cos \theta| + |\sin \theta|}{r} \right] = \frac{\pi}{2}$$
; if $r \rightarrow 0^-$, then
$$\lim_{r \rightarrow 0^-} \tan^{-1} \left[\frac{|r|(|\cos \theta| + |\sin \theta|)}{r^2} \right] = \lim_{r \rightarrow 0^-} \tan^{-1} \left[\frac{|\cos \theta| + |\sin \theta|}{-r} \right] = \frac{\pi}{2} \Rightarrow \text{the limit is } \frac{\pi}{2}$$

66.
$$\lim_{(x,y) \rightarrow (0,0)} \frac{x^2 - y^2}{x^2 + y^2} = \lim_{r \rightarrow 0} \frac{r^2 \cos^2 \theta - r^2 \sin^2 \theta}{r^2} = \lim_{r \rightarrow 0} (\cos^2 \theta - \sin^2 \theta) = \lim_{r \rightarrow 0} (\cos 2\theta)$$
 which ranges between -1 and 1 depending on $\theta \Rightarrow$ the limit does not exist

67.
$$\lim_{(x,y) \rightarrow (0,0)} \ln\left(\frac{3x^2 - x^2 y^2 + 3y^2}{x^2 + y^2}\right) = \lim_{r \rightarrow 0} \ln\left(\frac{3r^2 \cos^2 \theta - r^4 \cos^2 \theta \sin^2 \theta + 3r^2 \sin^2 \theta}{r^2}\right) = \lim_{r \rightarrow 0} \ln(3 - r^2 \cos^2 \theta \sin^2 \theta) = \ln 3$$

 \Rightarrow define $f(0, 0) = \ln 3$

68.
$$\lim_{(x,y) \rightarrow (0,0)} \frac{3xy^2}{x^2 + y^2} = \lim_{r \rightarrow 0} \frac{(3r \cos \theta)(r^2 \sin^2 \theta)}{r^2} = \lim_{r \rightarrow 0} 3r \cos \theta \sin^2 \theta = 0 \Rightarrow \text{define } f(0,0) = 0$$

69. Let $\delta = 0.1$. Then $\sqrt{x^2 + y^2} < \delta \Rightarrow \sqrt{x^2 + y^2} < 0.1 \Rightarrow x^2 + y^2 < 0.01 \Rightarrow |x^2 + y^2 - 0| < 0.01$
 $\Rightarrow |f(x, y) - f(0, 0)| < 0.01 = \epsilon$.

70. Let $\delta = 0.05$. Then $|x| < \delta$ and $|y| < \delta \Rightarrow |f(x, y) - f(0, 0)| = \left| \frac{y}{x^2 + 1} - 0 \right| = \left| \frac{y}{x^2 + 1} \right| \leq |y| < 0.05 = \epsilon$.

71. Let $\delta = 0.005$. Then $|x| < \delta$ and $|y| < \delta \Rightarrow |f(x, y) - f(0, 0)| = \left| \frac{x+y}{x^2 + 1} - 0 \right| = \left| \frac{x+y}{x^2 + 1} \right| \leq |x + y| < |x| + |y| < 0.005 + 0.005 = 0.01 = \epsilon$.

72. Let $\delta = 0.01$. Since $-1 \leq \cos x \leq 1 \Rightarrow 1 \leq 2 + \cos x \leq 3 \Rightarrow \frac{1}{3} \leq \frac{1}{2 + \cos x} \leq 1 \Rightarrow \frac{|x+y|}{3} \leq \left| \frac{x+y}{2 + \cos x} \right| \leq |x + y| \leq |x| + |y|$.

Then $|x| < \delta$ and $|y| < \delta \Rightarrow |f(x, y) - f(0, 0)| = \left| \frac{x+y}{2 + \cos x} - 0 \right| = \left| \frac{x+y}{2 + \cos x} \right| \leq |x| + |y| < 0.01 + 0.01 = 0.02 = \epsilon$.

73. Let $\delta = 0.04$. Since $y^2 \leq x^2 + y^2 \Rightarrow \frac{y^2}{x^2 + y^2} \leq 1 \Rightarrow \frac{|x|y^2}{x^2 + y^2} \leq |x| = \sqrt{x^2} \leq \sqrt{x^2 + y^2} < \delta \Rightarrow |f(x, y) - f(0, 0)|$
 $= \left| \frac{xy^2}{x^2 + y^2} - 0 \right| < 0.04 = \epsilon.$

74. Let $\delta = 0.01$. If $|y| \leq 1$, then $y^2 \leq |y| = \sqrt{y^2} \leq \sqrt{x^2 + y^2}$, so $|x| = \sqrt{x^2} \leq \sqrt{x^2 + y^2} \Rightarrow |x| + y^2 \leq 2\sqrt{x^2 + y^2}$.
 Since $x^2 \leq x^2 + y^2 \Rightarrow \frac{x^2}{x^2 + y^2} \leq 1$ and $y^2 \leq x^2 + y^2 \Rightarrow \frac{y^2}{x^2 + y^2} \leq 1$. Then $\frac{|x^3 + y^4|}{x^2 + y^2} \leq \frac{x^2}{x^2 + y^2} |x| + \frac{y^2}{x^2 + y^2} y^2$
 $\leq |x| + y^2 < 2\delta \Rightarrow |f(x, y) - f(0, 0)| = \left| \frac{x^3 + y^4}{x^2 + y^2} - 0 \right| < 2(0.01) = 0.002 = \epsilon.$

75. Let $\delta = \sqrt{0.015}$. Then $\sqrt{x^2 + y^2 + z^2} < \delta \Rightarrow |f(x, y, z) - f(0, 0, 0)| = |x^2 + y^2 + z^2 - 0| = |x^2 + y^2 + z^2|$
 $= \left(\sqrt{x^2 + y^2 + z^2} \right)^2 < \left(\sqrt{0.015} \right)^2 = 0.015 = \epsilon.$

76. Let $\delta = 0.2$. Then $|x| < \delta, |y| < \delta$, and $|z| < \delta \Rightarrow |f(x, y, z) - f(0, 0, 0)| = |xyz - 0| = |xyz| = |x| |y| |z| < (0.2)^3$
 $= 0.008 = \epsilon.$

77. Let $\delta = 0.005$. Then $|x| < \delta, |y| < \delta$, and $|z| < \delta \Rightarrow |f(x, y, z) - f(0, 0, 0)| = \left| \frac{x+y+z}{x^2+y^2+z^2+1} - 0 \right| = \left| \frac{x+y+z}{x^2+y^2+z^2+1} \right|$
 $\leq |x+y+z| \leq |x| + |y| + |z| < 0.005 + 0.005 + 0.005 = 0.015 = \epsilon.$

78. Let $\delta = \tan^{-1}(0.1)$. Then $|x| < \delta, |y| < \delta$, and $|z| < \delta \Rightarrow |f(x, y, z) - f(0, 0, 0)| = \left| \tan^2 x + \tan^2 y + \tan^2 z \right|$
 $\leq \left| \tan^2 x \right| + \left| \tan^2 y \right| + \left| \tan^2 z \right| = \tan^2 x + \tan^2 y + \tan^2 z < \tan^2 \delta + \tan^2 \delta + \tan^2 \delta = 0.01 + 0.01 + 0.01 = 0.03 = \epsilon.$

79. $\lim_{(x, y, z) \rightarrow (x_0, y_0, z_0)} f(x, y, z) = \lim_{(x, y, z) \rightarrow (x_0, y_0, z_0)} (x + y - z) = x_0 + y_0 - z_0 = f(x_0, y_0, z_0) \Rightarrow f$ is continuous at every (x_0, y_0, z_0)

80. $\lim_{(x, y, z) \rightarrow (x_0, y_0, z_0)} f(x, y, z) = \lim_{(x, y, z) \rightarrow (x_0, y_0, z_0)} (x^2 + y^2 + z^2) = x_0^2 + y_0^2 + z_0^2 = f(x_0, y_0, z_0) \Rightarrow f$ is continuous at every point (x_0, y_0, z_0)

14.3 PARTIAL DERIVATIVES

1. $\frac{\partial f}{\partial x} = 4x, \frac{\partial f}{\partial y} = -3$

2. $\frac{\partial f}{\partial x} = 2x - y, \frac{\partial f}{\partial y} = -x + 2y$

3. $\frac{\partial f}{\partial x} = 2x(y + 2), \frac{\partial f}{\partial y} = x^2 - 1$

4. $\frac{\partial f}{\partial x} = 5y - 14x + 3, \frac{\partial f}{\partial y} = 5x - 2y - 6$

5. $\frac{\partial f}{\partial x} = 2y(xy - 1), \frac{\partial f}{\partial y} = 2x(xy - 1)$

6. $\frac{\partial f}{\partial x} = 6(2x - 3y)^2, \frac{\partial f}{\partial y} = -9(2x - 3y)^2$

7. $\frac{\partial f}{\partial x} = \frac{x}{\sqrt{x^2+y^2}}, \frac{\partial f}{\partial y} = \frac{y}{\sqrt{x^2+y^2}}$
8. $\frac{\partial f}{\partial x} = \frac{2x^2}{\sqrt[3]{x^3+(\frac{y}{2})}}, \frac{\partial f}{\partial y} = \frac{1}{3\sqrt[3]{x^3+(\frac{y}{2})}}$
9. $\frac{\partial f}{\partial x} = -\frac{1}{(x+y)^2} \cdot \frac{\partial}{\partial x}(x+y) = -\frac{1}{(x+y)^2}, \frac{\partial f}{\partial y} = -\frac{1}{(x+y)^2} \cdot \frac{\partial}{\partial y}(x+y) = -\frac{1}{(x+y)^2}$
10. $\frac{\partial f}{\partial x} = \frac{(x^2+y^2)(1-x(2x))}{(x^2+y^2)^2} = \frac{y^2-x^2}{(x^2+y^2)^2}, \frac{\partial f}{\partial y} = \frac{(x^2+y^2)(0)-x(2y)}{(x^2+y^2)^2} = -\frac{2xy}{(x^2+y^2)^2}$
11. $\frac{\partial f}{\partial x} = \frac{(xy-1)(1)-(x+y)(y)}{(xy-1)^2} = \frac{-y^2-1}{(xy-1)^2}, \frac{\partial f}{\partial y} = \frac{(xy-1)(1)-(x+y)(x)}{(xy-1)^2} = \frac{-x^2-1}{(xy-1)^2}$
12. $\frac{\partial f}{\partial x} = \frac{1}{1+(\frac{y}{x})^2} \cdot \frac{\partial}{\partial x}\left(\frac{y}{x}\right) = -\frac{y}{x^2\left[1+(\frac{y}{x})^2\right]} = -\frac{y}{x^2+y^2}, \frac{\partial f}{\partial y} = \frac{1}{1+(\frac{y}{x})^2} \cdot \frac{\partial}{\partial y}\left(\frac{y}{x}\right) = \frac{1}{x\left[1+(\frac{y}{x})^2\right]} = \frac{x}{x^2+y^2}$
13. $\frac{\partial f}{\partial x} = e^{(x+y+1)} \cdot \frac{\partial}{\partial x}(x+y+1) = e^{(x+y+1)}, \frac{\partial f}{\partial y} = e^{(x+y+1)} \cdot \frac{\partial}{\partial y}(x+y+1) = e^{(x+y+1)}$
14. $\frac{\partial f}{\partial x} = -e^{-x} \sin(x+y) + e^{-x} \cos(x+y), \frac{\partial f}{\partial y} = e^{-x} \cos(x+y)$
15. $\frac{\partial f}{\partial x} = \frac{1}{x+y} \cdot \frac{\partial}{\partial x}(x+y) = \frac{1}{x+y}, \frac{\partial f}{\partial y} = \frac{1}{x+y} \cdot \frac{\partial}{\partial y}(x+y) = \frac{1}{x+y}$
16. $\frac{\partial f}{\partial x} = e^{xy} \cdot \frac{\partial}{\partial x}(xy) \cdot \ln y = ye^{xy} \ln y, \frac{\partial f}{\partial y} = e^{xy} \cdot \frac{\partial}{\partial y}(xy) \cdot \ln y + e^{xy} \cdot \frac{1}{y} = xe^{xy} \ln y + \frac{e^{xy}}{y}$
17. $\frac{\partial f}{\partial x} = 2 \sin(x-3y) \cdot \frac{\partial}{\partial x} \sin(x-3y) = 2 \sin(x-3y) \cos(x-3y) \cdot \frac{\partial}{\partial x}(x-3y) = 2 \sin(x-3y) \cos(x-3y),$
 $\frac{\partial f}{\partial y} = 2 \sin(x-3y) \cdot \frac{\partial}{\partial y} \sin(x-3y) = 2 \sin(x-3y) \cos(x-3y) \cdot \frac{\partial}{\partial y}(x-3y) = -6 \sin(x-3y) \cos(x-3y)$
18. $\frac{\partial f}{\partial x} = 2 \cos(3x-y^2) \cdot \frac{\partial}{\partial x} \cos(3x-y^2) = -2 \cos(3x-y^2) \sin(3x-y^2) \cdot \frac{\partial}{\partial x}(3x-y^2)$
 $= -6 \cos(3x-y^2) \sin(3x-y^2),$
 $\frac{\partial f}{\partial y} = 2 \cos(3x-y^2) \cdot \frac{\partial}{\partial y} \cos(3x-y^2) = -2 \cos(3x-y^2) \sin(3x-y^2) \cdot \frac{\partial}{\partial y}(3x-y^2)$
 $= 4y \cos(3x-y^2) \sin(3x-y^2)$
19. $\frac{\partial f}{\partial x} = -yx^{y-1}, \frac{\partial f}{\partial y} = x^y \ln x$
20. $f(x, y) = \frac{\ln x}{\ln y} \Rightarrow \frac{\partial f}{\partial x} = \frac{1}{x \ln y}$ and $\frac{\partial f}{\partial y} = \frac{-\ln x}{y(\ln y)^2}$
21. $\frac{\partial f}{\partial x} = -g(x), \frac{\partial f}{\partial y} = g(y)$

39. $W_p = V$, $W_v = P + \frac{\delta v^2}{2g}$, $W_\delta = \frac{Vv^2}{2g}$, $W_v = \frac{2V\delta v}{2g} = \frac{V\delta v}{g}$, $W_g = -\frac{V\delta v^2}{2g^2}$
40. $\frac{\partial A}{\partial c} = m$, $\frac{\partial A}{\partial h} = \frac{q}{2}$, $\frac{\partial A}{\partial k} = \frac{m}{q}$, $\frac{\partial A}{\partial m} = \frac{k}{q} + c$, $\frac{\partial A}{\partial q} = -\frac{km}{q^2} + \frac{h}{2}$
41. $\frac{\partial f}{\partial x} = 1 + y$, $\frac{\partial f}{\partial y} = 1 + x$, $\frac{\partial^2 f}{\partial x^2} = 0$, $\frac{\partial^2 f}{\partial y^2} = 0$, $\frac{\partial^2 f}{\partial y \partial x} = \frac{\partial^2 f}{\partial x \partial y} = 1$
42. $\frac{\partial f}{\partial x} = y \cos xy$, $\frac{\partial f}{\partial y} = x \cos xy$, $\frac{\partial^2 f}{\partial x^2} = -y^2 \sin xy$, $\frac{\partial^2 f}{\partial y^2} = -x^2 \sin xy$, $\frac{\partial^2 f}{\partial y \partial x} = \frac{\partial^2 f}{\partial x \partial y} = \cos xy - xy \sin xy$
43. $\frac{\partial g}{\partial x} = 2xy + y \cos x$, $\frac{\partial g}{\partial y} = x^2 - \sin y + \sin x$, $\frac{\partial^2 g}{\partial x^2} = 2y - y \sin x$, $\frac{\partial^2 g}{\partial y^2} = -\cos y$, $\frac{\partial^2 g}{\partial y \partial x} = \frac{\partial^2 g}{\partial x \partial y} = 2x + \cos x$
44. $\frac{\partial h}{\partial x} = e^y$, $\frac{\partial h}{\partial y} = xe^y + 1$, $\frac{\partial^2 h}{\partial x^2} = 0$, $\frac{\partial^2 h}{\partial y^2} = xe^y$, $\frac{\partial^2 h}{\partial y \partial x} = \frac{\partial^2 h}{\partial x \partial y} = e^y$
45. $\frac{\partial r}{\partial x} = \frac{1}{x+y}$, $\frac{\partial r}{\partial y} = \frac{1}{x+y}$, $\frac{\partial^2 r}{\partial x^2} = \frac{-1}{(x+y)^2}$, $\frac{\partial^2 r}{\partial y^2} = \frac{-1}{(x+y)^2}$, $\frac{\partial^2 r}{\partial y \partial x} = \frac{\partial^2 r}{\partial x \partial y} = \frac{-1}{(x+y)^2}$
46. $\frac{\partial s}{\partial x} = \left[\frac{1}{1 + \left(\frac{y}{x}\right)^2} \right] \cdot \frac{\partial}{\partial x} \left(\frac{y}{x} \right) = \left(-\frac{y}{x^2} \right) \left[\frac{1}{1 + \left(\frac{y}{x}\right)^2} \right] = \frac{-y}{x^2 + y^2}$, $\frac{\partial s}{\partial y} = \left[\frac{1}{1 + \left(\frac{y}{x}\right)^2} \right] \cdot \frac{\partial}{\partial y} \left(\frac{y}{x} \right) = \left(\frac{1}{x} \right) \left[\frac{1}{1 + \left(\frac{y}{x}\right)^2} \right] = \frac{x}{x^2 + y^2}$,
 $\frac{\partial^2 s}{\partial x^2} = \frac{y(2x)}{(x^2 + y^2)^2} = \frac{2xy}{(x^2 + y^2)^2}$, $\frac{\partial^2 s}{\partial y^2} = \frac{-x(2y)}{(x^2 + y^2)^2} = -\frac{2xy}{(x^2 + y^2)^2}$, $\frac{\partial^2 s}{\partial y \partial x} = \frac{\partial^2 s}{\partial x \partial y} = \frac{(x^2 + y^2)(-1) + y(2y)}{(x^2 + y^2)^2} = \frac{y^2 - x^2}{(x^2 + y^2)^2}$
47. $\frac{\partial w}{\partial x} = 2x \tan(xy) + x^2 \sec^2(xy) \cdot y = 2x \tan(xy) + x^2 y \sec^2(xy)$, $\frac{\partial w}{\partial y} = x^2 \sec^2(xy) \cdot x = x^3 \sec^2(xy)$,
 $\frac{\partial^2 w}{\partial x^2} = 2 \tan(xy) + 2x \sec^2(xy) \cdot y + 2xy \sec^2(xy) + x^2 y (2 \sec(xy) \sec(xy) \tan(xy) \cdot y)$
 $= 2 \tan(xy) + 4xy \sec^2(xy) + 2x^2 y^2 \sec^2(xy) \tan(xy)$, $\frac{\partial^2 w}{\partial y^2} = x^3 (2 \sec(xy) \sec(xy) \tan(xy) \cdot x)$
 $= 2x^4 \sec^2(xy) \tan(xy)$, $\frac{\partial^2 w}{\partial y \partial x} = \frac{\partial^2 w}{\partial x \partial y} = 3x^2 \sec^2(xy) + x^3 (2 \sec(xy) \sec(xy) \tan(xy) \cdot y)$
 $= 3x^2 \sec^2(xy) + x^3 y \sec^2(xy) \tan(xy)$
48. $\frac{\partial w}{\partial x} = ye^{x^2-y} \cdot 2x = 2xye^{x^2-y}$, $\frac{\partial w}{\partial y} = (1)e^{x^2-y} + ye^{x^2-y} \cdot (-1) = e^{x^2-y}(1-y)$,
 $\frac{\partial^2 w}{\partial x^2} = 2ye^{x^2-y} + 2xy(e^{x^2-y} \cdot 2x) = 2ye^{x^2-y}(1+2x^2)$, $\frac{\partial^2 w}{\partial y^2} = (e^{x^2-y} \cdot (-1))(1-y) + e^{x^2-y}(-1) = e^{x^2-y}(y-2)$,
 $\frac{\partial^2 w}{\partial y \partial x} = \frac{\partial^2 w}{\partial x \partial y} = (e^{x^2-y} \cdot 2x)(1-y) = 2xe^{x^2-y}(1-y)$
49. $\frac{\partial w}{\partial x} = \sin(x^2 y) + x \cos(x^2 y) \cdot 2xy = \sin(x^2 y) + 2x^2 y \cos(x^2 y)$, $\frac{\partial w}{\partial y} = x \cos(x^2 y) \cdot x^2 = x^3 \cos(x^2 y)$,
 $\frac{\partial^2 w}{\partial x^2} = \cos(x^2 y) \cdot 2xy + 4xy \cos(x^2 y) - 2x^2 y \sin(x^2 y) \cdot 2xy = 6xy \cos(x^2 y) - 4x^3 y^2 \sin(x^2 y)$,

$$\begin{aligned}\frac{\partial^2 w}{\partial y^2} &= -x^3 \sin(x^2 y) \cdot x^2 = -x^5 \sin(x^2 y), \quad \frac{\partial^2 w}{\partial y \partial x} = \frac{\partial^2 w}{\partial x \partial y} = 3x^2 \cos(x^2 y) - x^3 \sin(x^2 y) \cdot 2xy \\ &= 3x^2 \cos(x^2 y) - 2x^4 y \sin(x^2 y)\end{aligned}$$

$$\begin{aligned}50. \quad \frac{\partial w}{\partial x} &= \frac{(x^2+y)-(x-y)(2x)}{(x^2+y)^2} = \frac{-x^2+2xy+y}{(x^2+y)^2}, \quad \frac{\partial w}{\partial y} = \frac{(x^2+y)(-1)-(x-y)}{(x^2+y)^2} = \frac{-x^2-x}{(x^2+y)^2}, \\ \frac{\partial^2 w}{\partial x^2} &= \frac{(x^2+y)^2(-2x+2y)-(-x^2+2xy+y)2(x^2+y)(2x)}{\left[(x^2+y)^2\right]^2} = \frac{2(x^3-3x^2y-3xy+y^2)}{(x^2+y)^3}, \quad \frac{\partial^2 w}{\partial y^2} = \frac{(x^2+y)^2 \cdot 0 - (-x^2-x)2(x^2+y) \cdot 1}{\left[(x^2+y)^2\right]^2} \\ &= \frac{2x^2+2x}{(x^2+y)^3}, \quad \frac{\partial^2 w}{\partial y \partial x} = \frac{\partial^2 w}{\partial x \partial y} = \frac{(x^2+y)^2(2x+1)-(-x^2+2xy+y)2(x^2+y) \cdot 1}{\left[(x^2+y)^2\right]^2} = \frac{2x^3+3x^2-2xy-y}{(x^2+y)^3}\end{aligned}$$

$$51. \quad \frac{\partial w}{\partial x} = \frac{2}{2x+3y}, \quad \frac{\partial w}{\partial y} = \frac{3}{2x+3y}, \quad \frac{\partial^2 w}{\partial y \partial x} = \frac{-6}{(2x+3y)^2}, \quad \text{and} \quad \frac{\partial^2 w}{\partial x \partial y} = \frac{-6}{(2x+3y)^2}$$

$$52. \quad \frac{\partial w}{\partial x} = e^x + \ln y + \frac{y}{x}, \quad \frac{\partial w}{\partial y} = \frac{x}{y} + \ln x, \quad \frac{\partial^2 w}{\partial y \partial x} = \frac{1}{y} + \frac{1}{x}, \quad \text{and} \quad \frac{\partial^2 w}{\partial x \partial y} = \frac{1}{y} + \frac{1}{x}$$

$$\begin{aligned}53. \quad \frac{\partial w}{\partial x} &= y^2 + 2xy^3 + 3x^2 y^4, \quad \frac{\partial w}{\partial y} = 2xy + 3x^2 y^2 + 4x^3 y^3, \quad \frac{\partial^2 w}{\partial y \partial x} = 2y + 6xy^2 + 12x^2 y^3, \quad \text{and} \\ \frac{\partial^2 w}{\partial x \partial y} &= 2y + 6xy^2 + 12x^2 y^3\end{aligned}$$

$$54. \quad \frac{\partial w}{\partial x} = \sin y + y \cos x + y, \quad \frac{\partial w}{\partial y} = x \cos y + \sin x + x, \quad \frac{\partial^2 w}{\partial y \partial x} = \cos y + \cos x + 1, \quad \text{and} \quad \frac{\partial^2 w}{\partial x \partial y} = \cos y + \cos x + 1$$

$$55. \quad \text{(a) } x \text{ first} \quad \text{(b) } y \text{ first} \quad \text{(c) } x \text{ first} \quad \text{(d) } x \text{ first} \quad \text{(e) } y \text{ first} \quad \text{(f) } y \text{ first}$$

$$56. \quad \text{(a) } y \text{ first three times} \quad \text{(b) } y \text{ first three times} \quad \text{(c) } y \text{ first twice} \quad \text{(d) } x \text{ first twice}$$

$$\begin{aligned}57. \quad f_x(1,2) &= \lim_{h \rightarrow 0} \frac{f(1+h,2)-f(1,2)}{h} = \lim_{h \rightarrow 0} \frac{[1-(1+h)+2-6(1+h)^2]-(2-6)}{h} = \lim_{h \rightarrow 0} \frac{-h-6(1+2h+h^2)+6}{h} = \lim_{h \rightarrow 0} \frac{-13h-6h^2}{h} \\ &= \lim_{h \rightarrow 0} (-13-6h) = -13, \quad f_y(1,2) = \lim_{h \rightarrow 0} \frac{f(1,2+h)-f(1,2)}{h} = \lim_{h \rightarrow 0} \frac{[1-1+(2+h)-3(2+h)]-(2-6)}{h} = \lim_{h \rightarrow 0} \frac{(2-6-2h)-(2-6)}{h} \\ &= \lim_{h \rightarrow 0} (-2) = -2\end{aligned}$$

$$\begin{aligned}58. \quad f_x(-2,1) &= \lim_{h \rightarrow 0} \frac{f(-2+h,1)-f(-2,1)}{h} = \lim_{h \rightarrow 0} \frac{[4+2(-2+h)-3(-2+h)]-(-3+2)}{h} = \lim_{h \rightarrow 0} \frac{(2h-1-h)+1}{h} = \lim_{h \rightarrow 0} 1 = 1, \\ f_y(-2,1) &= \lim_{h \rightarrow 0} \frac{f(-2,1+h)-f(-2,1)}{h} = \lim_{h \rightarrow 0} \frac{[4-4-3(1+h)+2(1+h)^2]-(-3+2)}{h} = \lim_{h \rightarrow 0} \frac{(-3-3h+2+4h+2h^2)+1}{h} = \lim_{h \rightarrow 0} \frac{h+2h^2}{h} \\ &= \lim_{h \rightarrow 0} (1+2h) = 1\end{aligned}$$

$$\begin{aligned}
 59. \quad f_x(-2, 3) &= \lim_{h \rightarrow 0} \frac{f(-2+h, 3) - f(-2, 3)}{h} = \lim_{h \rightarrow 0} \frac{\sqrt{2(-2+h)+9-1} - \sqrt{-4+9-1}}{h} = \lim_{h \rightarrow 0} \frac{\sqrt{2h+4}-2}{h} = \lim_{h \rightarrow 0} \left(\frac{\sqrt{2h+4}-2}{h} \cdot \frac{\sqrt{2h+4}+2}{\sqrt{2h+4}+2} \right) \\
 &= \lim_{h \rightarrow 0} \frac{2}{\sqrt{2h+4}+2} = \frac{1}{2}, \quad f_y(-2, 3) = \lim_{h \rightarrow 0} \frac{f(-2, 3+h) - f(-2, 3)}{h} = \lim_{h \rightarrow 0} \frac{\sqrt{-4+3(3+h)-1} - \sqrt{-4+9-1}}{h} = \lim_{h \rightarrow 0} \frac{\sqrt{3h+4}-2}{h} \\
 &= \lim_{h \rightarrow 0} \left(\frac{\sqrt{3h+4}-2}{h} \cdot \frac{\sqrt{3h+4}+2}{\sqrt{3h+4}+2} \right) = \lim_{h \rightarrow 0} \frac{3}{\sqrt{3h+4}+2} = \frac{3}{4}
 \end{aligned}$$

$$\begin{aligned}
 60. \quad f_x(0, 0) &= \lim_{h \rightarrow 0} \frac{f(0+h, 0) - f(0, 0)}{h} = \lim_{h \rightarrow 0} \frac{\frac{\sin(h^3+0)}{h^2+0} - 0}{h} = \lim_{h \rightarrow 0} \frac{\sin h^3}{h^3} = 1, \\
 f_y(0, 0) &= \lim_{h \rightarrow 0} \frac{f(0, 0+h) - f(0, 0)}{h} = \lim_{h \rightarrow 0} \frac{\frac{\sin(0+h^4)}{0+h^2} - 0}{h} = \lim_{h \rightarrow 0} \frac{\sin h^4}{h^3} = \lim_{h \rightarrow 0} \left(h \cdot \frac{\sin h^4}{h^4} \right) = 0 \cdot 1 = 0
 \end{aligned}$$

$$\begin{aligned}
 61. \quad (a) \quad &\text{In the plane } x = 2 \Rightarrow f_y(x, y) = 3 \Rightarrow f_y(2, -1) = 3 \Rightarrow m = 3 \\
 (b) \quad &\text{In the plane } y = -1 \Rightarrow f_x(x, y) = 2 \Rightarrow f_x(2, -1) = 2 \Rightarrow m = 2
 \end{aligned}$$

$$\begin{aligned}
 62. \quad (a) \quad &\text{In the plane } x = -1 \Rightarrow f_y(x, y) = 3y^2 \Rightarrow f_y(-1, 1) = 3(1)^2 = 3 \Rightarrow m = 3 \\
 (b) \quad &\text{In the plane } y = 1 \Rightarrow f_x(x, y) = 2x \Rightarrow f_x(-1, 1) = 2(-1) = -2 \Rightarrow m = -2
 \end{aligned}$$

$$\begin{aligned}
 63. \quad f_z(x_0, y_0, z_0) &= \lim_{h \rightarrow 0} \frac{f(x_0, y_0, z_0+h) - f(x_0, y_0, z_0)}{h}; \\
 f_z(1, 2, 3) &= \lim_{h \rightarrow 0} \frac{f(1, 2, 3+h) - f(1, 2, 3)}{h} = \lim_{h \rightarrow 0} \frac{2(3+h)^2 - 2(9)}{h} = \lim_{h \rightarrow 0} \frac{12h + 2h^2}{h} = \lim_{h \rightarrow 0} (12 + 2h) = 12
 \end{aligned}$$

$$\begin{aligned}
 64. \quad f_y(x_0, y_0, z_0) &= \lim_{h \rightarrow 0} \frac{f(x_0, y_0, z_0+h) - f(x_0, y_0, z_0)}{h}; \\
 f_y(-1, 0, 3) &= \lim_{h \rightarrow 0} \frac{f(-1, h, 3) - f(-1, 0, 3)}{h} = \lim_{h \rightarrow 0} \frac{(2h^2 + 9h) - 0}{h} = \lim_{h \rightarrow 0} (2h + 9) = 9
 \end{aligned}$$

$$65. \quad y + \left(3z^2 \frac{\partial z}{\partial x} \right) x + z^3 - 2y \frac{\partial z}{\partial x} = 0 \Rightarrow (3xz^2 - 2y) \frac{\partial z}{\partial x} = -y - z^3 \Rightarrow \text{at } (1, 1, 1) \text{ we have } (3-2) \frac{\partial z}{\partial x} = -1-1 \text{ or } \frac{\partial z}{\partial x} = -2$$

$$66. \quad \left(\frac{\partial x}{\partial z} \right) z + x + \left(\frac{y}{x} \right) \frac{\partial x}{\partial z} - 2x \frac{\partial x}{\partial z} = 0 \Rightarrow \left(z + \frac{y}{x} - 2x \right) \frac{\partial x}{\partial z} = -x \Rightarrow \text{at } (1, -1, -3) \text{ we have } (-3-1-2) \frac{\partial x}{\partial z} = -1 \text{ or } \frac{\partial x}{\partial z} = \frac{1}{6}$$

$$\begin{aligned}
 67. \quad a^2 = b^2 + c^2 - 2bc \cos A &\Rightarrow 2a = (2bc \sin A) \frac{\partial A}{\partial a} \Rightarrow \frac{\partial A}{\partial a} = \frac{a}{bc \sin A}; \text{ also } 0 = 2b - 2c \cos A + (2bc \sin A) \frac{\partial A}{\partial b} \\
 &\Rightarrow 2c \cos A - 2b = (2bc \sin A) \frac{\partial A}{\partial b} \Rightarrow \frac{\partial A}{\partial b} = \frac{c \cos A - b}{bc \sin A}
 \end{aligned}$$

$$\begin{aligned}
 68. \quad \frac{a}{\sin A} = \frac{b}{\sin B} &\Rightarrow \frac{(\sin A) \frac{\partial a}{\partial A} - a \cos A}{\sin^2 A} = 0 \Rightarrow (\sin A) \frac{\partial a}{\partial A} - a \cos A = 0 \Rightarrow \frac{\partial a}{\partial A} = \frac{a \cos A}{\sin A}; \text{ also } \left(\frac{1}{\sin A} \right) \frac{\partial a}{\partial B} = b(-\csc B \cot B) \\
 &\Rightarrow \frac{\partial a}{\partial B} = -b \csc B \cot B \sin A
 \end{aligned}$$

69. Differentiating each equation implicitly gives $1 = v_x \ln u + \left(\frac{v}{u}\right)u_x$ and $0 = u_x \ln v + \left(\frac{u}{v}\right)v_x$ or

$$\left. \begin{aligned} (\ln u)v_x + \left(\frac{v}{u}\right)u_x &= 1 \\ \left(\frac{u}{v}\right)v_x + (\ln v)u_x &= 0 \end{aligned} \right\} \Rightarrow v_x = \frac{\begin{vmatrix} 1 & \frac{v}{u} \\ 0 & \ln v \end{vmatrix}}{\begin{vmatrix} \ln u & \frac{v}{u} \\ \frac{u}{v} & \ln v \end{vmatrix}} = \frac{\ln v}{(\ln u)(\ln v) - 1}$$

70. Differentiating each equation implicitly gives $1 = (2x)x_u - (2y)y_u$ and $0 = (2x)x_u - y_u$ or

$$\left. \begin{aligned} (2x)x_u - (2y)y_u &= 1 \\ (2x)x_u - y_u &= 0 \end{aligned} \right\} \Rightarrow x_u = \frac{\begin{vmatrix} 1 & -2y \\ 0 & -1 \end{vmatrix}}{\begin{vmatrix} 2x & -2y \\ 2x & -1 \end{vmatrix}} = \frac{-1}{-2x+4xy} = \frac{1}{2x-4xy} \quad \text{and} \quad y_u = \frac{\begin{vmatrix} 2x & 1 \\ 2x & 0 \end{vmatrix}}{\begin{vmatrix} 2x & -2y \\ 2x & -1 \end{vmatrix}} = \frac{-2x}{-2x+4xy} = \frac{2x}{2x-4xy} = \frac{1}{1-2y}$$

$$\text{next } s = x^2 + y^2 \Rightarrow \frac{\partial s}{\partial u} = 2x \frac{\partial x}{\partial u} + 2y \frac{\partial y}{\partial u} = 2x \left(\frac{1}{2x-4xy} \right) + 2y \left(\frac{1}{1-2y} \right) = \frac{1}{1-2y} + \frac{2y}{1-2y} = \frac{1+2y}{1-2y}$$

71. $f_x(x, y) = \begin{cases} 0 & \text{if } y \geq 0 \\ 0 & \text{if } y < 0 \end{cases} \Rightarrow f_x(x, y) = 0$ for all points (x, y) ; at $y = 0$, $f_y(x, 0) = \lim_{h \rightarrow 0} \frac{f(x, 0+h) - f(x, 0)}{h}$
 $= \lim_{h \rightarrow 0} \frac{f(x, h) - 0}{h} = \lim_{h \rightarrow 0} \frac{f(x, h)}{h} = 0$ because $\lim_{h \rightarrow 0^-} \frac{f(x, h)}{h} = \lim_{h \rightarrow 0^-} \frac{h^3}{h} = 0$ and $\lim_{h \rightarrow 0^+} \frac{f(x, h)}{h} = \lim_{h \rightarrow 0^+} \frac{h^2}{h} = 0$
 $\Rightarrow f_y(x, y) = \begin{cases} 3y^2 & \text{if } y \geq 0 \\ -2y & \text{if } y < 0 \end{cases}; f_{yx}(x, y) = f_{xy}(x, y) = 0$ for all points (x, y)

72. At $x = 0$, $f_x(0, y) = \lim_{h \rightarrow 0} \frac{f(0+h, y) - f(0, y)}{h} = \lim_{h \rightarrow 0} \frac{f(h, y) - 0}{h} = \lim_{h \rightarrow 0} \frac{f(h, y)}{h}$ which does not exist because

$$\lim_{h \rightarrow 0^-} \frac{f(h, y)}{h} = \lim_{h \rightarrow 0^-} \frac{h^2}{h} = 0 \quad \text{and} \quad \lim_{h \rightarrow 0^+} \frac{f(h, y)}{h} = \lim_{h \rightarrow 0^+} \frac{\sqrt{h}}{h} = \lim_{h \rightarrow 0^+} \frac{1}{\sqrt{h}} = +\infty \Rightarrow f_x(x, y) = \begin{cases} \frac{1}{2\sqrt{x}} & \text{if } x > 0 \\ 2x & \text{if } x < 0 \end{cases};$$

$f_y(x, y) = \begin{cases} 0 & \text{if } x \geq 0 \\ 0 & \text{if } x < 0 \end{cases} \Rightarrow f_y(x, y) = 0$ for all points (x, y) ; $f_{yx}(x, y) = 0$ for all points (x, y) , while

$f_{xy}(x, y) = 0$ for all points (x, y) such that $x \neq 0$.

73. $\frac{\partial f}{\partial x} = 2x$, $\frac{\partial f}{\partial y} = 2y$, $\frac{\partial f}{\partial z} = -4z \Rightarrow \frac{\partial^2 f}{\partial x^2} = 2$, $\frac{\partial^2 f}{\partial y^2} = 2$, $\frac{\partial^2 f}{\partial z^2} = -4 \Rightarrow \frac{\partial^2 f}{\partial x^2} + \frac{\partial^2 f}{\partial y^2} + \frac{\partial^2 f}{\partial z^2} = 2 + 2 + (-4) = 0$

74. $\frac{\partial f}{\partial x} = -6xz$, $\frac{\partial f}{\partial z} = -6yz$, $\frac{\partial f}{\partial z} = 6z^2 - 3(x^2 + y^2)$, $\frac{\partial^2 f}{\partial x^2} = -6z$, $\frac{\partial^2 f}{\partial y^2} = -6z$, $\frac{\partial^2 f}{\partial z^2} = 12z$
 $\Rightarrow \frac{\partial^2 f}{\partial x^2} + \frac{\partial^2 f}{\partial y^2} + \frac{\partial^2 f}{\partial z^2} = -6z - 6z + 12z = 0$

75. $\frac{\partial f}{\partial x} = -2e^{-2y} \sin 2x$, $\frac{\partial f}{\partial y} = -2e^{-2y} \cos 2x$, $\frac{\partial^2 f}{\partial x^2} = -4e^{-2y} \cos 2x$, $\frac{\partial^2 f}{\partial y^2} = -4e^{-2y} \cos 2x$
 $\Rightarrow \frac{\partial^2 f}{\partial x^2} + \frac{\partial^2 f}{\partial y^2} = -4e^{-2y} \cos 2x + 4e^{-2y} \cos 2x = 0$

76. $\frac{\partial f}{\partial x} = \frac{x}{x^2+y^2}$, $\frac{\partial f}{\partial y} = \frac{y}{x^2+y^2}$, $\frac{\partial^2 f}{\partial x^2} = \frac{y^2-x^2}{(x^2+y^2)^2}$, $\frac{\partial^2 f}{\partial y^2} = \frac{x^2-y^2}{(x^2+y^2)^2} \Rightarrow \frac{\partial^2 f}{\partial x^2} + \frac{\partial^2 f}{\partial y^2} = \frac{y^2-x^2}{(x^2+y^2)^2} + \frac{x^2-y^2}{(x^2+y^2)^2} = 0$

$$77. \frac{\partial f}{\partial x} = 3, \frac{\partial f}{\partial y} = 2, \frac{\partial^2 f}{\partial x^2} = 0, \frac{\partial^2 f}{\partial y^2} = 0 \Rightarrow \frac{\partial^2 f}{\partial x^2} + \frac{\partial^2 f}{\partial y^2} = 0 + 0 = 0$$

$$78. \frac{\partial f}{\partial x} = \frac{1/y}{1+(\frac{x}{y})^2} = \frac{y}{y^2+x^2}, \frac{\partial f}{\partial y} = \frac{-x/y^2}{1+(\frac{x}{y})^2} = \frac{-x}{y^2+x^2}, \frac{\partial^2 f}{\partial x^2} = \frac{(y^2+x^2)0-y \cdot 2x}{(y^2+x^2)^2} = \frac{-2xy}{(y^2+x^2)^2},$$

$$\frac{\partial^2 f}{\partial y^2} = \frac{(y^2+x^2)0-(-x) \cdot 2y}{(y^2+x^2)^2} = \frac{2xy}{(y^2+x^2)^2} \Rightarrow \frac{\partial^2 f}{\partial x^2} + \frac{\partial^2 f}{\partial y^2} = \frac{-2xy}{(y^2+x^2)^2} + \frac{2xy}{(y^2+x^2)^2} = 0$$

$$79. \frac{\partial f}{\partial x} = -\frac{1}{2}(x^2+y^2+z^2)^{-3/2}(2x) = -x(x^2+y^2+z^2)^{-3/2},$$

$$\frac{\partial f}{\partial y} = -\frac{1}{2}(x^2+y^2+z^2)^{-3/2}(2y) = -y(x^2+y^2+z^2)^{-3/2},$$

$$\frac{\partial f}{\partial z} = -\frac{1}{2}(x^2+y^2+z^2)^{-3/2}(2z) = -z(x^2+y^2+z^2)^{-3/2};$$

$$\frac{\partial^2 f}{\partial x^2} = -\left(x^2+y^2+z^2\right)^{-3/2} + 3x^2\left(x^2+y^2+z^2\right)^{-5/2},$$

$$\frac{\partial^2 f}{\partial y^2} = -\left(x^2+y^2+z^2\right)^{-3/2} + 3y^2\left(x^2+y^2+z^2\right)^{-5/2},$$

$$\frac{\partial^2 f}{\partial z^2} = -\left(x^2+y^2+z^2\right)^{-3/2} + 3z^2\left(x^2+y^2+z^2\right)^{-5/2}$$

$$\Rightarrow \frac{\partial^2 f}{\partial x^2} + \frac{\partial^2 f}{\partial y^2} + \frac{\partial^2 f}{\partial z^2} = \left[-\left(x^2+y^2+z^2\right)^{-3/2} + 3x^2\left(x^2+y^2+z^2\right)^{-5/2}\right]$$

$$+ \left[-\left(x^2+y^2+z^2\right)^{-3/2} + 3y^2\left(x^2+y^2+z^2\right)^{-5/2}\right] + \left[-\left(x^2+y^2+z^2\right)^{-3/2} + 3z^2\left(x^2+y^2+z^2\right)^{-5/2}\right]$$

$$= -3\left(x^2+y^2+z^2\right)^{-3/2} + (3x^2+3y^2+3z^2)\left(x^2+y^2+z^2\right)^{-5/2} = 0$$

$$80. \frac{\partial f}{\partial x} = 3e^{3x+4y} \cos 5z, \frac{\partial f}{\partial y} = 4e^{3x+4y} \cos 5z, \frac{\partial f}{\partial z} = -5e^{3x+4y} \sin 5z; \frac{\partial^2 f}{\partial x^2} = 9e^{3x+4y} \cos 5z,$$

$$\frac{\partial^2 f}{\partial y^2} = 16e^{3x+4y} \cos 5z, \frac{\partial^2 f}{\partial z^2} = -25e^{3x+4y} \cos 5z$$

$$\Rightarrow \frac{\partial^2 f}{\partial x^2} + \frac{\partial^2 f}{\partial y^2} + \frac{\partial^2 f}{\partial z^2} = 9e^{3x+4y} \cos 5z + 16e^{3x+4y} \cos 5z - 25e^{3x+4y} \cos 5z = 0$$

$$81. \frac{\partial w}{\partial x} = \cos(x+ct), \frac{\partial w}{\partial t} = c \cos(x+ct); \frac{\partial^2 w}{\partial x^2} = -\sin(x+ct), \frac{\partial^2 w}{\partial t^2} = -c^2 \sin(x+ct)$$

$$\Rightarrow \frac{\partial^2 w}{\partial t^2} = c^2 [-\sin(x+ct)] = c^2 \frac{\partial^2 w}{\partial x^2}$$

$$82. \frac{\partial w}{\partial x} = -2 \sin(2x+2ct), \frac{\partial w}{\partial t} = -2c \sin(2x+2ct); \frac{\partial^2 w}{\partial x^2} = -4 \cos(2x+2ct), \frac{\partial^2 w}{\partial t^2} = -4c^2 \cos(2x+2ct)$$

$$\Rightarrow \frac{\partial^2 w}{\partial t^2} = c^2 [-4 \cos(2x+2ct)] = c^2 \frac{\partial^2 w}{\partial x^2}$$

83. $\frac{\partial w}{\partial x} = \cos(x+ct) - 2\sin(2x+2ct)$, $\frac{\partial w}{\partial t} = c\cos(x+ct) - 2c\sin(2x+2ct)$; $\frac{\partial^2 w}{\partial x^2} = -\sin(x+ct) - 4\cos(2x+2ct)$,
 $\frac{\partial^2 w}{\partial t^2} = -c^2\sin(x+ct) - 4c^2\cos(2x+2ct) \Rightarrow \frac{\partial^2 w}{\partial t^2} = c^2[-\sin(x+ct) - 4\cos(2x+2ct)] = c^2 \frac{\partial^2 w}{\partial x^2}$

84. $\frac{\partial w}{\partial x} = \frac{1}{x+ct}$, $\frac{\partial w}{\partial t} = \frac{c}{x+ct}$; $\frac{\partial^2 w}{\partial x^2} = \frac{-1}{(x+ct)^2}$, $\frac{\partial^2 w}{\partial t^2} = \frac{-c^2}{(x+ct)^2} \Rightarrow \frac{\partial^2 w}{\partial t^2} = c^2 \left[\frac{-1}{(x+ct)^2} \right] = c^2 \frac{\partial^2 w}{\partial x^2}$

85. $\frac{\partial w}{\partial x} = 2\sec^2(2x-2ct)$, $\frac{\partial w}{\partial t} = -2c\sec^2(2x-2ct)$; $\frac{\partial^2 w}{\partial x^2} = 8\sec^2(2x-2ct)\tan(2x-2ct)$,
 $\frac{\partial^2 w}{\partial t^2} = 8c^2\sec^2(2x-2ct)\tan(2x-2ct) \Rightarrow ux \frac{\partial^2 w}{\partial t^2} = c^2 \left[8\sec^2(2x-2ct)\tan(2x-2ct) \right] = c^2 \frac{\partial^2 w}{\partial x^2}$

86. $\frac{\partial w}{\partial x} = -15\sin(3x+3ct) + e^{x+ct}$, $\frac{\partial w}{\partial t} = -15c\sin(3x+3ct) + ce^{x+ct}$; $\frac{\partial^2 w}{\partial x^2} = -45\cos(3x+3ct) + e^{x+ct}$,
 $\frac{\partial^2 w}{\partial t^2} = -45c^2\cos(3x+3ct) + c^2e^{x+ct} \Rightarrow \frac{\partial^2 w}{\partial t^2} = c^2[-45\cos(3x+3ct) + e^{x+ct}] = c^2 \frac{\partial^2 w}{\partial x^2}$

87. $\frac{\partial w}{\partial t} = \frac{\partial f}{\partial u} \frac{\partial u}{\partial t} = \frac{\partial f}{\partial u}(ac) \Rightarrow \frac{\partial^2 w}{\partial t^2} = (ac) \left(\frac{\partial^2 f}{\partial u^2} \right) (ac) = a^2 c^2 \frac{\partial^2 f}{\partial u^2}$; $\frac{\partial w}{\partial x} = \frac{\partial f}{\partial u} \frac{\partial u}{\partial x} = \frac{\partial f}{\partial u} \cdot a \Rightarrow \frac{\partial^2 w}{\partial x^2} = \left(a \frac{\partial^2 f}{\partial u^2} \right) \cdot a$
 $= a^2 \frac{\partial^2 f}{\partial u^2} \Rightarrow \frac{\partial^2 w}{\partial t^2} = a^2 c^2 \frac{\partial^2 f}{\partial u^2} = c^2 \left(a^2 \frac{\partial^2 f}{\partial u^2} \right) = c^2 \frac{\partial^2 w}{\partial x^2}$

88. If the first partial derivatives are continuous throughout an open region R , then by Theorem 3 in this section of the text, $f(x, y) = f(x_0, y_0) + f_x(x_0, y_0)\Delta x + f_y(x_0, y_0)\Delta y + \epsilon_1\Delta x + \epsilon_2\Delta y$, where $\epsilon_1, \epsilon_2 \rightarrow 0$ as $\Delta x, \Delta y \rightarrow 0$.

Then as $(x, y) \rightarrow (x_0, y_0)$, $\Delta x \rightarrow 0$ and $\Delta y \rightarrow 0 \Rightarrow \lim_{(x,y) \rightarrow (x_0,y_0)} f(x, y) = f(x_0, y_0) \Rightarrow f$ is continuous at every point (x_0, y_0) in R .

89. Yes, since f_{xx}, f_{yy}, f_{xy} , and f_{yx} are all continuous on R , use the same reasoning as in Exercise 88 with

$f_x(x, y) = f_x(x_0, y_0) + f_{xx}(x_0, y_0)\Delta x + f_{xy}(x_0, y_0)\Delta y + \epsilon_1\Delta x + \epsilon_2\Delta y$ and
 $f_y(x, y) = f_y(x_0, y_0) + f_{yx}(x_0, y_0)\Delta x + f_{yy}(x_0, y_0)\Delta y + \hat{\epsilon}_1\Delta x + \hat{\epsilon}_2\Delta y$. Then
 $\lim_{(x,y) \rightarrow (x_0,y_0)} f_x(x, y) = f_x(x_0, y_0)$ and $\lim_{(x,y) \rightarrow (x_0,y_0)} f_y(x, y) = f_y(x_0, y_0)$.

90. To find α and β so that $u_t = u_{xx} \Rightarrow u_t = -\beta\sin(\alpha x)e^{-\beta t}$ and $u_x = \alpha\cos(\alpha x)e^{-\beta t}$
 $\Rightarrow u_{xx} = -\alpha^2\sin(\alpha x)e^{-\beta t}$; then $u_t = u_{xx} \Rightarrow -\beta\sin(\alpha x)e^{-\beta t} = -\alpha^2\sin(\alpha x)e^{-\beta t}$, thus $u_t = u_{xx}$ only if $\beta = \alpha^2$

91. $f_x(0, 0) = \lim_{h \rightarrow 0} \frac{f(0+h, 0) - f(0, 0)}{h} = \lim_{h \rightarrow 0} \frac{\frac{h \cdot 0^2}{h^2 + 0^4} - 0}{h} = \lim_{h \rightarrow 0} \frac{0}{h} = 0$; $f_y(0, 0) = \lim_{h \rightarrow 0} \frac{f(0, 0+h) - f(0, 0)}{h} = \lim_{h \rightarrow 0} \frac{\frac{0 \cdot h^2}{0^2 + h^4} - 0}{h}$
 $= \lim_{h \rightarrow 0} \frac{0}{h} = 0$; $\lim_{(x,y) \rightarrow (0,0)} f(x, y) = \lim_{y \rightarrow 0} \frac{(ky^2)y^2}{(ky^2)^2 + y^4} = \lim_{y \rightarrow 0} \frac{ky^4}{k^2y^4 + y^4} = \lim_{y \rightarrow 0} \frac{k}{k^2 + 1} = \frac{k}{k^2 + 1} \Rightarrow$ different limits for
 along $x = ky^2$

different values of $k \Rightarrow \lim_{(x,y) \rightarrow (0,0)} f(x, y)$ does not exist $\Rightarrow f(x, y)$ is not continuous at $(0, 0) \Rightarrow$ by Theorem 4, $f(x, y)$ is not differentiable at $(0, 0)$.

$$\begin{aligned}
 92. \quad f_x(0, 0) &= \lim_{h \rightarrow 0} \frac{f(0+h, 0) - f(0, 0)}{h} = \lim_{h \rightarrow 0} \frac{f(h, 0) - 1}{h} = \lim_{h \rightarrow 0} \frac{1-1}{h} = 0; \quad f_y(0, 0) = \lim_{h \rightarrow 0} \frac{f(0, 0+h) - f(0, 0)}{h} \\
 &= \lim_{h \rightarrow 0} \frac{f(0, h) - 1}{h} = \lim_{h \rightarrow 0} \frac{1-1}{h} = 0; \quad \lim_{\substack{(x, y) \rightarrow (0, 0) \\ \text{along } y=x^2}} f(x, y) = \lim_{y \rightarrow 0} 0 = 0 \quad \text{but} \quad \lim_{\substack{(x, y) \rightarrow (0, 0) \\ \text{along } y=1.5x^2}} f(x, y) = \lim_{y \rightarrow 0} 1 = 1 \\
 &\Rightarrow \lim_{(x, y) \rightarrow (0, 0)} f(x, y) \text{ does not exist} \Rightarrow f(x, y) \text{ is not continuous at } (0, 0) \Rightarrow \text{by Theorem 4, } f(x, y) \text{ is not} \\
 &\text{differentiable at } (0, 0).
 \end{aligned}$$

14.4 THE CHAIN RULE

- $\frac{\partial w}{\partial x} = 2x, \quad \frac{\partial w}{\partial y} = 2y, \quad \frac{dx}{dt} = -\sin t, \quad \frac{dy}{dt} = \cos t \Rightarrow \frac{dw}{dt} = -2x \sin t + 2y \cos t = -2 \cos t \sin t + 2 \sin t \cos t = 0;$
 $w = x^2 + y^2 = \cos^2 t + \sin^2 t = 1 \Rightarrow \frac{dw}{dt} = 0$
 - $\frac{dw}{dt}(\pi) = 0$
- $\frac{\partial w}{\partial x} = 2x, \quad \frac{\partial w}{\partial y} = 2y, \quad \frac{dx}{dt} = -\sin t + \cos t, \quad \frac{dy}{dt} = -\sin t - \cos t$
 $\Rightarrow \frac{dw}{dt} = (2x)(-\sin t + \cos t) + (2y)(-\sin t - \cos t) = 2(\cos t + \sin t)(\cos t - \sin t) - 2(\cos t - \sin t)(\sin t + \cos t)$
 $= (2 \cos^2 t - 2 \sin^2 t) - (2 \cos^2 t - 2 \sin^2 t) = 0; \quad w = x^2 + y^2 = (\cos t + \sin t)^2 + (\cos t - \sin t)^2$
 $= 2 \cos^2 t + 2 \sin^2 t = 2 \Rightarrow \frac{dw}{dt} = 0$
 - $\frac{dw}{dt}(0) = 0$
- $\frac{\partial w}{\partial x} = \frac{1}{z}, \quad \frac{\partial w}{\partial y} = \frac{1}{z}, \quad \frac{\partial w}{\partial z} = \frac{-(x+y)}{z^2}, \quad \frac{dx}{dt} = -2 \cos t \sin t, \quad \frac{dy}{dt} = 2 \sin t \cos t, \quad \frac{dz}{dt} = -\frac{1}{t^2}$
 $\Rightarrow \frac{dw}{dt} = -\frac{2}{z} \cos t \sin t + \frac{2}{z} \sin t \cos t + \frac{x+y}{z^2 t^2} = \frac{\cos^2 t + \sin^2 t}{\left(\frac{1}{t^2}\right)(t^2)} = 1; \quad w = \frac{x}{z} + \frac{y}{z} = \frac{\cos^2 t}{\left(\frac{1}{t}\right)} + \frac{\sin^2 t}{\left(\frac{1}{t}\right)} = t \Rightarrow \frac{dw}{dt} = 1$
 - $\frac{dw}{dt}(3) = 1$
- $\frac{\partial w}{\partial x} = \frac{2x}{x^2+y^2+z^2}, \quad \frac{\partial w}{\partial y} = \frac{2y}{x^2+y^2+z^2}, \quad \frac{\partial w}{\partial z} = \frac{2z}{x^2+y^2+z^2}, \quad \frac{dx}{dt} = -\sin t, \quad \frac{dy}{dt} = \cos t, \quad \frac{dz}{dt} = 2t^{-1/2}$
 $\Rightarrow \frac{dw}{dt} = \frac{-2x \sin t}{x^2+y^2+z^2} + \frac{2y \cos t}{x^2+y^2+z^2} + \frac{4zt^{-1/2}}{x^2+y^2+z^2} = \frac{-2 \cos t \sin t + 2 \sin t \cos t + 4(4t^{1/2})t^{-1/2}}{\cos^2 t + \sin^2 t + 16t} = \frac{16}{1+16t};$
 $w = \ln(x^2 + y^2 + z^2) = \ln(\cos^2 t + \sin^2 t + 16t) = \ln(1 + 16t) \Rightarrow \frac{dw}{dt} = \frac{16}{1+16t}$
 - $\frac{dw}{dt}(3) = \frac{16}{49}$
- $\frac{\partial w}{\partial x} = 2ye^x, \quad \frac{\partial w}{\partial y} = 2e^x, \quad \frac{\partial w}{\partial z} = -\frac{1}{z}, \quad \frac{dx}{dt} = \frac{2t}{t^2+1}, \quad \frac{dy}{dt} = \frac{1}{t^2+1}, \quad \frac{dz}{dt} = e^t \Rightarrow \frac{dw}{dt} = \frac{4yte^x}{t^2+1} + \frac{2e^x}{t^2+1} - \frac{e^t}{z}$
 $= \frac{(4t)(\tan^{-1} t)(t^2+1)}{t^2+1} + \frac{2(t^2+1)}{t^2+1} - \frac{e^t}{e^t} = 4t \tan^{-1} t + 1; \quad w = 2ye^x - \ln z = (2 \tan^{-1} t)(t^2+1) - t$
 $\Rightarrow \frac{dw}{dt} = \left(\frac{2}{t^2+1}\right)(t^2+1) + (2 \tan^{-1} t)(2t) - 1 = 4t \tan^{-1} t + 1$
 - $\frac{dw}{dt}(1) = (4)(1)\left(\frac{\pi}{4}\right) + 1 = \pi + 1$

6. (a) $\frac{\partial w}{\partial x} = -y \cos xy, \frac{\partial w}{\partial y} = -x \cos xy, \frac{\partial w}{\partial z} = 1, \frac{dx}{dt} = 1, \frac{dy}{dt} = \frac{1}{t}, \frac{dz}{dt} = e^{t-1} \Rightarrow \frac{dw}{dt} = -y \cos xy - \frac{x \cos xy}{t} + e^{t-1}$
 $= -(\ln t)[\cos(t \ln t)] - \frac{t \cos(t \ln t)}{t} + e^{t-1} = -(\ln t)[\cos(t \ln t)] - \cos(t \ln t) + e^{t-1};$
 $w = z - \sin xy = e^{t-1} - \sin(t \ln t) \Rightarrow \frac{dw}{dt} = e^{t-1} - [\cos(t \ln t)] \left[\ln t + t \left(\frac{1}{t} \right) \right] = e^{t-1} - (1 + \ln t) \cos(t \ln t)$

(b) $\frac{dw}{dt}(1) = 1 - (1 + 0)(1) = 0$

7. (a) $\frac{\partial z}{\partial u} = \frac{\partial z}{\partial x} \frac{\partial x}{\partial u} + \frac{\partial z}{\partial y} \frac{\partial y}{\partial u} = (4e^x \ln y) \left(\frac{\cos v}{u \cos v} \right) + \left(\frac{4e^x}{y} \right) (\sin v) = \frac{4e^x \ln y}{u} + \frac{4e^x \sin v}{y}$
 $= \frac{4(u \cos v) \ln(u \sin v)}{u} + \frac{4(u \cos v)(\sin v)}{u \sin v} = (4 \cos v) \ln(u \sin v) + 4 \cos v;$
 $\frac{\partial z}{\partial v} = \frac{\partial z}{\partial x} \frac{\partial x}{\partial v} + \frac{\partial z}{\partial y} \frac{\partial y}{\partial v} = (4e^x \ln y) \left(\frac{-u \sin v}{u \cos v} \right) + \left(\frac{4e^x}{y} \right) (u \cos v) = -(4e^x \ln y)(\tan v) + \frac{4e^x u \cos v}{y}$
 $= [-4(u \cos v) \ln(u \sin v)](\tan v) + \frac{4(u \cos v)(u \cos v)}{u \sin v} = (-4u \sin v) \ln(u \sin v) + \frac{4u \cos^2 v}{\sin v};$
 $z = 4e^x \ln y = 4(u \cos v) \ln(u \sin v) \Rightarrow \frac{\partial z}{\partial u} = (4 \cos v) \ln(u \sin v) + 4(u \cos v) \left(\frac{\sin v}{u \sin v} \right)$
 $= (4 \cos v) \ln(u \sin v) + 4 \cos v; \text{ also } \frac{\partial z}{\partial v} = (-4u \sin v) \ln(u \sin v) + 4(u \cos v) \left(\frac{u \cos v}{u \sin v} \right)$
 $= (-4u \sin v) \ln(u \sin v) + \frac{4u \cos^2 v}{\sin v}$

(b) At $\left(2, \frac{\pi}{4} \right): \frac{\partial z}{\partial u} = 4 \cos \frac{\pi}{4} \ln \left(2 \sin \frac{\pi}{4} \right) + 4 \cos \frac{\pi}{4} = 2\sqrt{2} \ln \sqrt{2} + 2\sqrt{2} = \sqrt{2}(\ln 2 + 2);$
 $\frac{\partial z}{\partial v} = (-4)(2) \sin \frac{\pi}{4} \ln \left(2 \sin \frac{\pi}{4} \right) + \frac{(4)(2)(\cos^2 \frac{\pi}{4})}{(\sin \frac{\pi}{4})} = -4\sqrt{2} \ln \sqrt{2} + 4\sqrt{2} = -2\sqrt{2} \ln 2 + 4\sqrt{2}$

8. (a) $\frac{\partial z}{\partial v} = \left[\frac{\left(\frac{1}{y} \right)}{\left(\frac{x}{y} \right)^2 + 1} \right] \cos v + \left[\frac{\left(\frac{-x}{y^2} \right)}{\left(\frac{x}{y} \right)^2 + 1} \right] \sin v = \frac{y \cos v}{x^2 + y^2} - \frac{x \sin v}{x^2 + y^2} = \frac{(u \sin v)(\cos v) - (u \cos v)(\sin v)}{u^2} = 0;$
 $\frac{\partial z}{\partial v} = \left[\frac{\left(\frac{1}{y} \right)}{\left(\frac{x}{y} \right)^2 + 1} \right] (-u \sin v) + \left[\frac{\left(\frac{-x}{y^2} \right)}{\left(\frac{x}{y} \right)^2 + 1} \right] u \cos v = -\frac{yu \sin v}{x^2 + y^2} - \frac{xu \cos v}{x^2 + y^2} = \frac{-(u \sin v)(u \sin v) - (u \cos v)(u \cos v)}{u^2}$
 $= -\sin^2 v - \cos^2 v = -1; z = \tan^{-1} \left(\frac{x}{y} \right) = \tan^{-1}(\cot v) \Rightarrow \frac{\partial z}{\partial u} = 0 \text{ and } \frac{\partial z}{\partial v} = \left(\frac{-1}{1 + \cot^2 v} \right) (-\csc^2 v)$
 $= \frac{-1}{\sin^2 v + \cos^2 v} = -1$

(b) At $\left(1.3, \frac{\pi}{6} \right): \frac{\partial z}{\partial u} = 0 \text{ and } \frac{\partial z}{\partial v} = -1$

9. (a) $\frac{\partial w}{\partial u} = \frac{\partial w}{\partial x} \frac{\partial x}{\partial u} + \frac{\partial w}{\partial y} \frac{\partial y}{\partial u} + \frac{\partial w}{\partial z} \frac{\partial z}{\partial u} = (y + z)(1) + (x + z)(1) + (y + x)(v) = x + y + 2z + v(y + x)$
 $= (u + v) + (u - v) + 2uv + v(2u) = 2u + 4uv; \frac{\partial w}{\partial v} = \frac{\partial w}{\partial x} \frac{\partial x}{\partial v} + \frac{\partial w}{\partial y} \frac{\partial y}{\partial v} + \frac{\partial w}{\partial z} \frac{\partial z}{\partial v}$
 $= (y + z)(1) + (x + z)(-1) + (y + x)(u) = y - x + (y + x)u = -2v + (2u)u = -2v + 2u^2; w = xy + yz + xz$
 $= (u^2 - v^2) + (u^2 v - vu^2) + (u^2 v + uv^2) = u^2 - v^2 + 2u^2 v \Rightarrow \frac{\partial w}{\partial u} = 2u + 4uv \text{ and } \frac{\partial w}{\partial v} = -2v + 2u^2$

(b) At $\left(\frac{1}{2}, 1 \right): \frac{\partial w}{\partial u} = 2 \left(\frac{1}{2} \right) + 4 \left(\frac{1}{2} \right) (1) = 3 \text{ and } \frac{\partial w}{\partial v} = -2(1) + 2 \left(\frac{1}{2} \right)^2 = -\frac{3}{2}$

10. (a)
$$\begin{aligned} \frac{\partial w}{\partial u} &= \left(\frac{2x}{x^2+y^2+z^2} \right) (e^v \sin u + ue^v \cos u) + \left(\frac{2y}{x^2+y^2+z^2} \right) (e^v \cos u - ue^v \sin u) + \left(\frac{2z}{x^2+y^2+z^2} \right) (e^v) \\ &= \left(\frac{2ue^v \sin u}{u^2 e^{2v} \sin^2 u + u^2 e^{2v} \cos^2 u + u^2 e^{2v}} \right) (e^v \sin u + ue^v \cos u) + \left(\frac{2ue^v \cos u}{u^2 e^{2v} \sin^2 u + u^2 e^{2v} \cos^2 u + u^2 e^{2v}} \right) (e^v \cos u - ue^v \sin u) \\ &\quad + \left(\frac{2ue^v}{u^2 e^{2v} \sin^2 u + u^2 e^{2v} \cos^2 u + u^2 e^{2v}} \right) (e^v) = \frac{2}{u}; \\ \frac{\partial w}{\partial v} &= \left(\frac{2x}{x^2+y^2+z^2} \right) (ue^v \sin u) + \left(\frac{2y}{x^2+y^2+z^2} \right) (ue^v \cos u) + \left(\frac{2z}{x^2+y^2+z^2} \right) (ue^v) \\ &= \left(\frac{2ue^v \sin u}{u^2 e^{2v} \sin^2 u + u^2 e^{2v} \cos^2 u + u^2 e^{2v}} \right) (ue^v \sin u) + \left(\frac{2ue^v \cos u}{u^2 e^{2v} \sin^2 u + u^2 e^{2v} \cos^2 u + u^2 e^{2v}} \right) (ue^v \cos u) \\ &\quad + \left(\frac{2ue^v}{u^2 e^{2v} \sin^2 u + u^2 e^{2v} \cos^2 u + u^2 e^{2v}} \right) (ue^v) = 2; \\ w &= \ln(u^2 e^{2v} \sin^2 u + u^2 e^{2v} \cos^2 u + u^2 e^{2v}) = \ln(2u^2 e^{2v}) = \ln 2 + 2 \ln u + 2v \Rightarrow \frac{\partial w}{\partial u} = \frac{2}{u} \text{ and } \frac{\partial w}{\partial v} = 2 \end{aligned}$$

(b) At $(-2, 0)$: $\frac{\partial w}{\partial u} = \frac{2}{-2} = -1$ and $\frac{\partial w}{\partial v} = 2$

11. (a)
$$\begin{aligned} \frac{\partial u}{\partial x} &= \frac{\partial u}{\partial p} \frac{\partial p}{\partial x} + \frac{\partial u}{\partial q} \frac{\partial q}{\partial x} + \frac{\partial u}{\partial r} \frac{\partial r}{\partial x} = \frac{1}{q-r} + \frac{r-p}{(q-r)^2} + \frac{p-q}{(q-r)^2} = \frac{q-r+r-p+p-q}{(q-r)^2} = 0; \\ \frac{\partial u}{\partial y} &= \frac{\partial u}{\partial p} \frac{\partial p}{\partial y} + \frac{\partial u}{\partial q} \frac{\partial q}{\partial y} + \frac{\partial u}{\partial r} \frac{\partial r}{\partial y} = \frac{1}{q-r} - \frac{r-p}{(q-r)^2} + \frac{p-q}{(q-r)^2} = \frac{q-r-r+p+p-q}{(q-r)^2} = \frac{2p-2r}{(q-r)^2} \\ &= \frac{(2x+2y+2z)-(2x+2y-2z)}{(2z-2y)^2} = \frac{z}{(z-y)^2}; \quad \frac{\partial u}{\partial z} = \frac{\partial u}{\partial p} \frac{\partial p}{\partial z} + \frac{\partial u}{\partial q} \frac{\partial q}{\partial z} + \frac{\partial u}{\partial r} \frac{\partial r}{\partial z} = \frac{1}{q-r} + \frac{r-p}{(q-r)^2} - \frac{p-q}{(q-r)^2} \\ &= \frac{q-r+r-p-p+q}{(q-r)^2} = \frac{2q-2p}{(q-r)^2} = \frac{-4y}{(2z-2y)^2} = -\frac{y}{(z-y)^2}; \quad u = \frac{p-q}{q-r} = \frac{2y}{2z-2y} = \frac{y}{z-y} \Rightarrow \frac{\partial u}{\partial x} = 0; \\ \frac{\partial u}{\partial y} &= \frac{(z-y)-y(-1)}{(z-y)^2} = \frac{z}{(z-y)^2}, \text{ and } \frac{\partial u}{\partial z} = \frac{(z-y)(0)-y(1)}{(z-y)^2} = -\frac{y}{(z-y)^2} \end{aligned}$$

(b) At $(\sqrt{3}, 2, 1)$: $\frac{\partial u}{\partial x} = 0$, $\frac{\partial u}{\partial y} = \frac{1}{(1-2)^2} = 1$, and $\frac{\partial u}{\partial z} = \frac{-2}{(1-2)^2} = -2$

12. (a)
$$\begin{aligned} \frac{\partial u}{\partial x} &= \frac{e^{qr}}{\sqrt{1-p^2}} (\cos x) + (re^{qr} \sin^{-1} p)(0) + (qe^{qr} \sin^{-1} p)(0) = \frac{e^{qr} \cos x}{\sqrt{1-p^2}} = \frac{e^{z \ln y} \cos x}{\sqrt{1-\sin^2 x}} = y^z \text{ if } -\frac{\pi}{2} < x < \frac{\pi}{2}; \\ \frac{\partial u}{\partial y} &= \frac{e^{qr}}{\sqrt{1-p^2}} (0) + (re^{qr} \sin^{-1} p) \left(\frac{z^2}{y} \right) + (qe^{qr} \sin^{-1} p)(0) = \frac{z^2 re^{qr} \sin^{-1} p}{y} = \frac{z^2 \left(\frac{1}{z} \right) y^z x}{y} = xzy^{z-1}; \\ \frac{\partial u}{\partial z} &= \frac{e^{qr}}{\sqrt{1-p^2}} (0) + (re^{qr} \sin^{-1} p)(2z \ln y) + (qe^{qr} \sin^{-1} p) \left(-\frac{1}{z^2} \right) = (2zre^{qr} \sin^{-1} p)(\ln y) - \frac{qe^{qr} \sin^{-1} p}{z^2} \\ &= (2z) \left(\frac{1}{z} \right) (y^z x \ln y) - \frac{(z^2 \ln y)(y^z)x}{z^2} = xy^z \ln y; \quad u = e^{z \ln y} \sin^{-1}(\sin x) = xy^z \text{ if } -\frac{\pi}{2} \leq x \leq \frac{\pi}{2} \Rightarrow \frac{\partial u}{\partial x} = y^z, \\ \frac{\partial u}{\partial y} &= xzy^{z-1}, \text{ and } \frac{\partial u}{\partial z} = xy^z \ln y \text{ from direct calculations} \end{aligned}$$

(b) At $\left(\frac{\pi}{4}, \frac{1}{2}, -\frac{1}{2}\right)$: $\frac{\partial u}{\partial x} = \left(\frac{1}{2}\right)^{-1/2} = \sqrt{2}$, $\frac{\partial u}{\partial y} = \left(\frac{\pi}{4}\right) \left(-\frac{1}{2}\right) \left(\frac{1}{2}\right)^{(-1/2)-1} = -\frac{\pi\sqrt{2}}{4}$, $\frac{\partial u}{\partial z} = \left(\frac{\pi}{4}\right) \left(\frac{1}{2}\right)^{-1/2} \ln\left(\frac{1}{2}\right)$
 $= -\frac{\pi\sqrt{2} \ln 2}{4}$

13. $\frac{dz}{dt} = \frac{\partial z}{\partial x} \frac{dx}{dt} + \frac{\partial z}{\partial y} \frac{dy}{dt}$

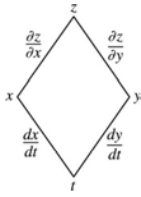

14. $\frac{dz}{dt} = \frac{\partial z}{\partial u} \frac{du}{dt} + \frac{\partial z}{\partial v} \frac{dv}{dt} + \frac{\partial z}{\partial w} \frac{dw}{dt}$

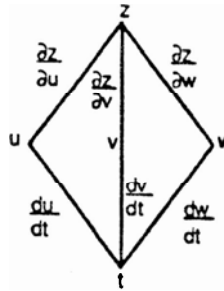

15. $\frac{\partial w}{\partial u} = \frac{\partial w}{\partial x} \frac{\partial x}{\partial u} + \frac{\partial w}{\partial y} \frac{\partial y}{\partial u} + \frac{\partial w}{\partial z} \frac{\partial z}{\partial u}$

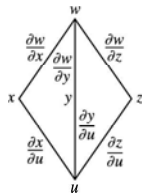

$\frac{\partial w}{\partial v} = \frac{\partial w}{\partial x} \frac{\partial x}{\partial v} + \frac{\partial w}{\partial y} \frac{\partial y}{\partial v} + \frac{\partial w}{\partial z} \frac{\partial z}{\partial v}$

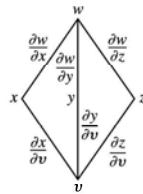

16. $\frac{\partial w}{\partial x} = \frac{\partial w}{\partial r} \frac{\partial r}{\partial x} + \frac{\partial w}{\partial s} \frac{\partial s}{\partial x} + \frac{\partial w}{\partial t} \frac{\partial t}{\partial x}$

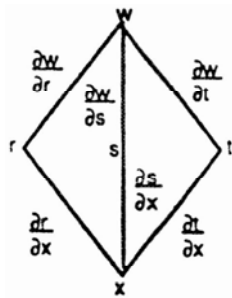

$\frac{\partial w}{\partial y} = \frac{\partial w}{\partial r} \frac{\partial r}{\partial y} + \frac{\partial w}{\partial s} \frac{\partial s}{\partial y} + \frac{\partial w}{\partial t} \frac{\partial t}{\partial y}$

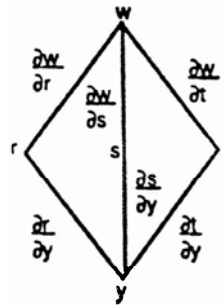

17. $\frac{\partial w}{\partial u} = \frac{\partial w}{\partial x} \frac{\partial x}{\partial u} + \frac{\partial w}{\partial y} \frac{\partial y}{\partial u}$

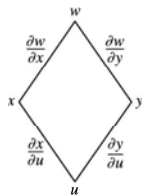

$\frac{\partial w}{\partial v} = \frac{\partial w}{\partial x} \frac{\partial x}{\partial v} + \frac{\partial w}{\partial y} \frac{\partial y}{\partial v}$

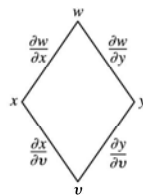

18. $\frac{\partial w}{\partial x} = \frac{\partial w}{\partial u} \frac{\partial u}{\partial x} + \frac{\partial w}{\partial v} \frac{\partial v}{\partial x}$

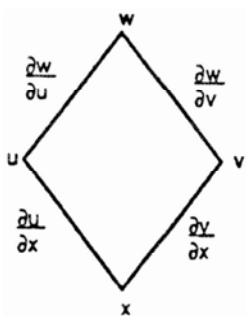

$\frac{\partial w}{\partial y} = \frac{\partial w}{\partial u} \frac{\partial u}{\partial y} + \frac{\partial w}{\partial v} \frac{\partial v}{\partial y}$

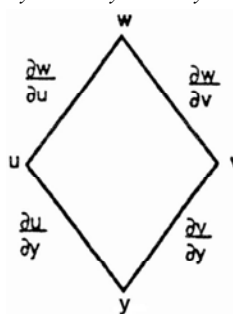

19. $\frac{\partial z}{\partial t} = \frac{\partial z}{\partial x} \frac{\partial x}{\partial t} + \frac{\partial z}{\partial y} \frac{\partial y}{\partial t}$

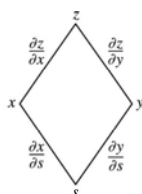
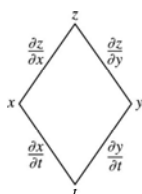

$\frac{\partial z}{\partial s} = \frac{\partial z}{\partial x} \frac{\partial x}{\partial s} + \frac{\partial z}{\partial y} \frac{\partial y}{\partial s}$

20. $\frac{\partial y}{\partial r} = \frac{dy}{du} \frac{\partial u}{\partial r}$

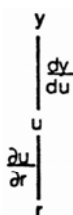

21. $\frac{\partial w}{\partial s} = \frac{dw}{du} \frac{\partial u}{\partial s}$ $\frac{\partial w}{\partial t} = \frac{dw}{du} \frac{\partial u}{\partial t}$

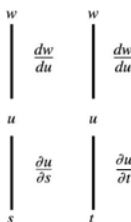

22. $\frac{\partial w}{\partial p} = \frac{\partial w}{\partial x} \frac{\partial x}{\partial p} + \frac{\partial w}{\partial y} \frac{\partial y}{\partial p} + \frac{\partial w}{\partial z} \frac{\partial z}{\partial p} + \frac{\partial w}{\partial v} \frac{\partial v}{\partial p}$

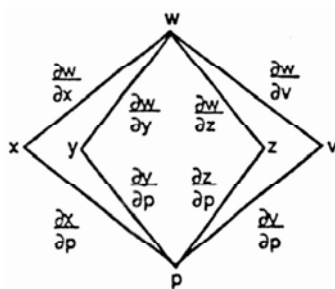

23. $\frac{\partial w}{\partial r} = \frac{\partial w}{\partial x} \frac{dx}{dr} + \frac{\partial w}{\partial y} \frac{dy}{dr} = \frac{\partial w}{\partial x} \frac{dx}{dr}$ since $\frac{dy}{dr} = 0$

$\frac{\partial w}{\partial s} = \frac{\partial w}{\partial x} \frac{dx}{ds} + \frac{\partial w}{\partial y} \frac{dy}{ds} = \frac{\partial w}{\partial x} \frac{dx}{ds}$ since $\frac{dy}{ds} = 0$

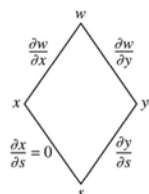
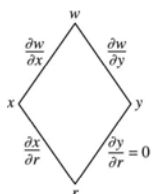

24. $\frac{\partial w}{\partial s} = \frac{\partial w}{\partial x} \frac{\partial x}{\partial s} + \frac{\partial w}{\partial y} \frac{\partial y}{\partial s}$

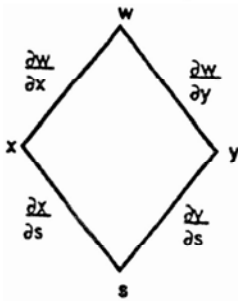

25. Let $F(x, y) = x^3 - 2y^2 + xy = 0 \Rightarrow F_x(x, y) = 3x^2 + y$
 and $F_y(x, y) = -4y + x \Rightarrow \frac{dy}{dx} = -\frac{F_x}{F_y} = -\frac{3x^2 + y}{-4y + x}$
 $\Rightarrow \frac{dy}{dx}(1, 1) = \frac{4}{3}$

26. Let $F(x, y) = xy + y^2 - 3x - 3 = 0 \Rightarrow F_x(x, y) = y - 3$ and $F_y(x, y) = x + 2y \Rightarrow \frac{dy}{dx} = -\frac{F_x}{F_y} = -\frac{y-3}{x+2y}$
 $\Rightarrow \frac{dy}{dx}(-1, 1) = 2$

27. Let $F(x, y) = x^2 + xy + y^2 - 7 = 0 \Rightarrow F_x(x, y) = 2x + y$ and $F_y(x, y) = x + 2y \Rightarrow \frac{dy}{dx} = -\frac{F_x}{F_y} = -\frac{2x+y}{x+2y}$
 $\Rightarrow \frac{dy}{dx}(1, 2) = -\frac{4}{5}$

28. Let $F(x, y) = xe^y + \sin xy + y - \ln 2 = 0 \Rightarrow F_x(x, y) = e^y + y \cos xy$ and $F_y(x, y) = xe^y + x \sin xy + 1$
 $\Rightarrow \frac{dy}{dx} = -\frac{F_x}{F_y} = -\frac{e^y + y \cos xy}{xe^y + x \sin xy + 1} \Rightarrow \frac{dy}{dx}(0, \ln 2) = -(2 + \ln 2)$

29. Let $F(x, y, z) = z^3 - xy + yz + y^3 - 2 = 0 \Rightarrow F_x(x, y, z) = -y, F_y(x, y, z) = -x + z + 3y^2,$
 $F_z(x, y, z) = 3z^2 + y \Rightarrow \frac{\partial z}{\partial x} = -\frac{F_x}{F_z} = -\frac{-y}{3z^2 + y} = \frac{y}{3z^2 + y} \Rightarrow \frac{\partial z}{\partial x}(1, 1, 1) = \frac{1}{4}; \frac{\partial z}{\partial y} = -\frac{F_y}{F_z} = -\frac{-x + z + 3y^2}{3z^2 + y} = \frac{x - z - 3y^2}{3z^2 + y}$
 $\Rightarrow \frac{\partial z}{\partial y}(1, 1, 1) = -\frac{3}{4}$

30. Let $F(x, y, z) = \frac{1}{x} + \frac{1}{y} + \frac{1}{z} - 1 = 0 \Rightarrow F_x(x, y, z) = -\frac{1}{x^2}, F_y(x, y, z) = -\frac{1}{y^2}, F_z(x, y, z) = -\frac{1}{z^2}$
 $\Rightarrow \frac{\partial z}{\partial x} = -\frac{F_x}{F_z} = -\frac{\left(-\frac{1}{x^2}\right)}{\left(-\frac{1}{z^2}\right)} = -\frac{z^2}{x^2} \Rightarrow \frac{\partial z}{\partial x}(2, 3, 6) = -9; \frac{\partial z}{\partial y} = -\frac{F_y}{F_z} = -\frac{\left(-\frac{1}{y^2}\right)}{\left(-\frac{1}{z^2}\right)} = -\frac{z^2}{y^2} \Rightarrow \frac{\partial z}{\partial y}(2, 3, 6) = -4$

31. Let $F(x, y, z) = \sin(x + y) + \sin(y + z) + \sin(x + z) = 0 \Rightarrow F_x(x, y, z) = \cos(x + y) + \cos(x + z),$
 $F_y(x, y, z) = \cos(x + y) + \cos(y + z), F_z(x, y, z) = \cos(y + z) + \cos(x + z)$
 $\Rightarrow \frac{\partial z}{\partial x} = -\frac{F_x}{F_z} = -\frac{\cos(x+y) + \cos(x+z)}{\cos(y+z) + \cos(x+z)} \Rightarrow \frac{\partial z}{\partial x}(\pi, \pi, \pi) = -1; \frac{\partial z}{\partial y} = -\frac{F_y}{F_z} = -\frac{\cos(x+y) + \cos(y+z)}{\cos(y+z) + \cos(x+z)} \Rightarrow \frac{\partial z}{\partial y}(\pi, \pi, \pi) = -1$

32. Let $F(x, y, z) = xe^y + ye^z + 2 \ln x - 2 - 3 \ln 2 = 0 \Rightarrow F_x(x, y, z) = e^y + \frac{2}{x}$, $F_y(x, y, z) = xe^y + e^z$,
 $F_z(x, y, z) = ye^z \Rightarrow \frac{\partial z}{\partial x} = -\frac{F_x}{F_z} = -\frac{(e^y + \frac{2}{x})}{ye^z} \Rightarrow \frac{\partial z}{\partial x}(1, \ln 2, \ln 3) = -\frac{4}{3 \ln 2}$; $\frac{\partial z}{\partial y} = -\frac{F_y}{F_z} = -\frac{xe^y + e^z}{ye^z}$
 $\Rightarrow \frac{\partial z}{\partial y}(1, \ln 2, \ln 3) = -\frac{5}{3 \ln 2}$
33. $\frac{\partial w}{\partial r} = \frac{\partial w}{\partial x} \frac{\partial x}{\partial r} + \frac{\partial w}{\partial y} \frac{\partial y}{\partial r} + \frac{\partial w}{\partial z} \frac{\partial z}{\partial r} = 2(x+y+z)(1) + 2(x+y+z)[- \sin(r+s)] + 2(x+y+z)[\cos(r+s)]$
 $= 2(x+y+z)[1 - \sin(r+s) + \cos(r+s)] = 2[r-s + \cos(r+s) + \sin(r+s)][1 - \sin(r+s) + \cos(r+s)]$
 $\Rightarrow \frac{\partial w}{\partial r} \Big|_{r=1, s=-1} = 2(3)(2) = 12$
34. $\frac{\partial w}{\partial v} = \frac{\partial w}{\partial x} \frac{\partial x}{\partial v} + \frac{\partial w}{\partial y} \frac{\partial y}{\partial v} + \frac{\partial w}{\partial z} \frac{\partial z}{\partial v} = y\left(\frac{2v}{u}\right) + x(1) + \left(\frac{1}{z}\right)(0) = (u+v)\left(\frac{2v}{u}\right) + \frac{v^2}{u} \Rightarrow \frac{\partial w}{\partial v} \Big|_{u=-1, v=2} = (1)\left(\frac{4}{-1}\right) + \left(\frac{4}{-1}\right) = -8$
35. $\frac{\partial w}{\partial v} = \frac{\partial w}{\partial x} \frac{\partial x}{\partial v} + \frac{\partial w}{\partial y} \frac{\partial y}{\partial v} = \left(2x - \frac{y}{x^2}\right)(-2) + \left(\frac{1}{x}\right)(1) = \left[2(u-2v+1) - \frac{2u+v-2}{(u-2v+1)^2}\right](-2) + \frac{1}{u-2v+1} \Rightarrow \frac{\partial w}{\partial v} \Big|_{u=0, v=0} = -7$
36. $\frac{\partial z}{\partial u} = \frac{\partial z}{\partial x} \frac{\partial x}{\partial u} + \frac{\partial z}{\partial y} \frac{\partial y}{\partial u} = (y \cos xy + \sin y)(2u) + (x \cos xy + x \cos y)(v)$
 $= \left[uv \cos(u^3 v + uv^3) + \sin uv\right](2u) + \left[(u^2 + v^2) \cos(u^3 v + uv^3) + (u^2 + v^2) \cos uv\right](v)$
 $\Rightarrow \frac{\partial z}{\partial u} \Big|_{u=0, v=1} = 0 + (\cos 0 + \cos 0)(1) = 2$
37. $\frac{\partial z}{\partial u} = \frac{dz}{dx} \frac{\partial x}{\partial u} = \left(\frac{5}{1+x^2}\right)e^u = \left[\frac{5}{1+(e^u + \ln v)^2}\right]e^u \Rightarrow \frac{\partial z}{\partial u} \Big|_{u=\ln 2, v=1} = \left[\frac{5}{1+(2)^2}\right](2) = 2$;
 $\frac{\partial z}{\partial v} = \frac{dz}{dx} \frac{\partial x}{\partial v} = \left(\frac{5}{1+x^2}\right)\left(\frac{1}{v}\right) = \left[\frac{5}{1+(e^u + \ln v)^2}\right]\left(\frac{1}{v}\right) \Rightarrow \frac{\partial z}{\partial v} \Big|_{u=\ln 2, v=1} = \left[\frac{5}{1+(2)^2}\right](1) = 1$
38. $\frac{\partial z}{\partial u} = \frac{dz}{dq} \frac{\partial q}{\partial u} = \left(\frac{1}{q}\right)\left(\frac{\sqrt{v+3}}{1+u^2}\right) = \left(\frac{1}{\sqrt{v+3} \tan^{-1} u}\right)\left(\frac{\sqrt{v+3}}{1+u^2}\right) = \frac{1}{(\tan^{-1} u)(1+u^2)} \Rightarrow \frac{\partial z}{\partial u} \Big|_{u=1, v=-2} = \frac{1}{(\tan^{-1} 1)(1+1^2)} = \frac{2}{\pi}$;
 $\frac{\partial z}{\partial v} = \frac{dz}{dq} \frac{\partial q}{\partial v} = \left(\frac{1}{q}\right)\left(\frac{\tan^{-1} u}{2\sqrt{v+3}}\right) = \left(\frac{1}{\sqrt{v+3} \tan^{-1} u}\right)\left(\frac{\tan^{-1} u}{2\sqrt{v+3}}\right) = \frac{1}{2(v+3)} \Rightarrow \frac{\partial z}{\partial v} \Big|_{u=1, v=-2} = \frac{1}{2}$
39. Let $x = s^3 + t^2 \Rightarrow w = f(s^3 + t^2) = f(x) \Rightarrow \frac{\partial w}{\partial s} = \frac{dw}{dx} \frac{\partial x}{\partial s} = f'(x) \cdot 3s^2 = 3s^2 e^{s^3+t^2}$,
 $\frac{\partial w}{\partial t} = \frac{dw}{dx} \frac{\partial x}{\partial t} = f'(x) \cdot 2t = 2t e^{s^3+t^2}$
40. Let $x = ts^2$ and $y = \frac{s}{t} \Rightarrow w = f\left(ts^2, \frac{s}{t}\right) = f(x, y)$
 $\Rightarrow \frac{\partial w}{\partial s} = \frac{\partial w}{\partial x} \frac{\partial x}{\partial s} + \frac{\partial w}{\partial y} \frac{\partial y}{\partial s} = f_x(x, y) \cdot 2ts + f_y(x, y) \cdot \frac{1}{t} = (ts^2)\left(\frac{s}{t}\right) \cdot 2ts + \frac{(ts^2)^2}{2} \cdot \frac{1}{t} = 2s^4 t + \frac{s^4 t}{2} = \frac{5s^4 t}{2}$;
 $\frac{\partial w}{\partial t} = \frac{\partial w}{\partial x} \frac{\partial x}{\partial t} + \frac{\partial w}{\partial y} \frac{\partial y}{\partial t} = f_x(x, y) \cdot s^2 + f_y(x, y) \cdot \frac{-s}{t^2} = (ts^2)\left(\frac{s}{t}\right) \cdot s^2 + \frac{(ts^2)^2}{2} \cdot \left(-\frac{s}{t^2}\right) = s^5 - \frac{s^5}{2} = \frac{s^5}{2}$

41. $V = IR \Rightarrow \frac{\partial V}{\partial I} = R$ and $\frac{\partial V}{\partial R} = I$; $\frac{dV}{dt} = \frac{\partial V}{\partial I} \frac{dI}{dt} + \frac{\partial V}{\partial R} \frac{dR}{dt} = R \frac{dI}{dt} + I \frac{dR}{dt} \Rightarrow -0.01$ volts/sec
 $= (600 \text{ ohms}) \frac{dI}{dt} + (0.04 \text{ amps})(0.5 \text{ ohms/sec}) \Rightarrow \frac{dI}{dt} = -0.00005$ amps/sec

42. $V = abc \Rightarrow \frac{dV}{dt} = \frac{\partial V}{\partial a} \frac{da}{dt} + \frac{\partial V}{\partial b} \frac{db}{dt} + \frac{\partial V}{\partial c} \frac{dc}{dt} = (bc) \frac{da}{dt} + (ac) \frac{db}{dt} + (ab) \frac{dc}{dt}$
 $\Rightarrow \left. \frac{dV}{dt} \right|_{a=1, b=2, c=3} = (2 \text{ m})(3 \text{ m})(1 \text{ m/sec}) + (1 \text{ m})(3 \text{ m})(1 \text{ m/sec}) + (1 \text{ m})(2 \text{ m})(-3 \text{ m/sec}) = 3 \text{ m}^3/\text{sec}$ and the
 volume is increasing; $S = 2ab + 2ac + 2bc \Rightarrow \frac{dS}{dt} = \frac{\partial S}{\partial a} \frac{da}{dt} + \frac{\partial S}{\partial b} \frac{db}{dt} + \frac{\partial S}{\partial c} \frac{dc}{dt} = 2(b+c) \frac{da}{dt} + 2(a+c) \frac{db}{dt} + 2(a+b) \frac{dc}{dt}$
 $\Rightarrow \left. \frac{dS}{dt} \right|_{a=1, b=2, c=3} = 2(5 \text{ m})(1 \text{ m/sec}) + 2(4 \text{ m})(1 \text{ m/sec}) + 2(3 \text{ m})(-3 \text{ m/sec}) = 0 \text{ m}^2/\text{sec}$ and the surface area is
 not changing; $D = \sqrt{a^2 + b^2 + c^2} \Rightarrow \frac{dD}{dt} = \frac{\partial D}{\partial a} \frac{da}{dt} + \frac{\partial D}{\partial b} \frac{db}{dt} + \frac{\partial D}{\partial c} \frac{dc}{dt} = \frac{1}{\sqrt{a^2 + b^2 + c^2}} \left(a \frac{da}{dt} + b \frac{db}{dt} + c \frac{dc}{dt} \right)$
 $\Rightarrow \left. \frac{dD}{dt} \right|_{a=1, b=2, c=3} = \left(\frac{1}{\sqrt{14} \text{ m}} \right) [(1 \text{ m})(1 \text{ m/sec}) + (2 \text{ m})(1 \text{ m/sec}) + (3 \text{ m})(-3 \text{ m/sec})] = -\frac{6}{\sqrt{14}} \text{ m/sec} < 0 \Rightarrow$ the
 diagonals are decreasing in length

43. $\frac{\partial f}{\partial x} = \frac{\partial f}{\partial u} \frac{\partial u}{\partial x} + \frac{\partial f}{\partial v} \frac{\partial v}{\partial x} + \frac{\partial f}{\partial w} \frac{\partial w}{\partial x} = \frac{\partial f}{\partial u} (1) + \frac{\partial f}{\partial v} (0) + \frac{\partial f}{\partial w} (-1) = \frac{\partial f}{\partial u} - \frac{\partial f}{\partial w}$,
 $\frac{\partial f}{\partial y} = \frac{\partial f}{\partial u} \frac{\partial u}{\partial y} + \frac{\partial f}{\partial v} \frac{\partial v}{\partial y} + \frac{\partial f}{\partial w} \frac{\partial w}{\partial y} = \frac{\partial f}{\partial u} (-1) + \frac{\partial f}{\partial v} (1) + \frac{\partial f}{\partial w} (0) = -\frac{\partial f}{\partial u} + \frac{\partial f}{\partial v}$, and
 $\frac{\partial f}{\partial z} = \frac{\partial f}{\partial u} \frac{\partial u}{\partial z} + \frac{\partial f}{\partial v} \frac{\partial v}{\partial z} + \frac{\partial f}{\partial w} \frac{\partial w}{\partial z} = \frac{\partial f}{\partial u} (0) + \frac{\partial f}{\partial v} (-1) + \frac{\partial f}{\partial w} (1) = -\frac{\partial f}{\partial v} + \frac{\partial f}{\partial w} \Rightarrow \frac{\partial f}{\partial x} + \frac{\partial f}{\partial y} + \frac{\partial f}{\partial z} = 0$

44. (a) $\frac{\partial w}{\partial r} = f_x \frac{\partial x}{\partial r} + f_y \frac{\partial y}{\partial r} = f_x \cos \theta + f_y \sin \theta$ and $\frac{\partial w}{\partial \theta} = f_x (-r \sin \theta) + f_y (r \cos \theta)$
 $\Rightarrow \frac{1}{r} \frac{\partial w}{\partial \theta} = -f_x \sin \theta + f_y \cos \theta$
 (b) $\frac{\partial w}{\partial r} \sin \theta = f_x \sin \theta \cos \theta + f_y \sin^2 \theta$ and $\left(\frac{\cos \theta}{r} \right) \frac{\partial w}{\partial \theta} = -f_x \sin \theta \cos \theta + f_y \cos^2 \theta$
 $\Rightarrow f_y = (\sin \theta) \frac{\partial w}{\partial r} + \left(\frac{\cos \theta}{r} \right) \frac{\partial w}{\partial \theta}$; then $\frac{\partial w}{\partial r} = f_x \cos \theta + \left[(\sin \theta) \frac{\partial w}{\partial r} + \left(\frac{\cos \theta}{r} \right) \frac{\partial w}{\partial \theta} \right] (\sin \theta)$
 $\Rightarrow f_x \cos \theta = \frac{\partial w}{\partial r} - (\sin^2 \theta) \frac{\partial w}{\partial r} - \left(\frac{\sin \theta \cos \theta}{r} \right) \frac{\partial w}{\partial \theta} = (1 - \sin^2 \theta) \frac{\partial w}{\partial r} - \left(\frac{\sin \theta \cos \theta}{r} \right) \frac{\partial w}{\partial \theta}$
 $\Rightarrow f_x = (\cos \theta) \frac{\partial w}{\partial r} - \left(\frac{\sin \theta}{r} \right) \frac{\partial w}{\partial \theta}$
 (c) $(f_x)^2 = (\cos^2 \theta) \left(\frac{\partial w}{\partial r} \right)^2 - \left(\frac{2 \sin \theta \cos \theta}{r} \right) \left(\frac{\partial w}{\partial r} \frac{\partial w}{\partial \theta} \right) + \left(\frac{\sin^2 \theta}{r^2} \right) \left(\frac{\partial w}{\partial \theta} \right)^2$ and
 $(f_y)^2 = (\sin^2 \theta) \left(\frac{\partial w}{\partial r} \right)^2 + \left(\frac{2 \sin \theta \cos \theta}{r} \right) \left(\frac{\partial w}{\partial r} \frac{\partial w}{\partial \theta} \right) + \left(\frac{\cos^2 \theta}{r^2} \right) \left(\frac{\partial w}{\partial \theta} \right)^2 \Rightarrow (f_x)^2 + (f_y)^2 = \left(\frac{\partial w}{\partial r} \right)^2 + \frac{1}{r^2} \left(\frac{\partial w}{\partial \theta} \right)^2$

45. $w_x = \frac{\partial w}{\partial x} = \frac{\partial w}{\partial u} \frac{\partial u}{\partial x} + \frac{\partial w}{\partial v} \frac{\partial v}{\partial x} = x \frac{\partial w}{\partial u} + y \frac{\partial w}{\partial v} \Rightarrow w_{xx} = \frac{\partial w}{\partial u} + x \frac{\partial}{\partial x} \left(\frac{\partial w}{\partial u} \right) + y \frac{\partial}{\partial x} \left(\frac{\partial w}{\partial v} \right)$
 $= \frac{\partial w}{\partial u} + x \left(\frac{\partial^2 w}{\partial u^2} \frac{\partial u}{\partial x} + \frac{\partial^2 w}{\partial v \partial u} \frac{\partial v}{\partial x} \right) + y \left(\frac{\partial^2 w}{\partial u \partial v} \frac{\partial u}{\partial x} + \frac{\partial^2 w}{\partial v^2} \frac{\partial v}{\partial x} \right) = \frac{\partial w}{\partial u} + x \left(x \frac{\partial^2 w}{\partial u^2} + y \frac{\partial^2 w}{\partial v \partial u} \right) + y \left(x \frac{\partial^2 w}{\partial u \partial v} + y \frac{\partial^2 w}{\partial v^2} \right)$
 $= \frac{\partial w}{\partial u} + x^2 \frac{\partial^2 w}{\partial u^2} + 2xy \frac{\partial^2 w}{\partial v \partial u} + y^2 \frac{\partial^2 w}{\partial v^2}$;
 $w_y = \frac{\partial w}{\partial y} = \frac{\partial w}{\partial u} \frac{\partial u}{\partial y} + \frac{\partial w}{\partial v} \frac{\partial v}{\partial y} = -y \frac{\partial w}{\partial u} + x \frac{\partial w}{\partial v} \Rightarrow w_{yy} = -\frac{\partial w}{\partial u} - y \left(\frac{\partial^2 w}{\partial u^2} \frac{\partial u}{\partial y} + \frac{\partial^2 w}{\partial v \partial u} \frac{\partial v}{\partial y} \right) + x \left(\frac{\partial^2 w}{\partial u \partial v} \frac{\partial u}{\partial y} + \frac{\partial^2 w}{\partial v^2} \frac{\partial v}{\partial y} \right)$
 $= -\frac{\partial w}{\partial u} - y \left(-y \frac{\partial^2 w}{\partial u^2} + x \frac{\partial^2 w}{\partial v \partial u} \right) + x \left(-y \frac{\partial^2 w}{\partial u \partial v} + x \frac{\partial^2 w}{\partial v^2} \right) = -\frac{\partial w}{\partial u} + y^2 \frac{\partial^2 w}{\partial u^2} - 2xy \frac{\partial^2 w}{\partial v \partial u} + x^2 \frac{\partial^2 w}{\partial v^2}$; thus
 $w_{xx} + w_{yy} = \left(x^2 + y^2 \right) \frac{\partial^2 w}{\partial u^2} + \left(x^2 + y^2 \right) \frac{\partial^2 w}{\partial v^2} = \left(x^2 + y^2 \right) (w_{uu} + w_{vv}) = 0$, since $w_{uu} + w_{vv} = 0$

46. $\frac{\partial w}{\partial x} = f'(u)(1) + g'(v)(1) = f'(u) + g'(v) \Rightarrow w_{xx} = f''(u)(1) + g''(v)(1) = f''(u) + g''(v);$
 $\frac{\partial w}{\partial y} = f'(u)(i) + g'(v)(-i) \Rightarrow w_{yy} = f''(u)(i^2) + g''(v)(i^2) = -f''(u) - g''(v) \Rightarrow w_{xx} + w_{yy} = 0$
47. $f_x(x, y, z) = \cos t, f_y(x, y, z) = \sin t, \text{ and } f_z(x, y, z) = t^2 + t - 2 \Rightarrow \frac{df}{dt} = \frac{\partial f}{\partial x} \frac{dx}{dt} + \frac{\partial f}{\partial y} \frac{dy}{dt} + \frac{\partial f}{\partial z} \frac{dz}{dt}$
 $= (\cos t)(-\sin t) + (\sin t)(\cos t) + (t^2 + t - 2)(1) = t^2 + t - 2; \frac{df}{dt} = 0 \Rightarrow t^2 + t - 2 = 0 \Rightarrow t = -2 \text{ or } t = 1;$
 $t = -2 \Rightarrow x = \cos(-2), y = \sin(-2), z = -2 \text{ for the point } (\cos(-2), \sin(-2), -2);$
 $t = 1 \Rightarrow x = \cos 1, y = \sin 1, z = 1 \text{ for the point } (\cos 1, \sin 1, 1)$
48. $\frac{dw}{dt} = \frac{\partial w}{\partial x} \frac{dx}{dt} + \frac{\partial w}{\partial y} \frac{dy}{dt} + \frac{\partial w}{\partial z} \frac{dz}{dt} = (2xe^{2y} \cos 3z)(-\sin t) + (2x^2e^{2y} \cos 3z)\left(\frac{1}{t+2}\right) + (-3x^2e^{2y} \sin 3z)(1)$
 $= -2xe^{2y} \cos 3z \sin t + \frac{2x^2e^{2y} \cos 3z}{t+2} - 3x^2e^{2y} \sin 3z; \text{ at the point on the curve } z = 0 \Rightarrow t = z = 0$
 $\Rightarrow \left. \frac{dw}{dt} \right|_{(1, \ln 2, 0)} = 0 + \frac{2(1)^2(4)(1)}{2} - 0 = 4$
49. (a) $\frac{\partial T}{\partial x} = 8x - 4y \text{ and } \frac{\partial T}{\partial y} = 8y - 4x \Rightarrow \frac{dT}{dt} = \frac{\partial T}{\partial x} \frac{dx}{dt} + \frac{\partial T}{\partial y} \frac{dy}{dt} = (8x - 4y)(-\sin t) + (8y - 4x)(\cos t)$
 $= (8 \cos t - 4 \sin t)(-\sin t) + (8 \sin t - 4 \cos t)(\cos t) = 4 \sin^2 t - 4 \cos^2 t \Rightarrow \frac{d^2T}{dt^2} = 16 \sin t \cos t;$
 $\frac{dT}{dt} = 0 \Rightarrow 4 \sin^2 t - 4 \cos^2 t = 0 \Rightarrow \sin^2 t = \cos^2 t \Rightarrow \sin t = \cos t \text{ or } \sin t = -\cos t \Rightarrow t = \frac{\pi}{4}, \frac{5\pi}{4}, \frac{3\pi}{4}, \frac{7\pi}{4} \text{ on}$
the interval $0 \leq t \leq 2\pi;$
 $\left. \frac{d^2T}{dt^2} \right|_{t=\frac{\pi}{4}} = 16 \sin \frac{\pi}{4} \cos \frac{\pi}{4} > 0 \Rightarrow T \text{ has a minimum at } (x, y) = \left(\frac{\sqrt{2}}{2}, \frac{\sqrt{2}}{2}\right);$
 $\left. \frac{d^2T}{dt^2} \right|_{t=\frac{3\pi}{4}} = 16 \sin \frac{3\pi}{4} \cos \frac{3\pi}{4} < 0 \Rightarrow T \text{ has a maximum at } (x, y) = \left(-\frac{\sqrt{2}}{2}, \frac{\sqrt{2}}{2}\right);$
 $\left. \frac{d^2T}{dt^2} \right|_{t=\frac{5\pi}{4}} = 16 \sin \frac{5\pi}{4} \cos \frac{5\pi}{4} > 0 \Rightarrow T \text{ has a minimum at } (x, y) = \left(-\frac{\sqrt{2}}{2}, -\frac{\sqrt{2}}{2}\right);$
 $\left. \frac{d^2T}{dt^2} \right|_{t=\frac{7\pi}{4}} = 16 \sin \frac{7\pi}{4} \cos \frac{7\pi}{4} < 0 \Rightarrow T \text{ has a maximum at } (x, y) = \left(\frac{\sqrt{2}}{2}, -\frac{\sqrt{2}}{2}\right)$
- (b) $T = 4x^2 - 4xy + 4y^2 \Rightarrow \frac{\partial T}{\partial x} = 8x - 4y, \text{ and } \frac{\partial T}{\partial y} = 8y - 4x \text{ so the extreme values occur at the four points}$
found in part (a): $T\left(-\frac{\sqrt{2}}{2}, \frac{\sqrt{2}}{2}\right) = T\left(\frac{\sqrt{2}}{2}, -\frac{\sqrt{2}}{2}\right) = 4\left(\frac{1}{2}\right) - 4\left(-\frac{1}{2}\right) + 4\left(\frac{1}{2}\right) = 6, \text{ the maximum and}$
 $T\left(\frac{\sqrt{2}}{2}, \frac{\sqrt{2}}{2}\right) = T\left(-\frac{\sqrt{2}}{2}, -\frac{\sqrt{2}}{2}\right) = 4\left(\frac{1}{2}\right) - 4\left(\frac{1}{2}\right) + 4\left(\frac{1}{2}\right) = 2, \text{ the minimum}$
50. (a) $\frac{\partial T}{\partial x} = y \text{ and } \frac{\partial T}{\partial y} = x \Rightarrow \frac{dT}{dt} = \frac{\partial T}{\partial x} \frac{dx}{dt} + \frac{\partial T}{\partial y} \frac{dy}{dt} = y(-2\sqrt{2} \sin t) + x(\sqrt{2} \cos t)$
 $= (\sqrt{2} \sin t)(-2\sqrt{2} \sin t) + (2\sqrt{2} \cos t)(\sqrt{2} \cos t) = -4 \sin^2 t + 4 \cos^2 t = -4 \sin^2 t + 4(1 - \sin^2 t)$
 $= 4 - 8 \sin^2 t \Rightarrow \frac{d^2T}{dt^2} = -16 \sin t \cos t; \frac{dT}{dt} = 0 \Rightarrow 4 - 8 \sin^2 t = 0 \Rightarrow \sin^2 t = \frac{1}{2} \Rightarrow \sin t = \pm \frac{1}{\sqrt{2}}$
 $\Rightarrow t = \frac{\pi}{4}, \frac{3\pi}{4}, \frac{5\pi}{4}, \frac{7\pi}{4} \text{ on the interval } 0 \leq t \leq 2\pi;$
 $\left. \frac{d^2T}{dt^2} \right|_{t=\frac{\pi}{4}} = -8 \sin 2\left(\frac{\pi}{4}\right) = -8 \Rightarrow T \text{ has a maximum at } (x, y) = (2, 1);$

$$\left. \frac{d^2T}{dt^2} \right|_{t=\frac{3\pi}{4}} = -8 \sin 2\left(\frac{3\pi}{4}\right) = 8 \Rightarrow T \text{ has a minimum at } (x, y) = (-2, 1);$$

$$\left. \frac{d^2T}{dt^2} \right|_{t=\frac{5\pi}{4}} = -8 \sin 2\left(\frac{5\pi}{4}\right) = -8 \Rightarrow T \text{ has a maximum at } (x, y) = (-2, -1);$$

$$\left. \frac{d^2T}{dt^2} \right|_{t=\frac{7\pi}{4}} = -8 \sin 2\left(\frac{7\pi}{4}\right) = 8 \Rightarrow T \text{ has a minimum at } (x, y) = (2, -1)$$

- (b) $T = xy - 2 \Rightarrow \frac{\partial T}{\partial x} = y$ and $\frac{\partial T}{\partial y} = x$ so the extreme values occur at the four points found in part (a):
 $T(2, 1) = T(-2, -1) = 0$, the maximum and $T(-2, 1) = T(2, -1) = -4$, the minimum

51. $G(u, x) = \int_a^u g(t, x) dt$ where $u = f(x) \Rightarrow \frac{dG}{dx} = \frac{\partial G}{\partial u} \frac{du}{dx} + \frac{\partial G}{\partial x} \frac{dx}{dx} = g(u, x)f'(x) + \int_a^u g_x(t, x) dt$; thus

$$F(x) = \int_0^{x^2} \sqrt{t^4 + x^3} dt \Rightarrow F'(x) = \sqrt{(x^2)^4 + x^3} (2x) + \int_0^{x^2} \frac{\partial}{\partial x} \sqrt{t^4 + x^3} dt = 2x\sqrt{x^8 + x^3} + \int_0^{x^2} \frac{3x^2}{2\sqrt{t^4 + x^3}} dt$$

52. Using the result in Exercise 51, $F(x) = \int_{x^2}^1 \sqrt{t^3 + x^2} dt = -\int_1^{x^2} \sqrt{t^3 + x^2} dt$

$$\Rightarrow F'(x) = \left[-\sqrt{(x^2)^3 + x^2} x^2 - \int_1^{x^2} \frac{\partial}{\partial x} \sqrt{t^3 + x^2} dt \right] = -x^2 \sqrt{x^6 + x^2} + \int_{x^2}^1 \frac{x}{\sqrt{t^3 + x^2}} dt$$

14.5 DIRECTIONAL DERIVATIVES AND GRADIENT VECTORS

1. $\frac{\partial f}{\partial x} = -1, \frac{\partial f}{\partial y} = 1 \Rightarrow \nabla f = -\mathbf{i} + \mathbf{j}; f(2, 1) = -1$
 $\Rightarrow -1 = y - x$ is the level curve

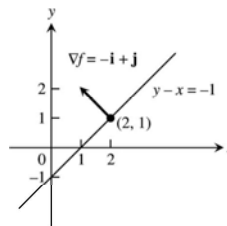

2. $\frac{\partial f}{\partial x} = \frac{2x}{x^2 + y^2} \Rightarrow \frac{\partial f}{\partial x}(1, 1) = 1; \frac{\partial f}{\partial y} = \frac{2y}{x^2 + y^2} \Rightarrow \frac{\partial f}{\partial y}(1, 1) = 1$
 $\Rightarrow \nabla f = \mathbf{i} + \mathbf{j}; f(1, 1) = \ln 2 \Rightarrow \ln 2 = \ln(x^2 + y^2)$
 $\Rightarrow 2 = x^2 + y^2$ is the level curve

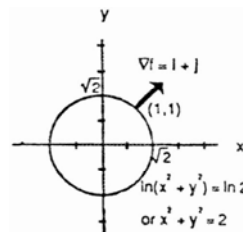

$$3. \frac{\partial g}{\partial x} = y^2 \Rightarrow \frac{\partial g}{\partial x}(2, -1) = 1;$$

$$\frac{\partial g}{\partial y} = 2xy \Rightarrow \frac{\partial g}{\partial y}(2, -1) = -4 \Rightarrow \nabla g = \mathbf{i} - 4\mathbf{j};$$

$$g(2, -1) = 2 \Rightarrow x = \frac{2}{y^2} \text{ is the level curve}$$

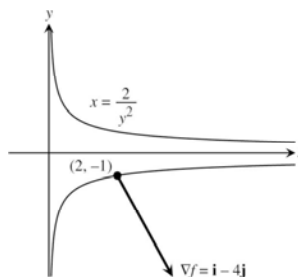

$$4. \frac{\partial g}{\partial x} = x \Rightarrow \frac{\partial g}{\partial x}(\sqrt{2}, 1) = \sqrt{2};$$

$$\frac{\partial g}{\partial y} = -y \Rightarrow \frac{\partial g}{\partial y}(\sqrt{2}, 1) = -1 \Rightarrow \nabla g = \sqrt{2}\mathbf{i} - \mathbf{j};$$

$$g(\sqrt{2}, 1) = \frac{1}{2} \Rightarrow \frac{1}{2} = \frac{x^2}{2} - \frac{y^2}{2} \text{ or } 1 = x^2 - y^2 \text{ is the level curve}$$

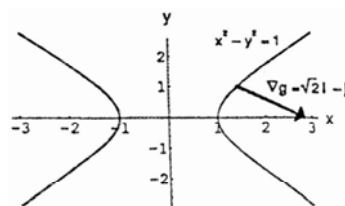

$$5. \frac{\partial f}{\partial x} = \frac{1}{\sqrt{2x+3y}} \Rightarrow \frac{\partial f}{\partial x}(-1, 2) = \frac{1}{2};$$

$$\frac{\partial f}{\partial y} = \frac{3}{2\sqrt{2x+3y}} \Rightarrow \frac{\partial f}{\partial y}(-1, 2) = \frac{3}{4} \Rightarrow \nabla f = \frac{1}{2}\mathbf{i} + \frac{3}{4}\mathbf{j};$$

$$f(-1, 2) = 2 \Rightarrow 4 = 2x + 3y \text{ is the level curve}$$

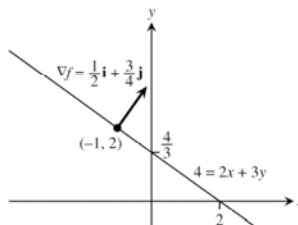

$$6. \frac{\partial f}{\partial x} = \frac{y}{2y^2\sqrt{x} + 2x^{3/2}} \Rightarrow \frac{\partial f}{\partial x}(4, -2) = -\frac{1}{16};$$

$$\frac{\partial f}{\partial y} = -\frac{\sqrt{x}}{2y^2 + x} \Rightarrow \frac{\partial f}{\partial y}(4, -2) = -\frac{1}{4} \Rightarrow \nabla f = -\frac{1}{16}\mathbf{i} - \frac{1}{4}\mathbf{j};$$

$$f(4, -2) = -\frac{\pi}{4} \Rightarrow y = -\sqrt{x} \text{ is the level curve}$$

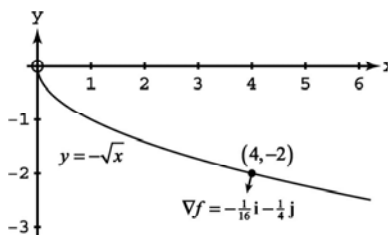

$$7. \frac{\partial f}{\partial x} = 2x + \frac{z}{x} \Rightarrow \frac{\partial f}{\partial x}(1, 1, 1) = 3; \frac{\partial f}{\partial y} = 2y \Rightarrow \frac{\partial f}{\partial y}(1, 1, 1) = 2; \frac{\partial f}{\partial z} = -4z + \ln x \Rightarrow \frac{\partial f}{\partial z}(1, 1, 1) = -4; \text{ thus}$$

$$\nabla f = 3\mathbf{i} + 2\mathbf{j} - 4\mathbf{k}$$

$$8. \frac{\partial f}{\partial x} = -6xz + \frac{z}{x^2z^2+1} \Rightarrow \frac{\partial f}{\partial x}(1, 1, 1) = -\frac{11}{2}; \frac{\partial f}{\partial y} = -6yz \Rightarrow \frac{\partial f}{\partial y}(1, 1, 1) = -6; \frac{\partial f}{\partial z} = 6z^2 - 3(x^2 + y^2) + \frac{x}{x^2z^2+1}$$

$$\Rightarrow \frac{\partial f}{\partial z}(1, 1, 1) = \frac{1}{2}; \text{ thus } \nabla f = -\frac{11}{2}\mathbf{i} - 6\mathbf{j} + \frac{1}{2}\mathbf{k}$$

$$9. \frac{\partial f}{\partial x} = -\frac{x}{(x^2+y^2+z^2)^{3/2}} + \frac{1}{x} \Rightarrow \frac{\partial f}{\partial x}(-1, 2, -2) = -\frac{26}{27}; \frac{\partial f}{\partial y} = -\frac{y}{(x^2+y^2+z^2)^{3/2}} + \frac{1}{y} \Rightarrow \frac{\partial f}{\partial y}(-1, 2, -2) = \frac{23}{54};$$

$$\frac{\partial f}{\partial z} = -\frac{z}{(x^2+y^2+z^2)^{3/2}} + \frac{1}{z} \Rightarrow \frac{\partial f}{\partial z}(-1, 2, -2) = -\frac{23}{54}; \text{ thus } \nabla f = -\frac{26}{27}\mathbf{i} + \frac{23}{54}\mathbf{j} - \frac{23}{54}\mathbf{k}$$

$$10. \frac{\partial f}{\partial x} = e^{x+y} \cos z + \frac{y+1}{\sqrt{1-x^2}} \Rightarrow \frac{\partial f}{\partial x} \left(0, 0, \frac{\pi}{6}\right) = \frac{\sqrt{3}}{2} + 1; \quad \frac{\partial f}{\partial y} = e^{x+y} \cos z + \sin^{-1} x \Rightarrow \frac{\partial f}{\partial y} \left(0, 0, \frac{\pi}{6}\right) = \frac{\sqrt{3}}{2};$$

$$\frac{\partial f}{\partial z} = -e^{x+y} \sin z \Rightarrow \frac{\partial f}{\partial z} \left(0, 0, \frac{\pi}{6}\right) = -\frac{1}{2}; \quad \text{thus } \nabla f = \left(\frac{\sqrt{3}+2}{2}\right)\mathbf{i} + \frac{\sqrt{3}}{2}\mathbf{j} - \frac{1}{2}\mathbf{k}$$

$$11. \mathbf{u} = \frac{\mathbf{A}}{|\mathbf{A}|} = \frac{4\mathbf{i}+3\mathbf{j}}{\sqrt{4^2+3^2}} = \frac{4}{5}\mathbf{i} + \frac{3}{5}\mathbf{j}; \quad f_x(x, y) = 2y \Rightarrow f_x(5, 5) = 10; \quad f_y(x, y) = 2x - 6y \Rightarrow f_y(5, 5) = -20$$

$$\Rightarrow \nabla f = 10\mathbf{i} - 20\mathbf{j} \Rightarrow (D_{\mathbf{u}}f)_{P_0} = \nabla f \cdot \mathbf{u} = 10\left(\frac{4}{5}\right) - 20\left(\frac{3}{5}\right) = -4$$

$$12. \mathbf{u} = \frac{\mathbf{A}}{|\mathbf{A}|} = \frac{3\mathbf{i}-4\mathbf{j}}{\sqrt{3^2+(-4)^2}} = \frac{3}{5}\mathbf{i} - \frac{4}{5}\mathbf{j}; \quad f_x(x, y) = 4x \Rightarrow f_x(-1, 1) = -4; \quad f_y(x, y) = 2y \Rightarrow f_y(-1, 1) = 2$$

$$\Rightarrow \nabla f = -4\mathbf{i} + 2\mathbf{j} \Rightarrow (D_{\mathbf{u}}f)_{P_0} = \nabla f \cdot \mathbf{u} = -\frac{12}{5} - \frac{8}{5} = -4$$

$$13. \mathbf{u} = \frac{\mathbf{A}}{|\mathbf{A}|} = \frac{12\mathbf{i}+5\mathbf{j}}{\sqrt{12^2+5^2}} = \frac{12}{13}\mathbf{i} + \frac{5}{13}\mathbf{j}; \quad g_x(x, y) = \frac{y^2+2}{(xy+2)^2} \Rightarrow g_x(1, -1) = 3; \quad g_y(x, y) = -\frac{x^2+2}{(xy+2)^2} \Rightarrow g_y(1, -1) = -3$$

$$\Rightarrow \nabla g = 3\mathbf{i} - 3\mathbf{j} \Rightarrow (D_{\mathbf{u}}g)_{P_0} = \nabla g \cdot \mathbf{u} = \frac{36}{13} - \frac{15}{13} = \frac{21}{13}$$

$$14. \mathbf{u} = \frac{\mathbf{A}}{|\mathbf{A}|} = \frac{3\mathbf{i}-2\mathbf{j}}{\sqrt{3^2+(-2)^2}} = \frac{3}{\sqrt{13}}\mathbf{i} - \frac{2}{\sqrt{13}}\mathbf{j}; \quad h_x(x, y) = \frac{\left(\frac{-y}{x^2}\right)}{\left(\frac{y}{x}\right)^2+1} + \frac{\left(\frac{y}{2}\right)\sqrt{3}}{\sqrt{1-\left(\frac{x^2y^2}{4}\right)}} \Rightarrow h_x(1, 1) = \frac{1}{2};$$

$$h_y(x, y) = \frac{\left(\frac{1}{x}\right)}{\left(\frac{y}{x}\right)^2+1} + \frac{\left(\frac{x}{2}\right)\sqrt{3}}{\sqrt{1-\left(\frac{x^2y^2}{4}\right)}} \Rightarrow h_y(1, 1) = \frac{3}{2} \Rightarrow \nabla h = \frac{1}{2}\mathbf{i} + \frac{3}{2}\mathbf{j} \Rightarrow (D_{\mathbf{u}}h)_{P_0} = \nabla h \cdot \mathbf{u} = \frac{3}{2\sqrt{13}} - \frac{6}{2\sqrt{13}} = -\frac{3}{2\sqrt{13}}$$

$$15. \mathbf{u} = \frac{\mathbf{A}}{|\mathbf{A}|} = \frac{3\mathbf{i}+6\mathbf{j}-2\mathbf{k}}{\sqrt{3^2+6^2+(-2)^2}} = \frac{3}{7}\mathbf{i} + \frac{6}{7}\mathbf{j} - \frac{2}{7}\mathbf{k}; \quad f_x(x, y, z) = y + z \Rightarrow f_x(1, -1, 2) = 1;$$

$$f_y(x, y, z) = x + z \Rightarrow f_y(1, -1, 2) = 3; \quad f_z(x, y, z) = y + x \Rightarrow f_z(1, -1, 2) = 0 \Rightarrow \nabla f = \mathbf{i} + 3\mathbf{j}$$

$$\Rightarrow (D_{\mathbf{u}}f)_{P_0} = \nabla f \cdot \mathbf{u} = \frac{3}{7} + \frac{18}{7} = 3$$

$$16. \mathbf{u} = \frac{\mathbf{A}}{|\mathbf{A}|} = \frac{\mathbf{i}+\mathbf{j}+\mathbf{k}}{\sqrt{1^2+1^2+1^2}} = \frac{1}{\sqrt{3}}\mathbf{i} + \frac{1}{\sqrt{3}}\mathbf{j} + \frac{1}{\sqrt{3}}\mathbf{k}; \quad f_x(x, y, z) = 2x \Rightarrow f_x(1, 1, 1) = 2; \quad f_y(x, y, z) = 4y \Rightarrow f_y(1, 1, 1) = 4;$$

$$f_z(x, y, z) = -6z \Rightarrow f_z(1, 1, 1) = -6 \Rightarrow \nabla f = 2\mathbf{i} + 4\mathbf{j} - 6\mathbf{k} \Rightarrow (D_{\mathbf{u}}f)_{P_0} = \nabla f \cdot \mathbf{u} = 2\left(\frac{1}{\sqrt{3}}\right) + 4\left(\frac{1}{\sqrt{3}}\right) - 6\left(\frac{1}{\sqrt{3}}\right) = 0$$

$$17. \mathbf{u} = \frac{\mathbf{A}}{|\mathbf{A}|} = \frac{2\mathbf{i}+\mathbf{j}-2\mathbf{k}}{\sqrt{2^2+1^2+(-2)^2}} = \frac{2}{3}\mathbf{i} + \frac{1}{3}\mathbf{j} - \frac{2}{3}\mathbf{k}; \quad g_x(x, y, z) = 3e^x \cos yz \Rightarrow g_x(0, 0, 0) = 3;$$

$$g_y(x, y, z) = -3ze^x \sin yz \Rightarrow g_y(0, 0, 0) = 0; \quad g_z(x, y, z) = -3ye^x \sin yz \Rightarrow g_z(0, 0, 0) = 0 \Rightarrow \nabla g = 3\mathbf{i}$$

$$\Rightarrow (D_{\mathbf{u}}g)_{P_0} = \nabla g \cdot \mathbf{u} = 2$$

$$18. \mathbf{u} = \frac{\mathbf{A}}{|\mathbf{A}|} = \frac{\mathbf{i}+2\mathbf{j}+2\mathbf{k}}{\sqrt{1^2+2^2+2^2}} = \frac{1}{3}\mathbf{i} + \frac{2}{3}\mathbf{j} + \frac{2}{3}\mathbf{k}; \quad h_x(x, y, z) = -y \sin xy + \frac{1}{x} \Rightarrow h_x\left(1, 0, \frac{1}{2}\right) = 1;$$

$$h_y(x, y, z) = -x \sin xy + ze^{yz} \Rightarrow h_y\left(1, 0, \frac{1}{2}\right) = \frac{1}{2}; \quad h_z(x, y, z) = ye^{yz} + \frac{1}{z} \Rightarrow h_z\left(1, 0, \frac{1}{2}\right) = 2 \Rightarrow \nabla h = \mathbf{i} + \frac{1}{2}\mathbf{j} + 2\mathbf{k}$$

$$\Rightarrow (D_{\mathbf{u}}h)_P = \nabla h \cdot \mathbf{u} = \frac{1}{3} + \frac{1}{3} + \frac{4}{3} = 2$$

19. $\nabla f = (2x + y)\mathbf{i} + (x + 2y)\mathbf{j} \Rightarrow \nabla f(-1, 1) = -\mathbf{i} + \mathbf{j} \Rightarrow \mathbf{u} = \frac{\nabla f}{|\nabla f|} = \frac{-\mathbf{i} + \mathbf{j}}{\sqrt{(-1)^2 + 1^2}} = -\frac{1}{\sqrt{2}}\mathbf{i} + \frac{1}{\sqrt{2}}\mathbf{j}$; f increases most rapidly in the direction $\mathbf{u} = -\frac{1}{\sqrt{2}}\mathbf{i} + \frac{1}{\sqrt{2}}\mathbf{j}$ and decreases most rapidly in the direction $-\mathbf{u} = \frac{1}{\sqrt{2}}\mathbf{i} - \frac{1}{\sqrt{2}}\mathbf{j}$; $(D_{\mathbf{u}}f)_{P_0} = \nabla f \cdot \mathbf{u} = |\nabla f| = \sqrt{2}$ and $(D_{-\mathbf{u}}f)_{P_0} = -\sqrt{2}$
20. $\nabla f = (2xy + ye^{xy} \sin y)\mathbf{i} + (x^2 + xe^{xy} \sin y + e^{xy} \cos y)\mathbf{j} \Rightarrow \nabla f(1, 0) = 2\mathbf{j} \Rightarrow \mathbf{u} = \frac{\nabla f}{|\nabla f|} = \mathbf{j}$; f increases most rapidly in the direction $\mathbf{u} = \mathbf{j}$ and decreases most rapidly in the direction $-\mathbf{u} = -\mathbf{j}$; $(D_{\mathbf{u}}f)_{P_0} = \nabla f \cdot \mathbf{u} = |\nabla f| = 2$ and $(D_{-\mathbf{u}}f)_{P_0} = -2$
21. $\nabla f = \frac{1}{y}\mathbf{i} - \left(\frac{x}{y^2} + z\right)\mathbf{j} - y\mathbf{k} \Rightarrow \nabla f(4, 1, 1) = \mathbf{i} - 5\mathbf{j} - \mathbf{k} \Rightarrow \mathbf{u} = \frac{\nabla f}{|\nabla f|} = \frac{\mathbf{i} - 5\mathbf{j} - \mathbf{k}}{\sqrt{1^2 + (-5)^2 + (-1)^2}} = \frac{1}{3\sqrt{3}}\mathbf{i} - \frac{5}{3\sqrt{3}}\mathbf{j} - \frac{1}{3\sqrt{3}}\mathbf{k}$; f increases most rapidly in the direction of $\mathbf{u} = \frac{1}{3\sqrt{3}}\mathbf{i} - \frac{5}{3\sqrt{3}}\mathbf{j} - \frac{1}{3\sqrt{3}}\mathbf{k}$ and decreases most rapidly in the direction $-\mathbf{u} = -\frac{1}{3\sqrt{3}}\mathbf{i} + \frac{5}{3\sqrt{3}}\mathbf{j} + \frac{1}{3\sqrt{3}}\mathbf{k}$; $(D_{\mathbf{u}}f)_{P_0} = \nabla f \cdot \mathbf{u} = |\nabla f| = 3\sqrt{3}$ and $(D_{-\mathbf{u}}f)_{P_0} = -3\sqrt{3}$
22. $\nabla g = e^y\mathbf{i} + xe^y\mathbf{j} + 2z\mathbf{k} \Rightarrow \nabla g\left(1, \ln 2, \frac{1}{2}\right) = 2\mathbf{i} + 2\mathbf{j} + \mathbf{k} \Rightarrow \mathbf{u} = \frac{\nabla g}{|\nabla g|} = \frac{2\mathbf{i} + 2\mathbf{j} + \mathbf{k}}{\sqrt{2^2 + 2^2 + 1^2}} = \frac{2}{3}\mathbf{i} + \frac{2}{3}\mathbf{j} + \frac{1}{3}\mathbf{k}$; g increases most rapidly in the direction $\mathbf{u} = \frac{2}{3}\mathbf{i} + \frac{2}{3}\mathbf{j} + \frac{1}{3}\mathbf{k}$ and decreases most rapidly in the direction $-\mathbf{u} = -\frac{2}{3}\mathbf{i} - \frac{2}{3}\mathbf{j} - \frac{1}{3}\mathbf{k}$; $(D_{\mathbf{u}}g)_{P_0} = \nabla g \cdot \mathbf{u} = |\nabla g| = 3$ and $(D_{-\mathbf{u}}g)_{P_0} = -3$
23. $\nabla f = \left(\frac{1}{x} + \frac{1}{x}\right)\mathbf{i} + \left(\frac{1}{y} + \frac{1}{y}\right)\mathbf{j} + \left(\frac{1}{z} + \frac{1}{z}\right)\mathbf{k} \Rightarrow \nabla f(1, 1, 1) = 2\mathbf{i} + 2\mathbf{j} + 2\mathbf{k} \Rightarrow \mathbf{u} = \frac{\nabla f}{|\nabla f|} = \frac{1}{\sqrt{3}}\mathbf{i} + \frac{1}{\sqrt{3}}\mathbf{j} + \frac{1}{\sqrt{3}}\mathbf{k}$; f increases most rapidly in the direction $\mathbf{u} = \frac{1}{\sqrt{3}}\mathbf{i} + \frac{1}{\sqrt{3}}\mathbf{j} + \frac{1}{\sqrt{3}}\mathbf{k}$ and decreases most rapidly in the direction $-\mathbf{u} = -\frac{1}{\sqrt{3}}\mathbf{i} - \frac{1}{\sqrt{3}}\mathbf{j} - \frac{1}{\sqrt{3}}\mathbf{k}$; $(D_{\mathbf{u}}f)_{P_0} = \nabla f \cdot \mathbf{u} = |\nabla f| = 2\sqrt{3}$ and $(D_{-\mathbf{u}}f)_{P_0} = -2\sqrt{3}$
24. $\nabla h = \left(\frac{2x}{x^2 + y^2 - 1}\right)\mathbf{i} + \left(\frac{2y}{x^2 + y^2 - 1}\right)\mathbf{j} + 6\mathbf{k} \Rightarrow \nabla h(1, 1, 0) = 2\mathbf{i} + 3\mathbf{j} + 6\mathbf{k} \Rightarrow \mathbf{u} = \frac{\nabla h}{|\nabla h|} = \frac{2\mathbf{i} + 3\mathbf{j} + 6\mathbf{k}}{\sqrt{2^2 + 3^2 + 6^2}} = \frac{2}{7}\mathbf{i} + \frac{3}{7}\mathbf{j} + \frac{6}{7}\mathbf{k}$; h increases most rapidly in the direction $\mathbf{u} = \frac{2}{7}\mathbf{i} + \frac{3}{7}\mathbf{j} + \frac{6}{7}\mathbf{k}$ and decreases most rapidly in the direction $-\mathbf{u} = -\frac{2}{7}\mathbf{i} - \frac{3}{7}\mathbf{j} - \frac{6}{7}\mathbf{k}$; $(D_{\mathbf{u}}h)_{P_0} = \nabla h \cdot \mathbf{u} = |\nabla h| = 7$ and $(D_{-\mathbf{u}}h)_{P_0} = -7$
25. $\nabla f = 2x\mathbf{i} + 2y\mathbf{j} \Rightarrow \nabla f(\sqrt{2}, \sqrt{2}) = 2\sqrt{2}\mathbf{i} + 2\sqrt{2}\mathbf{j}$
 \Rightarrow Tangent line: $2\sqrt{2}(x - \sqrt{2}) + 2\sqrt{2}(y - \sqrt{2}) = 0$
 $\Rightarrow \sqrt{2}x + \sqrt{2}y = 4$

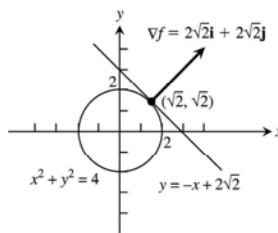

26. $\nabla f = 2x\mathbf{i} - \mathbf{j} \Rightarrow \nabla f(\sqrt{2}, 1) = 2\sqrt{2}\mathbf{i} - \mathbf{j}$
 \Rightarrow Tangent line: $2\sqrt{2}(x - \sqrt{2}) - (y - 1) = 0$
 $\Rightarrow y = 2\sqrt{2}x - 3$

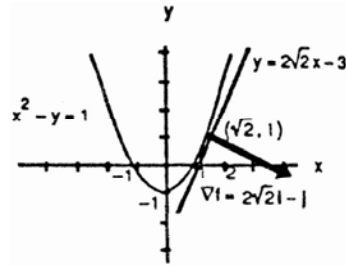

27. $\nabla f = y\mathbf{i} + x\mathbf{j} \Rightarrow \nabla f(2, -2) = -2\mathbf{i} + 2\mathbf{j}$
 \Rightarrow Tangent line: $-2(x - 2) + 2(y + 2) = 0$
 $\Rightarrow y = x - 4$

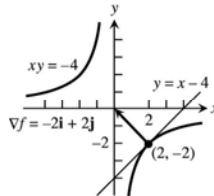

28. $\nabla f = (2x - y)\mathbf{i} + (2y - x)\mathbf{j} \Rightarrow \nabla f(-1, 2) = -4\mathbf{i} + 5\mathbf{j}$
 \Rightarrow Tangent line: $-4(x + 1) + 5(y - 2) = 0$
 $\Rightarrow -4x + 5y - 14 = 0$

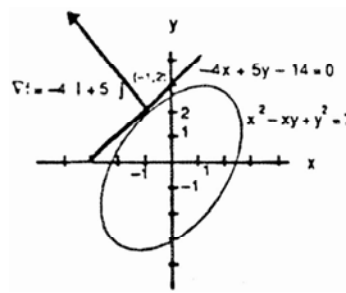

29. $\nabla f = (2x - y)\mathbf{i} + (-x + 2y - 1)\mathbf{j}$
- (a) $\nabla f(1, -1) = 3\mathbf{i} - 4\mathbf{j} \Rightarrow |\nabla f(1, -1)| = 5 \Rightarrow D_{\mathbf{u}}f(1, -1) = 5$ in the direction of $\mathbf{u} = \frac{3}{5}\mathbf{i} - \frac{4}{5}\mathbf{j}$
 - (b) $-\nabla f(1, -1) = -3\mathbf{i} + 4\mathbf{j} \Rightarrow |\nabla f(1, -1)| = 5 \Rightarrow D_{\mathbf{u}}f(1, -1) = -5$ in the direction of $\mathbf{u} = -\frac{3}{5}\mathbf{i} + \frac{4}{5}\mathbf{j}$
 - (c) $D_{\mathbf{u}}f(1, -1) = 0$ in the direction of $\mathbf{u} = \frac{4}{5}\mathbf{i} + \frac{3}{5}\mathbf{j}$ or $\mathbf{u} = -\frac{4}{5}\mathbf{i} - \frac{3}{5}\mathbf{j}$
 - (d) Let $\mathbf{u} = u_1\mathbf{i} + u_2\mathbf{j} \Rightarrow |\mathbf{u}| = \sqrt{u_1^2 + u_2^2} = 1 \Rightarrow u_1^2 + u_2^2 = 1$; $D_{\mathbf{u}}f(1, -1) = \nabla f(1, -1) \cdot \mathbf{u} = (3\mathbf{i} - 4\mathbf{j}) \cdot (u_1\mathbf{i} + u_2\mathbf{j})$
 $= 3u_1 - 4u_2 = 4 \Rightarrow u_2 = \frac{3}{4}u_1 - 1 \Rightarrow u_1^2 + (\frac{3}{4}u_1 - 1)^2 = 1 \Rightarrow \frac{25}{16}u_1^2 - \frac{3}{2}u_1 = 0 \Rightarrow u_1 = 0$ or
 $u_1 = \frac{24}{25}; u_1 = 0 \Rightarrow u_2 = -1 \Rightarrow \mathbf{u} = -\mathbf{j}$, or $u_1 = \frac{24}{25} \Rightarrow u_2 = -\frac{7}{25} \Rightarrow \mathbf{u} = \frac{24}{25}\mathbf{i} - \frac{7}{25}\mathbf{j}$
 - (e) Let $\mathbf{u} = u_1\mathbf{i} + u_2\mathbf{j} \Rightarrow |\mathbf{u}| = \sqrt{u_1^2 + u_2^2} = 1 \Rightarrow u_1^2 + u_2^2 = 1$; $D_{\mathbf{u}}f(1, -1) = \nabla f(1, -1) \cdot \mathbf{u} = (3\mathbf{i} - 4\mathbf{j}) \cdot (u_1\mathbf{i} + u_2\mathbf{j})$
 $= 3u_1 - 4u_2 = -3 \Rightarrow u_1 = \frac{4}{3}u_2 - 1 \Rightarrow (\frac{4}{3}u_2 - 1)^2 + u_2^2 = 1 \Rightarrow \frac{25}{9}u_2^2 - \frac{8}{3}u_2 = 0 \Rightarrow u_2 = 0$ or $u_2 = \frac{24}{25}$;
 $u_2 = 0 \Rightarrow u_1 = -1 \Rightarrow \mathbf{u} = -\mathbf{i}$, or $u_2 = \frac{24}{25} \Rightarrow u_1 = \frac{7}{25} \Rightarrow \mathbf{u} = \frac{7}{25}\mathbf{i} + \frac{24}{25}\mathbf{j}$

30. $\nabla f = \frac{2y}{(x+y)^2}\mathbf{i} - \frac{2x}{(x+y)^2}\mathbf{j}$
- (a) $\nabla f(-\frac{1}{2}, \frac{3}{2}) = 3\mathbf{i} + \mathbf{j} \Rightarrow |\nabla f(-\frac{1}{2}, \frac{3}{2})| = \sqrt{10} \Rightarrow D_{\mathbf{u}}f(-\frac{1}{2}, \frac{3}{2}) = \sqrt{10}$ in the direction of $\mathbf{u} = \frac{3}{\sqrt{10}}\mathbf{i} + \frac{1}{\sqrt{10}}\mathbf{j}$
 - (b) $-\nabla f(-\frac{1}{2}, \frac{3}{2}) = -3\mathbf{i} - \mathbf{j} \Rightarrow |\nabla f(-\frac{1}{2}, \frac{3}{2})| = \sqrt{10} \Rightarrow D_{\mathbf{u}}f(-\frac{1}{2}, \frac{3}{2}) = -\sqrt{10}$ in the direction of $\mathbf{u} = -\frac{3}{\sqrt{10}}\mathbf{i} - \frac{1}{\sqrt{10}}\mathbf{j}$

- (c) $D_{\mathbf{u}}f\left(-\frac{1}{2}, \frac{3}{2}\right) = 0$ in the direction of $\mathbf{u} = \frac{1}{\sqrt{10}}\mathbf{i} - \frac{3}{\sqrt{10}}\mathbf{j}$ or $\mathbf{u} = -\frac{1}{\sqrt{10}}\mathbf{i} + \frac{3}{\sqrt{10}}\mathbf{j}$
- (d) Let $\mathbf{u} = u_1\mathbf{i} + u_2\mathbf{j} \Rightarrow |\mathbf{u}| = \sqrt{u_1^2 + u_2^2} = 1 \Rightarrow u_1^2 + u_2^2 = 1$; $D_{\mathbf{u}}f\left(-\frac{1}{2}, \frac{3}{2}\right) = \nabla f\left(-\frac{1}{2}, \frac{3}{2}\right) \cdot \mathbf{u} = (3\mathbf{i} + \mathbf{j}) \cdot (u_1\mathbf{i} + u_2\mathbf{j})$
 $= 3u_1 + u_2 = -2 \Rightarrow u_2 = -3u_1 - 2 \Rightarrow u_1^2 + (-3u_1 - 2)^2 = 1 \Rightarrow 10u_1^2 + 12u_1 + 3 = 0 \Rightarrow u_1 = \frac{-6 \pm \sqrt{6}}{10}$
 $u_1 = \frac{-6 + \sqrt{6}}{10} \Rightarrow u_2 = \frac{-2 - 3\sqrt{6}}{10} \Rightarrow \mathbf{u} = \frac{-6 + \sqrt{6}}{10}\mathbf{i} + \frac{-2 - 3\sqrt{6}}{10}\mathbf{j}$, or $u_1 = \frac{-6 - \sqrt{6}}{10} \Rightarrow u_2 = \frac{-2 + 3\sqrt{6}}{10}$
 $\Rightarrow \mathbf{u} = \frac{-6 - \sqrt{6}}{10}\mathbf{i} + \frac{-2 + 3\sqrt{6}}{10}\mathbf{j}$
- (e) Let $\mathbf{u} = u_1\mathbf{i} + u_2\mathbf{j} \Rightarrow |\mathbf{u}| = \sqrt{u_1^2 + u_2^2} = 1 \Rightarrow u_1^2 + u_2^2 = 1$; $D_{\mathbf{u}}f\left(-\frac{1}{2}, \frac{3}{2}\right) = \nabla f\left(-\frac{1}{2}, \frac{3}{2}\right) \cdot \mathbf{u} = (3\mathbf{i} + \mathbf{j}) \cdot (u_1\mathbf{i} + u_2\mathbf{j})$
 $= 3u_1 + u_2 = 1 \Rightarrow u_2 = 1 - 3u_1 \Rightarrow u_1^2 + (1 - 3u_1)^2 = 1 \Rightarrow 10u_1^2 - 6u_1 = 0 \Rightarrow u_1 = 0$ or $u_1 = \frac{3}{5}$;
 $u_1 = 0 \Rightarrow u_2 = 1 \Rightarrow \mathbf{u} = \mathbf{j}$, or $u_1 = \frac{3}{5} \Rightarrow u_2 = -\frac{4}{5} \Rightarrow \mathbf{u} = \frac{3}{5}\mathbf{i} - \frac{4}{5}\mathbf{j}$
31. $\nabla f = y\mathbf{i} + (x + 2y)\mathbf{j} \Rightarrow \nabla f(3, 2) = 2\mathbf{i} + 7\mathbf{j}$; a vector orthogonal to ∇f is $\mathbf{v} = 7\mathbf{i} - 2\mathbf{j} \Rightarrow \mathbf{u} = \frac{\mathbf{v}}{|\mathbf{v}|} = \frac{7\mathbf{i} - 2\mathbf{j}}{\sqrt{7^2 + (-2)^2}}$
 $= \frac{7}{\sqrt{53}}\mathbf{i} - \frac{2}{\sqrt{53}}\mathbf{j}$ and $-\mathbf{u} = -\frac{7}{\sqrt{53}}\mathbf{i} + \frac{2}{\sqrt{53}}\mathbf{j}$ are the directions where the derivative is zero
32. $\nabla f = \frac{4xy^2}{(x^2 + y^2)^2}\mathbf{i} - \frac{4x^2y}{(x^2 + y^2)^2}\mathbf{j} \Rightarrow \nabla f(1, 1) = \mathbf{i} - \mathbf{j}$; a vector orthogonal to ∇f is $\mathbf{v} = \mathbf{i} + \mathbf{j} \Rightarrow \mathbf{u} = \frac{\mathbf{v}}{|\mathbf{v}|} = \frac{\mathbf{i} + \mathbf{j}}{\sqrt{1^2 + 1^2}}$
 $= \frac{1}{\sqrt{2}}\mathbf{i} + \frac{1}{\sqrt{2}}\mathbf{j}$ and $-\mathbf{u} = -\frac{1}{\sqrt{2}}\mathbf{i} - \frac{1}{\sqrt{2}}\mathbf{j}$ are the directions where the derivative is zero
33. $\nabla f = (2x - 3y)\mathbf{i} + (-3x + 8y)\mathbf{j} \Rightarrow \nabla f(1, 2) = -4\mathbf{i} + 13\mathbf{j} \Rightarrow |\nabla f(1, 2)| = \sqrt{(-4)^2 + (13)^2} = \sqrt{185}$; no, the maximum rate of change is $\sqrt{185} < 14$
34. $\nabla T = 2y\mathbf{i} + (2x - z)\mathbf{j} - y\mathbf{k} \Rightarrow \nabla T(1, -1, 1) = -2\mathbf{i} + \mathbf{j} + \mathbf{k} \Rightarrow |\nabla T(1, -1, 1)| = \sqrt{(-2)^2 + 1^2 + 1^2} = \sqrt{6}$; no, the minimum rate of change is $-\sqrt{6} > -3$
35. $\nabla f = f_x(1, 2)\mathbf{i} + f_y(1, 2)\mathbf{j}$ and $\mathbf{u}_1 = \frac{\mathbf{i} + \mathbf{j}}{\sqrt{1^2 + 1^2}} = \frac{1}{\sqrt{2}}\mathbf{i} + \frac{1}{\sqrt{2}}\mathbf{j} \Rightarrow (D_{\mathbf{u}_1}f)(1, 2) = f_x(1, 2)\left(\frac{1}{\sqrt{2}}\right) + f_y(1, 2)\left(\frac{1}{\sqrt{2}}\right) = 2\sqrt{2}$
 $\Rightarrow f_x(1, 2) + f_y(1, 2) = 4$; $\mathbf{u}_2 = -\mathbf{j} \Rightarrow (D_{\mathbf{u}_2}f)(1, 2) = f_x(1, 2)(0) + f_y(1, 2)(-1) = -3 \Rightarrow -f_y(1, 2) = -3$
 $\Rightarrow f_y(1, 2) = 3$; then $f_x(1, 2) + 3 = 4 \Rightarrow f_x(1, 2) = 1$; thus $\nabla f(1, 2) = \mathbf{i} + 3\mathbf{j}$ and $\mathbf{u} = \frac{\mathbf{v}}{|\mathbf{v}|} = \frac{-\mathbf{i} - 2\mathbf{j}}{\sqrt{(-1)^2 + (-2)^2}}$
 $= -\frac{1}{\sqrt{5}}\mathbf{i} - \frac{2}{\sqrt{5}}\mathbf{j} \Rightarrow (D_{\mathbf{u}}f)_{P_0} = \nabla f \cdot \mathbf{u} = -\frac{1}{\sqrt{5}} - \frac{6}{\sqrt{5}} = -\frac{7}{\sqrt{5}}$
36. (a) $(D_{\mathbf{u}}f)_p = 2\sqrt{3} \Rightarrow |\nabla f| = 2\sqrt{3}$; $\mathbf{u} = \frac{\mathbf{v}}{|\mathbf{v}|} = \frac{\mathbf{i} + \mathbf{j} - \mathbf{k}}{\sqrt{1^2 + 1^2 + (-1)^2}} = \frac{1}{\sqrt{3}}\mathbf{i} + \frac{1}{\sqrt{3}}\mathbf{j} - \frac{1}{\sqrt{3}}\mathbf{k}$; thus $\mathbf{u} = \frac{\nabla f}{|\nabla f|} \Rightarrow \nabla f = |\nabla f|\mathbf{u}$
 $\Rightarrow \nabla f = 2\sqrt{3}\left(\frac{1}{\sqrt{3}}\mathbf{i} + \frac{1}{\sqrt{3}}\mathbf{j} - \frac{1}{\sqrt{3}}\mathbf{k}\right) = 2\mathbf{i} + 2\mathbf{j} - 2\mathbf{k}$
- (b) $\mathbf{v} = \mathbf{i} + \mathbf{j} \Rightarrow \mathbf{u} = \frac{\mathbf{v}}{|\mathbf{v}|} = \frac{\mathbf{i} + \mathbf{j}}{\sqrt{1^2 + 1^2}} = \frac{1}{\sqrt{2}}\mathbf{i} + \frac{1}{\sqrt{2}}\mathbf{j} \Rightarrow (D_{\mathbf{u}}f)_{P_0} = \nabla f \cdot \mathbf{u} = 2\left(\frac{1}{\sqrt{2}}\right) + 2\left(\frac{1}{\sqrt{2}}\right) - 2(0) = 2\sqrt{2}$

37. The directional derivative is the scalar component. With ∇f evaluated at P_0 , the scalar component of ∇f in the direction of \mathbf{u} is $\nabla f \cdot \mathbf{u} = (D_{\mathbf{u}}f)_{P_0}$.
38. $D_{\mathbf{i}}f = \nabla f \cdot \mathbf{i} = (f_x\mathbf{i} + f_y\mathbf{j} + f_z\mathbf{k}) \cdot \mathbf{i} = f_x$; similarly, $D_{\mathbf{j}}f = \nabla f \cdot \mathbf{j} = f_y$ and $D_{\mathbf{k}}f = \nabla f \cdot \mathbf{k} = f_z$
39. If (x, y) is a point on the line, then $\mathbf{T}(x, y) = (x - x_0)\mathbf{i} + (y - y_0)\mathbf{j}$ is a vector parallel to the line $\Rightarrow \mathbf{T} \cdot \mathbf{N} = 0 \Rightarrow A(x - x_0) + B(y - y_0) = 0$, as claimed.
40. (a) $\nabla(kf) = \frac{\partial(kf)}{\partial x}\mathbf{i} + \frac{\partial(kf)}{\partial y}\mathbf{j} + \frac{\partial(kf)}{\partial z}\mathbf{k} = k\left(\frac{\partial f}{\partial x}\right)\mathbf{i} + k\left(\frac{\partial f}{\partial y}\right)\mathbf{j} + k\left(\frac{\partial f}{\partial z}\right)\mathbf{k} = k\left(\frac{\partial f}{\partial x}\mathbf{i} + \frac{\partial f}{\partial y}\mathbf{j} + \frac{\partial f}{\partial z}\mathbf{k}\right) = k\nabla f$
- (b) $\nabla(f+g) = \frac{\partial(f+g)}{\partial x}\mathbf{i} + \frac{\partial(f+g)}{\partial y}\mathbf{j} + \frac{\partial(f+g)}{\partial z}\mathbf{k} = \left(\frac{\partial f}{\partial x} + \frac{\partial g}{\partial x}\right)\mathbf{i} + \left(\frac{\partial f}{\partial y} + \frac{\partial g}{\partial y}\right)\mathbf{j} + \left(\frac{\partial f}{\partial z} + \frac{\partial g}{\partial z}\right)\mathbf{k}$
 $= \frac{\partial f}{\partial x}\mathbf{i} + \frac{\partial g}{\partial x}\mathbf{i} + \frac{\partial f}{\partial y}\mathbf{j} + \frac{\partial g}{\partial y}\mathbf{j} + \frac{\partial f}{\partial z}\mathbf{k} + \frac{\partial g}{\partial z}\mathbf{k} = \left(\frac{\partial f}{\partial x}\mathbf{i} + \frac{\partial f}{\partial y}\mathbf{j} + \frac{\partial f}{\partial z}\mathbf{k}\right) + \left(\frac{\partial g}{\partial x}\mathbf{i} + \frac{\partial g}{\partial y}\mathbf{j} + \frac{\partial g}{\partial z}\mathbf{k}\right) = \nabla f + \nabla g$
- (c) $\nabla(f-g) = \nabla f - \nabla g$ (Substitute $-g$ for g in part (b) above)
- (d) $\nabla(fg) = \frac{\partial(fg)}{\partial x}\mathbf{i} + \frac{\partial(fg)}{\partial y}\mathbf{j} + \frac{\partial(fg)}{\partial z}\mathbf{k} = \left(\frac{\partial f}{\partial x}g + \frac{\partial g}{\partial x}f\right)\mathbf{i} + \left(\frac{\partial f}{\partial y}g + \frac{\partial g}{\partial y}f\right)\mathbf{j} + \left(\frac{\partial f}{\partial z}g + \frac{\partial g}{\partial z}f\right)\mathbf{k}$
 $= \left(\frac{\partial f}{\partial x}g\right)\mathbf{i} + \left(\frac{\partial g}{\partial x}f\right)\mathbf{i} + \left(\frac{\partial f}{\partial y}g\right)\mathbf{j} + \left(\frac{\partial g}{\partial y}f\right)\mathbf{j} + \left(\frac{\partial f}{\partial z}g\right)\mathbf{k} + \left(\frac{\partial g}{\partial z}f\right)\mathbf{k} = f\left(\frac{\partial g}{\partial x}\mathbf{i} + \frac{\partial g}{\partial y}\mathbf{j} + \frac{\partial g}{\partial z}\mathbf{k}\right) + g\left(\frac{\partial f}{\partial x}\mathbf{i} + \frac{\partial f}{\partial y}\mathbf{j} + \frac{\partial f}{\partial z}\mathbf{k}\right)$
 $= f\nabla g + g\nabla f$
- (e) $\nabla\left(\frac{f}{g}\right) = \frac{\partial\left(\frac{f}{g}\right)}{\partial x}\mathbf{i} + \frac{\partial\left(\frac{f}{g}\right)}{\partial y}\mathbf{j} + \frac{\partial\left(\frac{f}{g}\right)}{\partial z}\mathbf{k} = \left(\frac{g\frac{\partial f}{\partial x} - f\frac{\partial g}{\partial x}}{g^2}\right)\mathbf{i} + \left(\frac{g\frac{\partial f}{\partial y} - f\frac{\partial g}{\partial y}}{g^2}\right)\mathbf{j} + \left(\frac{g\frac{\partial f}{\partial z} - f\frac{\partial g}{\partial z}}{g^2}\right)\mathbf{k}$
 $= \left(\frac{g\frac{\partial f}{\partial x}\mathbf{i} + g\frac{\partial f}{\partial y}\mathbf{j} + g\frac{\partial f}{\partial z}\mathbf{k}}{g^2}\right) - \left(\frac{f\frac{\partial g}{\partial x}\mathbf{i} + f\frac{\partial g}{\partial y}\mathbf{j} + f\frac{\partial g}{\partial z}\mathbf{k}}{g^2}\right) = \frac{g\left(\frac{\partial f}{\partial x}\mathbf{i} + \frac{\partial f}{\partial y}\mathbf{j} + \frac{\partial f}{\partial z}\mathbf{k}\right)}{g^2} - \frac{f\left(\frac{\partial g}{\partial x}\mathbf{i} + \frac{\partial g}{\partial y}\mathbf{j} + \frac{\partial g}{\partial z}\mathbf{k}\right)}{g^2} = \frac{g\nabla f}{g^2} - \frac{f\nabla g}{g^2} = \frac{g\nabla f - f\nabla g}{g^2}$

14.6 TANGENT PLANES AND DIFFERENTIALS

1. (a) $\nabla f = 2x\mathbf{i} + 2y\mathbf{j} + 2z\mathbf{k} \Rightarrow \nabla f(1, 1, 1) = 2\mathbf{i} + 2\mathbf{j} + 2\mathbf{k}$
 \Rightarrow Tangent plane: $2(x-1) + 2(y-1) + 2(z-1) = 0 \Rightarrow x + y + z = 3$;
 (b) Normal line: $x = 1 + 2t, y = 1 + 2t, z = 1 + 2t$
2. (a) $\nabla f = 2x\mathbf{i} + 2y\mathbf{j} - 2z\mathbf{k} \Rightarrow \nabla f(3, 5, -4) = 6\mathbf{i} + 10\mathbf{j} + 8\mathbf{k}$
 \Rightarrow Tangent plane: $6(x-3) + 10(y-5) + 8(z+4) = 0 \Rightarrow 3x + 5y + 4z = 18$;
 (b) Normal line: $x = 3 + 6t, y = 5 + 10t, z = -4 + 8t$
3. (a) $\nabla f = -2x\mathbf{i} + 2z\mathbf{k} \Rightarrow \nabla f(2, 0, 2) = -4\mathbf{i} + 2\mathbf{k}$
 \Rightarrow Tangent plane: $-4(x-2) + 2(z-2) = 0 \Rightarrow -4x + 2z + 4 = 0 \Rightarrow -2x + z + 2 = 0$;
 (b) Normal line: $x = 2 - 4t, y = 0, z = 2 + 2t$
4. (a) $\nabla f = (2x + 2y)\mathbf{i} + (2x - 2y)\mathbf{j} + 2z\mathbf{k} \Rightarrow \nabla f(1, -1, 3) = 4\mathbf{j} + 6\mathbf{k}$
 \Rightarrow Tangent plane: $4(y+1) + 6(z-3) = 0 \Rightarrow 2y + 3z = 7$;
 (b) Normal line: $x = 1, y = -1 + 4t, z = 3 + 6t$

5. (a) $\nabla f = (-\pi \sin \pi x - 2xy + ze^{xz})\mathbf{i} + (-x^2 + z)\mathbf{j} + (xe^{xz} + y)\mathbf{k} \Rightarrow \nabla f(0, 1, 2) = 2\mathbf{i} + 2\mathbf{j} + \mathbf{k}$
 \Rightarrow Tangent plane: $2(x-0) + 2(y-1) + 1(z-2) = 0 \Rightarrow 2x + 2y + z - 4 = 0$;
 (b) Normal line: $x = 2t, y = 1 + 2t, z = 2 + t$
6. (a) $\nabla f = (2x - y)\mathbf{i} - (x + 2y)\mathbf{j} - \mathbf{k} \Rightarrow \nabla f(1, 1, -1) = \mathbf{i} - 3\mathbf{j} - \mathbf{k}$
 \Rightarrow Tangent plane: $1(x-1) - 3(y-1) - 1(z+1) = 0 \Rightarrow x - 3y - z = -1$;
 (b) Normal line: $x = 1 + t, y = 1 - 3t, z = 1 - t$
7. (a) $\nabla f = \mathbf{i} + \mathbf{j} + \mathbf{k}$ for all points $\Rightarrow \nabla f(0, 1, 0) = \mathbf{i} + \mathbf{j} + \mathbf{k}$
 \Rightarrow Tangent plane: $1(x-0) + 1(y-1) + 1(z-0) = 0 \Rightarrow x + y + z - 1 = 0$;
 (b) Normal line: $x = t, y = 1 + t, z = t$
8. (a) $\nabla f = (2x - 2y - 1)\mathbf{i} + (2y - 2x + 3)\mathbf{j} - \mathbf{k} \Rightarrow \nabla f(2, -3, 18) = 9\mathbf{i} - 7\mathbf{j} - \mathbf{k}$
 \Rightarrow Tangent plane: $9(x-2) - 7(y+3) - 1(z-18) = 0 \Rightarrow 9x - 7y - z = 21$;
 (b) Normal line: $x = 2 + 9t, y = -3 - 7t, z = 18 - t$
9. $z = f(x, y) = \ln(x^2 + y^2) \Rightarrow f_x(x, y) = \frac{2x}{x^2 + y^2}$ and $f_y(x, y) = \frac{2y}{x^2 + y^2} \Rightarrow f_x(1, 0) = 2$ and $f_y(1, 0) = 0$
 \Rightarrow from Eq. (4) the tangent plane at $(1, 0, 0)$ is $2(x-1) - z = 0$ or $2x - z - 2 = 0$
10. $z = f(x, y) = e^{-(x^2 + y^2)} \Rightarrow f_x(x, y) = -2xe^{-(x^2 + y^2)}$ and $f_y(x, y) = -2ye^{-(x^2 + y^2)} \Rightarrow f_x(0, 0) = 0$ and $f_y(0, 0) = 0$
 \Rightarrow from Eq. (4) the tangent plane at $(0, 0, 1)$ is $z - 1 = 0$ or $z = 1$
11. $z = f(x, y) = \sqrt{y - x} \Rightarrow f_x(x, y) = -\frac{1}{2}(y - x)^{-1/2}$ and $f_y(x, y) = \frac{1}{2}(y - x)^{-1/2} \Rightarrow f_x(1, 2) = -\frac{1}{2}$ and $f_y(1, 2) = \frac{1}{2}$
 \Rightarrow from Eq. (4) the tangent plane at $(1, 2, 1)$ is $-\frac{1}{2}(x-1) + \frac{1}{2}(y-2) - (z-1) = 0$
 $\Rightarrow x - y + 2z - 1 = 0$
12. $z = f(x, y) = 4x^2 + y^2 \Rightarrow f_x(x, y) = 8x$ and $f_y(x, y) = 2y \Rightarrow f_x(1, 1) = 8$ and $f_y(1, 1) = 2$
 \Rightarrow from Eq. (4) the tangent plane at $(1, 1, 5)$ is $8(x-1) + 2(y-1) - (z-5) = 0$ or $8x + 2y - z - 5 = 0$
13. $\nabla f = \mathbf{i} + 2y\mathbf{j} + 2\mathbf{k} \Rightarrow \nabla f(1, 1, 1) = \mathbf{i} + 2\mathbf{j} + 2\mathbf{k}$ and $\nabla g = \mathbf{i}$ for all points; $\mathbf{v} = \nabla f \times \nabla g \Rightarrow \mathbf{v} = \begin{vmatrix} \mathbf{i} & \mathbf{j} & \mathbf{k} \\ 1 & 2 & 2 \\ 1 & 0 & 0 \end{vmatrix} = 2\mathbf{j} - 2\mathbf{k}$
 \Rightarrow Tangent line: $x = 1, y = 1 + 2t, z = 1 - 2t$
14. $\nabla f = yz\mathbf{i} + xz\mathbf{j} + xy\mathbf{k} \Rightarrow \nabla f(1, 1, 1) = \mathbf{i} + \mathbf{j} + \mathbf{k}$; $\nabla g = 2x\mathbf{i} + 4y\mathbf{j} + 6z\mathbf{k} \Rightarrow \nabla g(1, 1, 1) = 2\mathbf{i} + 4\mathbf{j} + 6\mathbf{k}$;
 $\Rightarrow \mathbf{v} = \nabla f \times \nabla g \Rightarrow \begin{vmatrix} \mathbf{i} & \mathbf{j} & \mathbf{k} \\ 1 & 1 & 1 \\ 2 & 4 & 6 \end{vmatrix} = 2\mathbf{i} - 4\mathbf{j} + 2\mathbf{k} \Rightarrow$ Tangent line: $x = 1 + 2t, y = 1 - 4t, z = 1 + 2t$

15. $\nabla f = 2x\mathbf{i} + 2\mathbf{j} + 2\mathbf{k} \Rightarrow \nabla f(1, 1, \frac{1}{2}) = 2\mathbf{i} + 2\mathbf{j} + 2\mathbf{k}$ and $\nabla g = \mathbf{j}$ for all points ;

$$\mathbf{v} = \nabla f \times \nabla g \Rightarrow \mathbf{v} = \begin{vmatrix} \mathbf{i} & \mathbf{j} & \mathbf{k} \\ 2 & 2 & 2 \\ 0 & 1 & 0 \end{vmatrix} = -2\mathbf{i} + 2\mathbf{k} \Rightarrow \text{Tangent line: } x = 1 - 2t, y = 1, z = \frac{1}{2} + 2t$$

16. $\nabla f = \mathbf{i} + 2y\mathbf{j} + \mathbf{k} \Rightarrow \nabla f(\frac{1}{2}, 1, \frac{1}{2}) = \mathbf{i} + 2\mathbf{j} + \mathbf{k}$ and $\nabla g = \mathbf{j}$ for all points; $\mathbf{v} = \nabla f \times \nabla g \Rightarrow \mathbf{v} = \begin{vmatrix} \mathbf{i} & \mathbf{j} & \mathbf{k} \\ 1 & 2 & 1 \\ 0 & 1 & 0 \end{vmatrix} = -\mathbf{i} + \mathbf{k}$

\Rightarrow Tangent line: $x = \frac{1}{2} - t, y = 1, z = \frac{1}{2} + t$

17. $\nabla f = (3x^2 + 6xy^2 + 4y)\mathbf{i} + (6x^2y + 3y^2 + 4x)\mathbf{j} - 2z\mathbf{k} \Rightarrow \nabla f(1, 1, 3) = 13\mathbf{i} + 13\mathbf{j} - 6\mathbf{k}$;

$$\nabla g = 2x\mathbf{i} + 2y\mathbf{j} + 2z\mathbf{k} \Rightarrow \nabla g(1, 1, 3) = 2\mathbf{i} + 2\mathbf{j} + 6\mathbf{k}; \quad \mathbf{v} = \nabla f \times \nabla g \Rightarrow \mathbf{v} = \begin{vmatrix} \mathbf{i} & \mathbf{j} & \mathbf{k} \\ 13 & 13 & -6 \\ 2 & 2 & 6 \end{vmatrix} = 90\mathbf{i} - 90\mathbf{j}$$

\Rightarrow Tangent line: $x = 1 + 90t, y = 1 - 90t, z = 3$

18. $\nabla f = 2x\mathbf{i} + 2y\mathbf{j} \Rightarrow \nabla f(\sqrt{2}, \sqrt{2}, 4) = 2\sqrt{2}\mathbf{i} + 2\sqrt{2}\mathbf{j}$; $\nabla g = 2x\mathbf{i} + 2y\mathbf{j} - \mathbf{k} \Rightarrow \nabla g(\sqrt{2}, \sqrt{2}, 4) = 2\sqrt{2}\mathbf{i} + 2\sqrt{2}\mathbf{j} - \mathbf{k}$;

$$\mathbf{v} = \nabla f \times \nabla g \Rightarrow \mathbf{v} = \begin{vmatrix} \mathbf{i} & \mathbf{j} & \mathbf{k} \\ 2\sqrt{2} & 2\sqrt{2} & 0 \\ 2\sqrt{2} & 2\sqrt{2} & -1 \end{vmatrix} = -2\sqrt{2}\mathbf{i} + 2\sqrt{2}\mathbf{j} \Rightarrow \text{Tangent line: } x = \sqrt{2} - 2\sqrt{2}t, y = \sqrt{2} + 2\sqrt{2}t, z = 4$$

19. $\nabla f = \left(\frac{x}{x^2+y^2+z^2}\right)\mathbf{i} + \left(\frac{y}{x^2+y^2+z^2}\right)\mathbf{j} + \left(\frac{z}{x^2+y^2+z^2}\right)\mathbf{k} \Rightarrow \nabla f(3, 4, 12) = \frac{3}{169}\mathbf{i} + \frac{4}{169}\mathbf{j} + \frac{12}{169}\mathbf{k}$;

$$\mathbf{u} = \frac{\mathbf{v}}{|\mathbf{v}|} = \frac{3\mathbf{i} + 6\mathbf{j} - 2\mathbf{k}}{\sqrt{3^2 + 6^2 + (-2)^2}} = \frac{3}{7}\mathbf{i} + \frac{6}{7}\mathbf{j} - \frac{2}{7}\mathbf{k} \Rightarrow \nabla f \cdot \mathbf{u} = \frac{9}{1183} \text{ and } df = (\nabla f \cdot \mathbf{u}) ds = \left(\frac{9}{1183}\right)(0.1) \approx 0.0008$$

20. $\nabla f = (e^x \cos yz)\mathbf{i} - (ze^x \sin yz)\mathbf{j} - (ye^x \sin yz)\mathbf{k} \Rightarrow \nabla f(0, 0, 0) = \mathbf{i}$; $\mathbf{u} = \frac{\mathbf{v}}{|\mathbf{v}|} = \frac{2\mathbf{i} + 2\mathbf{j} - 2\mathbf{k}}{\sqrt{2^2 + 2^2 + (-2)^2}}$

$$= \frac{1}{\sqrt{3}}\mathbf{i} + \frac{1}{\sqrt{3}}\mathbf{j} - \frac{1}{\sqrt{3}}\mathbf{k} \Rightarrow \nabla f \cdot \mathbf{u} = \frac{1}{\sqrt{3}} \text{ and } df = (\nabla f \cdot \mathbf{u}) ds = \frac{1}{\sqrt{3}}(0.1) \approx 0.0577$$

21. $\nabla g = (1 + \cos z)\mathbf{i} + (1 - \sin z)\mathbf{j} + (-x \sin z - y \cos z)\mathbf{k} \Rightarrow \nabla g(2, -1, 0) = 2\mathbf{i} + \mathbf{j} + \mathbf{k}$; $\mathbf{A} = \overline{P_0 P_1} = -2\mathbf{i} + 2\mathbf{j} + 2\mathbf{k}$

$$\Rightarrow \mathbf{u} = \frac{\mathbf{v}}{|\mathbf{v}|} = \frac{-2\mathbf{i} + 2\mathbf{j} + 2\mathbf{k}}{\sqrt{(-2)^2 + 2^2 + 2^2}} = -\frac{1}{\sqrt{3}}\mathbf{i} + \frac{1}{\sqrt{3}}\mathbf{j} + \frac{1}{\sqrt{3}}\mathbf{k} \Rightarrow \nabla g \cdot \mathbf{u} = 0 \text{ and } dg = (\nabla g \cdot \mathbf{u}) ds = (0)(0.2) = 0$$

22. $\nabla h = [-\pi y \sin(\pi xy) + z^2]\mathbf{i} - [\pi x \sin(\pi xy)]\mathbf{j} + 2xz\mathbf{k} \Rightarrow \nabla h(-1, -1, -1) = (\pi \sin \pi + 1)\mathbf{i} + (\pi \sin \pi)\mathbf{j} + 2\mathbf{k}$

$$= \mathbf{i} + 2\mathbf{k}; \quad \mathbf{v} = \overline{P_0 P_1} = \mathbf{i} + \mathbf{j} + \mathbf{k} \text{ where } P_1 = (0, 0, 0) \Rightarrow \mathbf{u} = \frac{\mathbf{v}}{|\mathbf{v}|} = \frac{\mathbf{i} + \mathbf{j} + \mathbf{k}}{\sqrt{1^2 + 1^2 + 1^2}} = \frac{1}{\sqrt{3}}\mathbf{i} + \frac{1}{\sqrt{3}}\mathbf{j} + \frac{1}{\sqrt{3}}\mathbf{k}$$

$$\Rightarrow \nabla h \cdot \mathbf{u} = \frac{3}{\sqrt{3}} = \sqrt{3} \text{ and } dh = (\nabla h \cdot \mathbf{u}) ds = \sqrt{3}(0.1) \approx 0.1732$$

23. (a) The unit tangent vector at $\left(\frac{1}{2}, \frac{\sqrt{3}}{2}\right)$ in the direction of motion is $\mathbf{u} = \frac{\sqrt{3}}{2}\mathbf{i} - \frac{1}{2}\mathbf{j}$;
 $\nabla T = (\sin 2y)\mathbf{i} + (2x \cos 2y)\mathbf{j} \Rightarrow \nabla T\left(\frac{1}{2}, \frac{\sqrt{3}}{2}\right) = (\sin \sqrt{3})\mathbf{i} + (\cos \sqrt{3})\mathbf{j} \Rightarrow D_{\mathbf{u}}T\left(\frac{1}{2}, \frac{\sqrt{3}}{2}\right) = \nabla T \cdot \mathbf{u}$
 $= \frac{\sqrt{3}}{2} \sin \sqrt{3} - \frac{1}{2} \cos \sqrt{3} \approx 0.935^\circ \text{ C/ft}$
- (b) $\mathbf{r}(t) = (\sin 2t)\mathbf{i} + (\cos 2t)\mathbf{j} \Rightarrow \mathbf{v}(t) = (2 \cos 2t)\mathbf{i} - (2 \sin 2t)\mathbf{j}$ and $|\mathbf{v}| = 2$;
 $\frac{dT}{dt} = \frac{\partial T}{\partial x} \frac{dx}{dt} + \frac{\partial T}{\partial y} \frac{dy}{dt} = \nabla T \cdot \mathbf{v} = \left(\nabla T \cdot \frac{\mathbf{v}}{|\mathbf{v}|}\right)|\mathbf{v}| = (D_{\mathbf{u}}T)|\mathbf{v}|$, where $\mathbf{u} = \frac{\mathbf{v}}{|\mathbf{v}|}$; at $\left(\frac{1}{2}, \frac{\sqrt{3}}{2}\right)$ we have $\mathbf{u} = \frac{\sqrt{3}}{2}\mathbf{i} - \frac{1}{2}\mathbf{j}$
 from part (a) $\Rightarrow \frac{dT}{dt} = \left(\frac{\sqrt{3}}{2} \sin \sqrt{3} - \frac{1}{2} \cos \sqrt{3}\right) \cdot 2 = \sqrt{3} \sin \sqrt{3} - \cos \sqrt{3} \approx 1.87^\circ \text{ C/sec}$
24. (a) $\nabla T = (4x - yz)\mathbf{i} - xz\mathbf{j} - xy\mathbf{k} \Rightarrow \nabla T(8, 6, -4) = 56\mathbf{i} + 32\mathbf{j} - 48\mathbf{k}$; $\mathbf{r}(t) = 2t^2\mathbf{i} + 3t\mathbf{j} - t^2\mathbf{k} \Rightarrow$ the particle is
 at the point $P(8, 6, -4)$ when $t = 2$; $\mathbf{v}(t) = 4t\mathbf{i} + 3\mathbf{j} - 2t\mathbf{k} \Rightarrow \mathbf{v}(2) = 8\mathbf{i} + 3\mathbf{j} - 4\mathbf{k} \Rightarrow \mathbf{u} = \frac{\mathbf{v}}{|\mathbf{v}|}$
 $= \frac{8}{\sqrt{89}}\mathbf{i} + \frac{3}{\sqrt{89}}\mathbf{j} - \frac{4}{\sqrt{89}}\mathbf{k} \Rightarrow D_{\mathbf{u}}T(8, 6, -4) = \nabla T \cdot \mathbf{u} = \frac{1}{\sqrt{89}}[56 \cdot 8 + 32 \cdot 3 - 48 \cdot (-4)] = \frac{736}{\sqrt{89}}^\circ \text{ C/m}$
- (b) $\frac{dT}{dt} = \frac{\partial T}{\partial x} \frac{dx}{dt} + \frac{\partial T}{\partial y} \frac{dy}{dt} = \nabla T \cdot \mathbf{v} = (\nabla T \cdot \mathbf{u})|\mathbf{v}| \Rightarrow$ at $t = 2$, $\frac{dT}{dt} = D_{\mathbf{u}}T|_{t=2} \mathbf{v}(2) = \left(\frac{736}{\sqrt{89}}\right)\sqrt{89} = 736^\circ \text{ C/sec}$
25. (a) $f(0, 0) = 1$, $f_x(x, y) = 2x \Rightarrow f_x(0, 0) = 0$, $f_y(x, y) = 2y \Rightarrow f_y(0, 0) = 0$
 $\Rightarrow L(x, y) = 1 + 0(x - 0) + 0(y - 0) = 1$
- (b) $f(1, 1) = 3$, $f_x(1, 1) = 2$, $f_y(1, 1) = 2 \Rightarrow L(x, y) = 3 + 2(x - 1) + 2(y - 1) = 2x + 2y - 1$
26. (a) $f(0, 0) = 4$, $f_x(x, y) = 2(x + y + 2) \Rightarrow f_x(0, 0) = 4$, $f_y(x, y) = 2(x + y + 2) \Rightarrow f_y(0, 0) = 4$
 $\Rightarrow L(x, y) = 4 + 4(x - 0) + 4(y - 0) = 4x + 4y + 4$
- (b) $f(1, 2) = 25$, $f_x(1, 2) = 10$, $f_y(1, 2) = 10 \Rightarrow L(x, y) = 25 + 10(x - 1) + 10(y - 2) = 10x + 10y - 5$
27. (a) $f(0, 0) = 5$, $f_x(x, y) = 3$ for all (x, y) , $f_y(x, y) = -4$ for all $(x, y) \Rightarrow L(x, y) = 5 + 3(x - 0) - 4(y - 0)$
 $= 3x - 4y + 5$
- (b) $f(1, 1) = 4$, $f_x(1, 1) = 3$, $f_y(1, 1) = -4 \Rightarrow L(x, y) = 4 + 3(x - 1) - 4(y - 1) = 3x - 4y + 5$
28. (a) $f(1, 1) = 1$, $f_x(x, y) = 3x^2y^4 \Rightarrow f_x(1, 1) = 3$, $f_y(x, y) = 4x^3y^3 \Rightarrow f_y(1, 1) = 4$
 $\Rightarrow L(x, y) = 1 + 3(x - 1) + 4(y - 1) = 3x + 4y - 6$
- (b) $f(0, 0) = 0$, $f_x(0, 0) = 0$, $f_y(0, 0) = 0 \Rightarrow L(x, y) = 0$
29. (a) $f(0, 0) = 1$, $f_x(x, y) = e^x \cos y = f_x(0, 0) = 1$, $f_y(x, y) = -e^x \sin y \Rightarrow f_y(0, 0) = 0$
 $\Rightarrow L(x, y) = 1 + 1(x - 0) + 0(y - 0) = x + 1$
- (b) $f\left(0, \frac{\pi}{2}\right) = 0$, $f_x\left(0, \frac{\pi}{2}\right) = 0$, $f_y\left(0, \frac{\pi}{2}\right) = -1 \Rightarrow L(x, y) = 0 + 0(x - 0) - 1\left(y - \frac{\pi}{2}\right) = -y + \frac{\pi}{2}$
30. (a) $f(0, 0) = 1$, $f_x(x, y) = -e^{2y-x} \Rightarrow f_x(0, 0) = -1$, $f_y(x, y) = 2e^{2y-x} \Rightarrow f_y(0, 0) = 2$
 $\Rightarrow L(x, y) = 1 - 1(x - 0) + 2(y - 0) = -x + 2y + 1$
- (b) $f(1, 2) = e^3$, $f_x(1, 2) = -e^3$, $f_y(1, 2) = 2e^3 \Rightarrow L(x, y) = e^3 - e^3(x - 1) + 2e^3(y - 2) = -e^3x + 2e^3y - 2e^3$

31. (a) $W(20, 25) = 11^\circ F$; $W(30, -10) = -39^\circ F$; $W(15, 15) = 0^\circ F$
 (b) $W(10, -40) = -65.5^\circ F$; $W(50, -40) = -88^\circ F$; $W(60, 30) = 10.2^\circ F$;
 (c) $W(25, 5) = -17.4088^\circ F$; $\frac{\partial W}{\partial V} = -\frac{5.72}{v^{0.84}} + \frac{0.0684t}{v^{0.84}} \Rightarrow \frac{\partial W}{\partial V}(25, 5) = -0.36$; $\frac{\partial W}{\partial T} = 0.6215 + 0.4275v^{0.16}$
 $\Rightarrow \frac{\partial W}{\partial T}(25, 5) = 1.3370 \Rightarrow L(V, T) = -17.4088 - 0.36(V - 25) + 1.337(T - 5) = 1.337T - 0.36V - 15.0938$
 (d) i) $W(24, 6) \approx L(24, 6) = -15.7118 \approx -15.7^\circ F$
 ii) $W(27, 2) \approx L(27, 2) = -22.1398 \approx -22.1^\circ F$
 iii) $W(5, -10) \approx L(5, -10) = -30.2638 \approx -30.2^\circ F$ This value is very different because the point $(5, -10)$ is not close to the point $(25, 5)$.

32. $W(50, -20) = -59.5298^\circ F$; $\frac{\partial W}{\partial V} = -\frac{5.72}{v^{0.84}} + \frac{0.0684t}{v^{0.84}} \Rightarrow \frac{\partial W}{\partial V}(50, -20) = -0.2651$; $\frac{\partial W}{\partial T} = 0.6215 + 0.4275v^{0.16}$
 $\Rightarrow \frac{\partial W}{\partial T}(50, -20) = 1.4209 \Rightarrow L(V, T) = -59.5298 - 0.2651(V - 50) + 1.4209(T + 20)$
 $= 1.4209T - 0.2651V - 17.8568$
 (a) $W(49, -22) \approx L(49, -22) = -62.1065 \approx -62.1^\circ F$
 (b) $W(53, -19) \approx L(53, -19) = -58.9042 \approx -58.9^\circ F$
 (c) $W(60, -30) \approx L(60, -30) = -76.3898 \approx -76.4^\circ F$

33. $f(2, 1) = 3$, $f_x(x, y) = 2x - 3y \Rightarrow f_x(2, 1) = 1$, $f_y(x, y) = -3x \Rightarrow f_y(2, 1) = -6 \Rightarrow L(x, y) = 3 + 1(x - 2) - 6(y - 1)$
 $= 7 + x - 6y$; $f_{xx}(x, y) = 2$, $f_{yy}(x, y) = 0$, $f_{xy}(x, y) = -3 \Rightarrow M = 3$; thus $|E(x, y)| \leq \left(\frac{1}{2}\right)(3)(|x - 2| + |y - 1|)^2$
 $\leq \left(\frac{3}{2}\right)(0.1 + 0.1)^2 = 0.06$

34. $f(2, 2) = 11$, $f_x(x, y) = x + y + 3 \Rightarrow f_x(2, 2) = 7$, $f_y(x, y) = x + \frac{y}{2} - 3 \Rightarrow f_y(2, 2) = 0$
 $\Rightarrow L(x, y) = 11 + 7(x - 2) + 0(y - 2) = 7x - 3$; $f_{xx}(x, y) = 1$, $f_{yy}(x, y) = \frac{1}{2}$, $f_{xy}(x, y) = 1 \Rightarrow M = 1$; thus
 $|E(x, y)| \leq \left(\frac{1}{2}\right)(1)(|x - 2| + |y - 2|)^2 \leq \left(\frac{1}{2}\right)(0.1 + 0.1)^2 = 0.02$

35. $f(0, 0) = 1$, $f_x(x, y) = \cos y \Rightarrow f_x(0, 0) = 1$, $f_y(x, y) = 1 - x \sin y \Rightarrow f_y(0, 0) = 1$
 $\Rightarrow L(x, y) = 1 + 1(x - 0) + 1(y - 0) = x + y + 1$; $f_{xx}(x, y) = 0$, $f_{yy}(x, y) = -x \cos y$, $f_{xy}(x, y) = -\sin y$
 $\Rightarrow M = 1$; thus $|E(x, y)| \leq \left(\frac{1}{2}\right)(1)(|x| + |y|)^2 \leq \left(\frac{1}{2}\right)(0.2 + 0.2)^2 = 0.08$

36. $f(1, 2) = 6$, $f_x(x, y) = y^2 - y \sin(x - 1) \Rightarrow f_x(1, 2) = 4$, $f_y(x, y) = 2xy + \cos(x - 1) \Rightarrow f_y(1, 2) = 5$
 $\Rightarrow L(x, y) = 6 + 4(x - 1) + 5(y - 2) = 4x + 5y - 8$; $f_{xx}(x, y) = -y \cos(x - 1)$, $f_{yy}(x, y) = 2x$,
 $f_{xy}(x, y) = 2y - \sin(x - 1)$; $|x - 1| \leq 0.1 \Rightarrow 0.9 \leq x \leq 1.1$ and $|y - 2| \leq 0.1 \Rightarrow 1.9 \leq y \leq 2.1$; thus the max of
 $|f_{xx}(x, y)|$ on R is 2.1, the max of $|f_{yy}(x, y)|$ on R is 2.2, and the max of $|f_{xy}(x, y)|$ on R is
 $2(2.1) - \sin(0.9 - 1) \leq 4.3 \Rightarrow M = 4.3$; thus $|E(x, y)| \leq \left(\frac{1}{2}\right)(4.3)(|x - 1| + |y - 2|)^2 \leq (2.15)(0.1 + 0.1)^2 = 0.086$

37. $f(0, 0) = 1$, $f_x(x, y) = e^x \cos y \Rightarrow f_x(0, 0) = 1$, $f_y(x, y) = -e^x \sin y \Rightarrow f_y(0, 0) = 0$
 $\Rightarrow L(x, y) = 1 + 1(x - 0) + 0(y - 0) = 1 + x$; $f_{xx}(x, y) = e^x \cos y$, $f_{yy}(x, y) = -e^x \cos y$, $f_{xy}(x, y) = -e^x \sin y$;
 $|x| \leq 0.1 \Rightarrow -0.1 \leq x \leq 0.1$ and $|y| \leq 0.1 \Rightarrow -0.1 \leq y \leq 0.1$; thus the max of $|f_{xx}(x, y)|$ on R is

$e^{0.1} \cos(0.1) \leq 1.11$, the max of $|f_{yy}(x, y)|$ on R is $e^{0.1} \cos(0.1) \leq 1.11$, and the max of $|f_{xy}(x, y)|$ on R is $e^{0.1} \sin(0.1) \leq 0.12 \Rightarrow M = 1.11$; thus $|E(x, y)| \leq \left(\frac{1}{2}\right)(1.11)(|x| + |y|)^2 \leq (0.555)(0.1 + 0.1)^2 = 0.0222$

38. $f(1, 1) = 0$, $f_x(x, y) = \frac{1}{x} \Rightarrow f_x(1, 1) = 1$, $f_y(x, y) = \frac{1}{y} \Rightarrow f_y(1, 1) = 1 \Rightarrow L(x, y) = 0 + 1(x-1) + 1(y-1)$
 $= x + y - 2$; $f_{xx}(x, y) = -\frac{1}{x^2}$, $f_{yy}(x, y) = -\frac{1}{y^2}$, $f_{xy}(x, y) = 0$; $|x-1| \leq 0.2 \Rightarrow 0.98 \leq x \leq 1.2$ so the max of $|f_{xx}(x, y)|$ on R is $\frac{1}{(0.98)^2} \leq 1.04$; $|y-1| \leq 0.2 \Rightarrow 0.98 \leq y \leq 1.2$ so the max of $|f_{yy}(x, y)|$ on R is $\frac{1}{(0.98)^2} \leq 1.04 \Rightarrow M = 1.04$; thus $E(x, y) \leq \left(\frac{1}{2}\right)(1.04)(|x-1| + |y-1|)^2 \leq (0.52)(0.2 + 0.2)^2 = 0.0832$

39. (a) $f(1, 1, 1) = 3$, $f_x(1, 1, 1) = y + z|_{(1,1,1)} = 2$, $f_y(1, 1, 1) = x + z|_{(1,1,1)} = 2$, $f_z(1, 1, 1) = y + x|_{(1,1,1)} = 2$
 $\Rightarrow L(x, y, z) = 3 + 2(x-1) + 2(y-1) + 2(z-1) = 2x + 2y + 2z - 3$

(b) $f(1, 0, 0) = 0$, $f_x(1, 0, 0) = 0$, $f_y(1, 0, 0) = 1$, $f_z(1, 0, 0) = 1$
 $\Rightarrow L(x, y, z) = 0 + 0(x-1) + (y-0) + (z-0) = y + z$

(c) $f(0, 0, 0) = 0$, $f_x(0, 0, 0) = 0$, $f_y(0, 0, 0) = 0$, $f_z(0, 0, 0) = 0 \Rightarrow L(x, y, z) = 0$

40. (a) $f(1, 1, 1) = 3$, $f_x(1, 1, 1) = 2x|_{(1,1,1)} = 2$, $f_y(1, 1, 1) = 2y|_{(1,1,1)} = 2$, $f_z(1, 1, 1) = 2z|_{(1,1,1)} = 2$
 $\Rightarrow L(x, y, z) = 3 + 2(x-1) + 2(y-1) + 2(z-1) = 2x + 2y + 2z - 3$

(b) $f(0, 1, 0) = 1$, $f_x(0, 1, 0) = 0$, $f_y(0, 1, 0) = 2$, $f_z(0, 1, 0) = 0$
 $\Rightarrow L(x, y, z) = 1 + 0(x-0) + 2(y-1) + 0(z-0) = 2y - 1$

(c) $f(1, 0, 0) = 1$, $f_x(1, 0, 0) = 2$, $f_y(1, 0, 0) = 0$, $f_z(1, 0, 0) = 0$
 $\Rightarrow L(x, y, z) = 1 + 2(x-1) + 0(y-0) + 0(z-0) = 2x - 1$

41. (a) $f(1, 0, 0) = 1$, $f_x(1, 0, 0) = \frac{x}{\sqrt{x^2 + y^2 + z^2}} \Big|_{(1,0,0)} = 1$, $f_y(1, 0, 0) = \frac{y}{\sqrt{x^2 + y^2 + z^2}} \Big|_{(1,0,0)} = 0$,
 $f_z(1, 0, 0) = \frac{z}{\sqrt{x^2 + y^2 + z^2}} \Big|_{(1,0,0)} = 0 \Rightarrow L(x, y, z) = 1 + 1(x-1) + 0(y-0) + 0(z-0) = x$

(b) $f(1, 1, 0) = \sqrt{2}$, $f_x(1, 1, 0) = \frac{1}{\sqrt{2}}$, $f_y(1, 1, 0) = \frac{1}{\sqrt{2}}$, $f_z(1, 1, 0) = 0$
 $\Rightarrow L(x, y, z) = \sqrt{2} + \frac{1}{\sqrt{2}}(x-1) + \frac{1}{\sqrt{2}}(y-1) + 0(z-0) = \frac{1}{\sqrt{2}}x + \frac{1}{\sqrt{2}}y$

(c) $f(1, 2, 2) = 3$, $f_x(1, 2, 2) = \frac{1}{3}$, $f_y(1, 2, 2) = \frac{2}{3}$, $f_z(1, 2, 2) = \frac{2}{3}$
 $\Rightarrow L(x, y, z) = 3 + \frac{1}{3}(x-1) + \frac{2}{3}(y-2) + \frac{2}{3}(z-2) = \frac{1}{3}x + \frac{2}{3}y + \frac{2}{3}z$

42. (a) $f\left(\frac{\pi}{2}, 1, 1\right) = 1$, $f_x\left(\frac{\pi}{2}, 1, 1\right) = \frac{y \cos xy}{z} \Big|_{\left(\frac{\pi}{2}, 1, 1\right)} = 0$, $f_y\left(\frac{\pi}{2}, 1, 1\right) = \frac{x \cos xy}{z} \Big|_{\left(\frac{\pi}{2}, 1, 1\right)} = 0$,
 $f_z\left(\frac{\pi}{2}, 1, 1\right) = \frac{-\sin xy}{z^2} \Big|_{\left(\frac{\pi}{2}, 1, 1\right)} = -1 \Rightarrow L(x, y, z) = 1 + 0\left(x - \frac{\pi}{2}\right) + 0(y-1) - 1(z-1) = 2 - z$

(b) $f(2, 0, 1) = 0$, $f_x(2, 0, 1) = 0$, $f_y(2, 0, 1) = 2$, $f_z(2, 0, 1) = 0$
 $\Rightarrow L(x, y, z) = 0 + 0(x-2) + 2(y-0) + 0(z-1) = 2y$

43. (a) $f(0, 0, 0) = 2, f_x(0, 0, 0) = e^x \Big|_{(0,0,0)} = 1, f_y(0, 0, 0) = -\sin(y+z) \Big|_{(0,0,0)} = 0,$
 $f_z(0, 0, 0) = -\sin(y+z) \Big|_{(0,0,0)} = 0 \Rightarrow L(x, y, z) = 2 + 1(x-0) + 0(y-0) + 0(z-0) = 2 + x$

(b) $f(0, \frac{\pi}{2}, 0) = 1, f_x(0, \frac{\pi}{2}, 0) = 1, f_y(0, \frac{\pi}{2}, 0) = -1, f_z(0, \frac{\pi}{2}, 0) = -1,$
 $\Rightarrow L(x, y, z) = 1 + 1(x-0) - 1(y - \frac{\pi}{2}) - 1(z-0) = x - y - z + \frac{\pi}{2} + 1$

(c) $f(0, \frac{\pi}{4}, \frac{\pi}{4}) = 1, f_x(0, \frac{\pi}{4}, \frac{\pi}{4}) = 1, f_y(0, \frac{\pi}{4}, \frac{\pi}{4}) = -1, f_z(0, \frac{\pi}{4}, \frac{\pi}{4}) = -1,$
 $\Rightarrow L(x, y, z) = 1 + 1(x-0) - 1(y - \frac{\pi}{4}) - 1(z - \frac{\pi}{4}) = x - y - z + \frac{\pi}{2} + 1$

44. (a) $f(1, 0, 0) = 0, f_x(1, 0, 0) = \frac{yz}{(xyz)^2+1} \Big|_{(1,0,0)} = 0, f_y(1, 0, 0) = \frac{xz}{(xyz)^2+1} \Big|_{(1,0,0)} = 0,$
 $f_z(1, 0, 0) = \frac{xy}{(xyz)^2+1} \Big|_{(1,0,0)} = 0 \Rightarrow L(x, y, z) = 0$

(b) $f(1, 1, 0) = 0, f_x(1, 1, 0) = 0, f_y(1, 1, 0) = 0, f_z(1, 1, 0) = 1$
 $\Rightarrow L(x, y, z) = 0 + 0(x-1) + 0(y-1) + 1(z-0) = z$

(c) $f(1, 1, 1) = \frac{\pi}{4}, f_x(1, 1, 1) = \frac{1}{2}, f_y(1, 1, 1) = \frac{1}{2}, f_z(1, 1, 1) = \frac{1}{2}$
 $\Rightarrow L(x, y, z) = \frac{\pi}{4} + \frac{1}{2}(x-1) + \frac{1}{2}(y-1) + \frac{1}{2}(z-1) = \frac{1}{2}x + \frac{1}{2}y + \frac{1}{2}z + \frac{\pi}{4} - \frac{3}{2}$

45. $f(x, y, z) = xz - 3yz + 2$ at $P_0(1, 1, 2) \Rightarrow f(1, 1, 2) = -2; f_x = z, f_y = -3z, f_z = x - 3y$
 $\Rightarrow L(x, y, z) = -2 + 2(x-1) - 6(y-1) - 2(z-2) = 2x - 6y - 2z + 6; f_{xx} = 0, f_{yy} = 0, f_{zz} = 0, f_{xy} = 0, f_{yz} = -3$
 $\Rightarrow M = 3; \text{ thus, } |E(x, y, z)| \leq \left(\frac{1}{2}\right)(3)(0.01 + 0.01 + 0.02)^2 = 0.0024$

46. $f(x, y, z) = x^2 + xy + yz + \frac{1}{4}z^2$ at $P_0(1, 1, 2) \Rightarrow f(1, 1, 2) = 5; f_x = 2x + y, f_y = x + z, f_z = y + \frac{1}{2}z$
 $\Rightarrow L(x, y, z) = 5 + 3(x-1) + 3(y-1) + 2(z-2) = 3x + 3y + 2z - 5; f_{xx} = 2, f_{yy} = 0, f_{zz} = \frac{1}{2}, f_{xy} = 1, f_{xz} = 0,$
 $f_{yz} = 1 \Rightarrow M = 2; \text{ thus, } |E(x, y, z)| \leq \left(\frac{1}{2}\right)(2)(0.01 + 0.01 + 0.08)^2 = 0.01$

47. $f(x, y, z) = xy + 2yz - 3xz$ at $P_0(1, 1, 0) \Rightarrow f(1, 1, 0) = 1; f_x = y - 3z, f_y = x + 2z, f_z = 2y - 3x$
 $\Rightarrow L(x, y, z) = 1 + (x-1) + (y-1) - (z-0) = x + y - z - 1; f_{xx} = 0, f_{yy} = 0, f_{zz} = 0, f_{xy} = 1, f_{xz} = -3, f_{yz} = 2$
 $\Rightarrow M = 3; \text{ thus, } |E(x, y, z)| \leq \left(\frac{1}{2}\right)(3)(0.01 + 0.01 + 0.01)^2 = 0.00135$

48. $f(x, y, z) = \sqrt{2} \cos x \sin(y+z)$ at $P_0(0, 0, \frac{\pi}{4}) \Rightarrow f(0, 0, \frac{\pi}{4}) = 1; f_x = -\sqrt{2} \sin x \sin(y+z),$
 $f_y = \sqrt{2} \cos x \cos(y+z), f_z = \sqrt{2} \cos x \cos(y+z) \Rightarrow L(x, y, z) = 1 - 0(x-0) + (y-0) + \left(z - \frac{\pi}{4}\right) = y + z - \frac{\pi}{4} + 1;$
 $f_{xx} = -\sqrt{2} \cos x \sin(y+z), f_{yy} = -\sqrt{2} \cos x \sin(y+z), f_{zz} = -\sqrt{2} \cos x \sin(y+z),$
 $f_{xy} = -\sqrt{2} \sin x \cos(y+z), f_{xz} = -\sqrt{2} \sin x \cos(y+z), f_{yz} = -\sqrt{2} \cos x \sin(y+z).$ The absolute value of each of these second partial derivatives is bounded above by $\sqrt{2} \Rightarrow M = \sqrt{2};$ thus
 $|E(x, y, z)| \leq \left(\frac{1}{2}\right)(\sqrt{2})(0.01 + 0.01 + 0.01)^2 = 0.000636.$

49. $T_x(x, y) = e^y + e^{-y}$ and $T_y(x, y) = x(e^y - e^{-y}) \Rightarrow dT = T_x(x, y) dx + T_y(x, y) dy$
 $= (e^y + e^{-y}) dx + x(e^y - e^{-y}) dy \Rightarrow dT|_{(2, \ln 2)} = 2.5 dx + 3.0 dy$. If $|dx| \leq 0.1$ and $|dy| \leq 0.02$, then the maximum possible error in the computed value of T is $(2.5)(0.1) + (3.0)(0.02) = 0.31$ in magnitude.
50. $V_r = 2\pi rh$ and $V_h = \pi r^2 \Rightarrow dV = V_r dr + V_h dh \Rightarrow \frac{dV}{V} = \frac{2\pi rh dr + \pi r^2 dh}{\pi r^2 h} = \frac{2}{r} dr + \frac{1}{h} dh$; now $\left| \frac{dr}{r} \cdot 100 \right| \leq 1$ and $\left| \frac{dh}{h} \cdot 100 \right| \leq 1 \Rightarrow \left| \frac{dV}{V} \cdot 100 \right| \leq \left| 2 \frac{dr}{r} \right| + \left| \frac{dh}{h} \right| \leq 2 \left| \frac{dr}{r} \right| + \left| \frac{dh}{h} \right| \leq 2(1) + 1 = 3 \Rightarrow 3\%$
51. $\frac{dx}{x} \leq 0.02, \frac{dy}{y} \leq 0.03$
- (a) $S = 2x^2 + 4xy \Rightarrow dS = (4x + 4y)dx + 4x dy = (4x^2 + 4xy) \frac{dx}{x} + 4xy \frac{dy}{y} \leq (4x^2 + 4xy)(0.02) + (4xy)(0.03)$
 $= 0.04(2x^2) + 0.05(4xy) \leq 0.05(2x^2) + 0.05(4xy) = (0.05)(2x^2 + 4xy) = 0.05S$
- (b) $V = x^2 y \Rightarrow dV = 2xy dx + x^2 dy = 2x^2 y \frac{dx}{x} + x^2 y \frac{dy}{y} \leq (2x^2 y)(0.02) + (x^2 y)(0.03) = 0.07(x^2 y) = 0.07V$
52. $V = \frac{4\pi}{3} r^3 + \pi r^2 h \Rightarrow dV = (4\pi r^2 + 2\pi rh) dr + \pi r^2 dh; r = 10, h = 15, dr = \frac{1}{2}$ and $dh = 0$
 $\Rightarrow dV = (4\pi(10)^2 + 2\pi(10)(15))\left(\frac{1}{2}\right) + \pi(10)^2(0) = 350\pi \text{ cm}^3$
53. $V_r = 2\pi rh$ and $V_h = \pi r^2 \Rightarrow dV = V_r dr + V_h dh \Rightarrow dV = 2\pi rh dr + \pi r^2 dh \Rightarrow dV|_{(5, 12)} = 120\pi dr + 25\pi dh;$
 $|dr| \leq 0.1 \text{ cm}$ and $|dh| \leq 0.1 \text{ cm} \Rightarrow dV \leq (120\pi)(0.1) + (25\pi)(0.1) = 14.5\pi \text{ cm}^3; V(5, 12) = 300\pi \text{ cm}^3$
 \Rightarrow maximum percentage error is $\pm \frac{14.5\pi}{300\pi} \times 100 = \pm 4.83\%$
54. (a) $\frac{1}{R} = \frac{1}{R_1} + \frac{1}{R_2} \Rightarrow -\frac{1}{R^2} dR = -\frac{1}{R_1^2} dR_1 - \frac{1}{R_2^2} dR_2 \Rightarrow dR = \left(\frac{R}{R_1}\right)^2 dR_1 + \left(\frac{R}{R_2}\right)^2 dR_2$
- (b) $dR = R^2 \left[\left(\frac{1}{R_1^2}\right) dR_1 + \left(\frac{1}{R_2^2}\right) dR_2 \right] \Rightarrow dR|_{(100, 400)} = R^2 \left[\frac{1}{(100)^2} dR_1 + \frac{1}{(400)^2} dR_2 \right]$
 $\Rightarrow R$ will be more sensitive to a variation in R_1 since $\frac{1}{(100)^2} > \frac{1}{(400)^2}$
- (c) From part (a), $dR = \left(\frac{R}{R_1}\right)^2 dR_1 + \left(\frac{R}{R_2}\right)^2 dR_2$ so that R_1 changing from 20 to 20.1 ohms
 $\Rightarrow dR_1 = 0.1 \text{ ohm}$ and R_2 changing from 25 to 24.9 ohms $\Rightarrow dR_2 = -0.1 \text{ ohms}; \frac{1}{R} = \frac{1}{R_1} + \frac{1}{R_2}$
 $\Rightarrow R = \frac{100}{9} \text{ ohms} \Rightarrow dR|_{(20, 25)} = \frac{\left(\frac{100}{9}\right)^2}{(20)^2} (0.1) + \frac{\left(\frac{100}{9}\right)^2}{(25)^2} (-0.1) \approx 0.011 \text{ ohms}$
 \Rightarrow percentage change is $\Rightarrow \frac{dR}{R}|_{(20, 25)} \times 100 = \frac{0.011}{\left(\frac{100}{9}\right)} \times 100 \approx 0.1\%$
55. $A = xy \Rightarrow dA = x dy + y dx$; if $x > y$ then a 1-unit change in y gives a greater change in dA than a 1-unit change in x . Thus, pay more attention to y which is the smaller of the two dimensions.

56. (a) $f_x(x, y) = 2x(y+1) \Rightarrow f_x(1, 0) = 2$ and $f_y(x, y) = x^2 \Rightarrow f_y(1, 0) = 1 \Rightarrow df = 2 dx + 1 dy$
 $\Rightarrow df$ is more sensitive to changes in x
 (b) $df = 0 \Rightarrow 2 dx + dy = 0 \Rightarrow 2 \frac{dx}{dy} + 1 = 0 \Rightarrow \frac{dx}{dy} = -\frac{1}{2}$
57. (a) $r^2 = x^2 + y^2 \Rightarrow 2r dr = 2x dx + 2y dy \Rightarrow dr = \frac{x}{r} dx + \frac{y}{r} dy \Rightarrow dr|_{(3, 4)} = \left(\frac{3}{5}\right)(\pm 0.01) + \left(\frac{4}{5}\right)(\pm 0.01)$
 $= \pm \frac{0.07}{5} = \pm 0.014 \Rightarrow \left| \frac{dr}{r} \times 100 \right| = \left| \pm \frac{0.014}{5} \times 100 \right| = 0.28\%$; $d\theta = \frac{\left(\frac{-y}{x^2}\right) dx + \left(\frac{1}{x}\right) dy}{\left(\frac{y}{x}\right)^2 + 1}$
 $= \frac{-y}{y^2+x^2} dx + \frac{x}{y^2+x^2} dy \Rightarrow d\theta|_{(3, 4)} = \left(\frac{-4}{25}\right)(\pm 0.01) + \left(\frac{3}{25}\right)(\pm 0.01) = \frac{\mp 0.04}{25} + \frac{\pm 0.03}{25} \Rightarrow$ maximum change in $d\theta$
 occurs when dx and dy have opposite signs ($dx = 0.01$ and $dy = -0.01$ or vice versa)
 $\Rightarrow d\theta = \frac{\pm 0.07}{25} \approx \pm 0.0028$; $\theta = \tan^{-1}\left(\frac{4}{3}\right) \approx 0.927255218 \Rightarrow \left| \frac{d\theta}{\theta} \times 100 \right| = \left| \frac{\pm 0.0028}{0.927255218} \times 100 \right| \approx 0.30\%$
 (b) the radius r is more sensitive to changes in y , and the angle θ is more sensitive to changes in x
58. (a) $V = \pi r^2 h \Rightarrow dV = 2\pi r h dr + \pi r^2 dh \Rightarrow$ at $r = 1$ and $h = 5$ we have $dV = 10\pi dr + \pi dh \Rightarrow$ the volume is about 10 times more sensitive to a change in r
 (b) $dV = 0 \Rightarrow 0 = 2\pi r h dr + \pi r^2 dh = 2h dr + r dh = 10 dr + dh \Rightarrow dr = -\frac{1}{10} dh$; choose $dh = 1.5 \Rightarrow dr = -0.15 \Rightarrow h = 6.5$ in. and $r = 0.85$ in. is one solution for $\Delta V \approx dV = 0$
59. $f(a, b, c, d) = \begin{vmatrix} a & b \\ c & d \end{vmatrix} = ad - bc \Rightarrow f_a = d, f_b = -c, f_c = -b, f_d = a \Rightarrow df = d da - c db - b dc + a dd$;
 since $|a|$ is much greater than $|b|, |c|,$ and $|d|$, the function f is most sensitive to a change in d .
60. $u_x = e^y, u_y = xe^y + \sin z, u_z = y \cos z \Rightarrow du = e^y dx + (xe^y + \sin z) dy + (y \cos z) dz$
 $\Rightarrow du|_{(2, \ln 3, \frac{\pi}{2})} = 3 dx + 7 dy + 0 dz = 3 dx + 7 dy \Rightarrow$ magnitude of the maximum possible error
 $\leq 3(0.2) + 7(0.6) = 4.8$
61. $Q_K = \frac{1}{2} \left(\frac{2KM}{h}\right)^{-1/2} \left(\frac{2M}{h}\right), Q_M = \frac{1}{2} \left(\frac{2KM}{h}\right)^{-1/2} \left(\frac{2K}{h}\right), \text{ and } Q_h = \frac{1}{2} \left(\frac{2KM}{h}\right)^{-1/2} \left(\frac{-2KM}{h^2}\right)$
 $\Rightarrow dQ = \frac{1}{2} \left(\frac{2KM}{h}\right)^{-1/2} \left(\frac{2M}{h}\right) dK + \frac{1}{2} \left(\frac{2KM}{h}\right)^{-1/2} \left(\frac{2K}{h}\right) dM + \frac{1}{2} \left(\frac{2KM}{h}\right)^{-1/2} \left(\frac{-2KM}{h^2}\right) dh$
 $= \frac{1}{2} \left(\frac{2KM}{h}\right)^{-1/2} \left[\frac{2M}{h} dK + \frac{2K}{h} dM - \frac{2KM}{h^2} dh \right]$
 $\Rightarrow dQ|_{(2, 20, 0.05)} = \frac{1}{2} \left[\frac{(2)(20)}{0.05} \right]^{-1/2} \left[\frac{(2)(20)}{0.05} dK + \frac{(2)(2)}{0.05} dM - \frac{(2)(2)(20)}{(0.05)^2} dh \right]$
 $= (0.0125)(800 dK + 80 dM - 32,000 dh) \Rightarrow Q$ is most sensitive to changes in h
62. $A = \frac{1}{2} ab \sin C \Rightarrow A_a = \frac{1}{2} b \sin C, A_b = \frac{1}{2} a \sin C, A_c = \frac{1}{2} ab \cos C$
 $\Rightarrow dA = \left(\frac{1}{2} b \sin C\right) da + \left(\frac{1}{2} a \sin C\right) db + \left(\frac{1}{2} ab \cos C\right) dC$; $dC = |2^\circ| = |0.0349|$ radians, $da = |0.5|$ ft, $db = |0.5|$ ft;
 at $a = 150$ ft, $b = 200$ ft, and $C = 60^\circ$, we that the change is approximately
 $dA = \frac{1}{2}(200)(\sin 60^\circ)|0.5| + \frac{1}{2}(150)(\sin 60^\circ)|0.5| + \frac{1}{2}(200)(150)(\cos 60^\circ)|0.0349| = \pm 338 \text{ ft}^2$

63. $z = f(x, y) \Rightarrow g(x, y, z) = f(x, y) - z = 0 \Rightarrow g_x(x, y, z) = f_x(x, y), g_y(x, y, z) = f_y(x, y)$ and $g_z(x, y, z) = -1 \Rightarrow g_x(x_0, y_0, f(x_0, y_0)) = f_x(x_0, y_0), g_y(x_0, y_0, f(x_0, y_0)) = f_y(x_0, y_0)$ and $g_z(x_0, y_0, f(x_0, y_0)) = -1 \Rightarrow$ the tangent plane at the point P_0 is $f_x(x_0, y_0)(x - x_0) + f_y(x_0, y_0)(y - y_0) - [z - f(x_0, y_0)] = 0$ or $z = f_x(x_0, y_0)(x - x_0) + f_y(x_0, y_0)(y - y_0) + f(x_0, y_0)$
64. $\nabla f = 2x\mathbf{i} + 2y\mathbf{j} = 2(\cos t + t \sin t)\mathbf{i} + 2(\sin t - t \cos t)\mathbf{j}$ and $\mathbf{v} = (t \cos t)\mathbf{i} + (t \sin t)\mathbf{j} \Rightarrow \mathbf{u} = \frac{\mathbf{v}}{|\mathbf{v}|} = \frac{(t \cos t)\mathbf{i} + (t \sin t)\mathbf{j}}{\sqrt{(t \cos t)^2 + (t \sin t)^2}}$
 $= (\cos t)\mathbf{i} + (\sin t)\mathbf{j}$ since $t > 0 \Rightarrow (D_{\mathbf{u}}f)_{P_0} = \nabla f \cdot \mathbf{u} = 2(\cos t + t \sin t)(\cos t) + 2(\sin t - t \cos t)(\sin t) = 2$
65. $\nabla f = 2x\mathbf{i} + 2y\mathbf{j} + 2z\mathbf{k} = 2(\cos t)\mathbf{i} + 2(\sin t)\mathbf{j} + 2t\mathbf{k}$ and $\mathbf{v} = (-\sin t)\mathbf{i} + (\cos t)\mathbf{j} + \mathbf{k} \Rightarrow \mathbf{u} = \frac{\mathbf{v}}{|\mathbf{v}|} = \frac{(-\sin t)\mathbf{i} + (\cos t)\mathbf{j} + \mathbf{k}}{\sqrt{(-\sin t)^2 + (\cos t)^2 + 1^2}}$
 $= \left(\frac{-\sin t}{\sqrt{2}}\right)\mathbf{i} + \left(\frac{\cos t}{\sqrt{2}}\right)\mathbf{j} + \frac{1}{\sqrt{2}}\mathbf{k} \Rightarrow (D_{\mathbf{u}}f)_{P_0} = \nabla f \cdot \mathbf{u} = (2 \cos t)\left(\frac{-\sin t}{\sqrt{2}}\right) + (2 \sin t)\left(\frac{\cos t}{\sqrt{2}}\right) + (2t)\left(\frac{1}{\sqrt{2}}\right) = \frac{2t}{\sqrt{2}}$
 $\Rightarrow (D_{\mathbf{u}}f)\left(-\frac{\pi}{4}\right) = -\frac{\pi}{2\sqrt{2}}, (D_{\mathbf{u}}f)(0) = 0$ and $(D_{\mathbf{u}}f)\left(\frac{\pi}{4}\right) = \frac{\pi}{2\sqrt{2}}$
66. $r = \sqrt{t}\mathbf{i} + \sqrt{t}\mathbf{j} - \frac{1}{4}(t+3)\mathbf{k} \Rightarrow \mathbf{v} = \frac{1}{2}t^{-1/2}\mathbf{i} + \frac{1}{2}t^{-1/2}\mathbf{j} - \frac{1}{4}\mathbf{k}; t = 1 \Rightarrow x = 1, y = 1, z = -1 \Rightarrow P_0 = (1, 1, -1)$ and $\mathbf{v}(1) = \frac{1}{2}\mathbf{i} + \frac{1}{2}\mathbf{j} - \frac{1}{4}\mathbf{k}; f(x, y, z) = x^2 + y^2 - z - 3 = 0 \Rightarrow \nabla f = 2x\mathbf{i} + 2y\mathbf{j} - \mathbf{k} \Rightarrow \nabla f(1, 1, -1) = 2\mathbf{i} + 2\mathbf{j} - \mathbf{k};$
 therefore $\mathbf{v} = \frac{1}{4}(\nabla f) \Rightarrow$ the curve is normal to the surface
67. $r = \sqrt{t}\mathbf{i} + \sqrt{t}\mathbf{j} + (2t-1)\mathbf{k} \Rightarrow \mathbf{v} = \frac{1}{2}t^{-1/2}\mathbf{i} + \frac{1}{2}t^{-1/2}\mathbf{j} + 2\mathbf{k}; t = 1 \Rightarrow x = 1, y = 1, z = 1 \Rightarrow P_0 = (1, 1, 1)$ and $\mathbf{v}(1) = \frac{1}{2}\mathbf{i} + \frac{1}{2}\mathbf{j} + 2\mathbf{k}; f(x, y, z) = x^2 + y^2 - z - 1 = 0 \Rightarrow \nabla f = 2x\mathbf{i} + 2y\mathbf{j} - \mathbf{k} \Rightarrow \nabla f(1, 1, 1) = 2\mathbf{i} + 2\mathbf{j} - \mathbf{k};$
 now $\mathbf{v}(1) \cdot \nabla f(1, 1, 1) = 0$, thus the curve is tangent to the surface when $t = 1$

14.7 EXTREME VALUES AND SADDLE POINTS

1. $f_x(x, y) = 2x + y + 3 = 0$ and $f_y(x, y) = x + 2y - 3 = 0 \Rightarrow x = -3$ and $y = 3 \Rightarrow$ critical point is $(-3, 3)$;
 $f_{xx}(-3, 3) = 2$, $f_{yy}(-3, 3) = 2$, $f_{xy}(-3, 3) = 1 \Rightarrow f_{xx}f_{yy} - f_{xy}^2 = 3 > 0$ and $f_{xx} > 0 \Rightarrow$ local minimum of
 $f(-3, 3) = -5$
2. $f_x(x, y) = 2y - 10x + 4 = 0$ and $f_y(x, y) = 2x - 4y + 4 = 0 \Rightarrow x = \frac{2}{3}$ and $y = \frac{4}{3} \Rightarrow$ critical point is $(\frac{2}{3}, \frac{4}{3})$;
 $f_{xx}(\frac{2}{3}, \frac{4}{3}) = -10$, $f_{yy}(\frac{2}{3}, \frac{4}{3}) = -4$, $f_{xy}(\frac{2}{3}, \frac{4}{3}) = 2 \Rightarrow f_{xx}f_{yy} - f_{xy}^2 = 36 > 0$ and $f_{xx} < 0 \Rightarrow$ local maximum of
 $f(\frac{2}{3}, \frac{4}{3}) = 0$
3. $f_x(x, y) = 2x + y + 3 = 0$ and $f_y(x, y) = x + 2 = 0 \Rightarrow x = -2$ and $y = 1 \Rightarrow$ critical point is $(-2, 1)$;
 $f_{xx}(-2, 1) = 2$, $f_{yy}(-2, 1) = 0$, $f_{xy}(-2, 1) = 1 \Rightarrow f_{xx}f_{yy} - f_{xy}^2 = -1 < 0 \Rightarrow$ saddle point
4. $f_x(x, y) = 5y - 14x + 3 = 0$ and $f_y(x, y) = 5x - 6 = 0 \Rightarrow x = \frac{6}{5}$ and $y = \frac{69}{25} \Rightarrow$ critical point is $(\frac{6}{5}, \frac{69}{25})$;
 $f_{xx}(\frac{6}{5}, \frac{69}{25}) = -14$, $f_{yy}(\frac{6}{5}, \frac{69}{25}) = 0$, $f_{xy}(\frac{6}{5}, \frac{69}{25}) = 5 \Rightarrow f_{xx}f_{yy} - f_{xy}^2 = -25 < 0 \Rightarrow$ saddle point
5. $f_x(x, y) = 2y - 2x + 3 = 0$ and $f_y(x, y) = 2x - 4y = 0 \Rightarrow x = 3$ and $y = \frac{3}{2} \Rightarrow$ critical point is $(3, \frac{3}{2})$;
 $f_{xx}(3, \frac{3}{2}) = -2$, $f_{yy}(3, \frac{3}{2}) = -4$, $f_{xy}(3, \frac{3}{2}) = 2 \Rightarrow f_{xx}f_{yy} - f_{xy}^2 = 4 > 0$ and $f_{xx} < 0 \Rightarrow$ local maximum of
 $f(3, \frac{3}{2}) = \frac{17}{2}$
6. $f_x(x, y) = 2x - 4y = 0$ and $f_y(x, y) = -4x + 2y + 6 = 0 \Rightarrow x = 2$ and $y = 1 \Rightarrow$ critical point is $(2, 1)$;
 $f_{xx}(2, 1) = 2$, $f_{yy}(2, 1) = 2$, $f_{xy}(2, 1) = -4 \Rightarrow f_{xx}f_{yy} - f_{xy}^2 = -12 < 0 \Rightarrow$ saddle point
7. $f_x(x, y) = 4x + 3y - 5 = 0$ and $f_y(x, y) = 3x + 8y + 2 = 0 \Rightarrow x = 2$ and $y = -1 \Rightarrow$ critical point is $(2, -1)$;
 $f_{xx}(2, -1) = 4$, $f_{yy}(2, -1) = 8$, $f_{xy}(2, -1) = 3 \Rightarrow f_{xx}f_{yy} - f_{xy}^2 = 23 > 0$ and $f_{xx} > 0 \Rightarrow$ local minimum of
 $f(2, -1) = -6$
8. $f_x(x, y) = 2x - 2y - 2 = 0$ and $f_y(x, y) = -2x + 4y + 2 = 0 \Rightarrow x = 1$ and $y = 0 \Rightarrow$ critical point is $(1, 0)$;
 $f_{xx}(1, 0) = 2$, $f_{yy}(1, 0) = 4$, $f_{xy}(1, 0) = -2 \Rightarrow f_{xx}f_{yy} - f_{xy}^2 = -4 > 0$ and $f_{xx} > 0 \Rightarrow$ local minimum of
 $f(1, 0) = 0$
9. $f_x(x, y) = 2x - 2 = 0$ and $f_y(x, y) = -2y + 4 = 0 \Rightarrow x = 1$ and $y = 2 \Rightarrow$ critical point is $(1, 2)$;
 $f_{xx}(1, 2) = 2$, $f_{yy}(1, 2) = -2$, $f_{xy}(1, 2) = 0 \Rightarrow f_{xx}f_{yy} - f_{xy}^2 = -4 < 0 \Rightarrow$ saddle point
10. $f_x(x, y) = 2x + 2y = 0$ and $f_y(x, y) = 2x = 0 \Rightarrow x = 0$ and $y = 0 \Rightarrow$ critical point is $(0, 0)$;
 $f_{xx}(0, 0) = 2$, $f_{yy}(0, 0) = 0$, $f_{xy}(0, 0) = 2 \Rightarrow f_{xx}f_{yy} - f_{xy}^2 = -4 < 0 \Rightarrow$ saddle point

11. $f_x(x, y) = \frac{112x-8y}{\sqrt{56x^2-8y^2-16x-31}} - 8 = 0$ and $f_y(x, y) = \frac{-8y}{\sqrt{56x^2-8y^2-16x-31}} = 0 \Rightarrow$ critical point is $\left(\frac{16}{7}, 0\right)$;
 $f_{xx}\left(\frac{16}{7}, 0\right) = -\frac{8}{15}$, $f_{yy}\left(\frac{16}{7}, 0\right) = -\frac{8}{15}$, $f_{xy}\left(\frac{16}{7}, 0\right) = 0 \Rightarrow f_{xx}f_{yy} - f_{xy}^2 = \frac{64}{225} > 0$ and $f_{xx} < 0 \Rightarrow$ local maximum
of $f\left(\frac{16}{7}, 0\right) = -\frac{16}{7}$
12. $f_x(x, y) = \frac{-2x}{3(x^2+y^2)^{2/3}} = 0$ and $f_y(x, y) = \frac{-2y}{3(x^2+y^2)^{2/3}} = 0 \Rightarrow$ there are no solutions to the system $f_x(x, y) = 0$
and $f_y(x, y) = 0$, however, we must also consider where the partials are undefined, and this occurs when
 $x = 0$ and $y = 0 \Rightarrow$ critical point is $(0, 0)$. Note that the partial derivatives are defined at every other point
other than $(0, 0)$. We cannot use the second derivative test, but this is the only possible local maximum, local
minimum, or saddle point. $f(x, y)$ has a local maximum of $f(0, 0) = 1$ at $(0, 0)$ since
 $f(x, y) = 1 - \sqrt[3]{x^2 + y^2} \leq 1$ for all (x, y) other than $(0, 0)$
13. $f_x(x, y) = 3x^2 - 2y = 0$ and $f_y(x, y) = -3y^2 - 2x = 0 \Rightarrow x = 0$ and $y = 0$, or $x = -\frac{2}{3}$ and $y = \frac{2}{3} \Rightarrow$ critical
points are $(0, 0)$ and $\left(-\frac{2}{3}, \frac{2}{3}\right)$; for $(0, 0)$: $f_{xx}(0, 0) = 6x|_{(0,0)} = 0$, $f_{yy}(0, 0) = -6y|_{(0,0)} = 0$, $f_{xy}(0, 0) = -2$
 $\Rightarrow f_{xx}f_{yy} - f_{xy}^2 = -4 < 0 \Rightarrow$ saddle point; for $\left(-\frac{2}{3}, \frac{2}{3}\right)$: $f_{xx}\left(-\frac{2}{3}, \frac{2}{3}\right) = -4$, $f_{yy}\left(-\frac{2}{3}, \frac{2}{3}\right) = -4$, $f_{xy}\left(-\frac{2}{3}, \frac{2}{3}\right) = -2$
 $\Rightarrow f_{xx}f_{yy} - f_{xy}^2 = 12 > 0$ and $f_{xx} < 0 \Rightarrow$ local maximum of $f\left(-\frac{2}{3}, \frac{2}{3}\right) = \frac{170}{27}$
14. $f_x(x, y) = 3x^2 + 3y = 0$ and $f_y(x, y) = 3x + 3y^2 = 0 \Rightarrow x = 0$ and $y = 0$, or $x = -1$ and $y = -1 \Rightarrow$ critical
points are $(0, 0)$ and $(-1, -1)$; for $(0, 0)$: $f_{xx}(0, 0) = 6x|_{(0,0)} = 0$, $f_{yy}(0, 0) = 6y|_{(0,0)} = 0$, $f_{xy}(0, 0) = 3$
 $\Rightarrow f_{xx}f_{yy} - f_{xy}^2 = -9 < 0 \Rightarrow$ saddle point; for $(-1, -1)$: $f_{xx}(-1, -1) = -6$, $f_{yy}(-1, -1) = -6$, $f_{xy}(-1, -1) = 3$
 $\Rightarrow f_{xx}f_{yy} - f_{xy}^2 = 27 > 0$ and $f_{xx} < 0 \Rightarrow$ local maximum of $f(-1, -1) = 1$
15. $f_x(x, y) = 12x - 6x^2 + 6y = 0$ and $f_y(x, y) = 6y + 6x = 0 \Rightarrow x = 0$ and $y = 0$, or $x = 1$ and $y = -1 \Rightarrow$ critical
points are $(0, 0)$ and $(1, -1)$; for $(0, 0)$: $f_{xx}(0, 0) = 12 - 12x|_{(0,0)} = 12$, $f_{yy}(0, 0) = 6$, $f_{xy}(0, 0) = 6$
 $\Rightarrow f_{xx}f_{yy} - f_{xy}^2 = 36 > 0$ and $f_{xx} > 0 \Rightarrow$ local minimum of $f(0, 0) = 0$; for $(1, -1)$: $f_{xx}(1, -1) = 0$,
 $f_{yy}(1, -1) = 6$, $f_{xy}(1, -1) = 6 \Rightarrow f_{xx}f_{yy} - f_{xy}^2 = -36 < 0 \Rightarrow$ saddle point
16. $f_x(x, y) = 3x^2 + 6x = 0 \Rightarrow x = 0$ or $x = -2$; $f_y(x, y) = 3x^2 - 6y = 0 \Rightarrow y = 0$ or $y = 2 \Rightarrow$ the critical points
are $(0, 0)$, $(0, 2)$, $(-2, 0)$, and $(-2, 2)$; for $(0, 0)$: $f_{xx}(0, 0) = 6x + 6|_{(0,0)} = 6$, $f_{yy}(0, 0) = 6y - 6|_{(0,0)} = -6$,
 $f_{xy}(0, 0) = 0 \Rightarrow f_{xx}f_{yy} - f_{xy}^2 = -36 < 0 \Rightarrow$ saddle point; for $(0, 2)$: $f_{xx}(0, 2) = 6$, $f_{yy}(0, 2) = 6$, $f_{xy}(0, 2) = 0$
 $\Rightarrow f_{xx}f_{yy} - f_{xy}^2 = 36 > 0$ and $f_{xx} > 0 \Rightarrow$ local minimum of $f(0, 2) = -12$; for $(-2, 0)$: $f_{xx}(-2, 0) = -6$,
 $f_{yy}(-2, 0) = -6$, $f_{xy}(-2, 0) = 0 \Rightarrow f_{xx}f_{yy} - f_{xy}^2 = 36 > 0$ and $f_{xx} < 0 \Rightarrow$ local maximum of $f(-2, 0) = -4$; for
 $(-2, 2)$: $f_{xx}(-2, 2) = -6$, $f_{yy}(-2, 2) = 6$, $f_{xy}(-2, 2) = 0 \Rightarrow f_{xx}f_{yy} - f_{xy}^2 = -36 < 0 \Rightarrow$ saddle point

17. $f_x(x, y) = 3x^2 + 3y^2 - 15 = 0$ and $f_y(x, y) = 6xy + 3y^2 - 15 = 0 \Rightarrow$ critical points are $(2, 1)$, $(-2, -1)$, $(0, \sqrt{5})$, and $(0, -\sqrt{5})$; for $(2, 1)$: $f_{xx}(2, 1) = 6x|_{(2,1)} = 12$, $f_{yy}(2, 1) = (6x + 6y)|_{(2,1)} = 18$, $f_{xy}(2, 1) = 6y|_{(2,1)} = 6$
 $\Rightarrow f_{xx}f_{yy} - f_{xy}^2 = 180 > 0$ and $f_{xx} > 0 \Rightarrow$ local minimum of $f(2, 1) = -30$; for $(-2, -1)$:
 $f_{xx}(-2, -1) = 6x|_{(-2,-1)} = -12$, $f_{yy}(-2, -1) = (6x + 6y)|_{(-2,-1)} = -18$, $f_{xy}(-2, -1) = 6y|_{(-2,-1)} = -6$
 $\Rightarrow f_{xx}f_{yy} - f_{xy}^2 = 180 > 0$ and $f_{xx} < 0 \Rightarrow$ local maximum of $f(-2, -1) = 30$; for $(0, -\sqrt{5})$:
 $f_{xx}(0, -\sqrt{5}) = 6x|_{(0,\sqrt{5})} = 0$, $f_{yy}(0, \sqrt{5}) = (6x + 6y)|_{(0,\sqrt{5})} = 6\sqrt{5}$, $f_{xy}(0, \sqrt{5}) = 6y|_{(0,\sqrt{5})} = 6\sqrt{5}$
 $\Rightarrow f_{xx}f_{yy} - f_{xy}^2 = -180 < 0 \Rightarrow$ saddle point; for $(0, -\sqrt{5})$: $f_{xx}(0, -\sqrt{5}) = 6x|_{(0,-\sqrt{5})} = 0$
 $f_{yy}(0, -\sqrt{5}) = (6x + 6y)|_{(0,-\sqrt{5})} = -6\sqrt{5}$, $f_{xy}(0, -\sqrt{5}) = 6y|_{(0,-\sqrt{5})} = -6\sqrt{5} \Rightarrow f_{xx}f_{yy} - f_{xy}^2 = -180 < 0$
 \Rightarrow saddle point.
18. $f_x(x, y) = 6x^2 - 18x = 0 \Rightarrow 6x(x - 3) = 0 \Rightarrow x = 0$ or $x = 3$; $f_y(x, y) = 6y^2 + 6y - 12 = 0 \Rightarrow 6(y + 2)(y - 1) = 0$
 $\Rightarrow y = -2$ or $y = 1 \Rightarrow$ the critical points are $(0, -2)$, $(0, 1)$, $(3, -2)$, and $(3, 1)$; $f_{xx}(x, y) = 12x - 18$,
 $f_{yy}(x, y) = 12y + 6$, and $f_{xy}(x, y) = 0$; for $(0, -2)$: $f_{xx}(0, -2) = -18$, $f_{yy}(0, -2) = -18$, $f_{xy}(0, -2) = 0$
 $\Rightarrow f_{xx}f_{yy} - f_{xy}^2 = 324 > 0$ and $f_{xx} < 0 \Rightarrow$ local maximum of $f(0, -2) = 20$; for $(0, 1)$: $f_{xx}(0, 1) = -18$,
 $f_{yy}(0, 1) = 18$, $f_{xy}(0, 1) = 0 \Rightarrow f_{xx}f_{yy} - f_{xy}^2 = -324 < 0 \Rightarrow$ saddle point; for $(3, -2)$: $f_{xx}(3, -2) = 18$,
 $f_{yy}(3, -2) = -18$, $f_{xy}(3, -2) = 0 \Rightarrow f_{xx}f_{yy} - f_{xy}^2 = -324 < 0 \Rightarrow$ saddle point; for $(3, 1)$: $f_{xx}(3, 1) = 18$,
 $f_{yy}(3, 1) = 18$, $f_{xy}(3, 1) = 0 \Rightarrow f_{xx}f_{yy} - f_{xy}^2 = 324 > 0$ and $f_{xx} > 0 \Rightarrow$ local minimum of $f(3, 1) = -34$
19. $f_x(x, y) = 4y - 4x^3 = 0$ and $f_y(x, y) = 4x - 4y^3 = 0 \Rightarrow x = y \Rightarrow x(1 - x^2) = 0 \Rightarrow x = 0, 1, -1 \Rightarrow$ the critical points are $(0, 0)$, $(1, 1)$, and $(-1, -1)$; for $(0, 0)$: $f_{xx}(0, 0) = -12x^2|_{(0,0)} = 0$, $f_{yy}(0, 0) = -12y^2|_{(0,0)} = 0$,
 $f_{xy}(0, 0) = 4 \Rightarrow f_{xx}f_{yy} - f_{xy}^2 = -16 < 0 \Rightarrow$ saddle point; for $(1, 1)$: $f_{xx}(1, 1) = -12$, $f_{yy}(1, 1) = -12$, $f_{xy}(1, 1) = 4$
 $\Rightarrow f_{xx}f_{yy} - f_{xy}^2 = 128 > 0$ and $f_{xx} < 0 \Rightarrow$ local maximum of $f(1, 1) = 2$; for $(-1, -1)$: $f_{xx}(-1, -1) = -12$,
 $f_{yy}(-1, -1) = -12$, $f_{xy}(-1, -1) = 4 \Rightarrow f_{xx}f_{yy} - f_{xy}^2 = 128 > 0$ and $f_{xx} < 0 \Rightarrow$ local maximum of $f(-1, -1) = 2$
20. $f_x(x, y) = 4x^3 + 4y = 0$ and $f_y(x, y) = 4y^3 + 4x = 0 \Rightarrow x = -y \Rightarrow -x^3 + x = 0 \Rightarrow x(1 - x^2) = 0 \Rightarrow x = 0, 1, -1$
 \Rightarrow the critical points are $(0, 0)$, $(1, -1)$, and $(-1, 1)$; $f_{xx}(x, y) = 12x^2$, $f_{yy}(x, y) = 12y^2$, and $f_{xy}(x, y) = 4$;
for $(0, 0)$: $f_{xx}(0, 0) = 0$, $f_{yy}(0, 0) = 0$, $f_{xy}(0, 0) = 4 \Rightarrow f_{xx}f_{yy} - f_{xy}^2 = -16 < 0 \Rightarrow$ saddle point; for $(1, -1)$:
 $f_{xx}(1, -1) = 12$, $f_{yy}(1, -1) = 12$, $f_{xy}(1, -1) = 4 \Rightarrow f_{xx}f_{yy} - f_{xy}^2 = 128 > 0$ and $f_{xx} > 0 \Rightarrow$ local minimum of
 $f(1, -1) = -2$; for $(-1, 1)$: $f_{xx}(-1, 1) = 12$, $f_{yy}(-1, 1) = 12$, $f_{xy}(-1, 1) = 4 \Rightarrow f_{xx}f_{yy} - f_{xy}^2 = 128 > 0$ and
 $f_{xx} > 0 \Rightarrow$ local minimum of $f(-1, 1) = -2$

21. $f_x(x, y) = \frac{-2x}{(x^2+y^2-1)^2} = 0$ and $f_y(x, y) = \frac{-2y}{(x^2+y^2-1)^2} = 0 \Rightarrow x = 0$ and $y = 0 \Rightarrow$ the critical points is $(0, 0)$;
 $f_{xx} = \frac{4x^2-2y^2+2}{(x^2+y^2-1)^3}$, $f_{yy} = \frac{-2x^2+4y^2+2}{(x^2+y^2-1)^3}$, $f_{xy} = \frac{8xy}{(x^2+y^2-1)^3}$; $f_{xx}(0, 0) = -2$, $f_{yy}(0, 0) = -2$, $f_{xy}(0, 0) = 0$
 $\Rightarrow f_{xx}f_{yy} - f_{xy}^2 = 4 > 0$ and $f_{xx} < 0 \Rightarrow$ local maximum of $f(0, 0) = -1$
22. $f_x(x, y) = -\frac{1}{x^2} + y = 0$ and $f_y(x, y) = x - \frac{1}{y^2} = 0 \Rightarrow x = 1 \Rightarrow$ and $y = 1$ the critical point is $(1, 1)$;
 $f_{xx} = \frac{2}{x^3}$, $f_{yy} = \frac{2}{y^3}$, $f_{xy} = 1$; $f_{xx}(1, 1) = 2$, $f_{yy}(1, 1) = 2$, $f_{xy}(1, 1) = 1 \Rightarrow f_{xx}f_{yy} - f_{xy}^2 = 3 > 0$ and $f_{xx} > 2$
 \Rightarrow local minimum of $f(1, 1) = 3$
23. $f_x(x, y) = y \cos x = 0$ and $f_y(x, y) = \sin x = 0 \Rightarrow x = n\pi$, n an integer, and $y = 0 \Rightarrow$ the critical points are $(n\pi, 0)$, n an integer (Note: $\cos x$ and $\sin x$ cannot both be 0 for the same x , so $\sin x$ must be 0 and $y = 0$);
 $f_{xx} = -y \sin x$, $f_{yy} = 0$, $f_{xy} = \cos x$; $f_{xx}(n\pi, 0) = 0$, $f_{yy}(n\pi, 0) = 0$, $f_{xy}(n\pi, 0) = 1$ if n is even and
 $f_{xy}(n\pi, 0) = -1$ if n is odd $\Rightarrow f_{xx}f_{yy} - f_{xy}^2 = -1 < 0 \Rightarrow$ saddle point.
24. $f_x(x, y) = 2e^{2x} \cos y = 0$ and $f_y(x, y) = -e^{2x} \sin y = 0 \Rightarrow$ no solution since $e^{2x} \neq 0$ for any x and the functions $\cos y$ and $\sin y$ cannot equal 0 for the same $y \Rightarrow$ no critical points \Rightarrow no extrema and no saddle points
25. $f_x(x, y) = (2x-4)e^{x^2+y^2-4x} = 0$ and $f_y(x, y) = 2ye^{x^2+y^2-4x} = 0 \Rightarrow$ critical point is $(2, 0)$; $f_{xx}(2, 0) = \frac{2}{e^4}$,
 $f_{xy}(2, 0) = 0$, $f_{yy}(2, 0) = \frac{2}{e^4} \Rightarrow f_{xx}f_{yy} - f_{xy}^2 = \frac{4}{e^8} > 0$ and $f_{xx} > 0 \Rightarrow$ local minimum of $f(2, 0) = \frac{1}{e^4}$
26. $f_x(x, y) = -ye^x = 0$ and $f_y(x, y) = e^y - e^x = 0 \Rightarrow$ critical point is $(0, 0)$; $f_{xx}(0, 0) = 0$, $f_{xy}(0, 0) = -1$,
 $f_{yy}(0, 0) = 1 \Rightarrow f_{xx}f_{yy} - f_{xy}^2 = -1 < 0 \Rightarrow$ saddle point
27. $f_x(x, y) = 2xe^{-y} = 0$ and $f_y(x, y) = 2ye^{-y} - e^{-y}(x^2 + y^2) = 0 \Rightarrow$ critical points are $(0, 0)$ and $(0, 2)$;
for $(0, 0)$: $f_{xx}(0, 0) = 2e^{-y}\Big|_{(0,0)} = 2$, $f_{yy}(0, 0) = \left(2e^{-y} - 4ye^{-y} + e^{-y}(x^2 + y^2)\right)\Big|_{(0,0)} = 2$,
 $f_{xy}(0, 0) = -2xe^{-y}\Big|_{(0,0)} = 0 \Rightarrow f_{xx}f_{yy} - f_{xy}^2 = 4 > 0 \Rightarrow$ and $f_{xx} > 0 \Rightarrow$ local minimum of $f(0, 0) = 0$;
for $(0, 2)$: $f_{xx}(0, 2) = 2e^{-y}\Big|_{(0,2)} = \frac{2}{e^2}$, $f_{yy}(0, 2) = \left(2e^{-y} - 4ye^{-y} + e^{-y}(x^2 + y^2)\right)\Big|_{(0,2)} = -\frac{2}{e^2}$,
 $f_{xy}(0, 2) = -2xe^{-y}\Big|_{(0,2)} = 0 \Rightarrow f_{xx}f_{yy} - f_{xy}^2 = -\frac{4}{e^4} < 0 \Rightarrow$ saddle point
28. $f_x(x, y) = e^x(x^2 - 2x + y^2) = 0$ and $f_y(x, y) = -2ye^x = 0 \Rightarrow$ critical points are $(0, 0)$ and $(-2, 0)$; for
 $(0, 0)$: $f_{xx}(0, 0) = e^x(x^2 + 4x + 2 - y^2)\Big|_{(0,0)} = 2$, $f_{yy}(0, 0) = -2e^x\Big|_{(0,0)} = -2$, $f_{xy}(0, 0) = -2ye^x\Big|_{(0,0)} = 0$
 $\Rightarrow f_{xx}f_{yy} - f_{xy}^2 = -4 < 0$ and $f_{xx} > 0 \Rightarrow$ saddle point; for $(-2, 0)$:

$$f_{xx}(-2, 0) = e^x(x^2 + 4x + 2 - y^2) \Big|_{(-2, 0)} = -\frac{2}{e^2}, f_{yy}(-2, 0) = -2e^x \Big|_{(-2, 0)} = -\frac{2}{e^2}, f_{xy}(-2, 0) = -2ye^x \Big|_{(-2, 0)} = 0$$

$$\Rightarrow f_{xx}f_{yy} - f_{xy}^2 = \frac{4}{e^4} > 0 \text{ and } f_{xx} < 0 \Rightarrow \text{local maximum of } f(-2, 0) = \frac{4}{e^2}$$

29. $f_x(x, y) = -4 + \frac{2}{x} = 0$ and $f_y(x, y) = -1 + \frac{1}{y} = 0 \Rightarrow$ critical point is $(\frac{1}{2}, 1)$; $f_{xx}(\frac{1}{2}, 1) = -8$, $f_{yy}(\frac{1}{2}, 1) = -1$,
 $f_{xy}(\frac{1}{2}, 1) = 0 \Rightarrow f_{xx}f_{yy} - f_{xy}^2 = 8 > 0$ and $f_{xx} < 0 \Rightarrow$ local maximum of $f(\frac{1}{2}, 1) = -3 - 2 \ln 2$

30. $f_x(x, y) = 2x + \frac{1}{x+y} = 0$ and $f_y(x, y) = -1 + \frac{1}{x+y} = 0 \Rightarrow$ critical point is $(-\frac{1}{2}, \frac{3}{2})$; $f_{xx}(-\frac{1}{2}, \frac{3}{2}) = 1$,
 $f_{yy}(-\frac{1}{2}, \frac{3}{2}) = -1$, $f_{xy}(-\frac{1}{2}, \frac{3}{2}) = -1 \Rightarrow f_{xx}f_{yy} - f_{xy}^2 = -2 < 0 \Rightarrow$ saddle point

31. (i) On OA , $f(x, y) = f(0, y) = y^2 - 4y + 1$ on $0 \leq y \leq 2$; $f'(0, y) = 2y - 4 = 0 \Rightarrow y = 2$;
 $f(0, 0) = 1$ and $f(0, 2) = -3$

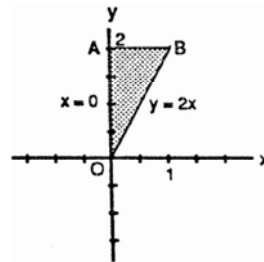

(ii) On AB , $f(x, y) = f(x, 2) = 2x^2 - 4x - 3$ on $0 \leq x \leq 1$; $f'(x, 2) = 4x - 4 = 0 \Rightarrow x = 1$;
 $f'(0, 2) = -3$ and $f(1, 2) = -5$

(iii) On OB , $f(x, y) = f(x, 2x) = 6x^2 - 12x + 1$ on $0 \leq x \leq 1$; endpoint values have been found above;
 $f'(x, 2x) = 12x - 12 = 0 \Rightarrow x = 1$ and $y = 2$, but $(1, 2)$ is not an interior point of OB

(iv) For interior points of the triangular region, $f_x(x, y) = 4x - 4 = 0$ and $f_y(x, y) = 2y - 4 = 0 \Rightarrow x = 1$ and $y = 2$, but $(1, 2)$ is not an interior point of the region. Therefore, the absolute maximum is 1 at $(0, 0)$ and the absolute minimum is -5 at $(1, 2)$.

32. (i) On OA , $D(x, y) = D(0, y) = y^2 + 1$ on $0 \leq y \leq 4$;
 $D'(0, y) = 2y = 0 \Rightarrow y = 0$; $D(0, 0) = 1$ and $D(0, 4) = 17$

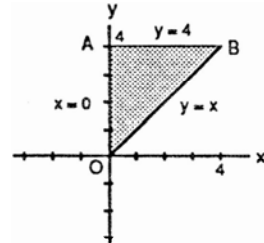

(ii) On AB , $D(x, y) = D(x, 4) = x^2 - 4x + 17$ on $0 \leq x \leq 4$; $D'(x, 4) = 2x - 4 = 0 \Rightarrow x = 2$ and $(2, 4)$ is an interior point of AB ; $D(2, 4) = 13$ and $D(4, 4) = D(0, 4) = 17$

(iii) On OB , $D(x, y) = D(x, x) = x^2 + 1$ on $0 \leq x \leq 4$; $D'(x, x) = 2x = 0 \Rightarrow x = 0$ and $y = 0$, which is not an interior point of OB ; endpoint values have been found above

(iv) For interior points of the triangular region, $f_x(x, y) = 2x - y = 0$ and $f_y(x, y) = -x + 2y = 0 \Rightarrow x = 0$ and $y = 0$, which is not an interior point of the region. Therefore, the absolute maximum is 17 at $(0, 4)$ and $(4, 4)$, and the absolute minimum is 1 at $(0, 0)$.

33. (i) On OA , $f(x, y) = f(0, y) = y^2$ on $0 \leq y \leq 2$;
 $f'(0, y) = 2y = 0 \Rightarrow y = 0$ and $x = 0$; $f(0, 0) = 0$
 and $f(0, 2) = 4$
- (ii) On OB , $f(x, y) = f(x, 0) = x^2$ on $0 \leq x \leq 1$;
 $f'(x, 0) = 2x = 0 \Rightarrow x = 0$ and $y = 0$; $f(0, 0) = 0$
 and $f(1, 0) = 1$

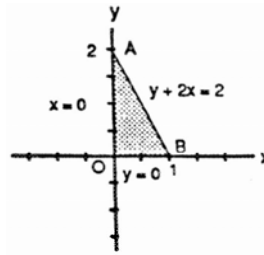

- (iii) On AB , $f(x, y) = f(x, -2x + 2) = 5x^2 - 8x + 4$ on $0 \leq x \leq 1$; $f'(x, -2x + 2) = 10x - 8 = 0 \Rightarrow x = \frac{4}{5}$ and $y = \frac{2}{5}$; $f\left(\frac{4}{5}, \frac{2}{5}\right) = \frac{4}{5}$; endpoint values have been found above.
- (iv) For interior points of the triangular region, $f_x(x, y) = 2x = 0$ and $f_y(x, y) = 2y = 0 \Rightarrow x = 0$ and $y = 0$, but $(0, 0)$ is not an interior point of the region. Therefore the absolute maximum is 4 at $(0, 2)$ and the absolute minimum is 0 at $(0, 0)$.

34. (i) On AB , $T(x, y) = T(0, y) = y^2$ on $-3 \leq y \leq 3$;
 $T'(0, y) = 2y = 0 \Rightarrow y = 0$ and $x = 0$; $T(0, 0) = 0$,
 $T(0, -3) = 9$, and $T(0, 3) = 9$
- (ii) On BC , $T(x, y) = T(x, 3) = x^2 - 3x + 9$ on
 $0 \leq x \leq 5$; $T'(x, 3) = 2x - 3 = 0 \Rightarrow x = \frac{3}{2}$ and
 $y = 3$; $T\left(\frac{3}{2}, 3\right) = \frac{27}{4}$ and $T(5, 3) = 19$

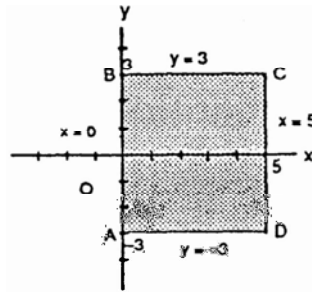

- (iii) On CD , $T(x, y) = T(5, y) = y^2 + 5y - 5$ on $-3 \leq y \leq 3$; $T'(5, y) = 2y + 5 = 0 \Rightarrow y = -\frac{5}{2}$ and $x = 5$;
 $T\left(5, -\frac{5}{2}\right) = -\frac{45}{4}$, $T(5, -3) = -11$ and $T(5, 3) = 19$
- (iv) On AD , $T(x, y) = T(x, -3) = x^2 - 9x + 9$ on $0 \leq x \leq 5$; $T'(x, -3) = 2x - 9 = 0 \Rightarrow x = \frac{9}{2}$ and $y = -3$;
 $T\left(\frac{9}{2}, -3\right) = -\frac{45}{4}$, $T(0, -3) = 9$ and $T(5, -3) = -11$
- (v) For interior points of the rectangular region, $T_x(x, y) = 2x + y - 6 = 0$ and $T_y(x, y) = x + 2y = 0 \Rightarrow x = 4$ and $y = -2 \Rightarrow (4, -2)$ is an interior critical point with $T(4, -2) = -12$. Therefore the absolute maximum is 19 at $(5, 3)$ and the absolute minimum is -12 at $(4, -2)$.

35. (i) On OC , $T(x, y) = T(x, 0) = x^2 - 6x + 2$ on
 $0 \leq x \leq 5$; $T'(x, 0) = 2x - 6 = 0 \Rightarrow x = 3$ and $y = 0$;
 $T(3, 0) = -7$, $T(0, 0) = 2$, and $T(5, 0) = -3$
- (ii) On CB , $T(x, y) = T(5, y) = y^2 + 5y - 3$ on
 $-3 \leq y \leq 0$; $T'(5, y) = 2y + 5 = 0 \Rightarrow y = -\frac{5}{2}$ and
 $x = 5$; $T\left(5, -\frac{5}{2}\right) = -\frac{37}{4}$ and $T(5, -3) = -9$
- (iii) On AB , $T(x, y) = T(x, -3) = x^2 - 9x + 11$ on $0 \leq x \leq 5$; $T'(x, -3) = 2x - 9 = 0 \Rightarrow x = \frac{9}{2}$ and $y = -3$;
 $T\left(\frac{9}{2}, -3\right) = -\frac{37}{4}$ and $T(0, -3) = 11$
- (iv) On AO , $T(x, y) = T(0, y) = y^2 + 2$ on $-3 \leq y \leq 0$; $T'(0, y) = 2y = 0 \Rightarrow y = 0$ and $x = 0$, but $(0, 0)$ is not an interior point of AO

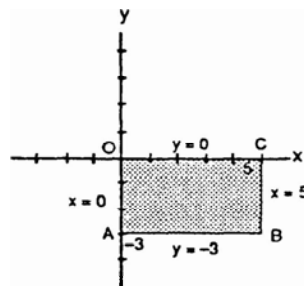

- (v) For interior points of the rectangular region, $T_x(x, y) = 2x + y - 6 = 0$ and $T_y(x, y) = x + 2y = 0 \Rightarrow x = 4$ and $y = -2$, an interior critical point with $T(4, -2) = -10$. Therefore the absolute maximum is 11 at $(0, -3)$ and the absolute minimum is -10 at $(4, -2)$.

36. (i) On OA , $f(x, y) = f(0, y) = -24y^2$ on $0 \leq y \leq 1$;
 $f'(0, y) = -48y = 0 \Rightarrow y = 0$ and $x = 0$, but
 $(0, 0)$ is not an interior point of OA ; $f(0, 0) = 0$
 and $f(0, 1) = -24$

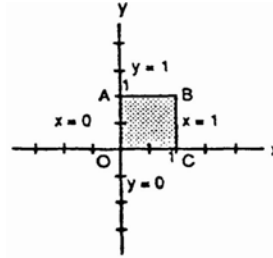

- (ii) On AB , $f(x, y) = f(x, 1) = 48x - 32x^3 - 24$ on
 $0 \leq x \leq 1$; $f'(x, 1) = 48 - 96x^2 = 0 \Rightarrow x = \frac{1}{\sqrt{2}}$ and

$y = 1$, or $x = -\frac{1}{\sqrt{2}}$ and $y = 1$, but $(-\frac{1}{\sqrt{2}}, 1)$ is not in the interior of AB ; $f(\frac{1}{\sqrt{2}}, 1) = 16\sqrt{2} - 24$ and
 $f(1, 1) = -8$

- (iii) On BC , $f(x, y) = f(1, y) = 48y - 32 - 24y^2$ on $0 \leq y \leq 1$; $f'(1, y) = 48 - 48y = 0 \Rightarrow y = 1$ and $x = 1$, but
 $(1, 1)$ is not an interior point of BC ; $f(1, 0) = -32$ and $f(1, 1) = -8$

- (iv) On OC , $f(x, y) = f(x, 0) = -32x^3$ on $0 \leq x \leq 1$; $f'(x, 0) = -96x^2 = 0 \Rightarrow x = 0$ and $y = 0$, but $(0, 0)$ is
 not an interior point of OC ; $f(0, 0) = 0$ and $f(1, 0) = -32$

- (v) For interior points of the rectangular region, $f_x(x, y) = 48y - 96x^2 = 0$ and $f_y(x, y) = 48x - 48y = 0$
 $\Rightarrow x = 0$ and $y = 0$, or $x = \frac{1}{2}$ and $y = \frac{1}{2}$, but $(0, 0)$ is not an interior point of the region; $f(\frac{1}{2}, \frac{1}{2}) = 2$.
 Therefore the absolute maximum is 2 at $(\frac{1}{2}, \frac{1}{2})$ and the absolute minimum is -32 at $(1, 0)$.

37. (i) On AB , $f(x, y) = f(1, y) = 3 \cos y$ on
 $-\frac{\pi}{4} \leq y \leq \frac{\pi}{4}$; $f'(1, y) = -3 \sin y = 0 \Rightarrow y = 0$ and
 $x = 1$; $f(1, 0) = 3$, $f(1, -\frac{\pi}{4}) = \frac{3\sqrt{2}}{2}$, and
 $f(1, \frac{\pi}{4}) = \frac{3\sqrt{2}}{2}$

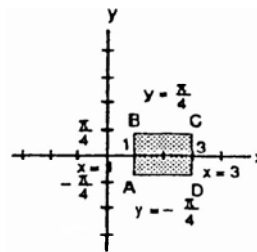

- (ii) On CD , $f(x, y) = f(3, y) = 3 \cos y$ on $-\frac{\pi}{4} \leq y \leq \frac{\pi}{4}$; $f'(3, y) = -3 \sin y = 0 \Rightarrow y = 0$ and $x = 3$;
 $f(3, 0) = 3$, $f(3, -\frac{\pi}{4}) = \frac{3\sqrt{2}}{2}$ and $f(3, \frac{\pi}{4}) = \frac{3\sqrt{2}}{2}$

- (iii) On BC , $f(x, y) = f(x, \frac{\pi}{4}) = \frac{\sqrt{2}}{2}(4x - x^2)$ on $1 \leq x \leq 3$; $f'(x, \frac{\pi}{4}) = \sqrt{2}(2 - x) = 0 \Rightarrow x = 2$ and $y = \frac{\pi}{4}$;
 $f(2, \frac{\pi}{4}) = 2\sqrt{2}$, $f(1, \frac{\pi}{4}) = \frac{3\sqrt{2}}{2}$, and $f(3, \frac{\pi}{4}) = \frac{3\sqrt{2}}{2}$

- (iv) On AD , $f(x, y) = f(x, -\frac{\pi}{4}) = \frac{\sqrt{2}}{2}(4x - x^2)$ on $1 \leq x \leq 3$; $f'(x, -\frac{\pi}{4}) = \sqrt{2}(2 - x) = 0 \Rightarrow x = 2$ and
 $y = -\frac{\pi}{4}$; $f(2, -\frac{\pi}{4}) = 2\sqrt{2}$, $f(1, -\frac{\pi}{4}) = \frac{3\sqrt{2}}{2}$, and $f(3, -\frac{\pi}{4}) = \frac{3\sqrt{2}}{2}$

- (v) For interior points of the region, $f_x(x, y) = (4 - 2x) \cos y = 0$ and $f_y(x, y) = -(4x - x^2) \sin y = 0$
 $\Rightarrow x = 2$ and $y = 0$, which is an interior critical point with $f(2, 0) = 4$. Therefore the absolute maximum
 is 4 at $(2, 0)$ and the absolute minimum is $\frac{3\sqrt{2}}{2}$ at $(3, -\frac{\pi}{4})$, $(3, \frac{\pi}{4})$, $(1, -\frac{\pi}{4})$, and $(1, \frac{\pi}{4})$.

38. (i) On OA , $f(x, y) = f(0, y) = 2y + 1$ on $0 \leq y \leq 1$;
 $f'(0, y) = 2 \Rightarrow$ no interior critical points;
 $f(0, 0) = 1$ and $f(0, 1) = 3$
- (ii) On OB , $f(x, y) = f(x, 0) = 4x + 1$ on $0 \leq x \leq 1$;
 $f'(x, 0) = 4 \Rightarrow$ no interior critical points;
 $f(1, 0) = 5$

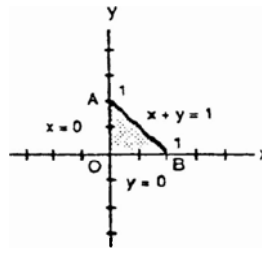

- (iii) On AB , $f(x, y) = f(x, -x + 1) = 8x^2 - 6x + 3$ on $0 \leq x \leq 1$; $f'(x, -x + 1) = 16x - 6 = 0 \Rightarrow x = \frac{3}{8}$ and $y = \frac{5}{8}$; $f(\frac{3}{8}, \frac{5}{8}) = \frac{15}{8}$, $f(0, 1) = 3$, and $f(1, 0) = 5$
- (iv) For interior points of the triangular region, $f_x(x, y) = 4 - 8y = 0$ and $f_y(x, y) = -8x + 2 = 0 \Rightarrow y = \frac{1}{2}$ and $x = \frac{1}{4}$ which is an interior critical point with $f(\frac{1}{4}, \frac{1}{2}) = 2$. Therefore the absolute maximum is 5 at $(1, 0)$ and the absolute minimum is 1 at $(0, 0)$.

39. Let $F(a, b) = \int_a^b (6 - x - x^2) dx$ where $a \leq b$. The boundary of the domain of F is the line $a = b$ in the ab -plane, and $F(a, a) = 0$, so F is identically 0 on the boundary of its domain. For interior critical points we have: $\frac{\partial F}{\partial a} = -(6 - a - a^2) = 0 \Rightarrow a = -3, 2$ and $\frac{\partial F}{\partial b} = (6 - b - b^2) = 0 \Rightarrow b = -3, 2$. Since $a \leq b$, there is only one interior critical point $(-3, 2)$ and $F(-3, 2) = \int_{-3}^2 (6 - x - x^2) dx$ gives the area under the parabola $y = 6 - x - x^2$ that is above the x -axis. Therefore, $a = -3$ and $b = 2$.

40. Let $F(a, b) = \int_a^b (24 - 2x - x^2)^{1/3} dx$ where $a \leq b$. The boundary of the domain of F is the line $a = b$ and on this line F is identically 0. For interior critical points we have: $\frac{\partial F}{\partial a} = -(24 - 2a - a^2)^{1/3} = 0 \Rightarrow a = 4, -6$ and $\frac{\partial F}{\partial b} = (24 - 2b - b^2)^{1/3} = 0 \Rightarrow b = 4, -6$. Since $a \leq b$, there is only one critical point $(-6, 4)$ and $F(-6, 4) = \int_{-6}^4 (24 - 2x - x^2)^{1/3} dx$ gives the area under the curve $y = (24 - 2x - x^2)^{1/3}$ that is above the x -axis. Therefore, $a = -6$ and $b = 4$.

41. $T_x(x, y) = 2x - 1 = 0$ and $T_y(x, y) = 4y = 0 \Rightarrow x = \frac{1}{2}$ and $y = 0$ with $T(\frac{1}{2}, 0) = -\frac{1}{4}$; on the boundary $x^2 + y^2 = 1$: $T(x, y) = -x^2 - x + 2$ for $-1 \leq x \leq 1 \Rightarrow T'(x, y) = -2x - 1 = 0 \Rightarrow x = -\frac{1}{2}$ and $y = \pm \frac{\sqrt{3}}{2}$;
 $T(-\frac{1}{2}, \frac{\sqrt{3}}{2}) = \frac{9}{4}$, $T(-\frac{1}{2}, -\frac{\sqrt{3}}{2}) = \frac{9}{4}$, $T(-1, 0) = 2$, and $T(1, 0) = 0 \Rightarrow$ the hottest is $(\frac{2}{4})^\circ$ at $(-\frac{1}{2}, -\frac{\sqrt{3}}{2})$ and $(-\frac{1}{2}, \frac{\sqrt{3}}{2})$; the coldest is $(-\frac{1}{4})^\circ$ at $(\frac{1}{2}, 0)$.

42. $f_x(x, y) = y + 2 - \frac{2}{x} = 0$ and $f_y(x, y) = x - \frac{1}{y} = 0 \Rightarrow x = \frac{1}{2}$ and $y = 2$; $f_{xx}(\frac{1}{2}, 2) = \frac{2}{x^2} \Big|_{(\frac{1}{2}, 2)} = 8$,
 $f_{yy}(\frac{1}{2}, 2) = \frac{1}{y^2} \Big|_{(\frac{1}{2}, 2)} = \frac{1}{4}$, $f_{xy}(\frac{1}{2}, 2) = 1 \Rightarrow f_{xx}f_{yy} - f_{xy}^2 = 1 > 0$ and $f_{xx} > 0 \Rightarrow$ a local minimum of
 $f(\frac{1}{2}, 2) = 2 - \ln \frac{1}{2} = 2 + \ln 2$

43. (a) $f_x(x, y) = 2x - 4y = 0$ and $f_y(x, y) = 2y - 4x = 0 \Rightarrow x = 0$ and $y = 0$; $f_{xx}(0, 0) = 2$, $f_{yy}(0, 0) = 2$,
 $f_{xy}(0, 0) = -4 \Rightarrow f_{xx}f_{yy} - f_{xy}^2 = -12 < 0 \Rightarrow$ saddle point at $(0, 0)$
- (b) $f_x(x, y) = 2x - 2 = 0$ and $f_y(x, y) = 2y - 4 = 0 \Rightarrow x = 1$ and $y = 2$; $f_{xx}(1, 2) = 2$; $f_{yy}(1, 2) = 2$,
 $f_{xy}(1, 2) = 0 \Rightarrow f_{xx}f_{yy} - f_{xy}^2 = 4 > 0$ and $f_{xx} > 0 \Rightarrow$ local minimum at $(1, 2)$
- (c) $f_x(x, y) = 9x^2 - 9 = 0$ and $f_y(x, y) = 2y + 4 = 0 \Rightarrow x = \pm 1$ and $y = -2$; $f_{xx}(1, -2) = 18x|_{(1, -2)} = 18$,
 $f_{yy}(1, -2) = 2$, $f_{xy}(1, -2) = 0 \Rightarrow f_{xx}f_{yy} - f_{xy}^2 = 36 > 0$ and $f_{xx} > 0 \Rightarrow$ local minimum at $(1, -2)$;
 $f_{xx}(-1, -2) = -18$, $f_{yy}(-1, -2) = 2$, $f_{xy}(-1, -2) = 0 \Rightarrow f_{xx}f_{yy} - f_{xy}^2 = -36 < 0 \Rightarrow$ saddle point at $(-1, -2)$
44. (a) Minimum at $(0, 0)$ Since $f(x, y) > 0$ for all other (x, y)
 (b) Maximum of 1 at $(0, 0)$ since $f(x, y) < 1$ for all other (x, y)
 (c) Neither since $f(x, y) < 0$ for $x < 0$ and $f(x, y) > 0$ for $x > 0$
 (d) Neither since $f(x, y) < 0$ for $x < 0$ and $f(x, y) > 0$ for $x > 0$
 (e) Neither since $f(x, y) < 0$ for $x < 0$ and $y > 0$, but $f(x, y) > 0$ for $x > 0$ and $y > 0$
 (f) Minimum at $(0, 0)$ since $f(x, y) > 0$ for all other (x, y)
45. If $k = 0$, then $f(x, y) = x^2 + y^2 \Rightarrow f_x(x, y) = 2x = 0$ and $f_y(x, y) = 2y = 0 \Rightarrow x = 0$ and $y = 0 \Rightarrow (0, 0)$ is the only critical point. If $k \neq 0$, $f_x(x, y) = 2x + ky = 0 \Rightarrow y = -\frac{2}{k}x$; $f_y(x, y) = kx + 2y = 0 \Rightarrow kx + 2\left(-\frac{2}{k}x\right) = 0 \Rightarrow kx - \frac{4x}{k} = 0 \Rightarrow \left(k - \frac{4}{k}\right)x = 0 \Rightarrow x = 0$ or $k = \pm 2 \Rightarrow y = \left(-\frac{2}{k}\right)(0) = 0$ or $y = \pm x$; in any case $(0, 0)$ is a critical point.
46. (See Exercise 45 above): $f_{xx}(x, y) = 2$, $f_{yy}(x, y) = 2$, and $f_{xy}(x, y) = k \Rightarrow f_{xx}f_{yy} - f_{xy}^2 = 4 - k^2$; f will have a saddle point at $(0, 0)$ if $4 - k^2 < 0 \Rightarrow k > 2$ or $k < -2$; f will have a local minimum at $(0, 0)$ if $4 - k^2 > 0 \Rightarrow -2 < k < 2$; the test is inconclusive if $4 - k^2 = 0 \Rightarrow k = \pm 2$.
47. No; for example $f(x, y) = xy$ has a saddle point at $(a, b) = (0, 0)$ where $f_x = f_y = 0$.
48. If $f_{xx}(a, b)$ and $f_{yy}(a, b)$ differ in sign, then $f_{xx}(a, b)f_{yy}(a, b) < 0$ so $f_{xx}f_{yy} - f_{xy}^2 < 0$. The surface must therefore have a saddle point at (a, b) by the second derivative test.
49. We want the point on $z = 10 - x^2 - y^2$ where the tangent plane is parallel to the plane $x + 2y + 3z = 0$. To find a normal vector to $z = 10 - x^2 - y^2$ let $w = z + x^2 + y^2 - 10$. Then $\nabla w = 2x\mathbf{i} + 2y\mathbf{j} + \mathbf{k}$ is normal to $z = 10 - x^2 - y^2$ at (x, y) . The vector ∇w is parallel to $\mathbf{i} + 2\mathbf{j} + 3\mathbf{k}$ which is normal to the plane $x + 2y + 3z = 0$ if $6x\mathbf{i} + 6y\mathbf{j} + 3\mathbf{k} = \mathbf{i} + 2\mathbf{j} + 3\mathbf{k}$ or $x = \frac{1}{6}$ and $y = \frac{1}{3}$. Thus the point is $\left(\frac{1}{6}, \frac{1}{3}, 10 - \frac{1}{36} - \frac{1}{9}\right)$ or $\left(\frac{1}{6}, \frac{1}{3}, \frac{355}{36}\right)$.
50. We want the point on $z = x^2 + y^2 + 10$ where the tangent plane is parallel to the plane $x + 2y - z = 0$. Let $w = z - x^2 - y^2 - 10$, then $\nabla w = -2x\mathbf{i} - 2y\mathbf{j} + \mathbf{k}$ is normal to $z = x^2 + y^2 + 10$ at (x, y) . The vector ∇w is

parallel to $\mathbf{i} + 2\mathbf{j} - \mathbf{k}$ which is normal to the plane if $x = \frac{1}{2}$ and $y = 1$. Thus the point $(\frac{1}{2}, 1, \frac{1}{4} + 1 + 10)$ or $(\frac{1}{2}, 1, \frac{45}{4})$ is the point on the surface $z = x^2 + y^2 + 10$ nearest the plane $x + 2y - z = 0$.

51. $d(x, y, z) = \sqrt{(x-0)^2 + (y-0)^2 + (z-0)^2} \Rightarrow$ we can minimize $d(x, y, z)$ by minimizing
 $D(x, y, z) = x^2 + y^2 + z^2$; $3x + 2y + z = 6 \Rightarrow z = 6 - 3x - 2y \Rightarrow D(x, y) = x^2 + y^2 + (6 - 3x - 2y)^2$
 $\Rightarrow D_x(x, y) = 2x - 6(6 - 3x - 2y) = 0$ and $D_y(x, y) = 2y - 4(6 - 3x - 2y) = 0 \Rightarrow$ critical point is
 $(\frac{9}{7}, \frac{6}{7}) \Rightarrow z = \frac{3}{7}$; $D_{xx}(\frac{9}{7}, \frac{6}{7}) = 20$, $D_{yy}(\frac{9}{7}, \frac{6}{7}) = 10$, $D_{xy}(\frac{9}{7}, \frac{6}{7}) = 12 \Rightarrow D_{xx}D_{yy} - D_{xy}^2 = 56 > 0$ and $D_{xx} > 0$
 \Rightarrow local minimum of $d(\frac{9}{7}, \frac{6}{7}, \frac{3}{7}) = \frac{3\sqrt{14}}{7}$
52. $d(x, y, z) = \sqrt{(x-2)^2 + (y+1)^2 + (z-1)^2} \Rightarrow$ we can minimize $d(x, y, z)$ by minimizing
 $D(x, y, z) = (x-2)^2 + (y+1)^2 + (z-1)^2$; $x + y - z = 2 \Rightarrow z = x + y - 2$
 $\Rightarrow D(x, y) = (x-2)^2 + (y+1)^2 + (x+y-3)^2 \Rightarrow D_x(x, y) = 2(x-2) + 2(x+y-3) = 0$ and
 $D_y(x, y) = 2(y+1) + 2(x+y-3) = 0 \Rightarrow$ critical point is $(\frac{8}{3}, -\frac{1}{3}) \Rightarrow z = \frac{1}{3}$; $D_{xx}(\frac{8}{3}, -\frac{1}{3}) = 4$, $D_{yy}(\frac{8}{3}, -\frac{1}{3}) = 4$,
 $D_{xy}(\frac{8}{3}, -\frac{1}{3}) = 2 \Rightarrow D_{xx}D_{yy} - D_{xy}^2 = 12 > 0$ and $D_{xx} > 0 \Rightarrow$ local minimum of $d(\frac{8}{3}, -\frac{1}{3}, \frac{1}{3}) = \frac{2}{\sqrt{3}}$
53. $s(x, y, z) = x^2 + y^2 + z^2$; $x + y + z = 9 \Rightarrow z = 9 - x - y \Rightarrow s(x, y) = x^2 + y^2 + (9 - x - y)^2$
 $\Rightarrow s_x(x, y) = 2x - 2(9 - x - y) = 0$ and $s_y(x, y) = 2y - 2(9 - x - y) = 0 \Rightarrow$ critical point is $(3, 3) \Rightarrow z = 3$;
 $s_{xx}(3, 3) = 4$, $s_{yy}(3, 3) = 4$, $s_{xy}(3, 3) = 2 \Rightarrow s_{xx}s_{yy} - s_{xy}^2 = 12 > 0$ and $s_{xx} > 0 \Rightarrow$ local minimum of
 $s(3, 3, 3) = 27$
54. $p(x, y, z) = xyz$; $x + y + z = 3 \Rightarrow z = 3 - x - y \Rightarrow p(x, y) = xy(3 - x - y) = 3xy - x^2y - xy^2$
 $\Rightarrow p_x(x, y) = 3y - 2xy - y^2 = 0$ and $p_y(x, y) = 3x - x^2 - 2xy = 0 \Rightarrow$ critical points are $(0, 0)$, $(0, 3)$, $(3, 0)$,
and $(1, 1)$; for $(0, 0) \Rightarrow z = 3$; $p_{xx}(0, 0) = 0$, $p_{yy}(0, 0) = 0$, $p_{xy}(0, 0) = 3 \Rightarrow p_{xx}p_{yy} - p_{xy}^2 = -9 < 0 \Rightarrow$ saddle
point; for $(0, 3) \Rightarrow z = 0$; $p_{xx}(0, 3) = -6$, $p_{yy}(0, 3) = 0$, $p_{xy}(0, 3) = -3 \Rightarrow p_{xx}p_{yy} - p_{xy}^2 = -9 < 0 \Rightarrow$ saddle
point; for $(3, 0) \Rightarrow z = 0$; $p_{xx}(3, 0) = 0$, $p_{yy}(3, 0) = -6$, $p_{xy}(3, 0) = -3 \Rightarrow p_{xx}p_{yy} - p_{xy}^2 = -9 < 0 \Rightarrow$ saddle
point; for $(1, 1) \Rightarrow z = 1$; $p_{xx}(1, 1) = -2$, $p_{yy}(1, 1) = -2$, $p_{xy}(1, 1) = -1 \Rightarrow p_{xx}p_{yy} - p_{xy}^2 = 3 > 0$ and $p_{xx} < 0$
 \Rightarrow local maximum of $p(1, 1, 1) = 1$
55. $s(x, y, z) = xy + yz + xz$; $x + y + z = 6 \Rightarrow z = 6 - x - y \Rightarrow s(x, y) = xy + y(6 - x - y) + x(6 - x - y)$
 $= 6x + 6y - xy - x^2 - y^2 \Rightarrow s_x(x, y) = 6 - 2x - y = 0$ and $s_y(x, y) = 6 - x - 2y = 0 \Rightarrow$ critical point is $(2, 2)$
 $\Rightarrow z = 2$; $s_{xx}(2, 2) = -2$, $s_{yy}(2, 2) = -2$, $s_{xy}(2, 2) = -1 \Rightarrow s_{xx}s_{yy} - s_{xy}^2 = 3 > 0$ and $s_{xx} < 0 \Rightarrow$ local maximum
of $s(2, 2, 2) = 12$
56. $d(x, y, z) = \sqrt{(x+6)^2 + (y-4)^2 + (z-0)^2} \Rightarrow$ we can minimize $d(x, y, z)$ by minimizing
 $D(x, y, z) = (x+6)^2 + (y-4)^2 + z^2$; $z = \sqrt{x^2 + y^2} \Rightarrow D(x, y) = (x+6)^2 + (y-4)^2 + x^2 + y^2$

$= 2x^2 + 2y^2 + 12x - 8y + 52 \Rightarrow D_x(x, y) = 4x + 12 = 0$ and $D_y(x, y) = 4y - 8 = 0 \Rightarrow$ critical point is $(-3, 2)$
 $\Rightarrow z = \sqrt{13}$; $D_{xx}(-3, 2) = 4, D_{yy}(-3, 2) = 4, D_{xy}(-3, 2) = 0 \Rightarrow D_{xx}D_{yy} - D_{xy}^2 = 16 > 0$ and $D_{xx} > 0 \Rightarrow$ local
 minimum of $d(-3, 2, \sqrt{13}) = \sqrt{26}$

57. $V(x, y, z) = (2x)(2y)(2z) = 8xyz$; $x^2 + y^2 + z^2 = 4 \Rightarrow z = \sqrt{4 - x^2 - y^2} \Rightarrow V(x, y) = 8xy\sqrt{4 - x^2 - y^2}$, $x \geq 0$
 and $y \geq 0 \Rightarrow V_x(x, y) = \frac{32y - 16x^2y - 8y^3}{\sqrt{4 - x^2 - y^2}} = 0$ and $V_y(x, y) = \frac{32x - 16xy^2 - 8x^3}{\sqrt{4 - x^2 - y^2}} = 0 \Rightarrow$ critical points are $(0, 0)$,
 $(\frac{2}{\sqrt{3}}, \frac{2}{\sqrt{3}}), (\frac{2}{\sqrt{3}}, -\frac{2}{\sqrt{3}}), (-\frac{2}{\sqrt{3}}, \frac{2}{\sqrt{3}})$, and $(-\frac{2}{\sqrt{3}}, -\frac{2}{\sqrt{3}})$. Only $(0, 0)$ and $(\frac{2}{\sqrt{3}}, \frac{2}{\sqrt{3}})$ satisfy $x \geq 0$ and $y \geq 0$
 $V(0, 0) = 0$ and $V(\frac{2}{\sqrt{3}}, \frac{2}{\sqrt{3}}) = \frac{64}{3\sqrt{3}}$; On $x = 0, 0 \leq y \leq 2 \Rightarrow V(0, y) = 8(0)y\sqrt{4 - 0^2 - y^2} = 0$, no critical points,
 $V(0, 0) = 0, V(0, 2) = 0$; On $y = 0, 0 \leq x \leq 2 \Rightarrow V(x, 0) = 8x(0)\sqrt{4 - x^2 - 0^2} = 0$, no critical points,
 $V(0, 0) = 0, V(0, 2) = 0$; On $y = \sqrt{4 - x^2}, 0 \leq x \leq 2 \Rightarrow V(x, \sqrt{4 - x^2}) = 8x\sqrt{4 - x^2}\sqrt{4 - x^2 - (\sqrt{4 - x^2})^2} = 0$
 no critical points, $V(0, 2) = 0, V(2, 0) = 0$. Thus, there is a maximum volume of $\frac{64}{3\sqrt{3}}$ if the box is
 $\frac{2}{\sqrt{3}} \times \frac{2}{\sqrt{3}} \times \frac{2}{\sqrt{3}}$.

58. $S(x, y, z) = 2xy + 2yz + 2xz$; $xyz = 27 \Rightarrow z = \frac{27}{xy} \Rightarrow S(x, y, z) = 2xy + 2y(\frac{27}{xy}) + 2x(\frac{27}{xy}) = 2xy + \frac{54}{x} + \frac{54}{y}$,
 $x > 0, y > 0$; $S_x(x, y) = 2y - \frac{54}{x^2} = 0$ and $S_y(x, y) = 2x - \frac{54}{y^2} = 0 \Rightarrow$ Critical point is $(3, 3) \Rightarrow z = 3$;
 $S_{xx}(3, 3) = 4, S_{yy}(3, 3) = 4, D_{xy}(3, 3) = 2 \Rightarrow D_{xx}D_{yy} - D_{xy}^2 = 12 > 0$ and $D_{xx} > 0 \Rightarrow$ local minimum of
 $S(3, 3, 3) = 54$

59. Let $x =$ height of the box, $y =$ width, and $z =$ length, cut out squares of length x from corner of the material See diagram at right. Fold along the dashed lines to form the box. From the diagram we see that the length of the material is $2x + y$ and the width is $2x + z$. Thus

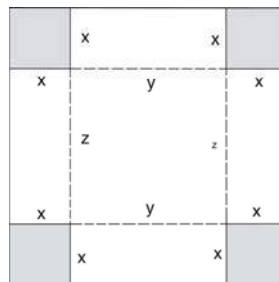

$(2x + y)(2x + z) = 12 \Rightarrow z = \frac{2(6 - 2x^2 + xy)}{2x + y}$. Since

$V(x, y, z) = x y z \Rightarrow V(x, y) = \frac{2xy(6 - 2x^2 + xy)}{2x + y}$, where

$x > 0, y > 0. V_x(x, y) = \frac{4(3y^2 - 4x^3y - 4x^2y^2 - xy^3)}{(2x + y)^2} = 0$ and $V_y(x, y) = \frac{2(12x^2 - 4x^4 - 4x^3y - x^2y^2)}{(2x + y)^2} = 0 \Rightarrow$ critical points

are $(\sqrt{3}, 0), (-\sqrt{3}, 0), (\frac{1}{\sqrt{3}}, \frac{4}{\sqrt{3}})$ and $(-\frac{1}{\sqrt{3}}, -\frac{4}{\sqrt{3}})$. Only $(\sqrt{3}, 0)$ and $(\frac{1}{\sqrt{3}}, \frac{4}{\sqrt{3}})$ satisfy $x > 0$ and $y > 0$.

For $(\sqrt{3}, 0): z = 0; V_{xx}(\sqrt{3}, 0) = 0, V_{yy}(\sqrt{3}, 0) = -2\sqrt{3}, V_{xy}(\sqrt{3}, 0) = -4\sqrt{3} \Rightarrow V_{xx}V_{yy} - V_{xy}^2 - 48 < 0$

\Rightarrow saddle point. For $(\frac{1}{\sqrt{3}}, \frac{4}{\sqrt{3}}): z = \frac{4}{\sqrt{3}}; V_{xx}(\frac{1}{\sqrt{3}}, \frac{4}{\sqrt{3}}) = -\frac{80}{3\sqrt{3}}, V_{yy}(\frac{1}{\sqrt{3}}, \frac{4}{\sqrt{3}}) = -\frac{2}{3\sqrt{3}}, V_{xy}(\frac{1}{\sqrt{3}}, \frac{4}{\sqrt{3}}) = -\frac{4}{3\sqrt{3}}$

$\Rightarrow V_{xx}V_{yy} - V_{xy}^2 = \frac{16}{3} > 0$ and $V_{xx} < 0 \Rightarrow$ local maximum of $V(\frac{1}{\sqrt{3}}, \frac{4}{\sqrt{3}}, \frac{4}{\sqrt{3}}) = \frac{16}{3\sqrt{3}}$

60. (a) (i) On $x = 0$, $f(x, y) = f(0, y) = y^2 - y + 1$ for $0 \leq y \leq 1$; $f'(0, y) = 2y - 1 = 0 \Rightarrow y = \frac{1}{2}$ and $x = 0$;
 $f\left(0, \frac{1}{2}\right) = \frac{3}{4}$, $f(0, 0) = 1$, and $f(0, 1) = 1$
- (ii) On $y = 1$, $f(x, y) = f(x, 1) = x^2 + x + 1$ for $0 \leq x \leq 1$; $f'(x, 1) = 2x + 1 = 0 \Rightarrow x = -\frac{1}{2}$ and $y = 1$, but $\left(-\frac{1}{2}, 1\right)$ is outside the domain; $f(0, 1) = 1$ and $f(1, 1) = 3$
- (iii) On $x = 1$, $f(x, y) = f(1, y) = y^2 + y + 1$ for $0 \leq y \leq 1$; $f'(1, y) = 2y + 1 = 0 \Rightarrow y = -\frac{1}{2}$ and $x = 1$, but $\left(1, -\frac{1}{2}\right)$ is outside the domain; $f(1, 0) = 1$ and $f(1, 1) = 3$
- (iv) On $y = 0$, $f(x, y) = f(x, 0) = x^2 - x + 1$ for $0 \leq x \leq 1$; $f'(x, 0) = 2x - 1 = 0 \Rightarrow x = \frac{1}{2}$ and $y = 0$;
 $f\left(\frac{1}{2}, 0\right) = \frac{3}{4}$; $f(0, 0) = 1$, and $f(1, 0) = 1$
- (v) On the interior of the square, $f_x(x, y) = 2x + 2y - 1 = 0$ and $f_y(x, y) = 2y + 2x - 1 = 0 \Rightarrow 2x + 2y = 1 \Rightarrow (x + y) = \frac{1}{2}$. Then $f(x, y) = x^2 + y^2 + 2xy - x - y + 1 = (x + y)^2 - (x + y) + 1 = \frac{3}{4}$ is the absolute minimum value when $2x + 2y = 1$.
- (b) The absolute maximum is $f(1, 1) = 3$.
61. (a) $\frac{df}{dt} = \frac{\partial f}{\partial x} \frac{dx}{dt} + \frac{\partial f}{\partial y} \frac{dy}{dt} = \frac{dx}{dt} + \frac{dy}{dt} = -2 \sin t + 2 \cos t = 0 \Rightarrow \cos t = \sin t \Rightarrow x = y$
- (i) On the semicircle $x^2 + y^2 = 4$, $y \geq 0$, we have $t = \frac{\pi}{4}$ and $x = y = \sqrt{2} \Rightarrow f(\sqrt{2}, \sqrt{2}) = 2\sqrt{2}$. At the endpoints, $f(-2, 0) = -2$ and $f(2, 0) = 2$. Therefore the absolute minimum is $f(-2, 0) = -2$ when $t = \pi$; the absolute maximum is $f(\sqrt{2}, \sqrt{2}) = 2\sqrt{2}$ when $t = \frac{\pi}{4}$.
- (ii) On the quartercircle $x^2 + y^2 = 4$, $x \geq 0$ and $y \geq 0$, the endpoints give $f(0, 2) = 2$ and $f(2, 0) = 2$. Therefore the absolute minimum is $f(2, 0) = 2$ and $f(0, 2) = 2$ when $t = 0, \frac{\pi}{2}$ respectively; the absolute maximum is $f(\sqrt{2}, \sqrt{2}) = 2\sqrt{2}$ when $t = \frac{\pi}{4}$.
- (b) $\frac{dg}{dt} = \frac{\partial g}{\partial x} \frac{dx}{dt} + \frac{\partial g}{\partial y} \frac{dy}{dt} = y \frac{dx}{dt} + x \frac{dy}{dt} = -4 \sin^2 t + 4 \cos^2 t = 0 \Rightarrow \cos t = \pm \sin t \Rightarrow x = \pm y$.
- (i) On the semicircle $x^2 + y^2 = 4$, $y \geq 0$, we obtain $x = y = \sqrt{2}$ at $t = \frac{\pi}{4}$ and $x = -\sqrt{2}$, $y = \sqrt{2}$ at $t = \frac{3\pi}{4}$. Then $g(\sqrt{2}, \sqrt{2}) = 2$ and $g(-\sqrt{2}, \sqrt{2}) = -2$. At the endpoints, $g(-2, 0) = g(2, 0) = 0$. Therefore the absolute minimum is $g(-\sqrt{2}, \sqrt{2}) = -2$ when $t = \frac{3\pi}{4}$; the absolute maximum is $g(\sqrt{2}, \sqrt{2}) = 2$ when $t = \frac{\pi}{4}$.
- (ii) On the quartercircle $x^2 + y^2 = 4$, $x \geq 0$ and $y \geq 0$, the endpoints give $g(0, 2) = 0$ and $g(2, 0) = 0$. Therefore the absolute minimum is $g(2, 0) = 0$ and $g(0, 2) = 0$ when $t = 0, \frac{\pi}{2}$ respectively; the absolute maximum is $g(\sqrt{2}, \sqrt{2}) = 2$ when $t = \frac{\pi}{4}$.
- (c) $\frac{dh}{dt} = \frac{\partial h}{\partial x} \frac{dx}{dt} + \frac{\partial h}{\partial y} \frac{dy}{dt} = 4x \frac{dx}{dt} + 2y \frac{dy}{dt} = (8 \cos t)(-2 \sin t) + (4 \sin t)(2 \cos t) = -8 \cos t \sin t = 0 \Rightarrow t = 0, \frac{\pi}{2}, \pi$ yielding the points $(2, 0), (0, 2)$ for $0 \leq t \leq \pi$.
- (i) On the semicircle $x^2 + y^2 = 4$, $y \geq 0$ we have $h(2, 0) = 8$, $h(0, 2) = 4$, and $h(-2, 0) = 8$. Therefore, the absolute minimum is $h(0, 2) = 4$ when $t = \frac{\pi}{2}$; the absolute maximum is $h(2, 0) = 8$ and $h(-2, 0) = 8$ when $t = 0, \pi$ respectively.

- (ii) On the quartercircle $x^2 + y^2 = 4$, $x \geq 0$ and $y \geq 0$ the absolute minimum is $h(0, 2) = 4$ when $t = \frac{\pi}{2}$; the absolute maximum is $h(2, 0) = 8$ when $t = 0$.
62. (a) $\frac{df}{dt} = \frac{\partial f}{\partial x} \frac{dx}{dt} + \frac{\partial f}{\partial y} \frac{dy}{dt} = 2 \frac{dx}{dt} + 3 \frac{dy}{dt} = -6 \sin t + 6 \cos t = 0 \Rightarrow \sin t = \cos t \Rightarrow t = \frac{\pi}{4}$ for $0 \leq t \leq \pi$.
- (i) On the semi-ellipse, $\frac{x^2}{9} + \frac{y^2}{4} = 1$, $y \geq 0$, $f(x, y) = 2x + 3y = 6 \cos t + 6 \sin t = 6\left(\frac{\sqrt{2}}{2}\right) + 6\left(\frac{\sqrt{2}}{2}\right) = 6\sqrt{2}$ at $t = \frac{\pi}{4}$. At the endpoints, $f(-3, 0) = -6$ and $f(3, 0) = 6$. The absolute minimum is $f(-3, 0) = -6$ when $t = \pi$; the absolute maximum is $f\left(\frac{3\sqrt{2}}{2}, \sqrt{2}\right) = 6\sqrt{2}$ when $t = \frac{\pi}{4}$.
- (ii) On the quarter ellipse, at the endpoints $f(0, 2) = 6$ and $f(3, 0) = 6$. The absolute minimum is $f(3, 0) = 6$ and $f(0, 2) = 6$ when $t = 0, \frac{\pi}{2}$ respectively; the absolute maximum is $f\left(\frac{3\sqrt{2}}{2}, \sqrt{2}\right) = 6\sqrt{2}$ when $t = \frac{\pi}{4}$.
- (b) $\frac{dg}{dt} = \frac{\partial g}{\partial x} \frac{dx}{dt} + \frac{\partial g}{\partial y} \frac{dy}{dt} = y \frac{dx}{dt} + x \frac{dy}{dt} = (2 \sin t)(-3 \sin t) + (3 \cos t)(2 \cos t) = 6(\cos^2 t - \sin^2 t) = 6 \cos 2t = 0 \Rightarrow t = \frac{\pi}{4}, \frac{3\pi}{4}$ for $0 \leq t \leq \pi$.
- (i) On the semi-ellipse, $g(x, y) = xy = 6 \sin t \cos t$. Then $g\left(\frac{3\sqrt{2}}{2}, \sqrt{2}\right) = 3$ when $t = \frac{\pi}{4}$, and $g\left(-\frac{3\sqrt{2}}{2}, \sqrt{2}\right) = -3$ when $t = \frac{3\pi}{4}$. At the endpoints, $g(-3, 0) = g(3, 0) = 0$. The absolute minimum is $g\left(-\frac{3\sqrt{2}}{2}, \sqrt{2}\right) = -3$ when $t = \frac{3\pi}{4}$; the absolute maximum is $g\left(\frac{3\sqrt{2}}{2}, \sqrt{2}\right) = 3$ when $t = \frac{\pi}{4}$.
- (ii) On the quarter ellipse, at the endpoints $g(0, 2) = 0$ and $g(3, 0) = 0$. The absolute minimum is $g(3, 0) = 0$ and $g(0, 2) = 0$ at $t = 0, \frac{\pi}{2}$ respectively; the absolute maximum is $g\left(\frac{3\sqrt{2}}{2}, \sqrt{2}\right) = 3$ when $t = \frac{\pi}{4}$.
- (c) $\frac{dh}{dt} = \frac{\partial h}{\partial x} \frac{dx}{dt} + \frac{\partial h}{\partial y} \frac{dy}{dt} = 2x \frac{dx}{dt} + 6y \frac{dy}{dt} = (6 \cos t)(-3 \sin t) + (12 \sin t)(2 \cos t) = 6 \sin t \cos t = 0 \Rightarrow t = 0, \frac{\pi}{2}, \pi$ for $0 \leq t \leq \pi$, yielding the points $(3, 0)$, $(0, 2)$, and $(-3, 0)$.
- (i) On the semi-ellipse, $y \geq 0$ so that $h(3, 0) = 9$, $h(0, 2) = 12$, and $h(-3, 0) = 9$. The absolute minimum is $h(3, 0) = 9$ and $h(-3, 0) = 9$ when $t = 0, \pi$ respectively; the absolute maximum is $h(0, 2) = 12$ when $t = \frac{\pi}{2}$.
- (ii) On the quarter ellipse, the absolute minimum is $h(3, 0) = 9$ when $t = 0$; the absolute maximum is $h(0, 2) = 12$ when $t = \frac{\pi}{2}$.
63. $\frac{df}{dt} = \frac{\partial f}{\partial x} \frac{dx}{dt} + \frac{\partial f}{\partial y} \frac{dy}{dt} = y \frac{dx}{dt} + x \frac{dy}{dt}$
- (i) $x = 2t$ and $y = t + 1 \Rightarrow \frac{df}{dt} = (t + 1)(2) + (2t)(1) = 4t + 2 = 0 \Rightarrow t = -\frac{1}{2} \Rightarrow x = -1$ and $y = \frac{1}{2}$ with $f\left(-1, \frac{1}{2}\right) = -\frac{1}{2}$. The absolute minimum is $f\left(-1, \frac{1}{2}\right) = -\frac{1}{2}$ when $t = -\frac{1}{2}$; there is no absolute maximum.
- (ii) For the endpoints: $t = -1 \Rightarrow x = -2$ and $y = 0$ with $f(-2, 0) = 0$; $t = 0 \Rightarrow x = 0$ and $y = 1$ with $f(0, 1) = 0$. The absolute minimum is $f\left(-1, \frac{1}{2}\right) = -\frac{1}{2}$ when $t = -\frac{1}{2}$; the absolute maximum is $f(0, 1) = 0$ and $f(-2, 0) = 0$ when $t = -1, 0$ respectively.

(iii) There are no interior critical points. For the endpoints: $t = 0 \Rightarrow x = 0$ and $y = 1$ with $f(0, 1) = 0$; $t = 1 \Rightarrow x = 2$ and $y = 2$ with $f(2, 2) = 4$. The absolute minimum is $f(0, 1) = 0$ when $t = 0$; the absolute maximum is $f(2, 2) = 4$ when $t = 1$.

64. (a) $\frac{df}{dt} = \frac{\partial f}{\partial x} \frac{dx}{dt} + \frac{\partial f}{\partial y} \frac{dy}{dt} = 2x \frac{dx}{dt} + 2y \frac{dy}{dt}$

(i) $x = t$ and $y = 2 - 2t \Rightarrow \frac{df}{dt} = (2t)(1) + 2(2 - 2t)(-2) = 10t - 8 = 0 \Rightarrow t = \frac{4}{5} \Rightarrow x = \frac{4}{5}$ and $y = \frac{2}{5}$ with $f\left(\frac{4}{5}, \frac{2}{5}\right) = \frac{16}{25} + \frac{4}{25} = \frac{4}{5}$. The absolute minimum is $f\left(\frac{4}{5}, \frac{2}{5}\right) = \frac{4}{5}$ when $t = \frac{4}{5}$; there is no absolute maximum along the line

(ii) For the endpoints: $t = 0 \Rightarrow x = 0$ and $y = 2$ with $f(0, 2) = 4$; $t = 1 \Rightarrow x = 1$ and $y = 0$ with $f(1, 0) = 1$. The absolute minimum is $f\left(\frac{4}{5}, \frac{2}{5}\right) = \frac{4}{5}$ at the interior critical point when $t = \frac{4}{5}$; the absolute maximum is $f(0, 2) = 4$ at the endpoint when $t = 0$.

(b) $\frac{dg}{dt} = \frac{\partial g}{\partial x} \frac{dx}{dt} + \frac{\partial g}{\partial y} \frac{dy}{dt} = \left[\frac{-2x}{(x^2 + y^2)^2} \right] \frac{dx}{dt} + \left[\frac{-2y}{(x^2 + y^2)^2} \right] \frac{dy}{dt}$

(i) $x = t$ and $y = 2 - 2t \Rightarrow x^2 + y^2 = 5t^2 - 8t + 4 \Rightarrow \frac{dg}{dt} = -(5t^2 - 8t + 4)^{-2} [(-2t)(1) + (-2)(2 - 2t)(-2)] = -(5t^2 - 8t + 4)^{-2} (-10t + 8) = 0 \Rightarrow t = \frac{4}{5} \Rightarrow x = \frac{4}{5}$ and $y = \frac{2}{5}$ with $g\left(\frac{4}{5}, \frac{2}{5}\right) = \frac{1}{\left(\frac{4}{5}\right)} = \frac{5}{4}$. The absolute maximum is $g\left(\frac{4}{5}, \frac{2}{5}\right) = \frac{5}{4}$ when $t = \frac{4}{5}$; there is no absolute minimum along the line since x and y can be as large as we please.

(ii) For the endpoints: $t = 0 \Rightarrow x = 0$ and $y = 2$ with $g(0, 2) = \frac{1}{4}$; $t = 1 \Rightarrow x = 1$ and $y = 0$ with $g(1, 0) = 1$. The absolute minimum is $g(0, 2) = \frac{1}{4}$ when $t = 0$; the absolute maximum is $g\left(\frac{4}{5}, \frac{2}{5}\right) = \frac{5}{4}$ when $t = \frac{4}{5}$.

65. $w = (mx_1 + b - y_1)^2 + (mx_2 + b - y_2)^2 + \dots + (mx_n + b - y_n)^2$
 $\Rightarrow \frac{\partial w}{\partial m} = 2(mx_1 + b - y_1)(x_1) + 2(mx_2 + b - y_2)(x_2) + \dots + 2(mx_n + b - y_n)(x_n) = 0$
 $\Rightarrow 2[(mx_1 + b - y_1)(x_1) + (mx_2 + b - y_2)(x_2) + \dots + (mx_n + b - y_n)(x_n)] = 0$
 $\Rightarrow mx_1^2 + bx_1 - x_1y_1 + mx_2^2 + bx_2 - x_2y_2 + \dots + mx_n^2 + bx_n - x_ny_n = 0$
 $\Rightarrow m(x_1^2 + x_2^2 + \dots + x_n^2) + b(x_1 + x_2 + \dots + x_n) - (x_1y_1 + x_2y_2 + \dots + x_ny_n) = m \sum_{k=1}^n (x_k^2) + b \sum_{k=1}^n x_k - \sum_{k=1}^n (x_k y_k) = 0$
 $\Rightarrow \frac{\partial w}{\partial b} = 2(mx_1 + b - y_1)(1) + 2(mx_2 + b - y_2)(1) + \dots + 2(mx_n + b - y_n)(1) = 0$
 $\Rightarrow 2[(mx_1 + b - y_1) + (mx_2 + b - y_2) + \dots + (mx_n + b - y_n)] = 0$
 $\Rightarrow mx_1 + b - y_1 + mx_2 + b - y_2 + \dots + mx_n + b - y_n = 0$
 $\Rightarrow m(x_1 + x_2 + \dots + x_n) + (b + b + \dots + b) - (y_1 + y_2 + \dots + y_n) = m \sum_{k=1}^n x_k + bn - \sum_{k=1}^n y_k = 0$
 $\Rightarrow b = \frac{1}{n} \left(\sum_{k=1}^n y_k - m \sum_{k=1}^n x_k \right)$. Substituting for b in the equation obtained for $\frac{\partial w}{\partial m}$ we get

$$\begin{aligned}
 & m \sum_{k=1}^n (x_k^2) + \frac{1}{n} \left(\sum_{k=1}^n y_k - m \sum_{k=1}^n x_k \right) \sum_{k=1}^n x_k - \sum_{k=1}^n (x_k y_k) = 0. \text{ Multiply both sides by } n \text{ to obtain} \\
 & mn \sum_{k=1}^n (x_k^2) + \left(\sum_{k=1}^n y_k - m \sum_{k=1}^n x_k \right) \sum_{k=1}^n x_k - n \sum_{k=1}^n (x_k y_k) = mn \sum_{k=1}^n (x_k^2) + \left(\sum_{k=1}^n x_k \right) \left(\sum_{k=1}^n y_k \right) - m \left(\sum_{k=1}^n x_k \right)^2 - n \sum_{k=1}^n (x_k y_k) = 0 \\
 & \Rightarrow m \left[n \sum_{k=1}^n (x_k^2) - \left(\sum_{k=1}^n x_k \right)^2 \right] = n \sum_{k=1}^n (x_k y_k) - \left(\sum_{k=1}^n x_k \right) \left(\sum_{k=1}^n y_k \right) \\
 & \Rightarrow m = \frac{n \sum_{k=1}^n (x_k y_k) - \left(\sum_{k=1}^n x_k \right) \left(\sum_{k=1}^n y_k \right)}{n \sum_{k=1}^n (x_k^2) - \left(\sum_{k=1}^n x_k \right)^2} = \frac{\left(\sum_{k=1}^n x_k \right) \left(\sum_{k=1}^n y_k \right) - n \sum_{k=1}^n (x_k y_k)}{\left(\sum_{k=1}^n x_k \right)^2 - n \sum_{k=1}^n (x_k^2)}
 \end{aligned}$$

To show that these values for m and b minimize the sum of the squares of the distances, use second derivative test. $\frac{\partial^2 w}{\partial m^2} = 2x_1^2 + 2x_2^2 + \dots + 2x_n^2 = 2 \sum_{k=1}^n (x_k^2)$; $\frac{\partial^2 w}{\partial m \partial b} = 2x_1 + 2x_2 + \dots + 2x_n = 2 \sum_{k=1}^n x_k$; $\frac{\partial^2 w}{\partial b^2} = 2 + 2 + \dots + 2 = 2n$

The discriminant is: $\left(\frac{\partial^2 w}{\partial m^2} \right) \left(\frac{\partial^2 w}{\partial b^2} \right) - \left(\frac{\partial^2 w}{\partial m \partial b} \right)^2 = \left[2 \sum_{k=1}^n (x_k^2) \right] (2n) - \left[2 \sum_{k=1}^n x_k \right]^2 = 4 \left[n \sum_{k=1}^n (x_k^2) - \left(\sum_{k=1}^n x_k \right)^2 \right]$.

Now, $n \sum_{k=1}^n (x_k^2) - \left(\sum_{k=1}^n x_k \right)^2 = n(x_1^2 + x_2^2 + \dots + x_n^2) - (x_1 + x_2 + \dots + x_n)(x_1 + x_2 + \dots + x_n)$

$$\begin{aligned}
 &= nx_1^2 + nx_2^2 + \dots + nx_n^2 - x_1^2 - x_1x_2 - \dots - x_1x_n - x_2x_1 - x_2^2 - \dots - x_2x_n - \dots - x_nx_1 - x_nx_2 - \dots - x_n^2 \\
 &= (n-1)x_1^2 + (n-1)x_2^2 + \dots + (n-1)x_n^2 - 2x_1x_2 - 2x_1x_3 - \dots - 2x_1x_n - 2x_2x_3 - \dots - 2x_2x_n - \dots - 2x_{n-1}x_n \\
 &= (x_1^2 - 2x_1x_2 + x_2^2) + (x_1^2 - 2x_1x_3 + x_3^2) + \dots + (x_1^2 - 2x_1x_n + x_n^2) + (x_2^2 - 2x_2x_3 + x_3^2) + \dots \\
 &\quad + (x_2^2 - 2x_2x_n + x_n^2) + \dots + (x_{n-1}^2 - 2x_{n-1}x_n + x_n^2) \\
 &= (x_1 - x_2)^2 + (x_1 - x_3)^2 + \dots + (x_1 - x_n)^2 + (x_2 - x_3)^2 + \dots + (x_2 - x_n)^2 + \dots + (x_{n-1} - x_n)^2 \geq 0.
 \end{aligned}$$

Thus we have: $\left(\frac{\partial^2 w}{\partial m^2} \right) \left(\frac{\partial^2 w}{\partial b^2} \right) - \left(\frac{\partial^2 w}{\partial m \partial b} \right)^2 = 4 \left[n \sum_{k=1}^n (x_k^2) - \left(\sum_{k=1}^n x_k \right)^2 \right] \geq 4(0) = 0$. If $x_1 = x_2 = \dots = x_n$ then

$\left(\frac{\partial^2 w}{\partial m^2} \right) \left(\frac{\partial^2 w}{\partial b^2} \right) - \left(\frac{\partial^2 w}{\partial m \partial b} \right)^2 = 0$. Also, $\frac{\partial^2 w}{\partial m^2} = 2 \sum_{k=1}^n (x_k^2) \geq 0$. If $x_1 = x_2 = \dots = x_n = 0$, then $\frac{\partial^2 w}{\partial m^2} = 0$. Provided that at

least one x_i is nonzero and different from the rest of $x_j, j \neq i$, then $\left(\frac{\partial^2 w}{\partial m^2} \right) \left(\frac{\partial^2 w}{\partial b^2} \right) - \left(\frac{\partial^2 w}{\partial m \partial b} \right)^2 > 0$ and

$\frac{\partial^2 w}{\partial m^2} > 0 \Rightarrow$ the values given above for m and b minimize w .

66. $m = \frac{(0)(5) - 3(6)}{(0)^2 - 3(8)} = \frac{3}{4}$ and

$b = \frac{1}{3} \left[5 - \frac{3}{4}(0) \right] = \frac{5}{3}$

$\Rightarrow y = \frac{3}{4}x + \frac{5}{3}; y|_{x=4} = \frac{14}{3}$

k	x_k	y_k	x_k^2	$x_k y_k$
1	-2	0	4	0
2	0	2	0	0
3	2	3	4	6
Σ	0	5	8	6

67. $m = \frac{(2)(-1)-3(-14)}{(2)^2-3(10)} = -\frac{20}{13}$ and

$b = \frac{1}{3} \left[-1 - \left(-\frac{20}{13} \right) (2) \right] = \frac{9}{13}$

$\Rightarrow y = -\frac{20}{13}x + \frac{9}{13}; y|_{x=4} = -\frac{71}{13}$

k	x_k	y_k	x_k^2	$x_k y_k$
1	-1	2	1	-2
2	0	1	0	0
3	3	-4	9	-12
Σ	2	-1	10	-14

68. $m = \frac{(3)(5)-3(8)}{(3)^2-3(5)} = \frac{3}{2}$ and

$b = \frac{1}{3} \left[5 - \frac{3}{2} (3) \right] = \frac{1}{6}$

$\Rightarrow y = \frac{3}{2}x + \frac{1}{6}; y|_{x=4} = \frac{37}{6}$

k	x_k	y_k	x_k^2	$x_k y_k$
1	0	0	0	0
2	1	2	1	2
3	2	3	4	6
Σ	3	5	5	8

69-74. Example CAS commands:

Maple:

```
f := (x,y) -> x^2+y^3-3*x*y;
x0,x1 := -5,5;
y0,y1 := -5,5;
plot3d( f(x,y), x=x0..x1, y=y0..y1, axes=boxed, shading=zhue, title="#69(a) (Section 14.7)");
plot3d( f(x,y), x=x0..x1, y=y0..y1, grid=[40,40], axes=boxed, shading=zhue, style=patchcontour,
title="#69(b) (Section 14.7)");
fx := D[1](f); # (c)
fy := D[2](f);
crit_pts := solve( {fx(x,y) = 0, fy(x,y)=0}, {x,y} );
fxx := D[1](fx); # (d)
fxy := D[2](fx);
fyy := D[2](fy);
discr := unapply( fxx(x,y)*fyy(x,y)-fxy(x,y)^2, (x,y) );
for CP in { crit_pts } do # (e)
eval( [x,y,fxx(x,y),discr(x,y)], CP );
end do;
# (0,0) is a saddle point
# ( 9/4, 3/2) is a local minimum
```

Mathematica: (assigned functions and bounds will vary)

```
Clear[x,y,f]
f[x_,y_] := x^2 + y^3 - 3x y
xmin = -5; xmax = 5; ymin = -5; ymax = 5;
Plot3D[f[x,y], {x, xmin, xmax}, {y, ymin, ymax}, AxesLabel -> {x, y, z}]
ContourPlot[f[x,y], {x, xmin, xmax}, {y, ymin, ymax}, ContourShading -> False, Contours -> 40]
```

```

fx = D[f[x,y], x];
fy = D[f[x,y], y];
critical = Solve[{fx == 0, fy == 0}, {x, y}];
fxx = D[fx, x];
fxy = D[fx, y];
fyy = D[fy, y];
discriminant = fxx fyy - fxy^2
{{x, y}, f[x, y], discriminant, fxx} /. critical

```

14.8 LAGRANGE MULTIPLIERS

- $\nabla f = y\mathbf{i} + x\mathbf{j}$ and $\nabla g = 2x\mathbf{i} + 4y\mathbf{j}$ so that $\nabla f = \lambda \nabla g \Rightarrow y\mathbf{i} + x\mathbf{j} = \lambda(2x\mathbf{i} + 4y\mathbf{j}) \Rightarrow y = 2x\lambda$ and $x = 4y\lambda$
 $\Rightarrow x = 8x\lambda^2 \Rightarrow \lambda = \pm \frac{\sqrt{2}}{4}$ or $x = 0$.

CASE 1: If $x = 0$, then $y = 0$. But $(0, 0)$ is not on the ellipse so $x \neq 0$.

CASE 2: $x \neq 0 \Rightarrow \lambda = \pm \frac{\sqrt{2}}{4} \Rightarrow x = \pm \sqrt{2}y \Rightarrow (\pm \sqrt{2}y)^2 + 2y^2 = 1 \Rightarrow y = \pm \frac{1}{2}$.

Therefore f takes on its extreme values at $(\pm \frac{\sqrt{2}}{2}, \frac{1}{2})$ and $(\pm \frac{\sqrt{2}}{2}, -\frac{1}{2})$. The extreme values of f on the ellipse are $\pm \frac{\sqrt{2}}{2}$.
- $\nabla f = y\mathbf{i} + x\mathbf{j}$ and $\nabla g = 2x\mathbf{i} + 2y\mathbf{j}$ so that $\nabla f = \lambda \nabla g \Rightarrow y\mathbf{i} + x\mathbf{j} = \lambda(2x\mathbf{i} + 2y\mathbf{j}) \Rightarrow y = 2x\lambda$ and $x = 2y\lambda$
 $\Rightarrow x = 4x\lambda^2 \Rightarrow x = 0$ or $\lambda = \pm \frac{1}{2}$.

CASE 1: If $x = 0$, then $y = 0$. But $(0, 0)$ is not on the circle $x^2 + y^2 - 10 = 0$ so $x \neq 0$.

CASE 2: $x \neq 0 \Rightarrow \lambda = \pm \frac{1}{2} \Rightarrow y = 2x(\pm \frac{1}{2}) = \pm x \Rightarrow x^2 + (\pm x)^2 - 10 = 0 \Rightarrow x = \pm \sqrt{5} \Rightarrow y = \pm \sqrt{5}$.

Therefore f takes on its extreme values at $(\pm \sqrt{5}, \sqrt{5})$ and $(\pm \sqrt{5}, -\sqrt{5})$. The extreme values of f on the circle are 5 and -5.
- $\nabla f = -2x\mathbf{i} - 2y\mathbf{j}$ and $\nabla g = \mathbf{i} + 3\mathbf{j}$ so that $\nabla f = \lambda \nabla g \Rightarrow -2x\mathbf{i} - 2y\mathbf{j} = \lambda(\mathbf{i} + 3\mathbf{j}) \Rightarrow x = -\frac{\lambda}{2}$ and $y = -\frac{3\lambda}{2}$
 $\Rightarrow (-\frac{\lambda}{2}) + 3(-\frac{3\lambda}{2}) = 10 \Rightarrow \lambda = -2 \Rightarrow x = 1$ and $y = 3 \Rightarrow f$ takes on its extreme value at $(1, 3)$ on the line. The extreme value is $f(1, 3) = 49 - 1 - 9 = 39$.
- $\nabla f = 2xy\mathbf{i} + x^2\mathbf{j}$ and $\nabla g = \mathbf{i} + \mathbf{j}$ so that $\nabla f = \lambda \nabla g \Rightarrow 2xy\mathbf{i} + x^2\mathbf{j} = \lambda(\mathbf{i} + \mathbf{j}) \Rightarrow 2xy = \lambda$ and $x^2 = \lambda$
 $\Rightarrow 2xy = x^2 \Rightarrow x = 0$ or $2y = x$.

CASE 1: If $x = 0$, then $x + y = 3 \Rightarrow y = 3$.

CASE 2: If $x \neq 0$, then $2y = x$ so that $x + y = 3 \Rightarrow 2y + y = 3 \Rightarrow y = 1 \Rightarrow x = 2$.

Therefore f takes on its extreme values at $(0, 3)$ and $(2, 1)$. The extreme values of f are $f(0, 3) = 0$ and $f(2, 1) = 4$.

5. We optimize $f(x, y) = x^2 + y^2$, the square of the distance to the origin, subject to the constraint $g(x, y) = xy^2 - 54 = 0$. Thus $\nabla f = 2x\mathbf{i} + 2y\mathbf{j}$ and $\nabla g = y^2\mathbf{i} + 2xy\mathbf{j}$ so that $\nabla f = \lambda \nabla g \Rightarrow 2x\mathbf{i} + 2y\mathbf{j} = \lambda(y^2\mathbf{i} + 2xy\mathbf{j}) \Rightarrow 2x = \lambda y^2$ and $2y = 2\lambda xy$.

CASE 1: If $y = 0$, then $x = 0$. But $(0, 0)$ does not satisfy the constraint $xy^2 = 54$ so $y \neq 0$.

CASE 2: If $y \neq 0$, then $2 = 2\lambda x \Rightarrow x = \frac{1}{\lambda} \Rightarrow 2\left(\frac{1}{\lambda}\right) = \lambda y^2 \Rightarrow y^2 = \frac{2}{\lambda^2}$. Then $xy^2 = 54 \Rightarrow \left(\frac{1}{\lambda}\right)\left(\frac{2}{\lambda^2}\right) = 54 \Rightarrow \lambda^3 = \frac{1}{27} \Rightarrow \lambda = \frac{1}{3} \Rightarrow x = 3$ and $y^2 = 18 \Rightarrow x = 3$ and $y = \pm 3\sqrt{2}$.

Therefore $(3, \pm 3\sqrt{2})$ are the points on the curve $xy^2 = 54$ nearest the origin (since $xy^2 = 54$ has points increasingly far away as y gets close to 0, no points are farthest away).

6. We optimize $f(x, y) = x^2 + y^2$, the square of the distance to the origin, subject to the constraint $g(x, y) = x^2y - 2 = 0$. Thus $\nabla f = 2x\mathbf{i} + 2y\mathbf{j}$ and $\nabla g = 2xy\mathbf{i} + x^2\mathbf{j}$ so that $\nabla f = \lambda \nabla g \Rightarrow 2x = 2xy\lambda$ and $2y = x^2\lambda \Rightarrow \lambda = \frac{2y}{x^2}$, since $x = 0 \Rightarrow y = 0$ (but $g(0, 0) \neq 0$). Thus $x \neq 0$ and $2x = 2xy\left(\frac{2y}{x^2}\right) \Rightarrow x^2 = 2y^2 \Rightarrow (2y^2)y - 2 = 0 \Rightarrow y = 1$ (since $y > 0$) $\Rightarrow x = \pm\sqrt{2}$. Therefore $(\pm\sqrt{2}, 1)$ are the points on the curve $x^2y = 2$ nearest the origin (since $x^2y = 2$ has points increasingly far away as x gets close to 0, no points are farthest away).

7. (a) $\nabla f = \mathbf{i} + \mathbf{j}$ and $\nabla g = y\mathbf{i} + x\mathbf{j}$ so that $\nabla f = \lambda \nabla g \Rightarrow \mathbf{i} + \mathbf{j} = \lambda(y\mathbf{i} + x\mathbf{j}) \Rightarrow 1 = \lambda y$ and $1 = \lambda x \Rightarrow y = \frac{1}{\lambda}$ and $x = \frac{1}{\lambda} \Rightarrow \frac{1}{\lambda^2} = 16 \Rightarrow \lambda = \pm\frac{1}{4}$. Use $\lambda = \frac{1}{4}$ since $x > 0$ and $y > 0$. Then $x = 4$ and $y = 4 \Rightarrow$ the minimum value is 8 at the point $(4, 4)$. Now, $xy = 16, x > 0, y > 0$ is a branch of a hyperbola in the first quadrant with the x - and y -axes as asymptotes. The equations $x + y = c$ give a family of parallel lines with $m = -1$. As these lines move away from the origin, the number c increases. Thus the minimum value of c occurs where $x + y = c$ is tangent to the hyperbola's branch.

(b) $\nabla f = y\mathbf{i} + x\mathbf{j}$ and $\nabla g = \mathbf{i} + \mathbf{j}$ so that $\nabla f = \lambda \nabla g \Rightarrow y\mathbf{i} + x\mathbf{j} = \lambda(\mathbf{i} + \mathbf{j}) \Rightarrow y = \lambda = x \Rightarrow y + y = 16 \Rightarrow y = 8 \Rightarrow x = 8 \Rightarrow f(8, 8) = 64$ is the maximum value. The equations $xy = c$ ($x > 0$ and $y > 0$ or $x < 0$ and $y < 0$ to get a maximum value) give a family of hyperbolas in the first and third quadrants with the x - and y -axes as asymptotes. The maximum value of c occurs where the hyperbola $xy = c$ is tangent to the line $x + y = 16$.

8. Let $f(x, y) = x^2 + y^2$ be the square of the distance from the origin. Then $\nabla f = 2x\mathbf{i} + 2y\mathbf{j}$ and $\nabla g = (2x + y)\mathbf{i} + (2y + x)\mathbf{j}$ so that $\nabla f = \lambda \nabla g \Rightarrow 2x = \lambda(2x + y)$ and $2y = \lambda(2y + x) \Rightarrow \frac{2y}{2y+x} = \lambda \Rightarrow 2x = \left(\frac{2y}{2y+x}\right)(2x + y) \Rightarrow x(2y + x) = y(2x + y) \Rightarrow x^2 = y^2 \Rightarrow y = \pm x$.

CASE 1: $y = x \Rightarrow x^2 + x(x) + x^2 - 1 = 0 \Rightarrow x = \pm\frac{1}{\sqrt{3}}$ and $y = x$.

CASE 2: $y = -x \Rightarrow x^2 + x(-x) + (-x)^2 - 1 = 0 \Rightarrow x = \pm 1$ and $y = -x$. Thus $f\left(\frac{1}{\sqrt{3}}, \frac{1}{\sqrt{3}}\right) = \frac{2}{3} = f\left(-\frac{1}{\sqrt{3}}, -\frac{1}{\sqrt{3}}\right)$ and $f(1, -1) = 2 = f(-1, 1)$.

Therefore the points $(1, -1)$ and $(-1, 1)$ are the farthest away; $\left(\frac{1}{\sqrt{3}}, \frac{1}{\sqrt{3}}\right)$ and $\left(-\frac{1}{\sqrt{3}}, -\frac{1}{\sqrt{3}}\right)$ are the closest points to the origin.

9. $V = \pi r^2 h \Rightarrow 16\pi = \pi r^2 h \Rightarrow 16 = r^2 h \Rightarrow g(r, h) = r^2 h - 16$; $S = 2\pi r h + 2\pi r^2 \Rightarrow \nabla S = (2\pi h + 4\pi r)\mathbf{i} + 2\pi r\mathbf{j}$ and $\nabla g = 2r h \mathbf{i} + r^2 \mathbf{j}$ so that $\nabla S = \lambda \nabla g \Rightarrow (2\pi r h + 4\pi r)\mathbf{i} + 2\pi r\mathbf{j} = \lambda(2r h \mathbf{i} + r^2 \mathbf{j}) \Rightarrow 2\pi r h + 4\pi r = 2r h \lambda$ and $2\pi r = \lambda r^2 \Rightarrow r = 0$ or $\lambda = \frac{2\pi}{r}$. But $r = 0$ gives no physical can, so $r \neq 0 \Rightarrow \lambda = \frac{2\pi}{r} \Rightarrow 2\pi h + 4\pi r = 2r h \left(\frac{2\pi}{r}\right) \Rightarrow 2r = h \Rightarrow 16 = r^2(2r) \Rightarrow r = 2 \Rightarrow h = 4$; thus $r = 2$ cm and $h = 4$ cm give the only extreme surface area of 24π cm². Since $r = 4$ cm and $h = 1$ cm $\Rightarrow V = 16\pi$ cm³ and $S = 40\pi$ cm², which is a larger surface area, then 24π cm² must be the minimum surface area.
10. For a cylinder of radius r and height h we want to maximize the surface area $S = 2\pi r h$ subject to the constraint $g(r, h) = r^2 + \left(\frac{h}{2}\right)^2 - a^2 = 0$. Thus $\nabla S = 2\pi h \mathbf{i} + 2\pi r \mathbf{j}$ and $\nabla g = 2r \mathbf{i} + \frac{h}{2} \mathbf{j}$ so that $\nabla S = \lambda \nabla g \Rightarrow 2\pi h = 2\lambda r$ and $2\pi r = \frac{\lambda h}{2} \Rightarrow \frac{\pi h}{r} = \lambda$ and $2\pi r = \left(\frac{\pi h}{r}\right)\left(\frac{h}{2}\right) \Rightarrow 4r^2 = h^2 \Rightarrow h = 2r \Rightarrow r^2 + \frac{4r^2}{4} = a^2 \Rightarrow 2r^2 = a^2 \Rightarrow r = \frac{a}{\sqrt{2}} \Rightarrow h = a\sqrt{2} \Rightarrow S = 2\pi\left(\frac{a}{\sqrt{2}}\right)(a\sqrt{2}) = 2\pi a^2$.
11. $A = (2x)(2y) = 4xy$ subject to $g(x, y) = \frac{x^2}{16} + \frac{y^2}{9} - 1 = 0$; $\nabla A = 4y \mathbf{i} + 4x \mathbf{j}$ and $\nabla g = \frac{x}{8} \mathbf{i} + \frac{2y}{9} \mathbf{j}$ so that $\nabla A = \lambda \nabla g \Rightarrow 4y \mathbf{i} + 4x \mathbf{j} = \lambda\left(\frac{x}{8} \mathbf{i} + \frac{2y}{9} \mathbf{j}\right) \Rightarrow 4y = \left(\frac{x}{8}\right)\lambda$ and $4x = \left(\frac{2y}{9}\right)\lambda \Rightarrow \lambda = \frac{32y}{x}$ and $4x = \left(\frac{2y}{9}\right)\left(\frac{32y}{x}\right) \Rightarrow y = \pm \frac{3}{4}x \Rightarrow \frac{x^2}{16} + \frac{\left(\pm \frac{3}{4}x\right)^2}{9} = 1 \Rightarrow x^2 = 8 \Rightarrow x = \pm 2\sqrt{2}$. We use $x = 2\sqrt{2}$ since x represents distance. Then $y = \frac{3}{4}(2\sqrt{2}) = \frac{3\sqrt{2}}{2}$, so the length is $2x = 4\sqrt{2}$ and the width is $2y = 3\sqrt{2}$.
12. $P = 4x + 4y$ subject to $g(x, y) = \frac{x^2}{a^2} + \frac{y^2}{b^2} - 1 = 0$; $\nabla P = 4\mathbf{i} + 4\mathbf{j}$ and $\nabla g = \frac{2x}{a^2} \mathbf{i} + \frac{2y}{b^2} \mathbf{j}$ so that $\nabla P = \lambda \nabla g \Rightarrow 4 = \left(\frac{2x}{a^2}\right)\lambda$ and $4 = \left(\frac{2y}{b^2}\right)\lambda \Rightarrow \lambda = \frac{2a^2}{x}$ and $4 = \left(\frac{2y}{b^2}\right)\left(\frac{2a^2}{x}\right) \Rightarrow y = \left(\frac{b^2}{a^2}\right)x \Rightarrow \frac{x^2}{a^2} + \frac{\left(\frac{b^2}{a^2}\right)^2 x^2}{b^2} = 1 \Rightarrow \frac{x^2}{a^2} + \frac{b^2 x^2}{a^4} = 1 \Rightarrow (a^2 + b^2)x^2 = a^4 \Rightarrow x = \frac{a^2}{\sqrt{a^2 + b^2}}$, since $x > 0 \Rightarrow y = \left(\frac{b^2}{a^2}\right)x = \frac{b^2}{\sqrt{a^2 + b^2}} \Rightarrow \text{width} = 2x = \frac{2a^2}{\sqrt{a^2 + b^2}}$ and height $= 2y = \frac{2b^2}{\sqrt{a^2 + b^2}} \Rightarrow \text{perimeter is } P = 4x + 4y = \frac{4a^2 + 4b^2}{\sqrt{a^2 + b^2}} = 4\sqrt{a^2 + b^2}$
13. $\nabla f = 2x\mathbf{i} + 2y\mathbf{j}$ and $\nabla g = (2x - 2)\mathbf{i} + (2y - 4)\mathbf{j}$ so that $\nabla f = \lambda \nabla g = 2x\mathbf{i} + 2y\mathbf{j} = \lambda[(2x - 2)\mathbf{i} + (2y - 4)\mathbf{j}] \Rightarrow 2x = \lambda(2x - 2)$ and $2y = \lambda(2y - 4) \Rightarrow x = \frac{\lambda}{\lambda - 1}$, and $y = \frac{2\lambda}{\lambda - 1}$, $\lambda \neq 1 \Rightarrow y = 2x \Rightarrow x^2 - 2x + (2x)^2 - 4(2x) = 0 \Rightarrow x = 0$ and $y = 0$, or $x = 2$ and $y = 4$. $f(0, 0) = 0$ is the minimum value and $f(2, 4) = 20$ is the maximum value. (Note that $\lambda = 1$ gives $2x = 2x - 2$ or $0 = -2$, which is impossible.)
14. $\nabla f = 3\mathbf{i} - \mathbf{j}$ and $\nabla g = 2x\mathbf{i} + 2y\mathbf{j}$ so that $\nabla f = \lambda \nabla g \Rightarrow 3 = 2\lambda x$ and $-1 = 2\lambda y \Rightarrow \lambda = \frac{3}{2x}$ and $-1 = 2\left(\frac{3}{2x}\right)y \Rightarrow y = -\frac{x}{3} \Rightarrow x^2 + \left(-\frac{x}{3}\right)^2 = 4 \Rightarrow 10x^2 = 36 \Rightarrow x = \pm \frac{6}{\sqrt{10}} \Rightarrow x = \frac{6}{\sqrt{10}}$ and $y = -\frac{2}{\sqrt{10}}$, or $x = -\frac{6}{\sqrt{10}}$ and $y = \frac{2}{\sqrt{10}}$. Therefore $f\left(\frac{6}{\sqrt{10}}, -\frac{2}{\sqrt{10}}\right) = \frac{20}{\sqrt{10}} + 6 = 2\sqrt{10} + 6 \approx 12.325$ is the maximum value, and $f\left(-\frac{6}{\sqrt{10}}, \frac{2}{\sqrt{10}}\right) = -2\sqrt{10} + 6 \approx -0.325$ is the minimum value.

15. $\nabla T = (8x - 4y)\mathbf{i} + (-4x + 2y)\mathbf{j}$ and $g(x, y) = x^2 + y^2 - 25 = 0 \Rightarrow \nabla g = 2x\mathbf{i} + 2y\mathbf{j}$ so that $\nabla T = \lambda \nabla g$
 $\Rightarrow (8x - 4y)\mathbf{i} + (-4x + 2y)\mathbf{j} = \lambda(2x\mathbf{i} + 2y\mathbf{j}) \Rightarrow 8x - 4y = 2\lambda x$ and $-4x + 2y = 2\lambda y \Rightarrow y = \frac{-2x}{\lambda - 1}, \lambda \neq 1$
 $\Rightarrow 8x - 4\left(\frac{-2x}{\lambda - 1}\right) = 2\lambda x \Rightarrow x = 0$, or $\lambda = 0$, or $\lambda = 5$.

CASE 1: $x = 0 \Rightarrow y = 0$; but $(0, 0)$ is not on $x^2 + y^2 = 25$ so $x \neq 0$.

CASE 2: $\lambda = 0 \Rightarrow y = 2x \Rightarrow x^2 + (2x)^2 = 25 \Rightarrow x = \pm\sqrt{5}$ and $y = 2x$.

CASE 3: $\lambda = 5 \Rightarrow y = -\frac{2x}{4} = -\frac{x}{2} \Rightarrow x^2 + \left(-\frac{x}{2}\right)^2 = 25 \Rightarrow x = \pm 2\sqrt{5} \Rightarrow x = 2\sqrt{5}$ and $y = -\sqrt{5}$, or $x = -2\sqrt{5}$
and $y = \sqrt{5}$.

Therefore $T(\sqrt{5}, 2\sqrt{5}) = 0^\circ = T(-\sqrt{5}, -2\sqrt{5})$ is the minimum value and $T(2\sqrt{5}, -\sqrt{5}) = 125^\circ = T(-2\sqrt{5}, \sqrt{5})$ is the maximum value. (Note: $\lambda = 1 \Rightarrow x = 0$ from the equation $-4x + 2y = 2\lambda y$; but we found $x \neq 0$ in CASE 1.)

16. The surface area is given by $S = 4\pi r^2 + 2\pi rh$ subject to the constraint $V(r, h) = \frac{4}{3}\pi r^3 + \pi r^2 h = 8000$. Thus
 $\nabla S = (8\pi r + 2\pi h)\mathbf{i} + 2\pi r\mathbf{j}$ and $\nabla V = (4\pi r^2 + 2\pi rh)\mathbf{i} + 2\pi r^2\mathbf{j}$ so that $\nabla S = \lambda \nabla V = (8\pi r + 2\pi h)\mathbf{i} + 2\pi r\mathbf{j}$
 $= \lambda \left[(4\pi r^2 + 2\pi rh)\mathbf{i} + 2\pi r^2\mathbf{j} \right] \Rightarrow 8\pi r + 2\pi h = \lambda(4\pi r^2 + 2\pi rh)$ and $2\pi r = \lambda 2\pi r^2 \Rightarrow r = 0$ or $2 = r\lambda$. But $r \neq 0$
so $2 = r\lambda \Rightarrow \lambda = \frac{2}{r} \Rightarrow 4r + h = \frac{2}{r}(2r^2 + rh) \Rightarrow h = 0 \Rightarrow$ the tank is a sphere (there is no cylindrical part) and
 $\frac{4}{3}\pi r^3 = 8000 \Rightarrow r = 10\left(\frac{6}{\pi}\right)^{1/3}$.

17. Let $f(x, y, z) = (x-1)^2 + (y-1)^2 + (z-1)^2$ be the square of the distance from $(1, 1, 1)$. Then
 $\nabla f = 2(x-1)\mathbf{i} + 2(y-1)\mathbf{j} + 2(z-1)\mathbf{k}$ and $\nabla g = \mathbf{i} + 2\mathbf{j} + 3\mathbf{k}$ so that $\nabla f = \lambda \nabla g$
 $\Rightarrow 2(x-1)\mathbf{i} + 2(y-1)\mathbf{j} + 2(z-1)\mathbf{k} = \lambda(\mathbf{i} + 2\mathbf{j} + 3\mathbf{k}) \Rightarrow 2(x-1) = \lambda, 2(y-1) = 2\lambda, 2(z-1) = 3\lambda$
 $\Rightarrow 2(y-1) = 2[2(x-1)]$ and $2(z-1) = 3[2(x-1)] \Rightarrow x = \frac{y+1}{2} \Rightarrow z+2 = 3\left(\frac{y+1}{2}\right)$ or $z = \frac{3y-1}{2}$; thus
 $\frac{y+1}{2} + 2y + 3\left(\frac{3y-1}{2}\right) - 13 = 0 \Rightarrow y = 2 \Rightarrow x = \frac{3}{2}$ and $z = \frac{5}{2}$. Therefore the point $\left(\frac{3}{2}, 2, \frac{5}{2}\right)$ is closest (since no
point on the plane is farthest from the point $(1, 1, 1)$).

18. Let $f(x, y, z) = (x-1)^2 + (y+1)^2 + (z-1)^2$ be the square of the distance from $(1, -1, 1)$. Then
 $\nabla f = 2(x-1)\mathbf{i} + 2(y+1)\mathbf{j} + 2(z-1)\mathbf{k}$ and $\nabla g = 2x\mathbf{i} + 2y\mathbf{j} + 2z\mathbf{k}$ so that $\nabla f = \lambda \nabla g \Rightarrow x-1 = \lambda x, y+1 = \lambda y$ and
 $z-1 = \lambda z \Rightarrow x = \frac{1}{1-\lambda}, y = -\frac{1}{1-\lambda}$, and $z = \frac{1}{1-\lambda}$ for $\lambda \neq 1 \Rightarrow \left(\frac{1}{1-\lambda}\right)^2 + \left(\frac{-1}{1-\lambda}\right)^2 + \left(\frac{1}{1-\lambda}\right)^2 = 4 \Rightarrow \frac{1}{1-\lambda} = \pm \frac{2}{\sqrt{3}}$
 $\Rightarrow x = \frac{2}{\sqrt{3}}, y = -\frac{2}{\sqrt{3}}, z = \frac{2}{\sqrt{3}}$ or $x = -\frac{2}{\sqrt{3}}, y = \frac{2}{\sqrt{3}}, z = -\frac{2}{\sqrt{3}}$. The largest value of f occurs where $x < 0, y > 0$,
and $z < 0$ or at the point $\left(-\frac{2}{\sqrt{3}}, \frac{2}{\sqrt{3}}, -\frac{2}{\sqrt{3}}\right)$ on the sphere.

19. Let $f(x, y, z) = x^2 + y^2 + z^2$ be the square of the distance from the origin. Then $\nabla f = 2x\mathbf{i} + 2y\mathbf{j} + 2z\mathbf{k}$ and
 $\nabla g = 2x\mathbf{i} - 2y\mathbf{j} - 2z\mathbf{k}$ so that $\nabla f = \lambda \nabla g \Rightarrow 2x\mathbf{i} + 2y\mathbf{j} + 2z\mathbf{k} = \lambda(2x\mathbf{i} - 2y\mathbf{j} - 2z\mathbf{k}) \Rightarrow 2x = 2x\lambda, 2y = -2y\lambda$, and
 $2z = -2z\lambda \Rightarrow x = 0$ or $\lambda = 1$.

CASE 1: $\lambda = 1 \Rightarrow 2y = -2y \Rightarrow y = 0; 2z = -2z \Rightarrow z = 0 \Rightarrow x^2 - 1 = 0 \Rightarrow x^2 - 1 = 0 \Rightarrow x = \pm 1$ and $y = z = 0$.

CASE 2: $x = 0 \Rightarrow y^2 - z^2 = 1$, which has no solution.

Therefore the points on the unit circle $x^2 + y^2 = 1$, are the points on the surface $x^2 + y^2 - z^2 = 1$ closest to the origin. The minimum distance is 1.

20. Let $f(x, y, z) = x^2 + y^2 + z^2$ be the square of the distance to the origin. Then $\nabla f = 2x\mathbf{i} + 2y\mathbf{j} + 2z\mathbf{k}$ and $\nabla g = y\mathbf{i} + x\mathbf{j} - \mathbf{k}$ so that $\nabla f = \lambda \nabla g \Rightarrow 2x\mathbf{i} + 2y\mathbf{j} + 2z\mathbf{k} = \lambda(y\mathbf{i} + x\mathbf{j} - \mathbf{k}) \Rightarrow 2x = \lambda y$, $2y = \lambda x$, and $2z = -\lambda$
 $\Rightarrow x = \frac{\lambda y}{2} \Rightarrow 2y = \lambda \left(\frac{\lambda y}{2} \right) \Rightarrow y = 0$ or $\lambda = \pm 2$.

CASE 1: $y = 0 \Rightarrow x = 0 \Rightarrow -z + 1 = 0 \Rightarrow z = 1$.

CASE 2: $\lambda = 2 \Rightarrow x = y$ and $z = -1 \Rightarrow x^2 - (-1) + 1 = 0 \Rightarrow x^2 + 2 = 0$, so no solution.

CASE 3: $\lambda = -2 \Rightarrow x = -y$ and $z = 1 \Rightarrow (-y)y - 1 + 1 = 0 \Rightarrow y = 0$, again.

Therefore $(0, 0, 1)$ is the point on the surface closest to the origin since this point gives the only extreme value and there is no maximum distance from the surface to the origin.

21. Let $f(x, y, z) = x^2 + y^2 + z^2$ be the square of the distance to the origin. Then $\nabla f = 2x\mathbf{i} + 2y\mathbf{j} + 2z\mathbf{k}$ and $\nabla g = -y\mathbf{i} - x\mathbf{j} + 2z\mathbf{k}$ so that $\nabla f = \lambda \nabla g \Rightarrow 2x\mathbf{i} + 2y\mathbf{j} + 2z\mathbf{k} = \lambda(-y\mathbf{i} - x\mathbf{j} + 2z\mathbf{k}) \Rightarrow 2x = -y\lambda$, $2y = -x\lambda$, and $2z = 2z\lambda \Rightarrow \lambda = 1$ or $z = 0$.

CASE 1: $\lambda = 1 \Rightarrow 2x = -y$ and $2y = -x \Rightarrow y = 0$ and $x = 0 \Rightarrow z^2 - 4 = 0 \Rightarrow z = \pm 2$ and $x = y = 0$.

CASE 2: $z = 0 \Rightarrow -xy - 4 = 0 \Rightarrow y = -\frac{4}{x}$. Then $2x = \frac{4}{x}\lambda \Rightarrow \lambda = \frac{x^2}{2}$, and $-\frac{8}{x} = -x\lambda \Rightarrow -\frac{8}{x} = -x \left(\frac{x^2}{2} \right)$

$$\Rightarrow x^4 = 16 \Rightarrow x = \pm 2. \text{ Thus, } x = 2 \text{ and } y = -2, \text{ or } x = -2 \text{ and } y = 2.$$

Therefore we get four points: $(2, -2, 0)$, $(-2, 2, 0)$, $(0, 0, -2)$, and $(0, 0, 2)$. But the points $(0, 0, 2)$ and $(0, 0, -2)$ are closest to the origin since they are 2 units away and the others are $2\sqrt{2}$ units away.

22. Let $f(x, y, z) = x^2 + y^2 + z^2$ be the square of the distance to the origin. Then $\nabla f = 2x\mathbf{i} + 2y\mathbf{j} + 2z\mathbf{k}$ and $\nabla g = yz\mathbf{i} + xz\mathbf{j} + xy\mathbf{k}$ so that $\nabla f = \lambda \nabla g \Rightarrow 2x = \lambda yz$, $2y = \lambda xz$, and $2z = \lambda xy \Rightarrow 2x^2 = \lambda xyz$ and $2y^2 = \lambda yxz \Rightarrow x^2 = y^2 \Rightarrow y = \pm x \Rightarrow z = \pm x \Rightarrow x(\pm x)(\pm x) = 1 \Rightarrow x = \pm 1 \Rightarrow$ the points are $(1, 1, 1)$, $(1, -1, -1)$, $(-1, -1, 1)$, and $(-1, 1, -1)$.

23. $\nabla f = \mathbf{i} - 2\mathbf{j} + 5\mathbf{k}$ and $\nabla g = 2x\mathbf{i} + 2y\mathbf{j} + 2z\mathbf{k}$ so that $\nabla f = \lambda \nabla g \Rightarrow \mathbf{i} - 2\mathbf{j} + 5\mathbf{k} = \lambda(2x\mathbf{i} + 2y\mathbf{j} + 2z\mathbf{k}) \Rightarrow 1 = 2x\lambda$, $-2 = 2y\lambda$, and $5 = 2z\lambda \Rightarrow x = \frac{1}{2\lambda}$, $y = -\frac{1}{\lambda} = -2x$, and $z = \frac{5}{2\lambda} = 5x \Rightarrow x^2 + (-2x)^2 + (5x)^2 = 30 \Rightarrow x = \pm 1$. Thus, $x = 1$, $y = -2$, $z = 5$ or $x = -1$, $y = 2$, $z = -5$. Therefore $f(1, -2, 5) = 30$ is the maximum value and $f(-1, 2, -5) = -30$ is the minimum value.

24. $\nabla f = \mathbf{i} + 2\mathbf{j} + 3\mathbf{k}$ and $\nabla g = 2x\mathbf{i} + 2y\mathbf{j} + 2z\mathbf{k}$ so that $\nabla f = \lambda \nabla g \Rightarrow \mathbf{i} + 2\mathbf{j} + 3\mathbf{k} = \lambda(2x\mathbf{i} + 2y\mathbf{j} + 2z\mathbf{k}) \Rightarrow 1 = 2x\lambda$, $2 = 2y\lambda$, and $3 = 2z\lambda \Rightarrow x = \frac{1}{2\lambda}$, $y = \frac{1}{\lambda} = 2x$, and $z = \frac{3}{2\lambda} = 3x \Rightarrow x^2 + (2x)^2 + (3x)^2 = 25 \Rightarrow x = \pm \frac{5}{\sqrt{14}}$. Thus, $x = \frac{5}{\sqrt{14}}$, $y = \frac{10}{\sqrt{14}}$, $z = \frac{15}{\sqrt{14}}$ or $x = -\frac{5}{\sqrt{14}}$, $y = -\frac{10}{\sqrt{14}}$, $z = -\frac{15}{\sqrt{14}}$. Therefore $f\left(\frac{5}{\sqrt{14}}, \frac{10}{\sqrt{14}}, \frac{15}{\sqrt{14}}\right) = 5\sqrt{14}$ is the maximum value and $f\left(-\frac{5}{\sqrt{14}}, -\frac{10}{\sqrt{14}}, -\frac{15}{\sqrt{14}}\right) = -5\sqrt{14}$ is the minimum value.

25. $f(x, y, z) = x^2 + y^2 + z^2$ and $g(x, y, z) = x + y + z - 9 = 0 \Rightarrow \nabla f = 2x\mathbf{i} + 2y\mathbf{j} + 2z\mathbf{k}$ and $\nabla g = \mathbf{i} + \mathbf{j} + \mathbf{k}$ so that $\nabla f = \lambda \nabla g \Rightarrow 2x\mathbf{i} + 2y\mathbf{j} + 2z\mathbf{k} = \lambda(\mathbf{i} + \mathbf{j} + \mathbf{k}) \Rightarrow 2x = \lambda, 2y = \lambda,$ and $2z = \lambda \Rightarrow x = y = z \Rightarrow x + x + x - 9 = 0 \Rightarrow x = 3, y = 3,$ and $z = 3.$
26. $f(x, y, z) = xyz$ and $g(x, y, z) = x + y + z^2 - 16 = 0 \Rightarrow \nabla f = yz\mathbf{i} + xz\mathbf{j} + xy\mathbf{k}$ and $\nabla g = \mathbf{i} + \mathbf{j} + 2z\mathbf{k}$ so that $\nabla f = \lambda \nabla g \Rightarrow yz\mathbf{i} + xz\mathbf{j} + xy\mathbf{k} = \lambda(\mathbf{i} + \mathbf{j} + 2z\mathbf{k}) \Rightarrow yz = \lambda, xz = \lambda,$ and $xy = 2z\lambda \Rightarrow yz = xz \Rightarrow z = 0$ or $y = x.$ But $z > 0$ so that $y = x \Rightarrow x^2 = 2z\lambda$ and $xz = \lambda.$ Then $x^2 = 2z(xz) \Rightarrow x = 0$ or $x = 2z^2.$ But $x > 0$ so that $x = 2z^2 \Rightarrow y = 2z^2 \Rightarrow 2z^2 + 2z^2 + z^2 = 16 \Rightarrow z = \pm \frac{4}{\sqrt{5}}.$ We use $z = \frac{4}{\sqrt{5}}$ since $z > 0.$ Then $x = \frac{32}{5}$ and $y = \frac{32}{5}$ which yields $f\left(\frac{32}{5}, \frac{32}{5}, \frac{4}{\sqrt{5}}\right) = \frac{4096}{25\sqrt{5}}.$
27. $V = xyz$ and $g(x, y, z) = x^2 + y^2 + z^2 - 1 = 0 \Rightarrow \nabla V = yz\mathbf{i} + xz\mathbf{j} + xy\mathbf{k}$ and $\nabla g = 2x\mathbf{i} + 2y\mathbf{j} + 2z\mathbf{k}$ so that $\nabla V = \lambda \nabla g \Rightarrow yz = \lambda x, xz = \lambda y,$ and $xy = \lambda z \Rightarrow xyz = \lambda x^2$ and $xyz = \lambda y^2 \Rightarrow y = \pm x \Rightarrow z = \pm x \Rightarrow x^2 + x^2 + x^2 = 1 \Rightarrow x = \frac{1}{\sqrt{3}}$ since $x > 0 \Rightarrow$ the dimensions of the box are $\frac{1}{\sqrt{3}}$ by $\frac{1}{\sqrt{3}}$ by $\frac{1}{\sqrt{3}}$ for maximum volume. (Note that there is no minimum volume since the box could be made arbitrarily thin.)
28. $V = xyz$ with x, y, z all positive and $\frac{x}{a} + \frac{y}{b} + \frac{z}{c} = 1;$ thus $V = xyz$ and $g(x, y, z) = bcx + acy + abz - abc = 0 \Rightarrow \nabla V = yz\mathbf{i} + xz\mathbf{j} + xy\mathbf{k}$ and $\nabla g = bc\mathbf{i} + ac\mathbf{j} + ab\mathbf{k}$ so that $\nabla V = \lambda \nabla g \Rightarrow yz = \lambda bc, xz = \lambda ac,$ and $xy = \lambda ab \Rightarrow xyz = \lambda bcx, xyz = \lambda acy,$ and $xyz = \lambda abz \Rightarrow \lambda \neq 0.$ Also, $\lambda bcx = \lambda acy = \lambda abz \Rightarrow bx = ay, cy = bz,$ and $cx = az \Rightarrow y = \frac{b}{a}x$ and $z = \frac{c}{a}x.$ Then $\frac{x}{a} + \frac{y}{b} + \frac{z}{c} = 1 \Rightarrow \frac{x}{a} + \frac{1}{b}\left(\frac{b}{a}x\right) + \frac{1}{c}\left(\frac{c}{a}x\right) = 1 \Rightarrow \frac{3x}{a} = 1 \Rightarrow x = \frac{a}{3} \Rightarrow y = \left(\frac{b}{a}\right)\left(\frac{a}{3}\right) = \frac{b}{3}$ and $z = \left(\frac{c}{a}\right)\left(\frac{a}{3}\right) = \frac{c}{3} \Rightarrow V = xyz = \left(\frac{a}{3}\right)\left(\frac{b}{3}\right)\left(\frac{c}{3}\right) = \frac{abc}{27}$ is the maximum volume. (Note that there is no minimum volume since the box could be made arbitrarily thin.)
29. $\nabla T = 16x\mathbf{i} + 4z\mathbf{j} + (4y - 16)\mathbf{k}$ and $\nabla g = 8x\mathbf{i} + 2y\mathbf{j} + 8z\mathbf{k}$ so that $\nabla T = \lambda \nabla g \Rightarrow 16x\mathbf{i} + 4z\mathbf{j} + (4y - 16)\mathbf{k} = \lambda(8x\mathbf{i} + 2y\mathbf{j} + 8z\mathbf{k}) \Rightarrow 16x = 8x\lambda, 4z = 2y\lambda,$ and $4y - 16 = 8z\lambda \Rightarrow \lambda = 2$ or $x = 0.$
CASE 1: $\lambda = 2 \Rightarrow 4z = 2y(2) \Rightarrow z = y.$ Then $4z - 16 = 16z \Rightarrow z = -\frac{4}{3} \Rightarrow y = -\frac{4}{3}.$ Then $4x^2 + \left(-\frac{4}{3}\right)^2 + 4\left(-\frac{4}{3}\right)^2 = 16 \Rightarrow x = \pm \frac{4}{3}.$
CASE 2: $x = 0 \Rightarrow \lambda = \frac{2z}{y} \Rightarrow 4y - 16 = 8z\left(\frac{2z}{y}\right) \Rightarrow y^2 - 4y = 4z^2 \Rightarrow 4(0)^2 + y^2 + (y^2 - 4y) - 16 = 0 \Rightarrow y^2 - 2y - 8 = 0 \Rightarrow (y - 4)(y + 2) = 0 \Rightarrow y = 4$ or $y = -2.$ Now $y = 4 \Rightarrow 4z^2 = 4^2 - 4(4) \Rightarrow z = 0$ and $y = -2 \Rightarrow 4z^2 = (-2)^2 - 4(-2) \Rightarrow z = \pm \sqrt{3}.$
The temperatures are $T\left(\pm \frac{4}{3}, -\frac{4}{3}, -\frac{4}{3}\right) = \left(642 \frac{2}{3}\right)^\circ, T(0, 4, 0) = 600^\circ, T(0, -2, \sqrt{3}) = \left(600 - 24\sqrt{3}\right)^\circ,$ and $T(0, -2, -\sqrt{3}) = \left(600 + 24\sqrt{3}\right)^\circ \approx 641.6^\circ.$ Therefore $\left(\pm \frac{4}{3}, -\frac{4}{3}, -\frac{4}{3}\right)$ are the hottest points on the space probe.
30. $\nabla T = 400yz^2\mathbf{i} + 400xz^2\mathbf{j} + 800xyz\mathbf{k}$ and $\nabla g = 2x\mathbf{i} + 2y\mathbf{j} + 2z\mathbf{k}$ so that $\nabla T = \lambda \nabla g \Rightarrow 400yz^2\mathbf{i} + 400xz^2\mathbf{j} + 800xyz\mathbf{k} = \lambda(2x\mathbf{i} + 2y\mathbf{j} + 2z\mathbf{k}) \Rightarrow 400yz^2 = 2x\lambda, 400xz^2 = 2y\lambda,$ and $800xyz = 2z\lambda.$ Solving this system yields the points $(0, \pm 1, 0), (\pm 1, 0, 0),$ and $\left(\pm \frac{1}{2}, \pm \frac{1}{2}, \pm \frac{\sqrt{2}}{2}\right).$ The corresponding

temperatures are $T(0, \pm 1, 0) = 0$, $T(\pm 1, 0, 0) = 0$, and $T\left(\pm \frac{1}{2}, \pm \frac{1}{2}, \pm \frac{\sqrt{2}}{2}\right) = \pm 50$. Therefore 50 is the maximum temperature at $\left(\frac{1}{2}, \frac{1}{2}, \pm \frac{\sqrt{2}}{2}\right)$ and $\left(-\frac{1}{2}, -\frac{1}{2}, \pm \frac{\sqrt{2}}{2}\right)$; -50 is the minimum temperature at $\left(\frac{1}{2}, -\frac{1}{2}, \pm \frac{\sqrt{2}}{2}\right)$ and $\left(-\frac{1}{2}, \frac{1}{2}, \pm \frac{\sqrt{2}}{2}\right)$.

31. (a) If we replace x by $2x$ and y by $2y$ in the formula for P , P changes by a factor of $2^\alpha \cdot 2^{1-\alpha} = 2$.
 (b) For the given information, the production function is $P(x, y) = 120x^{3/4}y^{1/4}$ and the constraint is $G(x, y) = 250x + 400y - 100,000 = 0$. $\nabla P = \lambda \nabla G$ implies

$$90\left(\frac{x}{y}\right)^{-1/4} = 250\lambda$$

$$30\left(\frac{x}{y}\right)^{3/4} = 400\lambda$$

Eliminating λ yields $\frac{x}{y} = \frac{24}{5}$ or $5x = 24y$. Now we solve the system

$$5x - 24y = 0$$

$$250x + 400y = 100,000$$

and find $x = 300$, $y = 62.5$. $P(300, 62.5) \approx 24,322$ units.

32. We can omit k since it affects the value but not the location of the maximum. We then have $P(x, y) = x^\alpha y^{1-\alpha}$ and $G(x, y) = c_1x + c_2y - B = 0$. $\nabla P = \lambda \nabla G$ implies

$$\alpha\left(\frac{x}{y}\right)^{\alpha-1} = \lambda c_1$$

$$(1-\alpha)\left(\frac{x}{y}\right)^{\alpha-1} = \lambda \frac{1-\alpha}{c_2}$$

Eliminating λ yields $\frac{x}{y} = \frac{c_2}{c_1} \cdot \frac{\alpha}{1-\alpha}$. Now we solve the system

$$c_1(1-\alpha)x = c_2\alpha y$$

$$c_1x + c_2y = B$$

and find $x = \frac{\alpha B}{c_1}$, $y = \frac{(1-\alpha)B}{c_2}$.

33. $\nabla U = (y+2)\mathbf{i} + x\mathbf{j}$ and $\nabla g = 2\mathbf{i} + \mathbf{j}$ so that $\nabla U = \lambda \nabla g \Rightarrow (y+2)\mathbf{i} + x\mathbf{j} = \lambda(2\mathbf{i} + \mathbf{j}) \Rightarrow y+2 = 2\lambda$ and $x = \lambda \Rightarrow y+2 = 2x \Rightarrow y = 2x-2 \Rightarrow 2x + (2x-2) = 30 \Rightarrow x = 8$ and $y = 14$. Therefore $U(8, 14) = \$128$ is the maximum value of U under the constraint.

34. $Q(p, q, r) = 2(pq + pr + qr)$ and $G(p, q, r) = p + q + r - 1 = 0$. $\nabla Q = \lambda \nabla G$ implies

$$\begin{aligned} 2(q + r) &= \lambda \\ 2(p + r) &= \lambda \\ 2(p + q) &= \lambda \end{aligned}$$

which is true only when $p = q = r$. $p + q + r = 1$ then implies that $p = q = r = \frac{1}{3}$. Thus the maximum of Q is $Q\left(\frac{1}{3}, \frac{1}{3}, \frac{1}{3}\right) = 2\left(\frac{1}{9} + \frac{1}{9} + \frac{1}{9}\right) = \frac{2}{3}$.

35. The following diagram shows $L, h,$ and k . We also name the lengths u and v as shown; we assume all named lengths are positive. We will minimize the square of L , which is equal to $(u + k)^2 + (v + h)^2$.

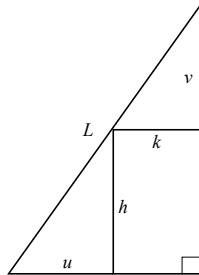

Our function to minimize is $S(u, v) = (u + k)^2 + (v + h)^2$. Using similar triangles, $\frac{v}{k} = \frac{h}{u}$, so our constraint equation is $G(u, v) = uv - hk = 0$. $\nabla S = \lambda \nabla G$ implies

$$\begin{aligned} 2(u + k) &= \lambda v \\ 2(v + h) &= \lambda u \end{aligned}$$

Eliminating λ by dividing the first equation by the second yields $\frac{u + k}{v + h} = \frac{v}{u}$. We combine this with the constraint equation and solve the system

$$\begin{aligned} (u + k) \cdot u &= (v + h) \cdot v \\ hk &= uv \end{aligned}$$

Substituting hk/v for u in the first equation, expanding, and moving all variables to the left side yields the equation $u^4 + ku^3 - h^2ku - h^2k^2 = 0$. Factoring by grouping we get $(u^3 - h^2k)(u + k) = 0$. Since no lengths are negative this gives us the solution $u = (h^2k)^{1/3}$. Substituting this value for u in $hk = uv$ we find

$v = (hk^2)^{1/3}$. (Note that throughout this calculation interchanging h and k has the effect of interchanging u and v . This must be true, since if we rotate the diagram 90 degrees clockwise we don't change the solution to the minimization problem, but now h and v are the horizontal distances and k and u are the vertical distances. All of our equations reflect this symmetry, and we could exploit it to save some computation.)

$$\begin{aligned} \text{Now } L^2 &= (u + k)^2 + (v + h)^2 = \left[(h^2k)^{1/3} + k \right]^2 + \left[(hk^2)^{1/3} + h \right]^2 \\ &= h^{4/3}k^{2/3} + 2h^{2/3}k^{4/3} + k^2 + h^{2/3}k^{4/3} + 2h^{4/3}k^{2/3} + h^2 \\ &= (h^{2/3} + k^{2/3})^3 \end{aligned}$$

Thus the minimum L is given by $(h^{2/3} + k^{2/3})^{3/2}$.

36. $\nabla M = (6+z)\mathbf{i} - 2y\mathbf{j} + x\mathbf{k}$ and $\nabla g = 2x\mathbf{i} + 2y\mathbf{j} + 2z\mathbf{k}$ so that $\nabla M = \lambda\nabla g \Rightarrow (6+z)\mathbf{i} - 2y\mathbf{j} + x\mathbf{k} = \lambda(2x\mathbf{i} + 2y\mathbf{j} + 2z\mathbf{k}) \Rightarrow 6+z = 2x\lambda, -2y = 2y\lambda, x = 2z\lambda \Rightarrow \lambda = -1$ or $y = 0$.

CASE 1: $\lambda = -1 \Rightarrow 6+z = -2x$ and $x = -2z \Rightarrow 6+z = -2(-2z) \Rightarrow z = 2$ and $x = -4$. Then

$$(-4)^2 + y^2 + 2^2 - 36 = 0 \Rightarrow y = \pm 4.$$

CASE 2: $y = 0, 6+z = 2x\lambda$, and $x = 2z\lambda \Rightarrow \lambda = \frac{x}{2z} \Rightarrow 6+z = 2x\left(\frac{x}{2z}\right) \Rightarrow 6z + z^2 = x^2 \Rightarrow (6z + z^2) + 0^2 + z^2 = 36 \Rightarrow z = -6$ or $z = 3$. Now $z = -6 \Rightarrow x^2 = 0 \Rightarrow x = 0; z = 3 \Rightarrow x^2 = 27 \Rightarrow x = \pm 3\sqrt{3}$.

Therefore we have the points $(\pm 3\sqrt{3}, 0, 3), (0, 0, -6)$, and $(-4, \pm 4, 2)$. Then $M(3\sqrt{3}, 0, 3) = 27\sqrt{3} + 60 \approx 106.8, M(-3\sqrt{3}, 0, 3) = 60 - 27\sqrt{3} \approx 13.2, M(0, 0, -6) = 60$, and $M(-4, 4, 2) = 12 = M(-4, -4, 2)$.

Therefore, the weakest field is at $(-4, \pm 4, 2)$.

37. Let $g_1(x, y, z) = 2x - y = 0$ and $g_2(x, y, z) = y + z = 0 \Rightarrow \nabla g_1 = 2\mathbf{i} - \mathbf{j}, \nabla g_2 = \mathbf{j} + \mathbf{k}$, and $\nabla f = 2x\mathbf{i} + 2\mathbf{j} - 2z\mathbf{k}$ so that $\nabla f = \lambda\nabla g_1 + \mu\nabla g_2 \Rightarrow 2x\mathbf{i} + 2\mathbf{j} - 2z\mathbf{k} = \lambda(2\mathbf{i} - \mathbf{j}) + \mu(\mathbf{j} + \mathbf{k}) \Rightarrow 2x\mathbf{i} + 2\mathbf{j} - 2z\mathbf{k} = 2\lambda\mathbf{i} + (\mu - \lambda)\mathbf{j} + \mu\mathbf{k} \Rightarrow 2x = 2\lambda, 2 = \mu - \lambda$, and $-2z = \mu \Rightarrow x = \lambda$. Then $2 = -2z - x \Rightarrow x = -2z - 2$ so that $2x - y = 0 \Rightarrow 2(-2z - 2) - y = 0 \Rightarrow -4z - 4 - y = 0$. This equation coupled with $y + z = 0$ implies $z = -\frac{4}{3}$ and $y = \frac{4}{3}$.

Then $x = \frac{2}{3}$ so that $(\frac{2}{3}, \frac{4}{3}, -\frac{4}{3})$ is the point that gives the maximum value $f(\frac{2}{3}, \frac{4}{3}, -\frac{4}{3}) = (\frac{2}{3})^2 + 2(\frac{4}{3}) - (-\frac{4}{3})^2 = \frac{4}{3}$.

38. Let $g_1(x, y, z) = x + 2y + 3z - 6 = 0$ and $g_2(x, y, z) = x + 3y + 9z - 9 = 0 \Rightarrow \nabla g_1 = \mathbf{i} + 2\mathbf{j} + 3\mathbf{k}, \nabla g_2 = \mathbf{i} + 3\mathbf{j} + 9\mathbf{k}$, and $\nabla f = 2x\mathbf{i} + 2y\mathbf{j} + 2z\mathbf{k}$ so that $\nabla f = \lambda\nabla g_1 + \mu\nabla g_2 \Rightarrow 2x\mathbf{i} + 2y\mathbf{j} + 2z\mathbf{k} = \lambda(\mathbf{i} + 2\mathbf{j} + 3\mathbf{k}) + \mu(\mathbf{i} + 3\mathbf{j} + 9\mathbf{k}) \Rightarrow 2x = \lambda + \mu, 2y = 2\lambda + 3\mu$, and $2z = 3\lambda + 9\mu$. Then $0 = x + 2y + 3z - 6 = \frac{1}{2}(\lambda + \mu) + (2\lambda + 3\mu) + (\frac{9}{2}\lambda + \frac{27}{2}\mu) - 6 \Rightarrow 7\lambda + 17\mu = 6; 0 = x + 3y + 9z - 9 \Rightarrow \frac{1}{2}(\lambda + \mu) + (3\lambda + \frac{9}{2}\mu) + (\frac{27}{2}\lambda + \frac{81}{2}\mu) - 9 \Rightarrow 34\lambda + 91\mu = 18$. Solving these two equations for λ and μ gives $\lambda = \frac{240}{59}$ and $\mu = -\frac{78}{59} \Rightarrow x = \frac{\lambda + \mu}{2} = \frac{81}{59}, y = \frac{2\lambda + 3\mu}{2} = \frac{123}{59}$, and $z = \frac{3\lambda + 9\mu}{2} = \frac{9}{59}$. The minimum value is $f(\frac{81}{59}, \frac{123}{59}, \frac{9}{59}) = \frac{21,771}{59^2} = \frac{369}{59}$. (Note that there is no maximum value of f subject to the constraints because at least one of the variables x, y , or z can be made arbitrary and assume a value as large as we please.)

39. Let $f(x, y, z) = x^2 + y^2 + z^2$ be the square of the distance from the origin. We want to minimize $f(x, y, z)$ subject to the constraints $g_1(x, y, z) = y + 2z - 12 = 0$ and $g_2(x, y, z) = x + y - 6 = 0$. Thus $\nabla f = 2x\mathbf{i} + 2y\mathbf{j} + 2z\mathbf{k}, \nabla g_1 = \mathbf{j} + 2\mathbf{k}$, and $\nabla g_2 = \mathbf{i} + \mathbf{j}$ so that $\nabla f = \lambda\nabla g_1 + \mu\nabla g_2 \Rightarrow 2x = \mu, 2y = \lambda + \mu$, and $2z = 2\lambda$. Then $0 = y + 2z - 12 = (\frac{\lambda}{2} + \frac{\mu}{2}) + 2\lambda - 12 \Rightarrow \frac{5}{2}\lambda + \frac{1}{2}\mu = 12 \Rightarrow 5\lambda + \mu = 24; 0 = x + y - 6 = \frac{\mu}{2} + (\frac{\lambda}{2} + \frac{\mu}{2}) - 6 \Rightarrow \frac{1}{2}\lambda + \mu = 6 \Rightarrow \lambda + 2\mu = 12$. Solving these two equations for λ and μ gives $\lambda = 4$ and $\mu = 4 \Rightarrow x = \frac{\mu}{2} = 2, y = \frac{\lambda + \mu}{2} = 4$, and $z = \lambda = 4$. The point $(2, 4, 4)$ on the line of intersection is closest to the origin. (There is no maximum distance from the origin since points on the line can be arbitrarily far away.)

40. The maximum value is $f(\frac{2}{3}, \frac{4}{3}, -\frac{4}{3}) = \frac{4}{3}$ from Exercise 33 above.

41. Let $g_1(x, y, z) = z - 1 = 0$ and $g_2(x, y, z) = x^2 + y^2 + z^2 - 10 = 0 \Rightarrow \nabla g_1 = \mathbf{k}$, $\nabla g_2 = 2x\mathbf{i} + 2y\mathbf{j} + 2z\mathbf{k}$, and $\nabla f = 2xyz\mathbf{i} + x^2z\mathbf{j} + x^2y\mathbf{k}$ so that $\nabla f = \lambda \nabla g_1 + \mu \nabla g_2 \Rightarrow 2xyz\mathbf{i} + x^2z\mathbf{j} + x^2y\mathbf{k} = \lambda(\mathbf{k}) + \mu(2x\mathbf{i} + 2y\mathbf{j} + 2z\mathbf{k})$
 $\Rightarrow 2xyz = 2x\mu$, $x^2z = 2y\mu$, and $x^2y = 2z\mu + \lambda \Rightarrow xyz = x\mu \Rightarrow x = 0$ or $yz = \mu \Rightarrow \mu = y$ since $z = 1$.
CASE 1: $x = 0$ and $z = 1 \Rightarrow y^2 - 9 = 0$ (from g_2) $\Rightarrow y = \pm 3$ yielding the points $(0, \pm 3, 1)$.
CASE 2: $\mu = y \Rightarrow x^2z = 2y^2 \Rightarrow x^2 = 2y^2$ (since $z = 1$) $\Rightarrow 2y^2 + y^2 + 1 - 10 = 0$ (from g_2) $\Rightarrow 3y^2 - 9 = 0$
 $\Rightarrow y = \pm \sqrt{3} \Rightarrow x^2 = 2(\pm\sqrt{3})^2 \Rightarrow x = \pm\sqrt{6}$ yielding the points $(\pm\sqrt{6}, \pm\sqrt{3}, 1)$.
Now $f(0, \pm 3, 1) = 1$ and $f(\pm\sqrt{6}, \pm\sqrt{3}, 1) = 6(\pm\sqrt{3}) + 1 = 1 \pm 6\sqrt{3}$. Therefore the maximum of f is $1 + 6\sqrt{3}$ at $(\pm\sqrt{6}, \sqrt{3}, 1)$, and the minimum of f is $1 - 6\sqrt{3}$ at $(\pm\sqrt{6}, -\sqrt{3}, 1)$.
42. (a) Let $g_1(x, y, z) = x + y + z - 40 = 0$ and $g_2(x, y, z) = x + y - z = 0 \Rightarrow \nabla g_1 = \mathbf{i} + \mathbf{j} + \mathbf{k}$, $\nabla g_2 = \mathbf{i} + \mathbf{j} - \mathbf{k}$, and $\nabla w = yz\mathbf{i} + xz\mathbf{j} + xy\mathbf{k}$ so that $\nabla w = \lambda \nabla g_1 + \mu \nabla g_2 \Rightarrow yz\mathbf{i} + xz\mathbf{j} + xy\mathbf{k} = \lambda(\mathbf{i} + \mathbf{j} + \mathbf{k}) + \mu(\mathbf{i} + \mathbf{j} - \mathbf{k})$
 $\Rightarrow yz = \lambda + \mu$, $xz = \lambda + \mu$, and $xy = \lambda - \mu \Rightarrow yz = xz \Rightarrow z = 0$ or $y = x$.
CASE 1: $z = 0 \Rightarrow x + y = 40$ and $x + y = 0 \Rightarrow$ no solution.
CASE 2: $x = y \Rightarrow 2x + z - 40 = 0$ and $2x - z = 0 \Rightarrow z = 20 \Rightarrow x = 10$ and $y = 10 \Rightarrow w = (10)(10)(20) = 2000$
- (b) $\mathbf{n} = \begin{vmatrix} \mathbf{i} & \mathbf{j} & \mathbf{k} \\ 1 & 1 & 1 \\ 1 & 1 & -1 \end{vmatrix} = -2\mathbf{i} + 2\mathbf{j}$ is parallel to the line of intersection \Rightarrow the line is $x = -2t + 10$, $y = 2t + 10$,
 $z = 20$. Since $z = 20$, we see that $w = xyz = (-2t + 10)(2t + 10)(20) = (-4t^2 + 100)(20)$ which has its maximum when $t = 0 \Rightarrow x = 10$, $y = 10$, and $z = 20$.
43. Let $g_1(x, y, z) = y - x = 0$ and $g_2(x, y, z) = x^2 + y^2 + z^2 - 4 = 0$. Then $\nabla f = y\mathbf{i} + x\mathbf{j} + 2z\mathbf{k}$, $\nabla g_1 = -\mathbf{i} + \mathbf{j}$, and $\nabla g_2 = 2x\mathbf{i} + 2y\mathbf{j} + 2z\mathbf{k}$ so that $\nabla f = \lambda \nabla g_1 + \mu \nabla g_2 \Rightarrow y\mathbf{i} + x\mathbf{j} + 2z\mathbf{k} = \lambda(-\mathbf{i} + \mathbf{j}) + \mu(2x\mathbf{i} + 2y\mathbf{j} + 2z\mathbf{k})$
 $\Rightarrow y = -\lambda + 2x\mu$, $x = \lambda + 2y\mu$, and $2z = 2z\mu \Rightarrow z = 0$ or $\mu = 1$.
CASE 1: $z = 0 \Rightarrow x^2 + y^2 - 4 = 0 \Rightarrow 2x^2 - 4 = 0$ (since $x = y$) $\Rightarrow x = \pm\sqrt{2}$ and $y = \pm\sqrt{2}$ yielding the points $(\pm\sqrt{2}, \pm\sqrt{2}, 0)$.
CASE 2: $\mu = 1 \Rightarrow y = -\lambda + 2x$ and $x = \lambda + 2y \Rightarrow x + y = 2(x + y) \Rightarrow 2x = 2(2x)$ since $x = y \Rightarrow x = 0 \Rightarrow y = 0$
 $\Rightarrow z^2 - 4 = 0 \Rightarrow z = \pm 2$ yielding the points $(0, 0, \pm 2)$.
Now, $f(0, 0, \pm 2) = 4$ and $f(\pm\sqrt{2}, \pm\sqrt{2}, 0) = 2$. Therefore the maximum value of f is 4 at $(0, 0, \pm 2)$ and the minimum value of f is 2 at $f(\pm\sqrt{2}, \pm\sqrt{2}, 0)$.
44. Let $f(x, y, z) = x^2 + y^2 + z^2$ be the square of the distance from the origin. We want to minimize $f(x, y, z)$ subject to the constraints $g_1(x, y, z) = 2y + 4z - 5 = 0$ and $g_2(x, y, z) = 4x^2 + 4y^2 - z^2 = 0$. Thus $\nabla f = 2x\mathbf{i} + 2y\mathbf{j} + 2z\mathbf{k}$, $\nabla g_1 = 2\mathbf{j} + 4\mathbf{k}$, and $\nabla g_2 = 8x\mathbf{i} + 8y\mathbf{j} - 2z\mathbf{k}$ so that $\nabla f = \lambda \nabla g_1 + \mu \nabla g_2$
 $\Rightarrow 2x\mathbf{i} + 2y\mathbf{j} + 2z\mathbf{k} = \lambda(2\mathbf{j} + 4\mathbf{k}) + \mu(8x\mathbf{i} + 8y\mathbf{j} - 2z\mathbf{k}) \Rightarrow 2x = 8x\mu$, $2y = 2\lambda + 8y\mu$, and $2z = 4\lambda - 2z\mu \Rightarrow x = 0$ or $\mu = \frac{1}{4}$.
CASE 1: $x = 0 \Rightarrow 4(0)^2 + 4y^2 - z^2 = 0 \Rightarrow z = \pm 2y \Rightarrow 2y + 4(2y) - 5 = 0 \Rightarrow y = \frac{1}{2}$, or $2y + 4(-2y) - 5 = 0$

$$\Rightarrow y = -\frac{5}{6} \text{ yielding the points } \left(0, \frac{1}{2}, 1\right) \text{ and } \left(0, -\frac{5}{6}, \frac{5}{3}\right).$$

CASE 2: $\mu = \frac{1}{4} \Rightarrow y = \lambda + y \Rightarrow \lambda = 0 \Rightarrow 2z = 4(0) - 2z\left(\frac{1}{4}\right) \Rightarrow z = 0 \Rightarrow 2y + 4(0) = 5 \Rightarrow y = \frac{5}{2}$ and

$$(0)^2 = 4x^2 + 4\left(\frac{5}{2}\right)^2 \Rightarrow \text{no solution.}$$

Then $f\left(0, \frac{1}{2}, 1\right) = \frac{5}{4}$ and $f\left(0, -\frac{5}{6}, \frac{5}{3}\right) = \frac{25}{36} + \frac{25}{9} = \frac{125}{36} \Rightarrow$ the point $\left(0, \frac{1}{2}, 1\right)$ is closest to the origin.

45. $\nabla f = \mathbf{i} + \mathbf{j}$ and $\nabla g = y\mathbf{i} + x\mathbf{j}$ so that $\nabla f = \lambda \nabla g \Rightarrow \mathbf{i} + \mathbf{j} = \lambda(y\mathbf{i} + x\mathbf{j}) \Rightarrow 1 = y\lambda$ and $1 = x\lambda \Rightarrow y = x \Rightarrow y^2 = 16 \Rightarrow y = \pm 4 \Rightarrow (4, 4)$ and $(-4, -4)$ are candidates for the location of extreme values. But as $x \rightarrow \infty, y \rightarrow \infty$ and $f(x, y) \rightarrow \infty$; as $x \rightarrow -\infty, y \rightarrow 0$ and $f(x, y) \rightarrow -\infty$. Therefore no maximum or minimum value exists subject to the constraint.

46. Let $f(A, B, C) = \sum_{k=1}^4 (Ax_k + By_k + C - z_k)^2 = C^2 + (B + C - 1)^2 + (A + B + C - 1)^2 + (A + C + 1)^2$. We want to minimize f . Then $f_A(A, B, C) = 4A + 2B + 4C, f_B(A, B, C) = 2A + 4B + 4C - 4$, and $f_C(A, B, C) = 4A + 4B + 8C - 2$. Set each partial derivative equal to 0 and solve the system to get $A = -\frac{1}{2}, B = \frac{3}{2}$, and $C = -\frac{1}{4}$ or the critical point of f is $\left(-\frac{1}{2}, \frac{3}{2}, -\frac{1}{4}\right)$.

47. (a) Maximize $f(a, b, c) = a^2b^2c^2$ subject to $a^2 + b^2 + c^2 = r^2$. Thus $\nabla f = 2ab^2c^2\mathbf{i} + 2a^2bc^2\mathbf{j} + 2a^2b^2c\mathbf{k}$ and $\nabla g = 2a\mathbf{i} + 2b\mathbf{j} + 2c\mathbf{k}$ so that $\nabla f = \lambda \nabla g \Rightarrow 2ab^2c^2 = 2a\lambda, 2a^2bc^2 = 2b\lambda$, and $2a^2b^2c = 2c\lambda \Rightarrow 2a^2b^2c^2 = 2a^2\lambda = 2b^2\lambda = 2c^2\lambda \Rightarrow \lambda = 0$ or $a^2 = b^2 = c^2$.

CASE 1: $\lambda = 0 \Rightarrow a^2b^2c^2 = 0$.

CASE 2: $a^2 = b^2 = c^2 \Rightarrow f(a, b, c) = a^2a^2a^2$ and $3a^2 = r^2 \Rightarrow f(a, b, c) = \left(\frac{r^2}{3}\right)^3$ is the maximum value.

- (b) The point $(\sqrt{a}, \sqrt{b}, \sqrt{c})$ is on the sphere if $a + b + c = r^2$. Moreover, by part (a),

$$abc = f(\sqrt{a}, \sqrt{b}, \sqrt{c}) \leq \left(\frac{r^2}{3}\right)^3 \Rightarrow (abc)^{1/3} \leq \frac{r^2}{3} = \frac{a+b+c}{3}, \text{ as claimed.}$$

48. Let $f(x_1, x_2, \dots, x_n) = \sum_{i=1}^n a_i x_i = a_1 x_1 + a_2 x_2 + \dots + a_n x_n$ and $g(x_1, x_2, \dots, x_n) = x_1^2 + x_2^2 + \dots + x_n^2 - 1$. Then we

want $\nabla f = \lambda \nabla g \Rightarrow a_1 = \lambda(2x_1), a_2 = \lambda(2x_2), \dots, a_n = \lambda(2x_n), \lambda \neq 0 \Rightarrow x_i = \frac{a_i}{2\lambda} \Rightarrow \frac{a_1^2}{4\lambda^2} + \frac{a_2^2}{4\lambda^2} + \dots + \frac{a_n^2}{4\lambda^2} = 1$

$$\Rightarrow 4\lambda^2 = \sum_{i=1}^n a_i^2 \Rightarrow 2\lambda = \left(\sum_{i=1}^n a_i^2\right)^{1/2} \Rightarrow f(x_1, x_2, \dots, x_n) = \sum_{i=1}^n a_i x_i = \sum_{i=1}^n a_i \left(\frac{a_i}{2\lambda}\right) = \frac{1}{2\lambda} \sum_{i=1}^n a_i^2 = \left(\sum_{i=1}^n a_i^2\right)^{1/2}$$
 is the maximum value.

49-54. Example CAS commands:

Maple:

```
f := (x,y,z) -> x*y+y*z;
g1 := (x,y,z) -> x^2+y^2-2;
g2 := (x,y,z) -> x^2+z^2-2;
h := unapply( f(x,y,z)-lambda[1]*g1(x,y,z)-lambda[2]*g2(x,y,z), (x,y,z,lambda[1],lambda[2]) ); # (a)
hx := diff( h(x,y,z,lambda[1],lambda[2]), x ); # (b)
hy := diff( h(x,y,z,lambda[1],lambda[2]), y );
hz := diff( h(x,y,z,lambda[1],lambda[2]), z );
h11 := diff( h(x,y,z,lambda[1],lambda[2]), lambda[1] );
h12 := diff( h(x,y,z,lambda[1],lambda[2]), lambda[2] );
sys := { hx=0, hy=0, hz=0, h11=0, h12=0 };
q1 := solve( sys, {x,y,z,lambda[1],lambda[2]} ); # (c)
q2 := map(allvalues, {q1}); # (d)
for p in q2 do
  eval( [x,y,z,f(x,y,z)], p );
  ``=evalf(eval( [x,y,z,f(x,y,z)], p ));
end do;
```

Mathematica: (assigned functions will vary)

```
Clear[x, y, z, lambda1, lambda2]
f[x_, y_, z_] := x y + y z
g1[x_, y_, z_] := x^2 + y^2 - 2
g2[x_, y_, z_] := x^2 + z^2 - 2
h = f[x, y, z] - lambda1 g1[x, y, z] - lambda2 g2[x, y, z];
hx = D[h, x]; hy = D[h, y]; hz = D[h, z]; hL1 = D[h, lambda1]; hL2 = D[h, lambda2];
critical = Solve[ {hx == 0, hy == 0, hz == 0, hL1 == 0, hL2 == 0, g1[x,y,z] == 0, g2[x,y,z] == 0},
{x, y, z, lambda1, lambda2}]/N
{{x, y, z}, f[x, y, z]}/.critical
```

14.9 TAYLOR'S FORMULA FOR TWO VARIABLES

- $f(x, y) = xe^y \Rightarrow f_x = e^y, f_y = xe^y, f_{xx} = 0, f_{xy} = e^y, f_{yy} = xe^y$
 $\Rightarrow f(x, y) \approx f(0, 0) + xf_x(0, 0) + yf_y(0, 0) + \frac{1}{2}[x^2 f_{xx}(0, 0) + 2xy f_{xy}(0, 0) + y^2 f_{yy}(0, 0)]$
 $= 0 + x \cdot 1 + y \cdot 0 + \frac{1}{2}(x^2 \cdot 0 + 2xy \cdot 1 + y^2 \cdot 0) = x + xy$ quadratic approximation;
 $f_{xxx} = 0, f_{xxy} = 0, f_{xyy} = e^y, f_{yyy} = xe^y$
 $\Rightarrow f(x, y) \approx \text{quadratic} + \frac{1}{6}[x^3 f_{xxx}(0, 0) + 3x^2 y f_{xxy}(0, 0) + 3xy^2 f_{xyy}(0, 0) + y^3 f_{yyy}(0, 0)]$
 $= x + xy + \frac{1}{6}(x^3 \cdot 0 + 3x^2 y \cdot 0 + 3xy^2 \cdot 1 + y^3 \cdot 0) = x + xy + \frac{1}{2}xy^2$, cubic approximation
- $f(x, y) = e^x \cos y \Rightarrow f_x = e^x \cos y, f_y = -e^x \sin y, f_{xx} = e^x \cos y, f_{xy} = -e^x \sin y, f_{yy} = -e^x \cos y$
 $\Rightarrow f(x, y) \approx f(0, 0) + xf_x(0, 0) + yf_y(0, 0) + \frac{1}{2}[x^2 f_{xx}(0, 0) + 2xy f_{xy}(0, 0) + y^2 f_{yy}(0, 0)]$
 $= 1 + x \cdot 1 + y \cdot 0 + \frac{1}{2}[x^2 \cdot 1 + 2xy \cdot 0 + y^2 \cdot (-1)] = 1 + x + \frac{1}{2}(x^2 - y^2)$, quadratic approximation;
 $f_{xxx} = e^x \cos y, f_{xxy} = -e^x \sin y, f_{xyy} = -e^x \cos y, f_{yyy} = e^x \sin y$
 $\Rightarrow f(x, y) \approx \text{quadratic} + \frac{1}{6}[x^3 f_{xxx}(0, 0) + 3x^2 y f_{xxy}(0, 0) + 3xy^2 f_{xyy}(0, 0) + y^3 f_{yyy}(0, 0)]$
 $= 1 + x + \frac{1}{2}(x^2 - y^2) + \frac{1}{6}[x^3 \cdot 1 + 3x^2 y \cdot 0 + 3xy^2 \cdot (-1) + y^3 \cdot 0]$
 $= 1 + x + \frac{1}{2}(x^2 - y^2) + \frac{1}{6}(x^3 - 3xy^2)$, cubic approximation
- $f(x, y) = y \sin x \Rightarrow f_x = y \cos x, f_y = \sin x, f_{xx} = -y \sin x, f_{xy} = \cos x, f_{yy} = 0$
 $\Rightarrow f(x, y) \approx f(0, 0) + xf_x(0, 0) + yf_y(0, 0) + \frac{1}{2}[x^2 f_{xx}(0, 0) + 2xy f_{xy}(0, 0) + y^2 f_{yy}(0, 0)]$
 $= 0 + x \cdot 0 + y \cdot 0 + \frac{1}{2}(x^2 \cdot 0 + 2xy \cdot 1 + y^2 \cdot 0) = xy$, quadratic approximation;
 $f_{xxx} = -y \cos x, f_{xxy} = -\sin x, f_{xyy} = 0, f_{yyy} = 0$
 $\Rightarrow f(x, y) \approx \text{quadratic} + \frac{1}{6}[x^3 f_{xxx}(0, 0) + 3x^2 y f_{xxy}(0, 0) + 3xy^2 f_{xyy}(0, 0) + y^3 f_{yyy}(0, 0)]$
 $= xy + \frac{1}{6}[x^3 \cdot 0 + 3x^2 y \cdot 0 + 3xy^2 \cdot 0 + y^3 \cdot 0] = xy$, cubic approximation
- $f(x, y) = \sin x \cos y \Rightarrow f_x = \cos x \cos y, f_y = -\sin x \sin y, f_{xx} = -\sin x \cos y, f_{xy} = -\cos x \sin y,$
 $f_{yy} = -\sin x \cos y \Rightarrow f(x, y) \approx f(0, 0) + xf_x(0, 0) + yf_y(0, 0) + \frac{1}{2}[x^2 f_{xx}(0, 0) + 2xy f_{xy}(0, 0) + y^2 f_{yy}(0, 0)]$
 $= 0 + x \cdot 1 + y \cdot 0 + \frac{1}{2}(x^2 \cdot 0 + 2xy \cdot 0 + y^2 \cdot 0) = x$, quadratic approximation;
 $f_{xxx} = -\cos x \cos y, f_{xxy} = \sin x \sin y, f_{xyy} = -\cos x \cos y, f_{yyy} = \sin x \sin y$
 $\Rightarrow f(x, y) \approx \text{quadratic} + \frac{1}{6}[x^3 f_{xxx}(0, 0) + 3x^2 y f_{xxy}(0, 0) + 3xy^2 f_{xyy}(0, 0) + y^3 f_{yyy}(0, 0)]$
 $= x + \frac{1}{6}[x^3 \cdot (-1) + 3x^2 y \cdot 0 + 3xy^2 \cdot (-1) + y^3 \cdot 0] = x - \frac{1}{6}(x^3 + 3xy^2)$, cubic approximation

5. $f(x, y) = e^x \ln(1+y) \Rightarrow f_x = e^x \ln(1+y), f_y = \frac{e^x}{1+y}, f_{xx} = e^x \ln(1+y), f_{xy} = \frac{e^x}{1+y}, f_{yy} = -\frac{e^x}{(1+y)^2}$
 $\Rightarrow f(x, y) \approx f(0, 0) + xf_x(0, 0) + yf_y(0, 0) + \frac{1}{2} \left[x^2 f_{xx}(0, 0) + 2xy f_{xy}(0, 0) + y^2 f_{yy}(0, 0) \right]$
 $= 0 + x \cdot 0 + y \cdot 1 + \frac{1}{2} \left[x^2 \cdot 0 + 2xy \cdot 1 + y^2 \cdot (-1) \right] = y + \frac{1}{2} (2xy - y^2), \text{ quadratic approximation;}$
 $f_{xxx} = e^x \ln(1+y), f_{xxy} = \frac{e^x}{1+y}, f_{xyy} = -\frac{e^x}{(1+y)^2}, f_{yyy} = \frac{2e^x}{(1+y)^3}$
 $\Rightarrow f(x, y) \approx \text{quadratic} + \frac{1}{6} \left[x^3 f_{xxx}(0, 0) + 3x^2 y f_{xxy}(0, 0) + 3xy^2 f_{xyy}(0, 0) + y^3 f_{yyy}(0, 0) \right]$
 $= y + \frac{1}{2} (2xy - y^2) + \frac{1}{6} \left[x^3 \cdot 0 + 3x^2 y \cdot 1 + 3xy^2 \cdot (-1) + y^3 \cdot 2 \right]$
 $= y + \frac{1}{2} (2xy - y^2) + \frac{1}{6} (3x^2 y - 3xy^2 + 2y^3), \text{ cubic approximation}$
6. $f(x, y) = \ln(2x+y+1) \Rightarrow f_x = \frac{2}{2x+y+1}, f_y = \frac{1}{2x+y+1}, f_{xx} = \frac{-4}{(2x+y+1)^2}, f_{xy} = \frac{-2}{(2x+y+1)^2}, f_{yy} = \frac{-1}{(2x+y+1)^2}$
 $\Rightarrow f(x, y) \approx f(0, 0) + xf_x(0, 0) + yf_y(0, 0) + \frac{1}{2} \left[x^2 f_{xx}(0, 0) + 2xy f_{xy}(0, 0) + y^2 f_{yy}(0, 0) \right]$
 $= 0 + x \cdot 2 + y \cdot 1 + \frac{1}{2} \left[x^2 \cdot (-4) + 2xy \cdot (-2) + y^2 \cdot (-1) \right] = 2x + y + \frac{1}{2} (-4x^2 - 4xy - y^2)$
 $= (2x + y) - \frac{1}{2} (2x + y)^2, \text{ quadratic approximation;}$
 $f_{xxx} = \frac{16}{(2x+y+1)^3}, f_{xxy} = \frac{8}{(2x+y+1)^3}, f_{xyy} = \frac{4}{(2x+y+1)^3}, f_{yyy} = \frac{2}{(2x+y+1)^3}$
 $\Rightarrow f(x, y) \approx \text{quadratic} + \frac{1}{6} \left[x^3 f_{xxx}(0, 0) + 3x^2 y f_{xxy}(0, 0) + 3xy^2 f_{xyy}(0, 0) + y^3 f_{yyy}(0, 0) \right]$
 $= (2x + y) - \frac{1}{2} (2x + y)^2 + \frac{1}{6} (x^3 \cdot 16 + 3x^2 y \cdot 8 + 3xy^2 \cdot 4 + y^3 \cdot 2)$
 $= (2x + y) - \frac{1}{2} (2x + y)^2 - \frac{1}{3} (8x^3 + 12x^2 y + 6xy^2 + y^2)$
 $= (2x + y) - \frac{1}{2} (2x + y)^2 + \frac{1}{3} (2x + y)^3, \text{ cubic approximation}$
7. $f(x, y) = \sin(x^2 + y^2) \Rightarrow f_x = 2x \cos(x^2 + y^2), f_y = 2y \cos(x^2 + y^2),$
 $f_{xx} = 2 \cos(x^2 + y^2) - 4x^2 \sin(x^2 + y^2), f_{xy} = -4xy \sin(x^2 + y^2), f_{yy} = 2 \cos(x^2 + y^2) - 4y^2 \sin(x^2 + y^2)$
 $\Rightarrow f(x, y) \approx f(0, 0) + xf_x(0, 0) + yf_y(0, 0) + \frac{1}{2} \left[x^2 f_{xx}(0, 0) + 2xy f_{xy}(0, 0) + y^2 f_{yy}(0, 0) \right]$
 $= 0 + x \cdot 0 + y \cdot 0 + \frac{1}{2} (x^2 \cdot 2 + 2xy \cdot 0 + y^2 \cdot 2) = x^2 + y^2, \text{ quadratic approximation;}$
 $f_{xxx} = -12x \sin(x^2 + y^2) - 8x^3 \cos(x^2 + y^2), f_{xxy} = -4y \sin(x^2 + y^2) - 8x^2 y \cos(x^2 + y^2),$
 $f_{xyy} = -4x \sin(x^2 + y^2) - 8xy^2 \cos(x^2 + y^2), f_{yyy} = -12y \sin(x^2 + y^2) - 8y^3 \cos(x^2 + y^2)$
 $\Rightarrow f(x, y) \approx \text{quadratic} + \frac{1}{6} \left[x^3 f_{xxx}(0, 0) + 3x^2 y f_{xxy}(0, 0) + 3xy^2 f_{xyy}(0, 0) + y^3 f_{yyy}(0, 0) \right]$
 $= x^2 + y^2 + \frac{1}{6} [x^3 \cdot 0 + 3x^2 y \cdot 0 + 3xy^2 \cdot 0 + y^3 \cdot 0] = x^2 + y^2, \text{ cubic approximation}$

8. $f(x, y) = \cos(x^2 + y^2) \Rightarrow f_x = -2x \sin(x^2 + y^2), f_y = -2y \sin(x^2 + y^2),$
 $f_{xx} = -2 \sin(x^2 + y^2) - 4x^2 \cos(x^2 + y^2), f_{xy} = -4xy \cos(x^2 + y^2), f_{yy} = -2 \sin(x^2 + y^2) - 4y^2 \cos(x^2 + y^2)$
 $\Rightarrow f(x, y) \approx f(0, 0) + x f_x(0, 0) + y f_y(0, 0) + \frac{1}{2} [x^2 f_{xx}(0, 0) + 2xy f_{xy}(0, 0) + y^2 f_{yy}(0, 0)]$
 $= 1 + x \cdot 0 + y \cdot 0 + \frac{1}{2} [x^2 \cdot 0 + 2xy \cdot 0 + y^2 \cdot 0] = 1, \text{ quadratic approximation;}$
 $f_{xxx} = -12x \cos(x^2 + y^2) + 8x^3 \sin(x^2 + y^2), f_{xxy} = -4y \cos(x^2 + y^2) + 8x^2 y \sin(x^2 + y^2),$
 $f_{xyy} = -4x \cos(x^2 + y^2) + 8xy^2 \sin(x^2 + y^2), f_{yyy} = -12y \cos(x^2 + y^2) + 8y^3 \sin(x^2 + y^2)$
 $\Rightarrow f(x, y) \approx \text{quadratic} + \frac{1}{6} [x^3 f_{xxx}(0, 0) + 3x^2 y f_{xxy}(0, 0) + 3xy^2 f_{xyy}(0, 0) + y^3 f_{yyy}(0, 0)]$
 $= 1 + \frac{1}{6} [x^3 \cdot 0 + 3x^2 y \cdot 0 + 3xy^2 \cdot 0 + y^3 \cdot 0] = 1, \text{ cubic approximation}$
9. $f(x, y) = \frac{1}{1-x-y} \Rightarrow f_x = \frac{1}{(1-x-y)^2} = f_y, f_{xx} = \frac{2}{(1-x-y)^3} = f_{xy} = f_{yy}$
 $\Rightarrow f(x, y) \approx f(0, 0) + x f_x(0, 0) + y f_y(0, 0) + \frac{1}{2} [x^2 f_{xx}(0, 0) + 2xy f_{xy}(0, 0) + y^2 f_{yy}(0, 0)]$
 $= 1 + x \cdot 1 + y \cdot 1 + \frac{1}{2} (x^2 \cdot 2 + 2xy \cdot 2 + y^2 \cdot 2) = 1 + (x + y) + (x^2 + 2xy + y^2)$
 $= 1 + (x + y) + (x + y)^2, \text{ quadratic approximation; } f_{xxx} = \frac{6}{(1-x-y)^4} = f_{xxy} = f_{xyy} = f_{yyy}$
 $\Rightarrow f(x, y) \approx \text{quadratic} + \frac{1}{6} [x^3 f_{xxx}(0, 0) + 3x^2 y f_{xxy}(0, 0) + 3xy^2 f_{xyy}(0, 0) + y^3 f_{yyy}(0, 0)]$
 $= 1 + (x + y) + (x + y)^2 + \frac{1}{6} [x^3 \cdot 6 + 3x^2 y \cdot 6 + 3xy^2 \cdot 6 + y^3 \cdot 6]$
 $= 1 + (x + y) + (x + y)^2 + (x^3 + 3x^2 y + 3xy^2 + y^3) = 1 + (x + y) + (x + y)^2 + (x + y)^3, \text{ cubic approximation}$
10. $f(x, y) = \frac{1}{1-x-y+xy} \Rightarrow f_x = \frac{1-y}{(1-x-y+xy)^2}, f_y = \frac{1-x}{(1-x-y+xy)^2}, f_{xx} = \frac{2(1-y)^2}{(1-x-y+xy)^3}, f_{xy} = \frac{1}{(1-x-y+xy)^2},$
 $f_{yy} = \frac{2(1-x)^2}{(1-x-y+xy)^3} \Rightarrow f(x, y) \approx f(0, 0) + x f_x(0, 0) + y f_y(0, 0) + \frac{1}{2} [x^2 f_{xx}(0, 0) + 2xy f_{xy}(0, 0) + y^2 f_{yy}(0, 0)]$
 $= 1 \cdot x \cdot 1 + y \cdot 1 + \frac{1}{2} (x^2 \cdot 2 + 2xy \cdot 1 + y^2 \cdot 2) = 1 + x + y + x^2 + xy + y^2, \text{ quadratic approximation;}$
 $f_{xxx} = \frac{6(1-y)^3}{(1-x-y+xy)^4}, f_{xxy} = \frac{[-4(1-x-y+xy) + 6(1-y)(1-x)](1-y)}{(1-x-y+xy)^4}, f_{xyy} = \frac{[-4(1-x-y+xy) + 6(1-x)(1-y)](1-x)}{(1-x-y+xy)^4},$
 $f_{yyy} = \frac{6(1-x)^3}{(1-x-y+xy)^4} \Rightarrow f(x, y) \approx \text{quadratic} + \frac{1}{6} [x^3 f_{xxx}(0, 0) + 3x^2 y f_{xxy}(0, 0) + 3xy^2 f_{xyy}(0, 0) + y^3 f_{yyy}(0, 0)]$
 $= 1 + x + y + x^2 + xy + y^2 + \frac{1}{6} [x^3 \cdot 6 + 3x^2 y \cdot 2 + 3xy^2 \cdot 2 + y^3 \cdot 6]$
 $= 1 + x + y + x^2 + xy + y^2 + x^3 + x^2 y + xy^2 + y^3, \text{ cubic approximation}$
11. $f(x, y) = \cos x \cos y \Rightarrow f_x = -\sin x \cos y, f_y = -\cos x \sin y, f_{xx} = -\cos x \cos y, f_{xy} = \sin x \sin y,$
 $f_{yy} = -\cos x \cos y \Rightarrow f(x, y) \approx f(0, 0) + x f_x(0, 0) + y f_y(0, 0) + \frac{1}{2} [x^2 f_{xx}(0, 0) + 2xy f_{xy}(0, 0) + y^2 f_{yy}(0, 0)]$
 $= 1 + x \cdot 0 + y \cdot 0 + \frac{1}{2} [x^2 \cdot (-1) + 2xy \cdot 0 + y^2 \cdot (-1)] = 1 - \frac{x^2}{2} - \frac{y^2}{2}, \text{ quadratic approximation. Since all partial}$

derivatives of f are products of sines and cosines, the absolute value of these derivatives is less than or equal to 1 $\Rightarrow E(x, y) \leq \frac{1}{6}[(0.1)^3 + 3(0.1)^3 + 3(0.1)^3 + (0.1)^3] \leq 0.00134$.

12. $f(x, y) = e^x \sin y \Rightarrow f_x = e^x \sin y, f_y = e^x \cos y, f_{xx} = e^x \sin y, f_{xy} = e^x \cos y, f_{yy} = -e^x \sin y$
 $\Rightarrow f(x, y) \approx f(0, 0) + x f_x(0, 0) + y f_y(0, 0) + \frac{1}{2} [x^2 f_{xx}(0, 0) + 2xy f_{xy}(0, 0) + y^2 f_{yy}(0, 0)]$
 $= 0 + x \cdot 0 + y \cdot 1 + \frac{1}{2} (x^2 \cdot 0 + 2xy \cdot 1 + y^2 \cdot 0) = y + xy$, quadratic approximation.

Now, $f_{xxx} = e^x \sin y, f_{xxy} = e^x \cos y, f_{xyy} = -e^x \sin y$, and $f_{yyy} = -e^x \cos y$.

Since $|x| \leq 0.1, |e^x \sin y| \leq e^{0.1} \sin 0.1 \approx 0.11$ and $|e^x \cos y| \leq |e^{0.1} \cos 0.1| \approx 1.11$.

Therefore, $E(x, y) \leq \frac{1}{6} [(0.11)(0.1)^3 + 3(1.11)(0.1)^3 + 3(0.11)(0.1)^3 + (1.11)(0.1)^3] \leq 0.000814$.

14.10 PARTIAL DERIVATIVES WITH CONSTRAINED VARIABLES

1. $w = x^2 + y^2 + z^2$ and $z = x^2 + y^2$:

(a) $\begin{pmatrix} y \\ z \end{pmatrix} \rightarrow \begin{pmatrix} x = x(y, z) \\ y = y \\ z = z \end{pmatrix} \rightarrow w \Rightarrow \left(\frac{\partial w}{\partial y}\right)_z = \frac{\partial w}{\partial x} \frac{\partial x}{\partial y} + \frac{\partial w}{\partial y} \frac{\partial y}{\partial y} + \frac{\partial w}{\partial z} \frac{\partial z}{\partial y}; \frac{\partial x}{\partial y} = 0$ and $\frac{\partial z}{\partial y} = 2x \frac{\partial x}{\partial y} + 2y \frac{\partial y}{\partial y}$
 $= 2x \frac{\partial x}{\partial y} + 2y \Rightarrow 0 = 2x \frac{\partial x}{\partial y} + 2y \Rightarrow \frac{\partial x}{\partial y} = -\frac{y}{x} \Rightarrow \left(\frac{\partial w}{\partial y}\right)_z = (2x) \left(-\frac{y}{x}\right) + (2y)(1) + (2z)(0) = -2y + 2y = 0$

(b) $\begin{pmatrix} x \\ z \end{pmatrix} \rightarrow \begin{pmatrix} x = x \\ y = y(x, z) \\ z = z \end{pmatrix} \rightarrow w \Rightarrow \left(\frac{\partial w}{\partial z}\right)_x = \frac{\partial w}{\partial x} \frac{\partial x}{\partial z} + \frac{\partial w}{\partial y} \frac{\partial y}{\partial z} + \frac{\partial w}{\partial z} \frac{\partial z}{\partial z}; \frac{\partial x}{\partial z} = 0$ and $\frac{\partial z}{\partial z} = 2x \frac{\partial x}{\partial z} + 2y \frac{\partial y}{\partial z}$
 $\Rightarrow 1 = 2y \frac{\partial y}{\partial z} \Rightarrow \frac{\partial y}{\partial z} = \frac{1}{2y} \Rightarrow \left(\frac{\partial w}{\partial z}\right)_x = (2x)(0) + (2y) \left(\frac{1}{2y}\right) + (2z)(1) = 1 + 2z$

(c) $\begin{pmatrix} y \\ z \end{pmatrix} \rightarrow \begin{pmatrix} x = x(y, z) \\ y = y \\ z = z \end{pmatrix} \rightarrow w \Rightarrow \left(\frac{\partial w}{\partial z}\right)_y = \frac{\partial w}{\partial x} \frac{\partial x}{\partial z} + \frac{\partial w}{\partial y} \frac{\partial y}{\partial z} + \frac{\partial w}{\partial z} \frac{\partial z}{\partial z}; \frac{\partial y}{\partial z} = 0$ and $\frac{\partial z}{\partial z} = 2x \frac{\partial x}{\partial z} + 2y \frac{\partial y}{\partial z}$
 $\Rightarrow 1 = 2x \frac{\partial x}{\partial z} \Rightarrow \frac{\partial x}{\partial z} = \frac{1}{2x} \Rightarrow \left(\frac{\partial w}{\partial z}\right)_y = (2x) \left(\frac{1}{2x}\right) + (2y)(0) + (2z)(1) = 1 + 2z$

2. $w = x^2 + y - z + \sin t$ and $x + y = t$:

(a) $\begin{pmatrix} x \\ y \\ z \end{pmatrix} \rightarrow \begin{pmatrix} x = x \\ y = y \\ z = z \\ t = x + y \end{pmatrix} \rightarrow w \Rightarrow \left(\frac{\partial w}{\partial y}\right)_{x,z} = \frac{\partial w}{\partial x} \frac{\partial x}{\partial y} + \frac{\partial w}{\partial y} \frac{\partial y}{\partial y} + \frac{\partial w}{\partial z} \frac{\partial z}{\partial y} + \frac{\partial w}{\partial t} \frac{\partial t}{\partial y}; \frac{\partial x}{\partial y} = 0, \frac{\partial z}{\partial y} = 0,$ and $\frac{\partial t}{\partial y} = 1$
 $\Rightarrow \left(\frac{\partial w}{\partial y}\right)_{x,t} = (2x)(0) + (1)(1) + (-1)(0) + (\cos t)(1) = 1 + \cos t = 1 + \cos(x + y)$

$$(b) \begin{pmatrix} y \\ z \\ t \end{pmatrix} \rightarrow \begin{pmatrix} x = t - y \\ y = y \\ z = z \\ t = t \end{pmatrix} \rightarrow w \Rightarrow \left(\frac{\partial w}{\partial y}\right)_{z,t} = \frac{\partial w}{\partial x} \frac{\partial x}{\partial y} + \frac{\partial w}{\partial y} \frac{\partial y}{\partial y} + \frac{\partial w}{\partial z} \frac{\partial z}{\partial y} + \frac{\partial w}{\partial t} \frac{\partial t}{\partial y}; \quad \frac{\partial z}{\partial y} = 0 \text{ and } \frac{\partial t}{\partial y} = 0$$

$$\Rightarrow \frac{\partial x}{\partial y} = \frac{\partial t}{\partial y} - \frac{\partial y}{\partial y} = -1 \Rightarrow \left(\frac{\partial w}{\partial y}\right)_{z,t} = (2x)(-1) + (1)(1) + (-1)(0) + (\cos t)(0) = 1 - 2(t - y) = 1 + 2y - 2t$$

$$(c) \begin{pmatrix} x \\ y \\ z \end{pmatrix} \rightarrow \begin{pmatrix} x = x \\ y = y \\ z = z \\ t = x + y \end{pmatrix} \rightarrow w \Rightarrow \left(\frac{\partial w}{\partial z}\right)_{x,y} = \frac{\partial w}{\partial x} \frac{\partial x}{\partial z} + \frac{\partial w}{\partial y} \frac{\partial y}{\partial z} + \frac{\partial w}{\partial z} \frac{\partial z}{\partial z} + \frac{\partial w}{\partial t} \frac{\partial t}{\partial z}; \quad \frac{\partial x}{\partial z} = 0 \text{ and } \frac{\partial y}{\partial z} = 0$$

$$\Rightarrow \left(\frac{\partial w}{\partial z}\right)_{x,y} = (2x)(0) + (1)(0) + (-1)(1) + (\cos t)(0) = -1$$

$$(d) \begin{pmatrix} y \\ z \\ t \end{pmatrix} \rightarrow \begin{pmatrix} x = t - y \\ y = y \\ z = z \\ t = t \end{pmatrix} \rightarrow w \Rightarrow \left(\frac{\partial w}{\partial z}\right)_{y,t} = \frac{\partial w}{\partial x} \frac{\partial x}{\partial z} + \frac{\partial w}{\partial y} \frac{\partial y}{\partial z} + \frac{\partial w}{\partial z} \frac{\partial z}{\partial z} + \frac{\partial w}{\partial t} \frac{\partial t}{\partial z}; \quad \frac{\partial y}{\partial z} = 0 \text{ and } \frac{\partial t}{\partial z} = 0$$

$$\Rightarrow \left(\frac{\partial w}{\partial z}\right)_{y,t} = (2x)(0) + (1)(0) + (-1)(1) + (\cos t)(0) = -1$$

$$(e) \begin{pmatrix} x \\ z \\ t \end{pmatrix} \rightarrow \begin{pmatrix} x = x \\ y = t - x \\ z = z \\ t = t \end{pmatrix} \rightarrow w \Rightarrow \left(\frac{\partial w}{\partial t}\right)_{x,z} = \frac{\partial w}{\partial x} \frac{\partial x}{\partial t} + \frac{\partial w}{\partial y} \frac{\partial y}{\partial t} + \frac{\partial w}{\partial z} \frac{\partial z}{\partial t} + \frac{\partial w}{\partial t} \frac{\partial t}{\partial t}; \quad \frac{\partial x}{\partial t} = 0 \text{ and } \frac{\partial z}{\partial t} = 0$$

$$\Rightarrow \left(\frac{\partial w}{\partial t}\right)_{x,z} = (2x)(0) + (1)(1) + (-1)(0) + (\cos t)(1) = 1 + \cos t$$

$$(f) \begin{pmatrix} y \\ z \\ t \end{pmatrix} \rightarrow \begin{pmatrix} x = t - y \\ y = y \\ z = z \\ t = t \end{pmatrix} \rightarrow w \Rightarrow \left(\frac{\partial w}{\partial t}\right)_{y,z} = \frac{\partial w}{\partial x} \frac{\partial x}{\partial t} + \frac{\partial w}{\partial y} \frac{\partial y}{\partial t} + \frac{\partial w}{\partial z} \frac{\partial z}{\partial t} + \frac{\partial w}{\partial t} \frac{\partial t}{\partial t}; \quad \frac{\partial y}{\partial t} = 0 \text{ and } \frac{\partial z}{\partial t} = 0$$

$$\Rightarrow \left(\frac{\partial w}{\partial t}\right)_{y,z} = (2x)(1) + (1)(0) + (-1)(0) + (\cos t)(1) = \cos t + 2x = \cos t + 2(t - y)$$

3. $U = f(P, V, T)$ and $PV = nRT$

$$(a) \begin{pmatrix} P \\ V \end{pmatrix} \rightarrow \begin{pmatrix} P = P \\ V = V \\ T = \frac{PV}{nR} \end{pmatrix} \rightarrow U \Rightarrow \left(\frac{\partial U}{\partial P}\right)_V = \frac{\partial U}{\partial P} \frac{\partial P}{\partial P} + \frac{\partial U}{\partial V} \frac{\partial V}{\partial P} + \frac{\partial U}{\partial T} \frac{\partial T}{\partial P} = \frac{\partial U}{\partial P} + \left(\frac{\partial U}{\partial V}\right)(0) + \left(\frac{\partial U}{\partial T}\right)\left(\frac{V}{nR}\right) = \frac{\partial U}{\partial P} + \left(\frac{\partial U}{\partial T}\right)\left(\frac{V}{nR}\right)$$

$$(b) \begin{pmatrix} V \\ T \end{pmatrix} \rightarrow \begin{pmatrix} P = \frac{nRT}{V} \\ V = V \\ T = T \end{pmatrix} \rightarrow U \Rightarrow \left(\frac{\partial U}{\partial T}\right)_V = \frac{\partial U}{\partial P} \frac{\partial P}{\partial T} + \frac{\partial U}{\partial V} \frac{\partial V}{\partial T} + \frac{\partial U}{\partial T} \frac{\partial T}{\partial T} = \left(\frac{\partial U}{\partial P}\right)\left(\frac{nR}{V}\right) + \left(\frac{\partial U}{\partial V}\right)(0) + \frac{\partial U}{\partial T}$$

$$= \left(\frac{\partial U}{\partial P}\right)\left(\frac{nR}{V}\right) + \frac{\partial U}{\partial T}$$

4. $w = x^2 + y^2 + z^2$ and $y \sin z + z \sin x = 0$

(a) $\begin{pmatrix} x \\ y \end{pmatrix} \rightarrow \begin{pmatrix} x = x \\ y = y \\ z = z(x, y) \end{pmatrix} \rightarrow w \Rightarrow \left(\frac{\partial w}{\partial x}\right)_y = \frac{\partial w}{\partial x} \frac{\partial x}{\partial x} + \frac{\partial w}{\partial y} \frac{\partial y}{\partial x} + \frac{\partial w}{\partial z} \frac{\partial z}{\partial x}; \frac{\partial y}{\partial x} = 0$ and

$(y \cos z) \frac{\partial z}{\partial x} + (\sin x) \frac{\partial z}{\partial x} + z \cos x = 0 \Rightarrow \frac{\partial z}{\partial x} = \frac{-z \cos x}{y \cos z + \sin x}$. At $(0, 1, \pi)$, $\frac{\partial z}{\partial x} = \frac{-\pi}{-1} = \pi$

$\Rightarrow \left(\frac{\partial w}{\partial x}\right)_y \Big|_{(0,1,\pi)} = (2x)(1) + (2y)(0) + (2z)(\pi) \Big|_{(0,1,\pi)} = 2\pi^2$

(b) $\begin{pmatrix} y \\ z \end{pmatrix} \rightarrow \begin{pmatrix} x = x(y, z) \\ y = y \\ z = z \end{pmatrix} \rightarrow w \Rightarrow \left(\frac{\partial w}{\partial z}\right)_y = \frac{\partial w}{\partial x} \frac{\partial x}{\partial z} + \frac{\partial w}{\partial y} \frac{\partial y}{\partial z} + \frac{\partial w}{\partial z} \frac{\partial z}{\partial z} = (2x) \frac{\partial x}{\partial z} + (2y)(0) + (2z)(1) = (2x) \frac{\partial x}{\partial z} + 2z$.

Now $(\sin z) \frac{\partial y}{\partial z} + y \cos z + \sin x + (z \cos x) \frac{\partial x}{\partial z} = 0$ and $\frac{\partial y}{\partial z} = 0 \Rightarrow y \cos z + \sin x + (z \cos x) \frac{\partial x}{\partial z} = 0$

$\Rightarrow \frac{\partial x}{\partial z} = \frac{-y \cos z - \sin x}{z \cos x}$. At $(0, 1, \pi)$, $\frac{\partial x}{\partial z} = \frac{1-0}{(\pi)(1)} = \frac{1}{\pi} \Rightarrow \left(\frac{\partial w}{\partial z}\right)_y \Big|_{(0,1,\pi)} = 2(0)\left(\frac{1}{\pi}\right) + 2\pi = 2\pi$

5. $w = x^2 y^2 + yz - z^3$ and $x^2 + y^2 + z^2 = 6$

(a) $\begin{pmatrix} x \\ y \end{pmatrix} \rightarrow \begin{pmatrix} x = x \\ y = y \\ z = z(x, y) \end{pmatrix} \rightarrow w \Rightarrow \left(\frac{\partial w}{\partial y}\right)_x = \frac{\partial w}{\partial x} \frac{\partial x}{\partial y} + \frac{\partial w}{\partial y} \frac{\partial y}{\partial y} + \frac{\partial w}{\partial z} \frac{\partial z}{\partial y} = (2xy^2)(0) + (2x^2 y + z)(1) + (y - 3z^2) \frac{\partial z}{\partial y}$

$= 2x^2 y + z + (y - 3z^2) \frac{\partial z}{\partial y}$. Now $(2x) \frac{\partial x}{\partial y} + 2y(2z) \frac{\partial z}{\partial y} = 0$ and $\frac{\partial x}{\partial y} = 0 \Rightarrow 2y + (2z) \frac{\partial z}{\partial y} = 0 \Rightarrow \frac{\partial z}{\partial y} = -\frac{y}{z}$.

At $(w, x, y, z) = (4, 2, 1, -1)$, $\frac{\partial z}{\partial y} = -\frac{1}{-1} = 1 \Rightarrow \left(\frac{\partial w}{\partial y}\right)_x \Big|_{(4,2,1,-1)} = [(2)(2)^2(1) + (-1)] + [1 - 3(-1)^2](1) = 5$

(b) $\begin{pmatrix} y \\ z \end{pmatrix} \rightarrow \begin{pmatrix} x = x(y, z) \\ y = y \\ z = z \end{pmatrix} \rightarrow w \Rightarrow \left(\frac{\partial w}{\partial y}\right)_z = \frac{\partial w}{\partial x} \frac{\partial x}{\partial y} + \frac{\partial w}{\partial y} \frac{\partial y}{\partial y} + \frac{\partial w}{\partial z} \frac{\partial z}{\partial y} = (2xy^2) \frac{\partial x}{\partial y} + (2x^2 y + z)(1) + (y - 3z^2)(0)$

$= (2x^2 y) \frac{\partial x}{\partial y} + 2x^2 y + z$. Now $(2x) \frac{\partial x}{\partial y} + 2y + (2z) \frac{\partial z}{\partial y} = 0$ and $\frac{\partial z}{\partial y} = 0 \Rightarrow (2x) \frac{\partial x}{\partial y} + 2y = 0 \Rightarrow \frac{\partial x}{\partial y} = -\frac{y}{x}$.

At $(w, x, y, z) = (4, 2, 1, -1)$, $\frac{\partial x}{\partial y} = -\frac{1}{2} \Rightarrow \left(\frac{\partial w}{\partial y}\right)_z \Big|_{(4,2,1,-1)} = (2)(2)(1)^2 \left(-\frac{1}{2}\right) + (2)(2)^2(1) + (-1) = 5$

6. $y = uv \Rightarrow 1 = v \frac{\partial u}{\partial y} + u \frac{\partial v}{\partial y}$; $x = u^2 + v^2 \Rightarrow \frac{\partial x}{\partial y} = 0 \Rightarrow 0 = 2u \frac{\partial u}{\partial y} + 2v \frac{\partial v}{\partial y} \Rightarrow \frac{\partial v}{\partial y} = \left(-\frac{u}{v}\right) \frac{\partial u}{\partial y}$

$\Rightarrow 1 = v \frac{\partial u}{\partial y} + u \left(-\frac{u}{v} \frac{\partial u}{\partial y}\right) = \left(\frac{v^2 - u^2}{v}\right) \frac{\partial u}{\partial y} \Rightarrow \frac{\partial u}{\partial y} = \frac{v}{v^2 - u^2}$. At $(u, v) = (\sqrt{2}, 1)$, $\frac{\partial u}{\partial y} = \frac{1}{1^2 - (\sqrt{2})^2} = -1 \Rightarrow \left(\frac{\partial u}{\partial y}\right)_x = -1$

7. $\begin{pmatrix} r \\ \theta \end{pmatrix} \rightarrow \begin{pmatrix} x = r \cos \theta \\ y = r \sin \theta \end{pmatrix} \Rightarrow \left(\frac{\partial x}{\partial r}\right)_\theta = \cos \theta$; $x^2 + y^2 = r^2 \Rightarrow 2x + 2y \frac{\partial y}{\partial x} = 2r \frac{\partial r}{\partial x}$ and $\frac{\partial y}{\partial x} = 0 \Rightarrow 2x = 2r \frac{\partial r}{\partial x} \Rightarrow \frac{\partial r}{\partial x} = \frac{x}{r}$

$\Rightarrow \left(\frac{\partial r}{\partial x}\right)_y = \frac{x}{\sqrt{x^2 + y^2}}$

8. If $x, y,$ and z are independent, then $\left(\frac{\partial w}{\partial x}\right)_{y,z} = \frac{\partial w}{\partial x} \frac{\partial x}{\partial x} + \frac{\partial w}{\partial y} \frac{\partial y}{\partial x} + \frac{\partial w}{\partial z} \frac{\partial z}{\partial x} + \frac{\partial w}{\partial t} \frac{\partial t}{\partial x}$

$= (2x)(1) + (-2y)(0) + (4)(0) + (1)\left(\frac{\partial t}{\partial x}\right) = 2x + \frac{\partial t}{\partial x}$. Thus $x + 2z + t + 25 \Rightarrow 1 + 0 + \frac{\partial t}{\partial x} = 0 \Rightarrow \frac{\partial t}{\partial x} = -1$

$\Rightarrow \left(\frac{\partial w}{\partial x}\right)_{y,z} = 2x - 1$. On the other hand, if $x, y,$ and t are independent, then

$$\left(\frac{\partial w}{\partial x}\right)_{y,t} = \frac{\partial w}{\partial x} \frac{\partial x}{\partial x} + \frac{\partial w}{\partial y} \frac{\partial y}{\partial x} + \frac{\partial w}{\partial z} \frac{\partial z}{\partial x} + \frac{\partial w}{\partial t} \frac{\partial t}{\partial x} = (2x)(1) + (-2y)(0) + 4 \frac{\partial z}{\partial x} + (1)(0) = 2x + 4 \frac{\partial z}{\partial x}.$$

Thus, $x + 2z + t = 25 \Rightarrow 1 + 2 \frac{\partial z}{\partial x} + 0 = 0 \Rightarrow \frac{\partial z}{\partial x} = -\frac{1}{2} \Rightarrow \left(\frac{\partial w}{\partial x}\right)_{y,t} = 2x + 4\left(-\frac{1}{2}\right) = 2x - 2$.

9. If x is a differentiable function of y and z , then $f(x, y, z) = 0 \Rightarrow \frac{\partial f}{\partial x} \frac{\partial x}{\partial x} + \frac{\partial f}{\partial y} \frac{\partial y}{\partial x} + \frac{\partial f}{\partial z} \frac{\partial z}{\partial x} = 0 \Rightarrow \frac{\partial f}{\partial x} + \frac{\partial f}{\partial y} \frac{\partial y}{\partial x} = 0$

$\Rightarrow \left(\frac{\partial x}{\partial y}\right)_z = -\frac{\partial f / \partial y}{\partial f / \partial x}$. Similarly, if y is a differentiable function of x and z , $\left(\frac{\partial y}{\partial z}\right)_x = -\frac{\partial f / \partial z}{\partial f / \partial x}$ and if z is a

differentiable function of x and y , $\left(\frac{\partial z}{\partial x}\right)_y = -\frac{\partial f / \partial x}{\partial f / \partial y}$. Then $\left(\frac{\partial x}{\partial y}\right)_z \left(\frac{\partial y}{\partial z}\right)_x \left(\frac{\partial z}{\partial x}\right)_y = \left(-\frac{\partial f / \partial y}{\partial f / \partial x}\right) \left(-\frac{\partial f / \partial z}{\partial f / \partial x}\right) \left(-\frac{\partial f / \partial x}{\partial f / \partial y}\right) = -1$

10. $z = z + f(u)$ and $u = xu \Rightarrow \frac{\partial z}{\partial x} = 1 + \frac{df}{du} \frac{\partial u}{\partial x} = 1 + y \frac{df}{du}$; also $\frac{\partial z}{\partial y} = 0 + \frac{df}{du} \frac{\partial u}{\partial y} = x \frac{df}{du}$ so that

$$x \frac{\partial z}{\partial x} - y \frac{\partial z}{\partial y} = x \left(1 + y \frac{df}{du}\right) - y \left(x \frac{df}{du}\right) = x$$

11. If x and y are independent, then $g(x, y, z) = 0 \Rightarrow \frac{\partial g}{\partial x} \frac{\partial x}{\partial y} + \frac{\partial g}{\partial y} \frac{\partial y}{\partial y} + \frac{\partial g}{\partial z} \frac{\partial z}{\partial y} = 0$ and $\frac{\partial x}{\partial y} = 0 \Rightarrow \frac{\partial g}{\partial y} + \frac{\partial g}{\partial z} \frac{\partial z}{\partial y} = 0$

$\Rightarrow \left(\frac{\partial z}{\partial y}\right)_x = -\frac{\partial g / \partial y}{\partial g / \partial z}$, as claimed.

12. Let x and y be independent, Then $f(x, y, z, w) = 0, g(x, y, z, w) = 0$ and $\frac{\partial y}{\partial x} = 0$

$$\Rightarrow \frac{\partial f}{\partial x} \frac{\partial x}{\partial x} + \frac{\partial f}{\partial y} \frac{\partial y}{\partial x} + \frac{\partial f}{\partial z} \frac{\partial z}{\partial x} + \frac{\partial f}{\partial w} \frac{\partial w}{\partial x} = \frac{\partial f}{\partial x} + \frac{\partial f}{\partial z} \frac{\partial z}{\partial x} + \frac{\partial f}{\partial w} \frac{\partial w}{\partial x} = 0 \text{ and}$$

$$\frac{\partial g}{\partial x} \frac{\partial x}{\partial x} + \frac{\partial g}{\partial y} \frac{\partial y}{\partial x} + \frac{\partial g}{\partial z} \frac{\partial z}{\partial x} + \frac{\partial g}{\partial w} \frac{\partial w}{\partial x} = \frac{\partial g}{\partial x} + \frac{\partial g}{\partial z} \frac{\partial z}{\partial x} + \frac{\partial g}{\partial w} \frac{\partial w}{\partial x} = 0$$

$$\text{imply } \begin{cases} \frac{\partial f}{\partial z} \frac{\partial z}{\partial x} + \frac{\partial f}{\partial w} \frac{\partial w}{\partial x} = -\frac{\partial f}{\partial x} \\ \frac{\partial g}{\partial z} \frac{\partial z}{\partial x} + \frac{\partial g}{\partial w} \frac{\partial w}{\partial x} = -\frac{\partial g}{\partial x} \end{cases} \Rightarrow \left(\frac{\partial z}{\partial x}\right)_y = \frac{\begin{vmatrix} \frac{\partial f}{\partial x} & \frac{\partial f}{\partial w} \\ \frac{\partial g}{\partial x} & \frac{\partial g}{\partial w} \end{vmatrix}}{\begin{vmatrix} \frac{\partial f}{\partial z} & \frac{\partial f}{\partial w} \\ \frac{\partial g}{\partial z} & \frac{\partial g}{\partial w} \end{vmatrix}} = \frac{\frac{\partial f}{\partial x} \frac{\partial g}{\partial w} - \frac{\partial g}{\partial x} \frac{\partial f}{\partial w}}{\frac{\partial f}{\partial z} \frac{\partial g}{\partial w} - \frac{\partial g}{\partial z} \frac{\partial f}{\partial w}} = -\frac{\frac{\partial f}{\partial x} \frac{\partial g}{\partial w} - \frac{\partial g}{\partial x} \frac{\partial f}{\partial w}}{\frac{\partial f}{\partial z} \frac{\partial g}{\partial w} - \frac{\partial g}{\partial z} \frac{\partial f}{\partial w}}, \text{ as claimed.}$$

Likewise, $f(x, y, z, w) = 0, g(x, y, z, w) = 0$, and

$$\frac{\partial x}{\partial y} = 0 \Rightarrow \frac{\partial f}{\partial x} \frac{\partial x}{\partial y} + \frac{\partial f}{\partial y} \frac{\partial y}{\partial y} + \frac{\partial f}{\partial z} \frac{\partial z}{\partial y} + \frac{\partial f}{\partial w} \frac{\partial w}{\partial y} = \frac{\partial f}{\partial y} + \frac{\partial f}{\partial z} \frac{\partial z}{\partial y} + \frac{\partial f}{\partial w} \frac{\partial w}{\partial y} = 0 \text{ and (similarly) } \frac{\partial g}{\partial y} + \frac{\partial g}{\partial z} \frac{\partial z}{\partial y} + \frac{\partial g}{\partial w} \frac{\partial w}{\partial y} = 0$$

$$\text{imply } \begin{cases} \frac{\partial f}{\partial z} \frac{\partial z}{\partial y} + \frac{\partial f}{\partial w} \frac{\partial w}{\partial y} = -\frac{\partial f}{\partial y} \\ \frac{\partial g}{\partial z} \frac{\partial z}{\partial y} + \frac{\partial g}{\partial w} \frac{\partial w}{\partial y} = -\frac{\partial g}{\partial y} \end{cases} \Rightarrow \left(\frac{\partial w}{\partial y}\right)_x = \frac{\begin{vmatrix} \frac{\partial f}{\partial z} & -\frac{\partial f}{\partial y} \\ \frac{\partial g}{\partial z} & -\frac{\partial g}{\partial y} \end{vmatrix}}{\begin{vmatrix} \frac{\partial f}{\partial z} & \frac{\partial f}{\partial w} \\ \frac{\partial g}{\partial z} & \frac{\partial g}{\partial w} \end{vmatrix}} = \frac{-\frac{\partial f}{\partial z} \frac{\partial g}{\partial y} + \frac{\partial g}{\partial z} \frac{\partial f}{\partial y}}{\frac{\partial f}{\partial z} \frac{\partial g}{\partial w} - \frac{\partial g}{\partial z} \frac{\partial f}{\partial w}} = -\frac{\frac{\partial f}{\partial z} \frac{\partial g}{\partial y} + \frac{\partial g}{\partial z} \frac{\partial f}{\partial y}}{\frac{\partial f}{\partial z} \frac{\partial g}{\partial w} - \frac{\partial g}{\partial z} \frac{\partial f}{\partial w}}, \text{ as claimed.}$$

CHAPTER 14 PRACTICE EXERCISES

1. Domain: All points in the xy -plane
 Range: $z \geq 0$

Level curves are ellipses with major axis along the y -axis, and minor axis along the x -axis.

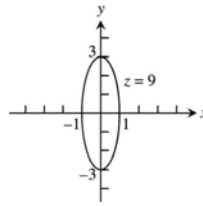

2. Domain: All point in the xy -plane
 Range: $0 < z < \infty$

Level curves are the straight lines $x + y = \ln z$ with slope -1 , and $z > 0$.

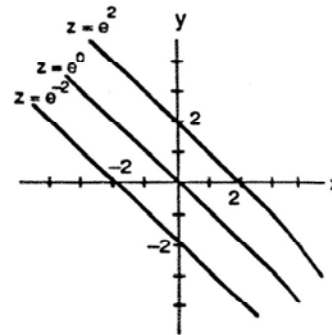

3. Domain: All (x, y) so that $x \neq 0$ and $y \neq 0$
 Range: $z \neq 0$

Level curves are hyperbolas with the x - and y -axes as asymptotes.

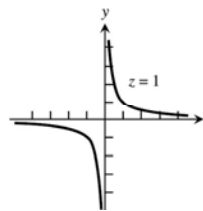

4. Domain: All (x, y) so that $x^2 - y \geq 0$
 Range: $z \geq 0$

Level curves are the parabolas $y = x^2 - c, c \geq 0$.

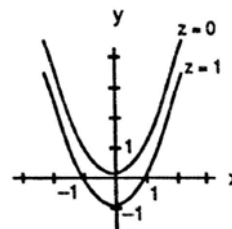

5. Domain: All points (x, y, z) in space
 Range: All real numbers

Level surfaces are paraboloids of revolution with the z -axis as axis.

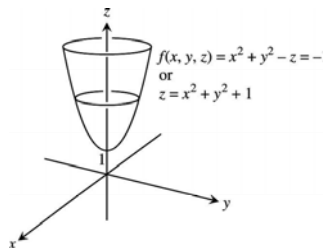

6. Domain: All points (x, y, z) in space
 Range: Nonnegative real numbers

Level surfaces are ellipsoids with center $(0, 0, 0)$.

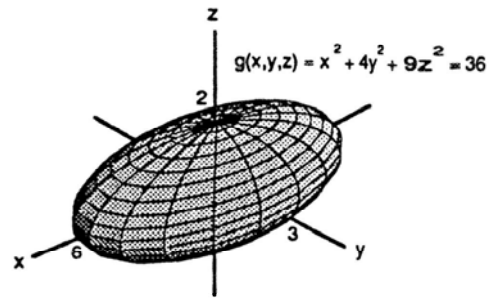

7. Domain: All (x, y, z) such that $(x, y, z) \neq (0, 0, 0)$
 Range: Positive real numbers

Level surfaces are spheres with center $(0, 0, 0)$ and radius $r > 0$.

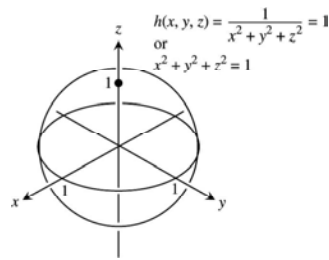

8. Domain: All points (x, y, z) in space
 Range: $(0, 1]$

Level surfaces are spheres with center $(0, 0, 0)$ and radius $r > 0$.

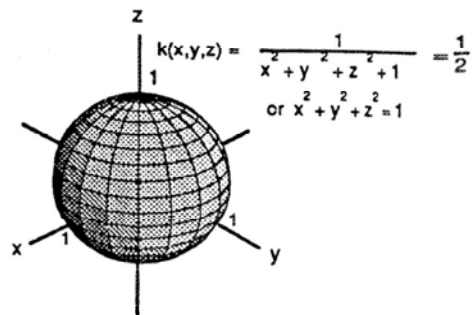

9. $\lim_{(x,y) \rightarrow (\pi, \ln 2)} e^y \cos x = e^{\ln 2} \cos \pi = (2)(-1) = -2$
10. $\lim_{(x,y) \rightarrow (0,0)} \frac{2+y}{x+\cos y} = \frac{2+0}{0+\cos 0} = 2$
11. $\lim_{\substack{(x,y) \rightarrow (1,1) \\ x \neq y}} \frac{x-y}{x^2-y^2} = \lim_{\substack{(x,y) \rightarrow (1,1) \\ x \neq y}} \frac{x-y}{(x-y)(x+y)} = \lim_{(x,y) \rightarrow (1,1)} \frac{1}{x+y} = \frac{1}{1+1} = \frac{1}{2}$
12. $\lim_{(x,y) \rightarrow (1,1)} \frac{x^3 y^3 - 1}{xy - y} = \lim_{(x,y) \rightarrow (1,1)} \frac{(xy-1)(x^2 y^2 + xy + 1)}{xy-1} = \lim_{(x,y) \rightarrow (1,1)} (x^2 y^2 + xy + 1) = 1^2 \cdot 1^2 + 1 \cdot 1 + 1 = 3$
13. $\lim_{P \rightarrow (1, -1, e)} \ln |x + y + z| = \ln |1 + (-1) + e| = \ln e = 1$
14. $\lim_{P \rightarrow (1, -1, -1)} \tan^{-1}(x + y + z) = \tan^{-1}(1 + (-1) + (-1)) = \tan^{-1}(-1) = -\frac{\pi}{4}$

15. Let $y = kx^2, k \neq 1$. Then $\lim_{\substack{(x,y) \rightarrow (0,0) \\ y \neq x^2}} \frac{y}{x^2 - y} = \lim_{(x, kx^2) \rightarrow (0,0)} \frac{kx^2}{x^2 - kx^2} = \frac{k}{1-k^2}$ which gives different limits for different values of $k \Rightarrow$ the limit does not exist.

16. Let $y = kx, k \neq 0$. Then $\lim_{\substack{(x,y) \rightarrow (0,0) \\ xy \neq 0}} \frac{x^2 + y^2}{xy} = \lim_{(x, kx) \rightarrow (0,0)} \frac{x^2 + (kx)^2}{x(kx)} = \frac{1+k^2}{k}$ which gives different limits for different values of $k \Rightarrow$ the limit does not exist.

17. Let $y = kx$. Then $\lim_{(x,y) \rightarrow (0,0)} \frac{x^2 - y^2}{x^2 + y^2} = \frac{x^2 - k^2x^2}{x^2 + k^2x^2} = \frac{1-k^2}{1+k^2}$ which gives different limits for different values of $k \Rightarrow$ the limit does not exist so $f(0, 0)$ cannot be defined in a way that makes f continuous at the origin.

18. Along the x -axis, $y = 0$ and $\lim_{(x,y) \rightarrow (0,0)} \frac{\sin(x-y)}{|x|+|y|} = \lim_{x \rightarrow 0} \frac{\sin x}{|x|} = \begin{cases} 1, & x > 0 \\ -1, & x < 0 \end{cases}$, so the limit fails to exist $\Rightarrow f$ is not continuous at $(0, 0)$.

19. $\frac{\partial g}{\partial r} = \cos \theta + \sin \theta, \frac{\partial g}{\partial \theta} = -r \sin \theta + r \cos \theta$

20. $\frac{\partial f}{\partial x} = \frac{1}{2} \left(\frac{2x}{x^2 + y^2} \right) + \frac{\left(\frac{-y}{x^2} \right)}{1 + \left(\frac{y}{x} \right)^2} = \frac{x}{x^2 + y^2} - \frac{y}{x^2 + y^2} = \frac{x-y}{x^2 + y^2}, \frac{\partial f}{\partial y} = \frac{1}{2} \left(\frac{2y}{x^2 + y^2} \right) + \frac{\left(\frac{1}{x} \right)}{1 + \left(\frac{y}{x} \right)^2} = \frac{y}{x^2 + y^2} + \frac{x}{x^2 + y^2} = \frac{x+y}{x^2 + y^2}$

21. $\frac{\partial f}{\partial R_1} = -\frac{1}{R_1^2}, \frac{\partial f}{\partial R_2} = -\frac{1}{R_2^2}, \frac{\partial f}{\partial R_3} = -\frac{1}{R_3^2}$

22. $h_x(x, y, z) = 2\pi \cos(2\pi x + y - 3z), h_y(x, y, z) = \cos(2\pi x + y - 3z), h_z(x, y, z) = -3 \cos(2\pi x + y - 3z)$

23. $\frac{\partial P}{\partial n} = \frac{RT}{V}, \frac{\partial P}{\partial R} = \frac{nT}{V}, \frac{\partial P}{\partial T} = \frac{nR}{V}, \frac{\partial P}{\partial V} = -\frac{nRT}{V^2}$

24. $f_r(r, \ell, T, w) = -\frac{1}{2r^2 \ell} \sqrt{\frac{T}{\pi w}}, f_\ell(r, \ell, T, w) = -\frac{1}{2r \ell^2} \sqrt{\frac{T}{\pi w}}, f_T(r, \ell, T, w) = \left(\frac{1}{2r \ell} \right) \left(\frac{1}{\sqrt{\pi w}} \right) \left(\frac{1}{2\sqrt{T}} \right) = \frac{1}{4r \ell} \sqrt{\frac{1}{T \pi w}}$
 $= \frac{1}{4r \ell T} \sqrt{\frac{T}{\pi w}}, f_w(r, \ell, T, w) = \left(\frac{1}{2r \ell} \right) \sqrt{\frac{T}{\pi}} \left(-\frac{1}{2} w^{-3/2} \right) = -\frac{1}{4r \ell w} \sqrt{\frac{T}{\pi w}}$

25. $\frac{\partial g}{\partial x} = \frac{1}{y}, \frac{\partial g}{\partial y} = 1 - \frac{x}{y^2} \Rightarrow \frac{\partial^2 g}{\partial x^2} = 0, \frac{\partial^2 g}{\partial y^2} = \frac{2x}{y^3}, \frac{\partial^2 g}{\partial y \partial x} = \frac{\partial^2 g}{\partial x \partial y} = -\frac{1}{y^2}$

26. $g_x(x, y) = e^x + y \cos x, g_y(x, y) = \sin x \Rightarrow g_{xx}(x, y) = e^x - y \sin x, g_{yy}(x, y) = 0,$
 $g_{xy}(x, y) = g_{yx}(x, y) = \cos x$

27. $\frac{\partial f}{\partial x} = 1 + y - 15x^2 + \frac{2x}{x^2 + 1}, \frac{\partial f}{\partial y} = x \Rightarrow \frac{\partial^2 f}{\partial x^2} = -30x + \frac{2-2x^2}{(x^2 + 1)^2}, \frac{\partial^2 f}{\partial y^2} = 0, \frac{\partial^2 f}{\partial y \partial x} = \frac{\partial^2 f}{\partial x \partial y} = 1$

28. $f_x(x, y) = -3y, f_y(x, y) = 2y - 3x - \sin y + 7e^y \Rightarrow f_{xx}(x, y) = 0, f_{yy}(x, y) = 2 - \cos y + 7e^y,$
 $f_{xy}(x, y) = f_{yx}(x, y) = -3$

29. $\frac{\partial w}{\partial x} = y \cos(xy + \pi), \frac{\partial w}{\partial y} = x \cos(xy + \pi), \frac{dx}{dt} = e^t, \frac{dy}{dt} = \frac{1}{t+1} \Rightarrow \frac{dw}{dt} = [y \cos(xy + \pi)]e^t + [x \cos(xy + \pi)]\left(\frac{1}{t+1}\right);$
 $t = 0 \Rightarrow x = 1 \text{ and } y = 0 \Rightarrow \left.\frac{dw}{dt}\right|_{t=0} = 0 \cdot 1 + [1 \cdot (-1)]\left(\frac{1}{0+1}\right) = -1$

30. $\frac{\partial w}{\partial x} = e^y, \frac{\partial w}{\partial y} = xe^y + \sin z, \frac{\partial w}{\partial z} = y \cos z + \sin z, \frac{dx}{dt} = t^{-1/2}, \frac{dy}{dt} = 1 + \frac{1}{t}, \frac{dz}{dt} = \pi$
 $\Rightarrow \frac{dw}{dt} = e^y t^{-1/2} + \left(xe^y + \sin z\right)\left(1 + \frac{1}{t}\right) + (y \cos z + \sin z)\pi;$
 $t = 1 \Rightarrow x = 2, y = 0, \text{ and } z = \pi \Rightarrow \left.\frac{dw}{dt}\right|_{t=1} = 1 \cdot 1 + (2 \cdot 1 - 0)(2) + (0 + 0)\pi = 5$

31. $\frac{\partial w}{\partial x} = 2 \cos(2x - y), \frac{\partial w}{\partial y} = -\cos(2x - y), \frac{\partial x}{\partial r} = 1, \frac{\partial x}{\partial s} = \cos s, \frac{\partial y}{\partial r} = s, \frac{\partial y}{\partial s} = r$
 $\Rightarrow \frac{\partial w}{\partial r} = [2 \cos(2x - y)](1) + [-\cos(2x - y)](s);$
 $r = \pi \text{ and } s = 0 \Rightarrow x = \pi \text{ and } y = 0 \Rightarrow \left.\frac{\partial w}{\partial r}\right|_{(\pi, 0)} = (2 \cos 2\pi) - (\cos 2\pi)(0) = 2;$
 $\frac{\partial w}{\partial s} = [2 \cos(2x - y)](\cos s) + [-\cos(2x - y)](r) \Rightarrow \left.\frac{\partial w}{\partial s}\right|_{(\pi, 0)} = (2 \cos 2\pi)(\cos 0) - (\cos 2\pi)(\pi) = 2 - \pi$

32. $\frac{\partial w}{\partial u} = \frac{\partial w}{\partial x} \frac{\partial x}{\partial u} = \left(\frac{x}{1+x^2} - \frac{1}{x^2+1}\right)(2e^u \cos v); u = v = 0 \Rightarrow x = 2 \Rightarrow \left.\frac{\partial w}{\partial u}\right|_{(0,0)} = \left(\frac{2}{5} - \frac{1}{5}\right)(2) = \frac{2}{5};$
 $\Rightarrow \left.\frac{\partial w}{\partial v}\right|_{(0,0)} = \left(\frac{2}{5} - \frac{1}{5}\right)(0) = 0$

33. $\frac{\partial f}{\partial x} = y + z, \frac{\partial f}{\partial y} = x + z, \frac{\partial f}{\partial z} = y + x, \frac{dx}{dt} = -\sin t, \frac{dy}{dt} = \cos t, \frac{dz}{dt} = -2 \sin 2t$
 $\Rightarrow \frac{df}{dt} = -(y + z)(\sin t) + (x + z)(\cos t) - 2(y + x)(\sin 2t); t = 1 \Rightarrow x = \cos 1, y = \sin 1, \text{ and } z = \cos 2$
 $\Rightarrow \left.\frac{df}{dt}\right|_{t=1} = -(\sin 1 + \cos 2)(\sin 1) + (\cos 1 + \cos 2)(\cos 1) - 2(\sin 1 + \cos 1)(\sin 2)$

34. $\frac{\partial w}{\partial x} = \frac{dw}{ds} \frac{\partial s}{\partial x} = (5) \frac{dw}{ds}$ and $\frac{\partial w}{\partial y} = \frac{dw}{ds} \frac{\partial s}{\partial y} = (1) \frac{dw}{ds} = \frac{dw}{ds} \Rightarrow \frac{\partial w}{\partial x} - 5 \frac{\partial w}{\partial y} = 5 \frac{dw}{ds} - 5 \frac{dw}{ds} = 0$

35. $F(x, y) = 1 - x - y^2 - \sin xy \Rightarrow F_x = -1 - y \cos xy \text{ and } F_y = -2y - x \cos xy \Rightarrow \frac{dy}{dx} = -\frac{F_x}{F_y} = -\frac{-1 - y \cos xy}{-2y - x \cos xy}$
 $= \frac{1 + y \cos xy}{-2y - x \cos xy} \Rightarrow \text{at } (x, y) = (0, 1) \text{ we have } \left.\frac{dy}{dx}\right|_{(0,1)} = \frac{1+1}{-2} = -1$

36. $F(x, y) = 2xy + e^{x+y} - 2 \Rightarrow F_x = 2y + e^{x+y} \text{ and } F_y = 2x + e^{x+y} \Rightarrow \frac{dy}{dx} = -\frac{F_x}{F_y} = -\frac{2y + e^{x+y}}{2x + e^{x+y}}$
 $\Rightarrow \text{at } (x, y) = (0, \ln 2) \text{ we have } \left.\frac{dy}{dx}\right|_{(0, \ln 2)} = -\frac{2 \ln 2 + 2}{0 + 2} = -(\ln 2 + 1)$

37. $\nabla f = (-\sin x \cos y)\mathbf{i} - (\cos x \sin y)\mathbf{j} \Rightarrow \nabla f|_{(\frac{\pi}{4}, \frac{\pi}{4})} = -\frac{1}{2}\mathbf{i} - \frac{1}{2}\mathbf{j} \Rightarrow |\nabla f| = \sqrt{\left(-\frac{1}{2}\right)^2 + \left(-\frac{1}{2}\right)^2} = \frac{\sqrt{2}}{2}$;
 $\mathbf{u} = \frac{\nabla f}{|\nabla f|} = -\frac{\sqrt{2}}{2}\mathbf{i} - \frac{\sqrt{2}}{2}\mathbf{j} \Rightarrow f$ increases most rapidly in the direction $\mathbf{u} = -\frac{\sqrt{2}}{2}\mathbf{i} - \frac{\sqrt{2}}{2}\mathbf{j}$ and decreases most rapidly in the direction $-\mathbf{u} = \frac{\sqrt{2}}{2}\mathbf{i} + \frac{\sqrt{2}}{2}\mathbf{j}$; $(D_{\mathbf{u}}f)_{P_0} = |\nabla f| = \frac{\sqrt{2}}{2}$ and $(D_{-\mathbf{u}}f)_{P_0} = -\frac{\sqrt{2}}{2}$; $\mathbf{u}_1 = \frac{\mathbf{v}}{|\mathbf{v}|} = \frac{3\mathbf{i}+4\mathbf{j}}{\sqrt{3^2+4^2}} = \frac{3}{5}\mathbf{i} + \frac{4}{5}\mathbf{j}$
 $\Rightarrow (D_{\mathbf{u}_1}f)_{P_0} = f \cdot \mathbf{u}_1 = \left(-\frac{1}{2}\right)\left(\frac{3}{5}\right) + \left(-\frac{1}{2}\right)\left(\frac{4}{5}\right) = -\frac{7}{10}$
38. $\nabla f = 2xe^{-2y}\mathbf{i} - 2x^2e^{-2y}\mathbf{j} \Rightarrow \nabla f|_{(1,0)} = 2\mathbf{i} - 2\mathbf{j} \Rightarrow |\nabla f| = \sqrt{2^2 + (-2)^2} = 2\sqrt{2}$; $\mathbf{u} = \frac{\nabla f}{|\nabla f|} = \frac{1}{\sqrt{2}}\mathbf{i} - \frac{1}{\sqrt{2}}\mathbf{j} \Rightarrow f$ increases most rapidly in the direction $\mathbf{u} = \frac{1}{\sqrt{2}}\mathbf{i} - \frac{1}{\sqrt{2}}\mathbf{j}$ and decreases most rapidly in the direction $-\mathbf{u} = -\frac{1}{\sqrt{2}}\mathbf{i} + \frac{1}{\sqrt{2}}\mathbf{j}$; $(D_{\mathbf{u}}f)_{P_0} = |\nabla f| = 2\sqrt{2}$ and $(D_{-\mathbf{u}}f)_{P_0} = -2\sqrt{2}$; $\mathbf{u}_1 = \frac{\mathbf{v}}{|\mathbf{v}|} = \frac{\mathbf{i}+\mathbf{j}}{\sqrt{1^2+1^2}} = \frac{1}{\sqrt{2}}\mathbf{i} + \frac{1}{\sqrt{2}}\mathbf{j}$
 $\Rightarrow (D_{\mathbf{u}_1}f)_{P_0} = \nabla f \cdot \mathbf{u}_1 = (2)\left(\frac{1}{\sqrt{2}}\right) + (-2)\left(\frac{1}{\sqrt{2}}\right) = 0$
39. $\nabla f = \left(\frac{2}{2x+3y+6z}\right)\mathbf{i} + \left(\frac{3}{2x+3y+6z}\right)\mathbf{j} + \left(\frac{6}{2x+3y+6z}\right)\mathbf{k} \Rightarrow \nabla f|_{(-1,-1,1)} = 2\mathbf{i} + 3\mathbf{j} + 6\mathbf{k}$; $\mathbf{u} = \frac{\nabla f}{|\nabla f|} = \frac{2\mathbf{i}+3\mathbf{j}+6\mathbf{k}}{\sqrt{2^2+3^2+6^2}}$
 $= \frac{2}{7}\mathbf{i} + \frac{3}{7}\mathbf{j} + \frac{6}{7}\mathbf{k} \Rightarrow f$ increases most rapidly in the direction $\mathbf{u} = \frac{2}{7}\mathbf{i} + \frac{3}{7}\mathbf{j} + \frac{6}{7}\mathbf{k}$ and decreases most rapidly in the direction $-\mathbf{u} = -\frac{2}{7}\mathbf{i} - \frac{3}{7}\mathbf{j} - \frac{6}{7}\mathbf{k}$; $(D_{\mathbf{u}}f)_{P_0} = |\nabla f| = 7$, $(D_{-\mathbf{u}}f)_{P_0} = -7$; $\mathbf{u}_1 = \frac{\mathbf{v}}{|\mathbf{v}|} = \frac{2}{7}\mathbf{i} + \frac{3}{7}\mathbf{j} + \frac{6}{7}\mathbf{k}$
 $\Rightarrow (D_{\mathbf{u}_1}f)_{P_0} = (D_{\mathbf{u}}f)_{P_0} = 7$
40. $\nabla f = (2x+3y)\mathbf{i} + (3x+2)\mathbf{j} + (1-2z)\mathbf{k} \Rightarrow \nabla f|_{(0,0,0)} = 2\mathbf{j} + \mathbf{k}$; $\mathbf{u} = \frac{\nabla f}{|\nabla f|} = \frac{2}{\sqrt{5}}\mathbf{j} + \frac{1}{\sqrt{5}}\mathbf{k} \Rightarrow f$ increases most rapidly in the direction $\mathbf{u} = \frac{2}{\sqrt{5}}\mathbf{j} + \frac{1}{\sqrt{5}}\mathbf{k}$ and decreases most rapidly in the direction $-\mathbf{u} = -\frac{2}{\sqrt{5}}\mathbf{j} - \frac{1}{\sqrt{5}}\mathbf{k}$;
 $(D_{\mathbf{u}}f)_{P_0} = |\nabla f| = \sqrt{5}$ and $(D_{-\mathbf{u}}f)_{P_0} = -\sqrt{5}$; $\mathbf{u}_1 = \frac{\mathbf{v}}{|\mathbf{v}|} = \frac{\mathbf{i}+\mathbf{j}+\mathbf{k}}{\sqrt{1^2+1^2+1^2}} = \frac{1}{\sqrt{3}}\mathbf{i} + \frac{1}{\sqrt{3}}\mathbf{j} + \frac{1}{\sqrt{3}}\mathbf{k} \Rightarrow (D_{\mathbf{u}_1}f)_{P_0}$
 $= f \cdot \mathbf{u}_1 = (0)\left(\frac{1}{\sqrt{3}}\right) + (2)\left(\frac{1}{\sqrt{3}}\right) + (1)\left(\frac{1}{\sqrt{3}}\right) = \frac{3}{\sqrt{3}} = \sqrt{3}$
41. $\mathbf{r} = (\cos 3t)\mathbf{i} + (\sin 3t)\mathbf{j} + 3t\mathbf{k} \Rightarrow \mathbf{v}(t) = (-3 \sin 3t)\mathbf{i} + (3 \cos 3t)\mathbf{j} + 3\mathbf{k} \Rightarrow \mathbf{v}\left(\frac{\pi}{3}\right) = -3\mathbf{j} + 3\mathbf{k} \Rightarrow \mathbf{u} = -\frac{1}{\sqrt{2}}\mathbf{j} + \frac{1}{\sqrt{2}}\mathbf{k}$;
 $f(x, y, z) = xyz \Rightarrow \nabla f = yz\mathbf{i} + xz\mathbf{j} + xy\mathbf{k}$; $t = \frac{\pi}{3}$ yields the point on the helix $(-1, 0, \pi)$
 $\Rightarrow \nabla f|_{(-1,0,\pi)} = -\pi\mathbf{j} \Rightarrow \nabla f \cdot \mathbf{u} = (-\pi\mathbf{j}) \cdot \left(-\frac{1}{\sqrt{2}}\mathbf{j} + \frac{1}{\sqrt{2}}\mathbf{k}\right) = \frac{\pi}{\sqrt{2}}$
42. $f(x, y, z) = xyz \Rightarrow \nabla f = yz\mathbf{i} + xz\mathbf{j} + xy\mathbf{k}$; at $(1, 1, 1)$ we get $\nabla f = \mathbf{i} + \mathbf{j} + \mathbf{k} \Rightarrow$ the maximum value of $D_{\mathbf{u}}f|_{(1,1,1)} = |\nabla f| = \sqrt{3}$
43. (a) Let $\nabla f = a\mathbf{i} + b\mathbf{j}$ at $(1, 2)$. The direction toward $(2, 2)$ is determined by $\mathbf{v}_1 = (2-1)\mathbf{i} + (2-2)\mathbf{j} = \mathbf{i} = \mathbf{u}$ so that $\nabla f \cdot \mathbf{u} = 2 \Rightarrow a = 2$. The direction toward $(1, 1)$ is determined by $\mathbf{v}_2 = (1-1)\mathbf{i} + (1-2)\mathbf{j} = -\mathbf{j} = \mathbf{u}$ so that $\nabla f \cdot \mathbf{u} = -2 \Rightarrow -b = -2 \Rightarrow b = 2$. Therefore $\nabla f = 2\mathbf{i} + 2\mathbf{j}$; $f_x(1, 2) = f_y(1, 2) = 2$.

(b) The direction toward (4, 6) is determined by $\mathbf{v}_3 = (4-1)\mathbf{i} + (6-2)\mathbf{j} = 3\mathbf{i} + 4\mathbf{j} \Rightarrow \mathbf{u} = \frac{3}{5}\mathbf{i} + \frac{4}{5}\mathbf{j}$
 $\Rightarrow \nabla f \cdot \mathbf{u} = \frac{14}{5}$.

44. (a) True (b) False (c) True (d) True

45. $\nabla f = 2x\mathbf{i} + \mathbf{j} + 2z\mathbf{k} \Rightarrow$
 $\nabla f|_{(0,-1,-1)} = -\mathbf{j} - 2\mathbf{k},$
 $\nabla f|_{(0,0,0)} = \mathbf{j},$
 $\nabla f|_{(0,-1,1)} = \mathbf{j} + 2\mathbf{k}$

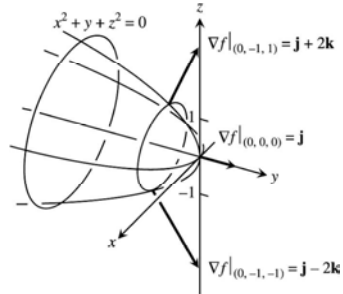

46. $\nabla f = 2y\mathbf{j} + 2z\mathbf{k} \Rightarrow$
 $\nabla f|_{(2,2,0)} = 4\mathbf{j},$
 $\nabla f|_{(2,-2,0)} = -4\mathbf{j},$
 $\nabla f|_{(2,0,2)} = 4\mathbf{k},$
 $\nabla f|_{(2,0,-2)} = -4\mathbf{k}$

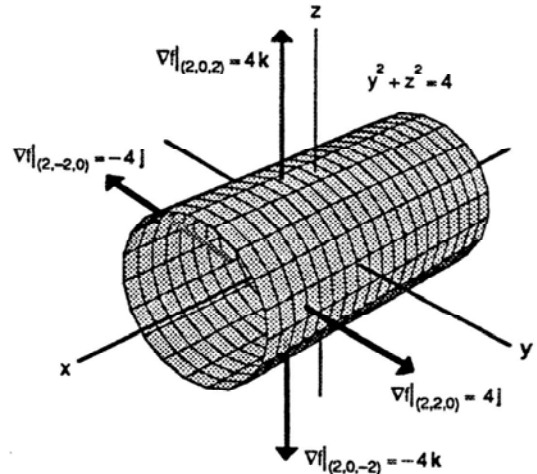

47. $\nabla f = 2x\mathbf{i} - \mathbf{j} - 5\mathbf{k} \Rightarrow \nabla f|_{(2,-1,1)} = 4\mathbf{i} - \mathbf{j} - 5\mathbf{k} \Rightarrow$ Tangent Plane: $4(x-2) - (y+1) - 5(z-1) = 0$
 $\Rightarrow 4x - y - 5z = 4$; Normal Line: $x = 2 + 4t, y = -1 - t, z = 1 - 5t$

48. $\nabla f = 2x\mathbf{i} + 2y\mathbf{j} + \mathbf{k} \Rightarrow \nabla f|_{(1,1,2)} = 2\mathbf{i} + 2\mathbf{j} + \mathbf{k} \Rightarrow$ Tangent Plane: $2(x-1) + 2(y-1) + (z-2) = 0$
 $\Rightarrow 2x + 2y + z - 6 = 0$; Normal Line: $x = 1 + 2t, y = 1 + 2t, z = 2 + t$

49. $\frac{\partial z}{\partial x} = \frac{2x}{x^2+y^2} \Rightarrow \frac{\partial z}{\partial x}|_{(0,1,0)} = 0$ and $\frac{\partial z}{\partial y} = \frac{2y}{x^2+y^2} \Rightarrow \frac{\partial z}{\partial y}|_{(0,1,0)} = 2$; thus the tangent plane is $2(y-1) - (z-0) = 0$ or $2y - z - 2 = 0$

50. $\frac{\partial z}{\partial x} = -2x(x^2+y^2)^{-2} \Rightarrow \frac{\partial z}{\partial x}|_{(1,1,\frac{1}{2})} = -\frac{1}{2}$ and $\frac{\partial z}{\partial y} = -2y(x^2+y^2)^{-2} \Rightarrow \frac{\partial z}{\partial y}|_{(1,1,\frac{1}{2})} = -\frac{1}{2}$; thus the tangent plane is $-\frac{1}{2}(x-1) - \frac{1}{2}(y-1) - (z - \frac{1}{2}) = 0$ or $x + y + 2z - 3 = 0$

51. $\nabla F = (-\cos x)\mathbf{i} + \mathbf{j} \Rightarrow \nabla f|_{(\pi,1)} = \mathbf{i} + \mathbf{j} \Rightarrow$ the tangent line is $(x-\pi) + (y-1) = 0 \Rightarrow x + y = \pi + 1$; the normal line is $y-1 = 1(x-\pi) \Rightarrow y = x - \pi + 1$

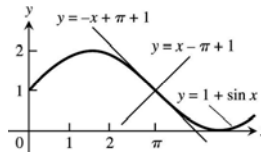

52. $\nabla f = -x\mathbf{i} + y\mathbf{j} \Rightarrow \nabla f|_{(1,2)} = -\mathbf{i} + 2\mathbf{j} \Rightarrow$ the tangent line is $-(x-1) + 2(y-2) = 0 \Rightarrow y = \frac{1}{2}x + \frac{3}{2}$; the normal line is $y-2 = -2(x-1) \Rightarrow y = -2x + 4$

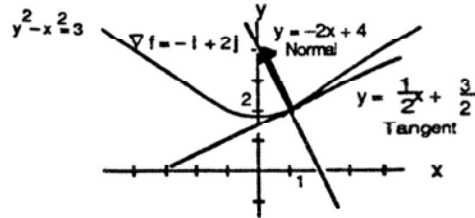

53. Let $f(x, y, z) = x^2 + 2y + 2z - 4$ and $g(x, y, z) = y - 1$. Then $\nabla f = 2x\mathbf{i} + 2\mathbf{j} + 2\mathbf{k} |_{(1,1,\frac{1}{2})} = 2\mathbf{i} + 2\mathbf{j} + 2\mathbf{k}$ and

$$\nabla g = \mathbf{j} \Rightarrow \nabla f \times \nabla g = \begin{vmatrix} \mathbf{i} & \mathbf{j} & \mathbf{k} \\ 2 & 2 & 2 \\ 0 & 1 & 0 \end{vmatrix} = -2\mathbf{i} + 2\mathbf{k} \Rightarrow \text{the line is } x = 1 - 2t, y = 1, z = \frac{1}{2} + 2t$$

54. Let $f(x, y, z) = x + y^2 + z - 2$ and $g(x, y, z) = y - 1$. Then $\nabla f = \mathbf{i} + 2y\mathbf{j} + \mathbf{k} |_{(\frac{1}{2},1,\frac{1}{2})} = \mathbf{i} + 2\mathbf{j} + \mathbf{k}$ and

$$\nabla g = \mathbf{j} \Rightarrow \nabla f \times \nabla g = \begin{vmatrix} \mathbf{i} & \mathbf{j} & \mathbf{k} \\ 1 & 2 & 1 \\ 0 & 1 & 0 \end{vmatrix} = -\mathbf{i} + \mathbf{k} \Rightarrow \text{the line is } x = \frac{1}{2} - t, y = 1, z = \frac{1}{2} + t$$

55. $f\left(\frac{\pi}{4}, \frac{\pi}{4}\right) = \frac{1}{2}$, $f_x\left(\frac{\pi}{4}, \frac{\pi}{4}\right) = \cos x \cos y |_{(\pi/4, \pi/4)} = \frac{1}{2}$, $f_y\left(\frac{\pi}{4}, \frac{\pi}{4}\right) = -\sin x \sin y |_{(\pi/4, \pi/4)} = -\frac{1}{2}$
 $\Rightarrow L(x, y) = \frac{1}{2} + \frac{1}{2}\left(x - \frac{\pi}{4}\right) - \frac{1}{2}\left(y - \frac{\pi}{4}\right) = \frac{1}{2} + \frac{1}{2}x - \frac{1}{2}y$; $f_{xx}(x, y) = -\sin x \cos y$, $f_{yy}(x, y) = -\sin x \cos y$, and $f_{xy}(x, y) = -\cos x \sin y$. Thus an upper bound for E depends on the bound M used for $|f_{xx}|$, $|f_{xy}|$, and $|f_{yy}|$.

With $M = \frac{\sqrt{2}}{2}$ we have $|E(x, y)| \leq \frac{1}{2}\left(\frac{\sqrt{2}}{2}\right)\left(\left|x - \frac{\pi}{4}\right| + \left|y - \frac{\pi}{4}\right|\right)^2 \leq \frac{\sqrt{2}}{4}(0.2)^2 \leq 0.0142$;

with $M = 1$, $|E(x, y)| \leq \frac{1}{2}(1)\left(\left|x - \frac{\pi}{4}\right| + \left|y - \frac{\pi}{4}\right|\right)^2 = \frac{1}{2}(0.2)^2 = 0.02$.

56. $f(1, 1) = 0$, $f_x(1, 1) = y |_{(1,1)} = 1$, $f_y(1, 1) = x - 6y |_{(1,1)} = -5 \Rightarrow L(x, y) = (x-1) - 5(y-1) = x - 5y + 4$;
 $f_{xx}(x, y) = 0$, $f_{yy}(x, y) = -6$, and $f_{xy}(x, y) = 1 \Rightarrow$ maximum of $|f_{xx}|$, $|f_{yy}|$, and $|f_{xy}|$ is 6 $\Rightarrow M = 6$
 $\Rightarrow |E(x, y)| \leq \frac{1}{2}(6)(|x-1| + |y-1|)^2 = \frac{1}{2}(6)(0.1 + 0.2)^2 = 0.27$

57. $f(1, 0, 0) = 0$, $f_x(1, 0, 0) = y - 3z |_{(1,0,0)} = 0$, $f_y(1, 0, 0) = x + 2z |_{(1,0,0)} = 1$, $f_z(1, 0, 0) = 2y - 3x |_{(1,0,0)} = -3$
 $\Rightarrow L(x, y, z) = 0(x-1) + (y-0) - 3(z-0) = y - 3z$; $f(1, 1, 0) = 1$, $f_x(1, 1, 0) = 1$, $f_y(1, 1, 0) = 1$, $f_z(1, 1, 0) = -1$
 $\Rightarrow L(x, y, z) = 1 + (x-1) + (y-1) - 1(z-0) = x + y - z - 1$

58. $f\left(0, 0, \frac{\pi}{4}\right) = 1$, $f_x\left(0, 0, \frac{\pi}{4}\right) = -\sqrt{2} \sin x \sin(y+z) |_{(0,0,\pi/4)} = 0$, $f_y\left(0, 0, \frac{\pi}{4}\right) = \sqrt{2} \cos x \cos(y+z) |_{(0,0,\pi/4)} = 1$,
 $f_z\left(0, 0, \frac{\pi}{4}\right) = \sqrt{2} \cos x \cos(y+z) |_{(0,0,\pi/4)} = 1 \Rightarrow L(x, y, z) = 1 + 1(y-0) + 1\left(z - \frac{\pi}{4}\right) = 1 + y + z - \frac{\pi}{4}$;

$$f\left(\frac{\pi}{4}, \frac{\pi}{4}, 0\right) = \frac{\sqrt{2}}{2}, f_x\left(\frac{\pi}{4}, \frac{\pi}{4}, 0\right) = -\frac{\sqrt{2}}{2}, f_y\left(\frac{\pi}{4}, \frac{\pi}{4}, 0\right) = \frac{\sqrt{2}}{2}, f_z\left(\frac{\pi}{4}, \frac{\pi}{4}, 0\right) = \frac{\sqrt{2}}{2}$$

$$\Rightarrow L(x, y, z) = \frac{\sqrt{2}}{2} - \frac{\sqrt{2}}{2}\left(x - \frac{\pi}{4}\right) + \frac{\sqrt{2}}{2}\left(y - \frac{\pi}{4}\right) + \frac{\sqrt{2}}{2}(z - 0) = \frac{\sqrt{2}}{2} - \frac{\sqrt{2}}{2}x + \frac{\sqrt{2}}{2}y + \frac{\sqrt{2}}{2}z$$

59. $V = \pi r^2 h \Rightarrow dV = 2\pi r h dr + \pi r^2 dh \Rightarrow dV|_{(1.5, 5280)} = 2\pi(1.5)(5280) dr + \pi(1.5)^2 dh = 15,840\pi dr + 2.25\pi dh$.
You should be more careful with the diameter since it has a greater effect on dV .

60. $df = (2x - y) dx + (-x + 2y) dy \Rightarrow df|_{(1, 2)} = 3 dy \Rightarrow f$ is more sensitive to changes in y ; in fact, near the point $(1, 2)$ a change in x does not change f .

61. $dI = \frac{1}{R} dV - \frac{V}{R^2} dR \Rightarrow dI|_{(24, 100)} = \frac{1}{100} dV - \frac{24}{100^2} dR \Rightarrow dI|_{dV=-1, dR=-20} = -0.01 + (480)(.0001) = 0.038$, or
increases by 0.038 amps; % change in $V = (100)\left(-\frac{1}{24}\right) \approx -4.17\%$; % change in $R = \left(-\frac{20}{100}\right)(100) = -20\%$;
 $I = \frac{24}{100} = 0.24 \Rightarrow$ estimated % change in $I = \frac{dI}{I} \times 100 = \frac{0.038}{0.24} \times 100 \approx 15.83\% \Rightarrow$ more sensitive to voltage change.

62. $A = \pi ab \Rightarrow dA = \pi b da + \pi a db \Rightarrow dA|_{(10, 16)} = 16\pi da + 10\pi db$; $da = \pm 0.1$ and $db = \pm 0.1$
 $\Rightarrow dA = \pm 26\pi(0.1) = \pm 2.6\pi$ and $A = \pi(10)(16) = 160\pi \Rightarrow \left|\frac{dA}{A} \times 100\right| = \left|\frac{2.6\pi}{160\pi} \times 100\right| \approx 1.625\%$

63. (a) $y = uv \Rightarrow dy = v du + u dv$; percentage change in $u \leq 2\% \Rightarrow |du| \leq 0.02$, and percentage change in $v \leq 3\%$
 $\Rightarrow |dv| \leq 0.03$; $\frac{dy}{y} = \frac{v du + u dv}{uv} = \frac{du}{u} + \frac{dv}{v} \Rightarrow \left|\frac{dy}{y} \times 100\right| = \left|\frac{du}{u} \times 100 + \frac{dv}{v} \times 100\right| \leq \left|\frac{du}{u} \times 100\right| + \left|\frac{dv}{v} \times 100\right|$
 $\leq 2\% + 3\% = 5\%$

(b) $z = u + v \Rightarrow \frac{dz}{z} = \frac{du + dv}{u + v} = \frac{du}{u + v} + \frac{dv}{u + v} \leq \frac{du}{u} + \frac{dv}{v}$ (since $u > 0, v > 0$)
 $\Rightarrow \left|\frac{dz}{z} \times 100\right| \leq \left|\frac{du}{u} \times 100 + \frac{dv}{v} \times 100\right| = \left|\frac{dy}{y} \times 100\right|$

64. $C = \frac{7}{71.84w^{0.425}h^{0.725}} \Rightarrow C_w = \frac{(-0.425)(7)}{71.84w^{1.425}h^{0.725}}$ and $C_h = \frac{(-0.725)(7)}{71.84w^{0.425}h^{1.725}}$
 $\Rightarrow dC = \frac{-2.975}{71.84w^{1.425}h^{0.725}} dw + \frac{-5.075}{71.84w^{0.425}h^{1.725}} dh$; thus when $w = 70$ and $h = 180$ we have
 $dC|_{(70, 180)} \approx -(0.00000225) dw - (0.00000149) dh \Rightarrow 1 \text{ kg error in weight has more effect}$

65. $f_x(x, y) = 2x - y + 2 = 0$ and $f_y(x, y) = -x + 2y + 2 = 0 \Rightarrow x = -2$ and $y = -2 \Rightarrow (-2, -2)$ is the critical
point; $f_{xx}(-2, -2) = 2, f_{yy}(-2, -2) = 2, f_{xy}(-2, -2) = -1 \Rightarrow f_{xx}f_{yy} - f_{xy}^2 = 3 > 0$ and $f_{xx} > 0 \Rightarrow$ local minimum
value of $f(-2, -2) = -8$

66. $f_x(x, y) = 10x + 4y + 4 = 0$ and $f_y(x, y) = 4x - 4y - 4 = 0 \Rightarrow x = 0$ and $y = -1 \Rightarrow (0, -1)$ is the critical point;
 $f_{xx}(0, -1) = 10, f_{yy}(0, -1) = -4, f_{xy}(0, -1) = 4 \Rightarrow f_{xx}f_{yy} - f_{xy}^2 = -56 < 0 \Rightarrow$ saddle point with $f(0, -1) = 2$

67. $f_x(x, y) = 6x^2 + 3y = 0$ and $f_y(x, y) = 3x + 6y^2 = 0 \Rightarrow y = -2x^2$ and $3x + 6(4x^4) = 0 \Rightarrow x(1 + 8x^3) = 0$
 $\Rightarrow x = 0$ and $y = 0$, or $x = -\frac{1}{2}$ and $y = -\frac{1}{2} \Rightarrow$ the critical points are $(0, 0)$ and $\left(-\frac{1}{2}, -\frac{1}{2}\right)$. For $(0, 0)$:

$f_{xx}(0, 0) = 12x|_{(0,0)} = 0$, $f_{yy}(0, 0) = 12y|_{(0,0)} = 0$, $f_{xy}(0, 0) = 3 \Rightarrow f_{xx}f_{yy} - f_{xy}^2 = -9 < 0 \Rightarrow$ saddle point with $f(0, 0) = 0$. For $(-\frac{1}{2}, -\frac{1}{2})$: $f_{xx} = -6$, $f_{yy} = -6$, $f_{xy} = 3 \Rightarrow f_{xx}f_{yy} - f_{xy}^2 = 27 > 0$ and $f_{xx} < 0 \Rightarrow$ local maximum value of $f(-\frac{1}{2}, -\frac{1}{2}) = \frac{1}{4}$

68. $f_x(x, y) = 3x^2 - 3y = 0$ and $f_y(x, y) = 3y^2 - 3x = 0 \Rightarrow y = x^2$ and $x^4 - x = 0 \Rightarrow x(x^3 - 1) = 0 \Rightarrow$ the critical points are $(0, 0)$ and $(1, 1)$. For $(0, 0)$: $f_{xx}(0, 0) = 6x|_{(0,0)} = 0$, $f_{yy}(0, 0) = 6y|_{(0,0)} = 0$, $f_{xy}(0, 0) = -3 \Rightarrow f_{xx}f_{yy} - f_{xy}^2 = -9 < 0 \Rightarrow$ saddle point with $f(0, 0) = 15$. For $(1, 1)$: $f_{xx}(1, 1) = 6$, $f_{yy}(1, 1) = 6$, $f_{xy}(1, 1) = -3 \Rightarrow f_{xx}f_{yy} - f_{xy}^2 = 27 > 0$ and $f_{xx} > 0 \Rightarrow$ local minimum value of $f(1, 1) = 14$

69. $f_x(x, y) = 3x^2 + 6x = 0$ and $f_y(x, y) = 3y^2 - 6y = 0 \Rightarrow x(x + 2) = 0$ and $y(y - 2) = 0 \Rightarrow x = 0$ or $x = -2$ and $y = 0$ or $y = 2 \Rightarrow$ the critical points are $(0, 0)$, $(0, 2)$, $(-2, 0)$, and $(-2, 2)$. For $(0, 0)$: $f_{xx}(0, 0) = 6x + 6|_{(0,0)} = 6$, $f_{yy}(0, 0) = 6y - 6|_{(0,0)} = -6$, $f_{xy}(0, 0) = 0 \Rightarrow f_{xx}f_{yy} - f_{xy}^2 = -36 < 0 \Rightarrow$ saddle point with $f(0, 0) = 0$. For $(0, 2)$: $f_{xx}(0, 2) = 6$, $f_{yy}(0, 2) = 6$, $f_{xy}(0, 2) = 0 \Rightarrow f_{xx}f_{yy} - f_{xy}^2 = 36 > 0$ and $f_{xx} > 0 \Rightarrow$ local minimum value of $f(0, 2) = -4$. For $(-2, 0)$: $f_{xx}(-2, 0) = -6$, $f_{yy}(-2, 0) = -6$, $f_{xy}(-2, 0) = 0 \Rightarrow f_{xx}f_{yy} - f_{xy}^2 = 36 > 0$ and $f_{xx} < 0 \Rightarrow$ local maximum value of $f(-2, 0) = 4$. For $(-2, 2)$: $f_{xx}(-2, 2) = -6$, $f_{yy}(-2, 2) = 6$, $f_{xy}(-2, 2) = 0 \Rightarrow f_{xx}f_{yy} - f_{xy}^2 = -36 < 0 \Rightarrow$ saddle point with $f(-2, 2) = 0$.

70. $f_x(x, y) = 4x^3 - 16x = 0 \Rightarrow 4x(x^2 - 4) = 0 \Rightarrow x = 0, 2, -2$; $f_y(x, y) = 6y - 6 = 0 \Rightarrow y = 1$. Therefore the critical points are $(0, 1)$, $(2, 1)$, and $(-2, 1)$. For $(0, 1)$: $f_{xx}(0, 1) = 12x^2 - 16|_{(0,1)} = -16$, $f_{yy}(0, 1) = 6$, $f_{xy}(0, 1) = 0 \Rightarrow f_{xx}f_{yy} - f_{xy}^2 = -96 < 0 \Rightarrow$ saddle point with $f(0, 1) = -3$. For $(2, 1)$: $f_{xx}(2, 1) = 32$, $f_{yy}(2, 1) = 6$, $f_{xy}(2, 1) = 0 \Rightarrow f_{xx}f_{yy} - f_{xy}^2 = 192 > 0$ and $f_{xx} > 0 \Rightarrow$ local minimum value of $f(2, 1) = -19$. For $(-2, 1)$: $f_{xx}(-2, 1) = 32$, $f_{yy}(-2, 1) = 6$, $f_{xy}(-2, 1) = 0 \Rightarrow f_{xx}f_{yy} - f_{xy}^2 = 192 > 0$ and $f_{xx} > 0 \Rightarrow$ local minimum value of $f(-2, 1) = -19$.

71. (i) On OA $f(x, y) = f(0, y) = y^2 + 3y$ for $0 \leq y \leq 4$
 $\Rightarrow f'(0, y) = 2y + 3 = 0 \Rightarrow y = -\frac{3}{2}$. But $(0, -\frac{3}{2})$ is not in the region.
 Endpoints: $f(0, 0) = 0$ and $f(0, 4) = 28$.
- (ii) On AB , $f(x, y) = f(x, -x + 4) = x^2 - 10x + 28$
 for $0 \leq x \leq 4 \Rightarrow f'(x, -x + 4) = 2x - 10 = 0$
 $\Rightarrow x = 5$, $y = -1$. But $(5, -1)$ is not in the region.
 Endpoints: $f(4, 0) = 4$ and $f(0, 4) = 28$.

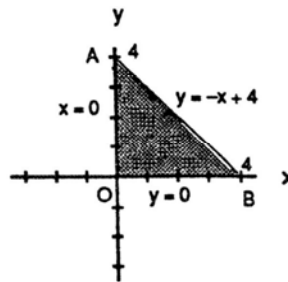

(iii) On OB , $f(x, y) = f(x, 0) = x^2 - 3x$ for $0 \leq x \leq 4 \Rightarrow f'(x, 0) = 2x - 3 \Rightarrow x = \frac{3}{2}$ and $y = 0 \Rightarrow (\frac{3}{2}, 0)$ is a critical point with $f(\frac{3}{2}, 0) = -\frac{9}{4}$. Endpoints: $f(0, 0) = 0$ and $f(4, 0) = 4$.

- (iv) For the interior of the triangular region, $f_x(x, y) = 2x + y - 3 = 0$ and $f_y(x, y) = x + 2y + 3 = 0 \Rightarrow x = 3$ and $y = -3$. But $(3, -3)$ is not in the region. Therefore the absolute maximum is 28 at $(0, 4)$ and the absolute minimum is $-\frac{9}{4}$ at $(\frac{3}{2}, 0)$.

72. (i) On OA , $f(x, y) = f(0, y) = -y^2 + 4y + 1$ for $0 \leq y \leq 2 \Rightarrow f'(0, y) = -2y + 4 = 0 \Rightarrow y = 2$ and $x = 0$. But $(0, 2)$ is not in the interior of OA . Endpoints: $f(0, 0) = 1$ and $f(0, 2) = 5$.

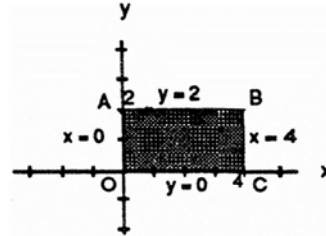

- (ii) On AB , $f(x, y) = f(x, 2) = x^2 - 2x + 5$ for $0 \leq x \leq 4 \Rightarrow f'(x, 2) = 2x - 2 = 0 \Rightarrow x = 1$ and $y = 2 \Rightarrow (1, 2)$ is an interior critical point of AB with $f(1, 2) = 4$. Endpoints: $f(4, 2) = 13$ and $f(0, 2) = 5$.

- (iii) On BC , $f(x, y) = f(4, y) = -y^2 + 4y + 9$ for $0 \leq y \leq 2 \Rightarrow f'(4, y) = -2y + 4 = 0 \Rightarrow y = 2$ and $x = 4$. But $(4, 2)$ is not in the interior of BC . Endpoints: $f(4, 0) = 9$ and $f(4, 2) = 13$.

- (iv) On OC , $f(x, y) = f(x, 0) = x^2 - 2x + 1$ for $0 \leq x \leq 4 \Rightarrow f'(x, 0) = 2x - 2 = 0 \Rightarrow x = 1$ and $y = 0 \Rightarrow (1, 0)$ is an interior critical point of OC with $f(1, 0) = 0$. Endpoints: $f(0, 0) = 1$ and $f(4, 0) = 9$.

- (v) For the interior of the rectangular region, $f_x(x, y) = 2x - 2 = 0$ and $f_y(x, y) = -2y + 4 = 0 \Rightarrow x = 1$ and $y = 2$. But $(1, 2)$ is not in the interior of the region. Therefore the absolute maximum is 13 at $(4, 2)$ and the absolute minimum is 0 at $(1, 0)$.

73. (i) On AB , $f(x, y) = f(-2, y) = y^2 - y - 4$ for $-2 \leq y \leq 2 \Rightarrow f'(-2, y) = 2y - 1 \Rightarrow y = \frac{1}{2}$ and $x = -2 \Rightarrow (-2, \frac{1}{2})$ is an interior critical point in AB with $f(-2, \frac{1}{2}) = -\frac{17}{4}$. Endpoints: $f(-2, -2) = 2$ and $f(-2, 2) = -2$.

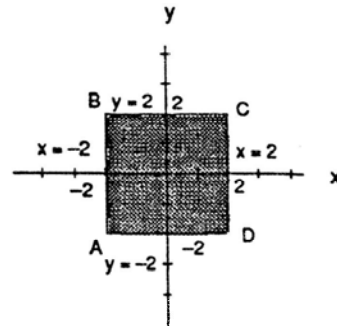

- (ii) On BC , $f(x, y) = f(x, 2) = -2$ for $-2 \leq x \leq 2 \Rightarrow f'(x, 2) = 0 \Rightarrow$ no critical points in the interior of BC . Endpoints: $f(-2, 2) = -2$ and $f(2, 2) = -2$.

- (iii) On CD , $f(x, y) = f(2, y) = y^2 - 5y + 4$ for $-2 \leq y \leq 2 \Rightarrow f'(2, y) = 2y - 5 = 0 \Rightarrow y = \frac{5}{2}$ and $x = 2$. But $(2, \frac{5}{2})$ is not in the region. Endpoints: $f(2, -2) = 18$ and $f(2, 2) = -2$.

- (iv) On AD , $f(x, y) = f(x, -2) = 4x + 10$ for $-2 \leq x \leq 2 \Rightarrow f'(x, -2) = 4 \Rightarrow$ no critical points in the interior of AD . Endpoints: $f(-2, -2) = 2$ and $f(2, -2) = 18$.

- (v) For the interior of the square, $f_x(x, y) = -y + 2 = 0$ and $f_y(x, y) = 2y - x - 3 = 0 \Rightarrow y = 2$ and $x = 1 \Rightarrow (1, 2)$ is an interior critical point of the square with $f(1, 2) = -2$. Therefore the absolute maximum is 18 at $(2, -2)$ and the absolute minimum is $-\frac{17}{4}$ at $(-2, \frac{1}{2})$.

74. (i) On OA , $f(x, y) = f(0, y) = 2y - y^2$ for $0 \leq y \leq 2 \Rightarrow f'(0, y) = 2 - 2y = 0 \Rightarrow y = 1$ and $x = 0 \Rightarrow (0, 1)$ is an interior critical point of OA with $f(0, 1) = 1$.
Endpoints: $f(0, 0) = 0$ and $f(0, 2) = 0$.

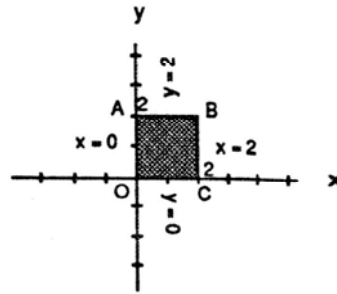

(ii) On AB , $f(x, y) = f(x, 2) = 2x - x^2$ for $0 \leq x \leq 2 \Rightarrow f'(x, 2) = 2 - 2x = 0 \Rightarrow x = 1$ and $y = 2 \Rightarrow (1, 2)$ is an interior critical point of AB with $f(1, 2) = 1$.
Endpoints: $f(0, 2) = 0$ and $f(2, 2) = 0$.

(iii) On BC , $f(x, y) = f(2, y) = 2y - y^2$ for $0 \leq y \leq 2 \Rightarrow f'(2, y) = 2 - 2y = 0 \Rightarrow y = 1$ and $x = 2 \Rightarrow (2, 1)$ is an interior critical point of BC with $f(2, 1) = 1$. Endpoints: $f(2, 0) = 0$ and $f(2, 2) = 0$.

(iv) On OC , $f(x, y) = f(x, 0) = 2x - x^2$ for $0 \leq x \leq 2 \Rightarrow f'(x, 0) = 2 - 2x = 0 \Rightarrow x = 1$ and $y = 0 \Rightarrow (1, 0)$ is an interior critical point of OC with $f(1, 0) = 1$. Endpoints: $f(0, 0) = 0$ and $f(2, 0) = 0$.

(v) For the interior of the rectangular region, $f_x(x, y) = 2 - 2x = 0$ and $f_y(x, y) = 2 - 2y = 0 \Rightarrow x = 1$ and $y = 1 \Rightarrow (1, 1)$ is an interior critical point of the square with $f(1, 1) = 2$. Therefore the absolute maximum is 2 at $(1, 1)$ and the absolute minimum is 0 at the corners $(0, 0)$, $(0, 2)$, $(2, 2)$, and $(2, 0)$.

75. (i) On AB , $f(x, y) = f(x, x+2) = -2x + 4$ for $-2 \leq x \leq 2 \Rightarrow f'(x, x+2) = -2 = 0 \Rightarrow$ no critical points in the interior of AB .
Endpoints: $f(-2, 0) = 8$ and $f(2, 4) = 0$.

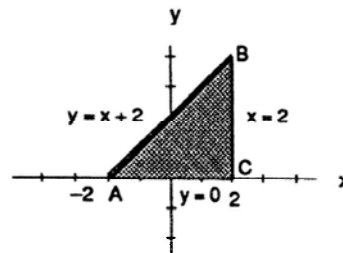

(ii) On BC , $f(x, y) = f(2, y) = -y^2 + 4y$ for $0 \leq y \leq 4 \Rightarrow f'(2, y) = -2y + 4 = 0 \Rightarrow y = 2$ and $x = 2 \Rightarrow (2, 2)$ is an interior critical point of BC with $f(2, 2) = 4$.
Endpoints: $f(2, 0) = 0$ and $f(2, 4) = 0$.

(iii) On AC , $f(x, y) = f(x, 0) = x^2 - 2x$ for $-2 \leq x \leq 2 \Rightarrow f'(x, 0) = 2x - 2 = 0 \Rightarrow x = 1$ and $y = 0 \Rightarrow (1, 0)$ is an interior critical point of AC with $f(1, 0) = -1$. Endpoints: $f(-2, 0) = 8$ and $f(2, 0) = 0$.

(iv) For the interior of the triangular region, $f_x(x, y) = 2x - 2 = 0$ and $f_y(x, y) = -2y + 4 = 0 \Rightarrow x = 1$ and $y = 2 \Rightarrow (1, 2)$ is an interior critical point of the region with $f(1, 2) = 3$. Therefore the absolute maximum is 8 at $(-2, 0)$ and the absolute minimum is -1 at $(1, 0)$.

76. (i) On AB , $f(x, y) = f(x, x) = 4x^2 - 2x^4 + 16$ for $-2 \leq x \leq 2 \Rightarrow f'(x, x) = 8x - 8x^3 = 0 \Rightarrow x = 0$ and $y = 0$, or $x = 1$ and $y = 1$, or $x = -1$ and $y = -1 \Rightarrow (0, 0)$, $(1, 1)$, $(-1, -1)$ are all interior points of AB with $f(0, 0) = 16$, $f(1, 1) = 18$, and $f(-1, -1) = 18$.
Endpoints: $f(-2, -2) = 0$ and $f(2, 2) = 0$.

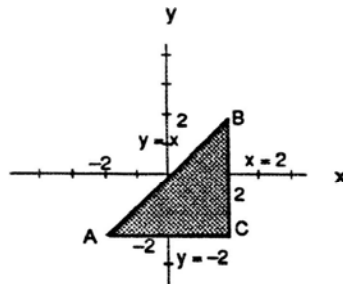

- (ii) On BC , $f(x, y) = f(2, y) = 8y - y^4$ for $-2 \leq y \leq 2 \Rightarrow f'(2, y) = 8 - 4y^3 = 0 \Rightarrow y = \sqrt[3]{2}$ and $x = 2 \Rightarrow (2, \sqrt[3]{2})$ is an interior critical point of BC with $f(2, \sqrt[3]{2}) = 6\sqrt[3]{2}$.
Endpoints: $f(2, -2) = -32$ and $f(2, 2) = 0$.
- (iii) On AC , $f(x, y) = f(x, -2) = -8x - x^4$ for $-2 \leq x \leq 2 \Rightarrow f'(x, -2) = -8 - 4x^3 = 0 \Rightarrow x = \sqrt[3]{-2}$ and $y = -2 \Rightarrow (\sqrt[3]{-2}, -2)$ is an interior critical point of AC with $f(\sqrt[3]{-2}, -2) = 6\sqrt[3]{2}$.
Endpoints: $f(-2, -2) = 0$ and $f(2, -2) = -32$.
- (iv) For the interior of the triangular region, $f_x(x, y) = 4y - 4x^3 = 0$ and $f_y(x, y) = 4x - 4y^3 = 0 \Rightarrow x = 0$ and $y = 0$, or $x = 1$ and $y = 1$ or $x = -1$ and $y = -1$. But neither of the points $(0, 0)$ and $(1, 1)$, or $(-1, -1)$ are interior to the region. Therefore the absolute maximum is 18 at $(1, 1)$, and $(-1, -1)$, the absolute minimum is -32 at $(2, -2)$.

77. (i) On AB , $f(x, y) = f(-1, y) = y^3 - 3y^2 + 2$ for $-1 \leq y \leq 1 \Rightarrow f'(-1, y) = 3y^2 - 6y = 0 \Rightarrow y = 0$ and $x = -1$, or $y = 2$ and $x = -1 \Rightarrow (-1, 0)$ is an interior critical point of AB with $f(-1, 0) = 2$; $(-1, 2)$ is outside the boundary.
Endpoints: $f(-1, -1) = -2$ and $f(-1, 1) = 0$.

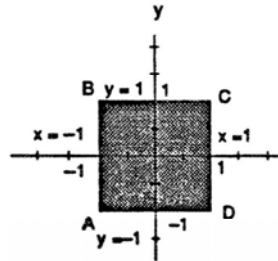

- (ii) On BC , $f(x, y) = f(x, 1) = x^3 + 3x^2 - 2$ for $-1 \leq x \leq 1 \Rightarrow f'(x, 1) = 3x^2 + 6x = 0 \Rightarrow x = 0$ and $y = 1$, or $x = -2$ and $y = 1 \Rightarrow (0, 1)$ is an interior critical point of BC with $f(0, 1) = -2$; $(-2, 1)$ is outside the boundary. Endpoints: $f(-1, 1) = 0$ and $f(1, 1) = 2$.
- (iii) On CD , $f(x, y) = f(1, y) = y^3 - 3y^2 + 4$ for $-1 \leq y \leq 1 \Rightarrow f'(1, y) = 3y^2 - 6y = 0 \Rightarrow y = 0$ and $x = 1$, or $y = 2$ and $x = 1 \Rightarrow (1, 0)$ is an interior critical point of CD with $f(1, 0) = 4$; $(1, 2)$ is outside the boundary. Endpoints: $f(1, 1) = 2$ and $f(1, -1) = 0$.
- (iv) On AD , $f(x, y) = f(x, -1) = x^3 + 3x^2 - 4$ for $-1 \leq x \leq 1 \Rightarrow f'(x, -1) = 3x^2 + 6x = 0 \Rightarrow x = 0$ and $y = -1$, or $x = -2$ and $y = -1 \Rightarrow (0, -1)$ is an interior critical point of AD with $f(0, -1) = -4$; $(-2, -1)$ is outside the boundary. Endpoints: $f(-1, -1) = -2$ and $f(1, -1) = 0$.
- (v) For the interior of the square, $f_x(x, y) = 3x^2 + 6x = 0$ and $f_y(x, y) = 3y^2 - 6y = 0 \Rightarrow x = 0$ or $x = -2$, and $y = 0$ or $y = 2 \Rightarrow (0, 0)$ is an interior critical point of the square region with $f(0, 0) = 0$; the points $(0, 2)$, $(-2, 0)$, and $(-2, 2)$ are outside the region. Therefore the absolute maximum is 4 at $(1, 0)$ and the absolute minimum is -4 at $(0, -1)$.

78. (i) On AB , $f(x, y) = f(-1, y) = y^3 - 3y$ for $-1 \leq y \leq 1 \Rightarrow f'(-1, y) = 3y^2 - 3 = 0 \Rightarrow y = \pm 1$ and $x = -1$ yielding the corner points $(-1, -1)$ and $(-1, 1)$ with $f(-1, -1) = 2$ and $f(-1, 1) = -2$.
- (ii) On BC , $f(x, y) = f(x, 1) = x^3 + 3x + 2$ for $-1 \leq x \leq 1 \Rightarrow f'(x, 1) = 3x^2 + 3 = 0 \Rightarrow$ no solution.
Endpoints: $f(-1, 1) = -2$ and $f(1, 1) = 6$.

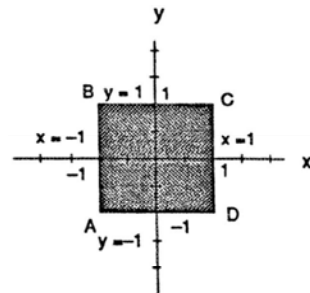

- (iii) On CD , $f(x, y) = f(1, y) = y^3 + 3y + 2$ for $-1 \leq y \leq 1 \Rightarrow f'(1, y) = 3y^2 + 3 = 0 \Rightarrow$ no solution.
 Endpoints: $f(1, 1) = 6$ and $f(1, -1) = -2$.
- (iv) On AD , $f(x, y) = f(x, -1) = x^3 - 3x$ for $-1 \leq x \leq 1 \Rightarrow f'(x, -1) = 3x^2 - 3 = 0 \Rightarrow x = \pm 1$ and $y = -1$
 yielding the corner points $(-1, -1)$ and $(1, -1)$ with $f(-1, -1) = 2$ and $f(1, -1) = -2$
- (v) For the interior of the square, $f_x(x, y) = 3x^2 + 3y = 0$ and $f_y(x, y) = 3y^2 + 3x = 0 \Rightarrow y = -x^2$ and
 $x^4 + x = 0 \Rightarrow x = 0$ or $x = -1 \Rightarrow y = 0$ or $y = -1 \Rightarrow (0, 0)$ is an interior critical point of the square region
 with $f(0, 0) = 1$; $(-1, -1)$ is on the boundary. Therefore the absolute maximum is 6 at $(1, 1)$ and the
 absolute minimum is -2 at $(1, -1)$ and $(-1, 1)$.

79. $\nabla f = 3x^2\mathbf{i} + 2y\mathbf{j}$ and $\nabla g = 2x\mathbf{i} + 2y\mathbf{j}$ so that $\nabla f = \lambda \nabla g \Rightarrow 3x^2\mathbf{i} + 2y\mathbf{j} = \lambda(2x\mathbf{i} + 2y\mathbf{j}) \Rightarrow 3x^2 = 2x\lambda$ and
 $2y = 2y\lambda \Rightarrow \lambda = 1$ or $y = 0$.

CASE 1: $\lambda = 1 \Rightarrow 3x^2 = 2x \Rightarrow x = 0$ or $x = \frac{2}{3}$; $x = 0 \Rightarrow y = \pm 1$ yielding the points $(0, 1)$ and $(0, -1)$;

$$x = \frac{2}{3} \Rightarrow y = \pm \frac{\sqrt{5}}{3} \text{ yielding the points } \left(\frac{2}{3}, \frac{\sqrt{5}}{3}\right) \text{ and } \left(\frac{2}{3}, -\frac{\sqrt{5}}{3}\right).$$

CASE 2: $y = 0 \Rightarrow x^2 - 1 = 0 \Rightarrow x = \pm 1$ yielding the points $(1, 0)$ and $(-1, 0)$.

Evaluations give $f(0, \pm 1) = 1$, $f\left(\frac{2}{3}, \pm \frac{\sqrt{5}}{3}\right) = \frac{23}{27}$, $f(1, 0) = 1$, and $f(-1, 0) = -1$. Therefore the absolute
 maximum is 1 at $(0, \pm 1)$ and $(1, 0)$, and the absolute minimum is -1 at $(-1, 0)$.

80. $\nabla f = y\mathbf{i} + x\mathbf{j}$ and $\nabla g = 2x\mathbf{i} + 2y\mathbf{j}$ so that $\nabla f = \lambda \nabla g \Rightarrow y\mathbf{i} + x\mathbf{j} = \lambda(2x\mathbf{i} + 2y\mathbf{j}) \Rightarrow y = 2\lambda x$ and $xy = 2\lambda y$
 $\Rightarrow x = 2\lambda(2\lambda x) = 4\lambda^2 x \Rightarrow x = 0$ or $4\lambda^2 = 1$.

CASE 1: $x = 0 \Rightarrow y = 0$ but $(0, 0)$ does not lie on the circle, so no solution.

CASE 2: $4\lambda^2 = 1 \Rightarrow \lambda = \frac{1}{2}$ or $\lambda = -\frac{1}{2}$. For $\lambda = \frac{1}{2}$, $y = x \Rightarrow 1 = x^2 + y^2 = 2x^2 \Rightarrow x = y = \pm \frac{1}{\sqrt{2}}$ yielding the

$$\text{points } \left(\frac{1}{\sqrt{2}}, \frac{1}{\sqrt{2}}\right) \text{ and } \left(-\frac{1}{\sqrt{2}}, -\frac{1}{\sqrt{2}}\right). \text{ For } \lambda = -\frac{1}{2}, y = -x \Rightarrow 1 = x^2 + y^2 = 2x^2 \Rightarrow x = \pm \frac{1}{\sqrt{2}} \text{ and}$$

$$y = -x \text{ yielding the points } \left(-\frac{1}{\sqrt{2}}, \frac{1}{\sqrt{2}}\right) \text{ and } \left(\frac{1}{\sqrt{2}}, -\frac{1}{\sqrt{2}}\right).$$

Evaluations give the absolute maximum value $f\left(\frac{1}{\sqrt{2}}, \frac{1}{\sqrt{2}}\right) = f\left(-\frac{1}{\sqrt{2}}, -\frac{1}{\sqrt{2}}\right) = \frac{1}{2}$ and the absolute minimum

$$\text{value } f\left(-\frac{1}{\sqrt{2}}, \frac{1}{\sqrt{2}}\right) = f\left(\frac{1}{\sqrt{2}}, -\frac{1}{\sqrt{2}}\right) = -\frac{1}{2}.$$

81. (i) $f(x, y) = x^2 + 3y^2 + 2y$ on $x^2 + y^2 = 1 \Rightarrow \nabla f = 2x\mathbf{i} + (6y + 2)\mathbf{j}$ and $\nabla g = 2x\mathbf{i} + 2y\mathbf{j}$ so that
 $\nabla f = \lambda \nabla g \Rightarrow 2x\mathbf{i} + (6y + 2)\mathbf{j} = \lambda(2x\mathbf{i} + 2y\mathbf{j}) \Rightarrow 2x = 2x\lambda$ and $6y + 2 = 2y\lambda \Rightarrow \lambda = 1$ or $x = 0$.

CASE 1: $\lambda = 1 \Rightarrow 6y + 2 = 2y \Rightarrow y = -\frac{1}{2}$ and $x = \pm \frac{\sqrt{3}}{2}$ yielding the points $\left(\pm \frac{\sqrt{3}}{2}, -\frac{1}{2}\right)$.

CASE 2: $x = 0 \Rightarrow y^2 = 1 \Rightarrow y = \pm 1$ yielding the points $(0, \pm 1)$.

Evaluations give $f\left(\pm \frac{\sqrt{3}}{2}, -\frac{1}{2}\right) = \frac{1}{2}$, $f(0, 1) = 5$, and $f(0, -1) = 1$. Therefore $\frac{1}{2}$ and 5 are the extreme
 values on the boundary of the disk.

- (ii) For the interior of the disk, $f_x(x, y) = 2x = 0$ and $f_y(x, y) = 6y + 2 = 0 \Rightarrow x = 0$ and $y = -\frac{1}{3} \Rightarrow (0, -\frac{1}{3})$ is an interior critical point with $f(0, -\frac{1}{3}) = -\frac{1}{3}$. Therefore the absolute maximum of f on the disk is 5 at $(0, 1)$ and the absolute minimum of f on the disk is $-\frac{1}{3}$ at $(0, -\frac{1}{3})$.
82. (i) $f(x, y) = x^2 + y^2 - 3x - xy$ on $x^2 + y^2 = 9 \Rightarrow \nabla f = (2x - 3 - y)\mathbf{i} + (2y - x)\mathbf{j}$ and $\nabla g = 2x\mathbf{i} + 2y\mathbf{j}$ so that $\nabla f = \lambda \nabla g \Rightarrow (2x - 3 - y)\mathbf{i} + (2y - x)\mathbf{j} = \lambda(2x\mathbf{i} + 2y\mathbf{j}) \Rightarrow 2x - 3 - y = 2x\lambda$ and $2y - x = 2y\lambda$
 $\Rightarrow 2x(1 - \lambda) - y = 3$ and $-x + 2y(1 - \lambda) = 0 \Rightarrow 1 - \lambda = \frac{x}{2y}$ and $(2x)\left(\frac{x}{2y}\right) - y = 3 \Rightarrow x^2 - y^2 = 3y$
 $\Rightarrow x^2 = y^2 + 3y$. Thus, $9 = x^2 + y^2 = y^2 + 3y + y^2 \Rightarrow 2y^2 + 3y - 9 = 0 \Rightarrow (2y - 3)(y + 3) = 0$
 $\Rightarrow y = -3$ or $y = \frac{3}{2}$. For $y = -3$, $x^2 + y^2 = 9 \Rightarrow x = 0$ yielding the point $(0, -3)$. For $y = \frac{3}{2}$, $x^2 + y^2 = 9$
 $\Rightarrow x^2 + \frac{9}{4} = 9 \Rightarrow x^2 = \frac{27}{4} \Rightarrow x = \pm \frac{3\sqrt{3}}{2}$. Evaluations give $f(0, -3) = 9$, $f\left(-\frac{3\sqrt{3}}{2}, \frac{3}{2}\right) = 9 + \frac{27\sqrt{3}}{4} \approx 20.691$,
and $f\left(\frac{3\sqrt{3}}{2}, \frac{3}{2}\right) = 9 - \frac{27\sqrt{3}}{4} \approx -2.691$.
- (ii) For the interior of the disk, $f_x(x, y) = 2x - 3 - y = 0$ and $f_y(x, y) = 2y - x = 0 \Rightarrow x = 2$ and $y = 1 \Rightarrow (2, 1)$ is an interior critical point of the disk with $f(2, 1) = -3$. Therefore, the absolute maximum of f on the disk is $9 + \frac{27\sqrt{3}}{4}$ at $\left(-\frac{3\sqrt{3}}{2}, \frac{3}{2}\right)$ and the absolute minimum of f on the disk is -3 at $(2, 1)$.
83. $\nabla f = \mathbf{i} - \mathbf{j} + \mathbf{k}$ and $\nabla g = 2x\mathbf{i} + 2y\mathbf{j} + 2z\mathbf{k}$ so that $\nabla f = \lambda \nabla g \Rightarrow \mathbf{i} - \mathbf{j} + \mathbf{k} = \lambda(2x\mathbf{i} + 2y\mathbf{j} + 2z\mathbf{k}) \Rightarrow 1 = 2x\lambda$,
 $-1 = 2y\lambda$, $1 = 2z\lambda \Rightarrow x = -y = z = \frac{1}{\lambda}$. Thus $x^2 + y^2 + z^2 = 1 \Rightarrow 3x^2 = 1 \Rightarrow x = \pm \frac{1}{\sqrt{3}}$ yielding the points
 $\left(\frac{1}{\sqrt{3}}, -\frac{1}{\sqrt{3}}, \frac{1}{\sqrt{3}}\right)$ and $\left(-\frac{1}{\sqrt{3}}, \frac{1}{\sqrt{3}}, -\frac{1}{\sqrt{3}}\right)$. Evaluations give the absolute maximum value of
 $f\left(\frac{1}{\sqrt{3}}, -\frac{1}{\sqrt{3}}, \frac{1}{\sqrt{3}}\right) = \frac{3}{\sqrt{3}} = \sqrt{3}$ and the absolute minimum value of $f\left(-\frac{1}{\sqrt{3}}, \frac{1}{\sqrt{3}}, -\frac{1}{\sqrt{3}}\right) = -\sqrt{3}$.
84. Let $f(x, y, z) = x^2 + y^2 + z^2$ be the square of the distance to the origin and $g(x, y, z) = x^2 - zy - 4$. Then
 $\nabla f = 2x\mathbf{i} + 2y\mathbf{j} + 2z\mathbf{k}$ and $\nabla g = 2x\mathbf{i} - z\mathbf{j} - y\mathbf{k}$ so that $\nabla f = \lambda \nabla g \Rightarrow 2x = 2\lambda x$, $2y = -\lambda z$, and $2z = -\lambda y$
 $\Rightarrow x = 0$ or $\lambda = 1$.
- CASE 1: $x = 0 \Rightarrow zy = -4 \Rightarrow z = -\frac{4}{y}$ and $y = -\frac{4}{z} \Rightarrow 2\left(-\frac{4}{y}\right) = -\lambda\lambda$ and $2\left(-\frac{4}{z}\right) = -\lambda z \Rightarrow \frac{8}{\lambda} = y^2$ and
 $\frac{8}{\lambda} = z^2 \Rightarrow y^2 = z^2 \Rightarrow y = \pm z$. But $y = x \Rightarrow z^2 = -4$ leads to no solution, so $y = -z \Rightarrow z^2 = 4$
 $\Rightarrow z = \pm 2$ yielding the points $(0, -2, 2)$ and $(0, 2, -2)$.
- CASE 2: $\lambda = 1 \Rightarrow 2z = -y$ and $2y = -z \Rightarrow 2y = -\left(-\frac{y}{2}\right) \Rightarrow 4y = y \Rightarrow y = 0 \Rightarrow z = 0 \Rightarrow x^2 - 4 = 0$
 $\Rightarrow x = \pm 2$ yielding the points $(-2, 0, 0)$ and $(2, 0, 0)$.
- Evaluations give $f(0, -2, 2) = f(0, 2, -2) = 8$ and $f(-2, 0, 0) = f(2, 0, 0) = 4$. Thus the points $(-2, 0, 0)$ and $(2, 0, 0)$ on the surface are closest to the origin.
85. The cost is $f(x, y, z) = 2axy + 2bxz + 2cyz$ subject to the constraint $xyz = V$. Then $\nabla f = \lambda \nabla g$
 $\Rightarrow 2ay + 2bz = \lambda yz$, $2ax + 2cz = \lambda xz$, and $2bx + 2cy = \lambda xy \Rightarrow 2axy + 2bxz = \lambda xyz$, $2axy + 2cyz = \lambda xyz$, and
 $2bxz + 2cyz = \lambda xyz \Rightarrow 2axy + 2bxz = 2axy + 2cyz \Rightarrow y = \left(\frac{b}{c}\right)x$. Also $2axy + 2bxz = 2bxz + 2cyz \Rightarrow z = \left(\frac{a}{c}\right)x$.

Then $x\left(\frac{b}{c}x\right)\left(\frac{a}{c}x\right) = V \Rightarrow x^3 = \frac{c^2V}{ab} \Rightarrow \text{width} = x = \left(\frac{c^2V}{ab}\right)^{1/3}$, $\text{Depth} = y = \left(\frac{b}{c}\right)\left(\frac{c^2V}{ab}\right)^{1/3} = \left(\frac{b^2V}{ac}\right)^{1/3}$, and $\text{Height} = z = \left(\frac{a}{c}\right)\left(\frac{c^2V}{ab}\right)^{1/3} = \left(\frac{a^2V}{bc}\right)^{1/3}$.

86. The volume of the pyramid in the first octant formed by the plane is $V(a, b, c) = \frac{1}{3}\left(\frac{1}{2}ab\right)c = \frac{1}{6}abc$. The point $(2, 1, 2)$ on the plane $\Rightarrow \frac{2}{a} + \frac{1}{b} + \frac{2}{c} = 1$. We want to minimize V subject to the constraint $2bc + ac + 2ab = abc$. Thus, $\nabla V = \frac{bc}{6}\mathbf{i} + \frac{ac}{6}\mathbf{j} + \frac{ab}{6}\mathbf{k}$ and $\nabla g = (c + 2b - bc)\mathbf{i} + (2c + 2a - ac)\mathbf{j} + (2b + a - ab)\mathbf{k}$ so that $\nabla V = \lambda \nabla g \Rightarrow \frac{bc}{6} = \lambda(c + 2b - bc)$, $\frac{ac}{6} = \lambda(2c + 2a - ac)$, and $\frac{ab}{6} = \lambda(2b + a - ab) \Rightarrow \frac{abc}{6} = \lambda(ac + 2ab - abc)$, $\frac{abc}{6} = \lambda(2bc + 2ab - abc)$, and $\frac{abc}{6} = \lambda(2bc + ac - abc) \Rightarrow \lambda ac = 2\lambda bc$ and $2\lambda ab = 2\lambda bc$. Now $\lambda \neq 0$ since $a \neq 0, b \neq 0$, and $c \neq 0 \Rightarrow ac = 2bc$ and $ab = bc \Rightarrow a = 2b = c$. Substituting into the constraint equation gives $\frac{2}{a} + \frac{2}{a} + \frac{2}{a} = 1 \Rightarrow a = 6 \Rightarrow b = 3$ and $c = 6$. Therefore the desired plane is $\frac{x}{6} + \frac{y}{3} + \frac{z}{6} = 1$ or $x + 2y + z = 6$.

87. $\nabla f = (y + z)\mathbf{i} + x\mathbf{j} + x\mathbf{k}$, $\nabla g = 2x\mathbf{i} + 2y\mathbf{j}$, and $\nabla h = z\mathbf{i} + x\mathbf{k}$ so that $\nabla f = \lambda \nabla g + \mu \nabla h \Rightarrow (y + z)\mathbf{i} + x\mathbf{j} + x\mathbf{k} = \lambda(2x\mathbf{i} + 2y\mathbf{j}) + \mu(z\mathbf{i} + x\mathbf{k}) \Rightarrow y + z = 2\lambda x + \mu z, x = 2\lambda y, x = \mu z \Rightarrow x = 0$ or $\mu = 1$.

CASE 1: $x = 0$ which is impossible since $xz = 1$.

CASE 2: $\mu = 1 \Rightarrow y + z = 2\lambda x + z \Rightarrow y = 2\lambda x$ and $x = 2\lambda y \Rightarrow y = (2\lambda)(2\lambda y) \Rightarrow y = 0$ or $4\lambda^2 = 1$. If $y = 0$, then $x^2 = 1 \Rightarrow x = \pm 1$ so with $xz = 1$ we obtain the points $(1, 0, 1)$ and $(-1, 0, -1)$. If $4\lambda^2 = 1$, then $\lambda = \pm \frac{1}{2}$. For $\lambda = -\frac{1}{2}, y = -x$ so $x^2 + y^2 = 1 \Rightarrow x^2 = \frac{1}{2} \Rightarrow x = \pm \frac{1}{\sqrt{2}}$ with $xz = 1 \Rightarrow z = \pm\sqrt{2}$, and we obtain the points $\left(\frac{1}{\sqrt{2}}, -\frac{1}{\sqrt{2}}, \sqrt{2}\right)$ and $\left(-\frac{1}{\sqrt{2}}, \frac{1}{\sqrt{2}}, -\sqrt{2}\right)$. For $\lambda = \frac{1}{2}, y = x \Rightarrow x^2 = \frac{1}{2} \Rightarrow x = \pm \frac{1}{\sqrt{2}}$ with $xz = 1 \Rightarrow z = \pm\sqrt{2}$, and we obtain the points $\left(\frac{1}{\sqrt{2}}, \frac{1}{\sqrt{2}}, \sqrt{2}\right)$ and $\left(-\frac{1}{\sqrt{2}}, -\frac{1}{\sqrt{2}}, -\sqrt{2}\right)$.

Evaluations give $f(1, 0, 1) = 1, f(-1, 0, -1) = 1, f\left(\frac{1}{\sqrt{2}}, -\frac{1}{\sqrt{2}}, \sqrt{2}\right) = \frac{1}{2}, f\left(-\frac{1}{\sqrt{2}}, \frac{1}{\sqrt{2}}, -\sqrt{2}\right) = \frac{1}{2}, f\left(\frac{1}{\sqrt{2}}, \frac{1}{\sqrt{2}}, \sqrt{2}\right) = \frac{3}{2}$, and $f\left(-\frac{1}{\sqrt{2}}, -\frac{1}{\sqrt{2}}, -\sqrt{2}\right) = \frac{3}{2}$. Therefore the absolute maximum is $\frac{3}{2}$ at $\left(\frac{1}{\sqrt{2}}, \frac{1}{\sqrt{2}}, \sqrt{2}\right)$ and $\left(-\frac{1}{\sqrt{2}}, -\frac{1}{\sqrt{2}}, -\sqrt{2}\right)$, and the absolute minimum is $\frac{1}{2}$ at $\left(-\frac{1}{\sqrt{2}}, \frac{1}{\sqrt{2}}, -\sqrt{2}\right)$ and $\left(\frac{1}{\sqrt{2}}, -\frac{1}{\sqrt{2}}, \sqrt{2}\right)$.

88. Let $f(x, y, z) = x^2 + y^2 + z^2$ be the square of the distance to the origin. Then $\nabla f = 2x\mathbf{i} + 2y\mathbf{j} + 2z\mathbf{k}$, $\nabla g = \mathbf{i} + \mathbf{j} + \mathbf{k}$, and $\nabla h = 4x\mathbf{i} + 4y\mathbf{j} - 2z\mathbf{k}$ so that $\nabla f = \lambda \nabla g + \mu \nabla h \Rightarrow 2x = \lambda + 4x\mu, 2y = \lambda + 4y\mu$, and $2z = \lambda - 2z\mu \Rightarrow \lambda = 2x(1 - 2\mu) = 2y(1 - 2\mu) = 2z(1 + 2\mu) \Rightarrow x = y$ or $\mu = \frac{1}{2}$.

CASE 1: $x = y \Rightarrow z^2 = 4x^2 \Rightarrow z = \pm 2x$ so that $x + y + z = 1 \Rightarrow x + x + 2x = 1$ or $x + x - 2x = 1$ (impossible and $\Rightarrow x = \frac{1}{4} \Rightarrow y = \frac{1}{4}$ and $z = \frac{1}{2}$ yielding the point $\left(\frac{1}{4}, \frac{1}{4}, \frac{1}{2}\right)$.

CASE 2: $\mu = \frac{1}{2} \Rightarrow \lambda = 0 \Rightarrow 0 = 2z(1 + 1) \Rightarrow z = 0$ so that $2x^2 + 2y^2 = 0 \Rightarrow x = y = 0$. But the origin $(0, 0, 0)$ fails to satisfy the first constraint $x + y + z = 1$.

Therefore, the point $\left(\frac{1}{4}, \frac{1}{4}, \frac{1}{2}\right)$ on the curve of intersection is closest to the origin.

89. Note that $x = r \cos \theta$ and $y = r \sin \theta \Rightarrow r = \sqrt{x^2 + y^2}$ and $\theta = \tan^{-1}\left(\frac{y}{x}\right)$. Thus,

$$\frac{\partial w}{\partial x} = \frac{\partial w}{\partial r} \frac{\partial r}{\partial x} + \frac{\partial w}{\partial \theta} \frac{\partial \theta}{\partial x} = \left(\frac{\partial w}{\partial r}\right)\left(\frac{x}{\sqrt{x^2 + y^2}}\right) + \left(\frac{\partial w}{\partial \theta}\right)\left(\frac{-y}{x^2 + y^2}\right) = (\cos \theta) \frac{\partial w}{\partial r} - \left(\frac{\sin \theta}{r}\right) \frac{\partial w}{\partial \theta},$$

$$\frac{\partial w}{\partial y} = \frac{\partial w}{\partial r} \frac{\partial r}{\partial y} + \frac{\partial w}{\partial \theta} \frac{\partial \theta}{\partial y} = \left(\frac{\partial w}{\partial r}\right)\left(\frac{y}{\sqrt{x^2 + y^2}}\right) + \left(\frac{\partial w}{\partial \theta}\right)\left(\frac{x}{x^2 + y^2}\right) = (\sin \theta) \frac{\partial w}{\partial r} + \left(\frac{\cos \theta}{r}\right) \frac{\partial w}{\partial \theta}$$

90. $z_x = f_u \frac{\partial u}{\partial x} + f_v \frac{\partial v}{\partial x} = af_u + af_v$, and $z_y = f_u \frac{\partial u}{\partial y} + f_v \frac{\partial v}{\partial y} = bf_u - bf_v$

91. $\frac{\partial u}{\partial y} = b$ and $\frac{\partial u}{\partial x} = a \Rightarrow \frac{\partial w}{\partial x} = \frac{dw}{du} \frac{\partial u}{\partial x} = a \frac{dw}{du}$ and $\frac{\partial w}{\partial y} = \frac{dw}{du} \frac{\partial u}{\partial y} = b \frac{dw}{du} \Rightarrow \frac{1}{a} \frac{\partial w}{\partial x} = \frac{dw}{du}$ and $\frac{1}{b} \frac{\partial w}{\partial y} = \frac{dw}{du}$
 $\Rightarrow \frac{1}{a} \frac{\partial w}{\partial x} = \frac{1}{b} \frac{\partial w}{\partial y} \Rightarrow b \frac{\partial w}{\partial x} = a \frac{\partial w}{\partial y}$

92. $\frac{\partial w}{\partial x} = \frac{2x}{x^2 + y^2 + 2z} = \frac{2(r+s)}{(r+s)^2 + (r-s)^2 + 4rs} = \frac{2(r+s)}{2(r^2 + 2rs + s^2)} = \frac{1}{r+s}$, $\frac{\partial w}{\partial y} = \frac{2y}{x^2 + y^2 + 2z} = \frac{2(r-s)}{2(r+s)^2} = \frac{r-s}{(r+s)^2}$, and

$$\frac{\partial w}{\partial z} = \frac{2}{x^2 + y^2 + 2z} = \frac{1}{(r+s)^2} \Rightarrow \frac{\partial w}{\partial r} = \frac{\partial w}{\partial x} \frac{\partial x}{\partial r} + \frac{\partial w}{\partial y} \frac{\partial y}{\partial r} + \frac{\partial w}{\partial z} \frac{\partial z}{\partial r} = \frac{1}{r+s} + \frac{r-s}{(r+s)^2} + \left[\frac{1}{(r+s)^2}\right](2s) = \frac{2r+2s}{(r+s)^2} = \frac{2}{r+s}$$
 and

$$\frac{\partial w}{\partial s} = \frac{\partial w}{\partial x} \frac{\partial x}{\partial s} + \frac{\partial w}{\partial y} \frac{\partial y}{\partial s} + \frac{\partial w}{\partial z} \frac{\partial z}{\partial s} = \frac{1}{r+s} - \frac{r-s}{(r-s)^2} + \left[\frac{1}{(r+s)^2}\right](2r) = \frac{2}{r+s}$$

93. $e^u \cos v - x = 0 \Rightarrow (e^u \cos v) \frac{\partial u}{\partial x} - (e^u \sin v) \frac{\partial v}{\partial x} = 1$; $e^u \sin v - y = 0 \Rightarrow (e^u \sin v) \frac{\partial u}{\partial x} + (e^u \cos v) \frac{\partial v}{\partial x} = 0$. Solving this system yields $\frac{\partial u}{\partial x} = e^{-u} \cos v$ and $\frac{\partial v}{\partial x} = -e^{-u} \sin v$. Similarly, $e^u \cos v - x = 0 \Rightarrow (e^u \cos v) \frac{\partial u}{\partial y} - (e^u \sin v) \frac{\partial v}{\partial y} = 0$ and $e^u \sin v - y = 0 \Rightarrow (e^u \sin v) \frac{\partial u}{\partial y} + (e^u \cos v) \frac{\partial v}{\partial y} = 1$. Solving this second system yields $\frac{\partial u}{\partial y} = e^{-u} \sin v$ and $\frac{\partial v}{\partial y} = e^{-u} \cos v$. Therefore $\left(\frac{\partial u}{\partial x} \mathbf{i} + \frac{\partial u}{\partial y} \mathbf{j}\right) \cdot \left(\frac{\partial v}{\partial x} \mathbf{i} + \frac{\partial v}{\partial y} \mathbf{j}\right) = \left[\left(e^{-u} \cos v\right) \mathbf{i} + \left(e^{-u} \sin v\right) \mathbf{j}\right] \cdot \left[\left(-e^{-u} \sin v\right) \mathbf{i} + \left(e^{-u} \cos v\right) \mathbf{j}\right] = 0 \Rightarrow$ the vectors are orthogonal \Rightarrow the angle between the vectors is the constant $\frac{\pi}{2}$.

94. $\frac{\partial g}{\partial \theta} = \frac{\partial f}{\partial x} \frac{\partial x}{\partial \theta} + \frac{\partial f}{\partial y} \frac{\partial y}{\partial \theta} = (-r \sin \theta) \frac{\partial f}{\partial x} + (r \cos \theta) \frac{\partial f}{\partial y}$
 $\Rightarrow \frac{\partial^2 g}{\partial \theta^2} = (-r \sin \theta) \left(\frac{\partial^2 f}{\partial x^2} \frac{\partial x}{\partial \theta} + \frac{\partial^2 f}{\partial y \partial x} \frac{\partial y}{\partial \theta}\right) - (r \cos \theta) \frac{\partial f}{\partial x} + (r \cos \theta) \left(\frac{\partial^2 f}{\partial x \partial y} \frac{\partial x}{\partial \theta} + \frac{\partial^2 f}{\partial y^2} \frac{\partial y}{\partial \theta}\right) - (r \sin \theta) \frac{\partial f}{\partial y}$
 $= (-r \sin \theta) \left(\frac{\partial x}{\partial \theta} + \frac{\partial y}{\partial \theta}\right) - (r \cos \theta) + (r \cos \theta) \left(\frac{\partial x}{\partial \theta} + \frac{\partial y}{\partial \theta}\right) - (r \sin \theta)$
 $= (-r \sin \theta + r \cos \theta)(-r \sin \theta + r \cos \theta) - (r \cos \theta + r \sin \theta) = (-2)(-2) - (0 + 2) = 4 - 2 = 2$ at $(r, \theta) = \left(2, \frac{\pi}{2}\right)$.

95. $(y+z)^2 + (z-x)^2 = 16 \Rightarrow \nabla f = -2(z-x)\mathbf{i} + 2(y+z)\mathbf{j} + 2(y+2z-x)\mathbf{k}$; if the normal line is parallel to the yz -plane, then x is constant $\Rightarrow \frac{\partial f}{\partial x} = 0 \Rightarrow -2(z-x) = 0 \Rightarrow z = x \Rightarrow (y+z)^2 + (z-z)^2 = 16 \Rightarrow y+z = \pm 4$.
 Let $x = t \Rightarrow z = t \Rightarrow y = -t \pm 4$. Therefore the points are $(t, -t \pm 4, t)$, t a real number.

96. Let $f(x, y, z) = xy + yz + zx - x - z^2 = 0$. If the tangent plane is to be parallel to the xy -plane, then ∇f is perpendicular to the xy -plane $\Rightarrow \nabla f \cdot \mathbf{i} = 0$ and $\nabla f \cdot \mathbf{j} = 0$. Now $\nabla f = (y + z - 1)\mathbf{i} + (x + z)\mathbf{j} + (y + x - 2z)\mathbf{k}$ so that $\nabla f \cdot \mathbf{i} = y + z - 1 = 0 \Rightarrow y + z = 1 \Rightarrow y = 1 - z$, and $\nabla f \cdot \mathbf{j} = x + z = 0 \Rightarrow x = -z$. Then $-z(1 - z) + (1 - z)z + z(-z) - (-z) - z^2 = 0 \Rightarrow z - 2z^2 = 0 \Rightarrow z = \frac{1}{2}$ or $z = 0$. Now $z = \frac{1}{2} \Rightarrow x = -\frac{1}{2}$ and $y = \frac{1}{2} \Rightarrow (-\frac{1}{2}, \frac{1}{2}, \frac{1}{2})$ is one desired point; $z = 0 \Rightarrow x = 0$ and $y = 1 \Rightarrow (0, 1, 0)$ is a second desired point.

97. $\nabla f = \lambda(x\mathbf{i} + y\mathbf{j} + z\mathbf{k}) \Rightarrow \frac{\partial f}{\partial x} = \lambda x \Rightarrow f(x, y, z) = \frac{1}{2}\lambda x^2 + g(y, z)$ for some function $g \Rightarrow \lambda y = \frac{\partial f}{\partial y} = \frac{\partial g}{\partial y} \Rightarrow g(y, z) = \frac{1}{2}\lambda y^2 + h(z)$ for some function $h \Rightarrow \lambda z = \frac{\partial f}{\partial z} = \frac{\partial g}{\partial z} = h'(z) \Rightarrow h(z) = \frac{1}{2}\lambda z^2 + C$ for some arbitrary constant $C \Rightarrow g(y, z) = \frac{1}{2}\lambda y^2 + (\frac{1}{2}\lambda z^2 + C) \Rightarrow f(x, y, z) = \frac{1}{2}\lambda x^2 + \frac{1}{2}\lambda y^2 + \frac{1}{2}\lambda z^2 + C \Rightarrow f(0, 0, a) = \frac{1}{2}\lambda a^2 + C$ and $f(0, 0, -a) = \frac{1}{2}\lambda(-a)^2 + C \Rightarrow f(0, 0, a) = f(0, 0, -a)$ for any constant a , as claimed.

98. $\left(\frac{df}{ds}\right)_{\mathbf{u},(0,0,0)} = \lim_{s \rightarrow 0} \frac{f(0+su_1, 0+su_2, 0+su_3) - f(0, 0, 0)}{s}, s > 0$
 $= \lim_{s \rightarrow 0} \frac{\sqrt{s^2 u_1^2 + s^2 u_2^2 + s^2 u_3^2} - 0}{s}, s > 0$
 $= \lim_{s \rightarrow 0} \frac{s\sqrt{u_1^2 + u_2^2 + u_3^2}}{s} = \lim_{s \rightarrow 0} |\mathbf{u}| = 1;$

however, $\nabla f = \frac{x}{\sqrt{x^2 + y^2 + z^2}} \mathbf{i} + \frac{y}{\sqrt{x^2 + y^2 + z^2}} \mathbf{j} + \frac{z}{\sqrt{x^2 + y^2 + z^2}} \mathbf{k}$ fails to exist at the origin $(0, 0, 0)$

99. Let $f(x, y, z) = xy + z - 2 \Rightarrow \nabla f = y\mathbf{i} + x\mathbf{j} + \mathbf{k}$. At $(1, 1, 1)$, we have $\nabla f = \mathbf{i} + \mathbf{j} + \mathbf{k} \Rightarrow$ the normal line is $x = 1 + t, y = 1 + t, z = 1 + t$, so at $t = -1 \Rightarrow x = 0, y = 0, z = 0$ and the normal line passes through the origin.

100. (b) $f(x, y, z) = x^2 - y^2 + z^2 = 4 \Rightarrow \nabla f = 2x\mathbf{i} - 2y\mathbf{j} + 2z\mathbf{k}$
 \Rightarrow at $(2, -3, 3)$ the gradient is $\nabla f = 4\mathbf{i} + 6\mathbf{j} + 6\mathbf{k}$
 which is normal to the surface
 (c) Tangent plane: $4x + 6y + 6z = 8$ or $2x + 3y + 3z = 4$
 Normal line: $x = 2 + 4t, y = -3 + 6t, z = 3 + 6t$

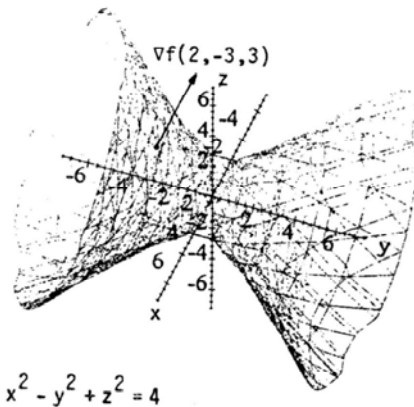

101. (a) y, z are independent with $w = x^2 e^{yz}$ and $z = x^2 - y^2 \Rightarrow \frac{\partial w}{\partial y} = \frac{\partial w}{\partial x} \frac{\partial x}{\partial y} + \frac{\partial w}{\partial y} \frac{\partial y}{\partial y} + \frac{\partial w}{\partial z} \frac{\partial z}{\partial y}$
 $= (2xe^{yz}) \frac{\partial x}{\partial y} + (zx^2 e^{yz})(1) + (yx^2 e^{yz})(0); z = x^2 - y^2 \Rightarrow 0 = 2x \frac{\partial x}{\partial y} - 2y \Rightarrow \frac{\partial x}{\partial y} = \frac{y}{x};$ therefore,
 $\left(\frac{\partial w}{\partial y}\right)_z = (2xe^{yz})\left(\frac{y}{x}\right) + zx^2 e^{yz} = (2y + zx^2) e^{yz}$

- (b) z, x are independent with $w = x^2 e^{yz}$ and $z = x^2 - y^2 \Rightarrow \frac{\partial w}{\partial z} = \frac{\partial w}{\partial x} \frac{\partial x}{\partial z} + \frac{\partial w}{\partial y} \frac{\partial y}{\partial z} + \frac{\partial w}{\partial z} \frac{\partial z}{\partial z}$
 $= (2xe^{yz})(0) + (zx^2 e^{yz}) \frac{\partial y}{\partial z} + (yx^2 e^{yz})(1)$; $z = x^2 - y^2 \Rightarrow 1 = 0 - 2y \frac{\partial y}{\partial z} \Rightarrow \frac{\partial y}{\partial z} = -\frac{1}{2y}$; therefore,
 $\left(\frac{\partial w}{\partial z}\right)_x = (zx^2 e^{yz})\left(-\frac{1}{2y}\right) + yx^2 e^{yz} = x^2 e^{yz} \left(y - \frac{z}{2y}\right)$
- (c) z, y are independent with $w = x^2 e^{yz}$ and $z = x^2 - y^2 \Rightarrow \frac{\partial w}{\partial z} = \frac{\partial w}{\partial x} \frac{\partial x}{\partial z} + \frac{\partial w}{\partial y} \frac{\partial y}{\partial z} + \frac{\partial w}{\partial z} \frac{\partial z}{\partial z}$
 $= (2xe^{yz}) \frac{\partial x}{\partial z} + (zx^2 e^{yz})(0) + (yx^2 e^{yz})(1)$; $z = x^2 - y^2 \Rightarrow 1 = 2x \frac{\partial x}{\partial z} - 0 \Rightarrow \frac{\partial x}{\partial z} = \frac{1}{2x}$; therefore,
 $\left(\frac{\partial w}{\partial z}\right)_y = (2xe^{yz})\left(\frac{1}{2x}\right) + yx^2 e^{yz} = (1 + x^2 y) e^{yz}$

102. (a) T, P are independent with $U = f(P, V, T)$ and $PV = nRT \Rightarrow \frac{\partial U}{\partial T} = \frac{\partial U}{\partial P} \frac{\partial P}{\partial T} + \frac{\partial U}{\partial V} \frac{\partial V}{\partial T} + \frac{\partial U}{\partial T} \frac{\partial T}{\partial T}$
 $= \left(\frac{\partial U}{\partial P}\right)(0) + \left(\frac{\partial U}{\partial V}\right)\left(\frac{\partial V}{\partial T}\right) + \left(\frac{\partial U}{\partial T}\right)(1)$; $PV = nRT \Rightarrow P \frac{\partial V}{\partial T} = nR \Rightarrow \frac{\partial V}{\partial T} = \frac{nR}{P}$; therefore,
 $\left(\frac{\partial U}{\partial T}\right)_P = \left(\frac{\partial U}{\partial V}\right)\left(\frac{nR}{P}\right) + \frac{\partial U}{\partial T}$
- (b) V, T are independent with $U = f(P, V, T)$ and $PV = nRT \Rightarrow \frac{\partial U}{\partial V} = \frac{\partial U}{\partial P} \frac{\partial P}{\partial V} + \frac{\partial U}{\partial V} \frac{\partial V}{\partial V} + \frac{\partial U}{\partial T} \frac{\partial T}{\partial V}$
 $= \left(\frac{\partial U}{\partial P}\right)\left(\frac{\partial P}{\partial V}\right) + \left(\frac{\partial U}{\partial V}\right)(1) + \left(\frac{\partial U}{\partial T}\right)(0)$; $PV = nRT \Rightarrow V \frac{\partial P}{\partial V} + P = (nR)\left(\frac{\partial T}{\partial V}\right) = 0 \Rightarrow \frac{\partial P}{\partial V} = -\frac{P}{V}$; therefore,
 $\left(\frac{\partial U}{\partial V}\right)_T = \left(\frac{\partial U}{\partial P}\right)\left(-\frac{P}{V}\right) + \frac{\partial U}{\partial V}$

CHAPTER 14 ADDITIONAL AND ADVANCED EXERCISES

1. By definition, $f_{xy}(0, 0) = \lim_{h \rightarrow 0} \frac{f_x(0, h) - f_x(0, 0)}{h}$ so we need to calculate the first partial derivatives in the numerator. For $(x, y) \neq (0, 0)$ we calculate $f_x(x, y)$ by applying the differentiation rules to the formula for $f(x, y)$: $f_x(x, y) = \frac{x^2 y - y^3}{x^2 + y^2} + (xy) \frac{(x^2 + y^2)(2x) - (x^2 - y^2)(2x)}{(x^2 + y^2)^2} = \frac{x^2 y - y^3}{x^2 + y^2} + \frac{4x^2 y^3}{(x^2 + y^2)^2} \xrightarrow{x \rightarrow 0} f(0, h) = \frac{h^3}{h^2} = -h$. For $(x, y) = (0, 0)$ we apply the definition: $f_x(0, 0) = \lim_{h \rightarrow 0} \frac{f(h, 0) - f(0, 0)}{h} = \lim_{h \rightarrow 0} \frac{0 - 0}{h} = 0$. Then by definition $f_{xy}(0, 0) = \lim_{h \rightarrow 0} \frac{-h - 0}{h} = -1$. Similarly, $f_{yx}(0, 0) = \lim_{h \rightarrow 0} \frac{f_y(h, 0) - f_y(0, 0)}{h}$, so for $(x, y) \neq (0, 0)$ we have $f_y(x, y) = \frac{x^3 - xy^2}{x^2 + y^2} - \frac{4x^3 y^2}{(x^2 + y^2)^2} \Rightarrow f_y(h, 0) = \frac{h^3}{h^2} = h$; for $(x, y) = (0, 0)$ we obtain $f_y(0, 0) = \lim_{h \rightarrow 0} \frac{f(0, h) - f(0, 0)}{h} = \lim_{h \rightarrow 0} \frac{0 - 0}{h} = 0$. Then by definition $f_{yx}(0, 0) = \lim_{h \rightarrow 0} \frac{h - 0}{h} = 1$. Note that $f_{xy}(0, 0) \neq f_{yx}(0, 0)$ in this case.
2. $\frac{\partial w}{\partial x} = 1 + e^x \cos y \Rightarrow w = x + e^x \cos y + g(y)$; $\frac{\partial w}{\partial y} = -e^x \sin y + g'(y) = 2y - e^x \sin y \Rightarrow g'(y) = 2y$
 $\Rightarrow g(y) = y^2 + C$; $w = \ln 2$ when $x = \ln 2$ and $y = 0 \Rightarrow \ln 2 = \ln 2 + e^{\ln 2} \cos 0 + 0^2 + C \Rightarrow 0 = 2 + C$
 $\Rightarrow C = -2$. Thus, $w = x + e^x \cos y + g(y) = x + e^x \cos y + y^2 - 2$.

3. Substitution of $u = u(x)$ and $v = v(x)$ in $g(u, v)$ gives $g(u(x), v(x))$ which is a function of the independent

$$\begin{aligned} \text{variable } x. \text{ Then, } g(u, v) &= \int_u^v f(t) dt \Rightarrow \frac{dg}{dx} = \frac{\partial g}{\partial u} \frac{du}{dx} + \frac{\partial g}{\partial v} \frac{dv}{dx} = \left(\frac{\partial}{\partial u} \int_u^v f(t) dt \right) \frac{du}{dx} + \left(\frac{\partial}{\partial v} \int_u^v f(t) dt \right) \frac{dv}{dx} \\ &= \left(-\frac{\partial}{\partial u} \int_u^u f(t) dt \right) \frac{du}{dx} + \left(\frac{\partial}{\partial v} \int_u^v f(t) dt \right) \frac{dv}{dx} = -f(u(x)) \frac{du}{dx} + f(v(x)) \frac{dv}{dx} = f(v(x)) \frac{dv}{dx} - f(u(x)) \frac{du}{dx} \end{aligned}$$

4. Applying the chain rules, $f_x = \frac{df}{dr} \frac{\partial r}{\partial x} \Rightarrow f_{xx} = \left(\frac{d^2 f}{dr^2} \right) \left(\frac{\partial r}{\partial x} \right)^2 + \frac{df}{dr} \frac{\partial^2 r}{\partial x^2}$. Similarly, $f_{yy} = \left(\frac{d^2 f}{dr^2} \right) \left(\frac{\partial r}{\partial y} \right)^2 + \frac{df}{dr} \frac{\partial^2 r}{\partial y^2}$ and

$$\begin{aligned} f_{zz} &= \left(\frac{d^2 f}{dr^2} \right) \left(\frac{\partial r}{\partial z} \right)^2 + \frac{df}{dr} \frac{\partial^2 r}{\partial z^2}. \text{ Moreover, } \frac{\partial r}{\partial x} = \frac{x}{\sqrt{x^2+y^2+z^2}} \Rightarrow \frac{\partial^2 r}{\partial x^2} = \frac{y^2+z^2}{(\sqrt{x^2+y^2+z^2})^3}, \frac{\partial r}{\partial y} = \frac{y}{\sqrt{x^2+y^2+z^2}} \\ \Rightarrow \frac{\partial^2 r}{\partial y^2} &= \frac{x^2+z^2}{(\sqrt{x^2+y^2+z^2})^3}; \text{ and } \frac{\partial r}{\partial z} = \frac{z}{\sqrt{x^2+y^2+z^2}} \Rightarrow \frac{\partial^2 r}{\partial z^2} = \frac{x^2+y^2}{(\sqrt{x^2+y^2+z^2})^3}. \text{ Next, } f_{xx} + f_{yy} + f_{zz} = 0 \\ \Rightarrow \left(\frac{d^2 f}{dr^2} \right) &\left(\frac{x^2}{x^2+y^2+z^2} \right) + \left(\frac{df}{dr} \right) \left(\frac{y^2+z^2}{(\sqrt{x^2+y^2+z^2})^3} \right) + \left(\frac{d^2 f}{dr^2} \right) \left(\frac{y^2}{x^2+y^2+z^2} \right) + \left(\frac{df}{dr} \right) \left(\frac{x^2+z^2}{(\sqrt{x^2+y^2+z^2})^3} \right) \\ &+ \left(\frac{d^2 f}{dr^2} \right) \left(\frac{z^2}{x^2+y^2+z^2} \right) + \left(\frac{df}{dr} \right) \left(\frac{x^2+y^2}{(\sqrt{x^2+y^2+z^2})^3} \right) = 0 \Rightarrow \frac{d^2 f}{dr^2} + \left(\frac{2}{\sqrt{x^2+y^2+z^2}} \right) \frac{df}{dr} = 0 \Rightarrow \frac{d^2 f}{dr^2} + \frac{2}{r} \frac{df}{dr} = 0 \\ \Rightarrow \frac{d}{dr} (f') &= \left(-\frac{2}{r} \right) f', \text{ where } f' = \frac{df}{dr} \Rightarrow \frac{df'}{f'} = -\frac{2}{r} dr \Rightarrow \ln f' = -2 \ln r + \ln C \Rightarrow f' = Cr^{-2}, \text{ or} \\ \frac{df}{dr} = Cr^{-2} &\Rightarrow f(r) = -\frac{C}{r} + b = \frac{a}{r} + b \text{ for some constants } a \text{ and } b \text{ (setting } a = -C) \end{aligned}$$

5. (a) Let $u = tx, v = ty$, and $w = f(u, v) = f(u(t, x), v(t, y)) = f(tx, ty) = t^n f(x, y)$, where t, x , and y are

$$\begin{aligned} \text{independent variables. Then } nt^{n-1} f(x, y) &= \frac{\partial w}{\partial t} = \frac{\partial w}{\partial u} \frac{\partial u}{\partial t} + \frac{\partial w}{\partial v} \frac{\partial v}{\partial t} = x \frac{\partial w}{\partial u} + y \frac{\partial w}{\partial v}. \text{ Now, } \frac{\partial w}{\partial x} = \frac{\partial w}{\partial u} \frac{\partial u}{\partial x} + \frac{\partial w}{\partial v} \frac{\partial v}{\partial x} \\ &= \left(\frac{\partial w}{\partial u} \right) (t) + \left(\frac{\partial w}{\partial v} \right) (0) = t \frac{\partial w}{\partial u} \Rightarrow \frac{\partial w}{\partial u} = \left(\frac{1}{t} \right) \left(\frac{\partial w}{\partial x} \right). \text{ Likewise, } \frac{\partial w}{\partial y} = \frac{\partial w}{\partial u} \frac{\partial u}{\partial y} + \frac{\partial w}{\partial v} \frac{\partial v}{\partial y} = \left(\frac{\partial w}{\partial u} \right) (0) + \left(\frac{\partial w}{\partial v} \right) (t) \\ \Rightarrow \frac{\partial w}{\partial v} &= \left(\frac{1}{t} \right) \left(\frac{\partial w}{\partial y} \right). \text{ Therefore, } nt^{n-1} f(x, y) = x \frac{\partial w}{\partial u} + y \frac{\partial w}{\partial v} = \left(\frac{x}{t} \right) \left(\frac{\partial w}{\partial x} \right) + \left(\frac{y}{t} \right) \left(\frac{\partial w}{\partial y} \right). \text{ When } t = 1, u = x, v = y, \\ \text{and } w = f(x, y) &\Rightarrow \frac{\partial w}{\partial x} = \frac{\partial f}{\partial x} \text{ and } \frac{\partial w}{\partial y} = \frac{\partial f}{\partial y} \Rightarrow nf(x, y) = x \frac{\partial f}{\partial x} + y \frac{\partial f}{\partial y}, \text{ as claimed.} \end{aligned}$$

(b) From part (a), $nt^{n-1} f(x, y) = x \frac{\partial w}{\partial u} + y \frac{\partial w}{\partial v}$. Differentiating with respect to t again we obtain

$$\begin{aligned} n(n-1)t^{n-2} f(x, y) &= x \frac{\partial^2 w}{\partial u^2} \frac{\partial u}{\partial t} + x \frac{\partial^2 w}{\partial v \partial u} \frac{\partial v}{\partial t} + y \frac{\partial^2 w}{\partial u \partial v} \frac{\partial v}{\partial t} + y \frac{\partial^2 w}{\partial v^2} \frac{\partial v}{\partial t} = x^2 \frac{\partial^2 w}{\partial u^2} + 2xy \frac{\partial^2 w}{\partial u \partial v} + y^2 \frac{\partial^2 w}{\partial v^2}. \text{ Also from} \\ \text{part (a), } \frac{\partial^2 w}{\partial x^2} &= \frac{\partial}{\partial x} \left(\frac{\partial w}{\partial x} \right) = \frac{\partial}{\partial x} \left(t \frac{\partial w}{\partial u} \right) = t \frac{\partial^2 w}{\partial u^2} \frac{\partial u}{\partial x} + t \frac{\partial^2 w}{\partial v \partial u} \frac{\partial v}{\partial x} = t^2 \frac{\partial^2 w}{\partial u^2}, \frac{\partial^2 w}{\partial y^2} = \frac{\partial}{\partial y} \left(\frac{\partial w}{\partial y} \right) = \frac{\partial}{\partial y} \left(t \frac{\partial w}{\partial v} \right) \\ &= t \frac{\partial^2 w}{\partial u \partial v} \frac{\partial u}{\partial y} + t \frac{\partial^2 w}{\partial v^2} \frac{\partial v}{\partial y} = t^2 \frac{\partial^2 w}{\partial v^2}, \text{ and } \frac{\partial^2 w}{\partial y \partial x} = \frac{\partial}{\partial y} \left(\frac{\partial w}{\partial x} \right) = \frac{\partial}{\partial y} \left(t \frac{\partial w}{\partial u} \right) = t \frac{\partial^2 w}{\partial u^2} \frac{\partial u}{\partial y} + t \frac{\partial^2 w}{\partial v \partial u} \frac{\partial v}{\partial y} = t^2 \frac{\partial^2 w}{\partial v \partial u} \\ \Rightarrow \left(\frac{1}{t^2} \right) \frac{\partial^2 w}{\partial x^2} &= \frac{\partial^2 w}{\partial u^2}, \left(\frac{1}{t^2} \right) \frac{\partial^2 w}{\partial y^2} = \frac{\partial^2 w}{\partial v^2}, \text{ and } \left(\frac{1}{t^2} \right) \frac{\partial^2 w}{\partial y \partial x} = \frac{\partial^2 w}{\partial v \partial u} \\ \Rightarrow n(n-1)t^{n-2} f(x, y) &= \left(\frac{x^2}{t^2} \right) \left(\frac{\partial^2 w}{\partial u^2} \right) + \left(\frac{2xy}{t^2} \right) \left(\frac{\partial^2 w}{\partial v \partial u} \right) + \left(\frac{y^2}{t^2} \right) \left(\frac{\partial^2 w}{\partial v^2} \right) \text{ for } t \neq 0. \end{aligned}$$

$$\text{When } t = 1, w = f(x, y) \text{ and we have } n(n-1)f(x, y) = x^2 \left(\frac{\partial^2 f}{\partial x^2} \right) + 2xy \left(\frac{\partial^2 f}{\partial x \partial y} \right) + y^2 \left(\frac{\partial^2 f}{\partial y^2} \right) \text{ as claimed.}$$

6. (a) $\lim_{r \rightarrow 0} \frac{\sin 6r}{6r} = \lim_{t \rightarrow 0} \frac{\sin t}{t} = 1$, where $t = 6r$
- (b) $f_r(0, 0) = \lim_{h \rightarrow 0} \frac{f(0+h, 0) - f(0, 0)}{h} = \lim_{h \rightarrow 0} \frac{\left(\frac{\sin 6h}{6h}\right)^{-1} - 1}{h} = \lim_{h \rightarrow 0} \frac{\sin 6h - 6h}{6h^2} = \lim_{h \rightarrow 0} \frac{\cos 6h - 6}{12h} = \lim_{h \rightarrow 0} \frac{-36 \sin 6h}{12} = 0$
 (applying l'Hôpital's rule twice)
- (c) $f_\theta(r, \theta) = \lim_{h \rightarrow 0} \frac{f(r, \theta+h) - f(r, \theta)}{h} = \lim_{h \rightarrow 0} \frac{\left(\frac{\sin 6r}{6r}\right) - \left(\frac{\sin 6r}{6r}\right)}{h} = \lim_{h \rightarrow 0} \frac{0}{h} = 0$
7. (a) $\mathbf{r} = x\mathbf{i} + y\mathbf{j} + z\mathbf{k} \Rightarrow r = |\mathbf{r}| = \sqrt{x^2 + y^2 + z^2}$ and $\nabla r = \frac{x}{\sqrt{x^2 + y^2 + z^2}}\mathbf{i} + \frac{y}{\sqrt{x^2 + y^2 + z^2}}\mathbf{j} + \frac{z}{\sqrt{x^2 + y^2 + z^2}}\mathbf{k} = \frac{\mathbf{r}}{r}$
- (b) $r^n = \left(\sqrt{x^2 + y^2 + z^2}\right)^n$
 $\Rightarrow \nabla(r^n) = nx(x^2 + y^2 + z^2)^{(n/2)-1}\mathbf{i} + ny(x^2 + y^2 + z^2)^{(n/2)-1}\mathbf{j} + nz(x^2 + y^2 + z^2)^{(n/2)-1}\mathbf{k} = nr^{n-2}\mathbf{r}$
- (c) Let $n = 2$ in part (b). Then $\frac{1}{2}\nabla(r^2) = \mathbf{r} \Rightarrow \nabla\left(\frac{1}{2}r^2\right) = \mathbf{r} \Rightarrow \frac{r^2}{2} = \frac{1}{2}(x^2 + y^2 + z^2)$ is the function.
- (d) $d\mathbf{r} = dx\mathbf{i} + dy\mathbf{j} + dz\mathbf{k} \Rightarrow \mathbf{r} \cdot d\mathbf{r} = x dx + y dy + z dz$, and $dr = r_x dx + r_y dy + r_z dz = \frac{x}{r} dx + \frac{y}{r} dy + \frac{z}{r} dz$
 $\Rightarrow r dr = x dx + y dy + z dz = \mathbf{r} \cdot d\mathbf{r}$
- (e) $\mathbf{A} = a\mathbf{i} + b\mathbf{j} + c\mathbf{k} \Rightarrow \mathbf{A} \cdot \mathbf{r} = ax + by + cz \Rightarrow \nabla(\mathbf{A} \cdot \mathbf{r}) = a\mathbf{i} + b\mathbf{j} + c\mathbf{k} = \mathbf{A}$
8. $f(g(t), h(t)) = c \Rightarrow 0 = \frac{df}{dt} = \frac{\partial f}{\partial x} \frac{dx}{dt} + \frac{\partial f}{\partial y} \frac{dy}{dt} = \left(\frac{\partial f}{\partial x}\mathbf{i} + \frac{\partial f}{\partial y}\mathbf{j}\right) \cdot \left(\frac{dx}{dt}\mathbf{i} + \frac{dy}{dt}\mathbf{j}\right)$, where $\frac{dx}{dt}\mathbf{i} + \frac{dy}{dt}\mathbf{j}$ is the tangent vector
 $\Rightarrow \nabla f$ is orthogonal to the tangent vector
9. $f(x, y, z) = xy^2 - yz + \cos xy - 1 \Rightarrow \nabla f = (z^2 - y \sin xy)\mathbf{i} + (-z - x \sin xy)\mathbf{j} + (2xz - y)\mathbf{k} \Rightarrow \nabla f(0, 0, 1) = \mathbf{i} - \mathbf{j}$
 \Rightarrow the tangent plane is $x - y = 0$; $\mathbf{r} = (\ln t)\mathbf{i} + (t \ln t)\mathbf{j} + t\mathbf{k} \Rightarrow \mathbf{r}' = \left(\frac{1}{t}\right)\mathbf{i} + (\ln t + 1)\mathbf{j} + \mathbf{k}$; $x = y = 0, z = 1$
 $\Rightarrow t = 1 \Rightarrow \mathbf{r}'(1) = \mathbf{i} + \mathbf{j} + \mathbf{k}$. Since $(\mathbf{i} + \mathbf{j} + \mathbf{k}) \cdot (\mathbf{i} - \mathbf{j}) = \mathbf{r}'(1) \cdot \nabla f = 0$, \mathbf{r}' is parallel to the plane, and
 $\mathbf{r}(1) = 0\mathbf{i} + 0\mathbf{j} + \mathbf{k} \Rightarrow \mathbf{r}$ is contained in the plane.
10. Let $f(x, y, z) = x^3 + y^3 + z^3 - xyz \Rightarrow \nabla f = (3x^2 - yz)\mathbf{i} + (3y^2 - xz)\mathbf{j} + (3z^2 - xy)\mathbf{k}$
 $\Rightarrow \nabla f(0, -1, 1) = \mathbf{i} + 3\mathbf{j} + 3\mathbf{k} \Rightarrow$ the tangent plane is $x + 3y + 3z = 0$; $\mathbf{r} = \left(\frac{t^3}{4} - 2\right)\mathbf{i} + \left(\frac{4}{t} - 3\right)\mathbf{j} + (\cos(t-2))\mathbf{k}$
 $\Rightarrow \mathbf{r}' = \left(\frac{3t^2}{4}\right)\mathbf{i} - \left(\frac{4}{t^2}\right)\mathbf{j} - (\sin(t-2))\mathbf{k}$; $x = 0, y = -1, z = 1 \Rightarrow t = 2 \Rightarrow \mathbf{r}'(2) = 3\mathbf{i} - \mathbf{j}$. Since $\mathbf{r}'(2) \cdot \nabla f = 0 \Rightarrow \mathbf{r}'$ is parallel to the plane, and $\mathbf{r}(2) = -\mathbf{i} + \mathbf{k} \Rightarrow \mathbf{r}$ is contained in the plane.
11. $\frac{\partial z}{\partial x} = 3x^2 - 9y = 0$ and $\frac{\partial z}{\partial x} = 3y^2 - 9x = 0 \Rightarrow y = \frac{1}{3}x^2$ and $3\left(\frac{1}{3}x^2\right)^2 - 9x = 0 \Rightarrow \frac{1}{3}x^4 - 9x = 0$
 $\Rightarrow x(x^3 - 27) = 0 \Rightarrow x = 0$ or $x = 3$. Now $x = 0 \Rightarrow y = 0$ or $(0, 0)$ and $x = 3 \Rightarrow y = 3$ or $(3, 3)$. Next
 $\frac{\partial^2 z}{\partial x^2} = 6x, \frac{\partial^2 z}{\partial y^2} = 6y$, and $\frac{\partial^2 z}{\partial x \partial y} = -9$. For $(0, 0), \frac{\partial^2 z}{\partial x^2} \frac{\partial^2 z}{\partial y^2} - \left(\frac{\partial^2 z}{\partial x \partial y}\right)^2 = -81 \Rightarrow$ no extremum (a saddle point), and
 for $(3, 3), \frac{\partial^2 z}{\partial x^2} \frac{\partial^2 z}{\partial y^2} - \left(\frac{\partial^2 z}{\partial x \partial y}\right)^2 = 243 > 0$ and $\frac{\partial^2 z}{\partial x^2} = 18 > 0 \Rightarrow$ a local minimum.

12. $f(x, y) = 6xye^{-(2x+3y)} \Rightarrow f_x(x, y) = 6y(1-2x)e^{-(2x+3y)} = 0$ and $f_y(x, y) = 6x(1-3y)e^{-(2x+3y)} = 0 \Rightarrow x = 0$ and $y = 0$, or $x = \frac{1}{2}$ and $y = \frac{1}{3}$. The value $f(0, 0) = 0$ is on the boundary, and $f\left(\frac{1}{2}, \frac{1}{3}\right) = \frac{1}{e^2}$. On the positive y -axis, $f(0, y) = 0$, and on the positive x -axis, $f(x, 0) = 0$. As $x \rightarrow \infty$ or $y \rightarrow \infty$ we see that $f(x, y) \rightarrow 0$. Thus the absolute maximum of f in the closed first quadrant is $\frac{1}{e^2}$ at the point $\left(\frac{1}{2}, \frac{1}{3}\right)$.

13. Let $f(x, y, z) = \frac{x^2}{a^2} + \frac{y^2}{b^2} + \frac{z^2}{c^2} - 1 \Rightarrow \nabla f = \frac{2x}{a^2} \mathbf{i} + \frac{2y}{b^2} \mathbf{j} + \frac{2z}{c^2} \mathbf{k} \Rightarrow$ an equation of the plane tangent at the point $P_0(x_0, y_0, z_0)$ is $\left(\frac{2x_0}{a^2}\right)x + \left(\frac{2y_0}{b^2}\right)y + \left(\frac{2z_0}{c^2}\right)z = \frac{2x_0^2}{a^2} + \frac{2y_0^2}{b^2} + \frac{2z_0^2}{c^2} = 2$ or $\left(\frac{x_0}{a^2}\right)x + \left(\frac{y_0}{b^2}\right)y + \left(\frac{z_0}{c^2}\right)z = 1$. The intercepts of the plane are $\left(\frac{a^2}{x_0}, 0, 0\right)$, $\left(0, \frac{b^2}{y_0}, 0\right)$ and $\left(0, 0, \frac{c^2}{z_0}\right)$. The volume of the tetrahedron formed by the plane and the coordinate planes is $V = \left(\frac{1}{3}\right)\left(\frac{1}{2}\right)\left(\frac{a^2}{x_0}\right)\left(\frac{b^2}{y_0}\right)\left(\frac{c^2}{z_0}\right) \Rightarrow$ we need to maximize $V(x, y, z) = \frac{(abc)^2}{6}(xyz)^{-1}$ subject to the constraint $f(x, y, z) = \frac{x^2}{a^2} + \frac{y^2}{b^2} + \frac{z^2}{c^2} = 1$. Thus, $\left[-\frac{(abc)^2}{6}\right]\left(\frac{1}{x^2yz}\right) = \frac{2x}{a^2} \lambda$, $\left[-\frac{(abc)^2}{6}\right]\left(\frac{1}{xy^2z}\right) = \frac{2y}{b^2} \lambda$, and $\left[-\frac{(abc)^2}{6}\right]\left(\frac{1}{xyz^2}\right) = \frac{2z}{c^2} \lambda$. Multiply the first equation by a^2yz , the second by b^2xz , and the third by c^2xy . Then equate the first and second $\Rightarrow a^2y^2 = b^2x^2 \Rightarrow y = \frac{b}{a}x, x > 0$; equate the first and third $\Rightarrow a^2z^2 = c^2x^2 \Rightarrow z = \frac{c}{a}x, x > 0$; substitute into $f(x, y, z) = 0 \Rightarrow x = \frac{a}{\sqrt{3}} \Rightarrow y = \frac{b}{\sqrt{3}} \Rightarrow z = \frac{c}{\sqrt{3}} \Rightarrow V = \frac{\sqrt{3}}{2} abc$.

14. $2(x-u) = -\lambda, 2(y-v) = \lambda, -2(x-u) = \mu,$ and $-2(y-v) = -2\mu v \Rightarrow x-u = v-y, x-u = -\frac{\mu}{2},$ and $y-v = \mu v \Rightarrow x-u = -\mu v = -\frac{\mu}{2} \Rightarrow v = \frac{1}{2}$ or $\mu = 0$.

CASE 1: $\mu = 0 \Rightarrow x = u, y = v,$ and $\lambda = 0$; then $y = x+1 \Rightarrow v = u+1$ and $v^2 = u \Rightarrow v = v^2 + 1 \Rightarrow v^2 - v + 1 = 0 \Rightarrow v = \frac{1 \pm \sqrt{1-4}}{2} \Rightarrow$ no real solution.

CASE 2: $v = \frac{1}{2}$ and $u = v^2 \Rightarrow u = \frac{1}{4}; x - \frac{1}{4} = \frac{1}{2} - y$ and $y = x+1 \Rightarrow x - \frac{1}{4} = -x - \frac{1}{2} \Rightarrow 2x = -\frac{1}{4} \Rightarrow x = -\frac{1}{8} \Rightarrow y = \frac{7}{8}$.

Then $f\left(-\frac{1}{8}, \frac{7}{8}, \frac{1}{4}, \frac{1}{2}\right) = \left(-\frac{1}{8} - \frac{1}{4}\right)^2 + \left(\frac{7}{8} - \frac{1}{2}\right)^2 = 2\left(\frac{3}{8}\right)^2 \Rightarrow$ the minimum distance is $\frac{3}{8}\sqrt{2}$. (Notice that f has no maximum value.)

15. Let (x_0, y_0) be any point in R . We must show $\lim_{(x,y) \rightarrow (x_0,y_0)} f(x, y) = f(x_0, y_0)$ or, equivalently that

$\lim_{(h,k) \rightarrow (0,0)} |f(x_0+h, y_0+k) - f(x_0, y_0)| = 0$. Consider $f(x_0+h, y_0+k) - f(x_0, y_0) = [f(x_0+h, y_0+k) - f(x_0, y_0+k)] + [f(x_0, y_0+k) - f(x_0, y_0)]$. Let $F(x) = f(x, y_0+k)$ and apply the Mean Value Theorem: there exists ξ with $x_0 < \xi < x_0+h$ such that $F'(\xi)h = F(x_0+h) - F(x_0) \Rightarrow hf'_x(\xi, y_0+k) = f(x_0+h, y_0+k) - f(x_0, y_0+k)$. Similarly, $k f'_y(x_0, \eta) = f(x_0, y_0+k) - f(x_0, y_0)$ for some η with $y_0 < \eta < y_0+k$. Then $|f(x_0+h, y_0+k) - f(x_0, y_0)| \leq |hf'_x(\xi, y_0+k)| + |k f'_y(x_0, \eta)|$. If M, N are positive real numbers such that $|f'_x| \leq M$ and $|f'_y| \leq N$ for all (x, y) in the xy -plane, then

$$|f(x_0 + h, y_0 + k) - f(x_0, y_0)| \leq M|h| + N|k|. \text{ As } |(h, k) \rightarrow 0, |f(x_0 + h, y_0 + k) - f(x_0, y_0)| \rightarrow 0 \\ \Rightarrow \lim_{(h, k) \rightarrow (0, 0)} |f(x_0 + h, y_0 + k) - f(x_0, y_0)| = 0 \Rightarrow f \text{ is continuous at } (x_0, y_0).$$

16. At extreme values, ∇f and $\mathbf{v} = \frac{d\mathbf{r}}{dt}$ are orthogonal because $\frac{df}{dt} = \nabla f \cdot \frac{d\mathbf{r}}{dt} = 0$ by the First Derivative Theorem for Local Extreme Values.

17. $\frac{\partial f}{\partial x} = 0 \Rightarrow f(x, y) = h(y)$ is a function of y only. Also, $\frac{\partial g}{\partial y} = \frac{\partial f}{\partial x} = 0 \Rightarrow g(x, y) = k(x)$ is a function of x only.

Moreover, $\frac{\partial f}{\partial y} = \frac{\partial g}{\partial x} \Rightarrow h'(y) = k'(x)$ for all x and y . This can happen only if $h'(y) = k'(x) = c$ is a constant.

Integration gives $h(y) = cy + c_1$ and $k(x) = cx + c_2$, where c_1 and c_2 are constants. Therefore $f(x, y) = cy + c_1$ and $g(x, y) = cx + c_2$. Then $f(1, 2) = g(1, 2) = 5 \Rightarrow 5 = 2c + c_1 = c + c_2$, and $f(0, 0) = 4 \Rightarrow c_1 = 4 \Rightarrow c = \frac{1}{2} \Rightarrow c_2 = \frac{9}{2}$. Thus, $f(x, y) = \frac{1}{2}y + 4$ and $g(x, y) = \frac{1}{2}x + \frac{9}{2}$.

18. Let $g(x, y) = D_u f(x, y) = f_x(x, y)a + f_y(x, y)b$. Then $D_u g(x, y) = g_x(x, y)a + g_y(x, y)b \\ = f_{xx}(x, y)a^2 + f_{yx}(x, y)ab + f_{xy}(x, y)ba + f_{yy}(x, y)b^2 = f_{xx}(x, y)a^2 + 2f_{xy}(x, y)ab + f_{yy}(x, y)b^2$.

19. Since the particle is heat-seeking, at each point (x, y) it moves in the direction of maximal temperature increase, that is in the direction of $\nabla T(x, y) = (e^{-2y} \sin x)\mathbf{i} + (2e^{-2y} \cos x)\mathbf{j}$. Since $\nabla T(x, y)$ is parallel to the particle's velocity vector, it is tangent to the path $y = f(x)$ of the particle $\Rightarrow f'(x) = \frac{2e^{-2y} \cos x}{e^{-2y} \sin x} = 2 \cot x$.

Integration gives $f(x) = 2 \ln|\sin x| + C$ and $f\left(\frac{\pi}{4}\right) = 0 \Rightarrow 0 = 2 \ln\left|\sin \frac{\pi}{4}\right| + C \Rightarrow C = -2 \ln \frac{\sqrt{2}}{2} = \ln\left(\frac{2}{\sqrt{2}}\right)^2 = \ln 2$.

Therefore, the path of the particle is the graph of $y = 2 \ln|\sin x| + \ln 2$.

20. The line of travel is $x = t, y = t, z = 30 - 5t$, and the bullet hits the surface $z = 2x^2 + 3y^2$ when $30 - 5t = 2t^2 + 3t^2 \Rightarrow t^2 + t - 6 = 0 \Rightarrow (t + 3)(t - 2) = 0 \Rightarrow t = 2$ (since $t > 0$). Thus the bullet hits the surface at the point $(2, 2, 20)$. Now, the vector $4x\mathbf{i} + 6y\mathbf{j} - \mathbf{k}$ is normal to the surface at any (x, y, z) , so that $\mathbf{n} = 8\mathbf{i} + 12\mathbf{j} - \mathbf{k}$ is normal to the surface at $(2, 2, 20)$. If $\mathbf{v} = \mathbf{i} + \mathbf{j} - 5\mathbf{k}$, then the velocity of the particle after the ricochet is $\mathbf{w} = \mathbf{v} - 2 \text{proj}_{\mathbf{n}} \mathbf{v} = \mathbf{v} - \left(\frac{2\mathbf{v} \cdot \mathbf{n}}{|\mathbf{n}|^2}\right)\mathbf{n} = \mathbf{v} - \left(\frac{2 \cdot 25}{209}\right)\mathbf{n} = (\mathbf{i} + \mathbf{j} - 5\mathbf{k}) - \left(\frac{400}{209}\mathbf{i} + \frac{600}{209}\mathbf{j} - \frac{50}{209}\mathbf{k}\right)$

$$= -\frac{191}{209}\mathbf{i} - \frac{391}{209}\mathbf{j} - \frac{995}{209}\mathbf{k}.$$

21. (a) \mathbf{k} is a vector normal to $z = 10 - x^2 - y^2$ at the point $(0, 0, 10)$. So directions tangential to S at $(0, 0, 10)$ will be unit vectors $\mathbf{u} = a\mathbf{i} + b\mathbf{j}$. Also, $\nabla T(x, y, z) = (2xy + 4)\mathbf{i} + (x^2 + 2yz + 14)\mathbf{j} + (y^2 + 1)\mathbf{k}$
 $\Rightarrow \nabla T(0, 0, 10) = 4\mathbf{i} + 14\mathbf{j} + \mathbf{k}$. We seek the unit vector $\mathbf{u} = a\mathbf{i} + b\mathbf{j}$ such that $D_{\mathbf{u}}T(0, 0, 10) = (4\mathbf{i} + 14\mathbf{j} + \mathbf{k}) \cdot (a\mathbf{i} + b\mathbf{j}) = (4\mathbf{i} + 14\mathbf{j}) \cdot (a\mathbf{i} + b\mathbf{j})$ is a maximum. The maximum will occur when $a\mathbf{i} + b\mathbf{j}$ has the same direction as $4\mathbf{i} + 14\mathbf{j}$, or $\mathbf{u} = \frac{1}{\sqrt{53}}(2\mathbf{i} + 7\mathbf{j})$.

(b) A vector normal to S at $(1, 1, 8)$ is $\mathbf{n} = 2\mathbf{i} + 2\mathbf{j} + \mathbf{k}$. Now, $\nabla T(1, 1, 8) = 6\mathbf{i} + 31\mathbf{j} + 2\mathbf{k}$ and we seek the unit vector \mathbf{u} such that $D_{\mathbf{u}}T(1, 1, 8) = \nabla T \cdot \mathbf{u}$ has its largest value. Now write $\nabla T = \mathbf{v} + \mathbf{w}$, where \mathbf{v} is parallel to ∇T and \mathbf{w} is orthogonal to ∇T . Then $D_{\mathbf{u}}T = \nabla T \cdot \mathbf{u} = (\mathbf{v} + \mathbf{w}) \cdot \mathbf{u} = \mathbf{v} \cdot \mathbf{u} + \mathbf{w} \cdot \mathbf{u} = \mathbf{w} \cdot \mathbf{u}$. Thus

$$D_{\mathbf{u}}T(1, 1, 8) \text{ is a maximum when } \mathbf{u} \text{ has the same direction as } \mathbf{w}. \text{ Now, } \mathbf{w} = \nabla T - \left(\frac{\nabla T \cdot \mathbf{n}}{|\mathbf{n}|^2} \right) \mathbf{n}$$

$$= (6\mathbf{i} + 31\mathbf{j} + 2\mathbf{k}) - \left(\frac{12 + 62 + 2}{4 + 4 + 1} \right) (2\mathbf{i} + 2\mathbf{j} + \mathbf{k}) = \left(6 - \frac{152}{9} \right) \mathbf{i} + \left(31 - \frac{152}{9} \right) \mathbf{j} + \left(2 - \frac{76}{9} \right) \mathbf{k} = -\frac{98}{9} \mathbf{i} + \frac{127}{9} \mathbf{j} - \frac{58}{9} \mathbf{k}$$

$$\Rightarrow \mathbf{u} = \frac{\mathbf{w}}{|\mathbf{w}|} = -\frac{1}{\sqrt{29,097}} (98\mathbf{i} - 127\mathbf{j} + 58\mathbf{k}).$$

22. Suppose the surface (boundary) of the mineral deposit is the graph of $z = f(x, y)$ (where the z -axis points up into the air). Then $-\frac{\partial f}{\partial x} \mathbf{i} - \frac{\partial f}{\partial y} \mathbf{j} + \mathbf{k}$ is an outer normal to the mineral deposit at (x, y) and $\frac{\partial f}{\partial x} \mathbf{i} + \frac{\partial f}{\partial y} \mathbf{j}$ points in the direction of steepest ascent of the mineral deposit. This is in the direction of the vector $\frac{\partial f}{\partial x} \mathbf{i} + \frac{\partial f}{\partial y} \mathbf{j}$ at $(0, 0)$ (the location of the 1st borehole) that the geologists should drill their fourth borehole. To approximate this vector we use the fact that $(0, 0, -1000)$, $(0, 100, -950)$, and $(100, 0, -1025)$ lie on the graph of $z = f(x, y)$. The plane containing these three points is a good approximation to the tangent plane to $z = f(x, y)$ at the point

$$(0, 0, 0). \text{ A normal to this plane is } \begin{vmatrix} \mathbf{i} & \mathbf{j} & \mathbf{k} \\ 0 & 100 & 50 \\ 100 & 0 & -25 \end{vmatrix} = -2500\mathbf{i} + 5000\mathbf{j} - 10,000\mathbf{k}, \text{ or } -\mathbf{i} + 2\mathbf{j} - 4\mathbf{k}. \text{ So at } (0, 0)$$

the vector $\frac{\partial f}{\partial x} \mathbf{i} + \frac{\partial f}{\partial y} \mathbf{j}$ is approximately $-\mathbf{i} + 2\mathbf{j}$. Thus the geologists should drill their fourth borehole in the direction of $\frac{1}{\sqrt{5}}(-\mathbf{i} + 2\mathbf{j})$ from the first borehole.

23. $w = e^{rt} \sin \pi x \Rightarrow w_t = re^{rt} \sin \pi x$ and $w_x = \pi e^{rt} \cos \pi x \Rightarrow w_{xx} = -\pi^2 e^{rt} \sin \pi x$; $w_{xx} = \frac{1}{c^2} w_t$, where c^2 is the positive constant determined by the material of the rod $\Rightarrow -\pi^2 e^{rt} \sin \pi x = \frac{1}{c^2} (re^{rt} \sin \pi x)$
 $\Rightarrow (r + c^2 \pi^2) e^{rt} \sin \pi x = 0 \Rightarrow r = -c^2 \pi^2 \Rightarrow w = e^{-c^2 \pi^2 t} \sin \pi x$

24. $w = e^{rt} \sin kx \Rightarrow w_t = re^{rt} \sin kx$ and $w_x = ke^{rt} \cos kx \Rightarrow w_{xx} = -k^2 e^{rt} \sin kx$; $w_{xx} = \frac{1}{c^2} w_t$
 $\Rightarrow -k^2 e^{rt} \sin kx = \frac{1}{c^2} (re^{rt} \sin kx) \Rightarrow (r + c^2 k^2) e^{rt} \sin kx = 0 \Rightarrow r = -c^2 k^2 \Rightarrow w = e^{-c^2 k^2 t} \sin kx$. Now,
 $w(L, t) = 0 \Rightarrow e^{-c^2 k^2 t} \sin kL = 0 \Rightarrow kL = n\pi$ for n an integer $\Rightarrow k = \frac{n\pi}{L} \Rightarrow w = e^{-c^2 n^2 \pi^2 t / L^2} \sin\left(\frac{n\pi}{L} x\right)$. As
 $t \rightarrow \infty, w \rightarrow 0$ since $\left| \sin\left(\frac{n\pi}{L} x\right) \right| \leq 1$ and $e^{-c^2 n^2 \pi^2 t / L^2} \rightarrow 0$.

CHAPTER 15 MULTIPLE INTEGRALS

15.1 DOUBLE AND ITERATED INTEGRALS OVER RECTANGLES

1. $\int_1^2 \int_0^4 2xy \, dy \, dx = \int_1^2 [xy^2]_0^4 \, dx = \int_1^2 16x \, dx = [8x^2]_1^2 = 24$
2. $\int_0^2 \int_{-1}^1 (x-y) \, dy \, dx = \int_0^2 [xy - \frac{1}{2}y^2]_{-1}^1 \, dx = \int_0^2 2x \, dx = [x^2]_0^2 = 4$
3. $\int_{-1}^0 \int_{-1}^1 (x+y+1) \, dx \, dy = \int_{-1}^0 [\frac{x^2}{2} + yx + x]_{-1}^1 \, dy = \int_{-1}^0 (2y+2) \, dy = [y^2 + 2y]_{-1}^0 = 1$
4. $\int_0^1 \int_0^1 (1 - \frac{x^2+y^2}{2}) \, dx \, dy = \int_0^1 [x - \frac{x^3}{6} - \frac{xy^2}{2}]_0^1 \, dy = \int_0^1 (\frac{5}{6} - \frac{y^2}{2}) \, dy = [\frac{5}{6}y - \frac{y^3}{6}]_0^1 = \frac{2}{3}$
5. $\int_0^3 \int_0^2 (4-y^2) \, dy \, dx = \int_0^3 [4y - \frac{y^3}{3}]_0^2 \, dx = \int_0^3 \frac{16}{3} \, dx = [\frac{16}{3}x]_0^3 = 16$
6. $\int_0^3 \int_{-2}^0 (x^2y - 2xy) \, dy \, dx = \int_0^3 [\frac{x^2y^2}{2} - xy^2]_{-2}^0 \, dx = \int_0^3 (4x - 2x^2) \, dx = [2x^2 - \frac{2x^3}{3}]_0^3 = 0$
7. $\int_0^1 \int_0^1 \frac{y}{1+xy} \, dx \, dy = \int_0^1 [\ln|1+xy|]_0^1 \, dy = \int_0^1 \ln|1+y| \, dy = [y \ln|1+y| - y + \ln|1+y|]_0^1 = 2 \ln 2 - 1$
8. $\int_1^4 \int_0^4 (\frac{x}{2} + \sqrt{y}) \, dx \, dy = \int_1^4 [\frac{1}{4}x^2 + x\sqrt{y}]_0^4 \, dy = \int_1^4 (4 + 4y^{1/2}) \, dy = [4y + \frac{8}{3}y^{3/2}]_1^4 = \frac{92}{3}$
9. $\int_0^{\ln 2} \int_1^{\ln 5} e^{2x+y} \, dy \, dx = \int_0^{\ln 2} [e^{2x+y}]_1^{\ln 5} \, dx = \int_0^{\ln 2} (5e^{2x} - e^{2x+1}) \, dx = [\frac{5}{2}e^{2x} - \frac{1}{2}e^{2x+1}]_0^{\ln 2} = \frac{3}{2}(5-e)$
10. $\int_0^1 \int_1^2 x y e^x \, dy \, dx = \int_0^1 [\frac{1}{2}x y^2 e^x]_1^2 \, dx = \int_0^1 \frac{3}{2}x e^x \, dx = [\frac{3}{2}x e^x - \frac{3}{2}e^x]_0^1 = \frac{3}{2}$
11. $\int_{-1}^2 \int_0^{\pi/2} y \sin x \, dx \, dy = \int_{-1}^2 [-y \cos x]_0^{\pi/2} \, dy = \int_{-1}^2 y \, dy = [\frac{1}{2}y^2]_{-1}^2 = \frac{3}{2}$
12. $\int_{\pi}^{2\pi} \int_0^{\pi} (\sin x + \cos y) \, dx \, dy = \int_{\pi}^{2\pi} [-\cos x + x \cos y]_0^{\pi} \, dy = \int_{\pi}^{2\pi} (2 + \pi \cos y) \, dy = [2y + \pi \sin y]_{\pi}^{2\pi} = 2\pi$
13. $\int_1^4 \int_1^e \frac{\ln x}{xy} \, dx \, dy = \int_1^4 \left(\frac{(\ln x)^2}{2y} \right)_{x=1}^{x=e} \, dy = \int_1^4 \frac{1}{2y} \, dy = \left[\frac{\ln y}{2} \right]_1^4 = \ln 2$

$$14. \int_{-1}^2 \int_1^2 x \ln y \, dy \, dx = \int_{-1}^2 \left(x(y \ln y - y) \Big|_{y=1}^{y=2} \right) dx = \int_{-1}^2 (2 \ln 2 - 1)x \, dx = (2 \ln 2 - 1) \frac{x^2}{2} \Big|_{-1}^2 = 3 \ln 2 - \frac{3}{2}$$

$$15. \iint_R (6y^2 - 2x) \, dA = \int_0^1 \int_0^2 (6y^2 - 2x) \, dy \, dx = \int_0^1 [2y^3 - 2xy]_0^2 \, dx = \int_0^1 (16 - 4x) \, dx = [16x - 2x^2]_0^1 = 14$$

$$16. \iint_R \frac{\sqrt{x}}{y^2} \, dA = \int_0^4 \int_1^2 \frac{\sqrt{x}}{y^2} \, dy \, dx = \int_0^4 \left[-\frac{\sqrt{x}}{y} \right]_1^2 \, dx = \int_0^4 \frac{1}{2} x^{1/2} \, dx = \left[\frac{1}{3} x^{3/2} \right]_0^4 = \frac{8}{3}$$

$$17. \iint_R xy \cos y \, dA = \int_{-1}^1 \int_0^\pi xy \cos y \, dy \, dx = \int_{-1}^1 [xy \sin y + x \cos y]_0^\pi \, dx = \int_{-1}^1 (-2x) \, dx = [-x^2]_{-1}^1 = 0$$

$$18. \iint_R y \sin(x+y) \, dA = \int_{-\pi}^0 \int_0^\pi y \sin(x+y) \, dy \, dx = \int_{-\pi}^0 [-y \cos(x+y) + \sin(x+y)]_0^\pi \, dx \\ = \int_{-\pi}^0 (\sin(x+\pi) - \pi \cos(x+\pi) - \sin x) \, dx = [-\cos(x+\pi) - \pi \sin(x+\pi) + \cos x]_{-\pi}^0 = 4$$

$$19. \iint_R e^{x-y} \, dA = \int_0^{\ln 2} \int_0^{\ln 2} e^{x-y} \, dy \, dx = \int_0^{\ln 2} [-e^{x-y}]_0^{\ln 2} \, dx = \int_0^{\ln 2} (-e^{x-\ln 2} + e^x) \, dx = [-e^{x-\ln 2} + e^x]_0^{\ln 2} = \frac{1}{2}$$

$$20. \iint_R xy \, e^{xy^2} \, dA = \int_0^2 \int_0^1 xy \, e^{xy^2} \, dy \, dx = \int_0^2 \left[\frac{1}{2} e^{xy^2} \right]_0^1 \, dx = \int_0^2 \left(\frac{1}{2} e^x - \frac{1}{2} \right) \, dx = \left[\frac{1}{2} e^x - \frac{1}{2} x \right]_0^2 = \frac{1}{2}(e^2 - 3)$$

$$21. \iint_R \frac{xy^3}{x^2+1} \, dA = \int_0^1 \int_0^2 \frac{xy^3}{x^2+1} \, dy \, dx = \int_0^1 \left[\frac{xy^4}{4(x^2+1)} \right]_0^2 \, dx = \int_0^1 \frac{4x}{x^2+1} \, dx = [2 \ln |x^2+1|]_0^1 = 2 \ln 2$$

$$22. \iint_R \frac{y}{x^2y^2+1} \, dA = \int_0^1 \int_0^1 \frac{y}{(xy)^2+1} \, dx \, dy = \int_0^1 [\tan^{-1}(xy)]_0^1 \, dy = \int_0^1 \tan^{-1} y \, dy = \left[y \tan^{-1} y - \frac{1}{2} \ln |1+y^2| \right]_0^1 = \frac{\pi}{4} - \frac{1}{2} \ln 2$$

$$23. \int_1^2 \int_1^2 \frac{1}{xy} \, dy \, dx = \int_1^2 \frac{1}{x} (\ln 2 - \ln 1) \, dx = (\ln 2) \int_1^2 \frac{1}{x} \, dx = (\ln 2)^2$$

$$24. \int_0^1 \int_0^\pi y \cos xy \, dx \, dy = \int_0^1 [\sin xy]_0^\pi \, dy = \int_0^1 \sin \pi y \, dy = \left[-\frac{1}{\pi} \cos \pi y \right]_0^1 = -\frac{1}{\pi}(-1-1) = \frac{2}{\pi}$$

$$25. V = \iint_R f(x, y) \, dA = \int_{-1}^1 \int_{-1}^1 (x^2 + y^2) \, dy \, dx = \int_{-1}^1 \left[x^2 y + \frac{1}{3} y^3 \right]_{-1}^1 \, dx = \int_{-1}^1 \left(2x^2 + \frac{2}{3} \right) \, dx = \left[\frac{2}{3} x^3 + \frac{2}{3} x \right]_{-1}^1 = \frac{8}{3}$$

$$26. V = \iint_R f(x, y) \, dA = \int_0^2 \int_0^2 (16 - x^2 - y^2) \, dy \, dx = \int_0^2 \left[16y - x^2 y - \frac{1}{3} y^3 \right]_0^2 \, dx = \int_0^2 \left(\frac{88}{3} - 2x^2 \right) \, dx = \left[\frac{88}{3} x - \frac{2}{3} x^3 \right]_0^2 \\ = \frac{160}{3}$$

$$27. \quad V = \iint_R f(x, y) \, dA = \int_0^1 \int_0^1 (2 - x - y) \, dy \, dx = \int_0^1 \left[2y - xy - \frac{1}{2}y^2 \right]_0^1 dx = \int_0^1 \left(\frac{3}{2} - x \right) dx = \left[\frac{3}{2}x - \frac{1}{2}x^2 \right]_0^1 = 1$$

$$28. \quad V = \iint_R f(x, y) \, dA = \int_0^4 \int_0^2 \frac{y}{2} \, dy \, dx = \int_0^4 \left[\frac{y^2}{4} \right]_0^2 dx = \int_0^4 1 \, dx = [x]_0^4 = 4$$

$$29. \quad V = \iint_R f(x, y) \, dA = \int_0^{\pi/2} \int_0^{\pi/4} 2 \sin x \cos y \, dy \, dx = \int_0^{\pi/2} [2 \sin x \sin y]_0^{\pi/4} dx = \int_0^{\pi/2} (\sqrt{2} \sin x) dx \\ = [-\sqrt{2} \cos x]_0^{\pi/2} = \sqrt{2}$$

$$30. \quad V = \iint_R f(x, y) \, dA = \int_0^1 \int_0^2 (4 - y^2) \, dy \, dx = \int_0^1 \left[4y - \frac{1}{3}y^3 \right]_0^2 dx = \int_0^1 \left(\frac{16}{3} \right) dx = \left[\frac{16}{3}x \right]_0^1 = \frac{16}{3}$$

$$31. \quad \int_1^2 \int_0^3 kx^2y \, dx \, dy = \int_1^2 \left(\frac{k}{3}x^3y \right)_{x=0}^{x=3} dx = \int_1^2 9ky \, dy = \left[\frac{9}{2}ky^2 \right]_1^2 = \frac{27}{2}k$$

Thus we choose $k = 2/27$.

32. $\int_0^{\pi/2} \sin(\sqrt{y}) \, dy$ is some number, say a . Then $\int_{-1}^1 \int_0^{\pi/2} x \sin(\sqrt{y}) \, dy \, dx = a \int_{-1}^1 x \, dx = 0$ since the integral of the odd function x over an interval symmetric to 0 is equal to 0.

33. By Fubini's Theorem,

$$\int_0^2 \int_0^1 \frac{x}{1+xy} \, dx \, dy = \int_0^1 \int_0^2 \frac{x}{1+xy} \, dy \, dx \\ = \int_0^1 \left(\ln(1+xy) \right)_{y=0}^{y=2} dx = \int_0^1 \ln(1+2x) \, dx = \frac{(1+2x)}{2} [\ln(1+2x) - 1] \Big|_0^1 = \frac{3}{2} \ln 3 - 1$$

34. By Fubini's Theorem,

$$\int_0^1 \int_0^3 xe^{xy} \, dx \, dy = \int_0^3 \int_0^1 xe^{xy} \, dy \, dx \\ = \int_0^3 \left(e^{xy} \right)_{y=0}^{y=1} dx = \int_0^3 (e^x - 1) \, dx = (e^x - x) \Big|_0^3 = e^3 - 4 \approx 16.086$$

35. (a) MAPLE gives $\int_0^1 \int_0^2 \frac{y-x}{(x+y)^3} \, dx \, dy = \frac{1}{3}$ and $\int_0^2 \int_0^1 \frac{y-x}{(x+y)^3} \, dy \, dx = -\frac{2}{3}$. This does not contradict

Fubini's Theorem since the integrand is not continuous on the region $R: 0 \leq x \leq 2, 0 \leq y \leq 1$.

36. Since f is continuous on R , for fixed u $f(u, v)$ is a continuous function of v and has an antiderivative with respect to v on R , call it $g(u, v)$. Then $\int_c^y f(u, v) dv = g(u, y) - g(u, c)$ and

$$F(x, y) = \int_a^x \int_c^y f(u, v) dv du = \int_a^x (g(u, y) - g(u, c)) du.$$

$$F_x = \frac{\partial}{\partial x} \int_a^x (g(u, y) - g(u, c)) du = g(x, y) - g(x, c).$$

Now taking the derivative with respect to y , we get

$$F_{xy} = \frac{\partial}{\partial y} (g(x, y) - g(x, c)) = f(x, y).$$

To evaluate F_{yx} we use Fubini's Theorem to rewrite $F(x, y)$ as $\int_c^y \int_a^x f(u, v) du dv$ and make a similar argument. The result is again $f(x, y)$.

15.2 DOUBLE INTEGRALS OVER GENERAL REGIONS

1.

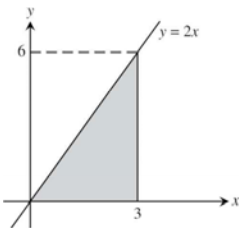

2.

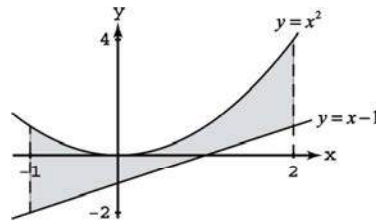

3.

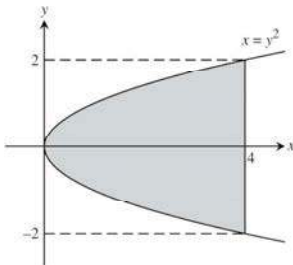

4.

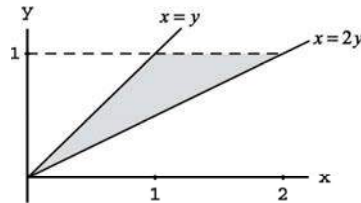

5.

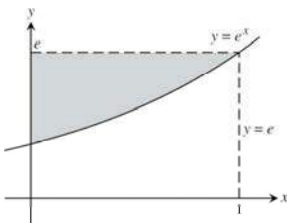

6.

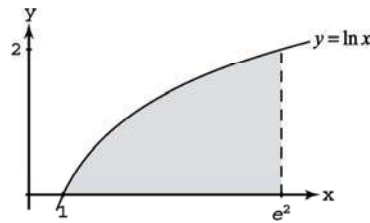

7.

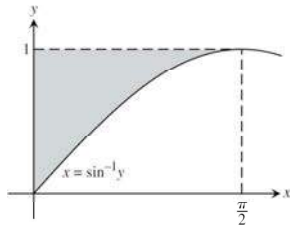

9. (a) $\int_0^2 \int_{x^3}^8 dy dx$

10. (a) $\int_0^3 \int_0^{2x} dy dx$

11. (a) $\int_0^3 \int_{x^2}^{3x} dy dx$

12. (a) $\int_0^2 \int_1^{e^x} dy dx$

13. (a) $\int_0^9 \int_0^{\sqrt{x}} dy dx$

(b) $\int_0^3 \int_{y^2}^9 dx dy$

14. (a) $\int_0^{\pi/4} \int_{\tan x}^1 dy dx$

(b) $\int_0^1 \int_0^{\tan^{-1} y} dx dy$

15. (a) $\int_0^{\ln 3} \int_{e^{-x}}^1 dy dx$

(b) $\int_{1/3}^1 \int_{-\ln y}^{\ln 3} dx dy$

8.

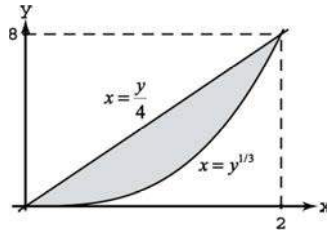

(b) $\int_0^8 \int_0^{y^{1/3}} dx dy$

(b) $\int_0^6 \int_{y/2}^3 dx dy$

(b) $\int_0^9 \int_{y/3}^{\sqrt{y}} dx dy$

(b) $\int_1^{e^2} \int_{\ln y}^2 dx dy$

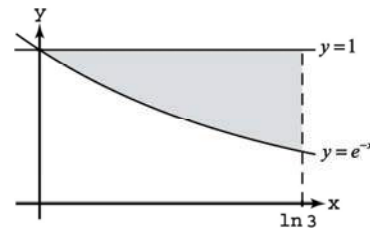
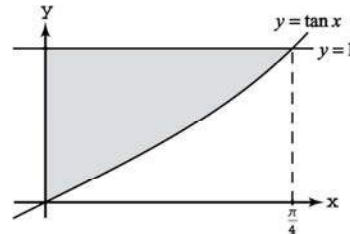
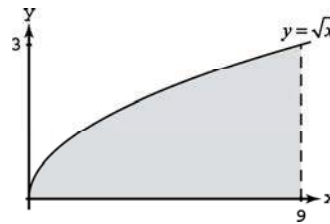

16. (a) $\int_0^1 \int_0^1 dy dx + \int_1^e \int_{\ln x}^1 dy dx$

(b) $\int_0^1 \int_0^{e^y} dx dy$

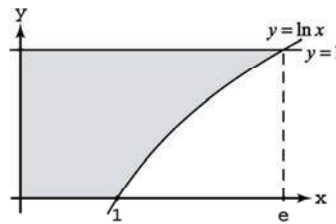

17. (a) $\int_0^1 \int_x^{3-2x} dy dx$

(b) $\int_0^1 \int_0^y dx dy + \int_1^3 \int_0^{(3-y)/2} dx dy$

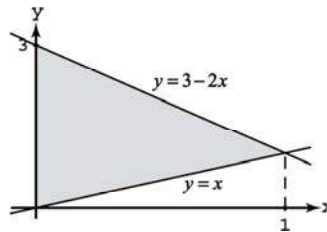

18. (a) $\int_{-1}^2 \int_{x^2}^{x+2} dy dx$

(b) $\int_0^1 \int_{-\sqrt{y}}^{\sqrt{y}} dx dy + \int_1^3 \int_{y-2}^{\sqrt{y}} dx dy$

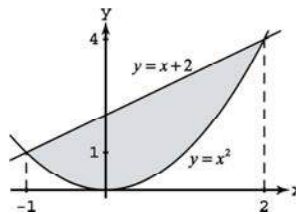

19. $\int_0^\pi \int_0^\pi (x \sin y) dy dx = \int_0^\pi [-x \cos y]_0^\pi dx$
 $= \int_0^\pi (x - x \cos x) dx = \left[\frac{x^2}{2} - (\cos x + x \sin x) \right]_0^\pi$
 $= \frac{\pi^2}{2} + 2$

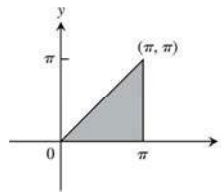

20. $\int_0^\pi \int_0^{\sin x} y dy dx = \int_0^\pi \left[\frac{y^2}{2} \right]_0^{\sin x} dx = \int_0^\pi \frac{1}{2} \sin^2 x dx$
 $= \frac{1}{4} \int_0^\pi (1 - \cos 2x) dx = \frac{1}{4} \left[x - \frac{1}{2} \sin 2x \right]_0^\pi = \frac{\pi}{4}$

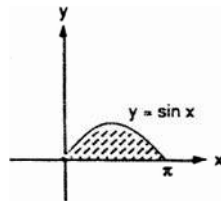

21. $\int_1^{\ln 8} \int_0^{\ln y} e^{x+y} dx dy = \int_1^{\ln 8} [e^{x+y}]_0^{\ln y} dy$
 $= \int_1^{\ln 8} (ye^y - e^y) dy = \left[(y-1)e^y - e^y \right]_1^{\ln 8}$
 $= 8(\ln 8 - 1) - 8 + e = 8 \ln 8 - 16 + e$

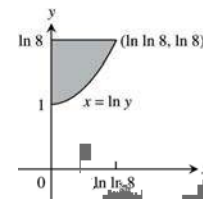

22. $\int_1^2 \int_y^{y^2} dx dy = \int_1^2 (y^2 - y) dy = \left[\frac{y^3}{3} - \frac{y^2}{2} \right]_1^2$
 $= \left(\frac{8}{3} - 2 \right) - \left(\frac{1}{3} - \frac{1}{2} \right) = \frac{7}{3} - \frac{3}{2} = \frac{5}{6}$

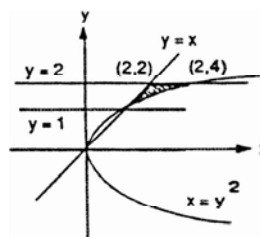

$$\begin{aligned}
 23. \int_0^1 \int_0^{y^2} 3y^3 e^{xy} dx dy &= \int_0^1 \left[3y^2 e^{xy} \right]_0^{y^2} dy \\
 &= \int_0^1 (3y^2 e^{y^3} - 3y^2) dy = \left[e^{y^3} - y^3 \right]_0^1 = e - 2
 \end{aligned}$$

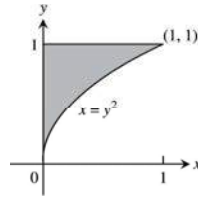

$$\begin{aligned}
 24. \int_1^4 \int_0^{\sqrt{x}} \frac{3}{2} e^{y/\sqrt{x}} dy dx &= \int_1^4 \left[\frac{3}{2} \sqrt{x} e^{y/\sqrt{x}} \right]_0^{\sqrt{x}} dx \\
 &= \frac{3}{2} (e-1) \int_1^4 \sqrt{x} dx = \left[\frac{3}{2} (e-1) \left(\frac{2}{3} \right) x^{3/2} \right]_1^4 = 7(e-1)
 \end{aligned}$$

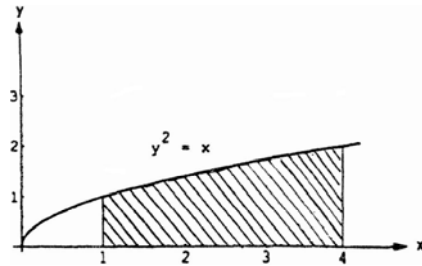

$$25. \int_1^2 \int_x^{2x} \frac{x}{y} dy dx = \int_1^2 [x \ln y]_x^{2x} dx = (\ln 2) \int_1^2 x dx = \frac{3}{2} \ln 2$$

$$\begin{aligned}
 26. \int_0^1 \int_0^{1-x} (x^2 + y^2) dy dx &= \int_0^1 \left[x^2 y + \frac{y^3}{3} \right]_0^{1-x} dx = \int_0^1 \left[x^2 (1-x) + \frac{(1-x)^3}{3} \right] dx \\
 &= \int_0^1 \left[x^2 - x^3 + \frac{(1-x)^3}{3} \right] dx \\
 &= \left[\frac{x^3}{3} - \frac{x^4}{4} - \frac{(1-x)^4}{12} \right]_0^1 = \left(\frac{1}{3} - \frac{1}{4} - 0 \right) - \left(0 - 0 - \frac{1}{12} \right) = \frac{1}{6}
 \end{aligned}$$

$$\begin{aligned}
 27. \int_0^1 \int_0^{1-u} (v - \sqrt{u}) dv du &= \int_0^1 \left[\frac{v^2}{2} - v\sqrt{u} \right]_0^{1-u} du = \int_0^1 \left[\frac{1-2u+u^2}{2} - \sqrt{u}(1-u) \right] du \\
 &= \int_0^1 \left(\frac{1}{2} - u + \frac{u^2}{2} - u^{1/2} + u^{3/2} \right) du = \left[\frac{u}{2} - \frac{u^2}{2} + \frac{u^3}{6} - \frac{2}{3} u^{3/2} + \frac{2}{5} u^{5/2} \right]_0^1 \\
 &= \frac{1}{2} - \frac{1}{2} + \frac{1}{6} - \frac{2}{3} + \frac{2}{5} = -\frac{1}{2} + \frac{2}{5} = -\frac{1}{10}
 \end{aligned}$$

$$\begin{aligned}
 28. \int_1^2 \int_0^{\ln t} e^s \ln t ds dt &= \int_1^2 \left[e^s \ln t \right]_0^{\ln t} dt = \int_1^2 (t \ln t - \ln t) dt = \left[\frac{t^2}{2} \ln t - \frac{t^2}{4} - t \ln t + t \right]_1^2 \\
 &= (2 \ln 2 - 1 - 2 \ln 2 + 2) - \left(-\frac{1}{4} + 1 \right) = \frac{1}{4}
 \end{aligned}$$

$$\begin{aligned}
 29. \int_{-2}^0 \int_v^{-v} 2 dp dv &= 2 \int_{-2}^0 [p]_v^{-v} dv = 2 \int_{-2}^0 -2v dv \\
 &= -2 \left[v^2 \right]_{-2}^0 = 8
 \end{aligned}$$

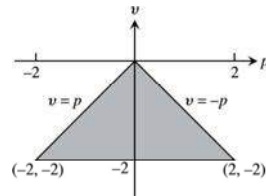

$$\begin{aligned}
 30. \int_0^1 \int_0^{\sqrt{1-s^2}} 8t dt ds &= \int_0^1 \left[4t^2 \right]_0^{\sqrt{1-s^2}} ds \\
 &= \int_0^1 4(1-s^2) ds = 4 \left[s - \frac{s^3}{3} \right]_0^1 = \frac{8}{3}
 \end{aligned}$$

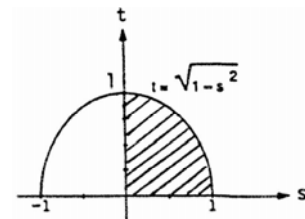

$$31. \int_{-\pi/3}^{\pi/3} \int_0^{\sec t} 3 \cos t \, du \, dt = \int_{-\pi/3}^{\pi/3} [(3 \cos t)u]_0^{\sec t} \, dt$$

$$= \int_{-\pi/3}^{\pi/3} 3 \, dt = 2\pi$$

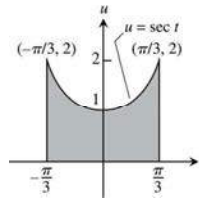

$$32. \int_0^{3/2} \int_1^{4-2u} \frac{4-2u}{v^2} \, dv \, du = \int_0^{3/2} \left[\frac{2u-4}{v} \right]_1^{4-2u} \, du$$

$$= \int_0^{3/2} (3-2u) \, du = \left[3u - u^2 \right]_0^{3/2} = \frac{9}{2}$$

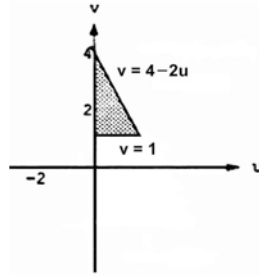

$$33. \int_2^4 \int_0^{(4-y)/2} dx \, dy$$

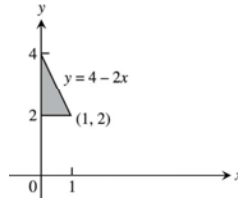

$$34. \int_{-2}^0 \int_0^{x+2} dy \, dx$$

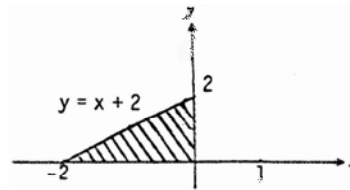

$$35. \int_0^1 \int_{x^2}^x dy \, dx$$

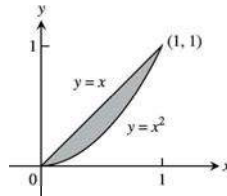

$$36. \int_0^1 \int_{1-y}^{\sqrt{1-y}} dx \, dy$$

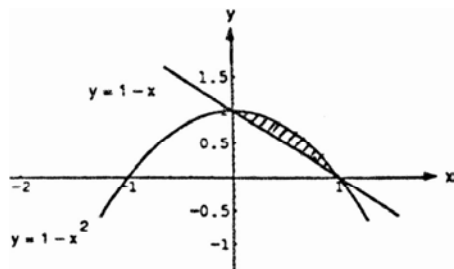

$$37. \int_1^e \int_{\ln y}^1 dx \, dy$$

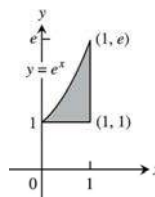

38. $\int_1^2 \int_0^{\ln x} dy dx$

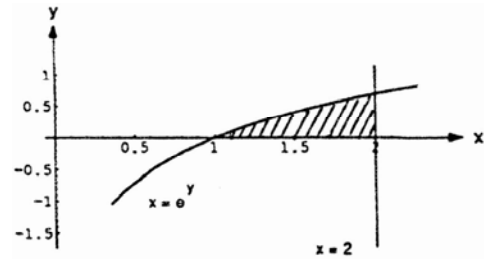

39. $\int_0^9 \int_0^{\frac{1}{2}\sqrt{9-y}} 16x dx dy$

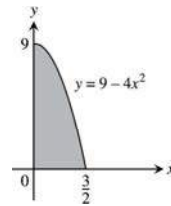

40. $\int_0^4 \int_0^{\sqrt{4-x}} y dy dx$

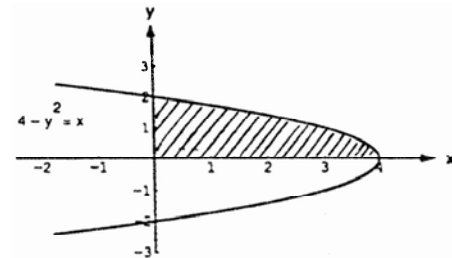

41. $\int_{-1}^1 \int_0^{\sqrt{1-x^2}} 3y dy dx$

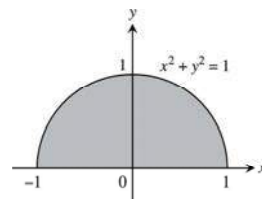

42. $\int_{-2}^2 \int_0^{\sqrt{4-y^2}} 6x dx dy$

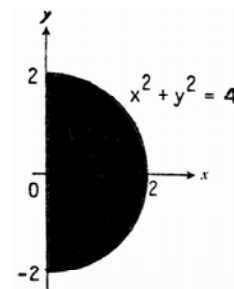

43. $\int_0^1 \int_{e^y}^e xy dx dy$

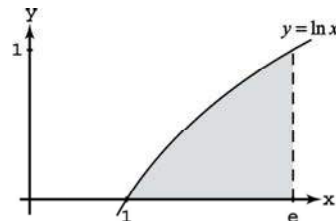

44. $\int_0^{1/2} \int_0^{\sin^{-1} y} xy^2 dx dy$

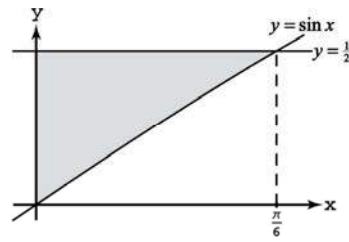

45. $\int_1^{e^3} \int_{\ln x}^3 (x+y) dy dx$

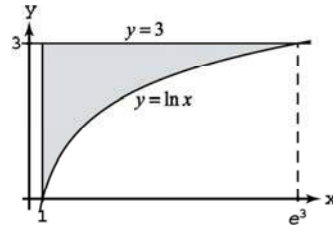

46. $\int_0^{\pi/3} \int_{\tan x}^{\sqrt{3}} \sqrt{xy} dy dx$

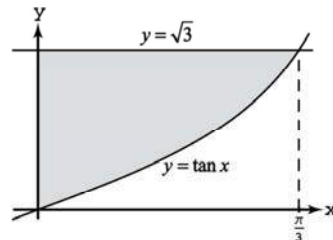

47. $\int_0^\pi \int_x^\pi \frac{\sin y}{y} dy dx = \int_0^\pi \int_0^y \frac{\sin y}{y} dx dy = \int_0^\pi \sin y dy = 2$

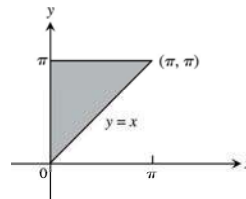

48. $\int_0^2 \int_x^2 2y^2 \sin xy dy dx = \int_0^2 \int_0^y 2y^2 \sin xy dx dy$
 $= \int_0^2 [-2y \cos xy]_0^y dy = \int_0^2 (-2y \cos y^2 + 2y) dy$
 $= [-\sin y^2 + y^2]_0^2 = 4 - \sin 4$

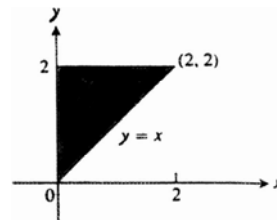

49. $\int_0^1 \int_y^1 x^2 e^{xy} dx dy = \int_0^1 \int_0^x x^2 e^{xy} dy dx = \int_0^1 [xe^{xy}]_0^x dx$
 $= \int_0^1 (xe^{x^2} - x) dx = [\frac{1}{2}e^{x^2} - \frac{x^2}{2}]_0^1 = \frac{e-2}{2}$

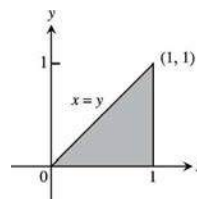

50. $\int_0^2 \int_0^{4-x^2} \frac{xe^{2y}}{4-y} dy dx = \int_0^4 \int_0^{\sqrt{4-y}} \frac{xe^{2y}}{4-y} dx dy$
 $= \int_0^4 [\frac{x^2 e^{2y}}{2(4-y)}]_0^{\sqrt{4-y}} dy = \int_0^4 \frac{e^{2y}}{2} dy = [\frac{e^{2y}}{4}]_0^4 = \frac{e^8-1}{4}$

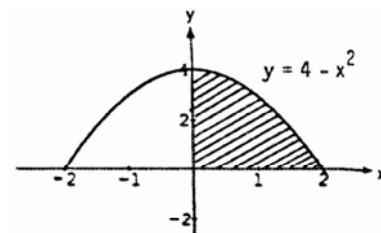

$$\begin{aligned}
 51. \quad \int_0^{2\sqrt{\ln 3}} \int_{y/2}^{\sqrt{\ln 3}} e^{x^2} dx dy &= \int_0^{\sqrt{\ln 3}} \int_0^{2x} e^{x^2} dy dx \\
 &= \int_0^{\sqrt{\ln 3}} 2xe^{x^2} dx = \left[e^{x^2} \right]_0^{\sqrt{\ln 3}} = e^{\ln 3} - 1 = 2
 \end{aligned}$$

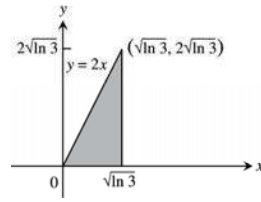

$$\begin{aligned}
 52. \quad \int_0^3 \int_{\sqrt{x/3}}^1 e^{y^3} dy dx &= \int_0^1 \int_0^{3y^2} e^{y^3} dx dy \\
 &= \int_0^1 3y^2 e^{y^3} dy = \left[e^{y^3} \right]_0^1 = e - 1
 \end{aligned}$$

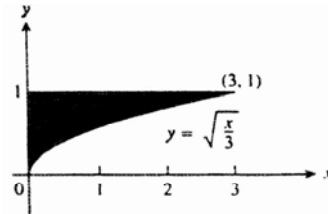

$$\begin{aligned}
 53. \quad \int_0^{1/16} \int_{y^{1/4}}^{1/2} \cos(16\pi x^5) dx dy &= \int_0^{1/2} \int_0^{x^4} \cos(16\pi x^5) dy dx \\
 &= \int_0^{1/2} x^4 \cos(16\pi x^5) dx \\
 &= \left[\frac{\sin(16\pi x^5)}{80\pi} \right]_0^{1/2} = \frac{1}{80\pi}
 \end{aligned}$$

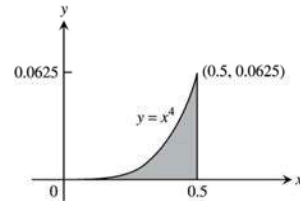

$$\begin{aligned}
 54. \quad \int_0^8 \int_{\sqrt[3]{x}}^2 \frac{1}{y^4+1} dy dx &= \int_0^2 \int_0^{y^3} \frac{1}{y^4+1} dx dy \\
 &= \int_0^2 \frac{y^3}{y^4+1} dy = \frac{1}{4} \left[\ln(y^4+1) \right]_0^2 = \frac{\ln 17}{4}
 \end{aligned}$$

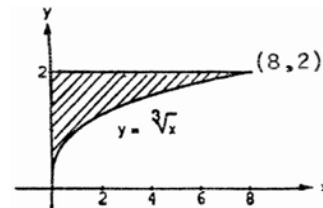

$$\begin{aligned}
 55. \quad \iint_R (y - 2x^2) dA &= \int_{-1}^0 \int_{-x-1}^{x+1} (y - 2x^2) dy dx + \int_0^1 \int_{x-1}^{1-x} (y - 2x^2) dy dx \\
 &= \int_{-1}^0 \left[\frac{1}{2} y^2 - 2x^2 y \right]_{-x-1}^{x+1} dx + \int_0^1 \left[\frac{1}{2} y^2 - 2x^2 y \right]_{x-1}^{1-x} dx \\
 &= \int_{-1}^0 \left(\frac{1}{2} (x+1)^2 - 2x^2(x+1) - \frac{1}{2} (-x-1)^2 + 2x^2(-x-1) \right) dx \\
 &\quad + \int_0^1 \left[\frac{1}{2} (1-x)^2 - 2x^2(1-x) - \frac{1}{2} (x-1)^2 + 2x^2(x-1) \right] dx \\
 &= -4 \int_{-1}^0 (x^3 + x^2) dx + 4 \int_0^1 (x^3 + x^2) dx \\
 &= -4 \left[\frac{x^4}{4} + \frac{x^3}{3} \right]_{-1}^0 + 4 \left[\frac{x^4}{4} + \frac{x^3}{3} \right]_0^1 \\
 &= 4 \left[\frac{(-1)^4}{4} + \frac{(-1)^3}{3} \right] + 4 \left(\frac{1}{4} + \frac{1}{3} \right) = 8 \left(\frac{3}{12} - \frac{4}{12} \right) = -\frac{8}{12} = -\frac{2}{3}
 \end{aligned}$$

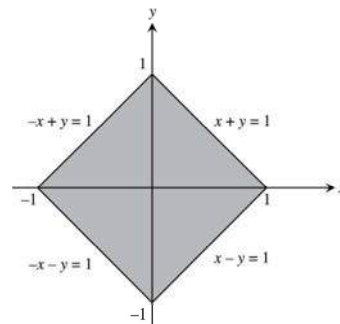

$$\begin{aligned}
 56. \iint_R xy \, dA &= \int_0^{2/3} \int_x^{2x} xy \, dy \, dx + \int_{2/3}^1 \int_x^{2-x} xy \, dy \, dx \\
 &= \int_0^{2/3} \left[\frac{1}{2} xy^2 \right]_x^{2x} dx + \int_{2/3}^1 \left[\frac{1}{2} xy^2 \right]_x^{2-x} dx \\
 &= \int_0^{2/3} \left(2x^3 - \frac{1}{2} x^3 \right) dx + \int_{2/3}^1 \left[\frac{1}{2} x(2-x)^2 - \frac{1}{2} x^3 \right] dx \\
 &= \int_0^{2/3} \frac{3}{2} x^3 dx + \int_{2/3}^1 (2x - x^2) dx \\
 &= \left[\frac{3}{8} x^4 \right]_0^{2/3} + \left[x^2 - \frac{2}{3} x^3 \right]_{2/3}^1 = \left(\frac{3}{8} \right) \left(\frac{16}{81} \right) + \left(1 - \frac{2}{3} \right) - \left[\frac{4}{9} - \left(\frac{2}{3} \right) \left(\frac{8}{27} \right) \right] = \frac{6}{81} + \frac{27}{81} - \left(\frac{36}{81} - \frac{16}{81} \right) = \frac{13}{81}
 \end{aligned}$$

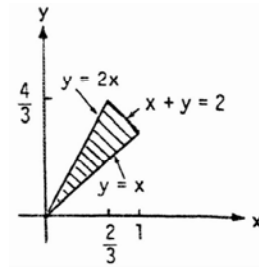

$$\begin{aligned}
 57. V &= \int_0^1 \int_x^{2-x} (x^2 + y^2) \, dy \, dx = \int_0^1 \left[x^2 y + \frac{y^3}{3} \right]_x^{2-x} dx = \int_0^1 \left[2x^2 - \frac{7x^3}{3} + \frac{(2-x)^3}{3} \right] dx = \left[\frac{2x^3}{3} - \frac{7x^4}{12} - \frac{(2-x)^4}{12} \right]_0^1 \\
 &= \left(\frac{2}{3} - \frac{7}{12} - \frac{1}{12} \right) - \left(0 - 0 - \frac{16}{12} \right) = \frac{4}{3}
 \end{aligned}$$

$$\begin{aligned}
 58. V &= \int_{-2}^1 \int_x^{2-x^2} x^2 \, dy \, dx = \int_{-2}^1 \left[x^2 y \right]_x^{2-x^2} dx = \int_{-2}^1 (2x^2 - x^4 - x^3) dx = \left[\frac{2}{3} x^3 - \frac{1}{5} x^5 - \frac{1}{4} x^4 \right]_{-2}^1 \\
 &= \left(\frac{2}{3} - \frac{1}{5} - \frac{1}{4} \right) - \left(-\frac{16}{3} + \frac{32}{5} - \frac{16}{4} \right) = \left(\frac{40}{60} - \frac{12}{60} - \frac{15}{60} \right) - \left(-\frac{320}{60} + \frac{384}{60} - \frac{240}{60} \right) = \frac{189}{60} = \frac{63}{20}
 \end{aligned}$$

$$\begin{aligned}
 59. V &= \int_{-4}^1 \int_{3x}^{4-x^2} (x+4) \, dy \, dx = \int_{-4}^1 [xy + 4y]_{3x}^{4-x^2} dx = \int_{-4}^1 \left[x(4-x^2) + 4(4-x^2) - 3x^2 - 12x \right] dx \\
 &= \int_{-4}^1 (-x^3 - 7x^2 - 8x + 16) dx = \left[-\frac{1}{4} x^4 - \frac{7}{3} x^3 - 4x^2 + 16x \right]_{-4}^1 = \left(-\frac{1}{4} - \frac{7}{3} + 12 \right) - \left(\frac{64}{3} - 64 \right) = \frac{157}{3} - \frac{1}{4} = \frac{625}{12}
 \end{aligned}$$

$$\begin{aligned}
 60. V &= \int_0^2 \int_0^{\sqrt{4-x^2}} (3-y) \, dy \, dx = \int_0^2 \left[3y - \frac{y^2}{2} \right]_0^{\sqrt{4-x^2}} dx = \int_0^2 \left[3\sqrt{4-x^2} - \frac{(4-x^2)}{2} \right] dx \\
 &= \left[\frac{3}{2} x\sqrt{4-x^2} + 6 \sin^{-1} \left(\frac{x}{2} \right) - 2x + \frac{x^3}{6} \right]_0^2 = 6 \left(\frac{\pi}{2} \right) - 4 + \frac{8}{6} = 3\pi - \frac{16}{6} = \frac{9\pi-8}{3}
 \end{aligned}$$

$$61. V = \int_0^2 \int_0^3 (4-y^2) \, dx \, dy = \int_0^2 [4x - y^2 x]_0^3 dy = \int_0^2 (12 - 3y^2) \, dy = \left[12y - y^3 \right]_0^2 = 24 - 8 = 16$$

$$\begin{aligned}
 62. V &= \int_0^2 \int_0^{4-x^2} (4-x^2-y) \, dy \, dx = \int_0^2 \left[(4-x^2)y - \frac{y^2}{2} \right]_0^{4-x^2} dx = \int_0^2 \frac{1}{2} (4-x^2)^2 dx = \int_0^2 \left(8 - 4x^2 + \frac{x^4}{2} \right) dx \\
 &= \left[8x - \frac{4}{3} x^3 + \frac{1}{10} x^5 \right]_0^2 = 16 - \frac{32}{3} + \frac{32}{10} = \frac{480-320+96}{30} = \frac{128}{15}
 \end{aligned}$$

$$63. V = \int_0^2 \int_0^{2-x} (12-3y^2) \, dy \, dx = \int_0^2 \left[12y - y^3 \right]_0^{2-x} dx = \int_0^2 \left[24 - 12x - (2-x)^3 \right] dx = \left[24x - 6x^2 + \frac{(2-x)^4}{4} \right]_0^2 = 20$$

$$64. V = \int_{-1}^0 \int_{-x-1}^{x+1} (3-3x) \, dy \, dx + \int_0^1 \int_{x-1}^{1-x} (3-3x) \, dy \, dx = 6 \int_{-1}^0 (1-x^2) dx + 6 \int_0^1 (1-x^2) dx = 4 + 2 = 6$$

65. $V = \int_1^2 \int_{-1/x}^{1/x} (x+1) dy dx = \int_1^2 [xy + y]_{-1/x}^{1/x} dx = \int_1^2 \left[1 + \frac{1}{x} - \left(-1 - \frac{1}{x}\right)\right] dx = 2 \int_1^2 \left(1 + \frac{1}{x}\right) dx = 2[x + \ln x]_1^2 = 2(1 + \ln 2)$

66. $V = 4 \int_0^{\pi/3} \int_0^{\sec x} (1+y^2) dy dx = 4 \int_0^{\pi/3} \left[y + \frac{y^3}{3}\right]_0^{\sec x} dx = 4 \int_0^{\pi/3} \left(\sec x + \frac{\sec^3 x}{3}\right) dx = \frac{2}{3} [7 \ln |\sec x + \tan x| + \sec x \tan x]_0^{\pi/3} = \frac{2}{3} [7 \ln (2 + \sqrt{3}) + 2\sqrt{3}]$

67.

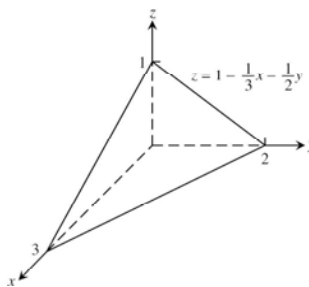
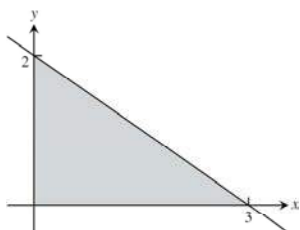

68.

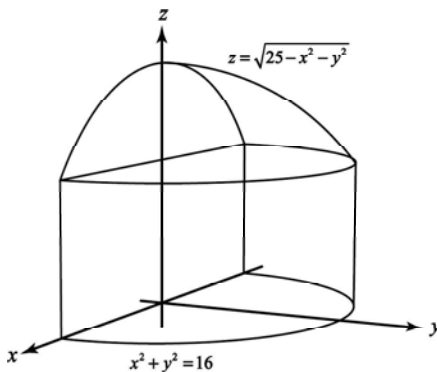
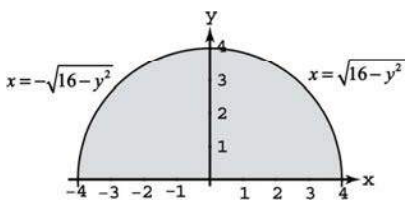

69. $\int_1^\infty \int_{e^{-x}}^1 \frac{1}{x^3 y} dy dx = \int_1^\infty \left[\frac{\ln y}{x^3}\right]_{e^{-x}}^1 dx = \int_1^\infty -\left(\frac{-x}{x^3}\right) dx = -\lim_{b \rightarrow \infty} \left[\frac{1}{x}\right]_1^b = -\lim_{b \rightarrow \infty} \left(\frac{1}{b} - 1\right) = 1$

70. $\int_{-1}^1 \int_{-1/\sqrt{1-x^2}}^{1/\sqrt{1-x^2}} (2y+1) dy dx = \int_{-1}^1 [y^2 + y]_{-1/\sqrt{1-x^2}}^{1/\sqrt{1-x^2}} dx = \int_{-1}^1 \frac{2}{\sqrt{1-x^2}} dx = 4 \lim_{b \rightarrow 1^-} [\sin^{-1} x]_0^b = 4 \lim_{b \rightarrow 1^-} [\sin^{-1} b - 0] = 2\pi$

71. $\int_{-\infty}^\infty \int_{-\infty}^\infty \frac{1}{(x^2+1)(y^2+1)} dx dy = 2 \int_0^\infty \left(\frac{2}{y^2+1}\right) \left(\lim_{b \rightarrow \infty} \tan^{-1} b - \tan^{-1} 0\right) dy = 2\pi \lim_{b \rightarrow \infty} \int_0^b \frac{1}{y^2+1} dy = 2\pi \left(\lim_{b \rightarrow \infty} \tan^{-1} b - \tan^{-1} 0\right) = (2\pi)\left(\frac{\pi}{2}\right) = \pi^2$

72. $\int_0^\infty \int_0^\infty x e^{-(x+2y)} dx dy = \int_0^\infty e^{-2y} \lim_{b \rightarrow \infty} [-xe^{-x} - e^{-x}]_0^b dy = \int_0^\infty e^{-2y} \lim_{b \rightarrow \infty} (-be^{-b} - e^{-b} + 1) dy = \int_0^\infty e^{-2y} dy = \frac{1}{2} \lim_{b \rightarrow \infty} (-e^{-2b} + 1) = \frac{1}{2}$

73. $\iint_R f(x, y) \, dA \approx \frac{1}{4} f\left(-\frac{1}{2}, 0\right) + \frac{1}{8} f(0, 0) + \frac{1}{8} f\left(\frac{1}{4}, 0\right) = \frac{1}{4}\left(-\frac{1}{2}\right) + \frac{1}{8}\left(0 + \frac{1}{4}\right) = -\frac{3}{32}$

74. $\iint_R f(x, y) \, dA \approx \frac{1}{4} \left[f\left(\frac{7}{4}, \frac{11}{4}\right) + f\left(\frac{9}{4}, \frac{11}{4}\right) + f\left(\frac{7}{4}, \frac{13}{4}\right) + f\left(\frac{9}{4}, \frac{13}{4}\right) \right] = \frac{1}{16} (29 + 31 + 33 + 35) = \frac{128}{16} = 8$

75. The ray $\theta = \frac{\pi}{6}$ meets the circle $x^2 + y^2 = 4$ at the point $(\sqrt{3}, 1) \Rightarrow$ the ray is represented by the line $y = \frac{x}{\sqrt{3}}$.

Thus, $\iint_R f(x, y) \, dA = \int_0^{\sqrt{3}} \int_{x/\sqrt{3}}^{\sqrt{4-x^2}} \sqrt{4-x^2} \, dy \, dx = \int_0^{\sqrt{3}} \left[(4-x^2) - \frac{x}{\sqrt{3}} \sqrt{4-x^2} \right] dx = \left[4x - \frac{x^3}{3} + \frac{(4-x^2)^{3/2}}{3\sqrt{3}} \right]_0^{\sqrt{3}}$
 $= \frac{20\sqrt{3}}{9}$

76. $\int_2^\infty \int_0^2 \frac{1}{(x^2-x)(y-1)^{2/3}} \, dy \, dx = \int_2^\infty \left[\frac{3(y-1)^{1/3}}{x^2-x} \right]_0^2 dx = \int_2^\infty \left(\frac{3}{x^2-x} + \frac{3}{x^2-x} \right) dx = 6 \int_2^\infty \frac{dx}{x(x-1)} = 6 \lim_{b \rightarrow \infty} \int_2^b \left(\frac{1}{x-1} - \frac{1}{x} \right) dx$
 $= 6 \lim_{b \rightarrow \infty} [\ln(x-1) - \ln x]_2^b = 6 \lim_{b \rightarrow \infty} [\ln(b-1) - \ln b - \ln 1 + \ln 2] = 6 \left[\lim_{b \rightarrow \infty} \ln\left(1 - \frac{1}{b}\right) + \ln 2 \right] = 6 \ln 2$

77. $V = \int_0^1 \int_x^{2-x} (x^2 + y^2) \, dy \, dx = \int_0^1 \left[x^2 y + \frac{y^3}{3} \right]_x^{2-x} dx$
 $= \int_0^1 \left[2x^2 - \frac{7x^3}{3} + \frac{(2-x)^3}{3} \right] dx = \left[\frac{2x^3}{3} - \frac{7x^4}{12} - \frac{(2-x)^4}{12} \right]_0^1$
 $= \left(\frac{2}{3} - \frac{7}{12} - \frac{1}{12} \right) - \left(0 - 0 - \frac{16}{12} \right) = \frac{4}{3}$

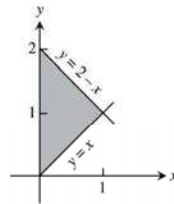

78. $\int_0^2 (\tan^{-1} \pi x - \tan^{-1} x) \, dx = \int_0^2 \int_x^{\pi x} \frac{1}{1+y^2} \, dy \, dx = \int_0^2 \int_{y/\pi}^y \frac{1}{1+y^2} \, dx \, dy + \int_2^{2\pi} \int_{y/\pi}^2 \frac{1}{1+y^2} \, dx \, dy$
 $= \int_0^2 \frac{(1-\frac{1}{\pi})y}{1+y^2} \, dy + \int_2^{2\pi} \frac{(2-\frac{y}{\pi})}{1+y^2} \, dy = \left(\frac{\pi-1}{2\pi} \right) \left[\ln(1+y^2) \right]_0^2 + \left[2 \tan^{-1} y + \frac{1}{2\pi} \ln(1+y^2) \right]_2^{2\pi}$
 $= \left(\frac{\pi-1}{2\pi} \right) \ln 5 + 2 \tan^{-1} 2\pi - \frac{1}{2\pi} \ln(1+4\pi^2) - 2 \tan^{-1} 2 + \frac{1}{2\pi} \ln 5$
 $= 2 \tan^{-1} 2\pi - 2 \tan^{-1} 2 - \frac{1}{2\pi} \ln(1+4\pi^2) + \frac{\ln 5}{2}$

79. To maximize the integral, we want the domain to include all points where the integrand is positive and to exclude all points where the integrand is negative. These criteria are met by the points (x, y) such that $4 - x^2 - 2y^2 \geq 0$ or $x^2 + 2y^2 \leq 4$, which is the ellipse $x^2 + 2y^2 = 4$ together with its interior.

80. To minimize the integral, we want the domain to include all points where the integrand is negative and to exclude all points where the integrand is positive. These criteria are met by the points (x, y) such that $x^2 + y^2 - 9 \leq 0$ or $x^2 + y^2 \leq 9$, which is the closed disk of radius 3 centered at the origin.

81. No, it is not possible. By Fubini's theorem, the two orders of integration must give the same result.

82. One way would be to partition R into two triangles with the line $y=1$. The integral of f over R could then be written as a sum of integrals that could be evaluated by integrating first with respect to x and then with respect to y :

$$\iint_R f(x, y) dA = \int_0^1 \int_{2-2y}^{2-(y/2)} f(x, y) dx dy + \int_1^2 \int_{y-1}^{2-(y/2)} f(x, y) dx dy.$$

Partitioning R with the line $x=1$ would let us write the integral of f over R as a sum of iterated integrals with order $dy dx$.

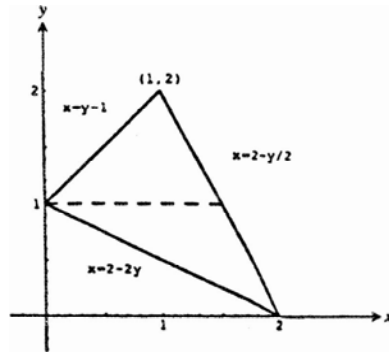

83.
$$\int_{-b}^b \int_{-b}^b e^{-x^2-y^2} dx dy = \int_{-b}^b \int_{-b}^b e^{-y^2} e^{-x^2} dx dy = \int_{-b}^b e^{-y^2} \left(\int_{-b}^b e^{-x^2} dx \right) dy = \left(\int_{-b}^b e^{-x^2} dx \right) \left(\int_{-b}^b e^{-y^2} dy \right)$$

$$= \left(\int_{-b}^b e^{-x^2} dx \right)^2 = \left(2 \int_0^b e^{-x^2} dx \right)^2 = 4 \left(\int_0^b e^{-x^2} dx \right)^2$$
; taking limits as $b \rightarrow \infty$ gives the stated result.

84.
$$\int_0^1 \int_0^3 \frac{x^2}{(y-1)^{2/3}} dy dx = \int_0^3 \int_0^1 \frac{x^2}{(y-1)^{2/3}} dx dy = \int_0^3 \frac{1}{(y-1)^{2/3}} \left[\frac{x^3}{3} \right]_0^1 dy = \frac{1}{3} \int_0^3 \frac{dy}{(y-1)^{2/3}}$$

$$= \frac{1}{3} \lim_{b \rightarrow 1^-} \int_0^b \frac{dy}{(y-1)^{2/3}} + \frac{1}{3} \lim_{b \rightarrow 1^+} \int_b^3 \frac{dy}{(y-1)^{2/3}} = \lim_{b \rightarrow 1^-} \left[(y-1)^{1/3} \right]_0^b + \lim_{b \rightarrow 1^+} \left[(y-1)^{1/3} \right]_b^3$$

$$= \left[\lim_{b \rightarrow 1^-} (b-1)^{1/3} - (-1)^{1/3} \right] - \left[\lim_{b \rightarrow 1^+} (b-1)^{1/3} - (2)^{1/3} \right] = (0+1) - (0-\sqrt[3]{2}) = 1 + \sqrt[3]{2}$$

- 85-88. Example CAS commands:

Maple:

```
f := (x,y) -> 1/x/y;
q1 := Int( Int( f(x,y) y=1..x), x=1..3);
evalf(q1);
value(q1);
evalf(value(q1));
```

- 89-94. Example CAS commands:

Maple:

```
f := (x,y) -> exp(x^2);
c,d := 0,1;
g1 := y -> 2*y;
g2 := y -> 4;
q5 := Int( Int( f(x,y), x=g1(y)..g2(y) ), y=c..d);
value(q5);
plot3d(0, (x=g1(y)..g2(y), y=c..d, color=pink, style=patchngrid, axes=boxed, orientation=[-90,0]
scaling=constrained, title="#89(Section 15.2)");
r5 := Int( Int( f(x,y), y=0..x/2), x=0..2) + Int( Int( f(x,y=0..1), x=2..4);
```

```
value(r5);
value(q5-t5);
```

85-94. Example CAS commands:

Mathematica: (functions and bounds will vary)

You can integrate using the built-in integral signs or with the command **Integrate**. In the **Integrate** command, the integration begins with the variable on the right. (In this case, y going from 1 to x).

```
Clear[x, y, f]
f[x_, y_] := 1 / (x y)
Integrate[f[x, y], {x, 1, 3}, {y, 1, x}]
```

To reverse the order of integration, it is best to first plot the region over which the integration extends. This can be done with **ImplicitPlot** and all bounds involving both x and y can be plotted. A graphics package must be loaded. Remember to use the double equal sign for the equations of the bounding curves.

```
Clear[x, y, f]
<<Graphics`ImplicitPlot`
ImplicitPlot[{x == 2y, x == 4, y == 0, y == 1}, {x, 0, 4.1}, {y, 0, 1.1}];
f[x_, y_] := Exp[x^2]
Integrate[f[x, y], {x, 0, 2}, {y, 0, x/2}] + Integrate[f[x, y], {x, 2, 4}, {y, 0, 1}]
```

To get a numerical value for the result, use the numerical integrator, **NIntegrate**. Verify that this equals the original.

```
Integrate[f[x, y], {x, 0, 2}, {y, 0, x/2}] + NIntegrate[f[x, y], {x, 2, 4}, {y, 0, 1}]
NIntegrate[f[x, y], {y, 0, 1}, {x, 2y, 4}]
```

Another way to show a region is with the **FilledPlot** command. This assumes that functions are given as $y=f(x)$.

```
Clear[x, y, f]
<<Graphics`FilledPlot`
FilledPlot[{x^2, 9}, {x, 0, 3}, AxesLabels -> {x, y}];
f[x_, y_] := x Cos[y^2]
Integrate[f[x, y], {y, 0, 9}, {x, 0, Sqrt[y]}]
```

$$85. \int_1^3 \int_1^x \frac{1}{xy} dy dx \approx 0.603$$

$$86. \int_0^1 \int_0^1 e^{-(x^2+y^2)} dy dx \approx 0.558$$

$$87. \int_0^1 \int_0^1 \tan^{-1} xy dy dx \approx 0.233$$

$$88. \int_{-1}^1 \int_0^{\sqrt{1-x^2}} 3\sqrt{1-x^2-y^2} dy dx \approx 3.142$$

89. Evaluate the integrals:

$$\begin{aligned} & \int_0^1 \int_{2y}^4 e^{x^2} dx dy \\ &= \int_0^2 \int_0^{x/2} e^{x^2} dy dx + \int_2^4 \int_0^1 e^{x^2} dy dx \\ &= -\frac{1}{4} + \frac{1}{4} \left(e^4 - 2\sqrt{\pi} \operatorname{erfi}(2) + 2\sqrt{\pi} \operatorname{erfi}(4) \right) \\ &\approx 1.1494 \times 10^6 \end{aligned}$$

The following graph was generated using Mathematica.

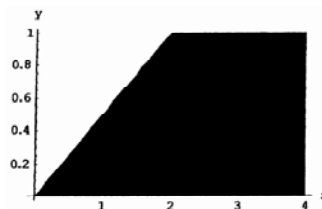

90. Evaluate the integrals:

$$\begin{aligned} & \int_0^3 \int_{x^2}^9 x \cos(y^2) dy dx = \int_0^9 \int_0^{\sqrt{y}} x \cos(y^2) dx dy \\ &= \frac{\sin(81)}{4} \approx -0.157472 \end{aligned}$$

The following graph was generated using Mathematica.

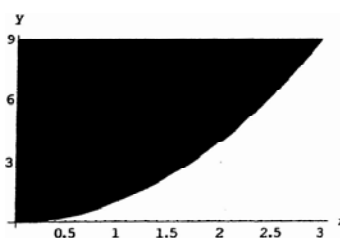

91. Evaluate the integrals:

$$\begin{aligned} & \int_0^2 \int_{y^3}^{4\sqrt{2y}} (x^2 y - xy^2) dx dy = \int_0^8 \int_{x^2/32}^{\sqrt[3]{x}} (x^2 y - xy^2) dy dx \\ &= \frac{67,520}{693} \approx 97.4315 \end{aligned}$$

The following graph was generated using Mathematica.

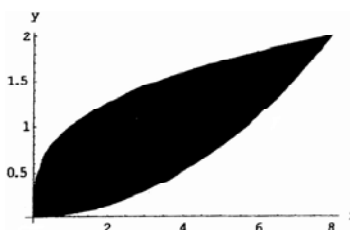

92. Evaluate the integrals:

$$\begin{aligned} & \int_0^2 \int_0^{4-y^2} e^{xy} dx dy = \int_0^4 \int_0^{\sqrt{4-x}} e^{xy} dy dx \\ &\approx 20.5648 \end{aligned}$$

The following graph was generated using Mathematica.

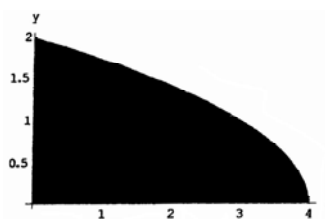

93. Evaluate the integrals:

$$\begin{aligned} & \int_1^2 \int_0^{x^2} \frac{1}{x+y} dy dx \\ &= \int_0^1 \int_1^2 \frac{1}{x+y} dx dy + \int_1^4 \int_{\sqrt{y}}^2 \frac{1}{x+y} dx dy \\ &= -1 + \ln\left(\frac{27}{4}\right) \approx 0.909543 \end{aligned}$$

The following graph was generated using Mathematica.

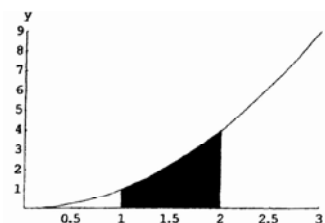

94. Evaluate the integrals:

$$\int_1^2 \int_{y^3}^8 \frac{1}{\sqrt{x^2+y^2}} dx dy = \int_1^8 \int_1^{\sqrt[3]{x}} \frac{1}{\sqrt{x^2+y^2}} dy dx$$

$$\approx 0.866649$$

The following graph was generated using Mathematica.

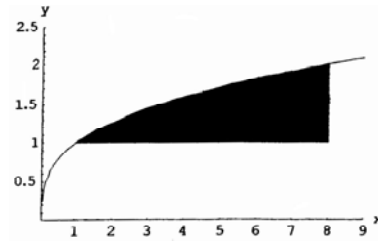

15.3 AREA BY DOUBLE INTEGRATION

1. $\int_0^2 \int_0^{2-x} dy dx = \int_0^2 (2-x) dx = \left[2x - \frac{x^2}{2} \right]_0^2 = 2,$
 or $\int_0^2 \int_0^{2-y} dx dy = \int_0^2 (2-y) dy = 2$

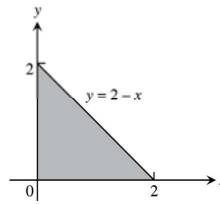

2. $\int_0^2 \int_{2x}^4 dy dx = \int_0^2 (4-2x) dx = \left[4x - x^2 \right]_0^2 = 4,$
 or $\int_0^4 \int_0^{y/2} dx dy = \int_0^4 \frac{y}{2} dy = 4$

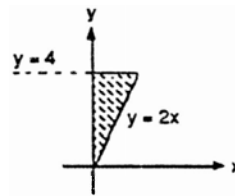

3. $\int_{-2}^1 \int_{y-2}^{-y^2} dx dy = \int_{-2}^1 (-y^2 - y + 2) dy$
 $= \left[-\frac{y^3}{3} - \frac{y^2}{2} + 2y \right]_{-2}^1$
 $= \left(-\frac{1}{3} - \frac{1}{2} + 2 \right) - \left(\frac{8}{3} - 2 - 4 \right) = \frac{9}{2}$

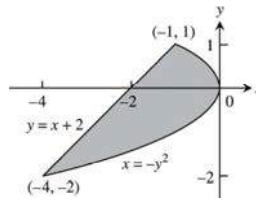

4. $\int_0^2 \int_{-y}^{y-y^2} dx dy = \int_0^2 (2y - y^2) dy = \left[y^2 - \frac{y^3}{3} \right]_0^2$
 $= 4 - \frac{8}{3} = \frac{4}{3}$

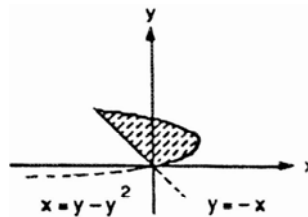

5. $\int_0^{\ln 2} \int_0^{e^x} dy dx = \int_0^{\ln 2} e^x dx = \left[e^x \right]_0^{\ln 2} = 2 - 1 = 1$

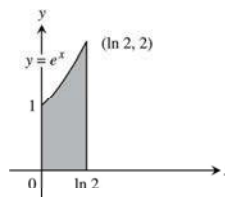

$$6. \int_1^e \int_{\ln x}^{2 \ln x} dy dx = \int_1^e \ln x dx = [x \ln x - x]_1^e = (e - e) - (0 - 1) = 1$$

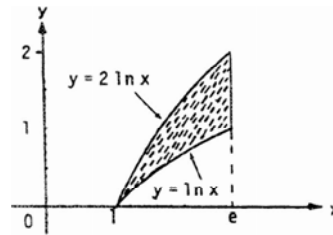

$$7. \int_0^1 \int_{y^2}^{2y-y^2} dx dy = \int_0^1 (2y - 2y^2) dy = \left[y^2 - \frac{2}{3} y^3 \right]_0^1 = \frac{1}{3}$$



$$8. \int_{-1}^1 \int_{2y^2-2}^{y^2-1} dx dy = \int_{-1}^1 (y^2 - 1 - 2y^2 + 2) dy = \int_{-1}^1 (1 - y^2) dy = \left[y - \frac{y^3}{3} \right]_{-1}^1 = \frac{4}{3}$$

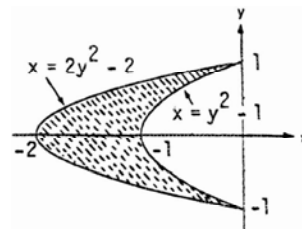

$$9. \int_0^2 \int_y^{3y} 1 dx dy = \int_0^2 [x]_y^{3y} dy = \int_0^2 (2y) dy = [y^2]_0^2 = 4$$

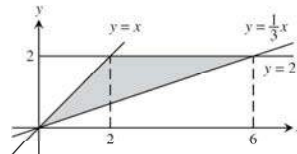

$$10. \int_1^2 \int_{1-y}^{\ln y} 1 dx dy = \int_1^2 [x]_{1-y}^{\ln y} dy = \int_1^2 (\ln y - 1 + y) dy = \left[y \ln y - 2y + \frac{y^2}{2} \right]_1^2 = 2 \ln 2 - \frac{1}{2}$$

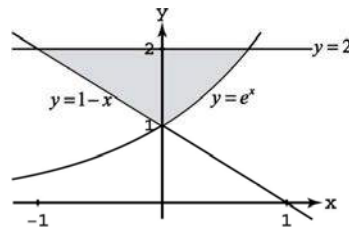

$$11. \int_0^1 \int_{x/2}^{2x} 1 dy dx + \int_1^2 \int_{x/2}^{3-x} 1 dy dx = \int_0^1 [y]_{x/2}^{2x} dx + \int_1^2 [y]_{x/2}^{3-x} dx = \int_0^1 \left(\frac{3}{2}x \right) dx + \int_1^2 \left(3 - \frac{3}{2}x \right) dx = \left[\frac{3}{4}x^2 \right]_0^1 + \left[3x - \frac{3}{4}x^2 \right]_1^2 = \frac{3}{2}$$

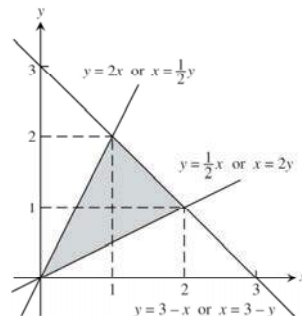

$$\begin{aligned}
 12. \quad & \int_0^1 \int_{-x}^{\sqrt{x}} 1 \, dy \, dx + \int_1^4 \int_{x-2}^{\sqrt{x}} 1 \, dy \, dx \\
 &= \int_0^1 [y]_{-x}^{\sqrt{x}} \, dx + \int_1^4 [y]_{x-2}^{\sqrt{x}} \, dx \\
 &= \int_0^1 (\sqrt{x} + x) \, dx + \int_1^4 (\sqrt{x} - x + 2) \, dx \\
 &= \left[\frac{2}{3}x^{3/2} + \frac{1}{2}x^2 \right]_0^1 + \left[\frac{2}{3}x^{3/2} - \frac{1}{2}x^2 + 2x \right]_1^4 = \frac{13}{3}
 \end{aligned}$$

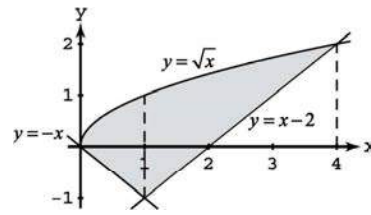

$$\begin{aligned}
 13. \quad & \int_0^6 \int_{y^2/3}^{2y} dx \, dy = \int_0^6 \left(2y - \frac{y^2}{3} \right) dy = \left[y^2 - \frac{y^3}{9} \right]_0^6 \\
 &= 36 - \frac{216}{9} = 12
 \end{aligned}$$

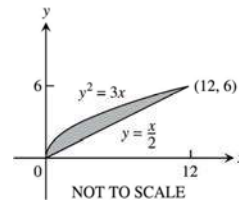

$$\begin{aligned}
 14. \quad & \int_0^3 \int_{-x}^{2x-x^2} dy \, dx = \int_0^3 (3x - x^2) \, dx = \left[\frac{3}{2}x^2 - \frac{1}{3}x^3 \right]_0^3 \\
 &= \frac{27}{2} - 9 = \frac{9}{2}
 \end{aligned}$$

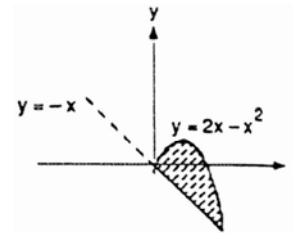

$$\begin{aligned}
 15. \quad & \int_0^{\pi/4} \int_{\sin x}^{\cos x} dy \, dx \\
 &= \int_0^{\pi/4} (\cos x - \sin x) \, dx = [\sin x + \cos x]_0^{\pi/4} \\
 &= \left(\frac{\sqrt{2}}{2} + \frac{\sqrt{2}}{2} \right) - (0 + 1) = \sqrt{2} - 1
 \end{aligned}$$

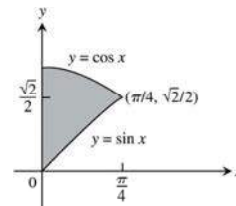

$$\begin{aligned}
 16. \quad & \int_{-1}^2 \int_{y^2}^{y+2} dx \, dy = \int_{-1}^2 (y + 2 - y^2) \, dy \\
 &= \left[\frac{y^2}{2} + 2y - \frac{y^3}{3} \right]_{-1}^2 = \left(2 + 4 - \frac{8}{3} \right) - \left(\frac{1}{2} - 2 + \frac{1}{3} \right) \\
 &= 5 - \frac{1}{2} = \frac{9}{2}
 \end{aligned}$$

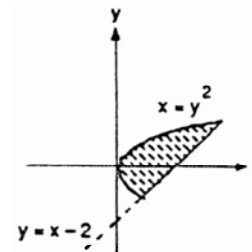

$$\begin{aligned}
 17. \quad & \int_{-1}^0 \int_{-2x}^{1-x} dy \, dx + \int_0^2 \int_{-x/2}^{1-x} dy \, dx \\
 &= \int_{-1}^0 (1+x) \, dx + \int_0^2 \left(1 - \frac{x}{2} \right) dx \\
 &= \left[x + \frac{x^2}{2} \right]_{-1}^0 + \left[x - \frac{x^2}{4} \right]_0^2 = -\left(-1 + \frac{1}{2} \right) + (2 - 1) = \frac{3}{2}
 \end{aligned}$$

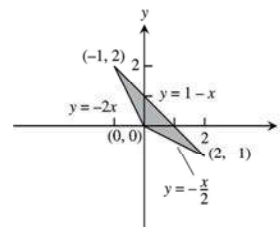

$$\begin{aligned}
 18. \quad & \int_0^2 \int_{x^2-4}^0 dy dx + \int_0^4 \int_0^{\sqrt{x}} dy dx \\
 &= \int_0^2 (4-x^2) dx + \int_0^4 x^{1/2} dx \\
 &= \left[4x - \frac{x^3}{3} \right]_0^2 + \left[\frac{2}{3} x^{3/2} \right]_0^4 = \left(8 - \frac{8}{3} \right) + \frac{16}{3} = \frac{32}{3}
 \end{aligned}$$

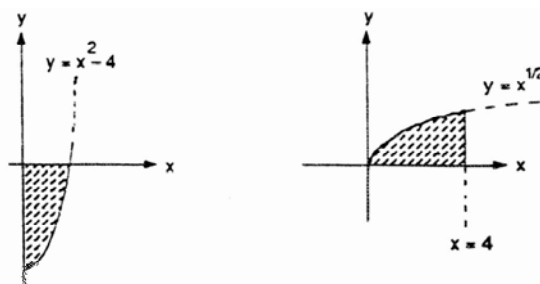

$$\begin{aligned}
 19. \quad (a) \quad \text{average} &= \frac{1}{\pi^2} \int_0^\pi \int_0^\pi \sin(x+y) dy dx = \frac{1}{\pi^2} \int_0^\pi [-\cos(x+y)]_0^\pi dx = \frac{1}{\pi^2} \int_0^\pi [-\cos(x+\pi) + \cos x] dx \\
 &= \frac{1}{\pi^2} [-\sin(x+\pi) + \sin x]_0^\pi = \frac{1}{\pi^2} [(-\sin 2\pi + \sin \pi) - (-\sin \pi + \sin 0)] = 0
 \end{aligned}$$

$$\begin{aligned}
 (b) \quad \text{average} &= \frac{1}{\left(\frac{\pi}{2}\right)^2} \int_0^{\pi/2} \int_0^{\pi/2} \sin(x+y) dy dx = \frac{2}{\pi^2} \int_0^{\pi/2} [-\cos(x+y)]_0^{\pi/2} dx = \frac{2}{\pi^2} \int_0^{\pi/2} [-\cos\left(x + \frac{\pi}{2}\right) + \cos x] dx \\
 &= \frac{2}{\pi^2} [-\sin\left(x + \frac{\pi}{2}\right) + \sin x]_0^{\pi/2} = \frac{2}{\pi^2} \left[(-\sin \frac{3\pi}{2} + \sin \pi) - (-\sin \frac{\pi}{2} + \sin 0) \right] = \frac{4}{\pi^2}
 \end{aligned}$$

$$20. \quad \text{average value over the square} = \int_0^1 \int_0^1 xy dy dx = \int_0^1 \left[\frac{xy^2}{2} \right]_0^1 dx = \int_0^1 \frac{x}{2} dx = \frac{1}{4} = 0.25;$$

$$\begin{aligned}
 \text{average value over the quarter circle} &= \frac{1}{\left(\frac{\pi}{4}\right)^2} \int_0^1 \int_0^{\sqrt{1-x^2}} xy dy dx = \frac{4}{\pi^2} \int_0^1 \left[\frac{xy^2}{2} \right]_0^{\sqrt{1-x^2}} dx = \frac{2}{\pi^2} \int_0^1 (x-x^3) dx \\
 &= \frac{2}{\pi^2} \left[\frac{x^2}{2} - \frac{x^4}{4} \right]_0^1 = \frac{1}{2\pi^2} \approx 0.159. \text{ The average value over the square is larger.}
 \end{aligned}$$

$$21. \quad \text{average height} = \frac{1}{4} \int_0^2 \int_0^2 (x^2 + y^2) dy dx = \frac{1}{4} \int_0^2 \left[x^2 y + \frac{y^3}{3} \right]_0^2 dx = \frac{1}{4} \int_0^2 \left(2x^2 + \frac{8}{3} \right) dx = \frac{1}{2} \left[\frac{x^3}{3} + \frac{4x}{3} \right]_0^2 = \frac{8}{3}$$

$$\begin{aligned}
 22. \quad \text{average} &= \frac{1}{(\ln 2)^2} \int_{\ln 2}^{2 \ln 2} \int_{\ln 2}^{2 \ln 2} \frac{1}{xy} dy dx = \frac{1}{(\ln 2)^2} \int_{\ln 2}^{2 \ln 2} \left[\frac{\ln y}{x} \right]_{\ln 2}^{2 \ln 2} dx = \frac{1}{(\ln 2)^2} \int_{\ln 2}^{2 \ln 2} \frac{1}{x} (\ln 2 + \ln \ln 2 - \ln \ln 2) dx \\
 &= \left(\frac{1}{\ln 2} \right) \int_{\ln 2}^{2 \ln 2} \frac{dx}{x} = \left(\frac{1}{\ln 2} \right) [\ln x]_{\ln 2}^{2 \ln 2} = \left(\frac{1}{\ln 2} \right) (\ln 2 + \ln \ln 2 - \ln \ln 2) = 1
 \end{aligned}$$

23. The region R is shaded in the following figure.

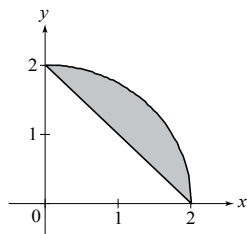

$$\iint_R dA = \int_0^2 \int_{2-x}^{\sqrt{4-x^2}} 1 dy dx = \int_0^2 \left(\sqrt{4-x^2} - (2-x) \right) dx = \left(\frac{x}{2} \sqrt{4-x^2} + 2 \sin^{-1} \frac{x}{2} + \frac{x^2}{2} - 2x \right) \Big|_0^2 = \pi - 2, \text{ where}$$

we use integration by parts with $u = \sqrt{4-x^2}$ and $dv = 1/2$ to find $\int \sqrt{4-x^2} dx$. Geometrically, the region R is a quarter of a circle of radius 2 with a triangle of area 2 removed, giving area $\pi - 2$.

24. The area of the region R is 4 times the shaded in the following figure.

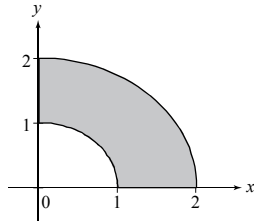

The area integral will be easy to compute in polar coordinates, but in rectangular coordinates the calculation is awkward.

$$\iint_R dA = 4 \left[\int_0^1 \int_{\sqrt{1-x^2}}^{\sqrt{4-x^2}} 1 \, dy \, dx + \int_1^2 \int_0^{\sqrt{4-x^2}} 1 \, dy \, dx \right] = 4 \left[\left(\frac{\sqrt{3}}{2} + \frac{\pi}{12} \right) + \left(\frac{2\pi}{3} - \frac{\sqrt{3}}{2} \right) \right] = 4 \frac{3\pi}{4} = 3\pi$$

(As in Exercise 23, use integration by parts to evaluate the integrals $\int \sqrt{4-x^2} \, dx$ and $\int \sqrt{1-x^2} \, dx$.)

Geometrically the area is the difference between the area of a circle of radius 2 and the area of a circle of radius 1, or $4\pi - \pi = 3\pi$.

$$\begin{aligned} 25. \quad \int_{-5}^5 \int_{-2}^0 \frac{10,000e^{xy}}{1+\frac{|x|}{2}} \, dy \, dx &= 10,000(1-e^{-2}) \int_{-5}^5 \frac{dx}{1+\frac{|x|}{2}} = 10,000(1-e^{-2}) \left[\int_{-5}^0 \frac{dx}{1+\frac{x}{2}} + \int_0^5 \frac{dx}{1+\frac{x}{2}} \right] \\ &= 10,000(1-e^{-2}) \left[-2 \ln\left(1-\frac{x}{2}\right) \right]_{-5}^0 + 10,000(1-e^{-2}) \left[2 \ln\left(1+\frac{x}{2}\right) \right]_0^5 \\ &= 10,000(1-e^{-2}) \left[2 \ln\left(1+\frac{5}{2}\right) \right] + 10,000(1-e^{-2}) \left[2 \ln\left(1+\frac{5}{2}\right) \right] = 40,000(1-e^{-2}) \ln\left(\frac{7}{2}\right) \approx 43,329 \end{aligned}$$

$$\begin{aligned} 26. \quad \int_0^1 \int_{y^2}^{2y-y^2} 100(y+1) \, dx \, dy &= \int_0^1 [100(y+1)x]_{y^2}^{2y-y^2} \, dy = \int_0^1 100(y+1)(2y-2y^2) \, dy = 200 \int_0^1 (y-y^3) \, dy \\ &= 200 \left[\frac{y^2}{2} - \frac{y^4}{4} \right]_0^1 = (200) \left(\frac{1}{4} \right) = 50 \end{aligned}$$

27. Let (x_i, y_i) be the location of the weather station in county i for $i = 1, \dots, 254$. The average temperature in

Texas at time t_0 is approximately $\frac{\sum_{i=1}^{254} T(x_i, y_i) \Delta A_i}{A}$, where $T(x_i, y_i)$ is the temperature at time t_0 at the weather station in county i , ΔA_i is the area of country i , and A is the area of Texas.

$$\begin{aligned} 28. \quad \text{Let } y = f(x) \text{ be a nonnegative, continuous function on } [a, b], \text{ then } A &= \iint_R dA = \int_a^b \int_0^{f(x)} dy \, dx = \int_a^b [y]_0^{f(x)} dx \\ &= \int_a^b f(x) \, dx \end{aligned}$$

29. Since f is continuous on R , if $m \leq f(x, y) \leq M$, property 3(b) of double integrals gives us

$$\iint_R m \, dA \leq \iint_R f(x, y) \, dA \leq \iint_R M \, dA \quad \text{and hence } mA(R) \leq \iint_R f(x, y) \, dA \leq MA(R).$$

30. If $f(x, y)$ is positive at some point P in R or on the boundary of R then by the continuity of f there is a disk of positive radius around P (or if P is on the boundary, the intersection of such a disk with R) on which $f(x, y)$ is positive. This sub-region will make a positive contribution to the area $\iint_R f(x, y) dA$, and since $f(x, y)$ is never negative, $\iint_R f(x, y) dA$ will be greater than 0. This contradicts our assumption that $\iint_R f(x, y) dA = 0$, so $f(x, y)$ is positive nowhere on R and is thus equal to 0 at every point of R .

15.4 DOUBLE INTEGRALS IN POLAR FORM

- $x^2 + y^2 = 9^2 \Rightarrow r = 9 \Rightarrow \frac{\pi}{2} \leq \theta \leq 2\pi, 0 \leq r \leq 9$
- $x^2 + y^2 = 1^2 \Rightarrow r = 1, x^2 + y^2 = 4^2 \Rightarrow r = 4 \Rightarrow -\frac{\pi}{2} \leq \theta \leq \frac{\pi}{2}, 1 \leq r \leq 4$
- $y = x \Rightarrow \theta = \frac{\pi}{4}, y = -x \Rightarrow \theta = \frac{3\pi}{4}, y = 1 \Rightarrow r = \csc \theta \Rightarrow \frac{\pi}{4} \leq \theta \leq \frac{3\pi}{4}, 0 \leq r \leq \csc \theta$
- $x = 1 \Rightarrow r = \sec \theta, y = \sqrt{3}x \Rightarrow \theta = \frac{\pi}{3} \Rightarrow 0 \leq \theta \leq \frac{\pi}{3}, 0 \leq r \leq \sec \theta$
- $x^2 + y^2 = 1^2 \Rightarrow r = 1, x = 2\sqrt{3} \Rightarrow r = 2\sqrt{3} \sec \theta, y = 2 \Rightarrow r = 2 \csc \theta;$
 $2\sqrt{3} \sec \theta = 2 \csc \theta \Rightarrow \theta = \frac{\pi}{6} \Rightarrow 0 \leq \theta \leq \frac{\pi}{6}, 1 \leq r \leq 2\sqrt{3} \sec \theta; \frac{\pi}{6} \leq \theta \leq \frac{\pi}{2}, 1 \leq r \leq 2\sqrt{3} \csc \theta$
- $x^2 + y^2 = 2^2 \Rightarrow r = 2, x = 1 \Rightarrow r = \sec \theta; 2 = \sec \theta \Rightarrow \theta = \frac{\pi}{3}$ or $\theta = -\frac{\pi}{3} \Rightarrow -\frac{\pi}{3} \leq \theta \leq \frac{\pi}{3}, \sec \theta \leq r \leq 2$
- $x^2 + y^2 = 2x \Rightarrow r = 2 \cos \theta \Rightarrow -\frac{\pi}{2} \leq \theta \leq \frac{\pi}{2}, 0 \leq r \leq 2 \cos \theta$
- $x^2 + y^2 = 2y \Rightarrow r = 2 \sin \theta \Rightarrow 0 \leq \theta \leq \pi, 0 \leq r \leq 2 \sin \theta$
- $\int_{-1}^1 \int_0^{\sqrt{1-x^2}} dy dx = \int_0^\pi \int_0^1 r dr d\theta = \frac{1}{2} \int_0^\pi d\theta = \frac{\pi}{2}$
- $\int_0^1 \int_0^{\sqrt{1-y^2}} (x^2 + y^2) dx dy = \int_0^{\pi/2} \int_0^1 r^3 dr d\theta = \frac{1}{4} \int_0^{\pi/2} d\theta = \frac{\pi}{8}$
- $\int_0^2 \int_0^{\sqrt{4-y^2}} (x^2 + y^2) dx dy = \int_0^{\pi/2} \int_0^2 r^3 dr d\theta = 4 \int_0^{\pi/2} d\theta = 2\pi$
- $\int_{-a}^a \int_{-\sqrt{a^2-x^2}}^{\sqrt{a^2-x^2}} dy dx = \int_0^{2\pi} \int_0^a r dr d\theta = \frac{a^2}{2} \int_0^{2\pi} d\theta = \pi a^2$
- $\int_0^6 \int_0^y x dx dy = \int_{\pi/4}^{\pi/2} \int_0^{6 \csc \theta} r^2 \cos \theta dr d\theta = 72 \int_{\pi/4}^{\pi/2} \cot \theta \csc^2 \theta d\theta = -36 \left[\cot^2 \theta \right]_{\pi/4}^{\pi/2} = 36$

$$14. \int_0^2 \int_0^x y \, dy \, dx = \int_0^{\pi/4} \int_0^{2 \sec \theta} r^2 \sin \theta \, dr \, d\theta = \frac{8}{3} \int_0^{\pi/4} \tan \theta \sec^2 \theta \, d\theta = \frac{4}{3}$$

$$15. \int_1^{\sqrt{3}} \int_1^x dy \, dx = \int_{\pi/6}^{\pi/4} \int_{\csc \theta}^{\sqrt{3} \sec \theta} r \, dr \, d\theta = \int_{\pi/6}^{\pi/4} \left(\frac{3}{2} \sec^2 \theta - \frac{1}{2} \csc^2 \theta \right) d\theta = \left[\frac{3}{2} \tan \theta + \frac{1}{2} \cot \theta \right]_{\pi/6}^{\pi/4} = 2 - \sqrt{3}$$

$$16. \int_{\sqrt{2}}^2 \int_{\sqrt{4-y^2}}^y dy \, dx = \int_{\pi/4}^{\pi/2} \int_2^{2 \csc \theta} r \, dr \, d\theta = \int_{\pi/4}^{\pi/2} (2 \csc^2 \theta - 2) \, d\theta = \left[-2 \cot \theta - \frac{1}{2} \theta \right]_{\pi/4}^{\pi/2} = 2 - \frac{\pi}{2}$$

$$17. \int_{-1}^0 \int_{-\sqrt{1-x^2}}^0 \frac{2}{1+\sqrt{x^2+y^2}} \, dy \, dx = \int_{\pi}^{3\pi/2} \int_0^1 \frac{2r}{1+r} \, dr \, d\theta = 2 \int_{\pi}^{3\pi/2} \int_0^1 \left(1 - \frac{1}{1+r} \right) \, dr \, d\theta = 2 \int_{\pi}^{3\pi/2} (1 - \ln 2) \, d\theta = (1 - \ln 2)\pi$$

$$18. \int_{-1}^1 \int_{-\sqrt{1-x^2}}^{\sqrt{1-x^2}} \frac{2}{(1+x^2+y^2)^2} \, dy \, dx = 4 \int_0^{\pi/2} \int_0^1 \frac{2r}{(1+r^2)^2} \, dr \, d\theta = 4 \int_0^{\pi/2} \left[-\frac{1}{1+r^2} \right]_0^1 \, d\theta = 2 \int_0^{\pi/2} d\theta = \pi$$

$$19. \int_0^{\ln 2} \int_0^{\sqrt{(\ln 2)^2 - y^2}} e^{\sqrt{x^2+y^2}} \, dx \, dy = \int_0^{\pi/2} \int_0^{\ln 2} r e^r \, dr \, d\theta = \int_0^{\pi/2} (2 \ln 2 - 1) \, d\theta = \frac{\pi}{2} (2 \ln 2 - 1)$$

$$20. \int_{-1}^1 \int_{-\sqrt{1-y^2}}^{\sqrt{1-y^2}} \ln(x^2 + y^2 + 1) \, dx \, dy = 4 \int_0^{\pi/2} \int_0^1 \ln(r^2 + 1) r \, dr \, d\theta = 2 \int_0^{\pi/2} (\ln 4 - 1) \, d\theta = \pi(\ln 4 - 1)$$

$$21. \int_0^1 \int_x^{\sqrt{2-x^2}} (x+2y) \, dy \, dx = \int_{\pi/4}^{\pi/2} \int_0^{\sqrt{2}} (r \cos \theta + 2r \sin \theta) r \, dr \, d\theta = \int_{\pi/4}^{\pi/2} \left[\frac{r^3}{3} \cos \theta + \frac{2r^3}{3} \sin \theta \right]_0^{\sqrt{2}} \, d\theta$$

$$= \int_{\pi/4}^{\pi/2} \left(\frac{2\sqrt{2}}{3} \cos \theta + \frac{4\sqrt{2}}{3} \sin \theta \right) \, d\theta = \left[\frac{2\sqrt{2}}{3} \sin \theta - \frac{4\sqrt{2}}{3} \cos \theta \right]_{\pi/4}^{\pi/2} = \frac{2(1+\sqrt{2})}{3}$$

$$22. \int_1^2 \int_0^{\sqrt{2x-x^2}} \frac{1}{(x^2+y^2)^2} \, dy \, dx = \int_0^{\pi/4} \int_{\sec \theta}^{2 \cos \theta} \frac{1}{r^4} r \, dr \, d\theta = \int_0^{\pi/4} \left[-\frac{1}{2r^2} \right]_{\sec \theta}^{2 \cos \theta} \, d\theta = \int_0^{\pi/4} \left(\frac{1}{2} \cos^2 \theta - \frac{1}{8} \sec^2 \theta \right) \, d\theta$$

$$= \left[\frac{1}{4} \theta + \frac{1}{8} \sin 2\theta - \frac{1}{8} \tan \theta \right]_0^{\pi/4} = \frac{\pi}{16}$$

$$23. \int_0^1 \int_0^{\sqrt{1-x^2}} x y \, dy \, dx \quad \text{or} \quad \int_0^1 \int_0^{\sqrt{1-y^2}} x y \, dy \, dx$$

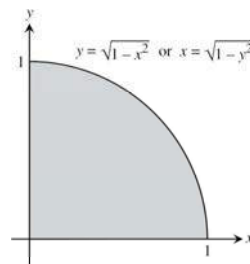

$$24. \int_{1/2}^1 \int_{\sqrt{1-y^2}}^{\sqrt{3}y} x \, dx \, dy \text{ or}$$

$$\int_0^{\sqrt{3}/2} \int_{\sqrt{1-x^2}}^1 x \, dy \, dx + \int_{\sqrt{3}/2}^1 \int_{x/\sqrt{3}}^1 x \, dy \, dx$$

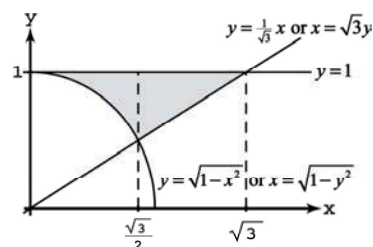

$$25. \int_0^2 \int_0^x y^2 (x^2 + y^2) \, dy \, dx \text{ or}$$

$$\int_0^2 \int_y^2 y^2 (x^2 + y^2) \, dx \, dy$$

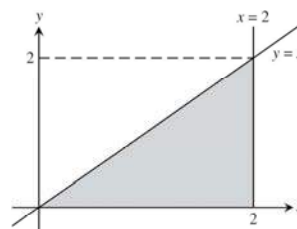

$$26. \int_0^3 \int_0^4 (x^2 + y^2)^3 \, dy \, dx \text{ or } \int_0^4 \int_0^3 (x^2 + y^2)^3 \, dx \, dy$$

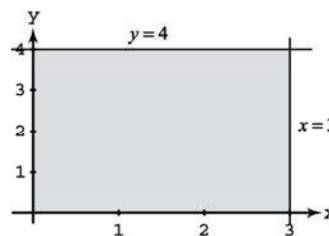

$$27. \int_0^{\pi/2} \int_0^{2\sqrt{2-\sin 2\theta}} r \, dr \, d\theta = 2 \int_0^{\pi/2} (2 - \sin 2\theta) \, d\theta = 2(\pi - 1)$$

$$28. A = 2 \int_0^{\pi/2} \int_1^{1+\cos\theta} r \, dr \, d\theta = \int_0^{\pi/2} (2 \cos\theta + \cos^2\theta) \, d\theta = \frac{8+\pi}{4}$$

$$29. A = 2 \int_0^{\pi/6} \int_0^{12\cos 3\theta} r \, dr \, d\theta = 144 \int_0^{\pi/6} \cos^2 3\theta \, d\theta = 12\pi$$

$$30. A = \int_0^{2\pi} \int_0^{4\theta/3} r \, dr \, d\theta = \frac{8}{9} \int_0^{2\pi} \theta^2 \, d\theta = \frac{64\pi^3}{27}$$

$$31. A = \int_0^{\pi/2} \int_0^{1+\sin\theta} r \, dr \, d\theta = \frac{1}{2} \int_0^{\pi/2} \left(\frac{3}{2} + 2 \sin\theta - \frac{\cos 2\theta}{2} \right) \, d\theta = \frac{3\pi}{8} + 1$$

$$32. A = 4 \int_0^{\pi/2} \int_0^{1-\cos\theta} r \, dr \, d\theta = 2 \int_0^{\pi/2} \left(\frac{3}{2} - 2 \cos\theta + \frac{\cos 2\theta}{2} \right) \, d\theta = \frac{3\pi}{2} - 4$$

$$33. \text{average} = \frac{4}{\pi a^2} \int_0^{\pi/2} \int_0^a r \sqrt{a^2 - r^2} \, dr \, d\theta = \frac{4}{3\pi a^2} \int_0^{\pi/2} a^3 \, d\theta = \frac{2a}{3}$$

$$34. \text{average} = \frac{4}{\pi a^2} \int_0^{\pi/2} \int_0^a r^2 \, dr \, d\theta = \frac{4}{3\pi a^2} \int_0^{\pi/2} a^3 \, d\theta = \frac{2a}{3}$$

$$35. \text{ average} = \frac{1}{\pi a^2} \int_{-a}^a \int_{-\sqrt{a^2-x^2}}^{\sqrt{a^2-x^2}} \sqrt{x^2+y^2} \, dy \, dx = \frac{1}{\pi a^2} \int_0^{2\pi} \int_0^a r^2 \, dr \, d\theta = \frac{a}{3\pi} \int_0^{2\pi} d\theta = \frac{2a}{3}$$

$$36. \text{ average} = \frac{1}{\pi} \iint_R [(1-x)^2 + y^2] \, dy \, dx = \frac{1}{\pi} \int_0^{2\pi} \int_0^1 [(1-r\cos\theta)^2 + r^2 \sin^2\theta] r \, dr \, d\theta$$

$$= \frac{1}{\pi} \int_0^{2\pi} \int_0^1 (r^3 - 2r^2 \cos\theta + r) \, dr \, d\theta = \frac{1}{\pi} \int_0^{2\pi} \left(\frac{3}{4} - \frac{2\cos\theta}{3}\right) d\theta = \frac{1}{\pi} \left[\frac{3}{4}\theta - \frac{2\sin\theta}{3}\right]_0^{2\pi} = \frac{3}{2}$$

$$37. \int_0^{2\pi} \int_1^{\sqrt{e}} \left(\frac{\ln r^2}{r}\right) r \, dr \, d\theta = \int_0^{2\pi} \int_1^{\sqrt{e}} 2 \ln r \, dr \, d\theta = 2 \int_0^{2\pi} [r \ln r - r]_1^{\sqrt{e}} d\theta = 2 \int_0^{2\pi} \sqrt{e} \left[\left(\frac{1}{2}-1\right) + 1\right] d\theta = 2\pi(2-\sqrt{e})$$

$$38. \int_0^{2\pi} \int_1^e \left(\frac{\ln r^2}{r}\right) dr \, d\theta = \int_0^{2\pi} \int_1^e \left(\frac{2 \ln r}{r}\right) dr \, d\theta = \int_0^{2\pi} [(\ln r)^2]_1^e d\theta = \int_0^{2\pi} d\theta = 2\pi$$

$$39. V = 2 \int_0^{\pi/2} \int_1^{1+\cos\theta} r^2 \cos\theta \, dr \, d\theta = \frac{2}{3} \int_0^{\pi/2} (3 \cos^2\theta + 3 \cos^3\theta + \cos^4\theta) d\theta$$

$$= \frac{2}{3} \left[\frac{15\theta}{8} + \sin 2\theta + 3 \sin\theta - \sin^3\theta + \frac{\sin 4\theta}{32}\right]_0^{\pi/2} = \frac{4}{3} + \frac{5\pi}{8}$$

$$40. V = 4 \int_0^{\pi/4} \int_0^{\sqrt{2\cos 2\theta}} r \sqrt{2-r^2} \, dr \, d\theta = -\frac{4}{3} \int_0^{\pi/4} [(2-2\cos 2\theta)^{3/2} - 2^{3/2}] d\theta$$

$$= \frac{2\pi\sqrt{2}}{3} - \frac{32}{3} \int_0^{\pi/4} (1-\cos 2\theta) \sin\theta \, d\theta = \frac{2\pi\sqrt{2}}{3} - \frac{32}{3} \left[\frac{\cos^3\theta}{3} - \cos\theta\right]_0^{\pi/4} = \frac{6\pi\sqrt{2}+40\sqrt{2}-64}{9}$$

$$41. (a) I^2 = \int_0^\infty \int_0^\infty e^{-(x^2+y^2)} dx \, dy = \int_0^{\pi/2} \int_0^\infty (e^{-r^2}) r \, dr \, d\theta = \int_0^{\pi/2} \left[\lim_{b \rightarrow \infty} \int_0^b r e^{-r^2} \, dr\right] d\theta$$

$$= -\frac{1}{2} \int_0^{\pi/2} \lim_{b \rightarrow \infty} (e^{-b^2} - 1) d\theta = \frac{1}{2} \int_0^{\pi/2} d\theta = \frac{\pi}{4} \Rightarrow I = \frac{\sqrt{\pi}}{2}$$

$$(b) \lim_{x \rightarrow \infty} \int_0^x \frac{2e^{-t^2}}{\sqrt{\pi}} dt = \frac{2}{\sqrt{\pi}} \int_0^\infty e^{-t^2} dt = \left(\frac{2}{\sqrt{\pi}}\right) \left(\frac{\sqrt{\pi}}{2}\right) = 1, \text{ from part (a)}$$

$$42. \int_0^\infty \int_0^\infty \frac{1}{(1+x^2+y^2)^2} dx \, dy = \int_0^{\pi/2} \int_0^\infty \frac{r}{(1+r^2)^2} dr \, d\theta = \frac{\pi}{2} \lim_{b \rightarrow \infty} \int_0^b \frac{r}{(1+r^2)^2} dr = \frac{\pi}{4} \lim_{b \rightarrow \infty} \left[1 - \frac{1}{1+r^2}\right]_0^b = \frac{\pi}{4} \lim_{b \rightarrow \infty} \left(1 - \frac{1}{1+b^2}\right)$$

$$= \frac{\pi}{4}$$

$$43. \text{ Over the disk } x^2 + y^2 \leq \frac{3}{4}: \iint_R \frac{1}{1-x^2-y^2} dA = \int_0^{2\pi} \int_0^{\sqrt{3}/2} \frac{r}{1-r^2} dr \, d\theta = \int_0^{2\pi} \left[-\frac{1}{2} \ln(1-r^2)\right]_0^{\sqrt{3}/2} d\theta$$

$$= \int_0^{2\pi} \left(-\frac{1}{2} \ln \frac{1}{4}\right) d\theta = (\ln 2) \int_0^{2\pi} d\theta = \pi \ln 4$$

$$\text{Over the disk } x^2 + y^2 \leq 1: \iint_R \frac{1}{1-x^2-y^2} dA = \int_0^{2\pi} \int_0^1 \frac{r}{1-r^2} dr \, d\theta = \int_0^{2\pi} \left[\lim_{a \rightarrow 1^-} \int_0^a \frac{r}{1-r^2} dr\right] d\theta$$

$$= \int_0^{2\pi} \lim_{a \rightarrow 1^-} \left[-\frac{1}{2} \ln(1-a^2)\right] d\theta = 2\pi \cdot \lim_{a \rightarrow 1^-} \left[-\frac{1}{2} \ln(1-a^2)\right] = 2\pi \cdot \infty, \text{ so the integral does not exist over } x^2 + y^2 \leq 1$$

44. The area in polar coordinates is given by $A = \int_{\alpha}^{\beta} \int_0^{f(\theta)} r \, dr \, d\theta = \int_{\alpha}^{\beta} \left[\frac{r^2}{2} \right]_0^{f(\theta)} d\theta = \frac{1}{2} \int_{\alpha}^{\beta} f^2(\theta) \, d\theta = \int_{\alpha}^{\beta} \frac{1}{2} r^2 \, d\theta$, where $r = f(\theta)$

45.
$$\begin{aligned} \text{average} &= \frac{1}{\pi a^2} \int_0^{2\pi} \int_0^a [(r \cos \theta - h)^2 + r^2 \sin^2 \theta] r \, dr \, d\theta = \frac{1}{\pi a^2} \int_0^{2\pi} \int_0^a (r^3 - 2r^2 h \cos \theta + rh^2) \, dr \, d\theta \\ &= \frac{1}{\pi a^2} \int_0^{2\pi} \left(\frac{a^4}{4} - \frac{2a^3 h \cos \theta}{3} + \frac{a^2 h^2}{2} \right) d\theta = \frac{1}{\pi} \int_0^{2\pi} \left(\frac{a^2}{4} - \frac{2ah \cos \theta}{3} + \frac{h^2}{2} \right) d\theta = \frac{1}{\pi} \left[\frac{a^2 \theta}{4} - \frac{2ah \sin \theta}{3} + \frac{h^2 \theta}{2} \right]_0^{2\pi} \\ &= \frac{1}{2} (a^2 + 2h^2) \end{aligned}$$

46.
$$\begin{aligned} A &= \int_{\pi/4}^{3\pi/4} \int_{\csc \theta}^{2 \sin \theta} r \, dr \, d\theta \\ &= \frac{1}{2} \int_{\pi/4}^{3\pi/4} (4 \sin^2 \theta - \csc^2 \theta) \, d\theta \\ &= \frac{1}{2} [2\theta - \sin 2\theta + \cot \theta]_{\pi/4}^{3\pi/4} = \frac{\pi}{2} \end{aligned}$$

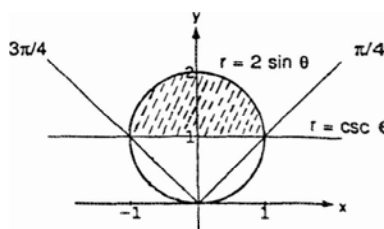

47. The region R is shaded in the graph below.

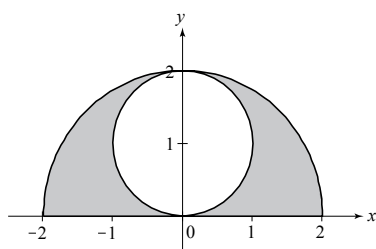

The polar equation of the outer circle is just $r = 2$. The inner circle is $x^2 + (y - 1)^2 = 1$ or $x^2 + y^2 = 2y$. This is equivalent to $r^2 = 2r \sin \theta$ or $r = 2 \sin \theta$. The integrand is r in polar coordinates, so

$$\begin{aligned} \iint_R \sqrt{x^2 + y^2} \, dA &= \int_0^{\pi} \int_{2 \sin \theta}^2 r \cdot r \, dr \, d\theta \\ &= \int_0^{\pi} \left[\frac{r^3}{3} \right]_{2 \sin \theta}^2 d\theta = \int_0^{\pi} \frac{8}{3} (1 - \sin^3 \theta) \, d\theta \end{aligned}$$

Write the integrand as $\frac{8}{3} (1 - \sin \theta (1 - \cos^2 \theta))$. The indefinite integral is then $\frac{8}{3} \left(\theta + \cos \theta - \frac{1}{3} \cos^3 \theta \right)$ and the

definite integral is $\frac{8}{3} \left(\theta + \cos \theta - \frac{1}{3} \cos^3 \theta \right) \Big|_0^{\pi} = \frac{8}{9} (3\pi - 4)$

48. The region R is shaded in the graph below.

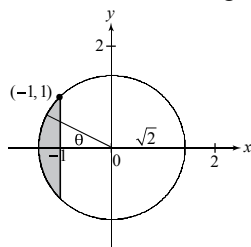

As θ ranges from $3\pi/4$ to $5\pi/4$ the ray at angle θ enters R at $r = \sec\theta$ and leaves R at $r = \sqrt{2}$. Thus

$$\begin{aligned} \iint_R (x^2 + y^2)^{-2} dA &= \int_{3\pi/4}^{5\pi/4} \int_{\sec\theta}^{\sqrt{2}} r^{-4} \cdot r dr d\theta \\ &= \int_{3\pi/4}^{5\pi/4} \left[-\frac{1}{2} r^{-2} \right]_{\sec\theta}^{\sqrt{2}} d\theta = \int_{3\pi/4}^{5\pi/4} \frac{1}{4} (2\cos^2\theta - 1) d\theta = \frac{1}{4} \int_{3\pi/4}^{5\pi/4} \cos 2\theta d\theta = \frac{1}{8} \left[\sin 2\theta \right]_{3\pi/4}^{5\pi/4} = \frac{1}{4} \end{aligned}$$

49-52. Example CAS commands:

Maple:

```
f := (x,y) -> y/(x^2+y^2);
```

```
a,b := 0,1;
```

```
f1 := x -> x;
```

```
f2 := x -> 1;
```

```
plot3d( f(x,y), y=f1(x)..f2(x), x=a..b, axes=boxed, style=patchngrid, shading=zhue, orientation=[0,180],
        title="#49(a) (Section 15.4)"); # (a)
```

```
q1 := eval( x=a, [x=r*cos(theta),y=r*sin(theta)] ); # (b)
```

```
q2 := eval( x=b, [x=r*cos(theta),y=r*sin(theta)] );
```

```
q3 := eval( y=f1(x), [x=r*cos(theta),y=r*sin(theta)] );
```

```
q4 := eval( y=f2(x), [x=r*cos(theta),y=r*sin(theta)] );
```

```
theta1 := solve( q3, theta );
```

```
theta2 := solve( q1, theta );
```

```
r1 := 0;
```

```
r2 := solve( q4, r );
```

```
plot3d(0,r=r1..r2, theta=theta1..theta2, axes=boxed, style=patchngrid, shading=zhue, orientation=[-90,0],
        title="#49(c) (Section 15.4)");
```

```
fP := simplify(eval( f(x,y), [x=r*cos(theta),y=r*sin(theta)] )); # (d)
```

```
q5 := Int( Int( fP*r, r=r1..r2 ), theta=theta1..theta2 );
```

```
value( q5 );
```

Mathematica: (functions and bounds will vary)

For 49 and 50, begin by drawing the region of integration with the **FilledPlot** command.

```
Clear[x, y, r, t]
```

```
<<Graphics`FilledPlot`
```

```
FilledPlot[{x, 1}, {x, 0, 1}, AspectRatio -> 1, AxesLabel -> {x, y}];
```

The picture demonstrates that r goes from 0 to the line $y=1$ or $r = 1/\sin[t]$, while t goes from $\pi/4$ to $\pi/2$.

```
f:= y / (x^2 + y^2)
```

```
topolar={x -> r Cos[t], y -> r Sin[t]};
```

```
fp= f/.topolar //Simplify
```

```
Integrate[r fp, {t, pi/4, pi/2}, {r, 0, 1/Sin[t]}]
```

For 51 and 52, drawing the region of integration with the `ImplicitPlot` command.

```
Clear[x, y]
```

```
<<Graphics`ImplicitPlot`
```

```
ImplicitPlot[{x==y, x==2-y, y==0, y==1}, {x, 0, 2.1}, {y, 0, 1.1}];
```

The picture shows that as t goes from 0 to $\pi/4$, r goes from 0 to the line $x=2-y$. **Solve** will find the bound for r .

```
bdr=Solve[r Cos[t]==2-r Sin[t], r]//Simplify
```

```
f:=Sqrt[x + y]
```

```
topolar={x -> r Cos[t], y -> r Sin[t]};
```

```
fp= f/.topolar //Simplify
```

```
Integrate[r fp, {t, 0, pi/4}, {r, 0, bdr[[1, 1, 2]]}]
```

15.5 TRIPLE INTEGRALS IN RECTANGULAR COORDINATES

$$1. \int_0^1 \int_0^{1-x} \int_{x+z}^1 F(x, y, z) dy dz dx = \int_0^1 \int_0^{1-x} \int_{x+z}^1 dy dz dx = \int_0^1 \int_0^{1-x} (1-x-z) dz dx$$

$$= \int_0^1 \left[(1-x)z - \frac{z^2}{2} \right]_0^{1-x} dx = \int_0^1 \left[(1-x)^2 - \frac{(1-x)^2}{2} \right] dx = \int_0^1 \frac{(1-x)^2}{2} dx = \left[-\frac{(1-x)^3}{6} \right]_0^1 = \frac{1}{6}$$

$$2. \int_0^1 \int_0^2 \int_0^3 dz dy dx = \int_0^1 \int_0^2 3 dy dx = \int_0^1 6 dx = 6, \int_0^2 \int_0^1 \int_0^3 dz dx dy, \int_0^3 \int_0^2 \int_0^1 dx dy dz, \int_0^2 \int_0^3 \int_0^1 dx dz dy,$$

$$\int_0^3 \int_0^1 \int_0^2 dy dx dz, \int_0^1 \int_0^3 \int_0^2 dy dz dx$$

$$3. \int_0^1 \int_0^{2-2x} \int_0^{3-3x-3y/2} dz dy dx = \int_0^1 \int_0^{2-2x} (3-3x-\frac{3}{2}y) dy dx$$

$$= \int_0^1 \left[3(1-x) \cdot 2(1-x) - \frac{3}{4} \cdot 4(1-x)^2 \right] dx$$

$$= 3 \int_0^1 (1-x)^2 dx = \left[-(1-x)^3 \right]_0^1 = 1,$$

$$\int_0^2 \int_0^{1-y/2} \int_0^{3-3x-3y/2} dz dx dy, \int_0^1 \int_0^{3-3x} \int_0^{2-2x-2z/3} dy dz dx,$$

$$\int_0^3 \int_0^{1-z/3} \int_0^{2-2x-2z/3} dy dx dz, \int_0^2 \int_0^{3-3y/2} \int_0^{1-y/2-z/3} dx dz dy,$$

$$\int_0^3 \int_0^{2-2z/3} \int_0^{1-y/2-z/3} dx dy dz$$

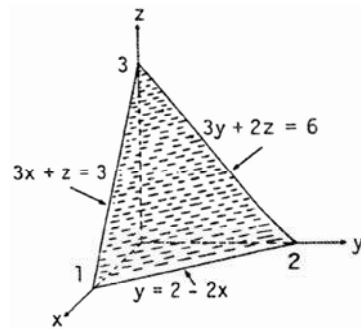

$$4. \int_0^2 \int_0^3 \int_0^{\sqrt{4-x^2}} dz dy dx = \int_0^2 \int_0^3 \sqrt{4-x^2} dy dx = \int_0^2 3\sqrt{4-x^2} dx = \frac{3}{2} \left[x\sqrt{4-x^2} + 4 \sin^{-1} \frac{x}{2} \right]_0^2 = 6 \sin^{-1} 1 = 3\pi,$$

$$\int_0^3 \int_0^2 \int_0^{\sqrt{4-x^2}} dz dx dy, \int_0^2 \int_0^{\sqrt{4-x^2}} \int_0^3 dy dz dx, \int_0^2 \int_0^{\sqrt{4-z^2}} \int_0^3 dy dx dz, \int_0^2 \int_0^3 \int_0^{\sqrt{4-z^2}} dx dy dz,$$

$$\int_0^3 \int_0^2 \int_0^{\sqrt{4-z^2}} dx dz dy$$

$$5. \int_{-2}^2 \int_{-\sqrt{4-x^2}}^{\sqrt{4-x^2}} \int_{x^2+y^2}^{8-x^2-y^2} dz dy dx = 4 \int_0^2 \int_0^{\sqrt{4-x^2}} \int_{x^2+y^2}^{8-x^2-y^2} dz dy dx$$

$$= 4 \int_0^2 \int_0^{\sqrt{4-x^2}} [8 - 2(x^2 + y^2)] dy dx$$

$$= 8 \int_0^2 \int_0^{\sqrt{4-x^2}} (4 - x^2 - y^2) dy dx = 8 \int_0^{\pi/2} \int_0^2 (4 - r^2) r dr d\theta$$

$$= 8 \int_0^{\pi/2} \left[2r^2 - \frac{r^4}{4} \right]_0^2 d\theta = 32 \int_0^{\pi/2} d\theta = 32 \left(\frac{\pi}{2} \right) = 16\pi,$$

$$\int_{-2}^2 \int_{-\sqrt{4-y^2}}^{\sqrt{4-y^2}} \int_{x^2+y^2}^{8-x^2-y^2} dz dx dy,$$

$$\int_{-2}^2 \int_{y^2}^4 \int_{-\sqrt{z-y^2}}^{\sqrt{z-y^2}} dx dz dy + \int_{-2}^2 \int_4^{8-y^2} \int_{-\sqrt{8-z-y^2}}^{\sqrt{8-z-y^2}} dx dz dy, \int_0^4 \int_{-\sqrt{z}}^{\sqrt{z}} \int_{-\sqrt{z-y^2}}^{\sqrt{z-y^2}} dx dy dz + \int_4^8 \int_{-\sqrt{8-z}}^{\sqrt{8-z}} \int_{-\sqrt{8-z-y^2}}^{\sqrt{8-z-y^2}} dx dy dz,$$

$$\int_{-2}^2 \int_{x^2}^4 \int_{-\sqrt{z-x^2}}^{\sqrt{z-x^2}} dy dz dx + \int_{-2}^2 \int_4^{8-x^2} \int_{-\sqrt{8-z-x^2}}^{\sqrt{8-z-x^2}} dy dz dx, \int_0^4 \int_{-\sqrt{z}}^{\sqrt{z}} \int_{-\sqrt{z-x^2}}^{\sqrt{z-x^2}} dy dx dz + \int_4^8 \int_{-\sqrt{8-z}}^{\sqrt{8-z}} \int_{-\sqrt{8-z-x^2}}^{\sqrt{8-z-x^2}} dy dx dz$$

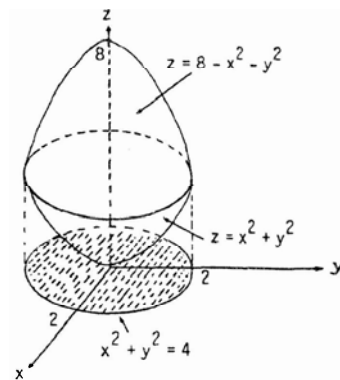

6. The projection of D onto the xy -plane has the boundary

$$x^2 + y^2 = 2y \Rightarrow x^2 + (y-1)^2 = 1, \text{ which is a circle.}$$

Therefore the two integrals are:

$$\int_0^2 \int_{-\sqrt{2y-y^2}}^{\sqrt{2y-y^2}} \int_{x^2+y^2}^{2y} dz dx dy \quad \text{and} \quad \int_{-1}^1 \int_{1-\sqrt{1-x^2}}^{1+\sqrt{1-x^2}} \int_{x^2+y^2}^{2y} dz dy dx$$

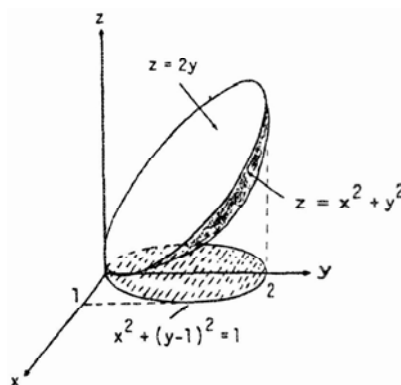

7. $\int_0^1 \int_0^1 \int_0^1 (x^2 + y^2 + z^2) dz dy dx = \int_0^1 \int_0^1 (x^2 + y^2 + \frac{1}{3}) dy dx = \int_0^1 (x^2 + \frac{2}{3}) dx = 1$
8. $\int_0^{\sqrt{2}} \int_0^{3y} \int_{x^2+3y^2}^{8-x^2-y^2} dz dx dy = \int_0^{\sqrt{2}} \int_0^{3y} (8-2x^2-4y^2) dx dy = \int_0^{\sqrt{2}} [8x - \frac{2}{3}x^3 - 4xy^2]_0^{3y} dy$
 $= \int_0^{\sqrt{2}} (24y - 18y^3 - 12y^3) dy = [12y^2 - \frac{15}{2}y^4]_0^{\sqrt{2}} = 24 - 30 = -6$
9. $\int_1^e \int_1^{e^2} \int_1^{e^3} \frac{1}{xyz} dx dy dz = \int_1^e \int_1^{e^2} [\frac{\ln x}{yz}]_1^{e^3} dy dz = \int_1^e \int_1^{e^2} \frac{3}{yz} dy dz = 3 \int_1^e [\frac{\ln y}{z}]_1^{e^2} dz = \int_1^e \frac{6}{z} dz = 6$
10. $\int_0^1 \int_0^{3-3x} \int_0^{3-3x-y} dz dy dx = \int_0^1 \int_0^{3-3x} (3-3x-y) dy dx = \int_0^1 [(3-3x)^2 - \frac{1}{2}(3-3x)^2] dx = \frac{9}{2} \int_0^1 (1-x)^2 dx$
 $= -\frac{3}{2} [(1-x)^3]_0^1 = \frac{3}{2}$
11. $\int_0^{\pi/6} \int_0^1 \int_{-2}^3 y \sin z dx dy dz = \int_0^{\pi/6} \int_0^1 5y \sin z dy dz = \frac{5}{2} \int_0^{\pi/6} \sin z dz = \frac{5(2-\sqrt{3})}{4}$
12. $\int_{-1}^1 \int_0^1 \int_0^2 (x+y+z) dy dx dz = \int_{-1}^1 \int_0^1 [xy + \frac{1}{2}y^2 + zy]_0^2 dx dz = \int_{-1}^1 \int_0^1 (2x+2+2z) dx dz$
 $= \int_{-1}^1 [x^2 + 2x + 2zx]_0^1 dz = \int_{-1}^1 (3+2z) dz = [3z + z^2]_{-1}^1 = 6$
13. $\int_0^3 \int_0^{\sqrt{9-x^2}} \int_0^{\sqrt{9-x^2}} dz dy dx = \int_0^3 \int_0^{\sqrt{9-x^2}} \sqrt{9-x^2} dy dx = \int_0^3 (9-x^2) dx = [9x - \frac{x^3}{3}]_0^3 = 18$
14. $\int_0^2 \int_{-\sqrt{4-y^2}}^{\sqrt{4-y^2}} \int_0^{2x+y} dz dx dy = \int_0^2 \int_{-\sqrt{4-y^2}}^{\sqrt{4-y^2}} (2x+y) dx dy = \int_0^2 [x^2 + xy]_{-\sqrt{4-y^2}}^{\sqrt{4-y^2}} dy = \int_0^2 (4-y^2)^{1/2} (2y) dy$
 $= [-\frac{2}{3}(4-y^2)^{3/2}]_0^2 = \frac{2}{3}(4)^{3/2} = \frac{16}{3}$

15. $\int_0^1 \int_0^{2-x} \int_0^{2-x-y} dz dy dx = \int_0^1 \int_0^{2-x} (2-x-y) dy dx = \int_0^1 \left[(2-x)^2 - \frac{1}{2}(2-x)^2 \right] dx = \frac{1}{2} \int_0^1 (2-x)^2 dx$
 $= \left[-\frac{1}{6}(2-x)^3 \right]_0^1 = -\frac{1}{6} + \frac{8}{6} = \frac{7}{6}$
16. $\int_0^1 \int_0^{1-x^2} \int_3^{4-x^2-y} x dz dy dx = \int_0^1 \int_0^{1-x^2} x(1-x^2-y) dy dx = \int_0^1 x \left[(1-x^2)^2 - \frac{1}{2}(1-x^2) \right] dx = \int_0^1 \frac{1}{2} x(1-x^2)^2 dx$
 $= \left[-\frac{1}{12}(1-x^2)^3 \right]_0^1 = \frac{1}{12}$
17. $\int_0^\pi \int_0^\pi \int_0^\pi \cos(u+v+w) du dv dw = \int_0^\pi \int_0^\pi [\sin(w+v+\pi) - \sin(w+v)] dv dw$
 $= \int_0^\pi [(-\cos(w+2\pi) + \cos(w+\pi)) + (\cos(w+\pi) - \cos w)] dw$
 $= [-\sin(w+2\pi) + \sin(w+\pi) - \sin w + \sin(w+\pi)]_0^\pi = 0$
18. $\int_0^1 \int_1^{\sqrt{e}} \int_1^e s e^s \ln r \frac{(\ln t)^2}{t} dt dr ds = \int_0^1 \int_1^{\sqrt{e}} (s e^s \ln r) \left[\frac{1}{3}(\ln t)^3 \right]_1^e dr ds = \int_0^1 \int_1^{\sqrt{e}} \frac{s e^s}{3} \ln r dr ds$
 $= \int_0^1 \frac{s e^s}{3} [r \ln r - r]_1^{\sqrt{e}} ds = \frac{2-\sqrt{e}}{6} \int_0^1 s e^s ds = \frac{2-\sqrt{e}}{6} [s e^s - e^s]_0^1 = \frac{2-\sqrt{e}}{6}$
19. $\int_0^{\pi/4} \int_0^{\ln \sec v} \int_{-\infty}^{2t} e^x dx dt dv = \int_0^{\pi/4} \int_0^{\ln \sec v} \lim_{b \rightarrow -\infty} (e^{2t} - e^b) dt dv = \int_0^{\pi/4} \int_0^{\ln \sec v} e^{2t} dt dv$
 $= \int_0^{\pi/4} \left(\frac{1}{2} e^{2 \ln \sec v} - \frac{1}{2} \right) dv = \int_0^{\pi/4} \left(\frac{\sec^2 v}{2} - \frac{1}{2} \right) dv = \left[\frac{\tan v}{2} - \frac{v}{2} \right]_0^{\pi/4} = \frac{1}{2} - \frac{\pi}{8}$
20. $\int_0^7 \int_0^2 \int_0^{\sqrt{4-q^2}} \frac{q}{r+1} dp dq dr = \int_0^7 \int_0^2 \frac{q \sqrt{4-q^2}}{r+1} dq dr = \int_0^7 \frac{1}{3(r+1)} \left[-(4-q^2)^{3/2} \right]_0^2 dr = \frac{8}{3} \int_0^7 \frac{1}{r+1} dr = \frac{8 \ln 8}{3} = 8 \ln 2$
21. (a) $\int_{-1}^1 \int_0^{1-x^2} \int_{x^2}^{1-z} dy dz dx$ (b) $\int_0^1 \int_{-\sqrt{1-z}}^{\sqrt{1-z}} \int_{x^2}^{1-z} dy dx dz$ (c) $\int_0^1 \int_0^{1-z} \int_{-\sqrt{y}}^{\sqrt{y}} dx dy dz$
 (d) $\int_0^1 \int_0^{1-y} \int_{-\sqrt{y}}^{\sqrt{y}} dx dz dy$ (e) $\int_0^1 \int_{-\sqrt{y}}^{\sqrt{y}} \int_0^{1-y} dz dx dy$
22. (a) $\int_0^1 \int_0^1 \int_{-1}^{-\sqrt{z}} dy dz dx$ (b) $\int_0^1 \int_0^1 \int_{-1}^{-\sqrt{z}} dy dx dz$ (c) $\int_0^1 \int_{-1}^{-\sqrt{z}} \int_0^1 dx dy dz$
 (d) $\int_{-1}^0 \int_0^{y^2} \int_0^1 dx dz dy$ (e) $\int_{-1}^0 \int_0^1 \int_0^{y^2} dz dx dy$
23. $V = \int_0^1 \int_{-1}^1 \int_0^{y^2} dz dy dx = \int_0^1 \int_{-1}^1 y^2 dy dx = \frac{2}{3} \int_0^1 dx = \frac{2}{3}$
24. $V = \int_0^1 \int_0^{1-x} \int_0^{2-2z} dy dz dx = \int_0^1 \int_0^{1-x} (2-2z) dz dx = \int_0^1 [2z - z^2]_0^{1-x} dx = \int_0^1 (1-x^2) dx = \left[x - \frac{x^3}{3} \right]_0^1 = \frac{2}{3}$

$$25. \quad V = \int_0^4 \int_0^{\sqrt{4-x}} \int_0^{2-y} dz \, dy \, dx = \int_0^4 \int_0^{\sqrt{4-x}} (2-y) \, dy \, dx = \int_0^4 \left[2\sqrt{4-x} - \left(\frac{4-x}{2}\right) \right] dx = \left[-\frac{4}{3}(4-x)^{3/2} + \frac{1}{4}(4-x)^2 \right]_0^4 \\ = \frac{4}{3}(4)^{3/2} - \frac{1}{4}(16) = \frac{32}{3} - 4 = \frac{20}{3}$$

$$26. \quad V = 2 \int_0^1 \int_{-\sqrt{1-x^2}}^0 \int_0^{-y} dz \, dy \, dx = -2 \int_0^1 \int_{-\sqrt{1-x^2}}^0 y \, dy \, dx = \int_0^1 (1-x^2) \, dx = \frac{2}{3}$$

$$27. \quad V = \int_0^1 \int_0^{2-2x} \int_0^{3-3x-3y/2} dz \, dy \, dx = \int_0^1 \int_0^{2-2x} (3-3x-\frac{3}{2}y) \, dy \, dx = \int_0^1 \left[6(1-x)^2 - \frac{3}{4} \cdot 4(1-x)^2 \right] dx \\ = \int_0^1 3(1-x)^2 \, dx = \left[-(1-x)^3 \right]_0^1 = 1$$

$$28. \quad V = \int_0^1 \int_0^{1-x} \int_0^{\cos(\pi x/2)} dz \, dy \, dx = \int_0^1 \int_0^{1-x} \cos\left(\frac{\pi x}{2}\right) \, dy \, dx = \int_0^1 \left(\cos\frac{\pi x}{2}\right) (1-x) \, dx \\ = \int_0^1 \cos\left(\frac{\pi x}{2}\right) \, dx - \int_0^1 x \cos\left(\frac{\pi x}{2}\right) \, dx = \left[\frac{2}{\pi} \sin\frac{\pi x}{2} \right]_0^1 - \frac{4}{\pi^2} \int_0^{\pi/2} u \cos u \, du = \frac{2}{\pi} - \frac{4}{\pi^2} [\cos u + u \sin u]_0^{\pi/2} \\ = \frac{2}{\pi} - \frac{4}{\pi^2} \left(\frac{\pi}{2} - 1\right) = \frac{4}{\pi^2}$$

$$29. \quad V = 8 \int_0^1 \int_0^{\sqrt{1-x^2}} \int_0^{\sqrt{1-x^2}} dz \, dy \, dx = 8 \int_0^1 \int_0^{\sqrt{1-x^2}} \sqrt{1-x^2} \, dy \, dx = 8 \int_0^1 (1-x^2) \, dx = \frac{16}{3}$$

$$30. \quad V = \int_0^2 \int_0^{4-x^2} \int_0^{4-x^2-y} dz \, dy \, dx = \int_0^2 \int_0^{4-x^2} (4-x^2-y) \, dy \, dx = \int_0^2 \left[(4-x^2)^2 - \frac{1}{2}(4-x^2)^2 \right] dx \\ = \frac{1}{2} \int_0^2 (4-x^2)^2 \, dx = \int_0^2 \left(8-4x^2 + \frac{x^4}{2} \right) dx = \frac{128}{15}$$

$$31. \quad V = \int_0^4 \int_0^{\sqrt{16-y^2}/2} \int_0^{4-y} dx \, dz \, dy = \int_0^4 \int_0^{\sqrt{16-y^2}/2} (4-y) \, dz \, dy = \int_0^4 \frac{\sqrt{16-y^2}}{2} (4-y) \, dy \\ = \int_0^4 2\sqrt{16-y^2} \, dy - \frac{1}{2} \int_0^4 y\sqrt{16-y^2} \, dy = \left[y\sqrt{16-y^2} + 16 \sin^{-1} \frac{y}{4} \right]_0^4 + \left[\frac{1}{6}(16-y^2)^{3/2} \right]_0^4 \\ = 16\left(\frac{\pi}{2}\right) - \frac{1}{6}(16)^{3/2} = 8\pi - \frac{32}{3}$$

$$32. \quad V = \int_{-2}^2 \int_{-\sqrt{4-x^2}}^{\sqrt{4-x^2}} \int_0^{3-x} dz \, dy \, dx = \int_{-2}^2 \int_{-\sqrt{4-x^2}}^{\sqrt{4-x^2}} (3-x) \, dy \, dx = 2 \int_{-2}^2 (3-x)\sqrt{4-x^2} \, dx \\ = 3 \int_{-2}^2 2\sqrt{4-x^2} \, dx - 2 \int_{-2}^2 x\sqrt{4-x^2} \, dx = 3 \left[x\sqrt{4-x^2} + 4 \sin^{-1} \frac{x}{2} \right]_{-2}^2 + \left[\frac{2}{3}(4-x^2)^{3/2} \right]_{-2}^2 \\ = 12 \sin^{-1} 1 - 12 \sin^{-1}(-1) = 12\left(\frac{\pi}{2}\right) - 12\left(-\frac{\pi}{2}\right) = 12\pi$$

$$\begin{aligned}
 33. \quad \int_0^2 \int_0^{2-x} \int_{(2-x-y)/2}^{4-2x-2y} dz \, dy \, dx &= \int_0^2 \int_0^{2-x} \left(3 - \frac{3x}{2} - \frac{3y}{2} \right) dy \, dx \\
 &= \int_0^2 \left[3\left(1 - \frac{x}{2}\right)(2-x) - \frac{3}{4}(2-x)^2 \right] dx = \int_0^2 \left[6 - 6x + \frac{3x^2}{2} - \frac{3(2-x)^2}{4} \right] dx \\
 &= \left[6x - 3x^2 + \frac{x^3}{2} + \frac{(2-x)^3}{4} \right]_0^2 = (12 - 12 + 4 + 0) - \frac{2^3}{4} = 2
 \end{aligned}$$

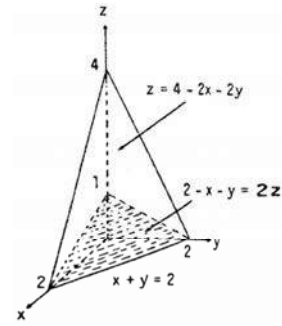

$$\begin{aligned}
 34. \quad V &= \int_0^4 \int_z^8 \int_z^{8-z} dx \, dy \, dz = \int_0^4 \int_z^8 (8-2z) \, dy \, dz = \int_0^4 (8-2z)(8-z) \, dz = \int_0^4 (64 - 24z + 2z^2) \, dz \\
 &= \left[64z - 12z^2 + \frac{2}{3}z^3 \right]_0^4 = \frac{320}{3}
 \end{aligned}$$

$$\begin{aligned}
 35. \quad V &= 2 \int_{-2}^2 \int_0^{\sqrt{4-x^2}/2} \int_0^{x+2} dz \, dy \, dx = 2 \int_{-2}^2 \int_0^{\sqrt{4-x^2}/2} (x+2) \, dy \, dx = \int_{-2}^2 (x+2)\sqrt{4-x^2} \, dx \\
 &= \int_{-2}^2 2\sqrt{4-x^2} \, dx + \int_{-2}^2 x\sqrt{4-x^2} \, dx = \left[x\sqrt{4-x^2} + 4 \sin^{-1} \frac{x}{2} \right]_{-2}^2 + \left[-\frac{1}{3}(4-x^2)^{3/2} \right]_{-2}^2 = 4\left(\frac{\pi}{2}\right) - 4\left(-\frac{\pi}{2}\right) = 4\pi
 \end{aligned}$$

$$\begin{aligned}
 36. \quad V &= 2 \int_0^1 \int_0^{1-y^2} \int_0^{x^2+y^2} dz \, dx \, dy = 2 \int_0^1 \int_0^{1-y^2} (x^2 + y^2) \, dx \, dy = 2 \int_0^1 \left[\frac{x^3}{3} + xy^2 \right]_0^{1-y^2} dy \\
 &= 2 \int_0^1 (1-y^2) \left[\frac{1}{3}(1-y^2)^2 + y^2 \right] dy = 2 \int_0^1 (1-y^2) \left(\frac{1}{3} + \frac{1}{3}y^2 + \frac{1}{3}y^4 \right) dy = \frac{2}{3} \int_0^1 (1-y^6) \, dy \\
 &= \frac{2}{3} \left[y - \frac{y^7}{7} \right]_0^1 = \left(\frac{2}{3} \right) \left(\frac{6}{7} \right) = \frac{4}{7}
 \end{aligned}$$

$$37. \quad \text{average} = \frac{1}{8} \int_0^2 \int_0^2 \int_0^2 (x^2 + 9) \, dz \, dy \, dx = \frac{1}{8} \int_0^2 \int_0^2 (2x^2 + 18) \, dy \, dx = \frac{1}{8} \int_0^2 (4x^2 + 36) \, dx = \frac{31}{3}$$

$$38. \quad \text{average} = \frac{1}{2} \int_0^1 \int_0^1 \int_0^2 (x + y - z) \, dz \, dy \, dx = \frac{1}{2} \int_0^1 \int_0^1 (2x + 2y - 2) \, dy \, dx = \frac{1}{2} \int_0^1 (2x - 1) \, dx = 0$$

$$39. \quad \text{average} = \int_0^1 \int_0^1 \int_0^1 (x^2 + y^2 + z^2) \, dz \, dy \, dx = \int_0^1 \int_0^1 \left(x^2 + y^2 + \frac{1}{3} \right) dy \, dx = \int_0^1 \left(x^2 + \frac{2}{3} \right) dx = 1$$

$$40. \quad \text{average} = \frac{1}{8} \int_0^2 \int_0^2 \int_0^2 xyz \, dz \, dy \, dx = \frac{1}{4} \int_0^2 \int_0^2 xy \, dy \, dx = \frac{1}{2} \int_0^2 x \, dx = 1$$

$$\begin{aligned}
 41. \quad \int_0^4 \int_0^1 \int_{2y}^2 \frac{4 \cos(x^2)}{2\sqrt{z}} \, dx \, dy \, dz &= \int_0^4 \int_0^2 \int_0^{x/2} \frac{4 \cos(x^2)}{2\sqrt{z}} \, dy \, dx \, dz = \int_0^4 \int_0^2 \frac{x \cos(x^2)}{\sqrt{z}} \, dx \, dz = \int_0^4 \left(\frac{\sin 4}{2} \right) z^{-1/2} \, dz \\
 &= \left[(\sin 4) z^{1/2} \right]_0^4 = 2 \sin 4
 \end{aligned}$$

$$42. \int_0^1 \int_0^1 \int_{x^2}^1 12xz e^{zy^2} dy dx dz = \int_0^1 \int_0^1 \int_0^{\sqrt{y}} 12xz e^{zy^2} dx dy dz = \int_0^1 \int_0^1 6yz e^{zy^2} dy dz = \int_0^1 \left[3e^{zy^2} \right]_0^1 dz$$

$$= 3 \int_0^1 (e^z - 1) dz = 3 \left[e^z - z \right]_0^1 = 3e - 6$$

$$43. \int_0^1 \int_{\sqrt{z}}^1 \int_0^{\ln 3} \frac{\pi e^{2x} \sin(\pi y^2)}{y^2} dx dy dz = \int_0^1 \int_{\sqrt{z}}^1 \frac{4\pi \sin(\pi y^2)}{y^2} dy dz = \int_0^1 \int_0^{y^3} \frac{4\pi \sin(\pi y^2)}{y^2} dz dy$$

$$= \int_0^1 4\pi y \sin(\pi y^2) dy = \left[-2 \cos(\pi y^2) \right]_0^1 = -2(-1) + 2(1) = 4$$

$$44. \int_0^2 \int_0^{4-x^2} \int_0^x \frac{\sin 2z}{4-z} dy dz dx = \int_0^2 \int_0^{4-x^2} \frac{x \sin 2z}{4-z} dz dx = \int_0^4 \int_0^{\sqrt{4-z}} \left(\frac{\sin 2z}{4-z} \right) x dx dz = \int_0^4 \left(\frac{\sin 2z}{4-z} \right) \frac{1}{2} (4-z) dz$$

$$= \left[-\frac{1}{4} \cos 2z \right]_0^4 = \left[-\frac{1}{4} + \frac{1}{2} \sin^2 z \right]_0^4 = \frac{\sin^2 4}{2}$$

$$45. \int_0^1 \int_0^{4-a-x^2} \int_a^{4-x^2-y} dz dy dx = \frac{4}{15} \Rightarrow \int_0^1 \int_0^{4-a-x^2} (4-x^2-y-a) dy dx = \frac{4}{15}$$

$$\Rightarrow \int_0^1 \left[(4-a-x^2)^2 - \frac{1}{2} (4-a-x^2)^2 \right] dx = \frac{4}{15} \Rightarrow \frac{1}{2} \int_0^1 (4-a-x^2)^2 dx = \frac{4}{15} \Rightarrow \int_0^1 [(4-a)^2 - 2x^2(4-a) + x^4] dx$$

$$= \frac{8}{15} \Rightarrow \left[(4-a)^2 x - \frac{2}{3} x^3 (4-a) + \frac{x^5}{5} \right]_0^1 = \frac{8}{15} \Rightarrow (4-a)^2 - \frac{2}{3} (4-a) + \frac{1}{5} = \frac{8}{15} \Rightarrow 15(4-a)^2 - 10(4-a) - 5 = 0$$

$$\Rightarrow 3(4-a)^2 - 2(4-a) - 1 = 0 \Rightarrow [3(4-a) + 1][(4-a) - 1] = 0 \Rightarrow 4-a = -\frac{1}{3} \text{ or } 4-a = 1 \Rightarrow a = \frac{13}{3} \text{ or } a = 3$$

46. The volume of the ellipsoid $\frac{x^2}{a^2} + \frac{y^2}{b^2} + \frac{z^2}{c^2} = 1$ is $\frac{4abc\pi}{3}$ so that $\frac{4(1)(2)(c)\pi}{3} = 8\pi \Rightarrow c = 3$.

47. To minimize the integral, we want the domain to include all points where the integrand is negative and to exclude all points where it is positive. These criteria are met by the points (x, y, z) such that $4x^2 + 4y^2 + z^2 - 4 \leq 0$ or $4x^2 + 4y^2 + z^2 \leq 4$, which is a solid ellipsoid centered at the origin.

48. To maximize the integral, we want the domain to include all points where the integrand is positive and to exclude all points where it is negative. These criteria are met by the points (x, y, z) such that $1 - x^2 - y^2 - z^2 \geq 0$ or $x^2 + y^2 + z^2 \leq 1$, which is a solid sphere of radius 1 centered at the origin.

49-52. Example CAS commands:

Maple:

```
F := (x,y,z) -> x^2*y^2*z;
q1 := Int( Int( Int( F(x,y,z), y=-sqrt(1-x^2)..sqrt(1-x^2) ), x=-1..1 ), z=0..1 );
value(q1);
```

Mathematica: (functions and bounds will vary)

```
Clear[f, x, y, z];
f:= x^2 y^2 z
Integrate[f, {x,-1,1}, {y,-Sqrt[1-x^2], Sqrt[1-x^2]}, {z, 0, 1}]
```

```

N[%]
topolar={x -> r Cos[t], y -> r Sin[t]};
fp= f/.topolar //Simplify
Integrate[r fp, {t, 0, 2π}, {r, 0, 1}, {z, 0, 1}]
N[%]

```

15.6 MOMENTS AND CENTERS OF MASS

- $$M = \int_0^1 \int_x^{2-x^2} 3 \, dy \, dx = 3 \int_0^1 (2-x^2-x) \, dx = \frac{7}{2}; \quad M_y = \int_0^1 \int_x^{2-x^2} 3x \, dy \, dx = 3 \int_0^1 [xy]_x^{2-x^2} \, dx$$

$$= 3 \int_0^1 (2x-x^3-x^2) \, dx = \frac{5}{4}; \quad M_x = \int_0^1 \int_x^{2-x^2} 3y \, dy \, dx = \frac{3}{2} \int_0^1 [y^2]_x^{2-x^2} \, dx = \frac{3}{2} \int_0^1 (4-5x^2+x^4) \, dx = \frac{19}{5}$$

$$\Rightarrow \bar{x} = \frac{5}{14} \text{ and } \bar{y} = \frac{38}{35}$$
- $$M = \delta \int_0^3 \int_0^3 dy \, dx = \delta \int_0^3 3 \, dx = 9\delta; \quad I_x = \delta \int_0^3 \int_0^3 y^2 \, dy \, dx = \delta \int_0^3 \left[\frac{y^3}{3} \right]_0^3 \, dx = 27\delta;$$

$$I_y = \delta \int_0^3 \int_0^3 x^2 \, dy \, dx = \delta \int_0^3 [x^2 y]_0^3 \, dx = \delta \int_0^3 3x^2 \, dx = 27\delta$$
- $$M = \int_0^2 \int_{y^2/2}^{4-y} dx \, dy = \int_0^2 \left(4-y-\frac{y^2}{2} \right) dy = \frac{14}{3}; \quad M_y = \int_0^2 \int_{y^2/2}^{4-y} x \, dx \, dy = \frac{1}{2} \int_0^2 [x^2]_{y^2/2}^{4-y} \, dy$$

$$= \frac{1}{2} \int_0^2 \left(16-8y+y^2-\frac{y^4}{4} \right) dy = \frac{128}{3}; \quad M_x = \int_0^2 \int_{y^2/2}^{4-y} y \, dx \, dy = \int_0^2 \left(4y-y^2-\frac{y^3}{2} \right) dy = \frac{10}{3} \Rightarrow \bar{x} = \frac{64}{35} \text{ and } \bar{y} = \frac{5}{7}$$
- $$M = \int_0^3 \int_0^{3-x} dy \, dx = \int_0^3 (3-x) \, dx = \frac{9}{2}; \quad M_y = \int_0^3 \int_0^{3-x} x \, dy \, dx = \int_0^3 [xy]_0^{3-x} \, dx = \int_0^3 (3x-x^2) \, dx = \frac{9}{2}$$

$$\Rightarrow \bar{x} = 1 \text{ and } \bar{y} = 1, \text{ by symmetry}$$
- $$M = \int_0^a \int_0^{\sqrt{a^2-x^2}} dy \, dx = \frac{\pi a^2}{4}; \quad M_y = \int_0^a \int_0^{\sqrt{a^2-x^2}} x \, dy \, dx = \int_0^a [xy]_0^{\sqrt{a^2-x^2}} \, dx = \int_0^a x\sqrt{a^2-x^2} \, dx = \frac{a^3}{3}$$

$$\Rightarrow \bar{x} = \bar{y} = \frac{4a}{3\pi}, \text{ by symmetry}$$
- $$M = \int_0^\pi \int_0^{\sin x} dy \, dx = \int_0^\pi \sin x \, dx = 2; \quad M_x = \int_0^\pi \int_0^{\sin x} y \, dy \, dx = \frac{1}{2} \int_0^\pi [y^2]_0^{\sin x} \, dx = \frac{1}{2} \int_0^\pi \sin^2 x \, dx$$

$$= \frac{1}{4} \int_0^\pi (1-\cos 2x) \, dx = \frac{\pi}{4} \Rightarrow \bar{x} = \frac{\pi}{2} \text{ and } \bar{y} = \frac{\pi}{8}$$
- $$I_x = \int_{-2}^2 \int_{-\sqrt{4-x^2}}^{\sqrt{4-x^2}} y^2 \, dy \, dx = \int_{-2}^2 \left[\frac{y^3}{3} \right]_{-\sqrt{4-x^2}}^{\sqrt{4-x^2}} \, dx = \frac{2}{3} \int_{-2}^2 (4-x^2)^{3/2} \, dx = 4\pi; \quad I_y = 4\pi, \text{ by symmetry;}$$

$$I_o = I_x + I_y = 8\pi$$
- $$I_y = \int_\pi^{2\pi} \int_0^{(\sin^2 x)/x^2} x^2 \, dy \, dx = \int_\pi^{2\pi} (\sin^2 x - 0) \, dx = \frac{1}{2} \int_\pi^{2\pi} (1-\cos 2x) \, dx = \frac{\pi}{2}$$

9. $M = \int_{-\infty}^0 \int_0^{e^x} dy dx = \int_{-\infty}^0 e^x dx = \lim_{b \rightarrow -\infty} \int_b^0 e^x dx = 1 - \lim_{b \rightarrow -\infty} e^b = 1$; $M_y = \int_{-\infty}^0 \int_0^{e^x} x dy dx = \int_{-\infty}^0 x e^x dx$
 $= \lim_{b \rightarrow -\infty} \int_b^0 x e^x dx = \lim_{b \rightarrow -\infty} [x e^x - e^x]_b^0 = -1 - \lim_{b \rightarrow -\infty} (b e^b - e^b) = -1$; $M_x = \int_{-\infty}^0 \int_0^{e^x} y dy dx = \frac{1}{2} \int_{-\infty}^0 e^{2x} dx$
 $= \frac{1}{2} \lim_{b \rightarrow -\infty} \int_b^0 e^{2x} dx = \frac{1}{4} \Rightarrow \bar{x} = -1$ and $\bar{y} = \frac{1}{4}$
10. $M_y = \int_0^\infty \int_0^{e^{-x^2/2}} x dy dx = \lim_{b \rightarrow \infty} \int_0^b x e^{-x^2/2} dx = - \lim_{b \rightarrow \infty} \left[\frac{1}{e^{x^2/2}} - 1 \right]_0^b = 1$
11. $M = \int_0^2 \int_{-y}^{y-y^2} (x+y) dx dy = \int_0^2 \left[\frac{x^2}{2} + xy \right]_{-y}^{y-y^2} dy = \int_0^2 \left(\frac{y^4}{2} - 2y^3 + 2y^2 \right) dy = \left[\frac{y^5}{10} - \frac{y^4}{2} + \frac{2y^3}{3} \right]_0^2 = \frac{8}{15}$;
 $I_x = \int_0^2 \int_{-y}^{y-y^2} y^2 (x+y) dx dy = \int_0^2 \left[\frac{x^2 y^2}{2} + xy^3 \right]_{-y}^{y-y^2} dy = \int_0^2 \left(\frac{y^6}{2} - 2y^5 + 2y^4 \right) dy = \frac{64}{105}$;
12. $M = \int_{-\sqrt{3}/2}^{\sqrt{3}/2} \int_{4y^2}^{\sqrt{12-4y^2}} 5x dx dy = 5 \int_{-\sqrt{3}/2}^{\sqrt{3}/2} \left[\frac{x^2}{2} \right]_{4y^2}^{\sqrt{12-4y^2}} dy = \frac{5}{2} \int_{-\sqrt{3}/2}^{\sqrt{3}/2} (12 - 4y^2 - 16y^4) dy = 23\sqrt{3}$
13. $M = \int_0^1 \int_x^{2-x} (6x+3y+3) dy dx = \int_0^1 \left[6xy + \frac{3}{2}y^2 + 3y \right]_x^{2-x} dx = \int_0^1 (12 - 12x^2) dx = 8$;
 $M_y = \int_0^1 \int_x^{2-x} x(6x+3y+3) dy dx = \int_0^1 (12x - 12x^3) dx = 3$; $M_x = \int_0^1 \int_x^{2-x} y(6x+3y+3) dy dx$
 $= \int_0^1 (14 - 6x - 6x^2 - 2x^3) dx = \frac{17}{2} \Rightarrow \bar{x} = \frac{3}{8}$ and $\bar{y} = \frac{17}{16}$
14. $M = \int_0^1 \int_{y^2}^{2y-y^2} (y+1) dx dy = \int_0^1 (2y - 2y^3) dy = \frac{1}{2}$; $M_x = \int_0^1 \int_{y^2}^{2y-y^2} y(y+1) dx dy = \int_0^1 (2y^2 - 2y^4) dy = \frac{4}{15}$;
 $M_y = \int_0^1 \int_{y^2}^{2y-y^2} x(y+1) dx dy = \int_0^1 (2y^2 - 2y^4) dy = \frac{4}{15} \Rightarrow \bar{x} = \frac{8}{15}$ and $\bar{y} = \frac{8}{15}$; $I_x = \int_0^1 \int_{y^2}^{2y-y^2} y^2 (y+1) dx dy$
 $= 2 \int_0^1 (y^3 - y^5) dy = \frac{1}{6}$
15. $M = \int_0^1 \int_0^6 (x+y+1) dx dy = \int_0^1 (6y+24) dy = 27$; $M_x = \int_0^1 \int_0^6 y(x+y+1) dx dy = \int_0^1 y(6y+24) dy = 14$;
 $M_y = \int_0^1 \int_0^6 x(x+y+1) dx dy = \int_0^1 (18y+90) dy = 99 \Rightarrow \bar{x} = \frac{11}{3}$ and $\bar{y} = \frac{14}{27}$;
 $I_y = \int_0^1 \int_0^6 x^2(x+y+1) dx dy = 216 \int_0^1 \left(\frac{y}{3} + \frac{11}{6} \right) dy = 432$
16. $M = \int_{-1}^1 \int_{x^2}^1 (y+1) dy dx = - \int_{-1}^1 \left(\frac{x^4}{2} + x^2 - \frac{3}{2} \right) dx = \frac{32}{15}$; $M_x = \int_{-1}^1 \int_{x^2}^1 y(y+1) dy dx = \int_{-1}^1 \left(\frac{5}{6} - \frac{x^6}{3} - \frac{x^4}{2} \right) dx = \frac{48}{35}$;
 $M_y = \int_{-1}^1 \int_{x^2}^1 x(y+1) dy dx = \int_{-1}^1 \left(\frac{3x}{2} - \frac{x^5}{2} - x^3 \right) dx = 0 \Rightarrow \bar{x} = 0$ and $\bar{y} = \frac{9}{14}$;
 $I_y = \int_{-1}^1 \int_{x^2}^1 x^2 (y+1) dy dx = \int_{-1}^1 \left(\frac{3x^2}{2} - \frac{x^6}{2} - x^4 \right) dx = \frac{16}{35}$

$$17. M = \int_{-1}^1 \int_0^{x^2} (7y+1) dy dx = \int_{-1}^1 \left(\frac{7x^4}{2} + x^2 \right) dx = \frac{31}{15}; \quad M_x = \int_{-1}^1 \int_0^{x^2} y(7y+1) dy dx = \int_{-1}^1 \left(\frac{7x^6}{3} + \frac{x^4}{2} \right) dx = \frac{13}{15};$$

$$M_y = \int_{-1}^1 \int_0^{x^2} x(7y+1) dy dx = \int_{-1}^1 \left(\frac{7x^5}{2} + x^3 \right) dx = 0 \Rightarrow \bar{x} = 0 \text{ and } \bar{y} = \frac{13}{31};$$

$$I_y = \int_{-1}^1 \int_0^{x^2} x^2(7y+1) dy dx = \int_{-1}^1 \left(\frac{7x^6}{2} + x^4 \right) dx = \frac{7}{5}$$

$$18. M = \int_0^{20} \int_{-1}^1 \left(1 + \frac{x}{20} \right) dy dx = \int_0^{20} \left(2 + \frac{x}{10} \right) dx = 60; \quad M_x = \int_0^{20} \int_{-1}^1 y \left(1 + \frac{x}{20} \right) dy dx = \int_0^{20} \left[\left(1 + \frac{x}{20} \right) \left(\frac{y^2}{2} \right) \right]_{-1}^1 dx = 0;$$

$$M_y = \int_0^{20} \int_{-1}^1 x \left(1 + \frac{x}{20} \right) dy dx = \int_0^{20} \left(2x + \frac{x^2}{10} \right) dx = \frac{2000}{3} \Rightarrow \bar{x} = \frac{100}{9} \text{ and } \bar{y} = 0;$$

$$I_x = \int_0^{20} \int_{-1}^1 y^2 \left(1 + \frac{x}{20} \right) dy dx = \frac{2}{3} \int_0^{20} \left(1 + \frac{x}{20} \right) dx = 20$$

$$19. M = \int_0^1 \int_{-y}^y (y+1) dx dy = \int_0^1 (2y^2 + 2y) dy = \frac{5}{3}; \quad M_x = \int_0^1 \int_{-y}^y y(y+1) dx dy = 2 \int_0^1 (y^3 + y^2) dy = \frac{7}{6};$$

$$M_y = \int_0^1 \int_{-y}^y x(y+1) dx dy = \int_0^1 0 dy = 0 \Rightarrow \bar{x} = 0 \text{ and } \bar{y} = \frac{7}{10}; \quad I_x = \int_0^1 \int_{-y}^y y^2(y+1) dx dy$$

$$= \left(\int_0^1 2y^4 + 2y^3 dy \right) = \frac{9}{10}; \quad I_y = \int_0^1 \int_{-y}^y x^2(y+1) dx dy = \frac{1}{3} \int_0^1 (2y^4 + 2y^3) dy = \frac{3}{10} \Rightarrow I_o = I_x + I_y = \frac{6}{5}$$

$$20. M = \int_0^1 \int_{-y}^y (3x^2 + 1) dx dy = \int_0^1 (2y^3 + 2y) dy = \frac{3}{2}; \quad M_x = \int_0^1 \int_{-y}^y y(3x^2 + 1) dx dy = \int_0^1 (2y^4 + 2y^2) dy = \frac{16}{15};$$

$$M_y = \int_0^1 \int_{-y}^y x(3x^2 + 1) dx dy = 0 \Rightarrow \bar{x} = 0 \text{ and } \bar{y} = \frac{32}{45}; \quad I_x = \int_0^1 \int_{-y}^y y^2(3x^2 + 1) dx dy = \int_0^1 (2y^5 + 2y^3) dy = \frac{5}{6};$$

$$I_y = \int_0^1 \int_{-y}^y x^2(3x^2 + 1) dx dy = 2 \int_0^1 \left(\frac{3}{5} y^5 + \frac{1}{3} y^3 \right) dy = \frac{11}{30} \Rightarrow I_o = I_x + I_y = \frac{6}{5}$$

$$21. I_x = \int_0^a \int_0^b \int_0^c (y^2 + z^2) dz dy dx = \int_0^a \int_0^b \left(cy^2 + \frac{c^3}{3} \right) dy dx = \int_0^a \left(\frac{cb^3}{3} + \frac{c^3b}{3} \right) dx = \frac{abc(b^2 + c^2)}{3} = \frac{M}{3}(b^2 + c^2) \text{ where}$$

$$M = abc; \quad I_y = \frac{M}{3}(a^2 + c^2) \text{ and } I_z = \frac{M}{3}(a^2 + b^2), \text{ by symmetry}$$

$$22. \text{ The plane } z = \frac{4-2y}{3} \text{ is the top of the wedge } \Rightarrow I_x = \int_{-3}^3 \int_{-2}^4 \int_{-4/3}^{(4-2y)/3} (y^2 + z^2) dz dy dx$$

$$= \int_{-3}^3 \int_{-2}^4 \left[\frac{8y^2}{3} - \frac{2y^3}{3} + \frac{8(2-y)^3}{81} + \frac{64}{81} \right] dy dx = \int_{-3}^3 \frac{104}{3} dx = 208; \quad I_y = \int_{-3}^3 \int_{-2}^4 \int_{-4/3}^{(4-2y)/3} (x^2 + z^2) dz dy dx$$

$$= \int_{-3}^3 \int_{-2}^4 \left[\frac{(4-2y)^3}{81} + \frac{x^2(4-2y)}{3} + \frac{4x^2}{3} + \frac{64}{81} \right] dy dx = \int_{-3}^3 \left(12x^2 + \frac{32}{3} \right) dx = 280;$$

$$I_z = \int_{-3}^3 \int_{-2}^4 \int_{-4/3}^{(4-2y)/3} (x^2 + y^2) dz dy dx = \int_{-3}^3 \int_{-2}^4 (x^2 + y^2) \left(\frac{8}{3} - \frac{2y}{3} \right) dy dx = 12 \int_{-3}^3 (x^2 + 2) dx = 360$$

$$23. M = 4 \int_0^1 \int_0^1 \int_{4y^2}^4 dz dy dx = 4 \int_0^1 \int_0^1 (4 - 4y^2) dy dx = 16 \int_0^1 \frac{2}{3} dx = \frac{32}{3}; \quad M_{xy} = 4 \int_0^1 \int_0^1 \int_{4y^2}^4 z dz dy dx$$

$$= 2 \int_0^1 \int_0^1 (16 - 16y^4) dy dx = \frac{128}{5} \int_0^1 dx = \frac{128}{5} \Rightarrow \bar{z} = \frac{12}{5}, \text{ and } \bar{x} = \bar{y} = 0, \text{ by symmetry;}$$

$$I_x = 4 \int_0^1 \int_0^1 \int_{4y^2}^4 (y^2 + z^2) dz dy dx = 4 \int_0^1 \int_0^1 \left[(4y^2 + \frac{64}{3}) - (4y^4 + \frac{64y^6}{3}) \right] dy dx = 4 \int_0^1 \frac{1976}{105} dx = \frac{7904}{105};$$

$$I_y = 4 \int_0^1 \int_0^1 \int_{4y^2}^4 (x^2 + z^2) dz dy dx = 4 \int_0^1 \int_0^1 \left[(4x^2 + \frac{64}{3}) - (4x^2 y^4 + \frac{64y^6}{3}) \right] dy dx = 4 \int_0^1 \left(\frac{8}{3} x^2 + \frac{128}{7} \right) dx = \frac{4832}{63};$$

$$I_z = 4 \int_0^1 \int_0^1 \int_{4y^2}^4 (x^2 + y^2) dz dy dx = 16 \int_0^1 \int_0^1 (x^2 - x^2 y^2 + y^2 - y^4) dy dx = 16 \int_0^1 \left(\frac{2x^2}{3} + \frac{2}{15} \right) dx = \frac{256}{45}$$

24. (a) $M = \int_{-2}^2 \int_{-\sqrt{4-x^2}/2}^{\sqrt{4-x^2}/2} \int_0^{2-x} dz dy dx = \int_{-2}^2 \int_{-\sqrt{4-x^2}/2}^{\sqrt{4-x^2}/2} (2-x) dy dx = \int_{-2}^2 (2-x)\sqrt{4-x^2} dx = 4\pi;$
 $M_{yz} = \int_{-2}^2 \int_{-\sqrt{4-x^2}/2}^{\sqrt{4-x^2}/2} \int_0^{2-x} x dz dy dx = \int_{-2}^2 \int_{-\sqrt{4-x^2}/2}^{\sqrt{4-x^2}/2} x(2-x) dy dx = \int_{-2}^2 x(2-x)\sqrt{4-x^2} dx = -2\pi;$
 $M_{xz} = \int_{-2}^2 \int_{-\sqrt{4-x^2}/2}^{\sqrt{4-x^2}/2} \int_0^{2-x} y dz dy dx = \int_{-2}^2 \int_{-\sqrt{4-x^2}/2}^{\sqrt{4-x^2}/2} y(2-x) dy dx = \frac{1}{2} \int_{-2}^2 (2-x) \left[\frac{4-x^2}{4} - \frac{4-x^2}{4} \right] dx = 0$
 $\Rightarrow \bar{x} = -\frac{1}{2}$ and $\bar{y} = 0$

(b) $M_{xy} = \int_{-2}^2 \int_{-\sqrt{4-x^2}/2}^{\sqrt{4-x^2}/2} \int_0^{2-x} z dz dy dx = \frac{1}{2} \int_{-2}^2 \int_{-\sqrt{4-x^2}/2}^{\sqrt{4-x^2}/2} (2-x)^2 dy dx = \frac{1}{2} \int_{-2}^2 (2-x)^2 \sqrt{4-x^2} dx$
 $= 5\pi \Rightarrow \bar{z} = \frac{5}{4}$

25. (a) $M = 4 \int_0^2 \int_0^{\sqrt{4-x^2}} \int_{x^2+y^2}^4 dz dy dx = 4 \int_0^{\pi/2} \int_0^2 \int_{r^2}^4 r dz dr d\theta = 4 \int_0^{\pi/2} \int_0^2 (4r - r^3) dr d\theta = 4 \int_0^{\pi/2} 4 d\theta = 8\pi;$
 $M_{xy} = \int_0^{2\pi} \int_0^2 \int_{r^2}^4 zr dz dr d\theta = \int_0^{2\pi} \int_0^2 \frac{r}{2} (16 - r^4) dr d\theta = \frac{32}{3} \int_0^{2\pi} d\theta = \frac{64\pi}{3} \Rightarrow \bar{z} = \frac{8}{3},$ and $\bar{x} = \bar{y} = 0,$
 by symmetry

(b) $M = 8\pi \Rightarrow 4\pi = \int_0^{2\pi} \int_0^{\sqrt{c}} \int_{r^2}^c r dz dr d\theta = \int_0^{2\pi} \int_0^{\sqrt{c}} (cr - r^3) dr d\theta = \int_0^{2\pi} \frac{c^2}{4} d\theta = \frac{c^2\pi}{2} \Rightarrow c^2 = 8 \Rightarrow c = 2\sqrt{2},$
 since $c > 0$

26. $M = 8; M_{xy} = \int_{-1}^1 \int_3^5 \int_{-1}^1 z dz dy dx = \int_{-1}^1 \int_3^5 \left[\frac{z^2}{2} \right]_{-1}^1 dy dx = 0; M_{yz} = \int_{-1}^1 \int_3^5 \int_{-1}^1 x dz dy dx = 2 \int_{-1}^1 \int_3^5 x dy dx$
 $= 4 \int_{-1}^1 x dx = 0; M_{xz} = \int_{-1}^1 \int_3^5 \int_{-1}^1 y dz dy dx = 2 \int_{-1}^1 \int_3^5 y dy dx = 16 \int_{-1}^1 dx = 32 \Rightarrow \bar{x} = 0, \bar{y} = 4, \bar{z} = 0;$
 $I_x = \int_{-1}^1 \int_3^5 \int_{-1}^1 (y^2 + z^2) dz dy dx = \int_{-1}^1 \int_3^5 \left(2y^2 + \frac{2}{3} \right) dy dx = \frac{2}{3} \int_{-1}^1 100 dx = \frac{400}{3};$
 $I_y = \int_{-1}^1 \int_3^5 \int_{-1}^1 (x^2 + z^2) dz dy dx = \int_{-1}^1 \int_3^5 \left(2x^2 + \frac{2}{3} \right) dy dx = \frac{4}{3} \int_{-1}^1 (3x^2 + 1) dx = \frac{16}{3};$
 $I_z = \int_{-1}^1 \int_3^5 \int_{-1}^1 (x^2 + y^2) dz dy dx = 2 \int_{-1}^1 \int_3^5 (x^2 + y^2) dy dx = 2 \int_{-1}^1 \left(2x^2 + \frac{98}{3} \right) dx = \frac{400}{3}$

27. The plane $y + 2z = 2$ is the top of the wedge $\Rightarrow I_L = \int_{-2}^2 \int_{-2}^4 \int_{-1}^{(2-y)/2} [(y-6)^2 + z^2] dz dy dx$
 $= \int_{-2}^2 \int_{-2}^4 \left[\frac{(y-6)^2(4-y)}{2} + \frac{(2-y)^3}{24} + \frac{1}{3} \right] dy dx; \text{ let } t = 2 - y \Rightarrow I_L = 4 \int_{-2}^4 \left(\frac{13t^3}{24} + 5t^2 + 16t + \frac{49}{3} \right) dt = 1386;$
 $M = \frac{1}{2}(3)(6)(4) = 36$

28. The plane $y + 2z = 2$ is the top of the wedge $\Rightarrow I_L = \int_{-2}^2 \int_{-2}^4 \int_{-1}^{(2-y)/2} [(x-4)^2 + y^2] dz dy dx$
 $= \frac{1}{2} \int_{-2}^2 \int_{-2}^4 (x^2 - 8x + 16 + y^2)(4-y) dy dx = \int_{-2}^2 (9x^2 - 72x + 162) dx = 696; M = \frac{1}{2}(3)(6)(4) = 36$

29. (a) $M = \int_0^2 \int_0^{2-x} \int_0^{2-x-y} 2x dz dy dx = \int_0^2 \int_0^{2-x} (4x - 2x^2 - 2xy) dy dx = \int_0^2 (x^3 - 4x^2 + 4x) dx = \frac{4}{3}$
 (b) $M_{xy} = \int_0^2 \int_0^{2-x} \int_0^{2-x-y} 2xz dz dy dx = \int_0^2 \int_0^{2-x} x(2-x-y)^2 dy dx = \int_0^2 \frac{x(2-x)^3}{3} dx = \frac{8}{15}; M_{xz} = \frac{8}{15}$ by symmetry; $M_{yz} = \int_0^2 \int_0^{2-x} \int_0^{2-x-y} 2x^2 dz dy dx = \int_0^2 \int_0^{2-x} 2x^2(2-x-y) dy dx = \int_0^2 (2x-x^2)^2 dx = \frac{16}{15}$
 $\Rightarrow \bar{x} = \frac{4}{5}$, and $\bar{y} = \bar{z} = \frac{2}{5}$

30. (a) $M = \int_0^2 \int_0^{\sqrt{x}} \int_0^{4-x^2} kxy dz dy dx = k \int_0^2 \int_0^{\sqrt{x}} xy(4-x^2) dy dx = \frac{k}{2} \int_0^2 (4x^2 - x^4) dx = \frac{32k}{15}$
 (b) $M_{yz} = \int_0^2 \int_0^{\sqrt{x}} \int_0^{4-x^2} kx^2 y dz dy dx = k \int_0^2 \int_0^{\sqrt{x}} x^2 y(4-x^2) dy dx = \frac{k}{2} \int_0^2 (4x^3 - x^5) dx = \frac{8k}{3} \Rightarrow \bar{x} = \frac{5}{4};$
 $M_{xz} = \int_0^2 \int_0^{\sqrt{x}} \int_0^{4-x^2} kxy^2 dz dy dx = k \int_0^2 \int_0^{\sqrt{x}} xy^2(4-x^2) dy dx = \frac{k}{3} \int_0^2 (4x^{5/2} - x^{9/2}) dx = \frac{256\sqrt{2}k}{231}$
 $\Rightarrow \bar{y} = \frac{40\sqrt{2}}{77}; M_{xy} = \int_0^2 \int_0^{\sqrt{x}} \int_0^{4-x^2} kxyz dz dy dx = \int_0^2 \int_0^{\sqrt{x}} xy(4-x^2)^2 dy dx = \frac{k}{4} \int_0^2 (16x^2 - 8x^4 + x^6) dx$
 $= \frac{256k}{105} \Rightarrow \bar{z} = \frac{8}{7}$

31. (a) $M = \int_0^1 \int_0^1 \int_0^1 (x+y+z+1) dz dy dx = \int_0^1 \int_0^1 (x+y+\frac{3}{2}) dy dx = \int_0^1 (x+2) dx = \frac{5}{2}$
 (b) $M_{xy} = \int_0^1 \int_0^1 \int_0^1 z(x+y+z+1) dz dy dx = \frac{1}{2} \int_0^1 \int_0^1 (x+y+\frac{5}{3}) dy dx = \frac{1}{2} \int_0^1 (x+\frac{13}{6}) dx = \frac{4}{3}$
 $\Rightarrow M_{xy} = M_{yz} = M_{xz} = \frac{4}{3}$, by symmetry $\Rightarrow \bar{x} = \bar{y} = \bar{z} = \frac{8}{15}$
 (c) $I_z = \int_0^1 \int_0^1 \int_0^1 (x^2 + y^2)(x+y+z+1) dz dy dx = \int_0^1 \int_0^1 (x^2 + y^2)(x+y+\frac{3}{2}) dy dx$
 $= \int_0^1 (x^3 + 2x^2 + \frac{1}{3}x + \frac{3}{4}) dx = \frac{11}{6} \Rightarrow I_x = I_y = I_z = \frac{11}{6}$, by symmetry

32. The plane $y + 2z = 2$ is the top of the wedge.
 (a) $M = \int_{-1}^1 \int_{-2}^4 \int_{-1}^{(2-y)/2} (x+1) dz dy dx = \int_{-1}^1 \int_{-2}^4 (x+1)(2-\frac{y}{2}) dy dx = 18$
 (b) $M_{yz} = \int_{-1}^1 \int_{-2}^4 \int_{-1}^{(2-y)/2} x(x+1) dz dy dx = \int_{-1}^1 \int_{-2}^4 x(x+1)(2-\frac{y}{2}) dy dx = 6;$
 $M_{xz} = \int_{-1}^1 \int_{-2}^4 \int_{-1}^{(2-y)/2} y(x+1) dz dy dx = \int_{-1}^1 \int_{-2}^4 y(x+1)(2-\frac{y}{2}) dy dx = 0;$
 $M_{xy} = \int_{-1}^1 \int_{-2}^4 \int_{-1}^{(2-y)/2} z(x+1) dz dy dx = \frac{1}{2} \int_{-1}^1 \int_{-2}^4 (x+1)(\frac{y^2}{2} - y) dy dx = 0 \Rightarrow \bar{x} = \frac{1}{3}$, and $\bar{y} = \bar{z} = 0$

$$\begin{aligned}
 \text{(c)} \quad I_x &= \int_{-1}^1 \int_{-2}^4 \int_{-1}^{(2-y)/2} (x+1)(y^2+z^2) dz dy dx = \int_{-1}^1 \int_{-2}^4 (x+1) \left[2y^2 + \frac{1}{3} - \frac{y^3}{2} + \frac{1}{3} \left(1 - \frac{y}{2}\right)^3 \right] dy dx = 45; \\
 I_y &= \int_{-1}^1 \int_{-2}^4 \int_{-1}^{(2-y)/2} (x+1)(x^2+z^2) dz dy dx = \int_{-1}^1 \int_{-2}^4 (x+1) \left[2x^2 + \frac{1}{3} - \frac{x^2 y}{2} + \frac{1}{3} \left(1 - \frac{y}{2}\right)^3 \right] dy dx = 15; \\
 I_z &= \int_{-1}^1 \int_{-2}^4 \int_{-1}^{(2-y)/2} (x+1)(x^2+y^2) dz dy dx = \int_{-1}^1 \int_{-2}^4 (x+1) \left(2 - \frac{y}{2}\right) (x^2+y^2) dy dx = 42
 \end{aligned}$$

$$\begin{aligned}
 33. \quad M &= \int_{-1}^1 \int_{z-1}^{1-z} \int_0^{\sqrt{z}} (2y+5) dy dx dz = \int_0^1 \int_{z-1}^{1-z} (z+5\sqrt{z}) dx dz = \int_0^1 2(z+5\sqrt{z})(1-z) dz \\
 &= 2 \int_0^1 (5z^{1/2} + z - 5z^{3/2} - z^2) dz = 2 \left[\frac{10}{3} z^{3/2} + \frac{1}{2} z^2 - 2z^{5/2} - \frac{1}{3} z^3 \right]_0^1 = 2 \left(\frac{9}{3} - \frac{3}{2} \right) = 3
 \end{aligned}$$

$$\begin{aligned}
 34. \quad M &= \int_{-2}^2 \int_{-\sqrt{4-x^2}}^{\sqrt{4-x^2}} \int_{2(x^2+y^2)}^{16-2(x^2+y^2)} \sqrt{x^2+y^2} dz dy dx = \int_{-2}^2 \int_{-\sqrt{4-x^2}}^{\sqrt{4-x^2}} \sqrt{x^2+y^2} [16-4(x^2+y^2)] dy dx \\
 &= 4 \int_0^{2\pi} \int_0^2 r(4-r^2) r dr d\theta = 4 \int_0^{2\pi} \left[\frac{4r^3}{3} - \frac{r^5}{5} \right]_0^2 d\theta = 4 \int_0^{2\pi} \frac{64}{15} d\theta = \frac{512\pi}{15}
 \end{aligned}$$

$$35. \quad \text{(a)} \quad \bar{x} = \frac{M_{yz}}{M} = 0 \Rightarrow \iiint_R x \delta(x, y, z) dx dy dz = 0 \Rightarrow M_{yz} = 0$$

$$\begin{aligned}
 \text{(b)} \quad I_L &= \iiint_D |\mathbf{v} - h\mathbf{i}|^2 dm = \iiint_D |(x-h)\mathbf{i} + y\mathbf{j}|^2 dm = \iiint_D (x^2 - 2xh + h^2 + y^2) dm \\
 &= \iiint_D (x^2 + y^2) dm - 2h \iiint_D x dm + h^2 \iiint_D dm = I_x - 0 + h^2 m = I_{c.m.} + h^2 m
 \end{aligned}$$

$$36. \quad I_L = I_{c.m.} + mh^2 = \frac{2}{5} ma^2 + ma^2 = \frac{7}{5} ma^2$$

$$\begin{aligned}
 37. \quad \text{(a)} \quad (\bar{x}, \bar{y}, \bar{z}) &= \left(\frac{a}{2}, \frac{b}{2}, \frac{c}{2} \right) \Rightarrow I_z = I_{c.m.} + abc \left(\sqrt{\frac{a^2}{4} + \frac{b^2}{4}} \right)^2 \Rightarrow I_{c.m.} = I_z - \frac{abc(a^2+b^2)}{4} \\
 &= \frac{abc(a^2+b^2)}{3} - \frac{abc(a^2+b^2)}{4} = \frac{abc(a^2+b^2)}{12}; \quad R_{c.m.} = \sqrt{\frac{I_{c.m.}}{M}} = \sqrt{\frac{a^2+b^2}{12}}
 \end{aligned}$$

$$\begin{aligned}
 \text{(b)} \quad I_L &= I_{c.m.} + abc \left(\sqrt{\frac{a^2}{4} + \left(\frac{b}{2} - 2b\right)^2} \right)^2 = \frac{abc(a^2+b^2)}{12} + \frac{abc(a^2+9b^2)}{4} = \frac{abc(4a^2+28b^2)}{12} = \frac{abc(a^2+7b^2)}{3}; \\
 R_L &= \sqrt{\frac{I_L}{M}} = \sqrt{\frac{a^2+7b^2}{3}}
 \end{aligned}$$

$$38. \quad M = \int_{-3}^3 \int_{-2}^4 \int_{-4/3}^{(4-2y)/3} dz dy dx = \int_{-3}^3 \int_{-2}^4 \frac{2}{3}(4-y) dy dx = \int_{-3}^3 \frac{2}{3} \left[4y - \frac{y^2}{2} \right]_{-2}^4 dx = 12 \int_{-3}^2 dx = 72; \quad \bar{x} = \bar{y} = \bar{z} = 0$$

$$\text{from Exercise 22} \Rightarrow I_x = I_{c.m.} + 72 \left(\sqrt{0^2 + 0^2} \right)^2 = I_{c.m.} \Rightarrow I_L = I_{c.m.} + 72 \left(\sqrt{16 + \frac{16}{9}} \right)^2 = 208 + 72 \left(\frac{160}{9} \right) = 1488$$

15.7 TRIPLE INTEGRALS IN CYLINDRICAL AND SPHERICAL COORDINATES

1.
$$\int_0^{2\pi} \int_0^1 \int_r^{\sqrt{2-r^2}} dz r dr d\theta = \int_0^{2\pi} \int_0^1 \left[r(2-r^2)^{1/2} - r^2 \right] dr d\theta = \int_0^{2\pi} \left[-\frac{1}{3}(2-r^2)^{3/2} - \frac{r^3}{3} \right]_0^1 d\theta$$

$$= \int_0^{2\pi} \left(\frac{2^{3/2}}{3} - \frac{2}{3} \right) d\theta = \frac{4\pi(\sqrt{2}-1)}{3}$$
2.
$$\int_0^{2\pi} \int_0^3 \int_{r^2/3}^{\sqrt{18-r^2}} dz r dr d\theta = \int_0^{2\pi} \int_0^3 \left[r(18-r^2)^{1/2} - \frac{r^3}{3} \right] dr d\theta = \int_0^{2\pi} \left[-\frac{1}{3}(18-r^2)^{3/2} - \frac{r^4}{12} \right]_0^3 d\theta = \frac{9\pi(8\sqrt{2}-7)}{2}$$
3.
$$\int_0^{2\pi} \int_0^{\theta/(2\pi)} \int_0^{3+24r^3} dz r dr d\theta = \int_0^{2\pi} \int_0^{\theta/(2\pi)} (3r+24r^3) dr d\theta = \int_0^{2\pi} \left[\frac{3}{2}r^2 + 6r^4 \right]_0^{\theta/(2\pi)} d\theta$$

$$= \frac{3}{2} \int_0^{2\pi} \left(\frac{\theta^2}{4\pi^2} + \frac{4\theta^4}{16\pi^4} \right) d\theta = \frac{3}{2} \left[\frac{\theta^3}{12\pi^2} + \frac{\theta^5}{20\pi^4} \right]_0^{2\pi} = \frac{17\pi}{5}$$
4.
$$\int_0^\pi \int_0^{\theta/\pi} \int_{-\sqrt{4-r^2}}^{\sqrt{4-r^2}} z dz r dr d\theta = \int_0^\pi \int_0^{\theta/\pi} \frac{1}{2} [9(4-r^2) - (4-r^2)] r dr d\theta = 4 \int_0^\pi \int_0^{\theta/\pi} (4r-r^3) dr d\theta$$

$$= 4 \int_0^\pi \left[2r^2 - \frac{r^4}{4} \right]_0^{\theta/\pi} d\theta = 4 \int_0^\pi \left(\frac{2\theta^2}{\pi^2} - \frac{\theta^4}{4\pi^4} \right) d\theta = \frac{37\pi}{15}$$
5.
$$\int_0^{2\pi} \int_0^1 \int_r^{(2-r^2)^{-1/2}} 3 dz r dr d\theta = 3 \int_0^{2\pi} \int_0^1 \left[r(2-r^2)^{-1/2} - r^2 \right] dr d\theta = 3 \int_0^{2\pi} \left[-(2-r^2)^{1/2} - \frac{r^3}{3} \right]_0^1 d\theta$$

$$= 3 \int_0^{2\pi} \left(\sqrt{2} - \frac{4}{3} \right) d\theta = \pi(6\sqrt{2}-8)$$
6.
$$\int_0^{2\pi} \int_0^1 \int_{-1/2}^{1/2} (r^2 \sin^2 \theta + z^2) dz r dr d\theta = \int_0^{2\pi} \int_0^1 \left(r^3 \sin^2 \theta + \frac{r}{12} \right) dr d\theta = \int_0^{2\pi} \left(\frac{\sin^2 \theta}{4} + \frac{1}{24} \right) d\theta = \frac{\pi}{3}$$
7.
$$\int_0^{2\pi} \int_0^3 \int_0^{z/3} r^3 dr dz d\theta = \int_0^{2\pi} \int_0^3 \frac{z^4}{324} dz d\theta = \int_0^{2\pi} \frac{3}{20} d\theta = \frac{3\pi}{10}$$
8.
$$\int_{-1}^1 \int_0^{2\pi} \int_0^{1+\cos \theta} 4r dr d\theta dz = \int_{-1}^1 \int_0^{2\pi} 2(1+\cos \theta)^2 d\theta dz = \int_{-1}^1 6\pi d\theta = 12\pi$$
9.
$$\int_0^1 \int_0^{\sqrt{z}} \int_0^{2\pi} (r^2 \cos^2 \theta + z^2) r d\theta dr dz = \int_0^1 \int_0^{\sqrt{z}} \left[\frac{r^2 \theta}{2} + \frac{r^2 \sin 2\theta}{4} + z^2 \theta \right]_0^{2\pi} r dr dz = \int_0^1 \int_0^{\sqrt{z}} (\pi r^3 + 2\pi r z^2) dr dz$$

$$= \int_0^1 \left[\frac{\pi r^4}{4} + \pi r^2 z^2 \right]_0^{\sqrt{z}} dz = \int_0^1 \left(\frac{\pi z^2}{4} + \pi z^3 \right) dz = \left[\frac{\pi z^3}{12} + \frac{\pi z^4}{4} \right]_0^1 = \frac{\pi}{3}$$
10.
$$\int_0^2 \int_{r-2}^{\sqrt{4-r^2}} \int_0^{2\pi} (r \sin \theta + 1)r d\theta dz dr = \int_0^2 \int_{r-2}^{\sqrt{4-r^2}} 2\pi r dz dr = 2\pi \int_0^2 \left[r(4-r^2)^{1/2} - r^2 + 2r \right] dr$$

$$= 2\pi \left[-\frac{1}{3}(4-r^2)^{3/2} - \frac{r^3}{3} + r^2 \right]_0^2 = 2\pi \left[-\frac{8}{3} + 4 + \frac{1}{3}(4)^{3/2} \right] = 8\pi$$

11. (a) $\int_0^{2\pi} \int_0^1 \int_0^{\sqrt{4-r^2}} dz r dr d\theta$
 (b) $\int_0^{2\pi} \int_0^{\sqrt{3}} \int_0^1 r dr dz d\theta + \int_0^{2\pi} \int_{\sqrt{3}}^2 \int_0^{\sqrt{4-z^2}} r dr dz d\theta$
 (c) $\int_0^1 \int_0^{\sqrt{4-r^2}} \int_0^{2\pi} r d\theta dz dr$

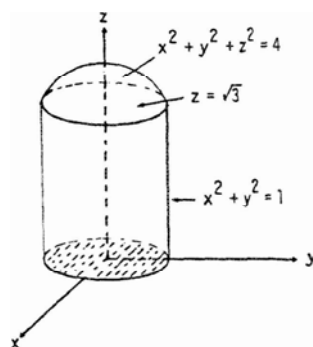

12. (a) $\int_0^{2\pi} \int_0^1 \int_r^{2-r^2} dz r dr d\theta$
 (b) $\int_0^{2\pi} \int_0^1 \int_0^z r dr dz d\theta + \int_0^{2\pi} \int_1^2 \int_0^{\sqrt{2-z}} r dr dz d\theta$
 (c) $\int_0^1 \int_r^{2-r^2} \int_0^{2\pi} r d\theta dz dr$

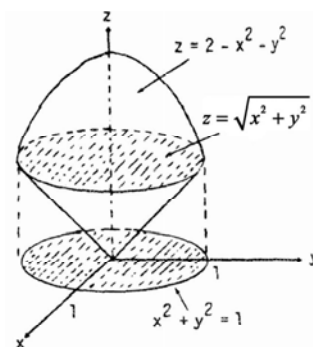

13. $\int_{-\pi/2}^{\pi/2} \int_0^{\cos\theta} \int_0^{3r^2} f(r, \theta, z) dz r dr d\theta$

14. $\int_{-\pi/2}^{\pi/2} \int_0^1 \int_0^{\cos\theta} r^3 dz dr d\theta = \int_{-\pi/2}^{\pi/2} \int_0^1 r^4 \cos\theta dr d\theta = \frac{1}{5} \int_{-\pi/2}^{\pi/2} \cos\theta d\theta = \frac{2}{5}$

15. $\int_0^\pi \int_0^{2\sin\theta} \int_0^{4-r\sin\theta} f(r, \theta, z) dz r dr d\theta$

16. $\int_{-\pi/2}^{\pi/2} \int_0^{3\cos\theta} \int_0^{5-r\cos\theta} f(r, \theta, z) dz r dr d\theta$

17. $\int_{-\pi/2}^{\pi/2} \int_1^{1+\cos\theta} \int_0^4 f(r, \theta, z) dz r dr d\theta$

18. $\int_{-\pi/2}^{\pi/2} \int_{\cos\theta}^{2\cos\theta} \int_0^{3-r\sin\theta} f(r, \theta, z) dz r dr d\theta$

19. $\int_0^{\pi/4} \int_0^{\sec\theta} \int_0^{2-r\sin\theta} f(r, \theta, z) dz r dr d\theta$

20. $\int_{\pi/4}^{\pi/2} \int_0^{\cos\theta} \int_0^{2-r\sin\theta} f(r, \theta, z) dz r dr d\theta$

21. $\int_0^\pi \int_0^\pi \int_0^{2\sin\phi} \rho^2 \sin\phi d\rho d\phi d\theta = \frac{8}{3} \int_0^\pi \int_0^\pi \sin^4\phi d\phi d\theta = \frac{8}{3} \int_0^\pi \left(\left[-\frac{\sin^3\phi \cos\phi}{4} \right]_0^\pi + \frac{3}{4} \int_0^\pi \sin^2\phi d\phi \right) d\theta$
 $= 2 \int_0^\pi \int_0^\pi \sin^2\phi d\phi d\theta = \int_0^\pi \left[\theta - \frac{\sin 2\theta}{2} \right]_0^\pi d\theta = \int_0^\pi \pi d\theta = \pi^2$

22. $\int_0^{2\pi} \int_0^{\pi/4} \int_0^2 (\rho \cos\phi) \rho^2 \sin\phi d\rho d\phi d\theta = \int_0^{2\pi} \int_0^{\pi/4} 4 \cos\phi \sin\phi d\phi d\theta = \int_0^{2\pi} \left[2 \sin^2\phi \right]_0^{\pi/4} d\theta = \int_0^{2\pi} d\theta = 2\pi$

23.
$$\int_0^{2\pi} \int_0^\pi \int_0^{(1-\cos\phi)/2} \rho^2 \sin\phi \, d\rho \, d\phi \, d\theta = \frac{1}{24} \int_0^{2\pi} \int_0^\pi (1-\cos\phi)^3 \sin\phi \, d\phi \, d\theta = \frac{1}{96} \int_0^{2\pi} \left[(1-\cos\phi)^4 \right]_0^\pi d\theta$$

$$= \frac{1}{96} \int_0^{2\pi} (2^4 - 0) \, d\theta = \frac{16}{96} \int_0^{2\pi} d\theta = \frac{1}{6} (2\pi) = \frac{\pi}{3}$$
24.
$$\int_0^{3\pi/2} \int_0^\pi \int_0^1 5\rho^3 \sin^3\phi \, d\rho \, d\phi \, d\theta = \frac{5}{4} \int_0^{3\pi/2} \int_0^\pi \sin^3\phi \, d\phi \, d\theta = \frac{5}{4} \int_0^{3\pi/2} \left(\left[-\frac{\sin^2\phi \cos\phi}{3} \right]_0^\pi + \frac{2}{3} \int_0^\pi \sin\phi \, d\phi \right) d\theta$$

$$= \frac{5}{6} \int_0^{3\pi/2} [-\cos\phi]_0^\pi d\theta = \frac{5}{3} \int_0^{3\pi/2} d\theta = \frac{5\pi}{2}$$
25.
$$\int_0^{2\pi} \int_0^{\pi/3} \int_{\sec\phi}^2 3\rho^2 \sin\phi \, d\rho \, d\phi \, d\theta = \int_0^{2\pi} \int_0^{\pi/3} (8 - \sec^3\phi) \sin\phi \, d\phi \, d\theta = \int_0^{2\pi} \left[-8\cos\phi - \frac{1}{2}\sec^2\phi \right]_0^{\pi/3} d\theta$$

$$= \int_0^{2\pi} \left[(-4 - 2) - (-8 - \frac{1}{2}) \right] d\theta = \frac{5}{2} \int_0^{2\pi} d\theta = 5\pi$$
26.
$$\int_0^{2\pi} \int_0^{\pi/4} \int_0^{\sec\phi} \rho^3 \sin\phi \cos\phi \, d\rho \, d\phi \, d\theta = \frac{1}{4} \int_0^{2\pi} \int_0^{\pi/4} \tan\phi \sec^2\phi \, d\phi \, d\theta = \frac{1}{4} \int_0^{2\pi} \left[\frac{1}{2} \tan^2\phi \right]_0^{\pi/4} d\theta$$

$$= \frac{1}{8} \int_0^{2\pi} d\theta = \frac{\pi}{4}$$
27.
$$\int_0^2 \int_{-\pi}^0 \int_{\pi/4}^{\pi/2} \rho^3 \sin 2\phi \, d\phi \, d\theta \, d\rho = \int_0^2 \int_{-\pi}^0 \rho^3 \left[-\frac{\cos 2\phi}{2} \right]_{\pi/4}^{\pi/2} d\theta \, d\rho = \int_0^2 \int_{-\pi}^0 \frac{\rho^3}{2} d\theta \, d\rho = \int_0^2 \frac{\rho^2 \pi}{2} d\rho$$

$$= \left[\frac{\pi \rho^4}{8} \right]_0^2 = 2\pi$$
28.
$$\int_{\pi/6}^{\pi/3} \int_{\csc\phi}^{2\csc\phi} \int_0^{2\pi} \rho^2 \sin\phi \, d\theta \, d\rho \, d\phi = 2\pi \int_{\pi/6}^{\pi/3} \int_{\csc\phi}^{2\csc\phi} \rho^2 \sin\phi \, d\rho \, d\phi = \frac{2\pi}{3} \int_{\pi/6}^{\pi/3} \left[\rho^3 \sin\phi \right]_{\csc\phi}^{2\csc\phi} d\phi$$

$$= \frac{14\pi}{3} \int_{\pi/6}^{\pi/3} \csc^2\phi \, d\phi = \frac{28\pi}{3\sqrt{3}}$$
29.
$$\int_0^1 \int_0^\pi \int_0^{\pi/4} 12\rho \sin^3\phi \, d\phi \, d\theta \, d\rho = \int_0^1 \int_0^\pi \left(12\rho \left[-\frac{\sin^2\phi \cos\phi}{3} \right]_0^{\pi/4} + 8\rho \int_0^{\pi/4} \sin\phi \, d\phi \right) d\theta \, d\rho$$

$$= \int_0^1 \int_0^\pi \left(-\frac{2\rho}{\sqrt{2}} - 8\rho [\cos\phi]_0^{\pi/4} \right) d\theta \, d\rho = \int_0^1 \int_0^\pi \left(8\rho - \frac{10\rho}{\sqrt{2}} \right) d\theta \, d\rho = \pi \int_0^1 \left(8\rho - \frac{10\rho}{\sqrt{2}} \right) d\rho = \pi \left[4\rho^2 - \frac{5\rho^2}{\sqrt{2}} \right]_0^1$$

$$= \frac{(4\sqrt{2}-5)\pi}{\sqrt{2}}$$
30.
$$\int_{\pi/6}^{\pi/2} \int_{-\pi/2}^{\pi/2} \int_{\csc\phi}^2 5\rho^4 \sin^3\phi \, d\rho \, d\theta \, d\phi = \int_{\pi/6}^{\pi/2} \int_{-\pi/2}^{\pi/2} (32 - \csc^5\phi) \sin^3\phi \, d\theta \, d\phi$$

$$= \int_{\pi/6}^{\pi/2} \int_{-\pi/2}^{\pi/2} (32 \sin^3\phi - \csc^2\phi) \, d\theta \, d\phi = \pi \int_{\pi/6}^{\pi/2} (32 \sin^3\phi - \csc^2\phi) \, d\phi$$

$$= \pi \left[-\frac{32 \sin^2\phi \cos\phi}{3} \right]_{\pi/6}^{\pi/2} + \frac{64\pi}{3} \int_{\pi/6}^{\pi/2} \sin\phi \, d\phi + \pi [\cot\phi]_{\pi/6}^{\pi/2} = \pi \left(\frac{32\sqrt{3}}{24} \right) - \frac{64\pi}{3} [\cos\phi]_{\pi/6}^{\pi/2} - \pi (\sqrt{3})$$

$$= \frac{\sqrt{3}}{3} \pi + \left(\frac{64\pi}{3} \right) \left(\frac{\sqrt{3}}{2} \right) = \frac{33\pi\sqrt{3}}{3} = 11\pi\sqrt{3}$$

31. (a) $x^2 + y^2 = 1 \Rightarrow \rho^2 \sin^2 \phi = 1$, and $\rho \sin \phi = 1 \Rightarrow \rho = \csc \phi$;

thus $\int_0^{2\pi} \int_0^{\pi/6} \int_0^{\csc \phi} \rho^2 \sin \phi \, d\rho \, d\phi \, d\theta + \int_0^{2\pi} \int_{\pi/6}^{\pi/2} \int_0^{\csc \phi} \rho^2 \sin \phi \, d\rho \, d\phi \, d\theta$

(b) $\int_0^{2\pi} \int_1^2 \int_0^{\sin^{-1}(1/\rho)} \rho^2 \sin \phi \, d\phi \, d\rho \, d\theta + \int_0^{2\pi} \int_0^2 \int_0^{\pi/6} \rho^2 \sin \phi \, d\phi \, d\rho \, d\theta$

32. (a) $\int_0^{2\pi} \int_0^{\pi/4} \int_0^{\sec \phi} \rho^2 \sin \phi \, d\rho \, d\phi \, d\theta$

(b) $\int_0^{2\pi} \int_0^1 \int_0^{\pi/4} \rho^2 \sin \phi \, d\phi \, d\rho \, d\theta + \int_0^{2\pi} \int_1^{\sqrt{2}} \int_{\cos^{-1}(1/\rho)}^{\pi/4} \rho^2 \sin \phi \, d\phi \, d\rho \, d\theta$

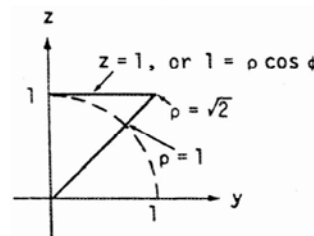

33. $V = \int_0^{2\pi} \int_0^{\pi/2} \int_{\cos \phi}^2 \rho^2 \sin \phi \, d\rho \, d\phi \, d\theta = \frac{1}{3} \int_0^{2\pi} \int_0^{\pi/2} (8 - \cos^3 \phi) \sin \phi \, d\phi \, d\theta = \frac{1}{3} \int_0^{2\pi} \left[-8 \cos \phi + \frac{\cos^4 \phi}{4} \right]_0^{\pi/2} d\theta$
 $= \frac{1}{3} \int_0^{2\pi} \left(8 - \frac{1}{4} \right) d\theta = \left(\frac{31}{12} \right) (2\pi) = \frac{31\pi}{6}$

34. $V = \int_0^{2\pi} \int_0^{\pi/2} \int_1^{1+\cos \phi} \rho^2 \sin \phi \, d\rho \, d\phi \, d\theta = \frac{1}{3} \int_0^{2\pi} \int_0^{\pi/2} (3 \cos \phi + 3 \cos^2 \phi + \cos^3 \phi) \sin \phi \, d\phi \, d\theta$
 $= \frac{1}{3} \int_0^{2\pi} \left[-\frac{3}{2} \cos^2 \phi - \cos^3 \phi - \frac{1}{4} \cos^4 \phi \right]_0^{\pi/2} d\theta = \frac{1}{3} \int_0^{2\pi} \left(\frac{3}{2} + 1 + \frac{1}{4} \right) d\theta = \frac{11}{12} \int_0^{2\pi} d\theta = \left(\frac{11}{12} \right) (2\pi) = \frac{11\pi}{6}$

35. $V = \int_0^{2\pi} \int_0^{\pi} \int_0^{1-\cos \phi} \rho^2 \sin \phi \, d\rho \, d\phi \, d\theta = \frac{1}{3} \int_0^{2\pi} \int_0^{\pi} (1 - \cos \phi)^3 \sin \phi \, d\phi \, d\theta = \frac{1}{3} \int_0^{2\pi} \left[\frac{(1 - \cos \phi)^4}{4} \right]_0^{\pi} d\theta$
 $= \frac{1}{12} (2)^4 \int_0^{2\pi} d\theta = \frac{4}{3} (2\pi) = \frac{8\pi}{3}$

36. $V = \int_0^{2\pi} \int_0^{\pi/2} \int_0^{1-\cos \phi} \rho^2 \sin \phi \, d\rho \, d\phi \, d\theta = \frac{1}{3} \int_0^{2\pi} \int_0^{\pi/2} (1 - \cos \phi)^3 \sin \phi \, d\phi \, d\theta = \frac{1}{3} \int_0^{2\pi} \left[\frac{(1 - \cos \phi)^4}{4} \right]_0^{\pi/2} d\theta$
 $= \frac{1}{12} \int_0^{2\pi} d\theta = \frac{1}{12} (2\pi) = \frac{\pi}{6}$

37. $V = \int_0^{2\pi} \int_{\pi/4}^{\pi/2} \int_0^{2 \cos \phi} \rho^2 \sin \phi \, d\rho \, d\phi \, d\theta = \frac{8}{3} \int_0^{2\pi} \int_{\pi/4}^{\pi/2} \cos^3 \phi \sin \phi \, d\phi \, d\theta = \frac{8}{3} \int_0^{2\pi} \left[-\frac{\cos^4 \phi}{4} \right]_{\pi/4}^{\pi/2} d\theta$
 $= \left(\frac{8}{3} \right) \left(\frac{1}{16} \right) \int_0^{2\pi} d\theta = \frac{1}{6} (2\pi) = \frac{\pi}{3}$

38. $V = \int_0^{2\pi} \int_{\pi/3}^{\pi/2} \int_0^2 \rho^2 \sin \phi \, d\rho \, d\phi \, d\theta = \frac{8}{3} \int_0^{2\pi} \int_{\pi/3}^{\pi/2} \sin \phi \, d\phi \, d\theta = \frac{8}{3} \int_0^{2\pi} \left[-\cos \phi \right]_{\pi/3}^{\pi/2} d\theta = \frac{4}{3} \int_0^{2\pi} d\theta = \frac{8\pi}{3}$

39. (a) $8 \int_0^{\pi/2} \int_0^{\pi/2} \int_0^2 \rho^2 \sin \phi \, d\rho \, d\phi \, d\theta$

(b) $8 \int_0^{\pi/2} \int_0^2 \int_0^{\sqrt{4-r^2}} dz \, r \, dr \, d\theta$

(c) $8 \int_0^2 \int_0^{\sqrt{4-x^2}} \int_0^{\sqrt{4-x^2-y^2}} dz \, dy \, dx$

$$40. \quad (a) \int_0^{\pi/2} \int_0^{3/\sqrt{2}} \int_r^{\sqrt{9-r^2}} dz r dr d\theta \qquad (b) \int_0^{\pi/2} \int_0^{\pi/4} \int_r^3 \rho^2 \sin \phi d\rho d\phi d\theta$$

$$(c) \int_0^{\pi/2} \int_0^{\pi/4} \int_0^3 \rho^2 \sin \phi d\rho d\phi d\theta = 9 \int_0^{\pi/2} \int_0^{\pi/4} \sin \phi d\phi d\theta = -9 \int_0^{\pi/2} \left(\frac{1}{\sqrt{2}} - 1 \right) d\theta = \frac{9\pi(2-\sqrt{2})}{4}$$

$$41. \quad (a) V = \int_0^{2\pi} \int_0^{\pi/3} \int_{\sec \phi}^2 \rho^2 \sin \phi d\rho d\phi d\theta \qquad (b) V = \int_0^{2\pi} \int_0^{\sqrt{3}} \int_1^{\sqrt{4-r^2}} dz r dr d\theta$$

$$(c) V = \int_{-\sqrt{3}}^{\sqrt{3}} \int_{-\sqrt{3-x^2}}^{\sqrt{3-x^2}} \int_1^{\sqrt{4-x^2-y^2}} dz dy dx$$

$$(d) V = \int_0^{2\pi} \int_0^{\sqrt{3}} \left[r(4-r^2)^{1/2} - r \right] dr d\theta = \int_0^{2\pi} \left[-\frac{(4-r^2)^{3/2}}{3} - \frac{r^2}{2} \right]_0^{\sqrt{3}} d\theta = \int_0^{2\pi} \left(-\frac{1}{3} - \frac{3}{2} + \frac{4^{3/2}}{3} \right) d\theta$$

$$= \frac{5}{6} \int_0^{2\pi} d\theta = \frac{5\pi}{3}$$

$$42. \quad (a) I_z = \int_0^{2\pi} \int_0^1 \int_0^{\sqrt{1-r^2}} r^2 dz r dr d\theta$$

$$(b) I_z = \int_0^{2\pi} \int_0^{\pi/2} \int_0^1 (\rho^2 \sin^2 \phi) (\rho^2 \sin \phi) d\rho d\phi d\theta,$$

$$\text{since } r^2 = x^2 + y^2 = \rho^2 \sin^2 \phi \cos^2 \theta + \rho^2 \sin^2 \phi \sin^2 \theta = \rho^2 \sin^2 \phi$$

$$(c) I_z = \int_0^{2\pi} \int_0^{\pi/2} \frac{1}{5} \sin^3 \phi d\phi d\theta = \frac{1}{5} \int_0^{2\pi} \left(\left[-\frac{\sin^2 \phi \cos \phi}{3} \right]_0^{\pi/2} + \frac{2}{3} \int_0^{\pi/2} \sin \phi d\phi \right) d\theta = \frac{2}{15} \int_0^{2\pi} [-\cos \phi]_0^{\pi/2} d\theta$$

$$= \frac{2}{15} (2\pi) = \frac{4\pi}{15}$$

$$43. \quad V = 4 \int_0^{\pi/2} \int_0^1 \int_{r^4-1}^{4-4r^2} dz r dr d\theta = 4 \int_0^{\pi/2} \int_0^1 (5r - 4r^3 - r^5) dr d\theta = 4 \int_0^{\pi/2} \left(\frac{5}{2} - 1 - \frac{1}{6} \right) d\theta = 4 \int_0^{\pi/2} d\theta = \frac{8\pi}{3}$$

$$44. \quad V = 4 \int_0^{\pi/2} \int_0^1 \int_{-\sqrt{1-r^2}}^{1-r} dz r dr d\theta = 4 \int_0^{\pi/2} \int_0^1 \left(r - r^2 + r\sqrt{1-r^2} \right) dr d\theta = 4 \int_0^{\pi/2} \left[\frac{r^2}{2} - \frac{r^3}{3} - \frac{1}{3} (1-r^2)^{3/2} \right]_0^1 d\theta$$

$$= 4 \int_0^{\pi/2} \left(\frac{1}{2} - \frac{1}{3} + \frac{1}{3} \right) d\theta = 2 \int_0^{\pi/2} d\theta = 2 \left(\frac{\pi}{2} \right) = \pi$$

$$45. \quad V = \int_{3\pi/2}^{2\pi} \int_0^{3\cos \theta} \int_0^{-r\sin \theta} dz r dr d\theta = \int_{3\pi/2}^{2\pi} \int_0^{3\cos \theta} (-r^2 \sin \theta) dr d\theta = \int_{3\pi/2}^{2\pi} (-9 \cos^3 \theta) (\sin \theta) d\theta$$

$$= \left[\frac{9}{4} \cos^4 \theta \right]_{3\pi/2}^{2\pi} = \frac{9}{4} - 0 = \frac{9}{4}$$

$$46. \quad V = 2 \int_{\pi/2}^{\pi} \int_0^{-3\cos \theta} \int_0^r dz r dr d\theta = 2 \int_{\pi/2}^{\pi} \int_0^{-3\cos \theta} r^2 dr d\theta = \frac{2}{3} \int_{\pi/2}^{\pi} (-27 \cos^3 \theta) d\theta$$

$$= -18 \left(\left[\frac{\cos^2 \theta \sin \theta}{3} \right]_{\pi/2}^{\pi} + \frac{2}{3} \int_{\pi/2}^{\pi} \cos \theta d\theta \right) = -12 [\sin \theta]_{\pi/2}^{\pi} = 12$$

$$\begin{aligned}
 47. \quad V &= \int_0^{\pi/2} \int_0^{\sin \theta} \int_0^{\sqrt{1-r^2}} dz \, r \, dr \, d\theta = \int_0^{\pi/2} \int_0^{\sin \theta} r\sqrt{1-r^2} \, dr \, d\theta = \int_0^{\pi/2} \left[-\frac{1}{3}(1-r^2)^{3/2} \right]_0^{\sin \theta} d\theta \\
 &= -\frac{1}{3} \int_0^{\pi/2} \left[(1-\sin^2 \theta)^{3/2} - 1 \right] d\theta = -\frac{1}{3} \int_0^{\pi/2} (\cos^3 \theta - 1) d\theta = -\frac{1}{3} \left(\left[\frac{\cos^2 \theta \sin \theta}{3} \right]_0^{\pi/2} + \frac{2}{3} \int_0^{\pi/2} \cos \theta \, d\theta \right) + \left[\frac{\theta}{3} \right]_0^{\pi/2} \\
 &= -\frac{2}{9} [\sin \theta]_0^{\pi/2} + \frac{\pi}{6} = \frac{-4+3\pi}{18}
 \end{aligned}$$

$$\begin{aligned}
 48. \quad V &= \int_0^{\pi/2} \int_0^{\cos \theta} \int_0^{3\sqrt{1-r^2}} dz \, r \, dr \, d\theta = \int_0^{\pi/2} \int_0^{\cos \theta} 3r\sqrt{1-r^2} \, dr \, d\theta = \int_0^{\pi/2} \left[-(1-r^2)^{3/2} \right]_0^{\cos \theta} d\theta \\
 &= \int_0^{\pi/2} \left[-(1-\cos^2 \theta)^{3/2} + 1 \right] d\theta = \int_0^{\pi/2} (1-\sin^3 \theta) d\theta = \left[\theta + \frac{\sin^2 \theta \cos \theta}{3} \right]_0^{\pi/2} - \frac{2}{3} \int_0^{\pi/2} \sin \theta \, d\theta \\
 &= \frac{\pi}{2} + \frac{2}{3} [\cos \theta]_0^{\pi/2} = \frac{\pi}{2} - \frac{2}{3} = \frac{3\pi-4}{6}
 \end{aligned}$$

$$\begin{aligned}
 49. \quad V &= \int_0^{2\pi} \int_{\pi/3}^{2\pi/3} \int_0^a \rho^2 \sin \phi \, d\rho \, d\phi \, d\theta = \int_0^{2\pi} \int_{\pi/3}^{2\pi/3} \frac{a^3}{3} \sin \phi \, d\phi \, d\theta = \frac{a^3}{3} \int_0^{2\pi} [-\cos \phi]_{\pi/3}^{2\pi/3} d\theta = \frac{a^3}{3} \int_0^{2\pi} \left(\frac{1}{2} + \frac{1}{2} \right) d\theta \\
 &= \frac{2\pi a^3}{3}
 \end{aligned}$$

$$50. \quad V = \int_0^{\pi/6} \int_0^{\pi/2} \int_0^a \rho^2 \sin \phi \, d\rho \, d\phi \, d\theta = \frac{a^3}{3} \int_0^{\pi/6} \int_0^{\pi/2} \sin \phi \, d\phi \, d\theta = \frac{a^3}{3} \int_0^{\pi/6} d\theta = \frac{a^3 \pi}{18}$$

$$\begin{aligned}
 51. \quad V &= \int_0^{2\pi} \int_0^{\pi/3} \int_{\sec \phi}^2 \rho^2 \sin \phi \, d\rho \, d\phi \, d\theta \\
 &= \frac{1}{3} \int_0^{2\pi} \int_0^{\pi/3} (8 \sin \phi - \tan \phi \sec^2 \phi) d\phi \, d\theta \\
 &= \frac{1}{3} \int_0^{2\pi} \left[-8 \cos \phi - \frac{1}{2} \tan^2 \phi \right]_0^{\pi/3} d\theta \\
 &= \frac{1}{3} \int_0^{2\pi} \left[-4 - \frac{1}{2}(3) + 8 \right] d\theta = \frac{1}{3} \int_0^{2\pi} \frac{5}{2} d\theta = \frac{5}{6} (2\pi) = \frac{5\pi}{3}
 \end{aligned}$$

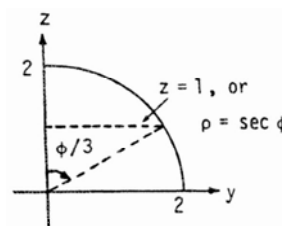

$$\begin{aligned}
 52. \quad V &= 4 \int_0^{\pi/2} \int_0^{\pi/4} \int_{\sec \phi}^{2 \sec \phi} \rho^2 \sin \phi \, d\rho \, d\phi \, d\theta = \frac{4}{3} \int_0^{\pi/2} \int_0^{\pi/4} (8 \sec^3 \phi - \sec^3 \phi) \sin \phi \, d\phi \, d\theta \\
 &= \frac{28}{3} \int_0^{\pi/2} \int_0^{\pi/4} \sec^3 \phi \sin \phi \, d\phi \, d\theta = \frac{28}{3} \int_0^{\pi/2} \int_0^{\pi/4} \tan \phi \sec^2 \phi \, d\phi \, d\theta = \frac{28}{3} \int_0^{\pi/2} \left[\frac{1}{2} \tan^2 \phi \right]_0^{\pi/4} d\theta \\
 &= \frac{14}{3} \int_0^{\pi/2} d\theta = \frac{7\pi}{3}
 \end{aligned}$$

$$53. \quad V = 4 \int_0^{\pi/2} \int_0^1 \int_0^{r^2} dz \, r \, dr \, d\theta = 4 \int_0^{\pi/2} \int_0^1 r^3 \, dr \, d\theta = \int_0^{\pi/2} d\theta = \frac{\pi}{2}$$

$$54. \quad V = 4 \int_0^{\pi/2} \int_0^1 \int_{r^2}^{r^2+1} dz \, r \, dr \, d\theta = 4 \int_0^{\pi/2} \int_0^1 r \, dr \, d\theta = 2 \int_0^{\pi/2} d\theta = \pi$$

$$55. \quad V = 8 \int_0^{\pi/2} \int_1^{\sqrt{2}} \int_0^r dz \, r \, dr \, d\theta = 8 \int_0^{\pi/2} \int_1^{\sqrt{2}} r^2 \, dr \, d\theta = 8 \left(\frac{2\sqrt{2}-1}{3} \right) \int_0^{\pi/2} d\theta = \frac{4\pi(2\sqrt{2}-1)}{3}$$

$$56. V = 8 \int_0^{\pi/2} \int_1^{\sqrt{2}} \int_0^{\sqrt{2-r^2}} dz r dr d\theta = 8 \int_0^{\pi/2} \int_1^{\sqrt{2}} r \sqrt{2-r^2} dr d\theta = 8 \int_0^{\pi/2} \left[-\frac{1}{3} (2-r^2)^{3/2} \right]_1^{\sqrt{2}} d\theta = 8 \int_0^{\pi/2} d\theta = \frac{4\pi}{3}$$

$$57. V = \int_0^{2\pi} \int_0^2 \int_0^{4-r\sin\theta} dz r dr d\theta = \int_0^{2\pi} \int_0^2 (4r - r^2 \sin\theta) dr d\theta = 8 \int_0^{2\pi} \left(1 - \frac{\sin\theta}{3}\right) d\theta = 16\pi$$

$$58. V = \int_0^{2\pi} \int_0^2 \int_0^{4-r\cos\theta-r\sin\theta} dz r dr d\theta = \int_0^{2\pi} \int_0^2 [4r - r^2(\cos\theta + \sin\theta)] dr d\theta = \frac{8}{3} \int_0^{2\pi} (3 - \cos\theta - \sin\theta) d\theta = 16\pi$$

59. The paraboloids intersect when $4x^2 + 4y^2 = 5 - x^2 - y^2 \Rightarrow x^2 + y^2 = 1$ and $z = 4$
 $\Rightarrow V = 4 \int_0^{\pi/2} \int_0^1 \int_{4r^2}^{5-r^2} dz r dr d\theta = 4 \int_0^{\pi/2} \int_0^1 (5r - 5r^3) dr d\theta = 20 \int_0^{\pi/2} \left[\frac{r^2}{2} - \frac{r^4}{4} \right]_0^1 d\theta = 5 \int_0^{\pi/2} d\theta = \frac{5\pi}{2}$

60. The paraboloid intersects the xy -plane when $9 - x^2 - y^2 = 0 \Rightarrow x^2 + y^2 = 9 \Rightarrow V = 4 \int_0^{\pi/2} \int_1^3 \int_0^{9-r^2} dz r dr d\theta$
 $= 4 \int_0^{\pi/2} \int_1^3 (9r - r^3) dr d\theta = 4 \int_0^{\pi/2} \left[\frac{9r^2}{2} - \frac{r^4}{4} \right]_1^3 d\theta = 4 \int_0^{\pi/2} \left(\frac{81}{4} - \frac{17}{4} \right) d\theta = 64 \int_0^{\pi/2} d\theta = 32\pi$

$$61. V = 8 \int_0^{2\pi} \int_0^1 \int_0^{\sqrt{4-r^2}} dz r dr d\theta = 8 \int_0^{2\pi} \int_0^1 r(4-r^2)^{1/2} dr d\theta = 8 \int_0^{2\pi} \left[-\frac{1}{3} (4-r^2)^{3/2} \right]_0^1 d\theta = -\frac{8}{3} \int_0^{2\pi} (3^{3/2} - 8) d\theta = \frac{4\pi(8-3\sqrt{3})}{3}$$

62. The sphere and paraboloid intersect when $x^2 + y^2 + z^2 = 2$ and $z = x^2 + y^2 \Rightarrow z^2 + z - 2 = 0$
 $\Rightarrow (z+2)(z-1) = 0 \Rightarrow z = 1$ or $z = -2 \Rightarrow z = 1$ since $z \geq 0$. Thus, $x^2 + y^2 = 1$ and the volume is given by the triple integral $V = 4 \int_0^{\pi/2} \int_0^1 \int_{r^2}^{\sqrt{2-r^2}} dz r dr d\theta = 4 \int_0^{\pi/2} \int_0^1 [r(2-r^2)^{1/2} - r^3] dr d\theta$
 $= 4 \int_0^{\pi/2} \left[-\frac{1}{3} (2-r^2)^{3/2} - \frac{r^4}{4} \right]_0^1 d\theta = 4 \int_0^{\pi/2} \left(\frac{2\sqrt{2}}{3} - \frac{7}{12} \right) d\theta = \frac{\pi(8\sqrt{2}-7)}{6}$

$$63. \text{average} = \frac{1}{2\pi} \int_0^{2\pi} \int_0^1 \int_{-1}^1 r^2 dz dr d\theta = \frac{1}{2\pi} \int_0^{2\pi} \int_0^1 2r^2 dr d\theta = \frac{1}{3\pi} \int_0^{2\pi} d\theta = \frac{2}{3}$$

$$64. \text{average} = \frac{1}{\left(\frac{4\pi}{3}\right)} \int_0^{2\pi} \int_0^1 \int_{-\sqrt{1-r^2}}^{\sqrt{1-r^2}} r^2 dz dr d\theta = \frac{3}{4\pi} \int_0^{2\pi} \int_0^1 2r^2 \sqrt{1-r^2} dr d\theta$$

$$= \frac{3}{2\pi} \int_0^{2\pi} \left[\frac{1}{8} \sin^{-1} r - \frac{1}{8} r \sqrt{1-r^2} (1-2r^2) \right]_0^1 d\theta = \frac{3}{16\pi} \int_0^{2\pi} \left(\frac{\pi}{2} + 0 \right) d\theta = \frac{3}{32} \int_0^{2\pi} d\theta = \left(\frac{3}{32} \right) (2\pi) = \frac{3\pi}{16}$$

$$65. \text{average} = \frac{1}{\left(\frac{4\pi}{3}\right)} \int_0^{2\pi} \int_0^{\pi} \int_0^1 \rho^3 \sin\phi d\rho d\phi d\theta = \frac{3}{16\pi} \int_0^{2\pi} \int_0^{\pi} \sin\phi d\phi d\theta = \frac{3}{8\pi} \int_0^{2\pi} d\theta = \frac{3}{4}$$

$$66. \text{ average} = \frac{1}{\left(\frac{2\pi}{3}\right)} \int_0^{2\pi} \int_0^{\pi/2} \int_0^1 \rho^3 \cos \phi \sin \phi \, d\rho \, d\phi \, d\theta = \frac{3}{8\pi} \int_0^{2\pi} \int_0^{\pi/2} \cos \phi \sin \phi \, d\phi \, d\theta = \frac{3}{8\pi} \int_0^{2\pi} \left[\frac{\sin^2 \phi}{2} \right]_0^{\pi/2} d\theta$$

$$= \frac{3}{16\pi} \int_0^{2\pi} d\theta = \left(\frac{3}{16\pi}\right)(2\pi) = \frac{3}{8}$$

$$67. M = 4 \int_0^{\pi/2} \int_0^1 \int_0^r dz \, r \, dr \, d\theta = 4 \int_0^{\pi/2} \int_0^1 r^2 \, dr \, d\theta = \frac{4}{3} \int_0^{\pi/2} d\theta = \frac{2\pi}{3}; \quad M_{xy} = \int_0^{2\pi} \int_0^1 \int_0^r z \, dz \, r \, dr \, d\theta$$

$$= \frac{1}{2} \int_0^{2\pi} \int_0^1 r^3 \, dr \, d\theta = \frac{1}{8} \int_0^{2\pi} d\theta = \frac{\pi}{4} \Rightarrow \bar{z} = \frac{M_{xy}}{M} = \left(\frac{\pi}{4}\right)\left(\frac{3}{2\pi}\right) = \frac{3}{8}, \text{ and } \bar{x} = \bar{y} = 0, \text{ by symmetry}$$

$$68. M = \int_0^{\pi/2} \int_0^2 \int_0^r dz \, r \, dr \, d\theta = \int_0^{\pi/2} \int_0^2 r^2 \, dr \, d\theta = \frac{8}{3} \int_0^{\pi/2} d\theta = \frac{4\pi}{3}; \quad M_{yz} = \int_0^{\pi/2} \int_0^2 \int_0^r x \, dz \, r \, dr \, d\theta$$

$$= \int_0^{\pi/2} \int_0^2 r^3 \cos \theta \, dr \, d\theta = 4 \int_0^{\pi/2} \cos \theta \, d\theta = 4; \quad M_{xz} = \int_0^{\pi/2} \int_0^2 \int_0^r y \, dz \, r \, dr \, d\theta = \int_0^{\pi/2} \int_0^2 r^3 \sin \theta \, dr \, d\theta$$

$$= 4 \int_0^{\pi/2} \sin \theta \, d\theta = 4; \quad M_{xy} = \int_0^{\pi/2} \int_0^2 \int_0^r z \, dz \, r \, dr \, d\theta = \frac{1}{2} \int_0^{\pi/2} \int_0^2 r^3 \, dr \, d\theta = 2 \int_0^{\pi/2} d\theta = \pi \Rightarrow \bar{x} = \frac{M_{yz}}{M} = \frac{3}{\pi},$$

$$\bar{y} = \frac{M_{xz}}{M} = \frac{3}{\pi}, \text{ and } \bar{z} = \frac{M_{xy}}{M} = \frac{3}{4}$$

$$69. M = \frac{8\pi}{3}; \quad M_{xy} = \int_0^{2\pi} \int_{\pi/3}^{\pi/2} \int_0^2 z \rho^2 \sin \phi \, d\rho \, d\phi \, d\theta = \int_0^{2\pi} \int_{\pi/3}^{\pi/2} \rho^3 \cos \phi \sin \phi \, d\rho \, d\phi \, d\theta$$

$$= 4 \int_0^{2\pi} \int_{\pi/3}^{\pi/2} \cos \phi \sin \phi \, d\phi \, d\theta = 4 \int_0^{2\pi} \left[\frac{\sin^2 \phi}{2} \right]_{\pi/3}^{\pi/2} d\theta = 4 \int_0^{2\pi} \left(\frac{1}{2} - \frac{3}{8} \right) d\theta = \frac{1}{2} \int_0^{2\pi} d\theta = \pi$$

$$\Rightarrow \bar{z} = \frac{M_{xy}}{M} = (\pi) \left(\frac{3}{8\pi} \right) = \frac{3}{8}, \text{ and } \bar{x} = \bar{y} = 0, \text{ by symmetry}$$

$$70. M = \int_0^{2\pi} \int_0^{\pi/4} \int_0^a \rho^2 \sin \phi \, d\rho \, d\phi \, d\theta = \frac{a^3}{3} \int_0^{2\pi} \int_0^{\pi/4} \sin \phi \, d\phi \, d\theta = \frac{a^3}{3} \int_0^{2\pi} \frac{2-\sqrt{2}}{2} \, d\theta = \frac{\pi a^3 (2-\sqrt{2})}{3};$$

$$M_{xy} = \int_0^{2\pi} \int_0^{\pi/4} \int_0^a \rho^3 \sin \phi \cos \phi \, d\rho \, d\phi \, d\theta = \frac{a^4}{4} \int_0^{2\pi} \int_0^{\pi/4} \sin \phi \, d\phi \, d\theta = \frac{a^4}{16} \int_0^{2\pi} d\theta = \frac{\pi a^4}{8}$$

$$\Rightarrow \bar{z} = \frac{M_{xy}}{M} = \left(\frac{\pi a^4}{8} \right) \left[\frac{3}{\pi a^3 (2-\sqrt{2})} \right] = \left(\frac{3a}{8} \right) \left(\frac{2+\sqrt{2}}{2} \right) = \frac{3(2+\sqrt{2})a}{16}, \text{ and } \bar{x} = \bar{y} = 0, \text{ by symmetry}$$

$$71. M = \int_0^{2\pi} \int_0^4 \int_0^{\sqrt{r}} dz \, r \, dr \, d\theta = \int_0^{2\pi} \int_0^4 r^{3/2} \, dr \, d\theta = \frac{64}{5} \int_0^{2\pi} d\theta = \frac{128\pi}{5}; \quad M_{xy} = \int_0^{2\pi} \int_0^4 \int_0^{\sqrt{r}} z \, dz \, r \, dr \, d\theta$$

$$= \frac{1}{2} \int_0^{2\pi} \int_0^4 r^2 \, dr \, d\theta = \frac{32}{3} \int_0^{2\pi} d\theta = \frac{64\pi}{3} \Rightarrow \bar{z} = \frac{M_{xy}}{M} = \frac{5}{6}, \text{ and } \bar{x} = \bar{y} = 0, \text{ by symmetry}$$

$$72. M = \int_{-\pi/3}^{\pi/3} \int_0^1 \int_{-\sqrt{1-r^2}}^{\sqrt{1-r^2}} dz \, r \, dr \, d\theta = \int_{-\pi/3}^{\pi/3} \int_0^1 2r\sqrt{1-r^2} \, dr \, d\theta = \int_{-\pi/3}^{\pi/3} \left[-\frac{2}{3}(1-r^2)^{3/2} \right]_0^1 d\theta$$

$$= \frac{2}{3} \int_{-\pi/3}^{\pi/3} d\theta = \left(\frac{2}{3}\right)\left(\frac{2\pi}{3}\right) = \frac{4\pi}{9}; \quad M_{yz} = \int_{-\pi/3}^{\pi/3} \int_0^1 \int_{-\sqrt{1-r^2}}^{\sqrt{1-r^2}} r^2 \cos \theta \, dz \, dr \, d\theta = 2 \int_{-\pi/3}^{\pi/3} \int_0^1 r^2 \sqrt{1-r^2} \cos \theta \, dr \, d\theta$$

$$= 2 \int_{-\pi/3}^{\pi/3} \left[\frac{1}{8} \sin^{-1} r - \frac{1}{8} r \sqrt{1-r^2} (1-2r^2) \right]_0^1 \cos \theta \, d\theta = \frac{\pi}{8} \int_{-\pi/3}^{\pi/3} \cos \theta \, d\theta = \frac{\pi}{8} [\sin \theta]_{-\pi/3}^{\pi/3} = \left(\frac{\pi}{8}\right)\left(2 \cdot \frac{\sqrt{3}}{2}\right) = \frac{\pi\sqrt{3}}{8}$$

$$\Rightarrow \bar{x} = \frac{M_{yz}}{M} = \frac{9\sqrt{3}}{32}, \text{ and } \bar{y} = \bar{z} = 0, \text{ by symmetry}$$

73. We orient the cone with its vertex at the origin and axis along the z -axis $\Rightarrow \phi = \frac{\pi}{4}$. We use the x -axis which

$$\begin{aligned} \text{is through the vertex and parallel to the base of the cone} &\Rightarrow I_x = \int_0^{2\pi} \int_0^1 \int_r^1 (r^2 \sin^2 \theta + z^2) dz r dr d\theta \\ &= \int_0^{2\pi} \int_0^1 \left(r^3 \sin^2 \theta - r^4 \sin^2 \theta + \frac{r}{3} - \frac{r^4}{3} \right) dr d\theta = \int_0^{2\pi} \left(\frac{\sin^2 \theta}{20} + \frac{1}{10} \right) d\theta = \left[\frac{\theta}{40} - \frac{\sin 2\theta}{80} + \frac{\theta}{10} \right]_0^{2\pi} = \frac{\pi}{20} + \frac{\pi}{5} = \frac{\pi}{4} \end{aligned}$$

$$\begin{aligned} 74. \quad I_z &= \int_0^{2\pi} \int_0^a \int_{-\sqrt{a^2-r^2}}^{\sqrt{a^2-r^2}} r^3 dz dr d\theta = \int_0^{2\pi} \int_0^a 2r^3 \sqrt{a^2-r^2} dr d\theta = 2 \int_0^{2\pi} \left[\left(-\frac{r^2}{5} - \frac{2a^2}{15} \right) (a^2-r^2)^{3/2} \right]_0^a d\theta \\ &= 2 \int_0^{2\pi} \frac{2}{15} a^5 d\theta = \frac{8\pi a^5}{15} \end{aligned}$$

$$\begin{aligned} 75. \quad I_z &= \int_0^{2\pi} \int_0^a \int_{\frac{h}{a}r}^h (x^2 + y^2) dz r dr d\theta = \int_0^{2\pi} \int_0^a \int_{\frac{h}{a}r}^h r^3 dz dr d\theta = \int_0^{2\pi} \int_0^a \left(hr^3 - \frac{hr^4}{a} \right) dr d\theta \\ &= \int_0^{2\pi} h \left[\frac{r^4}{4} - \frac{r^5}{5a} \right]_0^a d\theta = \int_0^{2\pi} h \left(\frac{a^4}{4} - \frac{a^5}{5a} \right) d\theta = \frac{ha^4}{20} \int_0^{2\pi} d\theta = \frac{\pi ha^4}{10} \end{aligned}$$

$$\begin{aligned} 76. \quad (a) \quad M &= \int_0^{2\pi} \int_0^1 \int_0^{r^2} z dz r dr d\theta = \int_0^{2\pi} \int_0^1 \frac{1}{2} r^5 dr d\theta = \frac{1}{12} \int_0^{2\pi} d\theta = \frac{\pi}{6}; \\ M_{xy} &= \int_0^{2\pi} \int_0^1 \int_0^{r^2} z^2 dz r dr d\theta = \frac{1}{3} \int_0^{2\pi} \int_0^1 r^7 dr d\theta = \frac{1}{24} \int_0^{2\pi} d\theta = \frac{\pi}{12} \Rightarrow \bar{z} = \frac{1}{2}, \text{ and } \bar{x} = \bar{y} = 0, \text{ by} \\ \text{symmetry; } I_z &= \int_0^{2\pi} \int_0^1 \int_0^{r^2} zr^3 dz dr d\theta = \frac{1}{2} \int_0^{2\pi} \int_0^1 r^7 dr d\theta = \frac{1}{16} \int_0^{2\pi} d\theta = \frac{\pi}{8} \end{aligned}$$

$$\begin{aligned} (b) \quad M &= \int_0^{2\pi} \int_0^1 \int_0^{r^2} r^2 dz dr d\theta = \int_0^{2\pi} \int_0^1 r^4 dr d\theta = \frac{1}{5} \int_0^{2\pi} d\theta = \frac{2\pi}{5}; \\ M_{xy} &= \int_0^{2\pi} \int_0^1 \int_0^{r^2} zr^2 dz dr d\theta = \frac{1}{2} \int_0^{2\pi} \int_0^1 r^6 dr d\theta = \frac{1}{14} \int_0^{2\pi} d\theta = \frac{\pi}{7} \Rightarrow \bar{z} = \frac{5}{14}, \text{ and } \bar{x} = \bar{y} = 0, \text{ by} \\ \text{symmetry; } I_z &= \int_0^{2\pi} \int_0^1 \int_0^{r^2} r^4 dz dr d\theta = \int_0^{2\pi} \int_0^1 r^6 dr d\theta = \frac{1}{7} \int_0^{2\pi} d\theta = \frac{2\pi}{7} \end{aligned}$$

$$\begin{aligned} 77. \quad (a) \quad M &= \int_0^{2\pi} \int_0^1 \int_r^1 z dz r dr d\theta = \frac{1}{2} \int_0^{2\pi} \int_0^1 (r-r^3) dr d\theta = \frac{1}{8} \int_0^{2\pi} d\theta = \frac{\pi}{4}; \\ M_{xy} &= \int_0^{2\pi} \int_0^1 \int_r^1 z^2 dz r dr d\theta = \frac{1}{3} \int_0^{2\pi} \int_0^1 (r-r^4) dr d\theta = \frac{1}{10} \int_0^{2\pi} d\theta = \frac{\pi}{5} \Rightarrow \bar{z} = \frac{4}{5}, \text{ and } \bar{x} = \bar{y} = 0, \text{ by} \\ \text{symmetry; } I_z &= \int_0^{2\pi} \int_0^1 \int_r^1 zr^3 dz dr d\theta = \frac{1}{2} \int_0^{2\pi} \int_0^1 (r^3-r^5) dr d\theta = \frac{1}{24} \int_0^{2\pi} d\theta = \frac{\pi}{12} \end{aligned}$$

$$\begin{aligned} (b) \quad M &= \int_0^{2\pi} \int_0^1 \int_r^1 z^2 dz r dr d\theta = \frac{\pi}{5} \text{ from part (a); } M_{xy} = \int_0^{2\pi} \int_0^1 \int_r^1 z^3 dz r dr d\theta = \frac{1}{4} \int_0^{2\pi} \int_0^1 (r-r^5) dr d\theta \\ &= \frac{1}{12} \int_0^{2\pi} d\theta = \frac{\pi}{6} \Rightarrow \bar{z} = \frac{5}{6}, \text{ and } \bar{x} = \bar{y} = 0, \text{ by symmetry; } I_z = \int_0^{2\pi} \int_0^1 \int_r^1 z^2 r^3 dz dr d\theta \\ &= \frac{1}{3} \int_0^{2\pi} \int_0^1 (r^3-r^6) dr d\theta = \frac{1}{28} \int_0^{2\pi} d\theta = \frac{\pi}{14} \end{aligned}$$

$$\begin{aligned} 78. \quad (a) \quad M &= \int_0^{2\pi} \int_0^\pi \int_0^a \rho^4 \sin \phi d\rho d\phi d\theta = \frac{a^5}{5} \int_0^{2\pi} \int_0^\pi \sin \phi d\phi d\theta = \frac{2a^5}{5} \int_0^{2\pi} d\theta = \frac{4\pi a^5}{5}; \\ I_z &= \int_0^{2\pi} \int_0^\pi \int_0^a \rho^6 \sin^3 \phi d\rho d\phi d\theta = \frac{a^7}{7} \int_0^{2\pi} \int_0^\pi (1-\cos^2 \phi) \sin \phi d\phi d\theta = \frac{a^7}{7} \int_0^{2\pi} \left[-\cos \phi + \frac{\cos^3 \phi}{3} \right]_0^\pi d\theta \\ &= \frac{4a^7}{21} \int_0^{2\pi} d\theta = \frac{8a^7 \pi}{21} \end{aligned}$$

$$(b) \quad M = \int_0^{2\pi} \int_0^\pi \int_0^a \rho^3 \sin^2 \phi \, d\rho \, d\phi \, d\theta = \frac{a^4}{4} \int_0^{2\pi} \int_0^\pi \frac{(1-\cos 2\phi)}{2} \, d\phi \, d\theta = \frac{\pi a^4}{8} \int_0^{2\pi} d\theta = \frac{\pi^2 a^4}{4};$$

$$\begin{aligned} I_z &= \int_0^{2\pi} \int_0^\pi \int_0^a \rho^5 \sin^4 \phi \, d\rho \, d\phi \, d\theta = \frac{a^6}{6} \int_0^{2\pi} \int_0^\pi \sin^4 \phi \, d\phi \, d\theta \\ &= \frac{a^6}{6} \int_0^{2\pi} \left(\left[\frac{-\sin^3 \phi \cos \phi}{4} \right]_0^\pi + \frac{3}{4} \int_0^\pi \sin^2 \phi \, d\phi \right) d\theta = \frac{a^6}{8} \int_0^{2\pi} \left[\frac{\phi}{2} - \frac{\sin 2\phi}{4} \right]_0^\pi d\theta = \frac{\pi a^6}{16} \int_0^{2\pi} d\theta = \frac{a^6 \pi^2}{8} \end{aligned}$$

$$\begin{aligned} 79. \quad M &= \int_0^{2\pi} \int_0^a \int_0^{\frac{h}{a}\sqrt{a^2-r^2}} dz \, r \, dr \, d\theta = \int_0^{2\pi} \int_0^a \frac{h}{a} r \sqrt{a^2-r^2} \, dr \, d\theta = \frac{h}{a} \int_0^{2\pi} \left[-\frac{1}{3}(a^2-r^2)^{3/2} \right]_0^a d\theta = \frac{h}{a} \int_0^{2\pi} \frac{a^3}{3} d\theta \\ &= \frac{2ha^2\pi}{3}; \quad M_{xy} = \int_0^{2\pi} \int_0^a \int_0^{\frac{h}{a}\sqrt{a^2-r^2}} z \, dz \, r \, dr \, d\theta = \frac{h^2}{2a^2} \int_0^{2\pi} \int_0^a (a^2r-r^3) \, dr \, d\theta = \frac{h^2}{2a^2} \int_0^{2\pi} \left(\frac{a^4}{2} - \frac{a^4}{4} \right) d\theta = \frac{a^2 h^2 \pi}{4} \\ &\Rightarrow \bar{z} = \left(\frac{\pi a^2 h^2}{4} \right) \left(\frac{3}{2ha^2\pi} \right) = \frac{3}{8}h, \text{ and } \bar{x} = \bar{y} = 0, \text{ by symmetry} \end{aligned}$$

80. Let the base radius of the cone be a and the height h , and place the cone's axis of symmetry along the z -axis

with the vertex at the origin. Then $M = \frac{\pi a^2 h}{3}$ and $M_{xy} = \int_0^{2\pi} \int_0^a \int_{\left(\frac{h}{a}\right)r}^h z \, dz \, r \, dr \, d\theta$

$$= \frac{1}{2} \int_0^{2\pi} \int_0^a \left(h^2 r - \frac{h^2}{a^2} r^3 \right) dr \, d\theta = \frac{h^2}{2} \int_0^{2\pi} \left[\frac{r^2}{2} - \frac{r^4}{4a^2} \right]_0^a d\theta = \frac{h^2}{2} \int_0^{2\pi} \left(\frac{a^2}{2} - \frac{a^4}{4} \right) d\theta = \frac{h^2 a^2}{8} \int_0^{2\pi} d\theta = \frac{h^2 a^2 \pi}{4}$$

$\Rightarrow \bar{z} = \frac{M_{xy}}{M} = \left(\frac{h^2 a^2 \pi}{4} \right) \left(\frac{3}{\pi a^2 h} \right) = \frac{3}{4}h$, and $\bar{x} = \bar{y} = 0$, by symmetry \Rightarrow the centroid is one fourth of the way from the base to the vertex

81. The density distribution function is linear so it has the form $\delta(\rho) = k\rho + C$, where ρ is the distance from the center of the planet. Now, $\delta(R) = 0 \Rightarrow kR + C = 0$, and $\delta(\rho) = k\rho - kR$. It remains to determine the constant

$$\begin{aligned} k: \quad M &= \int_0^{2\pi} \int_0^\pi \int_0^R (k\rho - kR) \rho^2 \sin \phi \, d\rho \, d\phi \, d\theta = \int_0^{2\pi} \int_0^\pi \left[k \frac{\rho^4}{4} - kR \frac{\rho^3}{3} \right]_0^R \sin \phi \, d\phi \, d\theta \\ &= \int_0^{2\pi} \int_0^\pi k \left(\frac{R^4}{4} - \frac{R^4}{3} \right) \sin \phi \, d\phi \, d\theta = \int_0^{2\pi} \left(-\frac{k}{12} R^4 [-\cos \phi]_0^\pi \right) d\theta = \int_0^{2\pi} \left(-\frac{k}{6} R^4 \right) d\theta = -\frac{k\pi R^4}{3} \Rightarrow k = -\frac{3M}{\pi R^4} \\ &\Rightarrow \delta(\rho) = -\frac{3M}{\pi R^4} \rho + \frac{3M}{\pi R^4} R. \text{ At the center of the planet } \rho = 0 \Rightarrow \delta(0) = \left(\frac{3M}{\pi R^4} \right) R = \frac{3M}{\pi R^3}. \end{aligned}$$

82. The mass of the planet's atmosphere to an altitude h above the surface of the planet is the triple integral

$$\begin{aligned} M(h) &= \int_0^{2\pi} \int_0^\pi \int_R^h \mu_0 e^{-c(\rho-R)} \rho^2 \sin \phi \, d\rho \, d\phi \, d\theta = \int_R^h \int_0^{2\pi} \int_0^\pi \mu_0 e^{-c(\rho-R)} \rho^2 \sin \phi \, d\phi \, d\theta \, d\rho \\ &= \int_R^h \int_0^{2\pi} \left[\mu_0 e^{-c(\rho-R)} \rho^2 (-\cos \phi) \right]_0^\pi d\theta \, d\rho = 2 \int_R^h \int_0^{2\pi} \mu_0 e^{cR} e^{-c\rho} \rho^2 \, d\theta \, d\rho = 4\pi \mu_0 e^{cR} \int_R^h e^{-c\rho} \rho^2 \, d\rho \\ &= 4\pi \mu_0 e^{cR} \left[-\frac{\rho^2 e^{-c\rho}}{c} - \frac{2\rho e^{-c\rho}}{c^2} - \frac{2e^{-c\rho}}{c^3} \right]_R^h \text{ (by parts)} \\ &= 4\pi \mu_0 e^{cR} \left(-\frac{h^2 e^{-ch}}{c} - \frac{2he^{-ch}}{c^2} - \frac{2e^{-ch}}{c^3} + \frac{R^2 e^{-cR}}{c} + \frac{2Re^{-cR}}{c^2} + \frac{2e^{-cR}}{c^3} \right). \end{aligned}$$

The mass of the planet's atmosphere is therefore $M = \lim_{h \rightarrow \infty} M(h) = 4\pi \mu_0 \left(\frac{R^2}{c} + \frac{2R}{c^2} + \frac{2}{c^3} \right)$.

83. (a) A plane perpendicular to the x -axis has the form $x = a$ in rectangular coordinates $\Rightarrow r \cos \theta = a$
 $\Rightarrow r = \frac{a}{\cos \theta} \Rightarrow r = a \sec \theta$, in cylindrical coordinates.
 (b) A plane perpendicular to the y -axis has the form $y = b$ in rectangular coordinates $\Rightarrow r \sin \theta = b$
 $\Rightarrow r = \frac{b}{\sin \theta} \Rightarrow r = b \csc \theta$, in cylindrical coordinates.
84. $ax + by = c \Rightarrow a(r \cos \theta) + b(r \sin \theta) = c \Rightarrow r(a \cos \theta + b \sin \theta) = c \Rightarrow r = \frac{c}{a \cos \theta + b \sin \theta}$.

85. The equation $r = f(z)$ implies that the point $(r, \theta, z) = (f(z), \theta, z)$ will lie on the surface for all θ . In particular $(f(z), \theta + \pi, z)$ lies on the surface whenever $(f(z), \theta, z)$ does \Rightarrow the surface is symmetric with respect to the z -axis.

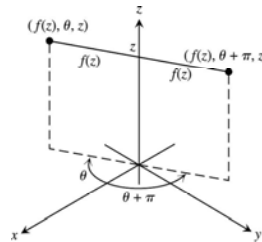

86. The equation $\rho = f(\phi)$ implies that the point $(\rho, \phi, \theta) = (f(\phi), \phi, \theta)$ lies on the surface for all θ . In particular, if $(f(\phi), \phi, \theta)$ lies on the surface, then $(f(\phi), \phi, \theta + \pi)$ lies on the surface, so the surface is symmetric with respect to the z -axis.

15.8 SUBSTITUTIONS IN MULTIPLE INTEGRALS

1. (a) $x - y = u$ and $2x + y = v \Rightarrow 3x = u + v$ and $y = x - u \Rightarrow x = \frac{1}{3}(u + v)$ and $y = \frac{1}{3}(-2u + v)$;

$$\frac{\partial(x, y)}{\partial(u, v)} = \begin{vmatrix} \frac{1}{3} & \frac{1}{3} \\ -\frac{2}{3} & \frac{1}{3} \end{vmatrix} = \frac{1}{9} + \frac{2}{9} = \frac{1}{3}$$

- (b) The line segment $y = x$ from $(0, 0)$ to $(1, 1)$ is $x - y = 0 \Rightarrow u = 0$; the line segment $y = -2x$ from $(0, 0)$ to $(1, -2)$ is $2x + y = 0 \Rightarrow v = 0$; the line segment $x = 1$ from $(1, 1)$ to $(1, -2)$ is $(x - y) + (2x + y) = 3 \Rightarrow u + v = 3$. The transformed region is sketched at the right.

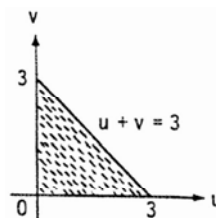

2. (a) $x + 2y = u$ and $x - y = v \Rightarrow 3y = u - v$ and $x = v + y \Rightarrow y = \frac{1}{3}(u - v)$ and $x = \frac{1}{3}(u + 2v)$;

$$\frac{\partial(x, y)}{\partial(u, v)} = \begin{vmatrix} \frac{1}{3} & \frac{2}{3} \\ \frac{1}{3} & -\frac{1}{3} \end{vmatrix} = -\frac{1}{9} - \frac{2}{9} = -\frac{1}{3}$$

- (b) The triangular region in the xy -plane has vertices $(0, 0)$, $(2, 0)$, and $(\frac{2}{3}, \frac{2}{3})$. The line segment $y = x$ from $(0, 0)$ to $(\frac{2}{3}, \frac{2}{3})$ is $x - y = 0 \Rightarrow v = 0$; the line segment $y = 0$ from $(0, 0)$ to $(2, 0) \Rightarrow u = v$; the line segment $x + 2y = 2$ from $(\frac{2}{3}, \frac{2}{3})$ to $(2, 0) \Rightarrow u = 2$. The transformed region is sketched at the right.

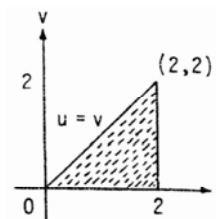

3. (a) $3x + 2y = u$ and $x + 4y = v \Rightarrow -5x = -2u + v$ and $y = \frac{1}{2}(u - 3x) \Rightarrow x = \frac{1}{5}(2u - v)$ and $y = \frac{1}{10}(3v - u)$;

$$\frac{\partial(x, y)}{\partial(u, v)} = \begin{vmatrix} \frac{2}{5} & -\frac{1}{5} \\ -\frac{1}{10} & \frac{3}{10} \end{vmatrix} = \frac{6}{50} - \frac{1}{50} = \frac{1}{10}$$

- (b) The x -axis $y = 0 \Rightarrow u = 3v$;
 the y -axis $x = 0 \Rightarrow v = 2u$;
 the line $x + y = 1 \Rightarrow \frac{1}{5}(2u - v) + \frac{1}{10}(3v - u) = 1$
 $\Rightarrow 2(2u - v) + (3v - u) = 10 \Rightarrow 3u + v = 10$. The transformed region is sketched at the right.

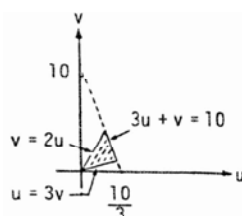

4. (a) $2x - 3y = u$ and $-x + y = v \Rightarrow -x = u + 3v$ and $y = v + x \Rightarrow x = -u - 3v$ and $y = -u - 2v$;

$$\frac{\partial(x, y)}{\partial(u, v)} = \begin{vmatrix} -1 & -3 \\ -1 & -2 \end{vmatrix} = 2 - 3 = -1$$

- (b) The line $x = -3 \Rightarrow -u - 3v = -3$ or $u + 3v = 3$;
 $x = 0 \Rightarrow u + 3v = 0$; $y = x \Rightarrow v = 0$; $y = x + 1$
 $\Rightarrow v = 1$. The transformed region is the parallelogram sketched at the right.

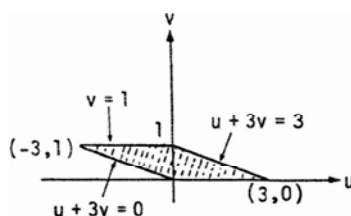

5. $\int_0^4 \int_{y/2}^{(y/2)+1} \left(x - \frac{y}{2}\right) dx dy = \int_0^4 \left[\frac{x^2}{2} - \frac{xy}{2} \right]_{y/2}^{(y/2)+1} dy = \frac{1}{2} \int_0^4 \left[\left(\frac{y}{2} + 1\right)^2 - \left(\frac{y}{2}\right)^2 - \left(\frac{y}{2} + 1\right)y + \left(\frac{y}{2}\right)y \right] dy$
 $= \frac{1}{2} \int_0^4 (y + 1 - y) dy = \frac{1}{2} \int_0^4 dy = \frac{1}{2}(4) = 2$

6. $\iint_R (2x^2 - xy - y^2) dx dy = \iint_R (x - y)(2x + y) dx dy$
 $= \iint_G uv \left| \frac{\partial(x, y)}{\partial(u, v)} \right| du dv = \frac{1}{3} \iint_G uv du dv$; We find the

boundaries of G from the boundaries of R , shown in the accompanying figure:

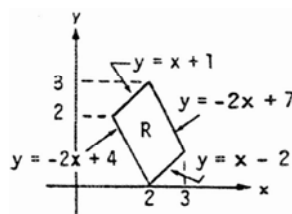

xy -equations for the boundary of R	Corresponding uv -equations for the boundary of G	Simplified uv -equations
$y = -2x + 4$	$\frac{1}{3}(-2u + v) = -\frac{2}{3}(u + v) + 4$	$v = 4$
$y = -2x + 7$	$\frac{1}{3}(-2u + v) = -\frac{2}{3}(u + v) + 7$	$v = 7$
$y = x - 2$	$\frac{1}{3}(-2u + v) = \frac{1}{3}(u + v) - 2$	$u = 2$
$y = x + 1$	$\frac{1}{3}(-2u + v) = \frac{1}{3}(u + v) + 1$	$u = -1$

$$\Rightarrow \frac{1}{3} \iint_G uv du dv = \frac{1}{3} \int_{-1}^2 \int_4^7 uv dv du = \frac{1}{3} \int_{-1}^2 u \left[\frac{v^2}{2} \right]_4^7 du = \frac{11}{2} \int_{-1}^2 u du = \left(\frac{11}{2}\right) \left[\frac{u^2}{2} \right]_{-1}^2 = \left(\frac{11}{4}\right)(4 - 1) = \frac{33}{4}$$

$$\begin{aligned}
 7. \quad & \iint_R (3x^2 + 14xy + 8y^2) \, dx \, dy \\
 &= \iint_R (3x + 2y)(x + 4y) \, dx \, dy \\
 &= \iint_G uv \left| \frac{\partial(x,y)}{\partial(u,v)} \right| \, du \, dv = \frac{1}{10} \iint_G uv \, du \, dv;
 \end{aligned}$$

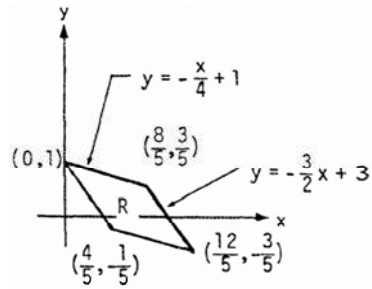

We find the boundaries of G from the boundaries of R , shown in the accompanying figure:

xy -equations for the boundary of R	Corresponding uv -equations for the boundary of G	Simplified uv -equations
$y = -\frac{3}{2}x + 1$	$\frac{1}{10}(3v - u) = -\frac{3}{10}(2u - v) + 1$	$u = 2$
$y = -\frac{3}{2}x + 3$	$\frac{1}{10}(3v - u) = -\frac{3}{10}(2u - v) + 3$	$u = 6$
$y = -\frac{1}{4}x$	$\frac{1}{10}(3v - u) = -\frac{1}{20}(2u - v)$	$v = 0$
$y = -\frac{1}{4}x + 1$	$\frac{1}{10}(3v - u) = -\frac{1}{20}(2u - v) + 1$	$v = 4$

$$\Rightarrow \frac{1}{10} \iint_G uv \, du \, dv = \frac{1}{10} \int_2^6 \int_0^4 uv \, dv \, du = \frac{1}{10} \int_2^6 u \left[\frac{v^2}{2} \right]_0^4 \, du = \frac{4}{5} \int_2^6 u \, du = \left(\frac{4}{5}\right) \left[\frac{u^2}{2} \right]_2^6 = \left(\frac{4}{5}\right)(18 - 2) = \frac{64}{5}$$

$$\begin{aligned}
 8. \quad & \iint_R 2(x - y) \, dx \, dy = \iint_G (-2v) \left| \frac{\partial(x,y)}{\partial(u,v)} \right| \, du \, dv = \iint_G (-2v) \, du \, dv; \text{ the region } G \text{ is sketched in Exercise 4} \\
 & \Rightarrow \iint_G (-2v) \, du \, dv = \int_0^1 \int_{-3v}^{-3v+3} (-2v) \, du \, dv = \int_0^1 (-2v)(3 - 3v + 3v) \, dv = \int_0^1 (-6v) \, dv = \left[-3v^2 \right]_0^1 = -3
 \end{aligned}$$

$$9. \quad x = \frac{u}{v} \text{ and } y = uv \Rightarrow \frac{y}{x} = v^2 \text{ and } xy = u^2; \frac{\partial(x,y)}{\partial(u,v)} = J(u,v) = \begin{vmatrix} v^{-1} & -uv^{-2} \\ v & u \end{vmatrix} = v^{-1}u + v^{-1}u = \frac{2u}{v};$$

$y = x \Rightarrow uv = \frac{u}{v} \Rightarrow v = 1$, and $y = 4x \Rightarrow v = 2$; $xy = 1 \Rightarrow u = 1$, and $xy = 9 \Rightarrow u = 3$; thus

$$\begin{aligned}
 \iint_R \left(\sqrt{\frac{y}{x}} + \sqrt{xy} \right) \, dx \, dy &= \int_1^3 \int_1^2 (v + u) \left(\frac{2u}{v} \right) \, dv \, du = \int_1^3 \int_1^2 \left(2u + \frac{2u^2}{v} \right) \, dv \, du = \int_1^3 \left[2uv + 2u^2 \ln v \right]_1^2 \, du \\
 &= \int_1^3 \left(2u + 2u^2 \ln 2 \right) \, du = \left[u^2 + \frac{2}{3}u^2 \ln 2 \right]_1^3 = 8 + \frac{2}{3}(26)(\ln 2) = 8 + \frac{52}{3}(\ln 2)
 \end{aligned}$$

$$10. \quad (a) \quad \frac{\partial(x,y)}{\partial(u,v)} = J(u,v) = \begin{vmatrix} 1 & 0 \\ v & u \end{vmatrix} = u, \text{ and the region } G \text{ is sketched at the right}$$

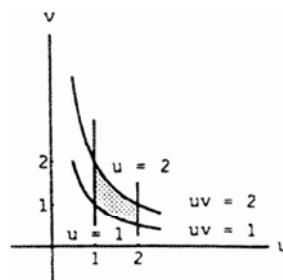

(b) $x = 1 \Rightarrow u = 1$, and $x = 2 \Rightarrow u = 2$; $y = 1 \Rightarrow uv = 1 \Rightarrow v = \frac{1}{u}$, and $y = 2 \Rightarrow uv = 2 \Rightarrow v = \frac{2}{u}$; thus,

$$\begin{aligned} \int_1^2 \int_1^2 \frac{y}{x} dy dx &= \int_1^2 \int_{1/u}^{2/u} \left(\frac{uv}{u}\right) u dv du = \int_1^2 \int_{1/u}^{2/u} uv dv du = \int_1^2 u \left[\frac{v^2}{2} \right]_{1/u}^{2/u} du = \int_1^2 u \left(\frac{2}{u^2} - \frac{1}{2u^2} \right) du \\ &= \frac{3}{2} \int_1^2 u \left(\frac{1}{u^2} \right) du = \frac{3}{2} [\ln u]_1^2 = \frac{3}{2} \ln 2; \quad \int_1^2 \int_1^2 \frac{y}{x} dy dx = \int_1^2 \left[\frac{1}{x} \cdot \frac{y^2}{2} \right]_1^2 dx = \frac{3}{2} \int_1^2 \frac{dx}{x} = \frac{3}{2} [\ln x]_1^2 = \frac{3}{2} \ln 2 \end{aligned}$$

11. $x = ar \cos \theta$ and $y = ar \sin \theta \Rightarrow \frac{\partial(x, y)}{\partial(r, \theta)} = J(r, \theta) = \begin{vmatrix} a \cos \theta & -ar \sin \theta \\ b \sin \theta & br \cos \theta \end{vmatrix} = abr \cos^2 \theta + abr \sin^2 \theta = abr$;

$$\begin{aligned} I_0 &= \iint_R (x^2 + y^2) dA = \int_0^{2\pi} \int_0^1 r^2 (a^2 \cos^2 \theta + b^2 \sin^2 \theta) |J(r, \theta)| dr d\theta \\ &= \int_0^{2\pi} \int_0^1 abr^3 (a^2 \cos^2 \theta + b^2 \sin^2 \theta) dr d\theta = \frac{ab}{4} \left(\int_0^{2\pi} a^2 \cos^2 \theta + b^2 \sin^2 \theta \right) d\theta \\ &= \frac{ab}{4} \left[\frac{a^2 \theta}{2} + \frac{a^2 \sin 2\theta}{4} + \frac{b^2 \theta}{2} - \frac{b^2 \sin 2\theta}{4} \right]_0^{2\pi} = \frac{ab\pi(a^2 + b^2)}{4} \end{aligned}$$

12. $\frac{\partial(x, y)}{\partial(u, v)} = J(u, v) = \begin{vmatrix} a & 0 \\ 0 & b \end{vmatrix} = ab$; $A = \iint_R dy dx = \iint_G ab du dv = \int_{-1}^1 \int_{-\sqrt{1-u^2}}^{\sqrt{1-u^2}} ab dv du = 2ab \int_{-1}^1 \sqrt{1-u^2} du$

$$= 2ab \left[\frac{u}{2} \sqrt{1-u^2} + \frac{1}{2} \sin^{-1} u \right]_{-1}^1 = ab \left[\sin^{-1} 1 - \sin^{-1}(-1) \right] = ab \left[\frac{\pi}{2} - \left(-\frac{\pi}{2}\right) \right] = ab\pi$$

13. The region of integration R in the xy -plane is sketched in the figure at the right. The boundaries of the image G are obtained as follows, with G sketched at the right:

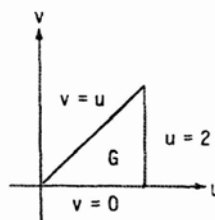
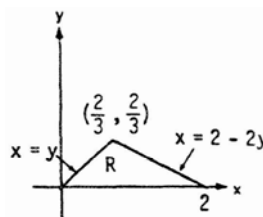

xy -equations for the boundary of R	Corresponding uv -equations for the boundary of G	Simplified uv -equations
$x = y$	$\frac{1}{3}(u + 2v) = \frac{1}{3}(u - v)$	$v = 0$
$x = 2 - 2y$	$\frac{1}{3}(u + 2v) = 2 - \frac{2}{3}(u - v)$	$u = 2$
$y = 0$	$0 = \frac{1}{3}(u - v)$	$v = u$

Also, from Exercise 2, $\frac{\partial(x,y)}{\partial(u,v)} = J(u,v) = -\frac{1}{3} \Rightarrow \int_0^{2/3} \int_y^{2-2y} (x+2y)e^{(y-x)} dx dy = \int_0^2 \int_0^u ue^{-v} \left| -\frac{1}{3} \right| dv du$
 $= \frac{1}{3} \int_0^2 u \left[-e^{-v} \right]_0^u du = \frac{1}{3} \int_0^2 u(1-e^{-u}) du = \frac{1}{3} \left[u(u+e^{-u}) - \frac{u^2}{2} + e^{-u} \right]_0^2 = \frac{1}{3} [2(2+e^{-2}) - 2 + e^{-2} - 1]$
 $= \frac{1}{3}(3e^{-2} + 1) \approx 0.4687$

14. $x = u + \frac{v}{2}$ and $y = v \Rightarrow 2x - y = (2u + v) - v = 2u$

and $\frac{\partial(x,y)}{\partial(u,v)} = J(u,v) = \begin{vmatrix} 1 & \frac{1}{2} \\ 0 & 1 \end{vmatrix} = 1$; next,

$u = x - \frac{v}{2} = x - \frac{y}{2}$ and $v = y$, so the boundaries of the region of integration R in the xy -plane are transformed to the boundaries of G :

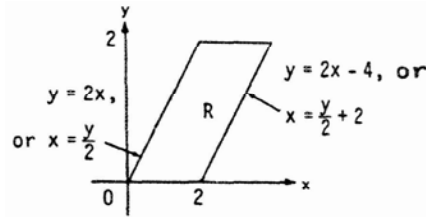

xy -equations for the boundary of R	Corresponding uv -equations for the boundary of G	Simplified uv -equations
$x = \frac{y}{2}$	$u + \frac{v}{2} = \frac{v}{2}$	$u = 0$
$x = \frac{y}{2} + 2$	$u + \frac{v}{2} = \frac{v}{2} + 2$	$u = 2$
$y = 0$	$v = 0$	$v = 0$
$y = 2$	$v = 2$	$v = 2$

$\Rightarrow \int_0^2 \int_{y/2}^{(y/2)+2} y^3(2x-y)e^{(2x-y)^2} dx dy = \int_0^2 \int_0^2 v^3(2u)e^{4u^2} du dv = \int_0^2 v^3 \left[\frac{1}{4} e^{4u^2} \right]_0^2 dv = \frac{1}{4} \int_0^2 v^3 (e^{16} - 1) dv$
 $= \frac{1}{4} (e^{16} - 1) \left[\frac{v^4}{4} \right]_0^2 = e^{16} - 1$

15. $x = \frac{u}{v}$ and $y = uv \Rightarrow \frac{y}{x} = v^2$ and $xy = u^2$; $\frac{\partial(x,y)}{\partial(u,v)} = J(u,v) = \begin{vmatrix} v^{-1} & -uv^{-2} \\ v & u \end{vmatrix} = v^{-1}u + v^{-1}u = \frac{2u}{v}$;

$y = x \Rightarrow uv = \frac{u}{v} \Rightarrow v = 1$, and $y = 4x \Rightarrow v = 2$; $xy = 1 \Rightarrow u = 1$, and $xy = 4 \Rightarrow u = 2$; thus

$\int_1^2 \int_{1/y}^y (x^2 + y^2) dx dy + \int_2^4 \int_{y/4}^{4/y} (x^2 + y^2) dx dy = \int_1^2 \int_1^2 \left(\frac{u^2}{v^2} + u^2 v^2 \right) \left(\frac{2u}{v} \right) du dv = \int_1^2 \int_1^2 \left(\frac{2u^3}{v^3} + 2u^3 v \right) du dv$
 $= \int_1^2 \left[\frac{u^4}{2v^3} + \frac{1}{2} u^4 v \right]_1^2 dv = \int_1^2 \left(\frac{15}{2v^3} + \frac{15v}{2} \right) dv = \left[-\frac{15}{4v^2} + \frac{15v^2}{4} \right]_1^2 = \frac{225}{16}$

16. $x = u^2 - v^2$ and $y = 2uv$; $\frac{\partial(x,y)}{\partial(u,v)} = J(u,v) = \begin{vmatrix} 2u & -2v \\ 2v & 2u \end{vmatrix} = 4u^2 + 4v^2 = 4(u^2 + v^2)$;

$y = 2\sqrt{1-x} \Rightarrow y^2 = 4(1-x) \Rightarrow (2uv)^2 = 4(1-(u^2 - v^2)) \Rightarrow u = \pm 1$; $y = 0 \Rightarrow 2uv = 0 \Rightarrow u = 0$ or $v = 0$;

$x = 0 \Rightarrow u^2 - v^2 = 0 \Rightarrow u = v$ or $u = -v$; This gives us four triangular regions, but only the one in the quadrant where both u, v are positive maps into the region R in the xy -plane.

$$\begin{aligned} \int_0^1 \int_0^{2\sqrt{1-x}} \sqrt{x^2 + y^2} dx dy &= \int_0^1 \int_0^u \sqrt{(u^2 - v^2)^2 + (2uv)^2} \cdot 4(u^2 + v^2) dv du = 4 \int_0^1 \int_0^u (u^2 + v^2)^2 dv du \\ &= 4 \int_1^2 \left[u^4 v + \frac{2}{3} u^2 v^3 + \frac{1}{5} v^5 \right]_0^u du = \frac{112}{15} \int_1^2 u^5 du = \frac{112}{15} \left[\frac{1}{6} u^6 \right]_1^2 = \frac{56}{45} \end{aligned}$$

$$17. \text{ (a) } x = u \cos v \text{ and } y = u \sin v \Rightarrow \frac{\partial(x, y)}{\partial(u, v)} = \begin{vmatrix} \cos v & -u \sin v \\ \sin v & u \cos v \end{vmatrix} = u \cos^2 v + u \sin^2 v = u$$

$$\text{ (b) } x = u \sin v \text{ and } y = u \cos v \Rightarrow \frac{\partial(x, y)}{\partial(u, v)} = \begin{vmatrix} \sin v & u \cos v \\ \cos v & -u \sin v \end{vmatrix} = -u \sin^2 v - u \cos^2 v = -u$$

$$18. \text{ (a) } x = u \cos v, y = u \sin v, z = w \Rightarrow \frac{\partial(x, y, z)}{\partial(u, v, w)} = \begin{vmatrix} \cos v & -u \sin v & 0 \\ \sin v & u \cos v & 0 \\ 0 & 0 & 1 \end{vmatrix} = u \cos^2 v + u \sin^2 v = u$$

$$\text{ (b) } x = 2u - 1, y = 3v - 4, z = \frac{1}{2}(w - 4) \Rightarrow \frac{\partial(x, y, z)}{\partial(u, v, w)} = \begin{vmatrix} 2 & 0 & 0 \\ 0 & 3 & 0 \\ 0 & 0 & \frac{1}{2} \end{vmatrix} = (2)(3)\left(\frac{1}{2}\right) = 3$$

$$\begin{aligned} 19. & \begin{vmatrix} \sin \phi \cos \theta & \rho \cos \phi \cos \theta & -\rho \sin \phi \sin \theta \\ \sin \phi \sin \theta & \rho \cos \phi \sin \theta & \rho \sin \phi \cos \theta \\ \cos \phi & -\rho \sin \phi & 0 \end{vmatrix} \\ &= (\cos \phi) \begin{vmatrix} \rho \cos \phi \cos \theta & -\rho \sin \phi \sin \theta \\ \rho \cos \phi \sin \theta & \rho \sin \phi \cos \theta \end{vmatrix} + (\rho \sin \phi) \begin{vmatrix} \sin \phi \cos \theta & -\rho \sin \phi \sin \theta \\ \sin \phi \sin \theta & \rho \sin \phi \cos \theta \end{vmatrix} \\ &= (\rho^2 \cos \phi) (\sin \phi \cos \phi \cos^2 \theta + \sin \phi \cos \phi \sin^2 \theta) + (\rho^2 \sin \phi) (\sin^2 \phi \cos^2 \theta + \sin^2 \phi \sin^2 \theta) \\ &= \rho^2 \sin \phi \cos^2 \phi + \rho^2 \sin^3 \phi = (\rho^2 \sin \phi) (\cos^2 \phi + \sin^2 \phi) = \rho^2 \sin \phi \end{aligned}$$

20. Let $u = g(x) \Rightarrow J(x) = \frac{du}{dx} = g'(x) \Rightarrow \int_a^b f(u) du = \int_{g(a)}^{g(b)} f(g(x)) g'(x) dx$ in accordance with Theorem 7 in Section 5.6. Note that $g'(x)$ represents the Jacobian of the transformation $u = g(x)$ or $x = g^{-1}(u)$.

$$\begin{aligned} 21. & \int_0^3 \int_0^4 \int_{y/2}^{1+(y/2)} \left(\frac{2x-y}{2} + \frac{z}{3} \right) dx dy dz = \int_0^3 \int_0^4 \left[\frac{x^2}{2} - \frac{xy}{2} + \frac{xz}{3} \right]_{y/2}^{1+(y/2)} dy dz = \int_0^3 \int_0^4 \left[\frac{1}{2}(y+1) - \frac{y}{2} + \frac{z}{3} \right] dy dz \\ &= \int_0^3 \left[\frac{(y+1)^2}{4} - \frac{y^2}{4} + \frac{yz}{3} \right]_0^4 dz = \int_0^3 \left(\frac{9}{4} + \frac{4z}{3} - \frac{1}{4} \right) dz = \int_0^3 \left(2 + \frac{4z}{3} \right) dz = \left[2z + \frac{2z^2}{3} \right]_0^3 = 12 \end{aligned}$$

$$22. J(u, v, w) = \begin{vmatrix} a & 0 & 0 \\ 0 & b & 0 \\ 0 & 0 & c \end{vmatrix} = abc; \text{ the transformation takes the ellipsoid region } \frac{x^2}{a^2} + \frac{y^2}{b^2} + \frac{z^2}{c^2} \leq 1 \text{ in } xyz\text{-space into}$$

the spherical region $u^2 + v^2 + w^2 \leq 1$ in uvw -space (which has volume $V = \frac{4}{3}\pi$) $\Rightarrow V = \iiint_R dx dy dz$

$$= \iiint_G abc du dv dw = \frac{4\pi abc}{3}$$

$$\begin{aligned}
 23. \quad J(u, v, w) &= \begin{vmatrix} a & 0 & 0 \\ 0 & b & 0 \\ 0 & 0 & c \end{vmatrix} = abc; \text{ for } R \text{ and } G \text{ as in Exercise 22, } \iiint_R |xyz| \, dx \, dy \, dz = \iiint_G a^2 b^2 c^2 uvw \, dw \, dv \, du \\
 &= 8a^2 b^2 c^2 \int_0^{\pi/2} \int_0^{\pi/2} \int_0^1 (\rho \sin \phi \cos \theta)(\rho \sin \phi \sin \theta)(\rho \cos \phi) (\rho^2 \sin \phi) \, d\rho \, d\phi \, d\theta \\
 &= \frac{4a^2 b^2 c^2}{3} \int_0^{\pi/2} \int_0^{\pi/2} \sin \theta \cos \theta \sin^3 \phi \cos \phi \, d\phi \, d\theta = \frac{a^2 b^2 c^2}{3} \int_0^{\pi/2} \sin \theta \cos \theta \, d\theta = \frac{a^2 b^2 c^2}{6}
 \end{aligned}$$

$$\begin{aligned}
 24. \quad u = x, v = xy, \text{ and } w = 3z \Rightarrow x = u, y = \frac{v}{u}, \text{ and } z = \frac{1}{3}w \Rightarrow J(u, v, w) &= \begin{vmatrix} 1 & 0 & 0 \\ -\frac{v}{u^2} & \frac{1}{u} & 0 \\ 0 & 0 & \frac{1}{3} \end{vmatrix} = \frac{1}{3u}; \\
 \iiint_D (x^2 y + 3xyz) \, dx \, dy \, dz &= \iiint_G \left[u^2 \left(\frac{v}{u} \right) + 3u \left(\frac{v}{u} \right) \left(\frac{w}{3} \right) \right] |J(u, v, w)| \, du \, dv \, dw = \frac{1}{3} \int_0^3 \int_0^2 \int_1^2 \left(v + \frac{vw}{u} \right) \, du \, dv \, dw \\
 &= \frac{1}{3} \int_0^3 \int_0^2 (v + vw \ln 2) \, dv \, dw = \frac{1}{3} \int_0^3 (1 + w \ln 2) \left[\frac{v^2}{2} \right]_0^2 \, dw = \frac{2}{3} \int_0^3 (1 + w \ln 2) \, dw = \frac{2}{3} \left[w + \frac{w^2}{2} \ln 2 \right]_0^3 \\
 &= \frac{2}{3} \left(3 + \frac{9}{2} \ln 2 \right) = 2 + 3 \ln 2 = 2 + \ln 8
 \end{aligned}$$

25. The first moment about the xy -coordinate plane for the semi-ellipsoid, $\frac{x^2}{a^2} + \frac{y^2}{b^2} + \frac{z^2}{c^2} = 1$ using the transformation in Exercise 23 is, $M_{xy} = \iiint_D z \, dz \, dy \, dx = \iiint_G cw |J(u, v, w)| \, du \, dv \, dw$

$$= abc^2 \iiint_G w \, du \, dv \, dw = (abc^2) \cdot (M_{xy} \text{ of the hemisphere } x^2 + y^2 + z^2 = 1, z \geq 0) = \frac{abc^2 \pi}{4};$$

the mass of the semi-ellipsoid is $\frac{2abc\pi}{3} \Rightarrow \bar{z} = \left(\frac{abc^2 \pi}{4} \right) \left(\frac{3}{2abc\pi} \right) = \frac{3}{8}c$

26. A solid of revolution is symmetric about the axis of revolution, therefore, the height of the solid is solely a function of r . That is, $y = f(x) = f(r)$. Using cylindrical coordinates with $x = r \cos \theta$, $y = y$ and $z = r \sin \theta$, we have $V = \iiint_G r \, dy \, d\theta \, dr = \int_a^b \int_0^{2\pi} \int_0^{f(r)} r \, dy \, d\theta \, dr = \int_a^b \int_0^{2\pi} [r y]_0^{f(r)} \, d\theta \, dr = \int_a^b \int_0^{2\pi} r f(r) \, d\theta \, dr$

$$= \int_a^b [r\theta f(r)]_0^{2\pi} \, dr = \int_a^b 2\pi r f(r) \, dr.$$

In the last integral, r is a dummy or stand-in variable and as such it can be replaced by any variable name. Choosing x instead of r we have $V = \int_a^b 2\pi x f(x) \, dx$, which is the same result obtained using the shell method.

27. The region R is shaded in the graph below.

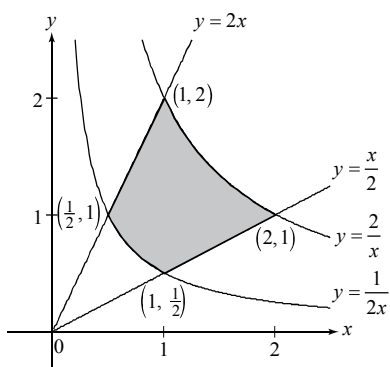

Solving explicitly for the transformation that gives x and y in terms of u and v yields a complicated expression for $\frac{\partial(x, y)}{\partial(u, v)}$. However, its reciprocal, $\frac{\partial(u, v)}{\partial(x, y)}$ is relatively easy to compute.

Since $u(x, y) = xy$ and $v(x, y) = y/x$, $J(x, y) = \begin{vmatrix} y & x \\ -\frac{y}{x^2} & \frac{1}{x} \end{vmatrix} = 2\frac{y}{x} = 2v$. Thus $J(u, v) = 1/2v$. In the uv -plane

the region corresponding to R is $G: \frac{1}{2} \leq u \leq 2, \frac{1}{2} \leq v \leq 2$. Thus v is positive and $|J(u, v)| = 1/2v$.

$$\iint_R dA = \int_{1/2}^2 \int_{1/2}^2 \frac{1}{2v} du dv = \int_{1/2}^2 \left(\frac{\ln u}{2} \right)_{1/2}^2 dv = \int_{1/2}^2 \ln 2 dv = \frac{3}{2} \ln 2$$

28. Under the given transformation, $y^2 = uv$, so

$$\iint_R y^2 dA = \int_{1/2}^2 \int_{1/2}^2 \frac{uv}{2v} du dv = \int_{1/2}^2 \left(\frac{u^2}{4} \right)_{1/2}^2 dv = \int_{1/2}^2 \frac{15}{16} dv = \frac{45}{32}$$

CHAPTER 15 PRACTICE EXERCISES

$$\begin{aligned}
 1. \int_1^{10} \int_0^{1/y} ye^{xy} dx dy &= \int_1^{10} [e^{xy}]_0^{1/y} dy \\
 &= \int_1^{10} (e-1) dy = 9e-9
 \end{aligned}$$

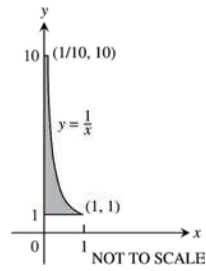

$$\begin{aligned}
 2. \int_0^1 \int_0^{x^3} e^{y/x} dy dx &= \int_0^1 x [e^{y/x}]_0^{x^3} dx \\
 &= \int_0^1 (xe^{x^2} - x) dx = \left[\frac{1}{2}e^{x^2} - \frac{x^2}{2} \right]_0^1 = \frac{e-2}{2}
 \end{aligned}$$

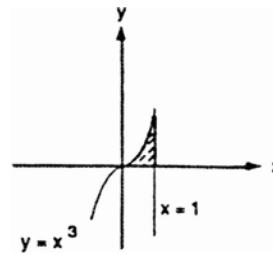

$$\begin{aligned}
 3. \int_0^{3/2} \int_{-\sqrt{9-4t^2}}^{\sqrt{9-4t^2}} t ds dt &= \int_0^{3/2} [ts]_{-\sqrt{9-4t^2}}^{\sqrt{9-4t^2}} dt \\
 &= \int_0^{3/2} 2t\sqrt{9-4t^2} dt = \left[-\frac{1}{6}(9-4t^2)^{3/2} \right]_0^{3/2} \\
 &= -\frac{1}{6}(0^{3/2} - 9^{3/2}) = \frac{27}{6} = \frac{9}{2}
 \end{aligned}$$

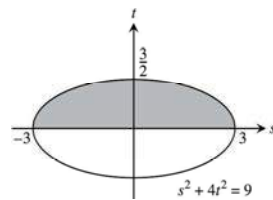

$$\begin{aligned}
 4. \int_0^1 \int_{\sqrt{y}}^{2-\sqrt{y}} xy dx dy &= \int_0^1 y \left[\frac{x^2}{2} \right]_{\sqrt{y}}^{2-\sqrt{y}} dy \\
 &= \frac{1}{2} \int_0^1 y(4 - 4\sqrt{y} + y - y) dy \\
 &= \int_0^1 (2y - 2y^{3/2}) dy = \left[y^2 - \frac{4y^{5/2}}{5} \right]_0^1 = \frac{1}{5}
 \end{aligned}$$

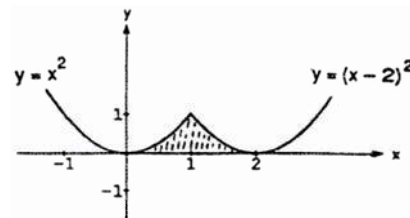

$$\begin{aligned}
 5. \int_{-2}^0 \int_{2x+4}^{4-x^2} dy dx &= \int_{-2}^0 (-x^2 - 2x) dx \\
 &= \left[-\frac{x^3}{3} - x^2 \right]_{-2}^0 = -\left(\frac{8}{3} - 4 \right) = \frac{4}{3} \\
 \int_0^4 \int_{-\sqrt{4-y}}^{(y-4)/2} dx dy &= \int_0^4 \left(\frac{y-4}{2} + \sqrt{4-y} \right) dy \\
 &= \left[\frac{y^2}{2} - 2y - \frac{2}{3}(4-y)^{3/2} \right]_0^4 \\
 &= 4 - 8 + \frac{2}{3} \cdot 4^{3/2} = -4 + \frac{16}{3} = \frac{4}{3}
 \end{aligned}$$

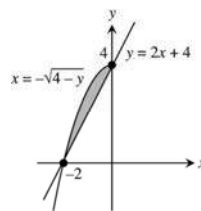

$$\begin{aligned}
 6. \int_0^1 \int_y^{\sqrt{y}} \sqrt{x} \, dx \, dy &= \int_0^1 \left[\frac{2}{3} x^{3/2} \right]_y^{\sqrt{y}} dy \\
 &= \frac{2}{3} \int_0^1 (y^{3/4} - y^{3/2}) dy = \frac{2}{3} \left[\frac{4}{7} y^{7/4} - \frac{2}{5} y^{5/2} \right]_0^1 \\
 &= \frac{2}{3} \left(\frac{4}{7} - \frac{2}{5} \right) = \frac{4}{35} \\
 \int_0^1 \int_{x^2}^x \sqrt{x} \, dy \, dx &= \int_0^1 x^{1/2} (x - x^2) dx \\
 &= \int_0^1 (x^{3/2} - x^{5/2}) dx \\
 &= \left[\frac{2}{5} x^{5/2} - \frac{2}{7} x^{7/2} \right]_0^1 = \frac{2}{5} - \frac{2}{7} = \frac{4}{35}
 \end{aligned}$$

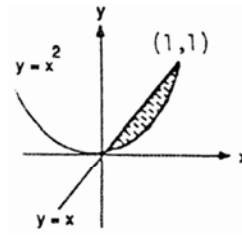

$$\begin{aligned}
 7. \int_{-3}^3 \int_0^{(1/2)\sqrt{9-x^2}} y \, dy \, dx &= \int_{-3}^3 \left[\frac{y^2}{2} \right]_0^{(1/2)\sqrt{9-x^2}} dx \\
 &= \int_{-3}^3 \frac{1}{8} (9 - x^2) dx = \left[\frac{9x}{8} - \frac{x^3}{24} \right]_{-3}^3 \\
 &= \left(\frac{27}{8} - \frac{27}{24} \right) - \left(-\frac{27}{8} + \frac{27}{24} \right) = \frac{27}{6} = \frac{9}{2} \\
 \int_0^{3/2} \int_{-\sqrt{9-4y^2}}^{\sqrt{9-4y^2}} y \, dx \, dy &= \int_0^{3/2} 2y\sqrt{9-4y^2} dy \\
 &= \left[-\frac{1}{4} \cdot \frac{2}{3} (9-4y^2)^{3/2} \right]_0^{3/2} = \frac{1}{6} \cdot 9^{3/2} = \frac{27}{6} = \frac{9}{2}
 \end{aligned}$$

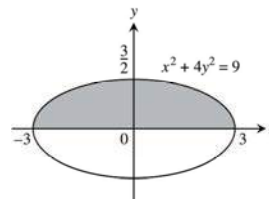

$$\begin{aligned}
 8. \int_0^2 \int_0^{4-x^2} 2x \, dy \, dx &= \int_0^2 [2xy]_0^{4-x^2} dx \\
 &= \int_0^2 (2x(4-x^2)) dx = \int_0^2 (8x - 2x^3) dx \\
 &= \left[4x^2 - \frac{x^4}{2} \right]_0^2 = 16 - \frac{16}{2} = 8 \\
 \int_0^4 \int_0^{\sqrt{4-y}} 2x \, dx \, dy &= \int_0^4 [x^2]_0^{\sqrt{4-y}} dy \\
 &= \int_0^4 (4-y) dy = \left[4y - \frac{y^2}{2} \right]_0^4 = 16 - \frac{16}{2} = 8
 \end{aligned}$$

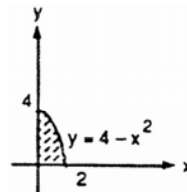

$$9. \int_0^1 \int_{2y}^2 4 \cos(x^2) \, dx \, dy = \int_0^2 \int_0^{x/2} 4 \cos(x^2) \, dy \, dx = \int_0^2 2x \cos(x^2) \, dx = \left[\sin(x^2) \right]_0^2 = \sin 4$$

$$10. \int_0^2 \int_{y/2}^1 e^{x^2} \, dx \, dy = \int_0^1 \int_0^{2x} e^{x^2} \, dy \, dx = \int_0^1 2xe^{x^2} \, dx = \left[e^{x^2} \right]_0^1 = e - 1$$

$$11. \int_0^8 \int_{\sqrt[3]{x}}^2 \frac{1}{y^4+1} \, dy \, dx = \int_0^2 \int_0^{y^3} \frac{1}{y^4+1} \, dx \, dy = \frac{1}{4} \int_0^2 \frac{4y^3}{y^4+1} \, dy = \frac{\ln 17}{4}$$

$$12. \int_0^1 \int_{\sqrt{y}}^1 \frac{2\pi \sin(\pi x^2)}{x^2} dx dy = \int_0^1 \int_0^{x^3} \frac{2\pi \sin(\pi x^2)}{x^2} dy dx = \int_0^1 2\pi x \sin(\pi x^2) dx = \left[-\cos(\pi x^2) \right]_0^1 = -(-1) - (-1) = 2$$

$$13. A = \int_{-2}^0 \int_{2x+4}^{4-x^2} dy dx = \int_{-2}^0 (-x^2 - 2x) dx = \frac{4}{3} \quad 14. A = \int_1^4 \int_{2-y}^{\sqrt{y}} dx dy = \int_1^4 (\sqrt{y} - 2 + y) dy = \frac{37}{6}$$

$$15. V = \int_0^1 \int_x^{2-x} (x^2 + y^2) dy dx = \int_0^1 \left[x^2 y + \frac{y^3}{3} \right]_x^{2-x} dx = \int_0^1 \left[2x^2 + \frac{(2-x)^3}{3} - \frac{7x^3}{3} \right] dx = \left[\frac{2x^3}{3} - \frac{(2-x)^4}{12} - \frac{7x^4}{12} \right]_0^1 = \left(\frac{2}{3} - \frac{1}{12} - \frac{7}{12} \right) + \frac{2^4}{12} = \frac{4}{3}$$

$$16. V = \int_{-3}^2 \int_x^{6-x^2} x^2 dy dx = \int_{-3}^2 [x^2 y]_x^{6-x^2} dx = \int_{-3}^2 (6x^2 - x^4 - x^3) dx = \frac{125}{4}$$

$$17. \text{average value} = \int_0^1 \int_0^1 xy dy dx = \int_0^1 \left[\frac{xy^2}{2} \right]_0^1 dx = \int_0^1 \frac{x}{2} dx = \frac{1}{4}$$

$$18. \text{average value} = \frac{1}{\left(\frac{\pi}{4}\right)} \int_0^1 \int_0^{\sqrt{1-x^2}} xy dy dx = \frac{4}{\pi} \int_0^1 \left[\frac{xy^2}{2} \right]_0^{\sqrt{1-x^2}} dx = \frac{2}{\pi} \int_0^1 (x - x^3) dx = \frac{1}{2\pi}$$

$$19. \int_{-1}^1 \int_{-\sqrt{1-x^2}}^{\sqrt{1-x^2}} \frac{2}{(1+x^2+y^2)^2} dy dx = \int_0^{2\pi} \int_0^1 \frac{2r}{(1+r^2)^2} dr d\theta = \int_0^{2\pi} \left[-\frac{1}{1+r^2} \right]_0^1 d\theta = \frac{1}{2} \int_0^{2\pi} d\theta = \pi$$

$$20. \int_{-1}^1 \int_{-\sqrt{1-y^2}}^{\sqrt{1-y^2}} \ln(x^2 + y^2 + 1) dx dy = \int_0^{2\pi} \int_0^1 r \ln(r^2 + 1) dr d\theta = \int_0^{2\pi} \int_1^2 \frac{1}{2} \ln u du d\theta = \frac{1}{2} \int_0^{2\pi} [u \ln u - u]_1^2 d\theta = \frac{1}{2} \int_0^{2\pi} (2 \ln 2 - 1) d\theta = [\ln(4) - 1]\pi$$

$$21. (x^2 + y^2)^2 - (x^2 - y^2) = 0 \Rightarrow r^4 - r^2 \cos 2\theta = 0 \Rightarrow r^2 = \cos 2\theta \text{ so the integral is } \int_{-\pi/4}^{\pi/4} \int_0^{\sqrt{\cos 2\theta}} \frac{r}{(1+r^2)^2} dr d\theta \\ = \int_{-\pi/4}^{\pi/4} \left[-\frac{1}{2(1+r^2)} \right]_0^{\sqrt{\cos 2\theta}} d\theta = \frac{1}{2} \int_{-\pi/4}^{\pi/4} \left(1 - \frac{1}{1+\cos 2\theta} \right) d\theta = \frac{1}{2} \int_{-\pi/4}^{\pi/4} \left(1 - \frac{1}{2\cos^2 \theta} \right) d\theta = \frac{1}{2} \int_{-\pi/4}^{\pi/4} \left(1 - \frac{\sec^2 \theta}{2} \right) d\theta \\ = \frac{1}{2} \left[\theta - \frac{\tan \theta}{2} \right]_{-\pi/4}^{\pi/4} = \frac{\pi-2}{4}$$

$$22. (a) \iint_R \frac{1}{(1+x^2+y^2)^2} dx dy = \int_0^{\pi/3} \int_0^{\sec \theta} \frac{r}{(1+r^2)^2} dr d\theta = \int_0^{\pi/3} \left[-\frac{1}{2(1+r^2)} \right]_0^{\sec \theta} d\theta = \int_0^{\pi/3} \left[\frac{1}{2} - \frac{1}{2(1+\sec^2 \theta)} \right] d\theta \\ = \frac{1}{2} \int_0^{\pi/3} \frac{\sec^2 \theta}{1+\sec^2 \theta} d\theta; \left[\begin{array}{l} u = \tan \theta \\ du = \sec^2 \theta d\theta \end{array} \right] \rightarrow \frac{1}{2} \int_0^{\sqrt{3}} \frac{du}{2+u^2} = \frac{1}{2} \left[\frac{1}{\sqrt{2}} \tan^{-1} \frac{u}{\sqrt{2}} \right]_0^{\sqrt{3}} = \frac{\sqrt{2}}{4} \tan^{-1} \sqrt{\frac{3}{2}}$$

- (b)
$$\iint_R \frac{1}{(1+x^2+y^2)^2} dx dy = \int_0^{\pi/2} \int_0^\infty \frac{r}{(1+r^2)^2} dr d\theta = \int_0^{\pi/2} \lim_{b \rightarrow \infty} \left[-\frac{1}{2(1+r^2)} \right]_0^b d\theta = \int_0^{\pi/2} \lim_{b \rightarrow \infty} \left[\frac{1}{2} - \frac{1}{2(1+b^2)} \right] d\theta$$

$$= \frac{1}{2} \int_0^{\pi/2} d\theta = \frac{\pi}{4}$$
23.
$$\int_0^\pi \int_0^\pi \int_0^\pi \cos(x+y+z) dx dy dz = \int_0^\pi \int_0^\pi [\sin(z+y+\pi) - \sin(z+y)] dy dz$$

$$= \int_0^\pi [-\cos(z+2\pi) + \cos(z+\pi) - \cos z + \cos(z+\pi)] dz = 0$$
24.
$$\int_{\ln 6}^{\ln 7} \int_0^{\ln 2} \int_{\ln 4}^{\ln 5} e^{(x+y+z)} dz dy dx = \int_{\ln 6}^{\ln 7} \int_0^{\ln 2} e^{(x+y)} dy dx = \int_{\ln 6}^{\ln 7} e^x dx = 1$$
25.
$$\int_0^1 \int_0^{x^2} \int_0^{x+y} (2x-y-z) dz dy dx = \int_0^1 \int_0^{x^2} \left(\frac{3x^2}{2} - \frac{3y^2}{2} \right) dy dx = \int_0^1 \left(\frac{3x^4}{2} - \frac{x^6}{2} \right) dx = \frac{8}{35}$$
26.
$$\int_1^e \int_1^x \int_0^z \frac{2y}{z^3} dy dz dx = \int_1^e \int_1^x \frac{1}{z} dz dx = \int_1^e \ln x dx = [x \ln x - x]_1^e = 1$$
27.
$$V = 2 \int_0^{\pi/2} \int_{-\cos y}^0 \int_0^{-2x} dz dx dy = 2 \int_0^{\pi/2} \int_{-\cos y}^0 (-2x) dx dy = 2 \int_0^{\pi/2} \cos^2 y dy = 2 \left[\frac{y}{2} + \frac{\sin 2y}{4} \right]_0^{\pi/2} = \frac{\pi}{2}$$
28.
$$V = 4 \int_0^2 \int_0^{\sqrt{4-x^2}} \int_0^{4-x^2} dz dy dx = 4 \int_0^2 \int_0^{\sqrt{4-x^2}} (4-x^2) dy dx = 4 \int_0^2 (4-x^2)^{3/2} dx$$

$$= \left[x(4-x^2)^{3/2} + 6x\sqrt{4-x^2} + 24 \sin^{-1} \frac{x}{2} \right]_0^2 = 24 \sin^{-1} 1 = 12\pi$$
29. average
$$= \frac{1}{3} \int_0^1 \int_0^3 \int_0^1 30xz\sqrt{x^2+y} dz dy dx = \frac{1}{3} \int_0^1 \int_0^3 15x\sqrt{x^2+y} dy dx = \frac{1}{3} \int_0^1 15x\sqrt{x^2+y} dx dy$$

$$= \frac{1}{3} \int_0^3 \left[5(x^2+y)^{3/2} \right]_0^1 dy = \frac{1}{3} \int_0^3 [5(1+y)^{3/2} - 5y^{3/2}] dy = \frac{1}{3} [2(1+y)^{5/2} - 2y^{5/2}]_0^3 = \frac{1}{3} [2(4)^{5/2} - 2(3)^{5/2} - 2]$$

$$= \frac{1}{3} [2(31 - 3^{5/2})]$$
30. average
$$= \frac{3}{4\pi a^3} \int_0^{2\pi} \int_0^\pi \int_0^a \rho^3 \sin \phi d\rho d\phi d\theta = \frac{3a}{16\pi} \int_0^{2\pi} \int_0^\pi \sin \phi d\phi d\theta = \frac{3a}{8\pi} \int_0^{2\pi} d\theta = \frac{3a}{4}$$
31. (a)
$$\int_{-\sqrt{2}}^{\sqrt{2}} \int_{-\sqrt{2-y^2}}^{\sqrt{2-y^2}} \int_{\sqrt{x^2+y^2}}^{\sqrt{4-x^2-y^2}} 3 dz dx dy$$
- (b)
$$\int_0^{2\pi} \int_0^{\pi/4} \int_0^2 3\rho^2 \sin \phi d\rho d\phi d\theta$$
- (c)
$$\int_0^{2\pi} \int_0^{\sqrt{2}} \int_r^{\sqrt{4-r^2}} 3 dz r dr d\theta = 3 \int_0^{2\pi} \int_0^{\sqrt{2}} \left[r(4-r^2)^{1/2} - r^2 \right] dr d\theta = 3 \int_0^{2\pi} \left[-\frac{1}{3}(4-r^2)^{3/2} - \frac{r^3}{3} \right]_0^{\sqrt{2}} d\theta$$

$$= \int_0^{2\pi} (-2^{3/2} - 2^{3/2} + 4^{3/2}) d\theta = (8 - 4\sqrt{2}) \int_0^{2\pi} d\theta = 2\pi(8 - 4\sqrt{2})$$

$$32. \text{ (a) } \int_{-\pi/2}^{\pi/2} \int_0^1 \int_{-r^2}^r 21(r \cos \theta)(r \sin \theta)^2 dz r dr d\theta = \int_{-\pi/2}^{\pi/2} \int_0^1 \int_{-r^2}^r 21r^3 \cos \theta \sin^2 \theta dz r dr d\theta$$

$$\text{ (b) } \int_{-\pi/2}^{\pi/2} \int_0^1 \int_{-r^2}^r 21r^3 \cos \theta \sin^2 \theta dz r dr d\theta = 84 \int_0^{\pi/2} \int_0^1 r^6 \sin^2 \theta \cos \theta dr d\theta = 12 \int_0^{\pi/2} \sin^2 \theta \cos \theta d\theta = 4$$

$$33. \text{ (a) } \int_0^{2\pi} \int_0^{\pi/4} \int_0^{\sec \phi} \rho^2 \sin \phi d\rho d\phi d\theta$$

$$\text{ (b) } \int_0^{2\pi} \int_0^{\pi/4} \int_0^{\sec \phi} \rho^2 \sin \phi d\rho d\phi d\theta = \frac{1}{3} \int_0^{2\pi} \int_0^{\pi/4} (\sec \phi)(\sec \phi \tan \phi) d\phi d\theta = \frac{1}{3} \int_0^{2\pi} \left[\frac{1}{2} \tan^2 \phi \right]_0^{\pi/4} d\theta$$

$$= \frac{1}{6} \int_0^{2\pi} d\theta = \frac{\pi}{3}$$

$$34. \text{ (a) } \int_0^1 \int_0^{\sqrt{1-x^2}} \int_0^{\sqrt{x^2+y^2}} (6+4y) dz dy dx \quad \text{ (b) } \int_0^{\pi/2} \int_0^1 \int_0^r (6+4r \sin \theta) dz r dr d\theta$$

$$\text{ (c) } \int_0^{\pi/2} \int_{\pi/4}^{\pi/2} \int_0^{\csc \phi} (6+4\rho \sin \phi \sin \theta) (\rho^2 \sin \phi) d\rho d\phi d\theta$$

$$\text{ (d) } \int_0^{\pi/2} \int_0^1 \int_0^r (6+4r \sin \theta) dz r dr d\theta = \int_0^{\pi/2} \int_0^1 (6r^2 + 4r^3 \sin \theta) dr d\theta = \int_0^{\pi/2} \left[2r^3 + r^4 \sin \theta \right]_0^1 d\theta$$

$$= \int_0^{\pi/2} (2 + \sin \theta) d\theta = [2\theta - \cos \theta]_0^{\pi/2} = \pi + 1$$

$$35. \int_0^1 \int_{\sqrt{1-x^2}}^{\sqrt{3-x^2}} \int_1^{\sqrt{4-x^2-y^2}} z^2 yx dz dy dx + \int_1^{\sqrt{3}} \int_0^{\sqrt{3-x^2}} \int_1^{\sqrt{4-x^2-y^2}} z^2 yx dz dy dx$$

36. (a) Bounded on the top and bottom by the sphere $x^2 + y^2 + z^2 = 4$, on the right by the right circular cylinder $(x-1)^2 + y^2 = 1$, on the left by the plane $y = 0$

$$\text{ (b) } \int_0^{\pi/2} \int_0^{2 \cos \theta} \int_{-\sqrt{4-r^2}}^{\sqrt{4-r^2}} dz r dr d\theta$$

$$37. \text{ (a) } V = \int_0^{2\pi} \int_0^2 \int_2^{\sqrt{8-r^2}} dz r dr d\theta = \int_0^{2\pi} \int_0^2 (r\sqrt{8-r^2} - 2r) dr d\theta = \int_0^{2\pi} \left[-\frac{1}{3}(8-r^2)^{3/2} - r^2 \right]_0^2 d\theta$$

$$= \int_0^{2\pi} \left[-\frac{1}{3}(4)^{3/2} - 4 + \frac{1}{3}(8)^{3/2} \right] d\theta = \int_0^{2\pi} \frac{4}{3}(-2-3+2\sqrt{8}) d\theta = \frac{4}{3}(4\sqrt{2}-5) \int_0^{2\pi} d\theta = \frac{8\pi(4\sqrt{2}-5)}{3}$$

$$\text{ (b) } V = \int_0^{2\pi} \int_0^{\pi/4} \int_{2 \sec \phi}^{\sqrt{8}} \rho^2 \sin \phi d\rho d\phi d\theta = \frac{8}{3} \int_0^{2\pi} \int_0^{\pi/4} (2\sqrt{2} \sin \phi - \sec^3 \phi \sin \phi) d\phi d\theta$$

$$= \frac{8}{3} \int_0^{2\pi} \int_0^{\pi/4} (2\sqrt{2} \sin \phi - \tan \phi \sec^2 \phi) d\phi d\theta = \frac{8}{3} \int_0^{2\pi} \left[-2\sqrt{2} \cos \phi - \frac{1}{2} \tan^2 \phi \right]_0^{\pi/4} d\theta$$

$$= \frac{8}{3} \int_0^{2\pi} \left(-2 - \frac{1}{2} + 2\sqrt{2} \right) d\theta = \frac{8}{3} \int_0^{2\pi} \left(\frac{-5+4\sqrt{2}}{2} \right) d\theta = \frac{8\pi(4\sqrt{2}-5)}{3}$$

$$38. I_z = \int_0^{2\pi} \int_0^{\pi/3} \int_0^2 (\rho \sin \phi)^2 (\rho^2 \sin \phi) d\rho d\phi d\theta = \int_0^{2\pi} \int_0^{\pi/3} \int_0^2 \rho^4 \sin^3 \phi d\rho d\phi d\theta$$

$$= \frac{32}{5} \int_0^{2\pi} \int_0^{\pi/3} (\sin \phi - \cos^2 \phi \sin \phi) d\phi d\theta = \frac{32}{5} \int_0^{2\pi} \left[-\cos \phi + \frac{\cos^3 \phi}{3} \right]_0^{\pi/3} d\theta = \frac{8\pi}{3}$$

39. With the centers of the spheres at the origin, $I_z = \int_0^{2\pi} \int_0^\pi \int_a^b \delta(\rho \sin \phi)^2 (\rho^2 \sin \phi) d\rho d\phi d\theta$
 $= \frac{\delta(b^5 - a^5)}{5} \int_0^{2\pi} \int_0^\pi \sin^3 \phi d\phi d\theta = \frac{\delta(b^5 - a^5)}{5} \int_0^{2\pi} \int_0^\pi (\sin \phi - \cos^2 \phi \sin \phi) d\phi d\theta$
 $= \frac{\delta(b^5 - a^5)}{5} \int_0^{2\pi} \left[-\cos \phi + \frac{\cos^3 \phi}{3} \right]_0^\pi d\theta = \frac{4\delta(b^5 - a^5)}{15} \int_0^{2\pi} d\theta = \frac{8\pi\delta(b^5 - a^5)}{15}$
40. $I_z = \int_0^{2\pi} \int_0^\pi \int_0^{1-\cos \theta} (\rho \sin \phi)^2 (\rho^2 \sin \phi) d\rho d\phi d\theta = \int_0^{2\pi} \int_0^\pi \int_0^{1-\cos \theta} \rho^4 \sin^3 \phi d\rho d\phi d\theta$
 $= \frac{1}{5} \int_0^{2\pi} \int_0^\pi (1 - \cos \phi)^5 \sin^3 \phi d\phi d\theta = \int_0^{2\pi} \int_0^\pi (1 - \cos \phi)^6 (1 + \cos \phi) \sin \phi d\phi d\theta; \begin{cases} u = 1 - \cos \phi \\ du = \sin \phi d\phi \end{cases}$
 $\rightarrow \frac{1}{5} \int_0^{2\pi} \int_0^2 u^6 (2 - u) du d\theta = \frac{1}{5} \int_0^{2\pi} \left[\frac{2u^7}{7} - \frac{u^8}{8} \right]_0^2 d\theta = \frac{1}{5} \int_0^{2\pi} \left(\frac{1}{7} - \frac{1}{8} \right) 2^8 d\theta = \frac{1}{5} \int_0^{2\pi} \frac{2^3 \cdot 2^5}{56} d\theta = \frac{32}{35} \int_0^{2\pi} d\theta = \frac{64\pi}{35}$
41. $M = \int_1^2 \int_{2/x}^2 dy dx = \int_1^2 \left(2 - \frac{2}{x} \right) dx = 2 - \ln 4; M_y = \int_1^2 \int_{2/x}^2 x dy dx = \int_1^2 x \left(2 - \frac{2}{x} \right) dx = 1;$
 $M_x = \int_1^2 \int_{2/x}^2 y dy dx = \int_1^2 \left(2 - \frac{2}{x^2} \right) dx = 1 \Rightarrow \bar{x} = \bar{y} = \frac{1}{2 - \ln 4}$
42. $M = \int_0^4 \int_{-2y}^{2y-y^2} dx dy = \int_0^4 (4y - y^2) dy = \frac{32}{3}; M_x = \int_0^4 \int_{-2y}^{2y-y^2} y dx dy = \int_0^4 (4y^2 - y^3) dy = \left[\frac{4y^3}{3} - \frac{y^4}{4} \right]_0^4 = \frac{64}{3};$
 $M_y = \int_0^4 \int_{-2y}^{2y-y^2} x dx dy = \int_0^4 \left[\frac{(2y-y^2)^2}{2} - 2y^2 \right] dy = \left[\frac{y^5}{10} - \frac{y^4}{2} \right]_0^4 = -\frac{128}{5} \Rightarrow \bar{x} = \frac{M_y}{M} = -\frac{12}{5} \text{ and } \bar{y} = \frac{M_x}{M} = 2$
43. $I_o = \int_0^2 \int_{2x}^4 (x^2 + y^2)(3) dy dx = 3 \int_0^2 \left(4x^2 + \frac{64}{3} - \frac{14x^3}{3} \right) dx = 104$
44. (a) $I_o = \int_{-2}^2 \int_{-1}^1 (x^2 + y^2) dy dx = \int_{-2}^2 \left(2x^2 + \frac{2}{3} \right) dx = \frac{40}{3}$
 (b) $I_x = \int_{-a}^a \int_{-b}^b y^2 dy dx = \int_{-a}^a \frac{2b^3}{3} dx = \frac{4ab^3}{3};$
 $I_y = \int_{-b}^b \int_{-a}^a x^2 dx dy = \int_{-b}^b \frac{2a^3}{3} dy = \frac{4a^3b}{3} \Rightarrow I_o = I_x + I_y = \frac{4ab^3}{3} + \frac{4a^3b}{3} = \frac{4ab(b^2 + a^2)}{3}$
45. $M = \delta \int_0^3 \int_0^{2x/3} dy dx = \delta \int_0^3 \frac{2x}{3} dx = 3\delta; I_x = \delta \int_0^3 \int_0^{2x/3} y^2 dy dx = \frac{8\delta}{81} \int_0^3 x^3 dx = \left(\frac{8\delta}{81} \right) \left(\frac{3^4}{4} \right) = 2\delta$
46. $M = \int_0^1 \int_{x^2}^x (x+1) dy dx = \int_0^1 (x - x^3) dx = \frac{1}{4}; M_x = \int_0^1 \int_{x^2}^x y(x+1) dy dx = \frac{1}{2} \int_0^1 (x^3 - x^5 + x^2 - x^4) dx = \frac{13}{120};$
 $M_y = \int_0^1 \int_{x^2}^x x(x+1) dy dx = \int_0^1 (x^2 - x^4) dx = \frac{2}{15} \Rightarrow \bar{x} = \frac{8}{15} \text{ and } \bar{y} = \frac{13}{30}; I_x = \int_0^1 \int_{x^2}^x y^2(x+1) dy dx$
 $= \frac{1}{3} \int_0^1 (x^4 - x^7 + x^3 - x^6) dx = \frac{17}{280} \Rightarrow R_x = \sqrt{\frac{I_x}{M}} = \sqrt{\frac{17}{70}}; I_y = \int_0^1 \int_{x^2}^x x^2(x+1) dy dx = \int_0^1 (x^3 - x^5) dx = \frac{1}{12}$

47. $M = \int_{-1}^1 \int_{-1}^1 \left(x^2 + y^2 + \frac{1}{3}\right) dy dx = \int_{-1}^1 \left(2x^2 + \frac{4}{3}\right) dx = 4$; $M_x = \int_{-1}^1 \int_{-1}^1 y \left(x^2 + y^2 + \frac{1}{3}\right) dy dx = \int_{-1}^1 0 dx = 0$;
 $M_y = \int_{-1}^1 \int_{-1}^1 x \left(x^2 + y^2 + \frac{1}{3}\right) dy dx = \int_{-1}^1 \left(2x^3 + \frac{4}{3}x\right) dx = 0$

48. Place the $\triangle ABC$ with its vertices at $A(0, 0)$, $B(b, 0)$ and $C(a, h)$. The line through the points A and C is $y = \frac{h}{a}x$; the line through the points C and B is $y = \frac{h}{a-b}(x-b)$. Thus, $M = \int_0^h \int_{ay/h}^{(a-b)y/h+b} \delta dx dy$
 $= b\delta \int_0^h \left(1 - \frac{y}{h}\right) dy = \frac{\delta bh}{2}$; $I_x = \int_0^h \int_{ay/h}^{(a-b)y/h+b} y^2 \delta dx dy = b\delta \int_0^h \left(y^2 - \frac{y^3}{h}\right) dy = \frac{\delta bh^3}{12}$

49. $M = \int_{-\pi/3}^{\pi/3} \int_0^3 r dr d\theta = \frac{9}{2} \int_{-\pi/3}^{\pi/3} d\theta = 3\pi$; $M_y = \int_{-\pi/3}^{\pi/3} \int_0^3 r^2 \cos \theta dr d\theta = 9 \int_{-\pi/3}^{\pi/3} \cos \theta d\theta = 9\sqrt{3} \Rightarrow \bar{x} = \frac{3\sqrt{3}}{\pi}$, and $\bar{y} = 0$ by symmetry

50. $M = \int_0^{\pi/2} \int_1^3 r dr d\theta = 4 \int_0^{\pi/2} d\theta = 2\pi$; $M_y = \int_0^{\pi/2} \int_1^3 r^2 \cos \theta dr d\theta = \frac{26}{3} \int_0^{\pi/2} \cos \theta d\theta = \frac{26}{3} \Rightarrow \bar{x} = \frac{13}{3\pi}$, and $\bar{y} = \frac{13}{3\pi}$ by symmetry

51. (a) $M = 2 \int_0^{\pi/2} \int_1^{1+\cos \theta} r dr d\theta$
 $= \int_0^{\pi/2} \left(2 \cos \theta + \frac{1+\cos 2\theta}{2}\right) d\theta = \frac{8+\pi}{4}$;
 $M_y = \int_{-\pi/2}^{\pi/2} \int_1^{1+\cos \theta} (r \cos \theta) r dr d\theta$
 $= \int_{-\pi/2}^{\pi/2} \left(\cos^2 \theta + \cos^3 \theta + \frac{\cos^4 \theta}{3}\right) d\theta$
 $= \frac{32+15\pi}{24} \Rightarrow \bar{x} = \frac{15\pi+32}{6\pi+48}$, and $\bar{y} = 0$ by symmetry

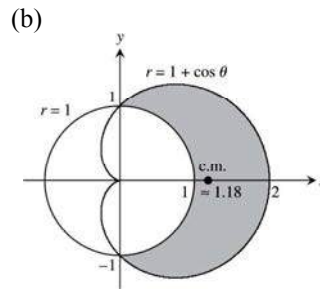

52. (a) $M = \int_{-\alpha}^{\alpha} \int_0^a r dr d\theta = \int_{-\alpha}^{\alpha} \frac{a^2}{2} d\theta = a^2 \alpha$;
 $M_y = \int_{-\alpha}^{\alpha} \int_0^a (r \cos \theta) r dr d\theta$
 $= \int_{-\alpha}^{\alpha} \frac{a^3 \cos \theta}{3} d\theta = \frac{2a^3 \sin \alpha}{3}$
 $\Rightarrow \bar{x} = \frac{2a \sin \alpha}{3\alpha}$, and $\bar{y} = 0$ by symmetry;
 $\lim_{\alpha \rightarrow \pi^-} \bar{x} = \lim_{\alpha \rightarrow \pi^-} \frac{2a \sin \alpha}{3\alpha} = 0$
 (b) $\bar{x} = \frac{2a}{5\pi}$ and $\bar{y} = 0$

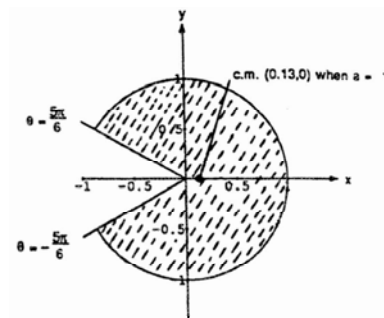

53. $x = u + y$ and $y = v \Rightarrow x = u + v$ and $y = v$

$$\Rightarrow J(u, v) = \begin{vmatrix} 1 & 1 \\ 0 & 1 \end{vmatrix} = 1; \text{ the boundary of the image } G$$

is obtained from the boundary of R as follows:

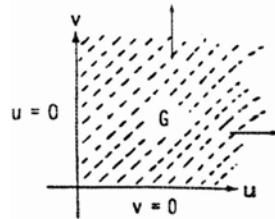
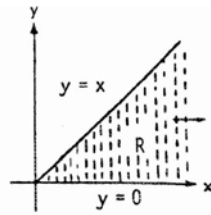

xy -equations for the boundary of R	Corresponding uv -equations for the boundary of G	Simplified uv -equations
$y = x$	$v = u + v$	$u = 0$
$y = 0$	$v = 0$	$v = 0$

$$\Rightarrow \int_0^\infty \int_0^x e^{-sx} f(x-y, y) dy dx = \int_0^\infty \int_0^\infty e^{-s(u+v)} f(u, v) du dv$$

54. If $s = \alpha x + \beta y$ and $t = \gamma x + \delta y$ where $(\alpha\delta - \beta\gamma)^2 = ac - b^2$, then $x = \frac{\delta s - \beta t}{\alpha\delta - \beta\gamma}$, $y = \frac{-\gamma s + \alpha t}{\alpha\delta - \beta\gamma}$, and

$$J(s, t) = \frac{1}{(\alpha\delta - \beta\gamma)^2} \begin{vmatrix} \delta & -\beta \\ -\gamma & \alpha \end{vmatrix} = \frac{1}{\alpha\delta - \beta\gamma} \Rightarrow \int_{-\infty}^\infty \int_{-\infty}^\infty e^{-(s^2+t^2)} \frac{1}{\sqrt{ac-b^2}} ds dt = \frac{1}{\sqrt{ac-b^2}} \int_0^{2\pi} \int_0^\infty r e^{-r^2} dr d\theta$$

$$= \frac{1}{2\sqrt{ac-b^2}} \int_0^{2\pi} d\theta = \frac{\pi}{\sqrt{ac-b^2}}. \text{ Therefore, } \frac{\pi}{\sqrt{ac-b^2}} = 1 \Rightarrow ac - b^2 = \pi^2.$$

CHAPTER 15 ADDITIONAL AND ADVANCED EXERCISES

1. (a) $V = \int_{-3}^2 \int_x^{6-x^2} x^2 dy dx$ (b) $V = \int_{-3}^2 \int_x^{6-x^2} \int_0^{x^2} dz dy dx$

(c) $V = \int_{-3}^2 \int_x^{6-x^2} x^2 dy dx = \int_{-3}^2 \int_x^{6-x^2} (6x^2 - x^4 - x^3) dx = \left[2x^3 - \frac{x^5}{5} - \frac{x^4}{4} \right]_{-3}^2 = \frac{125}{4}$

2. Place the sphere's center at the origin with the surface of the water at $z = -3$.

Then $9 = 25 - x^2 - y^2 \Rightarrow x^2 + y^2 = 16$ is the projection of the volume of water onto the xy -plane

$$\Rightarrow V = \int_0^{2\pi} \int_0^4 \int_{-\sqrt{25-r^2}}^{-3} dz r dr d\theta = \int_0^{2\pi} \int_0^4 \left(r\sqrt{25-r^2} - 3r \right) dr d\theta = \int_0^{2\pi} \left[-\frac{1}{3}(25-r^2)^{3/2} - \frac{3}{2}r^2 \right]_0^4 d\theta$$

$$= \int_0^{2\pi} \left[-\frac{1}{3}(9)^{3/2} - 24 + \frac{1}{3}(25)^{3/2} \right] d\theta = \int_0^{2\pi} \frac{26}{3} d\theta = \frac{52\pi}{3}$$

3. Using cylindrical coordinates, $V = \int_0^{2\pi} \int_0^1 \int_0^{2-r(\cos\theta+\sin\theta)} dz r dr d\theta = \int_0^{2\pi} \int_0^1 (2r - r^2 \cos\theta - r^2 \sin\theta) dr d\theta$

$$= \int_0^{2\pi} \left(1 - \frac{1}{3} \cos\theta - \frac{1}{3} \sin\theta \right) d\theta = \left[\theta - \frac{1}{3} \sin\theta + \frac{1}{3} \cos\theta \right]_0^{2\pi} = 2\pi$$

$$4. \quad V = 4 \int_0^{\pi/2} \int_0^1 \int_{r^2}^{\sqrt{2-r^2}} dz \, r \, dr \, d\theta = 4 \int_0^{\pi/2} \int_0^1 (r\sqrt{2-r^2} - r^3) \, dr \, d\theta = 4 \int_0^{\pi/2} \left[-\frac{1}{3}(2-r^2)^{3/2} - \frac{r^4}{4} \right]_0^1 d\theta$$

$$= 4 \int_0^{\pi/2} \left(-\frac{1}{3} - \frac{1}{4} + \frac{2\sqrt{2}}{3} \right) d\theta = \left(\frac{8\sqrt{2}-7}{3} \right) \int_0^{\pi/2} d\theta = \frac{\pi(8\sqrt{2}-7)}{6}$$

5. The surfaces intersect when $3 - x^2 - y^2 = 2x^2 + 2y^2 \Rightarrow x^2 + y^2 = 1$. Thus the volume is

$$V = 4 \int_0^1 \int_0^{\sqrt{1-x^2}} \int_{2x^2+2y^2}^{3-x^2-y^2} dz \, dy \, dx = 4 \int_0^{\pi/2} \int_0^1 \int_{2r^2}^{3-r^2} dz \, r \, dr \, d\theta = 4 \int_0^{\pi/2} \int_0^1 (3r - 3r^3) \, dr \, d\theta = 3 \int_0^{\pi/2} d\theta = \frac{3\pi}{2}$$

$$6. \quad V = 8 \int_0^{\pi/2} \int_0^{\pi/2} \int_0^{2\sin\phi} \rho^2 \sin\phi \, d\rho \, d\phi \, d\theta = \frac{64}{3} \int_0^{\pi/2} \int_0^{\pi/2} \sin^4\phi \, d\phi \, d\theta$$

$$= \frac{64}{3} \int_0^{\pi/2} \left[-\frac{\sin^3\phi \cos\phi}{4} \right]_0^{\pi/2} + \frac{3}{4} \int_0^{\pi/2} \sin^2\phi \, d\phi \, d\theta = 16 \int_0^{\pi/2} \left[\frac{\phi}{2} - \frac{\sin 2\phi}{4} \right]_0^{\pi/2} d\theta = 4\pi \int_0^{\pi/2} d\theta = 2\pi^2$$

7. (a) The radius of the hole is 1, and the radius of the sphere is 2.

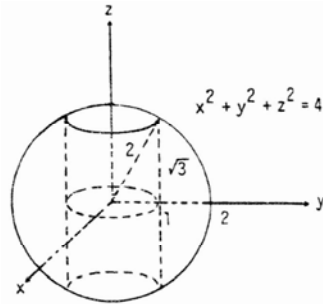

$$(b) \quad V = 2 \int_0^{2\pi} \int_0^{\sqrt{3}} \int_1^{\sqrt{4-z^2}} r \, dr \, dz \, d\theta = \int_0^{2\pi} \int_0^{\sqrt{3}} (3 - z^2) \, dz \, d\theta = 2\sqrt{3} \int_0^{2\pi} d\theta = 4\sqrt{3}\pi$$

$$8. \quad V = \int_0^{\pi} \int_0^{3\sin\theta} \int_0^{\sqrt{9-r^2}} dz \, r \, dr \, d\theta = \int_0^{\pi} \int_0^{3\sin\theta} r\sqrt{9-r^2} \, dr \, d\theta = \int_0^{\pi} \left[-\frac{1}{3}(9-r^2)^{3/2} \right]_0^{3\sin\theta} d\theta$$

$$= \int_0^{\pi} \left[-\frac{1}{3}(9-9\sin^2\theta)^{3/2} + \frac{1}{3}(9)^{3/2} \right] d\theta = 9 \int_0^{\pi} \left[1 - (1-\sin^2\theta)^{3/2} \right] d\theta = 9 \int_0^{\pi} (1 - \cos^3\theta) \, d\theta$$

$$= \int_0^{\pi} (1 - \cos\theta + \sin^2\theta \cos\theta) \, d\theta = 9 \left[\theta - \sin\theta + \frac{\sin^3\theta}{3} \right]_0^{\pi} = 9\pi$$

9. The surfaces intersect when $x^2 + y^2 = \frac{x^2+y^2+1}{2} \Rightarrow x^2 + y^2 = 1$. Thus the volume in cylindrical coordinates is

$$V = 4 \int_0^{\pi/2} \int_0^1 \int_{r^2}^{(r^2+1)/2} dz \, r \, dr \, d\theta = 4 \int_0^{\pi/2} \int_0^1 \left(\frac{r}{2} - \frac{r^3}{2} \right) dr \, d\theta = 4 \int_0^{\pi/2} \left[\frac{r^2}{4} - \frac{r^4}{8} \right]_0^1 d\theta = \frac{1}{2} \int_0^{\pi/2} d\theta = \frac{\pi}{4}$$

$$10. \quad V = \int_0^{\pi/2} \int_1^2 \int_0^{r^2 \sin\theta \cos\theta} dz \, r \, dr \, d\theta = \int_0^{\pi/2} \int_1^2 r^3 \sin\theta \cos\theta \, dr \, d\theta = \int_0^{\pi/2} \left[\frac{r^4}{4} \right]_1^2 \sin\theta \cos\theta \, d\theta$$

$$= \frac{15}{4} \int_0^{\pi/2} \sin\theta \cos\theta \, d\theta = \frac{15}{4} \left[\frac{\sin^2\theta}{2} \right]_0^{\pi/2} = \frac{15}{8}$$

$$11. \int_0^\infty \frac{e^{-ax} - e^{-bx}}{x} dx = \int_0^\infty \int_a^b e^{-xy} dy dx = \int_a^b \int_0^\infty e^{-xy} dx dy = \int_a^b \left(\lim_{t \rightarrow \infty} \int_0^t e^{-xy} dx \right) dy = \int_a^b \lim_{t \rightarrow \infty} \left[-\frac{e^{-xy}}{y} \right]_0^t dy$$

$$= \int_a^b \lim_{t \rightarrow \infty} \left(\frac{1}{y} - \frac{e^{-yt}}{y} \right) dy = \int_a^b \frac{1}{y} dy = [\ln y]_a^b = \ln\left(\frac{b}{a}\right)$$

12. (a) The region of integration is sketched at the right

$$\Rightarrow \int_0^{a \sin \beta} \int_{y \cot \beta}^{\sqrt{a^2 - y^2}} \ln(x^2 + y^2) dx dy$$

$$= \int_0^\beta \int_0^a r \ln(r^2) dr d\theta;$$

$$\left[\begin{array}{l} u = r^2 \\ du = 2r dr \end{array} \right] \rightarrow \frac{1}{2} \int_0^\beta \int_0^{a^2} \ln u du d\theta$$

$$= \frac{1}{2} \int_0^\beta [u \ln u - u]_0^{a^2} d\theta = \frac{1}{2} \int_0^\beta [2a^2 \ln a - a^2 - \lim_{t \rightarrow 0} t \ln t] d\theta = \frac{a^2}{2} \int_0^\beta (2 \ln a - 1) d\theta = a^2 \beta \left(\ln a - \frac{1}{2} \right)$$

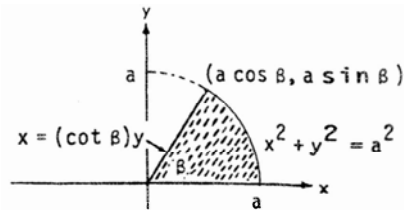

(b) $\int_0^{a \cos \beta} \int_0^{(\tan \beta)x} \ln(x^2 + y^2) dy dx + \int_{a \cos \beta}^a \int_0^{\sqrt{a^2 - x^2}} \ln(x^2 + y^2) dy dx$

13. $\int_0^x \int_0^u e^{m(x-t)} f(t) dt du = \int_0^x \int_t^x e^{m(x-t)} f(t) du dt = \int_0^x (x-t)e^{m(x-t)} f(t) dt$; also

$$\int_0^x \int_0^v \int_0^u e^{m(x-t)} f(t) dt du dv = \int_0^x \int_t^x \int_t^v e^{m(x-t)} f(t) du dv dt = \int_0^x \int_t^x (v-t)e^{m(x-t)} f(t) dv dt$$

$$= \int_0^x \left[\frac{1}{2}(v-t)^2 e^{m(x-t)} f(t) \right]_t^x dt = \int_0^x \frac{(x-t)^2}{2} e^{m(x-t)} f(t) dt$$

14. $\int_0^1 f(x) \left(\int_0^x g(x-y) f(y) dy \right) dx = \int_0^1 \int_0^x g(x-y) f(x) f(y) dy dx = \int_0^1 \int_y^1 g(x-y) f(x) f(y) dx dy$

$$= \int_0^1 f(y) \left(\int_y^1 g(x-y) f(x) dx \right) dy;$$

$$\int_0^1 \int_0^1 g(|x-y|) f(x) f(y) dx dy = \int_0^1 \int_0^x g(x-y) f(x) f(y) dy dx + \int_0^1 \int_x^1 g(y-x) f(x) f(y) dy dx$$

$$= \int_0^1 \int_y^1 g(x-y) f(x) f(y) dx dy + \int_0^1 \int_x^1 g(y-x) f(x) f(y) dy dx$$

$$= \int_0^1 \int_y^1 g(x-y) f(x) f(y) dx dy + \underbrace{\int_0^1 \int_y^1 g(x-y) f(y) f(x) dx dy}_{\text{simply interchange } x \text{ and } y \text{ variable names}} = 2 \int_0^1 \int_y^1 g(x-y) f(x) f(y) dx dy,$$

and the statement now follows.

15. $I_o(a) = \int_0^a \int_0^{x/a^2} (x^2 + y^2) dy dx = \int_0^a \left[x^2 y + \frac{y^3}{3} \right]_0^{x/a^2} dx = \int_0^a \left(\frac{x^3}{a^2} + \frac{x^3}{3a^6} \right) dx = \left[\frac{x^4}{4a^2} + \frac{x^4}{12a^6} \right]_0^a = \frac{a^2}{4} + \frac{1}{12} a^{-2};$

$I_o'(a) = \frac{1}{2} a - \frac{1}{6} a^{-3} = 0 \Rightarrow a^4 = \frac{1}{3} \Rightarrow a = \sqrt[4]{\frac{1}{3}} = \frac{1}{\sqrt[4]{3}}$. Since $I_o''(a) = \frac{1}{2} + \frac{1}{2} a^{-4} > 0$, the value of a does provide a minimum for the polar moment of inertia $I_o(a)$.

16. $I_o = \int_0^2 \int_{2x}^4 (x^2 + y^2)(3) dy dx = 3 \int_0^2 \left(4x^2 - \frac{14x^3}{3} + \frac{64}{3} \right) dx = 104$

$$\begin{aligned}
 17. \quad M &= \int_{-\theta}^{\theta} \int_{b \sec \theta}^a r \, dr \, d\theta = \int_{-\theta}^{\theta} \left(\frac{a^2}{2} - \frac{b^2}{2} \sec^2 \theta \right) d\theta \\
 &= a^2 \theta - b^2 \tan \theta = a^2 \cos^{-1} \left(\frac{b}{a} \right) - b^2 \left(\frac{\sqrt{a^2 - b^2}}{b} \right) \\
 &= a^2 \cos^{-1} \left(\frac{b}{a} \right) - b \sqrt{a^2 - b^2}; \\
 I_o &= \int_{-\theta}^{\theta} \int_{b \sec \theta}^a r^3 \, dr \, d\theta = \frac{1}{4} \int_{-\theta}^{\theta} (a^4 + b^4 \sec^4 \theta) d\theta \\
 &= \frac{1}{4} \int_{-\theta}^{\theta} [a^4 + b^4 (1 + \tan^2 \theta) (\sec^2 \theta)] d\theta \\
 &= \frac{1}{4} \left[a^4 \theta - b^4 \tan \theta - \frac{b^4 \tan^3 \theta}{3} \right]_{-\theta}^{\theta} = \frac{a^4 \theta}{2} - \frac{b^4 \tan \theta}{2} - \frac{b^4 \tan^3 \theta}{6} = \frac{1}{2} a^4 \cos^{-1} \left(\frac{b}{a} \right) - \frac{1}{2} b^3 \sqrt{a^2 - b^2} - \frac{1}{6} b^3 (a^2 - b^2)^{3/2}
 \end{aligned}$$

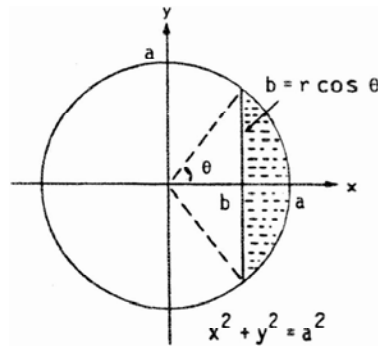

$$\begin{aligned}
 18. \quad M &= \int_{-2}^2 \int_{1-(y^2/4)}^{2-(y^2/2)} dx \, dy = \int_{-2}^2 \left(1 - \frac{y^2}{4} \right) dy = \left[y - \frac{y^3}{12} \right]_{-2}^2 = \frac{8}{3}; \quad M_y = \int_{-2}^2 \int_{1-(y^2/4)}^{2-(y^2/2)} x \, dx \, dy \\
 &= \int_{-2}^2 \left[\frac{x^2}{2} \right]_{1-(y^2/4)}^{2-(y^2/2)} dy = \int_{-2}^2 \frac{3}{32} (4 - y^2) dy = \frac{3}{32} \int_{-2}^2 (16 - 8y^2 + y^4) dy = \frac{3}{16} \left[16y - \frac{8y^3}{3} + \frac{y^5}{5} \right]_0^2 \\
 &= \frac{3}{16} \left(32 - \frac{64}{3} + \frac{32}{5} \right) = \left(\frac{3}{16} \right) \left(\frac{32 \cdot 8}{15} \right) = \frac{48}{15} = \frac{3}{32} \int_{-2}^2 (16 - 8y^2 + y^4) dy = \frac{3}{16} \left[16y - \frac{8y^3}{3} + \frac{y^5}{5} \right]_0^2 \text{ and } \bar{y} = 0 \text{ by symmetry}
 \end{aligned}$$

$$19. \quad = \left[\frac{1}{2ab} e^{b^2 x^2} \right]_0^a + \left[\frac{1}{2ba} e^{a^2 y^2} \right]_0^b = \frac{1}{2ab} (e^{b^2 a^2} - 1) + \frac{1}{2ab} (e^{a^2 b^2} - 1) = \frac{1}{ab} (e^{a^2 b^2} - 1)$$

$$\begin{aligned}
 20. \quad \int_{y_0}^{y_1} \int_{x_0}^{x_1} \frac{\partial^2 F(x, y)}{\partial x \partial y} dx \, dy &= \int_{y_0}^{y_1} \left[\frac{\partial F(x, y)}{\partial y} \right]_{x_0}^{x_1} dy = \int_{y_0}^{y_1} \left[\frac{\partial F(x_1, y)}{\partial y} - \frac{\partial F(x_0, y)}{\partial y} \right] dx = [F(x_1, y) - F(x_0, y)]_{y_0}^{y_1} \\
 &= F(x_1, y_1) - F(x_0, y_1) - F(x_1, y_0) + F(x_0, y_0)
 \end{aligned}$$

21. (a) (i) Fubini's Theorem
 (ii) Treating $G(y)$ as a constant
 (iii) Algebraic rearrangement
 (iv) The definite integral is a constant number

$$(b) \quad \int_0^{\ln 2} \int_0^{\pi/2} e^x \cos y \, dy \, dx = \left(\int_0^{\ln 2} e^x \, dx \right) \left(\int_0^{\pi/2} \cos y \, dy \right) = (e^{\ln 2} - e^0) (\sin \frac{\pi}{2} - \sin 0) = (1)(1) = 1$$

$$(c) \quad \int_1^2 \int_{-1}^1 \frac{x}{y^2} \, dx \, dy = \left(\int_1^2 \frac{1}{y^2} \, dy \right) \left(\int_{-1}^1 x \, dx \right) = \left[-\frac{1}{y} \right]_{-1}^2 \left[\frac{x^2}{2} \right]_{-1}^1 = \left(-\frac{1}{2} + 1 \right) \left(\frac{1}{2} - \frac{1}{2} \right) = 0$$

22. (a) $\nabla f = x\mathbf{i} + y\mathbf{j} \Rightarrow D_u f = u_1 x + u_2 y$; the area of the region of integration is $\frac{1}{2}$

$$\begin{aligned}
 \Rightarrow \text{average} &= 2 \int_0^1 \int_0^{1-x} (u_1 x + u_2 y) \, dy \, dx = 2 \int_0^1 \left[u_1 x(1-x) + \frac{1}{2} u_2 (1-x)^2 \right] dx \\
 &= 2 \left[u_1 \left(\frac{x^2}{2} - \frac{x^3}{3} \right) - \left(\frac{1}{2} u_2 \right) \frac{(1-x)^3}{3} \right]_0^1 = 2 \left(\frac{1}{6} u_1 + \frac{1}{6} u_2 \right) = \frac{1}{3} (u_1 + u_2)
 \end{aligned}$$

$$(b) \quad \text{average} = \frac{1}{\text{area}} \iint_R (u_1 x + u_2 y) \, dA = \frac{u_1}{\text{area}} \iint_R x \, dA + \frac{u_2}{\text{area}} \iint_R y \, dA = u_1 \left(\frac{M_y}{M} \right) + u_2 \left(\frac{M_x}{M} \right) = u_1 \bar{x} + u_2 \bar{y}$$

23. (a) $I^2 = \int_0^\infty \int_0^\infty e^{-(x^2+y^2)} dx dy = \int_0^{\pi/2} \int_0^\infty (e^{-r^2}) r dr d\theta = \int_0^{\pi/2} \left[\lim_{b \rightarrow \infty} \int_0^b r e^{-r^2} dr \right] d\theta$
 $= -\frac{1}{2} \int_0^{\pi/2} \lim_{b \rightarrow \infty} (e^{-b^2} - 1) d\theta = \frac{1}{2} \int_0^{\pi/2} d\theta = \frac{\pi}{4} \Rightarrow I = \frac{\sqrt{\pi}}{2}$

(b) $\Gamma\left(\frac{1}{2}\right) = \int_0^\infty t^{-1/2} e^{-t} dt = \int_0^\infty (y^2)^{-1/2} e^{-y^2} (2y) dy = 2 \int_0^\infty e^{-y^2} dy = 2 \left(\frac{\sqrt{\pi}}{2} \right) = \sqrt{\pi}$, where $y = \sqrt{t}$

24. $Q = \int_0^{2\pi} \int_0^R kr^2(1 - \sin \theta) dr d\theta = \frac{kR^3}{3} \int_0^{2\pi} (1 - \sin \theta) d\theta = \frac{kR^3}{3} [\theta + \cos \theta]_0^{2\pi} = \frac{2\pi kR^3}{3}$

25. For a height h in the bowl the volume of water is $V = \int_{-\sqrt{h}}^{\sqrt{h}} \int_{-\sqrt{h-x^2}}^{\sqrt{h-x^2}} \int_{x^2+y^2}^h dz dy dx$
 $= \int_{-\sqrt{h}}^{\sqrt{h}} \int_{-\sqrt{h-x^2}}^{\sqrt{h-x^2}} (h - x^2 - y^2) dy dx = \int_0^{2\pi} \int_0^{\sqrt{h}} (h - r^2) r dr d\theta = \int_0^{2\pi} \left[\frac{hr^2}{2} - \frac{r^4}{4} \right]_0^{\sqrt{h}} d\theta = \int_0^{2\pi} \frac{h^2}{4} d\theta = \frac{h^2\pi}{2}$.

Since the top of the bowl has area 10π , then we calibrate the bowl by comparing it to a right circular cylinder whose cross sectional area is 10π from $z = 0$ to $z = 10$. If such a cylinder contains $\frac{h^2\pi}{2}$ cubic inches of water to a depth w then we have $10\pi w = \frac{h^2\pi}{2} \Rightarrow w = \frac{h^2}{20}$. So for 1 inch of rain, $w = 1$ and $h = \sqrt{20}$; for 3 inches of rain, $w = 3$ and $h = \sqrt{60}$.

26. (a) An equation for the satellite dish in standard position is $z = \frac{1}{2}x^2 + \frac{1}{2}y^2$. Since the axis is tilted 30° , a unit vector $\mathbf{v} = 0\mathbf{i} + a\mathbf{j} + b\mathbf{k}$ normal to the plane of the water level satisfies

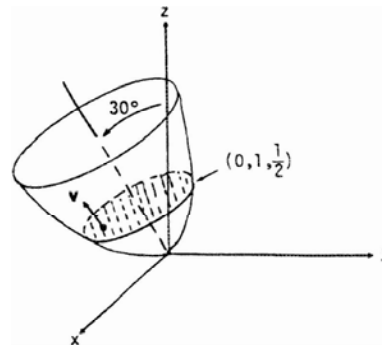

$$b = \mathbf{v} \cdot \mathbf{k} = \cos\left(\frac{\pi}{6}\right) = \frac{\sqrt{3}}{2}$$

$$\Rightarrow a = -\sqrt{1 - b^2} = -\frac{1}{2}$$

$$\Rightarrow \mathbf{v} = -\frac{1}{2}\mathbf{j} + \frac{\sqrt{3}}{2}\mathbf{k}$$

$$\Rightarrow -\frac{1}{2}(y - 1) + \frac{\sqrt{3}}{2}\left(z - \frac{1}{2}\right) = 0$$

$\Rightarrow z = \frac{1}{\sqrt{3}}y + \left(\frac{1}{2} - \frac{1}{\sqrt{3}}\right)$ is an equation of the plane of the water level. Therefore the volume of water is

$$V = \iiint_R \int_{\frac{1}{2}x^2 + \frac{1}{2}y^2}^{\frac{1}{\sqrt{3}}y + \frac{1}{2} - \frac{1}{\sqrt{3}}} dz dy dx, \text{ where } R \text{ is the interior of the ellipse } x^2 + y^2 - \frac{2}{\sqrt{3}}y - 1 + \frac{2}{\sqrt{3}} = 0. \text{ When } x = 0,$$

then $y = \alpha$ or $y = \beta$, $\alpha = \frac{\frac{2}{\sqrt{3}} + \sqrt{\frac{4}{3} - 4\left(\frac{2}{\sqrt{3}} - 1\right)}}{2}$ and $\beta = \frac{\frac{2}{\sqrt{3}} - \sqrt{\frac{4}{3} - 4\left(\frac{2}{\sqrt{3}} - 1\right)}}{2}$

$$\Rightarrow V = \int_{\alpha}^{\beta} \int_{-\left(\frac{2}{3}y + 1 - \frac{2}{\sqrt{3}}\right)^{1/2}}^{\left(\frac{2}{3}y + 1 - \frac{2}{\sqrt{3}}\right)^{1/2}} \int_{\frac{1}{2}x^2 + \frac{1}{2}y^2}^{\frac{1}{\sqrt{3}}y + \frac{1}{2} - \frac{1}{\sqrt{3}}} 1 dz dx dy$$

(b) $x = 0 \Rightarrow z = \frac{1}{2}y^2$ and $\frac{dz}{dy} = y$; $y = 1 \Rightarrow \frac{dz}{dy} = 1 \Rightarrow$ the tangent line has slope 1 or a 45° slant \Rightarrow at 45° and thereafter, the dish will not hold water.

27. The cylinder is given by $x^2 + y^2 = 1$ from $z = 1$ to $\infty \Rightarrow \iiint_D z(r^2 + z^2)^{-5/2} dV$

$$\begin{aligned}
 &= \int_0^{2\pi} \int_0^1 \int_1^\infty \frac{z}{(r^2 + z^2)^{5/2}} dz r dr d\theta = \lim_{a \rightarrow \infty} \int_0^{2\pi} \int_0^1 \int_1^a \frac{rz}{(r^2 + z^2)^{5/2}} dz dr d\theta = \lim_{a \rightarrow \infty} \int_0^{2\pi} \int_0^1 \left[\left(-\frac{1}{3}\right) \frac{r}{(r^2 + z^2)^{3/2}} \right]_1^a dr d\theta \\
 &= \lim_{a \rightarrow \infty} \int_0^{2\pi} \int_0^1 \left[\left(-\frac{1}{3}\right) \frac{r}{(r^2 + a^2)^{3/2}} + \left(\frac{1}{3}\right) \frac{r}{(r^2 + 1)^{3/2}} \right] dr d\theta = \lim_{a \rightarrow \infty} \int_0^{2\pi} \left[\frac{1}{3} (r^2 + a^2)^{-1/2} - \frac{1}{3} (r^2 + 1)^{-1/2} \right]_0^1 d\theta \\
 &= \lim_{a \rightarrow \infty} \int_0^{2\pi} \left[\frac{1}{3} (1 + a^2)^{-1/2} - \frac{1}{3} (2^{-1/2}) - \frac{1}{3} (a^2)^{-1/2} + \frac{1}{3} \right] d\theta = \lim_{a \rightarrow \infty} 2\pi \left[\frac{1}{3} (1 + a^2)^{-1/2} - \frac{1}{3} \left(\frac{\sqrt{2}}{2}\right) - \frac{1}{3} \left(\frac{1}{a}\right) + \frac{1}{3} \right] \\
 &= 2\pi \left[\frac{1}{3} - \left(\frac{1}{3}\right) \frac{\sqrt{2}}{2} \right].
 \end{aligned}$$

28. Let's see?

The length of the "unit" line segment is: $L = 2 \int_0^1 dx = 2.$

The area of the unit circle is: $A = 4 \int_0^1 \int_0^{\sqrt{1-x^2}} dy dx = \pi.$

The volume of the unit sphere is: $V = 8 \int_0^1 \int_0^{\sqrt{1-x^2}} \int_0^{\sqrt{1-x^2-y^2}} dz dy dx = \frac{4}{3} \pi.$

Therefore, the hypervolume of the unit 4-sphere should be:

$$V_{\text{hyper}} = 16 \int_0^1 \int_0^{\sqrt{1-x^2}} \int_0^{\sqrt{1-x^2-y^2}} \int_0^{\sqrt{1-x^2-y^2-z^2}} dw dz dy dx.$$

Mathematica is able to handle this integral, but we'll use the brute force approach.

$$\begin{aligned}
 V_{\text{hyper}} &= 16 \int_0^1 \int_0^{\sqrt{1-x^2}} \int_0^{\sqrt{1-x^2-y^2}} \int_a^{\sqrt{1-x^2-y^2-z^2}} dw dz dy dx = 16 \int_0^1 \int_0^{\sqrt{1-x^2}} \int_0^{\sqrt{1-x^2-y^2}} \sqrt{1-x^2-y^2-z^2} dz dy dx \\
 &= 16 \int_0^1 \int_0^{\sqrt{1-x^2}} \int_0^{\sqrt{1-x^2-y^2}} \sqrt{1-x^2-y^2} \sqrt{1-\frac{z^2}{1-x^2-y^2}} dz dy dx; \left[\begin{array}{l} \frac{z}{\sqrt{1-x^2-y^2}} = \cos \theta \\ dz = -\sqrt{1-x^2-y^2} \sin \theta d\theta \end{array} \right] \\
 &= 16 \int_0^1 \int_0^{\sqrt{1-x^2}} (1-x^2-y^2) \int_{\pi/2}^0 \left(-\sqrt{1-\cos^2 \theta} \sin \theta \right) d\theta dy dx = 16 \int_0^1 \int_0^{\sqrt{1-x^2}} (1-x^2-y^2) \int_{\pi/2}^0 \left(-\sin^2 \theta \right) d\theta dy dx \\
 &= 16 \int_0^1 \int_0^{\sqrt{1-x^2}} \frac{\pi}{4} (1-x^2-y^2) dy dx = 4\pi \int_0^1 \left(\sqrt{1-x^2} - x^2 \sqrt{1-x^2} - \frac{1}{3} (1-x^2)^{3/2} \right) dx \\
 &= 4\pi \int_0^1 \sqrt{1-x^2} \left[(1-x^2) - \frac{1-x^3}{3} \right] dx = \frac{8}{3} \pi \int_0^1 (1-x^2)^{3/2} dx; \left[\begin{array}{l} x = \cos \theta \\ dx = -\sin \theta d\theta \end{array} \right] \\
 &= -\frac{8}{3} \pi \int_{\pi/2}^0 \sin^4 \theta d\theta = -\frac{8}{3} \pi \int_{\pi/2}^0 \left(\frac{1-\cos 2\theta}{2} \right)^2 d\theta = -\frac{2}{3} \pi \int_{\pi/2}^0 (1-2\cos 2\theta + \cos^2 2\theta) d\theta \\
 &= -\frac{2}{3} \pi \int_{\pi/2}^0 \left(\frac{3}{2} - 2\cos 2\theta + \frac{\cos 4\theta}{2} \right) d\theta = \frac{\pi^2}{2}
 \end{aligned}$$

CHAPTER 16 INTEGRALS AND VECTOR FIELDS

16.1 LINE INTEGRALS

1. $\mathbf{r} = t\mathbf{i} + (1-t)\mathbf{j} \Rightarrow x = t$ and $y = 1-t \Rightarrow y = 1-x \Rightarrow (c)$
2. $\mathbf{r} = \mathbf{i} + \mathbf{j} + t\mathbf{k} \Rightarrow x = 1, y = 1,$ and $z = t \Rightarrow (e)$
3. $\mathbf{r} = (2 \cos t)\mathbf{i} + (2 \sin t)\mathbf{j} \Rightarrow x = 2 \cos t$ and $y = 2 \sin t \Rightarrow x^2 + y^2 = 4 \Rightarrow (g)$
4. $\mathbf{r} = t\mathbf{i} \Rightarrow x = t, y = 0,$ and $z = 0 \Rightarrow (a)$
5. $\mathbf{r} = t\mathbf{i} + t\mathbf{j} + t\mathbf{k} \Rightarrow x = t, y = t,$ and $z = t \Rightarrow (d)$
6. $\mathbf{r} = t\mathbf{j} + (2-2t)\mathbf{k} \Rightarrow y = t$ and $z = 2-2t \Rightarrow z = 2-2y \Rightarrow (b)$
7. $\mathbf{r} = (t^2 - 1)\mathbf{j} + 2t\mathbf{k} \Rightarrow y = t^2 - 1$ and $z = 2t \Rightarrow y = \frac{z^2}{4} - 1 \Rightarrow (f)$
8. $\mathbf{r} = (2 \cos t)\mathbf{i} + (2 \sin t)\mathbf{k} \Rightarrow x = 2 \cos t$ and $z = 2 \sin t \Rightarrow x^2 + z^2 = 4 \Rightarrow (h)$
9. $\mathbf{r}(t) = t\mathbf{i} + (1-t)\mathbf{j}, 0 \leq t \leq 1 \Rightarrow \frac{d\mathbf{r}}{dt} = \mathbf{i} - \mathbf{j} \Rightarrow \left| \frac{d\mathbf{r}}{dt} \right| = \sqrt{2}; x = t$ and $y = 1-t \Rightarrow x + y = t + (1-t) = 1$
 $\Rightarrow \int_C f(x, y, z) ds = \int_0^1 f(t, 1-t, 0) \left| \frac{d\mathbf{r}}{dt} \right| dt = \int_0^1 (1)(\sqrt{2}) dt = \left[\sqrt{2}t \right]_0^1 = \sqrt{2}$
10. $\mathbf{r}(t) = t\mathbf{i} + (1-t)\mathbf{j} + \mathbf{k}, 0 \leq t \leq 1 \Rightarrow \frac{d\mathbf{r}}{dt} = \mathbf{i} - \mathbf{j} \Rightarrow \left| \frac{d\mathbf{r}}{dt} \right| = \sqrt{2}; x = t, y = 1-t,$ and $z = 1 \Rightarrow x - y + z - 2$
 $= t - (1-t) + 1 - 2 = 2t - 2 \Rightarrow \int_C f(x, y, z) ds = \int_0^1 (2t - 2)\sqrt{2} dt = \sqrt{2} \left[t^2 - 2t \right]_0^1 = -\sqrt{2}$
11. $\mathbf{r}(t) = 2t\mathbf{i} + t\mathbf{j} + (2-2t)\mathbf{k}, 0 \leq t \leq 1 \Rightarrow \frac{d\mathbf{r}}{dt} = 2\mathbf{i} + \mathbf{j} - 2\mathbf{k} \Rightarrow \left| \frac{d\mathbf{r}}{dt} \right| = \sqrt{4+1+4} = 3; xy + y + z = (2t)t + t + (2-2t)$
 $\Rightarrow \int_C f(x, y, z) ds = \int_0^1 (2t^2 - t + 2) 3 dt = 3 \left[\frac{2}{3}t^3 - \frac{1}{2}t^2 + 2t \right]_0^1 = 3 \left(\frac{2}{3} - \frac{1}{2} + 2 \right) = \frac{13}{2}$
12. $\mathbf{r}(t) = (4 \cos t)\mathbf{i} + (4 \sin t)\mathbf{j} + 3t\mathbf{k}, -2\pi \leq t \leq 2\pi \Rightarrow \frac{d\mathbf{r}}{dt} = (-4 \sin t)\mathbf{i} + (4 \cos t)\mathbf{j} + 3\mathbf{k}$
 $\Rightarrow \left| \frac{d\mathbf{r}}{dt} \right| = \sqrt{16 \sin^2 t + 16 \cos^2 t + 9} = 5; \sqrt{x^2 + y^2} = \sqrt{16 \cos^2 t + 16 \sin^2 t} = 4 \Rightarrow \int_C f(x, y, z) ds = \int_{-2\pi}^{2\pi} (4)(5) dt$
 $= \left[20t \right]_{-2\pi}^{2\pi} = 80\pi$
13. $\mathbf{r}(t) = (\mathbf{i} + 2\mathbf{j} + 3\mathbf{k}) + t(-\mathbf{i} - 3\mathbf{j} - 2\mathbf{k}) = (1-t)\mathbf{i} + (2-3t)\mathbf{j} + (3-2t)\mathbf{k}, 0 \leq t \leq 1 \Rightarrow \frac{d\mathbf{r}}{dt} = -\mathbf{i} - 3\mathbf{j} - 2\mathbf{k}$
 $\Rightarrow \left| \frac{d\mathbf{r}}{dt} \right| = \sqrt{1+9+4} = \sqrt{14}; x + y + z = (1-t) + (2-3t) + (3-2t) = 6-6t \Rightarrow \int_C f(x, y, z) ds$
 $= \int_0^1 (6-6t) \sqrt{14} dt = 6\sqrt{14} \left[t - \frac{t^2}{2} \right]_0^1 = (6\sqrt{14}) \left(\frac{1}{2} \right) = 3\sqrt{14}$

14. $\mathbf{r}(t) = t\mathbf{i} + t\mathbf{j} + t\mathbf{k}, 1 \leq t \leq \infty \Rightarrow \frac{d\mathbf{r}}{dt} = \mathbf{i} + \mathbf{j} + \mathbf{k} \Rightarrow \left| \frac{d\mathbf{r}}{dt} \right| = \sqrt{3}; \frac{\sqrt{3}}{x^2+y^2+z^2} = \frac{\sqrt{3}}{t^2+t^2+t^2} = \frac{\sqrt{3}}{3t^2}$
 $\Rightarrow \int_C f(x, y, z) ds = \int_1^\infty \left(\frac{\sqrt{3}}{3t^2} \right) \sqrt{3} dt = \left[-\frac{1}{t} \right]_1^\infty = \lim_{b \rightarrow \infty} \left(-\frac{1}{b} + 1 \right) = 1$

15. $C_1: \mathbf{r}(t) = t\mathbf{i} + t^2\mathbf{j}, 0 \leq t \leq 1 \Rightarrow \frac{d\mathbf{r}}{dt} = \mathbf{i} + 2t\mathbf{j} \Rightarrow \left| \frac{d\mathbf{r}}{dt} \right| = \sqrt{1+4t^2}; x + \sqrt{y} - z^2 = t + \sqrt{t^2} - 0 = t + |t| = 2t$ since $t \geq 0 \Rightarrow \int_{C_1} f(x, y, z) ds = \int_0^1 2t\sqrt{1+4t^2} dt = \left[\frac{1}{6}(1+4t^2)^{3/2} \right]_0^1 = \frac{1}{6}(5)^{3/2} - \frac{1}{6} = \frac{1}{6}(5\sqrt{5} - 1);$

$C_2: \mathbf{r}(t) = \mathbf{i} + \mathbf{j} + t\mathbf{k}, 0 \leq t \leq 1 \Rightarrow \frac{d\mathbf{r}}{dt} = \mathbf{k} \Rightarrow \left| \frac{d\mathbf{r}}{dt} \right| = 1; x + \sqrt{y} - z^2 = 1 + \sqrt{1} - t^2 = 2 - t^2$
 $\Rightarrow \int_{C_2} f(x, y, z) ds = \int_0^1 (2 - t^2)(1) dt = \left[2t - \frac{1}{3}t^3 \right]_0^1 = 2 - \frac{1}{3} = \frac{5}{3};$

therefore $\int_C f(x, y, z) ds = \int_{C_1} f(x, y, z) ds + \int_{C_2} f(x, y, z) ds = \frac{5}{6}\sqrt{5} + \frac{5}{3}$

16. $C_1: \mathbf{r}(t) = t\mathbf{k}, 0 \leq t \leq 1 \Rightarrow \frac{d\mathbf{r}}{dt} = \mathbf{k} \Rightarrow \left| \frac{d\mathbf{r}}{dt} \right| = 1; x + \sqrt{y} - z^2 = 0 + \sqrt{0} - t^2 = -t^2$
 $\Rightarrow \int_{C_1} f(x, y, z) ds = \int_0^1 (-t^2)(1) dt = \left[-\frac{t^3}{3} \right]_0^1 = -\frac{1}{3};$

$C_2: \mathbf{r}(t) = t\mathbf{j} + \mathbf{k}, 0 \leq t \leq 1 \Rightarrow \frac{d\mathbf{r}}{dt} = \mathbf{j} \Rightarrow \left| \frac{d\mathbf{r}}{dt} \right| = 1; x + \sqrt{y} - z^2 = 0 + \sqrt{t} - 1 = \sqrt{t} - 1$
 $\Rightarrow \int_{C_2} f(x, y, z) ds = \int_0^1 (\sqrt{t} - 1)(1) dt = \left[\frac{2}{3}t^{3/2} - t \right]_0^1 = \frac{2}{3} - 1 = -\frac{1}{3};$

$C_3: \mathbf{r}(t) = t\mathbf{i} + \mathbf{j} + \mathbf{k}, 0 \leq t \leq 1 \Rightarrow \frac{d\mathbf{r}}{dt} = \mathbf{i} \Rightarrow \left| \frac{d\mathbf{r}}{dt} \right| = 1; x + \sqrt{y} - z^2 = t + \sqrt{1} - 1 = t$
 $\Rightarrow \int_{C_3} f(x, y, z) ds = \int_0^1 (t)(1) dt = \left[\frac{t^2}{2} \right]_0^1 = \frac{1}{2}$

$\Rightarrow \int_C f(x, y, z) ds = \int_{C_1} f ds + \int_{C_2} f ds + \int_{C_3} f ds = -\frac{1}{3} + \left(-\frac{1}{3}\right) + \frac{1}{2} = -\frac{1}{6}$

17. $\mathbf{r}(t) = t\mathbf{i} + t\mathbf{j} + t\mathbf{k}, 0 < a \leq t \leq b \Rightarrow \frac{d\mathbf{r}}{dt} = \mathbf{i} + \mathbf{j} + \mathbf{k} \Rightarrow \left| \frac{d\mathbf{r}}{dt} \right| = \sqrt{3}; \frac{x+y+z}{x^2+y^2+z^2} = \frac{t+t+t}{t^2+t^2+t^2} = \frac{1}{t}$
 $\Rightarrow \int_C f(x, y, z) ds = \int_a^b \left(\frac{1}{t} \right) \sqrt{3} dt = \left[\sqrt{3} \ln |t| \right]_a^b = \sqrt{3} \ln \left(\frac{b}{a} \right),$ since $0 < a \leq b$

18. $\mathbf{r}(t) = (a \cos t)\mathbf{j} + (a \sin t)\mathbf{k}, 0 \leq t \leq 2\pi \Rightarrow \frac{d\mathbf{r}}{dt} = (-a \sin t)\mathbf{j} + (a \cos t)\mathbf{k} \Rightarrow \left| \frac{d\mathbf{r}}{dt} \right| = \sqrt{a^2 \sin^2 t + a^2 \cos^2 t} = |a|;$
 $-\sqrt{x^2 + z^2} = -\sqrt{0 + a^2 \sin^2 t} = \begin{cases} -|a| \sin t, & 0 \leq t \leq \pi \\ |a| \sin t, & \pi \leq t \leq 2\pi \end{cases} \Rightarrow \int_C f(x, y, z) ds = \int_0^\pi -|a|^2 \sin t dt + \int_\pi^{2\pi} |a|^2 \sin t dt$
 $= \left[a^2 \cos t \right]_0^\pi - \left[a^2 \cos t \right]_\pi^{2\pi} = \left[a^2(-1) - a^2 \right] - \left[a^2 - a^2(-1) \right] = -4a^2$

19. (a) $\mathbf{r}(t) = t\mathbf{i} + \frac{1}{2}t\mathbf{j}, 0 \leq t \leq 4 \Rightarrow \frac{d\mathbf{r}}{dt} = \mathbf{i} + \frac{1}{2}\mathbf{j} \Rightarrow \left| \frac{d\mathbf{r}}{dt} \right| = \frac{\sqrt{5}}{2} \Rightarrow \int_C x ds = \int_0^4 t \frac{\sqrt{5}}{2} dt = \frac{\sqrt{5}}{2} \int_0^4 t dt = \left[\frac{\sqrt{5}}{4} t^2 \right]_0^4 = 4\sqrt{5}$

(b) $\mathbf{r}(t) = t\mathbf{i} + t^2\mathbf{j}, 0 \leq t \leq 2 \Rightarrow \frac{d\mathbf{r}}{dt} = \mathbf{i} + 2t\mathbf{j} \Rightarrow \left| \frac{d\mathbf{r}}{dt} \right| = \sqrt{1+4t^2} \Rightarrow \int_C x ds = \int_0^2 t\sqrt{1+4t^2} dt$
 $= \left[\frac{1}{12}(1+4t^2)^{3/2} \right]_0^2 = \frac{17\sqrt{17}-1}{12}$

20. (a) $\mathbf{r}(t) = t\mathbf{i} + 4t\mathbf{j}, 0 \leq t \leq 1 \Rightarrow \frac{d\mathbf{r}}{dt} = \mathbf{i} + 4\mathbf{j} \Rightarrow \left| \frac{d\mathbf{r}}{dt} \right| = \sqrt{17} \Rightarrow \int_C \sqrt{x+2y} \, ds = \int_0^1 \sqrt{t+2(4t)} \sqrt{17} \, dt$
 $= \sqrt{17} \int_0^1 \sqrt{9t} \, dt = 3\sqrt{17} \int_0^1 \sqrt{t} \, dt = \left[2\sqrt{17} t^{2/3} \right]_0^1 = 2\sqrt{17}$
- (b) $C_1 : \mathbf{r}(t) = t\mathbf{i}, 0 \leq t \leq 1 \Rightarrow \frac{d\mathbf{r}}{dt} = \mathbf{i} \Rightarrow \left| \frac{d\mathbf{r}}{dt} \right| = 1; C_2 : \mathbf{r}(t) = \mathbf{i} + t\mathbf{j}, 0 \leq t \leq 1 \Rightarrow \frac{d\mathbf{r}}{dt} = \mathbf{j} \Rightarrow \left| \frac{d\mathbf{r}}{dt} \right| = 1$
 $\int_C \sqrt{x+2y} \, ds = \int_{C_1} \sqrt{x+2y} \, ds + \int_{C_2} \sqrt{x+2y} \, ds = \int_0^1 \sqrt{t+2(0)} \, dt + \int_0^1 \sqrt{1+2(t)} \, dt$
 $= \int_0^1 \sqrt{t} \, dt + \int_0^1 \sqrt{1+2t} \, dt = \left[\frac{2}{3} t^{2/3} \right]_0^1 + \left[\frac{1}{3} (1+2t)^{2/3} \right]_0^1 = \frac{2}{3} + \left(\frac{5\sqrt{5}}{3} - \frac{1}{3} \right) = \frac{5\sqrt{5}+1}{3}$
21. $\mathbf{r}(t) = 4t\mathbf{i} - 3t\mathbf{j}, -1 \leq t \leq 2 \Rightarrow \frac{d\mathbf{r}}{dt} = 4\mathbf{i} - 3\mathbf{j} \Rightarrow \left| \frac{d\mathbf{r}}{dt} \right| = 5 \Rightarrow \int_C ye^{x^2} \, ds = \int_{-1}^2 (-3t) e^{(4t)^2} \cdot 5 \, dt$
 $= -15 \int_{-1}^2 t e^{16t^2} \, dt = \left[-\frac{15}{32} e^{16t^2} \right]_{-1}^2 = -\frac{15}{32} e^{64} + \frac{15}{32} e^{16} = \frac{15}{32} (e^{16} - e^{64})$
22. $\mathbf{r}(t) = (\cos t)\mathbf{i} + (\sin t)\mathbf{j}, 0 \leq t \leq 2\pi \Rightarrow \frac{d\mathbf{r}}{dt} = (-\sin t)\mathbf{i} + (\cos t)\mathbf{j} \Rightarrow \left| \frac{d\mathbf{r}}{dt} \right| = \sqrt{\sin^2 t + \cos^2 t} = 1$
 $\Rightarrow \int_C (x-y+3) \, ds = \int_0^{2\pi} (\cos t - \sin t + 3) \cdot 1 \, dt = [\sin t + \cos t + 3t]_0^{2\pi} = 6\pi$
23. $\mathbf{r}(t) = t^2\mathbf{i} + t^3\mathbf{j}, 1 \leq t \leq 2 \Rightarrow \frac{d\mathbf{r}}{dt} = 2t\mathbf{i} + 3t^2\mathbf{j} \Rightarrow \left| \frac{d\mathbf{r}}{dt} \right| = \sqrt{(2t)^2 + (3t^2)^2} = t\sqrt{4+9t^2}$
 $\Rightarrow \int_C \frac{x^2}{y^{4/3}} \, ds = \int_1^2 \frac{(t^2)^2}{(t^3)^{4/3}} \cdot t\sqrt{4+9t^2} \, dt = \int_1^2 t\sqrt{4+9t^2} \, dt = \left[\frac{1}{27} (4+9t^2)^{3/2} \right]_1^2 = \frac{80\sqrt{10}-13\sqrt{13}}{27}$
24. $\mathbf{r}(t) = t^3\mathbf{i} + t^4\mathbf{j}, \frac{1}{2} \leq t \leq 1 \Rightarrow \frac{d\mathbf{r}}{dt} = 3t^2\mathbf{i} + 4t^3\mathbf{j} \Rightarrow \left| \frac{d\mathbf{r}}{dt} \right| = \sqrt{(3t^2)^2 + (4t^3)^2} = t^2\sqrt{9+16t^2}$
 $\Rightarrow \int_C \frac{\sqrt{y}}{x} \, ds = \int_{1/2}^1 \frac{\sqrt{t^4}}{t^3} \cdot t^2\sqrt{9+16t^2} \, dt = \int_{1/2}^1 t\sqrt{9+16t^2} \, dt = \left[\frac{1}{48} (9+16t^2)^{3/2} \right]_{1/2}^1 = \frac{125-13\sqrt{13}}{48}$
25. $C_1 : \mathbf{r}(t) = t\mathbf{i} + t^2\mathbf{j}, 0 \leq t \leq 1 \Rightarrow \frac{d\mathbf{r}}{dt} = \mathbf{i} + 2t\mathbf{j} \Rightarrow \left| \frac{d\mathbf{r}}{dt} \right| = \sqrt{1+4t^2}; C_2 : \mathbf{r}(t) = (1-t)\mathbf{i} + (1-t)\mathbf{j}, 0 \leq t \leq 1$
 $\Rightarrow \frac{d\mathbf{r}}{dt} = -\mathbf{i} - \mathbf{j} \Rightarrow \left| \frac{d\mathbf{r}}{dt} \right| = \sqrt{2} \Rightarrow \int_C (x+\sqrt{y}) \, ds = \int_{C_1} (x+\sqrt{y}) \, ds + \int_{C_2} (x+\sqrt{y}) \, ds$
 $= \int_0^1 (t+\sqrt{t^2}) \sqrt{1+4t^2} \, dt + \int_0^1 ((1-t)+\sqrt{1-t}) \sqrt{2} \, dt = \int_0^1 2t\sqrt{1+4t^2} \, dt + \int_0^1 (1-t+\sqrt{1-t}) \sqrt{2} \, dt$
 $= \left[\frac{1}{6} (1+4t^2)^{3/2} \right]_0^1 + \sqrt{2} \left[t - \frac{1}{2} t^2 - \frac{2}{3} (1-t)^{3/2} \right]_0^1 = \frac{5\sqrt{5}-1}{6} + \frac{7\sqrt{2}}{6} = \frac{5\sqrt{5}+7\sqrt{2}-1}{6}$
26. $C_1 : \mathbf{r}(t) = t\mathbf{i}, 0 \leq t \leq 1 \Rightarrow \frac{d\mathbf{r}}{dt} = \mathbf{i} \Rightarrow \left| \frac{d\mathbf{r}}{dt} \right| = 1; C_2 : \mathbf{r}(t) = \mathbf{i} + t\mathbf{j}, 0 \leq t \leq 1 \Rightarrow \frac{d\mathbf{r}}{dt} = \mathbf{j} \Rightarrow \left| \frac{d\mathbf{r}}{dt} \right| = 1;$
 $C_3 : \mathbf{r}(t) = (1-t)\mathbf{i} + \mathbf{j}, 0 \leq t \leq 1 \Rightarrow \frac{d\mathbf{r}}{dt} = -\mathbf{i} \Rightarrow \left| \frac{d\mathbf{r}}{dt} \right| = 1; C_4 : \mathbf{r}(t) = (1-t)\mathbf{j}, 0 \leq t \leq 1 \Rightarrow \frac{d\mathbf{r}}{dt} = -\mathbf{j} \Rightarrow \left| \frac{d\mathbf{r}}{dt} \right| = 1;$
 $\Rightarrow \int_C \frac{1}{x^2+y^2+1} \, ds = \int_{C_1} \frac{1}{x^2+y^2+1} \, ds + \int_{C_2} \frac{1}{x^2+y^2+1} \, ds + \int_{C_3} \frac{1}{x^2+y^2+1} \, ds + \int_{C_4} \frac{1}{x^2+y^2+1} \, ds$

$$\begin{aligned}
&= \int_0^1 \frac{dt}{t^2+1} + \int_0^1 \frac{dt}{t^2+2} + \int_0^1 \frac{dt}{(1-t)^2+2} + \int_0^1 \frac{dt}{(1-t)^2+1} \\
&= \left[\tan^{-1} t \right]_0^1 + \frac{1}{\sqrt{2}} \left[\tan^{-1} \left(\frac{t}{\sqrt{2}} \right) \right]_0^1 + \frac{1}{\sqrt{2}} \left[\tan^{-1} \left(\frac{1-t}{\sqrt{2}} \right) \right]_0^1 + \left[-\tan^{-1}(1-t) \right]_0^1 = \frac{\pi}{2} + \frac{2}{\sqrt{2}} \tan^{-1} \left(\frac{1}{\sqrt{2}} \right)
\end{aligned}$$

$$27. \quad \mathbf{r}(x) = x\mathbf{i} + y\mathbf{j} = x\mathbf{i} + \frac{x^2}{2}\mathbf{j}, 0 \leq x \leq 2 \Rightarrow \frac{d\mathbf{r}}{dx} = \mathbf{i} + x\mathbf{j} \Rightarrow \left| \frac{d\mathbf{r}}{dx} \right| = \sqrt{1+x^2}; f(x, y) = f\left(x, \frac{x^2}{2}\right) = \frac{x^3}{\left(\frac{x^2}{2}\right)} = 2x$$

$$\Rightarrow \int_C f \, ds = \int_0^2 (2x)\sqrt{1+x^2} \, dx = \left[\frac{2}{3}(1+x^2)^{3/2} \right]_0^2 = \frac{2}{3}(5^{3/2} - 1) = \frac{10\sqrt{5}-2}{3}$$

$$28. \quad \mathbf{r}(t) = (1-t)\mathbf{i} + \frac{1}{2}(1-t)^2\mathbf{j}, 0 \leq t \leq 1 \Rightarrow \left| \frac{d\mathbf{r}}{dt} \right| = \sqrt{1+(1-t)^2}; f(x, y) = f\left((1-t), \frac{1}{2}(1-t)^2\right) = \frac{(1-t) + \frac{1}{4}(1-t)^4}{\sqrt{1+(1-t)^2}}$$

$$\begin{aligned}
\Rightarrow \int_C f \, ds &= \int_0^1 \frac{(1-t) + \frac{1}{4}(1-t)^4}{\sqrt{1+(1-t)^2}} \sqrt{1+(1-t)^2} \, dt = \int_0^1 \left((1-t) + \frac{1}{4}(1-t)^4 \right) dt = \left[-\frac{1}{2}(1-t)^2 - \frac{1}{20}(1-t)^5 \right]_0^1 \\
&= 0 - \left(-\frac{1}{2} - \frac{1}{20} \right) = \frac{11}{20}
\end{aligned}$$

$$29. \quad \mathbf{r}(t) = (2 \cos t)\mathbf{i} + (2 \sin t)\mathbf{j}, 0 \leq t \leq \frac{\pi}{2} \Rightarrow \frac{d\mathbf{r}}{dt} = (-2 \sin t)\mathbf{i} + (2 \cos t)\mathbf{j} \Rightarrow \left| \frac{d\mathbf{r}}{dt} \right| = 2; f(x, y) = f(2 \cos t, 2 \sin t)$$

$$= 2 \cos t + 2 \sin t \Rightarrow \int_C f \, ds = \int_0^{\pi/2} (2 \cos t + 2 \sin t)(2) \, dt = [4 \sin t - 4 \cos t]_0^{\pi/2} = 4 - (-4) = 8$$

$$30. \quad \mathbf{r}(t) = (2 \sin t)\mathbf{i} + (2 \cos t)\mathbf{j}, 0 \leq t \leq \frac{\pi}{4} \Rightarrow \frac{d\mathbf{r}}{dt} = (2 \cos t)\mathbf{i} + (-2 \sin t)\mathbf{j} \Rightarrow \left| \frac{d\mathbf{r}}{dt} \right| = 2; f(x, y) = f(2 \sin t, 2 \cos t)$$

$$= 4 \sin^2 t - 2 \cos t \Rightarrow \int_C f \, ds = \int_0^{\pi/4} (4 \sin^2 t - 2 \cos t)(2) \, dt = [4t - 2 \sin 2t - 4 \sin t]_0^{\pi/4} = \pi - 2(1 + \sqrt{2})$$

$$31. \quad y = x^2, 0 \leq x \leq 2 \Rightarrow \mathbf{r}(t) = t\mathbf{i} + t^2\mathbf{j}, 0 \leq t \leq 2 \Rightarrow \frac{d\mathbf{r}}{dt} = \mathbf{i} + 2t\mathbf{j} \Rightarrow \left| \frac{d\mathbf{r}}{dt} \right| = \sqrt{1+4t^2} \Rightarrow A = \int_C f(x, y) \, ds$$

$$= \int_C (x + \sqrt{y}) \, ds = \int_0^2 (t + \sqrt{t^2}) \sqrt{1+4t^2} \, dt = \int_0^2 2t \sqrt{1+4t^2} \, dt = \left[\frac{1}{6}(1+4t^2)^{3/2} \right]_0^2 = \frac{17\sqrt{17}-1}{6}$$

$$32. \quad 2x + 3y = 6, 0 \leq x \leq 6 \Rightarrow \mathbf{r}(t) = t\mathbf{i} + \left(2 - \frac{2}{3}t\right)\mathbf{j}, 0 \leq t \leq 6 \Rightarrow \frac{d\mathbf{r}}{dt} = \mathbf{i} - \frac{2}{3}\mathbf{j} \Rightarrow \left| \frac{d\mathbf{r}}{dt} \right| = \frac{\sqrt{13}}{3} \Rightarrow A = \int_C f(x, y) \, ds$$

$$= \int_C (4 + 3x + 2y) \, ds = \int_0^6 \left(4 + 3t + 2\left(2 - \frac{2}{3}t\right) \right) \frac{\sqrt{13}}{3} \, dt = \frac{\sqrt{13}}{3} \int_0^6 \left(8 + \frac{5}{3}t \right) dt = \frac{\sqrt{13}}{3} \left[8t + \frac{5}{6}t^2 \right]_0^6 = 26\sqrt{13}$$

$$33. \quad \mathbf{r}(t) = (t^2 - 1)\mathbf{j} + 2t\mathbf{k}, 0 \leq t \leq 1 \Rightarrow \frac{d\mathbf{r}}{dt} = 2t\mathbf{j} + 2\mathbf{k} \Rightarrow \left| \frac{d\mathbf{r}}{dt} \right| = 2\sqrt{t^2+1}; M = \int_C \delta(x, y, z) \, ds = \int_0^1 \delta(t) \left(2\sqrt{t^2+1} \right) dt$$

$$= \int_0^1 \left(\frac{3}{2}t \right) \left(2\sqrt{t^2+1} \right) dt = \left[(t^2+1)^{3/2} \right]_0^1 = 2^{3/2} - 1 = 2\sqrt{2} - 1$$

34. $\mathbf{r}(t) = (t^2 - 1)\mathbf{j} + 2t\mathbf{k}, -1 \leq t \leq 1 \Rightarrow \frac{d\mathbf{r}}{dt} = 2t\mathbf{j} + 2\mathbf{k}$

$$\Rightarrow \left| \frac{d\mathbf{r}}{dt} \right| = 2\sqrt{t^2 + 1}; M = \int_C \delta(x, y, z) ds$$

$$= \int_{-1}^1 \left(15\sqrt{(t^2 - 1) + 2} \right) \left(2\sqrt{t^2 + 1} \right) dt$$

$$= \int_{-1}^1 30(t^2 + 1) dt = \left[30\left(\frac{t^3}{3} + t\right) \right]_{-1}^1 = 60\left(\frac{1}{3} + 1\right) = 80;$$

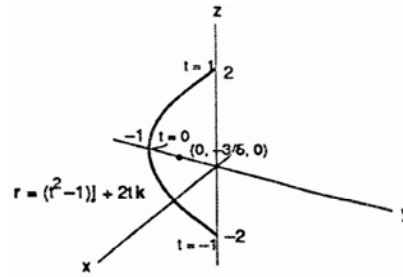

$$M_{xz} = \int_C y\delta(x, y, z) ds = \int_{-1}^1 (t^2 - 1) \left[30(t^2 + 1) \right] dt$$

$$= \int_{-1}^1 30(t^4 - 1) dt = \left[30\left(\frac{t^5}{5} - t\right) \right]_{-1}^1 = 60\left(\frac{1}{5} - 1\right) = -48 \Rightarrow \bar{y} = \frac{M_{xz}}{M} = -\frac{48}{80} = -\frac{3}{5};$$

$$M_{yz} = \int_C x\delta(x, y, z) ds = \int_C 0\delta ds = 0 \Rightarrow \bar{x} = 0; \bar{z} = 0 \text{ by symmetry (since } \delta \text{ is independent of } z) \Rightarrow (\bar{x}, \bar{y}, \bar{z}) = \left(0, -\frac{3}{5}, 0\right)$$

35. $\mathbf{r}(t) = \sqrt{2}t\mathbf{i} + \sqrt{2}t\mathbf{j} + (4 - t^2)\mathbf{k}, 0 \leq t \leq 1 \Rightarrow \frac{d\mathbf{r}}{dt} = \sqrt{2}\mathbf{i} + \sqrt{2}\mathbf{j} - 2t\mathbf{k} \Rightarrow \left| \frac{d\mathbf{r}}{dt} \right| = \sqrt{2 + 2 + 4t^2} = 2\sqrt{1 + t^2};$

(a) $M = \int_C \delta ds = \int_0^1 (3t) \left(2\sqrt{1 + t^2} \right) dt = \left[2(1 + t^2)^{3/2} \right]_0^1 = 2(2^{3/2} - 1) = 4\sqrt{2} - 2$

(b) $M = \int_C \delta ds = \int_0^1 (1) \left(2\sqrt{1 + t^2} \right) dt = \left[t\sqrt{1 + t^2} + \ln(t + \sqrt{1 + t^2}) \right]_0^1 = \left[\sqrt{2} + \ln(1 + \sqrt{2}) \right] - (0 + \ln 1)$
 $= \sqrt{2} + \ln(1 + \sqrt{2})$

36. $\mathbf{r}(t) = t\mathbf{i} + 2t\mathbf{j} + \frac{2}{3}t^{3/2}\mathbf{k}, 0 \leq t \leq 2 \Rightarrow \frac{d\mathbf{r}}{dt} = \mathbf{i} + 2\mathbf{j} + t^{1/2}\mathbf{k} \Rightarrow \left| \frac{d\mathbf{r}}{dt} \right| = \sqrt{1 + 4 + t} = \sqrt{5 + t};$

$$M = \int_C \delta ds = \int_0^2 (3\sqrt{5 + t})(\sqrt{5 + t}) dt = \int_0^2 3(5 + t) dt = \left[\frac{3}{2}(5 + t)^2 \right]_0^2 = \frac{3}{2}(7^2 - 5^2) = \frac{3}{2}(24) = 36;$$

$$M_{yz} = \int_C x\delta ds = \int_0^2 t[3(5 + t)] dt = \int_0^2 (15t + 3t^2) dt = \left[\frac{15}{2}t^2 + t^3 \right]_0^2 = 30 + 8 = 38;$$

$$M_{xz} = \int_C y\delta ds = \int_0^2 2t[3(5 + t)] dt = 2 \int_0^2 (15t + 3t^2) dt = 76; M_{xy} = \int_C z\delta ds = \int_0^2 \frac{2}{3}t^{3/2}[3(5 + t)] dt$$

$$= \int_0^2 (10t^{3/2} + 2t^{5/2}) dt = \left[4t^{5/2} + \frac{4}{7}t^{7/2} \right]_0^2 = 4(2)^{5/2} + \frac{4}{7}(2)^{7/2} = 16\sqrt{2} + \frac{32}{7}\sqrt{2} = \frac{144}{7}\sqrt{2}$$

$$\Rightarrow \bar{x} = \frac{M_{yz}}{M} = \frac{38}{36} = \frac{19}{18}, \bar{y} = \frac{M_{xz}}{M} = \frac{76}{36} = \frac{19}{9}, \text{ and } \bar{z} = \frac{M_{xy}}{M} = \frac{144\sqrt{2}}{7 \cdot 36} = \frac{4}{7}\sqrt{2}$$

37. Let $x = a \cos t$ and $y = a \sin t, 0 \leq t \leq 2\pi$. Then $\frac{dx}{dt} = -a \sin t, \frac{dy}{dt} = a \cos t, \frac{dz}{dt} = 0$

$$\Rightarrow \sqrt{\left(\frac{dx}{dt}\right)^2 + \left(\frac{dy}{dt}\right)^2 + \left(\frac{dz}{dt}\right)^2} dt = a dt; I_z = \int_C (x^2 + y^2) \delta ds = \int_0^{2\pi} (a^2 \sin^2 t + a^2 \cos^2 t) a \delta dt$$

$$= \int_0^{2\pi} a^3 \delta dt = 2\pi a^3.$$

38. $\mathbf{r}(t) = t\mathbf{j} + (2 - 2t)\mathbf{k}, 0 \leq t \leq 1 \Rightarrow \frac{d\mathbf{r}}{dt} = \mathbf{j} - 2\mathbf{k} \Rightarrow \left| \frac{d\mathbf{r}}{dt} \right| = \sqrt{5}; M = \int_C \delta ds = \int_0^1 \delta\sqrt{5} dt = \delta\sqrt{5};$

$$I_x = \int_C (y^2 + z^2) \delta ds = \int_0^1 [t^2 + (2 - 2t)^2] \delta\sqrt{5} dt = \int_0^1 (5t^2 - 8t + 4) \delta\sqrt{5} dt = \delta\sqrt{5} \left[\frac{5}{3}t^3 - 4t^2 + 4t \right]_0^1 = \frac{5}{3}\delta\sqrt{5};$$

$$I_y = \int_C (x^2 + z^2) \delta \, ds = \int_0^1 [0^2 + (2-2t)^2] \delta \sqrt{5} \, dt = \int_0^1 (4t^2 - 8t + 4) \delta \sqrt{5} \, dt = \delta \sqrt{5} \left[\frac{4}{3} t^3 - 4t^2 + 4t \right]_0^1 = \frac{4}{3} \delta \sqrt{5};$$

$$I_z = \int_C (x^2 + y^2) \delta \, ds = \int_0^1 (0^2 + t^2) \delta \sqrt{5} \, dt = \delta \sqrt{5} \left[\frac{t^3}{3} \right]_0^1 = \frac{1}{3} \delta \sqrt{5}$$

39. $\mathbf{r}(t) = (\cos t)\mathbf{i} + (\sin t)\mathbf{j} + t\mathbf{k}$, $0 \leq t \leq 2\pi \Rightarrow \frac{d\mathbf{r}}{dt} = (-\sin t)\mathbf{i} + (\cos t)\mathbf{j} + \mathbf{k} \Rightarrow \left| \frac{d\mathbf{r}}{dt} \right| = \sqrt{\sin^2 t + \cos^2 t + 1} = \sqrt{2};$

(a) $I_z = \int_C (x^2 + y^2) \delta \, ds = \int_0^{2\pi} (\cos^2 t + \sin^2 t) \delta \sqrt{2} \, dt = 2\pi \delta \sqrt{2}$

(b) $I_z = \int_C (x^2 + y^2) \delta \, ds = \int_0^{4\pi} \delta \sqrt{2} \, dt = 4\pi \delta \sqrt{2}$

40. $\mathbf{r}(t) = (t \cos t)\mathbf{i} + (t \sin t)\mathbf{j} + \frac{2\sqrt{2}}{3} t^{3/2} \mathbf{k}$, $0 \leq t \leq 1 \Rightarrow \frac{d\mathbf{r}}{dt} = (\cos t - t \sin t)\mathbf{i} + (\sin t + t \cos t)\mathbf{j} + \sqrt{2} t \mathbf{k}$

$$\Rightarrow \left| \frac{d\mathbf{r}}{dt} \right| = \sqrt{(t+1)^2} = t+1 \text{ for } 0 \leq t \leq 1; M = \int_C \delta \, ds = \int_0^1 (t+1) \, dt = \left[\frac{1}{2}(t+1)^2 \right]_0^1 = \frac{1}{2}(2^2 - 1^2) = \frac{3}{2};$$

$$M_{xy} = \int_C z \delta \, ds = \int_0^1 \left(\frac{2\sqrt{2}}{3} t^{3/2} \right) (t+1) \, dt = \frac{2\sqrt{2}}{3} \int_0^1 (t^{5/2} + t^{3/2}) \, dt = \frac{2\sqrt{2}}{3} \left[\frac{2}{7} t^{7/2} + \frac{2}{5} t^{5/2} \right]_0^1$$

$$= \frac{2\sqrt{2}}{3} \left(\frac{2}{7} + \frac{2}{5} \right) = \frac{2\sqrt{2}}{3} \left(\frac{24}{35} \right) = \frac{16\sqrt{2}}{35} \Rightarrow \bar{z} = \frac{M_{xy}}{M} = \left(\frac{16\sqrt{2}}{35} \right) \left(\frac{2}{3} \right) = \frac{32\sqrt{2}}{105};$$

$$I_z = \int_C (x^2 + y^2) \delta \, ds = \int_0^1 (t^2 \cos^2 t + t^2 \sin^2 t) (t+1) \, dt = \int_0^1 (t^3 + t^2) \, dt = \left[\frac{t^4}{4} + \frac{t^3}{3} \right]_0^1 = \frac{1}{4} + \frac{1}{3} = \frac{7}{12}$$

41. $\delta(x, y, z) = 2 - z$ and $\mathbf{r}(t) = (\cos t)\mathbf{j} + (\sin t)\mathbf{k}$, $0 \leq t \leq \pi \Rightarrow M = 2\pi - 2$ as found in Example 3 of the text; also

$$\left| \frac{d\mathbf{r}}{dt} \right| = 1; I_x = \int_C (y^2 + z^2) \delta \, ds = \int_0^\pi (\cos^2 t + \sin^2 t) (2 - \sin t) \, dt = \int_0^\pi (2 - \sin t) \, dt = 2\pi - 2$$

42. $\mathbf{r}(t) = t\mathbf{i} + \frac{2\sqrt{2}}{3} t^{3/2} \mathbf{j} + \frac{t^2}{2} \mathbf{k}$, $0 \leq t \leq 2 \Rightarrow \frac{d\mathbf{r}}{dt} = \mathbf{i} + \sqrt{2} t^{1/2} \mathbf{j} + t\mathbf{k} \Rightarrow \left| \frac{d\mathbf{r}}{dt} \right| = \sqrt{1 + 2t + t^2} = \sqrt{(1+t)^2} = 1+t$ for

$$0 \leq t \leq 2; M = \int_C \delta \, ds = \int_0^2 \left(\frac{1}{t+1} \right) (1+t) \, dt = \int_0^2 dt = 2; M_{yz} = \int_C x \delta \, ds = \int_0^2 t \left(\frac{1}{t+1} \right) (1+t) \, dt = \left[\frac{t^2}{2} \right]_0^2 = 2;$$

$$M_{xz} = \int_C y \delta \, ds = \int_0^2 \frac{2\sqrt{2}}{3} t^{3/2} \, dt = \left[\frac{4\sqrt{2}}{15} t^{5/2} \right]_0^2 = \frac{32}{15}; M_{xy} = \int_C z \delta \, ds = \int_0^2 \frac{t^2}{2} \, dt = \left[\frac{t^3}{6} \right]_0^2 = \frac{4}{3} \Rightarrow \bar{x} = \frac{M_{yz}}{M} = 1,$$

$$\bar{y} = \frac{M_{xz}}{M} = \frac{16}{15}, \text{ and } \bar{z} = \frac{M_{xy}}{M} = \frac{2}{3}; I_x = \int_C (y^2 + z^2) \delta \, ds = \int_0^2 \left(\frac{8}{9} t^3 + \frac{1}{4} t^4 \right) \, dt = \left[\frac{2}{9} t^4 + \frac{t^5}{20} \right]_0^2 = \frac{32}{9} + \frac{32}{20} = \frac{232}{45};$$

$$I_y = \int_C (x^2 + z^2) \delta \, ds = \int_0^2 \left(t^2 + \frac{1}{4} t^4 \right) \, dt = \left[\frac{t^3}{3} + \frac{t^5}{20} \right]_0^2 = \frac{8}{3} + \frac{32}{20} = \frac{64}{15};$$

$$I_z = \int_C (x^2 + y^2) \delta \, ds = \int_0^2 \left(t^2 + \frac{8}{9} t^3 \right) \, dt = \left[\frac{t^3}{3} + \frac{2}{9} t^4 \right]_0^2 = \frac{8}{3} + \frac{32}{9} = \frac{56}{9}$$

43-46. Example CAS commands:

Maple:

f:=(x,y,z) -> sqrt(1+30*x^2+10*y);

g:=t -> t;

h:=t -> t^2;

k:=t -> 3*t^2;

a,b:=0.2;

```

ds:=(D(g)^2+D(h)^2+D(k)^2)^(1/2); # (a)
'ds'=ds(t)*dt';
F:=f(g,h,k); # (b)
'F(t)'=F(t);
Int(f, s=C..NULL)=Int(simplify(F(t)*ds(t)), t=a..b); # (c)
`:=value(rhs(%));

```

Mathematica: (functions and domains may vary)

```

Clear[x, y, z, r, t, f]
f[x_, y_, z_]:=Sqrt(1+30x^2+10y)
{a, b}={0, 2};
x[t_]:=t
y[t_]:=t^2
z[t_]:=3t^2
r[t_]:={x[t], y[t], z[t]}
v[t_]:=D[r[t], t]
mag[vector_]:=Sqrt[vector.vector]
Integrate[f[x(t), y(t), z[t]] mag[v[t]], {t, a, b}]
N[%]

```

16.2 VECTOR FIELDS AND LINE INTEGRALS: WORK, CIRCULATION, AND FLUX

- $f(x, y, z) = (x^2 + y^2 + z^2)^{-1/2} \Rightarrow \frac{\partial f}{\partial x} = -\frac{1}{2}(x^2 + y^2 + z^2)^{-3/2} (2x) = -x(x^2 + y^2 + z^2)^{-3/2}$; similarly,
 $\frac{\partial f}{\partial y} = -y(x^2 + y^2 + z^2)^{-3/2}$ and $\frac{\partial f}{\partial z} = -z(x^2 + y^2 + z^2)^{-3/2} \Rightarrow \nabla f = \frac{-xi - yj - zk}{(x^2 + y^2 + z^2)^{3/2}}$
- $f(x, y, z) = \ln \sqrt{x^2 + y^2 + z^2} = \frac{1}{2} \ln(x^2 + y^2 + z^2) \Rightarrow \frac{\partial f}{\partial x} = \frac{1}{2} \left(\frac{1}{x^2 + y^2 + z^2} \right) (2x) = \frac{x}{x^2 + y^2 + z^2}$; similarly,
 $\frac{\partial f}{\partial y} = \frac{y}{x^2 + y^2 + z^2}$ and $\frac{\partial f}{\partial z} = \frac{z}{x^2 + y^2 + z^2} \Rightarrow \nabla f = \frac{xi + yj + zk}{x^2 + y^2 + z^2}$
- $g(x, y, z) = e^z - \ln(x^2 + y^2) \Rightarrow \frac{\partial g}{\partial x} = -\frac{2x}{x^2 + y^2}, \frac{\partial g}{\partial y} = -\frac{2y}{x^2 + y^2}$ and $\frac{\partial g}{\partial z} = e^z \Rightarrow \nabla g = \left(\frac{-2x}{x^2 + y^2} \right) \mathbf{i} - \left(\frac{2y}{x^2 + y^2} \right) \mathbf{j} + e^z \mathbf{k}$
- $g(x, y, z) = xy + yz + xz \Rightarrow \frac{\partial g}{\partial x} = y + z, \frac{\partial g}{\partial y} = x + z, \text{ and } \frac{\partial g}{\partial z} = y + x \Rightarrow \nabla g = (y + z)\mathbf{i} + (x + z)\mathbf{j} + (x + y)\mathbf{k}$
- $|\mathbf{F}|$ inversely proportional to the square of the distance from (x, y) to the origin $\Rightarrow \sqrt{(M(x, y))^2 + (N(x, y))^2} = \frac{k}{x^2 + y^2}, k > 0$; \mathbf{F} points toward the origin $\Rightarrow \mathbf{F}$ is in the direction of $\mathbf{n} = \frac{-x}{\sqrt{x^2 + y^2}} \mathbf{i} - \frac{y}{\sqrt{x^2 + y^2}} \mathbf{j} \Rightarrow \mathbf{F} = a\mathbf{n}$, for some constant $a > 0$. Then $M(x, y) = \frac{-ax}{\sqrt{x^2 + y^2}}$ and $N(x, y) = \frac{-ay}{\sqrt{x^2 + y^2}} \Rightarrow \sqrt{(M(x, y))^2 + (N(x, y))^2} = a \Rightarrow a = \frac{k}{x^2 + y^2} \Rightarrow \mathbf{F} = \frac{-kx}{(x^2 + y^2)^{3/2}} \mathbf{i} - \frac{ky}{(x^2 + y^2)^{3/2}} \mathbf{j}$, for any constant $k > 0$

6. Given $x^2 + y^2 = a^2 + b^2$, let $x = \sqrt{a^2 + b^2} \cos t$ and $y = -\sqrt{a^2 + b^2} \sin t$. Then
 $\mathbf{r} = \left(\sqrt{a^2 + b^2} \cos t\right)\mathbf{i} - \left(\sqrt{a^2 + b^2} \sin t\right)\mathbf{j}$ traces the circle in a clockwise direction as t goes from 0 to 2π
 $\Rightarrow \mathbf{v} = \left(-\sqrt{a^2 + b^2} \sin t\right)\mathbf{i} - \left(\sqrt{a^2 + b^2} \cos t\right)\mathbf{j}$ is tangent to the circle in a clockwise direction. Thus, let
 $\mathbf{F} = \mathbf{v} \Rightarrow \mathbf{F} = y\mathbf{i} - x\mathbf{j}$ and $\mathbf{F}(0, 0) = \mathbf{0}$.
7. Substitute the parametric representations for $\mathbf{r}(t) = x(t)\mathbf{i} + y(t)\mathbf{j} + z(t)\mathbf{k}$ representing each path into the vector field \mathbf{F} , and calculate $\int_C \mathbf{F} \cdot \frac{d\mathbf{r}}{dt} dt$.
- (a) $\mathbf{F} = 3t\mathbf{i} + 2t\mathbf{j} + 4t\mathbf{k}$ and $\frac{d\mathbf{r}}{dt} = \mathbf{i} + \mathbf{j} + \mathbf{k} \Rightarrow \mathbf{F} \cdot \frac{d\mathbf{r}}{dt} = 9t \Rightarrow \int_0^1 9t dt = \frac{9}{2}$
- (b) $\mathbf{F} = 3t^2\mathbf{i} + 2t\mathbf{j} + 4t^4\mathbf{k}$ and $\frac{d\mathbf{r}}{dt} = \mathbf{i} + 2t\mathbf{j} + 4t^3\mathbf{k} \Rightarrow \mathbf{F} \cdot \frac{d\mathbf{r}}{dt} = 7t^2 + 16t^7 \Rightarrow \int_0^1 (7t^2 + 16t^7) dt = \left[\frac{7}{3}t^3 + 2t^8\right]_0^1 = \frac{7}{3} + 2 = \frac{13}{3}$
- (c) $\mathbf{r}_1 = t\mathbf{i} + t\mathbf{j}$ and $\mathbf{r}_2 = \mathbf{i} + \mathbf{j} + t\mathbf{k}$; $\mathbf{F}_1 = 3t\mathbf{i} + 2t\mathbf{j}$ and $\frac{d\mathbf{r}_1}{dt} = \mathbf{i} + \mathbf{j} \Rightarrow \mathbf{F}_1 \cdot \frac{d\mathbf{r}_1}{dt} = 5t \Rightarrow \int_0^1 5t dt = \frac{5}{2}$;
 $\mathbf{F}_2 = 3\mathbf{i} + 2\mathbf{j} + 4t\mathbf{k}$ and $\frac{d\mathbf{r}_2}{dt} = \mathbf{k} \Rightarrow \mathbf{F}_2 \cdot \frac{d\mathbf{r}_2}{dt} = 4t \Rightarrow \int_0^1 4t dt = 2 \Rightarrow \frac{5}{2} + 2 = \frac{9}{2}$
8. Substitute the parametric representation for $\mathbf{r}(t) = x(t)\mathbf{i} + y(t)\mathbf{j} + z(t)\mathbf{k}$ representing each path into the vector field \mathbf{F} , and calculate $\int_C \mathbf{F} \cdot \frac{d\mathbf{r}}{dt} dt$.
- (a) $\mathbf{F} = \left(\frac{1}{t^2+1}\right)\mathbf{j}$ and $\frac{d\mathbf{r}}{dt} = \mathbf{i} + \mathbf{j} + \mathbf{k} \Rightarrow \mathbf{F} \cdot \frac{d\mathbf{r}}{dt} = \frac{1}{t^2+1} \Rightarrow \int_0^1 \frac{1}{t^2+1} dt = \left[\tan^{-1} t\right]_0^1 = \frac{\pi}{4}$
- (b) $\mathbf{F} = \left(\frac{1}{t^2+1}\right)\mathbf{j}$ and $\frac{d\mathbf{r}}{dt} = \mathbf{i} + 2t\mathbf{j} + 4t^3\mathbf{k} \Rightarrow \mathbf{F} \cdot \frac{d\mathbf{r}}{dt} = \frac{2t}{t^2+1} \Rightarrow \int_0^1 \frac{2t}{t^2+1} dt = \left[\ln(t^2+1)\right]_0^1 = \ln 2$
- (c) $\mathbf{r}_1 = t\mathbf{i} + t\mathbf{j}$ and $\mathbf{r}_2 = \mathbf{i} + \mathbf{j} + t\mathbf{k}$; $\mathbf{F}_1 = \left(\frac{1}{t^2+1}\right)\mathbf{j}$ and $\frac{d\mathbf{r}_1}{dt} = \mathbf{i} + \mathbf{j} \Rightarrow \mathbf{F}_1 \cdot \frac{d\mathbf{r}_1}{dt} = \frac{1}{t^2+1}$; $\mathbf{F}_2 = \frac{1}{2}\mathbf{j}$ and $\frac{d\mathbf{r}_2}{dt} = \mathbf{k} \Rightarrow \mathbf{F}_2 \cdot \frac{d\mathbf{r}_2}{dt} = 0 \Rightarrow \int_0^1 \frac{1}{t^2+1} dt = \frac{\pi}{4}$
9. Substitute the parametric representation for $\mathbf{r}(t) = x(t)\mathbf{i} + y(t)\mathbf{j} + z(t)\mathbf{k}$ representing each path into the vector field \mathbf{F} , and calculate $\int_C \mathbf{F} \cdot \frac{d\mathbf{r}}{dt} dt$.
- (a) $\mathbf{F} = \sqrt{t}\mathbf{i} - 2t\mathbf{j} + \sqrt{t}\mathbf{k}$ and $\frac{d\mathbf{r}}{dt} = \mathbf{i} + \mathbf{j} + \mathbf{k} \Rightarrow \mathbf{F} \cdot \frac{d\mathbf{r}}{dt} = 2\sqrt{t} - 2t \Rightarrow \int_0^1 (2\sqrt{t} - 2t) dt = \left[\frac{4}{3}t^{3/2} - t^2\right]_0^1 = \frac{1}{3}$
- (b) $\mathbf{F} = t^2\mathbf{i} - 2t\mathbf{j} + t\mathbf{k}$ and $\frac{d\mathbf{r}}{dt} = \mathbf{i} + 2t\mathbf{j} + 4t^3\mathbf{k} \Rightarrow \mathbf{F} \cdot \frac{d\mathbf{r}}{dt} = 4t^4 - 3t^2 \Rightarrow \int_0^1 (4t^4 - 3t^2) dt = \left[\frac{4}{5}t^5 - t^3\right]_0^1 = -\frac{1}{5}$
- (c) $\mathbf{r}_1 = t\mathbf{i} + t\mathbf{j}$ and $\mathbf{r}_2 = \mathbf{i} + \mathbf{j} + t\mathbf{k}$; $\mathbf{F}_1 = -2t\mathbf{j} + \sqrt{t}\mathbf{k}$ and $\frac{d\mathbf{r}_1}{dt} = \mathbf{i} + \mathbf{j} \Rightarrow \mathbf{F}_1 \cdot \frac{d\mathbf{r}_1}{dt} = -2t \Rightarrow \int_0^1 -2t dt = -1$;
 $\mathbf{F}_2 = \sqrt{t}\mathbf{i} - 2\mathbf{j} + \mathbf{k}$ and $\frac{d\mathbf{r}_2}{dt} = \mathbf{k} \Rightarrow \mathbf{F}_2 \cdot \frac{d\mathbf{r}_2}{dt} = 1 \Rightarrow \int_0^1 dt = 1 \Rightarrow -1 + 1 = 0$
10. Substitute the parametric representation for $\mathbf{r}(t) = x(t)\mathbf{i} + y(t)\mathbf{j} + z(t)\mathbf{k}$ representing each path into the vector field \mathbf{F} , and calculate $\int_C \mathbf{F} \cdot \frac{d\mathbf{r}}{dt} dt$.
- (a) $\mathbf{F} = t^2\mathbf{i} + t^2\mathbf{j} + t^2\mathbf{k}$ and $\frac{d\mathbf{r}}{dt} = \mathbf{i} + \mathbf{j} + \mathbf{k} \Rightarrow \mathbf{F} \cdot \frac{d\mathbf{r}}{dt} = 3t^2 \Rightarrow \int_0^1 3t^2 dt = 1$

$$(b) \quad \mathbf{F} = t^3\mathbf{i} - t^6\mathbf{j} + t^5\mathbf{k} \text{ and } \frac{d\mathbf{r}}{dt} = \mathbf{i} + 2t\mathbf{j} + 4t^3\mathbf{k} \Rightarrow \mathbf{F} \cdot \frac{d\mathbf{r}}{dt} = t^3 + 2t^7 + 4t^8 \Rightarrow \int_0^1 (t^3 + 2t^7 + 4t^8) dt \\ = \left[\frac{t^4}{4} + \frac{t^8}{4} + \frac{4}{9}t^9 \right]_0^1 = \frac{17}{18}$$

$$(c) \quad \mathbf{r}_1 = t\mathbf{i} + t\mathbf{j} \text{ and } \mathbf{r}_2 = \mathbf{i} + \mathbf{j} + t\mathbf{k}; \mathbf{F}_1 = t^2\mathbf{i} \text{ and } \frac{d\mathbf{r}_1}{dt} = \mathbf{i} + \mathbf{j} \Rightarrow \mathbf{F}_1 \cdot \frac{d\mathbf{r}_1}{dt} = t^2 \Rightarrow \int_0^1 t^2 dt = \frac{1}{3}; \\ \mathbf{F}_2 = \mathbf{i} + t\mathbf{j} + t\mathbf{k} \text{ and } \frac{d\mathbf{r}_2}{dt} = \mathbf{k} \Rightarrow \mathbf{F}_2 \cdot \frac{d\mathbf{r}_2}{dt} = t \Rightarrow \int_0^1 t dt = \frac{1}{2} \Rightarrow \frac{1}{3} + \frac{1}{2} = \frac{5}{6}$$

11. Substitute the parametric representation for $\mathbf{r}(t) = x(t)\mathbf{i} + y(t)\mathbf{j} + z(t)\mathbf{k}$ representing each path into the vector field \mathbf{F} , and calculate $\int_C \mathbf{F} \cdot \frac{d\mathbf{r}}{dt} dt$.

$$(a) \quad \mathbf{F} = (3t^2 - 3t)\mathbf{i} + 3t\mathbf{j} + \mathbf{k} \text{ and } \frac{d\mathbf{r}}{dt} = \mathbf{i} + \mathbf{j} + \mathbf{k} \Rightarrow \mathbf{F} \cdot \frac{d\mathbf{r}}{dt} = 3t^2 + 1 \Rightarrow \int_0^1 (3t^2 + 1) dt = \left[t^3 + t \right]_0^1 = 2$$

$$(b) \quad \mathbf{F} = (3t^2 - 3t)\mathbf{i} + 3t^4\mathbf{j} + \mathbf{k} \text{ and } \frac{d\mathbf{r}}{dt} = \mathbf{i} + 2t\mathbf{j} + 4t^3\mathbf{k} \Rightarrow \mathbf{F} \cdot \frac{d\mathbf{r}}{dt} = 6t^5 + 4t^3 + 3t^2 - 3t \\ \Rightarrow \int_0^1 (6t^5 + 4t^3 + 3t^2 - 3t) dt = \left[t^6 + t^4 + t^3 - \frac{3}{2}t^2 \right]_0^1 = \frac{3}{2}$$

$$(c) \quad \mathbf{r}_1 = t\mathbf{i} + t\mathbf{j} \text{ and } \mathbf{r}_2 = \mathbf{i} + \mathbf{j} + t\mathbf{k}; \mathbf{F}_1 = (3t^2 - 3t)\mathbf{i} + \mathbf{k} \text{ and } \frac{d\mathbf{r}_1}{dt} = \mathbf{i} + \mathbf{j} \Rightarrow \mathbf{F}_1 \cdot \frac{d\mathbf{r}_1}{dt} = 3t^2 - 3t \\ \Rightarrow \int_0^1 (3t^2 - 3t) dt = \left[t^3 - \frac{3}{2}t^2 \right]_0^1 = -\frac{1}{2}; \mathbf{F}_2 = 3t\mathbf{j} + \mathbf{k} \text{ and } \frac{d\mathbf{r}_2}{dt} = \mathbf{k} \Rightarrow \mathbf{F}_2 \cdot \frac{d\mathbf{r}_2}{dt} = 1 \Rightarrow \int_0^1 dt = 1 \Rightarrow -\frac{1}{2} + 1 = \frac{1}{2}$$

12. Substitute the parametric representation for $\mathbf{r}(t) = x(t)\mathbf{i} + y(t)\mathbf{j} + z(t)\mathbf{k}$ representing each path into the vector field \mathbf{F} , and calculate $\int_C \mathbf{F} \cdot \frac{d\mathbf{r}}{dt} dt$.

$$(a) \quad \mathbf{F} = 2t\mathbf{i} + 2t\mathbf{j} + 2t\mathbf{k} \text{ and } \frac{d\mathbf{r}}{dt} = \mathbf{i} + \mathbf{j} + \mathbf{k} \Rightarrow \mathbf{F} \cdot \frac{d\mathbf{r}}{dt} = 6t \Rightarrow \int_0^1 6t dt = \left[3t^2 \right]_0^1 = 3$$

$$(b) \quad \mathbf{F} = (t^2 + t^4)\mathbf{i} + (t^4 + t)\mathbf{j} + (t + t^2)\mathbf{k} \text{ and } \frac{d\mathbf{r}}{dt} = \mathbf{i} + 2t\mathbf{j} + 4t^3\mathbf{k} \Rightarrow \mathbf{F} \cdot \frac{d\mathbf{r}}{dt} = 6t^5 + 5t^4 + 3t^2 \\ \Rightarrow \int_0^1 (6t^5 + 5t^4 + 3t^2) dt = \left[t^6 + t^5 + t^3 \right]_0^1 = 3$$

$$(c) \quad \mathbf{r}_1 = t\mathbf{i} + t\mathbf{j} \text{ and } \mathbf{r}_2 = \mathbf{i} + \mathbf{j} + t\mathbf{k}; \mathbf{F}_1 = t\mathbf{i} + t\mathbf{j} + 2t\mathbf{k} \text{ and } \frac{d\mathbf{r}_1}{dt} = \mathbf{i} + \mathbf{j} \Rightarrow \mathbf{F}_1 \cdot \frac{d\mathbf{r}_1}{dt} = 2t \Rightarrow \int_0^1 2t dt = 1; \\ \mathbf{F}_2 = (1+t)\mathbf{i} + (t+1)\mathbf{j} + 2\mathbf{k} \text{ and } \frac{d\mathbf{r}_2}{dt} = \mathbf{k} \Rightarrow \mathbf{F}_2 \cdot \frac{d\mathbf{r}_2}{dt} = 2 \Rightarrow \int_0^1 2 dt = 2 \Rightarrow 1 + 2 = 3$$

$$13. \quad x = t, y = 2t + 1, 0 \leq t \leq 3 \Rightarrow dx = dt \Rightarrow \int_C (x - y) dx = \int_0^3 (t - (2t + 1)) dt = \int_0^3 (-t - 1) dt = \left[-\frac{1}{2}t^2 - t \right]_0^3 = -\frac{15}{2}$$

$$14. \quad x = t, y = t^2, 1 \leq t \leq 2 \Rightarrow dy = 2t dt \Rightarrow \int_C \frac{x}{y} dy = \int_1^2 \frac{t}{t^2} (2t) dt = \int_1^2 2 dt = [2t]_1^2 = 2$$

$$15. \quad C_1 : x = t, y = 0, 0 \leq t \leq 3 \Rightarrow dy = 0; C_2 : x = 3, y = t, 0 \leq t \leq 3 \Rightarrow dy = dt \Rightarrow \int_C (x^2 + y^2) dy \\ = \int_{C_1} (x^2 + y^2) dx + \int_{C_2} (x^2 + y^2) dx = \int_0^3 (t^2 + 0^2) \cdot 0 + \int_0^3 (3^2 + t^2) dt = \int_0^3 (9 + t^2) dt = \left[9t + \frac{1}{3}t^3 \right]_0^3 = 36$$

$$16. C_1 : x = t, y = 3t, 0 \leq t \leq 1 \Rightarrow dx = dt; C_2 : x = 1-t, y = 3, 0 \leq t \leq 1 \Rightarrow dx = -dt; C_3 : x = 0, y = 3-t, 0 \leq t \leq 3$$

$$\begin{aligned} &\Rightarrow dx = 0 \Rightarrow \int_C \sqrt{x+y} \, dx = \int_{C_1} \sqrt{x+y} \, dx + \int_{C_2} \sqrt{x+y} \, dx + \int_{C_3} \sqrt{x+y} \, dx \\ &= \int_0^1 \sqrt{t+3t} \, dt + \int_0^1 \sqrt{(1-t)+3(-1)} \, dt + \int_0^3 \sqrt{0+(3-t)} \cdot 0 = \int_0^1 2\sqrt{t} \, dt - \int_0^1 \sqrt{4-t} \, dt \\ &= \left[\frac{4}{3} t^{3/2} \right]_0^1 + \left[\frac{2}{3} (4-t)^{3/2} \right]_0^1 = \frac{4}{3} + \left(2\sqrt{3} - \frac{16}{3} \right) = 2\sqrt{3} - 4 \end{aligned}$$

$$17. \mathbf{r}(t) = t\mathbf{i} - \mathbf{j} + t^2\mathbf{k}, 0 \leq t \leq 1 \Rightarrow dx = dt, dy = 0, dz = 2t \, dt$$

$$(a) \int_C (x+y-z) \, dx = \int_0^1 (t-1-t^2) \, dt = \left[\frac{1}{2} t^2 - t - \frac{1}{3} t^3 \right]_0^1 = -\frac{5}{6}$$

$$(b) \int_C (x+y-z) \, dy = \int_0^1 (t-1-t^2) \cdot 0 = 0$$

$$(c) \int_C (x+y-z) \, dz = \int_0^1 (t-1-t^2) 2t \, dt = \int_0^1 (2t^2 - 2t - 2t^3) \, dt = \left[\frac{2}{3} t^3 - t^2 - \frac{1}{2} t^4 \right]_0^1 = -\frac{5}{6}$$

$$18. \mathbf{r}(t) = (\cos t)\mathbf{i} + (\sin t)\mathbf{j} - (\cos t)\mathbf{k}, 0 \leq t \leq \pi \Rightarrow dx = -\sin t \, dt, dy = \cos t \, dt, dz = \sin t \, dt$$

$$(a) \int_C xz \, dx = \int_0^\pi (\cos t)(-\cos t)(-\sin t) \, dt = \int_0^\pi \cos^2 t \sin t \, dt = \left[-\frac{1}{3} (\cos t)^3 \right]_0^\pi = \frac{2}{3}$$

$$(b) \int_C xz \, dy = \int_0^\pi (\cos t)(-\cos t)(\cos t) \, dt = -\int_0^\pi \cos^3 t \, dt = -\int_0^\pi (1-\sin^2 t) \cos t \, dt = \left[\frac{1}{3} (\sin t)^3 - \sin t \right]_0^\pi = 0$$

$$\begin{aligned} (c) \int_C xyz \, dz &= \int_0^\pi (\cos t)(\sin t)(-\cos t)(\sin t) \, dt = -\int_0^\pi \cos^2 t \sin^2 t \, dt = -\frac{1}{4} \int_0^\pi \sin^2 2t \, dt = -\frac{1}{4} \int_0^\pi \frac{1-\cos 4t}{2} \, dt \\ &= -\frac{1}{8} \int_0^\pi (1-\cos 4t) \, dt = \left[-\frac{1}{8} t + \frac{1}{32} \sin 4t \right]_0^\pi = -\frac{\pi}{8} \end{aligned}$$

$$19. \mathbf{r} = t\mathbf{i} + t^2\mathbf{j} + t\mathbf{k}, 0 \leq t \leq 1, \text{ and } \mathbf{F} = xy\mathbf{i} + y\mathbf{j} - yz\mathbf{k} \Rightarrow \mathbf{F} = t^3\mathbf{i} + t^2\mathbf{j} - t^3\mathbf{k} \text{ and } \frac{d\mathbf{r}}{dt} = \mathbf{i} + 2t\mathbf{j} + \mathbf{k}$$

$$\Rightarrow \mathbf{F} \cdot \frac{d\mathbf{r}}{dt} = 2t^3 \Rightarrow \text{work} = \int_0^1 2t^3 \, dt = \frac{1}{2}$$

$$20. \mathbf{r} = (\cos t)\mathbf{i} + (\sin t)\mathbf{j} + \frac{t}{6}\mathbf{k}, 0 \leq t \leq 2\pi, \text{ and } \mathbf{F} = 2y\mathbf{i} + 3x\mathbf{j} + (x+y)\mathbf{k}$$

$$\Rightarrow \mathbf{F} = (2 \sin t)\mathbf{i} + (3 \cos t)\mathbf{j} + (\cos t + \sin t)\mathbf{k} \text{ and } \frac{d\mathbf{r}}{dt} = (-\sin t)\mathbf{i} + (\cos t)\mathbf{j} + \frac{1}{6}\mathbf{k}$$

$$\Rightarrow \mathbf{F} \cdot \frac{d\mathbf{r}}{dt} = 3 \cos^2 t - 2 \sin^2 t + \frac{1}{6} \cos t + \frac{1}{6} \sin t \Rightarrow \text{work} = \int_0^{2\pi} \left(3 \cos^2 t - 2 \sin^2 t + \frac{1}{6} \cos t + \frac{1}{6} \sin t \right) dt$$

$$= \left[\frac{3}{2} t + \frac{3}{4} \sin 2t - t + \frac{\sin 2t}{2} + \frac{1}{6} \sin t - \frac{1}{6} \cos t \right]_0^{2\pi} = \pi$$

$$21. \mathbf{r} = (\sin t)\mathbf{i} + (\cos t)\mathbf{j} + t\mathbf{k}, 0 \leq t \leq 2\pi, \text{ and } \mathbf{F} = z\mathbf{i} + x\mathbf{j} + y\mathbf{k} \Rightarrow \mathbf{F} = t\mathbf{i} + (\sin t)\mathbf{j} + (\cos t)\mathbf{k} \text{ and}$$

$$\frac{d\mathbf{r}}{dt} = (\cos t)\mathbf{i} - (\sin t)\mathbf{j} + \mathbf{k} \Rightarrow \mathbf{F} \cdot \frac{d\mathbf{r}}{dt} = t \cos t - \sin^2 t + \cos t \Rightarrow \text{work} = \int_0^{2\pi} (t \cos t - \sin^2 t + \cos t) dt$$

$$= \left[\cos t + t \sin t - \frac{t}{2} + \frac{\sin 2t}{4} + \sin t \right]_0^{2\pi} = -\pi$$

22. $\mathbf{r} = (\sin t)\mathbf{i} + (\cos t)\mathbf{j} + \frac{1}{6}\mathbf{k}$, $0 \leq t \leq 2\pi$, and $\mathbf{F} = 6z\mathbf{i} + y^2\mathbf{j} + 12x\mathbf{k} \Rightarrow \mathbf{F} = t\mathbf{i} + (\cos^2 t)\mathbf{j} + (12 \sin t)\mathbf{k}$ and

$$\frac{d\mathbf{r}}{dt} = (\cos t)\mathbf{i} - (\sin t)\mathbf{j} + \frac{1}{6}\mathbf{k} \Rightarrow \mathbf{F} \cdot \frac{d\mathbf{r}}{dt} = t \cos t - \sin t \cos^2 t + 2 \sin t$$

$$\Rightarrow \text{work} = \int_0^{2\pi} (t \cos t - \sin t \cos^2 t + 2 \sin t) dt = \left[\cos t + t \sin t + \frac{1}{3} \cos^3 t - 2 \cos t \right]_0^{2\pi} = 0$$

23. $x = t$ and $y = x^2 = t^2 \Rightarrow \mathbf{r} = t\mathbf{i} + t^2\mathbf{j}$, $-1 \leq t \leq 2$, and $\mathbf{F} = xy\mathbf{i} + (x+y)\mathbf{j} \Rightarrow \mathbf{F} = t^3\mathbf{i} + (t+t^2)\mathbf{j}$ and

$$\frac{d\mathbf{r}}{dt} = \mathbf{i} + 2t\mathbf{j} \Rightarrow \mathbf{F} \cdot \frac{d\mathbf{r}}{dt} = t^3 + (2t^2 + 2t^3) = 3t^3 + 2t^2 \Rightarrow \int_C \mathbf{F} \cdot \frac{d\mathbf{r}}{dt} dt = \int_{-1}^2 (3t^3 + 2t^2) dt$$

$$= \left[\frac{3}{4}t^4 + \frac{2}{3}t^3 \right]_{-1}^2 = \left(12 + \frac{16}{3} \right) - \left(\frac{3}{4} - \frac{2}{3} \right) = \frac{45}{4} + \frac{18}{3} = \frac{69}{4}$$

24. Along (0,0) to (1,0): $\mathbf{r} = t\mathbf{i}$, $0 \leq t \leq 1$, and $\mathbf{F} = (x-y)\mathbf{i} + (x+y)\mathbf{j} \Rightarrow \mathbf{F} = t\mathbf{i} + t\mathbf{j}$ and $\frac{d\mathbf{r}}{dt} = \mathbf{i} \Rightarrow \mathbf{F} \cdot \frac{d\mathbf{r}}{dt} = t$;

Along (1,0) to (0,1): $\mathbf{r} = (1-t)\mathbf{i} + t\mathbf{j}$, $0 \leq t \leq 1$, and $\mathbf{F} = (x-y)\mathbf{i} + (x+y)\mathbf{j} \Rightarrow \mathbf{F} = (1-2t)\mathbf{i} + \mathbf{j}$ and

$$\frac{d\mathbf{r}}{dt} = -\mathbf{i} + \mathbf{j} \Rightarrow \mathbf{F} \cdot \frac{d\mathbf{r}}{dt} = 2t;$$

Along (0,1) to (0,0): $\mathbf{r} = (1-t)\mathbf{j}$, $0 \leq t \leq 1$, and $\mathbf{F} = (x-y)\mathbf{i} + (x+y)\mathbf{j} \Rightarrow \mathbf{F} = (t-1)\mathbf{i} + (1-t)\mathbf{j}$ and

$$\frac{d\mathbf{r}}{dt} = -\mathbf{j} \Rightarrow \mathbf{F} \cdot \frac{d\mathbf{r}}{dt} = t-1 \Rightarrow \int_C (x-y) dx + (x+y) dy = \int_0^1 t dt + \int_0^1 2t dt + \int_0^1 (t-1) dt = \int_0^1 (4t-1) dt$$

$$= \left[2t^2 - t \right]_0^1 = 2 - 1 = 1$$

25. $\mathbf{r} = x\mathbf{i} + y\mathbf{j} = y^2\mathbf{i} + y\mathbf{j}$, $2 \geq y \geq -1$, and $\mathbf{F} = x^2\mathbf{i} - y\mathbf{j} = y^4\mathbf{i} - y\mathbf{j} \Rightarrow \frac{d\mathbf{r}}{dy} = 2y\mathbf{i} + \mathbf{j}$ and $\mathbf{F} \cdot \frac{d\mathbf{r}}{dy} = 2y^5 - y$

$$\Rightarrow \int_C \mathbf{F} \cdot \mathbf{T} ds = \int_2^{-1} \mathbf{F} \cdot \frac{d\mathbf{r}}{dy} dy = \int_2^{-1} (2y^5 - y) dy = \left[\frac{1}{3}y^6 - \frac{1}{2}y^2 \right]_2^{-1} = \left(\frac{1}{3} - \frac{1}{2} \right) - \left(\frac{64}{3} - \frac{4}{2} \right) = \frac{3}{2} - \frac{63}{3} = -\frac{39}{2}$$

26. $\mathbf{r} = (\cos t)\mathbf{i} + (\sin t)\mathbf{j}$, $0 \leq t \leq \frac{\pi}{2}$, and $\mathbf{F} = y\mathbf{i} - x\mathbf{j} \Rightarrow \mathbf{F} = (\sin t)\mathbf{i} - (\cos t)\mathbf{j}$ and $\frac{d\mathbf{r}}{dt} = (-\sin t)\mathbf{i} + (\cos t)\mathbf{j}$

$$\Rightarrow \mathbf{F} \cdot \frac{d\mathbf{r}}{dt} = -\sin^2 t - \cos^2 t = -1 \Rightarrow \int_C \mathbf{F} \cdot d\mathbf{r} = \int_0^{\pi/2} (-1) dt = -\frac{\pi}{2}$$

27. $\mathbf{r} = (\mathbf{i} + \mathbf{j}) + t(\mathbf{i} + 2\mathbf{j}) = (1+t)\mathbf{i} + (1+2t)\mathbf{j}$, $0 \leq t \leq 1$, and $\mathbf{F} = xy\mathbf{i} + (y-x)\mathbf{j} \Rightarrow \mathbf{F} = (1+3t+2t^2)\mathbf{i} + t\mathbf{j}$ and

$$\frac{d\mathbf{r}}{dt} = \mathbf{i} + 2\mathbf{j} \Rightarrow \mathbf{F} \cdot \frac{d\mathbf{r}}{dt} = 1+5t+2t^2 \Rightarrow \text{work} = \int_C \mathbf{F} \cdot \frac{d\mathbf{r}}{dt} dt = \int_0^1 (1+5t+2t^2) dt = \left[t + \frac{5}{2}t^2 + \frac{2}{3}t^3 \right]_0^1 = \frac{25}{6}$$

28. $\mathbf{r} = (2 \cos t)\mathbf{i} + (2 \sin t)\mathbf{j}$, $0 \leq t \leq 2\pi$, and $\mathbf{F} = \nabla f = 2(x+y)\mathbf{i} + 2(x+y)\mathbf{j}$

$$\Rightarrow \mathbf{F} = 4(\cos t + \sin t)\mathbf{i} + 4(\cos t + \sin t)\mathbf{j} \text{ and } \frac{d\mathbf{r}}{dt} = (-2 \sin t)\mathbf{i} + (2 \cos t)\mathbf{j}$$

$$\Rightarrow \mathbf{F} \cdot \frac{d\mathbf{r}}{dt} = -8(\sin t \cos t + \sin^2 t) + 8(\cos^2 t + \cos t \sin t) = 8(\cos^2 t - \sin^2 t) = 8 \cos 2t$$

$$\Rightarrow \text{work} = \int_C \nabla f \cdot d\mathbf{r} = \int_C \mathbf{F} \cdot \frac{d\mathbf{r}}{dt} dt = \int_0^{2\pi} 8 \cos 2t dt = [4 \sin 2t]_0^{2\pi} = 0$$

29. (a) $\mathbf{r} = (\cos t)\mathbf{i} + (\sin t)\mathbf{j}$, $0 \leq t \leq 2\pi$, $\mathbf{F}_1 = x\mathbf{i} + y\mathbf{j}$, and $\mathbf{F}_2 = -y\mathbf{i} + x\mathbf{j} \Rightarrow \frac{d\mathbf{r}}{dt} = (-\sin t)\mathbf{i} + (\cos t)\mathbf{j}$,

$$\mathbf{F}_1 = (\cos t)\mathbf{i} + (\sin t)\mathbf{j}, \text{ and } \mathbf{F}_2 = (-\sin t)\mathbf{i} + (\cos t)\mathbf{j} \Rightarrow \mathbf{F}_1 \cdot \frac{d\mathbf{r}}{dt} = 0 \text{ and } \mathbf{F}_2 \cdot \frac{d\mathbf{r}}{dt} = \sin^2 t + \cos^2 t = 1$$

$$\Rightarrow \text{Circ}_1 = \int_0^{2\pi} 0 \, dt = 0 \text{ and } \text{Circ}_2 = \int_0^{2\pi} dt = 2\pi; \mathbf{n} = (\cos t)\mathbf{i} + (\sin t)\mathbf{j} \Rightarrow \mathbf{F}_1 \cdot \mathbf{n} = \cos^2 t + \sin^2 t = 1 \text{ and}$$

$$\mathbf{F}_2 \cdot \mathbf{n} = 0 \Rightarrow \text{Flux}_1 = \int_0^{2\pi} dt = 2\pi \text{ and } \text{Flux}_2 = \int_0^{2\pi} 0 \, dt = 0$$

(b) $\mathbf{r} = (\cos t)\mathbf{i} + (4 \sin t)\mathbf{j}, 0 \leq t \leq 2\pi \Rightarrow \frac{d\mathbf{r}}{dt} = (-\sin t)\mathbf{i} + (4 \cos t)\mathbf{j}, \mathbf{F}_1 = (\cos t)\mathbf{i} + (4 \sin t)\mathbf{j},$ and

$$\mathbf{F}_2 = (-4 \sin t)\mathbf{i} + (\cos t)\mathbf{j} \Rightarrow \mathbf{F}_1 \cdot \frac{d\mathbf{r}}{dt} = 15 \sin t \cos t \text{ and } \mathbf{F}_2 \cdot \frac{d\mathbf{r}}{dt} = 4 \Rightarrow \text{Circ}_1 = \int_0^{2\pi} 15 \sin t \cos t \, dt$$

$$= \left[\frac{15}{2} \sin^2 t \right]_0^{2\pi} = 0 \text{ and } \text{Circ}_2 = \int_0^{2\pi} 4 \, dt = 8\pi; \mathbf{n} = \left(\frac{4}{\sqrt{17}} \cos t \right)\mathbf{i} + \left(\frac{1}{\sqrt{17}} \sin t \right)\mathbf{j} \Rightarrow \mathbf{F}_1 \cdot \mathbf{n}$$

$$= \frac{4}{\sqrt{17}} \cos^2 t + \frac{4}{\sqrt{17}} \sin^2 t \text{ and } \mathbf{F}_2 \cdot \mathbf{n} = -\frac{15}{\sqrt{17}} \sin t \cos t \Rightarrow \text{Flux}_1 = \int_0^{2\pi} (\mathbf{F}_1 \cdot \mathbf{n}) |\mathbf{v}| \, dt = \int_0^{2\pi} \left(\frac{4}{\sqrt{17}} \right) \sqrt{17} \, dt$$

$$= 8\pi \text{ and } \text{Flux}_2 = \int_0^{2\pi} (\mathbf{F}_2 \cdot \mathbf{n}) |\mathbf{v}| \, dt = \int_0^{2\pi} \left(-\frac{15}{\sqrt{17}} \sin t \cos t \right) \sqrt{17} \, dt = \left[-\frac{15}{2} \sin^2 t \right]_0^{2\pi} = 0$$

30. $\mathbf{r} = (a \cos t)\mathbf{i} + (a \sin t)\mathbf{j}, 0 \leq t \leq 2\pi, \mathbf{F}_1 = 2x\mathbf{i} - 3y\mathbf{j},$ and $\mathbf{F}_2 = 2x\mathbf{i} + (x - y)\mathbf{j} \Rightarrow \frac{d\mathbf{r}}{dt} = (-a \sin t)\mathbf{i} + (a \cos t)\mathbf{j},$

$$\mathbf{F}_1 = (2a \cos t)\mathbf{i} - (3a \sin t)\mathbf{j}, \text{ and } \mathbf{F}_2 = (2a \cos t)\mathbf{i} + (a \cos t - a \sin t)\mathbf{j} \Rightarrow \mathbf{n} |\mathbf{v}| = (a \cos t)\mathbf{i} + (a \sin t)\mathbf{j},$$

$$\mathbf{F}_1 \cdot \mathbf{n} |\mathbf{v}| = 2a^2 \cos^2 t - 3a^2 \sin^2 t, \text{ and } \mathbf{F}_2 \cdot \mathbf{n} |\mathbf{v}| = 2a^2 \cos^2 t + a^2 \sin t \cos t - a^2 \sin^2 t$$

$$\Rightarrow \text{Flux}_1 = \int_0^{2\pi} (2a^2 \cos^2 t - 3a^2 \sin^2 t) \, dt = 2a^2 \left[\frac{t}{2} + \frac{\sin 2t}{4} \right]_0^{2\pi} - 3a^2 \left[\frac{t}{2} - \frac{\sin 2t}{4} \right]_0^{2\pi} = -\pi a^2, \text{ and}$$

$$\text{Flux}_2 = \int_0^{2\pi} (2a^2 \cos^2 t - a^2 \sin t \cos t - a^2 \sin^2 t) \, dt$$

$$= 2a^2 \left[\frac{t}{2} + \frac{\sin 2t}{4} \right]_0^{2\pi} + \frac{a^2}{2} \left[\sin^2 t \right]_0^{2\pi} - a^2 \left[\frac{t}{2} - \frac{\sin 2t}{4} \right]_0^{2\pi} = \pi a^2$$

31. $\mathbf{F}_1 = (a \cos t)\mathbf{i} + (a \sin t)\mathbf{j}, \frac{d\mathbf{r}_1}{dt} = (-a \sin t)\mathbf{i} + (a \cos t)\mathbf{j} \Rightarrow \mathbf{F}_1 \cdot \frac{d\mathbf{r}_1}{dt} = 0 \Rightarrow \text{Circ}_1 = 0; M_1 = a \cos t,$

$$N_1 = a \sin t, dx = -a \sin t \, dt, dy = a \cos t \, dt \Rightarrow \text{Flux}_1 = \int_C M_1 \, dy - N_1 \, dx = \int_0^\pi (a^2 \cos^2 t + a^2 \sin^2 t) \, dt$$

$$= \int_0^\pi a^2 \, dt = a^2 \pi;$$

$$\mathbf{F}_2 = t\mathbf{i}, \frac{d\mathbf{r}_2}{dt} = \mathbf{i} \Rightarrow \mathbf{F}_2 \cdot \frac{d\mathbf{r}_2}{dt} = t \Rightarrow \text{Circ}_2 = \int_{-a}^a t \, dt = 0; M_2 = t, N_2 = 0, dx = dt, dy = 0$$

$$\Rightarrow \text{Flux}_2 = \int_C M_2 \, dy - N_2 \, dx = \int_{-a}^a 0 \, dt = 0;$$

therefore, $\text{Circ} = \text{Circ}_1 + \text{Circ}_2 = 0$ and $\text{Flux} = \text{Flux}_1 + \text{Flux}_2 = a^2 \pi$

32. $\mathbf{F}_1 = (a^2 \cos^2 t)\mathbf{i} + (a^2 \sin^2 t)\mathbf{j}, \frac{d\mathbf{r}_1}{dt} = (-a \sin t)\mathbf{i} + (a \cos t)\mathbf{j} \Rightarrow \mathbf{F}_1 \cdot \frac{d\mathbf{r}_1}{dt} = -a^3 \sin t \cos^2 t + a^3 \cos t \sin^2 t$

$$\Rightarrow \text{Circ}_1 = \int_0^\pi (-a^3 \sin t \cos^2 t + a^3 \cos t \sin^2 t) \, dt = -\frac{2a^3}{3}; M_1 = a^2 \cos^2 t, N_1 = a^2 \sin^2 t, dy = a \cos t \, dt,$$

$$dx = -a \sin t \, dt \Rightarrow \text{Flux}_1 = \int_C M_1 \, dy - N_1 \, dx = \int_0^\pi (a^3 \cos^3 t + a^3 \sin^3 t) \, dt = \frac{4}{3} a^3;$$

$$\mathbf{F}_2 = t^2 \mathbf{i}, \frac{d\mathbf{r}_2}{dt} = \mathbf{i} \Rightarrow \mathbf{F}_2 \cdot \frac{d\mathbf{r}_2}{dt} = t^2 \Rightarrow \text{Circ}_2 = \int_{-a}^a t^2 \, dt = \frac{2a^3}{3}; M_2 = t^2, N_2 = 0, dy = 0, dx = dt$$

$$\Rightarrow \text{Flux}_2 = \int_C M_2 \, dy - N_2 \, dx = 0; \text{ therefore, } \text{Circ} = \text{Circ}_1 + \text{Circ}_2 = 0 \text{ and } \text{Flux} = \text{Flux}_1 + \text{Flux}_2 = \frac{4}{3} a^3$$

33. $\mathbf{F}_1 = (-a \sin t)\mathbf{i} + (a \cos t)\mathbf{j}$, $\frac{d\mathbf{r}_1}{dt} = (-a \sin t)\mathbf{i} + (a \cos t)\mathbf{j} \Rightarrow \mathbf{F}_1 \cdot \frac{d\mathbf{r}_1}{dt} = a^2 \sin^2 t + a^2 \cos^2 t = a^2$
 $\Rightarrow \text{Circ}_1 = \int_0^\pi a^2 dt = a^2 \pi$; $M_1 = -a \sin t$, $N_1 = a \cos t$, $dx = -a \sin t dt$, $dy = a \cos t dt$
 $\Rightarrow \text{Flux}_1 = \int_C M_1 dy - N_1 dx = \int_0^\pi (-a^2 \sin t \cos t + a^2 \sin t \cos t) dt = 0$; $\mathbf{F}_2 = t\mathbf{j}$, $\frac{d\mathbf{r}_2}{dt} = \mathbf{i} \Rightarrow \mathbf{F}_2 \cdot \frac{d\mathbf{r}_2}{dt} = 0$
 $\Rightarrow \text{Circ}_2 = 0$; $M_2 = 0$, $N_2 = t$, $dx = dt$, $dy = 0 \Rightarrow \text{Flux}_2 = \int_C M_2 dy - N_2 dx = \int_{-a}^a -t dt = 0$; therefore,
 $\text{Circ} = \text{Circ}_1 + \text{Circ}_2 = a^2 \pi$ and $\text{Flux} = \text{Flux}_1 + \text{Flux}_2 = 0$
34. $\mathbf{F}_1 = (-a^2 \sin^2 t)\mathbf{i} + (a^2 \cos^2 t)\mathbf{j}$, $\frac{d\mathbf{r}_1}{dt} = (-a \sin t)\mathbf{i} + (a \cos t)\mathbf{j} \Rightarrow \mathbf{F}_1 \cdot \frac{d\mathbf{r}_1}{dt} = a^3 \sin^3 t + a^3 \cos^3 t$
 $\Rightarrow \text{Circ}_1 = \int_0^\pi (a^3 \sin^3 t + a^3 \cos^3 t) dt = \frac{4}{3} a^3$; $M_1 = -a^2 \sin^2 t$, $N_1 = a^2 \cos^2 t$, $dy = a \cos t dt$, $dx = -a \sin t dt$
 $\Rightarrow \text{Flux}_1 = \int_C M_1 dy - N_1 dx = \int_0^\pi (-a^3 \cos t \sin^2 t + a^3 \sin t \cos^2 t) dt = \frac{2}{3} a^3$; $\mathbf{F}_2 = t^2 \mathbf{j}$, $\frac{d\mathbf{r}_2}{dt} = \mathbf{i} \Rightarrow \mathbf{F}_2 \cdot \frac{d\mathbf{r}_2}{dt} = 0$
 $\Rightarrow \text{Circ}_2 = 0$; $M_2 = 0$, $N_2 = t^2$, $dy = 0$, $dx = dt \Rightarrow \text{Flux}_2 = \int_C M_2 dy - N_2 dx = \int_{-a}^a -t^2 dt = -\frac{2}{3} a^3$; therefore,
 $\text{Circ} = \text{Circ}_1 + \text{Circ}_2 = \frac{4}{3} a^3$ and $\text{Flux} = \text{Flux}_1 + \text{Flux}_2 = 0$
35. (a) $\mathbf{r} = (\cos t)\mathbf{i} + (\sin t)\mathbf{j}$, $0 \leq t \leq \pi$, and $\mathbf{F} = (x+y)\mathbf{i} - (x^2 + y^2)\mathbf{j} \Rightarrow \frac{d\mathbf{r}}{dt} = (-\sin t)\mathbf{i} + (\cos t)\mathbf{j}$ and
 $\mathbf{F} = (\cos t + \sin t)\mathbf{i} - (\cos^2 t + \sin^2 t)\mathbf{j} \Rightarrow \mathbf{F} \cdot \frac{d\mathbf{r}}{dt} = -\sin t \cos t - \sin^2 t - \cos t \Rightarrow \int_C \mathbf{F} \cdot \mathbf{T} ds$
 $= \int_0^\pi (-\sin t \cos t - \sin^2 t - \cos t) dt = \left[-\frac{1}{2} \sin^2 t - \frac{t}{2} + \frac{\sin 2t}{4} - \sin t \right]_0^\pi = -\frac{\pi}{2}$
- (b) $\mathbf{r} = (1-2t)\mathbf{i}$, $0 \leq t \leq 1$, and $\mathbf{F} = (x+y)\mathbf{i} - (x^2 + y^2)\mathbf{j} \Rightarrow \frac{d\mathbf{r}}{dt} = -2\mathbf{i}$ and $\mathbf{F} = (1-2t)\mathbf{i} - (1-2t)^2 \mathbf{j} \Rightarrow$
 $\mathbf{F} \cdot \frac{d\mathbf{r}}{dt} = 4t - 2 \Rightarrow \int_C \mathbf{F} \cdot \mathbf{T} ds = \int_0^1 (4t - 2) dt = \left[2t^2 - 2t \right]_0^1 = 0$
- (c) $\mathbf{r}_1 = (1-t)\mathbf{i} - t\mathbf{j}$, $0 \leq t \leq 1$, and $\mathbf{F} = (x+y)\mathbf{i} - (x^2 + y^2)\mathbf{j} \Rightarrow \frac{d\mathbf{r}_1}{dt} = -\mathbf{i} - \mathbf{j}$ and $\mathbf{F} = (1-2t)\mathbf{i} - (1-2t+2t^2)\mathbf{j}$
 $\Rightarrow \mathbf{F} \cdot \frac{d\mathbf{r}_1}{dt} = (2t-1) + (1-2t+2t^2) = 2t^2 \Rightarrow \text{Flow}_1 = \int_{C_1} \mathbf{F} \cdot \frac{d\mathbf{r}_1}{dt} = \int_0^1 2t^2 dt = \frac{2}{3}$; $\mathbf{r}_2 = -t\mathbf{i} + (t-1)\mathbf{j}$,
 $0 \leq t \leq 1$, and $\mathbf{F} = (x+y)\mathbf{i} - (x^2 + y^2)\mathbf{j} \Rightarrow \frac{d\mathbf{r}_2}{dt} = -\mathbf{i} + \mathbf{j}$ and $\mathbf{F} = -\mathbf{i} - (t^2 + t^2 - 2t + 1)\mathbf{j}$
 $= -\mathbf{i} - (2t^2 - 2t + 1)\mathbf{j} \Rightarrow \mathbf{F} \cdot \frac{d\mathbf{r}_2}{dt} = 1 - (2t^2 - 2t + 1) = 2t - 2t^2 \Rightarrow \text{Flow}_2 = \int_{C_2} \mathbf{F} \cdot \frac{d\mathbf{r}_2}{dt} = \int_0^1 (2t - 2t^2) dt$
 $= \left[t^2 - \frac{2}{3} t^3 \right]_0^1 = \frac{1}{3} \Rightarrow \text{Flow} = \text{Flow}_1 + \text{Flow}_2 = \frac{2}{3} + \frac{1}{3} = 1$
36. From (1,0) to (0,1): $\mathbf{r}_1 = (1-t)\mathbf{i} + t\mathbf{j}$, $0 \leq t \leq 1$, and $\mathbf{F} = (x+y)\mathbf{i} - (x^2 + y^2)\mathbf{j} \Rightarrow \frac{d\mathbf{r}_1}{dt} = -\mathbf{i} + \mathbf{j}$,
 $\mathbf{F} = \mathbf{i} - (1-2t+2t^2)\mathbf{j}$, and $\mathbf{n}_1 |\mathbf{v}_1| = \mathbf{i} + \mathbf{j} \Rightarrow \mathbf{F} \cdot \mathbf{n}_1 |\mathbf{v}_1| = 2t - 2t^2 \Rightarrow \text{Flux}_1 = \int_0^1 (2t - 2t^2) dt = \left[t^2 - \frac{2}{3} t^3 \right]_0^1 = \frac{1}{3}$;
 From (0,1) to (-1,0): $\mathbf{r}_2 = -t\mathbf{i} + (1-t)\mathbf{j}$, $0 \leq t \leq 1$, and $\mathbf{F} = (x+y)\mathbf{i} - (x^2 + y^2)\mathbf{j} \Rightarrow \frac{d\mathbf{r}_2}{dt} = -\mathbf{i} - \mathbf{j}$,
 $\mathbf{F} = (1-2t)\mathbf{i} - (1-2t+2t^2)\mathbf{j}$, and $\mathbf{n}_2 |\mathbf{v}_2| = -\mathbf{i} + \mathbf{j} \Rightarrow \mathbf{F} \cdot \mathbf{n}_2 |\mathbf{v}_2| = (2t-1) + (-1+2t-2t^2) = -2+4t-2t^2$
 $\Rightarrow \text{Flux}_2 = \int_0^1 (-2+4t-2t^2) dt = \left[-2t+2t^2-\frac{2}{3}t^3 \right]_0^1 = -\frac{2}{3}$;

From $(-1, 0)$ to $(1, 0)$: $\mathbf{r}_3 = (-1+2t)\mathbf{i}$, $0 \leq t \leq 1$, and $\mathbf{F} = (x+y)\mathbf{i} - (x^2+y^2)\mathbf{j} \Rightarrow \frac{d\mathbf{r}_3}{dt} = 2\mathbf{i}$,

$\mathbf{F} = (-1+2t)\mathbf{i} - (1-4t+4t^2)\mathbf{j}$, and $\mathbf{n}_3 \cdot |\mathbf{v}_3| = -2\mathbf{j} \Rightarrow \mathbf{F} \cdot \mathbf{n}_3 \cdot |\mathbf{v}_3| = 2(1-4t+4t^2)$

$$\Rightarrow \text{Flux}_3 = 2 \int_0^1 (1-4t+4t^2) dt = 2 \left[t-2t^2 + \frac{4}{3}t^3 \right]_0^1 = \frac{2}{3} \Rightarrow \text{Flux} = \text{Flux}_1 + \text{Flux}_2 + \text{Flux}_3 = \frac{1}{3} - \frac{2}{3} + \frac{2}{3} = \frac{1}{3}$$

37. (a) $y = 2x$, $0 \leq x \leq 2 \Rightarrow \mathbf{r}(t) = t\mathbf{i} + 2t\mathbf{j}$, $0 \leq t \leq 2 \Rightarrow \frac{d\mathbf{r}}{dt} = \mathbf{i} + 2t\mathbf{j} \Rightarrow \mathbf{F} \cdot \frac{d\mathbf{r}}{dt} = ((2t)^2\mathbf{i} + 2t(2t)\mathbf{j}) \cdot (\mathbf{i} + 2t\mathbf{j})$

$$= 4t^2 + 8t^2 = 12t^2 \Rightarrow \text{Flow} = \int_C \mathbf{F} \cdot \frac{d\mathbf{r}}{dt} dt = \int_0^2 12t^2 dt = \left[4t^3 \right]_0^2 = 32$$

(b) $y = x^2$, $0 \leq x \leq 2 \Rightarrow \mathbf{r}(t) = t\mathbf{i} + t^2\mathbf{j}$, $0 \leq t \leq 2 \Rightarrow \frac{d\mathbf{r}}{dt} = \mathbf{i} + 2t\mathbf{j} \Rightarrow \mathbf{F} \cdot \frac{d\mathbf{r}}{dt} = \left((t^2)^2\mathbf{i} + 2t(t^2)\mathbf{j} \right) \cdot (\mathbf{i} + 2t\mathbf{j})$

$$= t^4 + 4t^4 = 5t^4 \Rightarrow \text{Flow} = \int_C \mathbf{F} \cdot \frac{d\mathbf{r}}{dt} dt = \int_0^2 5t^4 dt = \left[t^5 \right]_0^2 = 32$$

(c) answers will vary, one possible path is $y = \frac{1}{2}x^3$, $0 \leq x \leq 2 \Rightarrow \mathbf{r}(t) = t\mathbf{i} + \frac{1}{2}t^3\mathbf{j}$, $0 \leq t \leq 2 \Rightarrow \frac{d\mathbf{r}}{dt} = \mathbf{i} + 3t^2\mathbf{j}$

$$\Rightarrow \mathbf{F} \cdot \frac{d\mathbf{r}}{dt} = \left(\left(\frac{1}{2}t^3 \right)^2\mathbf{i} + 2t \left(\frac{1}{2}t^3 \right)\mathbf{j} \right) \cdot (\mathbf{i} + 3t^2\mathbf{j}) = \frac{1}{4}t^6 + \frac{3}{2}t^6 = \frac{7}{4}t^6 \Rightarrow \text{Flow} = \int_C \mathbf{F} \cdot \frac{d\mathbf{r}}{dt} dt = \int_0^2 \frac{7}{4}t^6 dt$$

$$= \left[\frac{1}{4}t^7 \right]_0^2 = 32$$

38. (a) $C_1: \mathbf{r}(t) = (1-t)\mathbf{i} + \mathbf{j}$, $0 \leq t \leq 2 \Rightarrow \frac{d\mathbf{r}}{dt} = -\mathbf{i} \Rightarrow \mathbf{F} \cdot \frac{d\mathbf{r}}{dt} = ((1)\mathbf{i} + ((1-t) + 2(1))\mathbf{j}) \cdot (-\mathbf{i}) = -1$;

$$C_2: \mathbf{r}(t) = -\mathbf{i} + (1-t)\mathbf{j}$$
, $0 \leq t \leq 2 \Rightarrow \frac{d\mathbf{r}}{dt} = -\mathbf{j} \Rightarrow \mathbf{F} \cdot \frac{d\mathbf{r}}{dt} = ((1-t)\mathbf{i} + ((-1) + 2(1-t))\mathbf{j}) \cdot (-\mathbf{j}) = 2t-1$;

$$C_3: \mathbf{r}(t) = (t-1)\mathbf{i} - \mathbf{j}$$
, $0 \leq t \leq 2 \Rightarrow \frac{d\mathbf{r}}{dt} = \mathbf{i} \Rightarrow \mathbf{F} \cdot \frac{d\mathbf{r}}{dt} = ((-1)\mathbf{i} + ((t-1) + 2(-1))\mathbf{j}) \cdot (\mathbf{i}) = -1$;

$$C_4: \mathbf{r}(t) = \mathbf{i} + (t-1)\mathbf{j}$$
, $0 \leq t \leq 2 \Rightarrow \frac{d\mathbf{r}}{dt} = \mathbf{j} \Rightarrow \mathbf{F} \cdot \frac{d\mathbf{r}}{dt} = ((t-1)\mathbf{i} + ((1) + 2(t-1))\mathbf{j}) \cdot (\mathbf{j}) = 2t-1$;

$$\Rightarrow \text{Flow} = \int_C \mathbf{F} \cdot \frac{d\mathbf{r}}{dt} dt = \int_{C_1} \mathbf{F} \cdot \frac{d\mathbf{r}}{dt} dt + \int_{C_2} \mathbf{F} \cdot \frac{d\mathbf{r}}{dt} dt + \int_{C_3} \mathbf{F} \cdot \frac{d\mathbf{r}}{dt} dt + \int_{C_4} \mathbf{F} \cdot \frac{d\mathbf{r}}{dt} dt$$

$$= \int_0^2 (-1) dt + \int_0^2 (2t-1) dt + \int_0^2 (-1) dt + \int_0^2 (2t-1) dt = [-t]_0^2 + [t^2 - t]_0^2 + [-t]_0^2 + [t^2 - t]_0^2$$

$$= -2 + 2 - 2 + 2 = 0$$

(b) $x^2 + y^2 = 4 \Rightarrow \mathbf{r}(t) = (2 \cos t)\mathbf{i} + (2 \sin t)\mathbf{j}$, $0 \leq t \leq 2\pi \Rightarrow \frac{d\mathbf{r}}{dt} = (-2 \sin t)\mathbf{i} + (2 \cos t)\mathbf{j}$

$$\Rightarrow \mathbf{F} \cdot \frac{d\mathbf{r}}{dt} = ((2 \sin t)\mathbf{i} + (2 \cos t + 2(2 \sin t))\mathbf{j}) \cdot ((-2 \sin t)\mathbf{i} + (2 \cos t)\mathbf{j}) = -4 \sin^2 t + 4 \cos^2 t + 8 \sin t \cos t$$

$$= 4 \cos 2t + 4 \sin 2t \Rightarrow \text{Flow} = \int_C \mathbf{F} \cdot \frac{d\mathbf{r}}{dt} dt = \int_0^{2\pi} (4 \cos 2t + 4 \sin 2t) dt = [2 \sin 2t - 2 \cos 2t]_0^{2\pi} = 0$$

(c) answers will vary, one possible path is:

$$C_1: \mathbf{r}(t) = t\mathbf{i}$$
, $0 \leq t \leq 1 \Rightarrow \frac{d\mathbf{r}}{dt} = \mathbf{i} \Rightarrow \mathbf{F} \cdot \frac{d\mathbf{r}}{dt} = ((0)\mathbf{i} + (t + 2(1))\mathbf{j}) \cdot (\mathbf{i}) = 0$;

$$C_2: \mathbf{r}(t) = (1-t)\mathbf{i} + t\mathbf{j}$$
, $0 \leq t \leq 1 \Rightarrow \frac{d\mathbf{r}}{dt} = -\mathbf{i} + \mathbf{j} \Rightarrow \mathbf{F} \cdot \frac{d\mathbf{r}}{dt} = (t\mathbf{i} + ((1-t) + 2t)\mathbf{j}) \cdot (-\mathbf{i} + \mathbf{j}) = 1$;

$$C_3: \mathbf{r}(t) = (1-t)\mathbf{j}$$
, $0 \leq t \leq 1 \Rightarrow \frac{d\mathbf{r}}{dt} = -\mathbf{j} \Rightarrow \mathbf{F} \cdot \frac{d\mathbf{r}}{dt} = ((1-t)\mathbf{i} + (0 + 2(1-t))\mathbf{j}) \cdot (-\mathbf{j}) = 2t-1$;

$$\Rightarrow \text{Flow} = \int_C \mathbf{F} \cdot \frac{d\mathbf{r}}{dt} dt = \int_{C_1} \mathbf{F} \cdot \frac{d\mathbf{r}}{dt} dt + \int_{C_2} \mathbf{F} \cdot \frac{d\mathbf{r}}{dt} dt + \int_{C_3} \mathbf{F} \cdot \frac{d\mathbf{r}}{dt} dt = \int_0^1 (0) dt + \int_0^1 (1) dt + \int_0^1 (2t-1) dt$$

$$= 0 + [t]_0^1 + [t^2 - t]_0^1 = 1 + (-1) = 0$$

39. $\mathbf{F} = -\frac{y}{\sqrt{x^2+y^2}}\mathbf{i} + \frac{x}{\sqrt{x^2+y^2}}\mathbf{j}$ on $x^2 + y^2 = 4$;

at $(2, 0)$, $\mathbf{F} = \mathbf{j}$; at $(0, 2)$, $\mathbf{F} = -\mathbf{i}$;

at $(-2, 0)$, $\mathbf{F} = -\mathbf{j}$; at $(0, -2)$, $\mathbf{F} = \mathbf{i}$;

at $(\sqrt{2}, \sqrt{2})$, $\mathbf{F} = -\frac{\sqrt{3}}{2}\mathbf{i} + \frac{1}{2}\mathbf{j}$;

at $(\sqrt{2}, -\sqrt{2})$, $\mathbf{F} = \frac{\sqrt{3}}{2}\mathbf{i} + \frac{1}{2}\mathbf{j}$;

at $(-\sqrt{2}, \sqrt{2})$, $\mathbf{F} = -\frac{\sqrt{3}}{2}\mathbf{i} - \frac{1}{2}\mathbf{j}$;

at $(-\sqrt{2}, -\sqrt{2})$, $\mathbf{F} = \frac{\sqrt{3}}{2}\mathbf{i} - \frac{1}{2}\mathbf{j}$

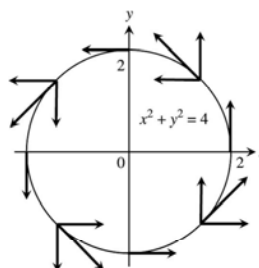

40. $\mathbf{F} = x\mathbf{i} + y\mathbf{j}$ on $x^2 + y^2 = 1$; at $(1, 0)$, $\mathbf{F} = \mathbf{i}$;

at $(-1, 0)$, $\mathbf{F} = -\mathbf{i}$; at $(0, 1)$, $\mathbf{F} = \mathbf{j}$;

at $(0, -1)$, $\mathbf{F} = -\mathbf{j}$; at $(\frac{1}{2}, \frac{\sqrt{3}}{2})$, $\mathbf{F} = \frac{1}{2}\mathbf{i} + \frac{\sqrt{3}}{2}\mathbf{j}$;

at $(-\frac{1}{2}, \frac{\sqrt{3}}{2})$, $\mathbf{F} = -\frac{1}{2}\mathbf{i} + \frac{\sqrt{3}}{2}\mathbf{j}$;

at $(\frac{1}{2}, -\frac{\sqrt{3}}{2})$, $\mathbf{F} = \frac{1}{2}\mathbf{i} - \frac{\sqrt{3}}{2}\mathbf{j}$;

at $(-\frac{1}{2}, -\frac{\sqrt{3}}{2})$, $\mathbf{F} = -\frac{1}{2}\mathbf{i} - \frac{\sqrt{3}}{2}\mathbf{j}$.

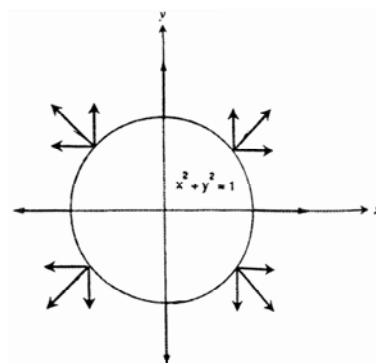

41. (a) $\mathbf{G} = P(x, y)\mathbf{i} + Q(x, y)\mathbf{j}$ is to have a magnitude $\sqrt{a^2 + b^2}$ and to be tangent to $x^2 + y^2 = a^2 + b^2$ in a counterclockwise direction. Thus $x^2 + y^2 = a^2 + b^2 \Rightarrow 2x + 2yy' = 0 \Rightarrow y' = -\frac{x}{y}$ is the slope of the tangent line at any point on the circle $\Rightarrow y' = -\frac{a}{b}$ at (a, b) . Let $\mathbf{v} = -b\mathbf{i} + a\mathbf{j} \Rightarrow |\mathbf{v}| = \sqrt{a^2 + b^2}$, with \mathbf{v} in a counterclockwise direction and tangent to the circle. Then let $P(x, y) = -y$ and $Q(x, y) = x \Rightarrow \mathbf{G} = -y\mathbf{i} + x\mathbf{j} \Rightarrow$ for (a, b) on $x^2 + y^2 = a^2 + b^2$ we have $\mathbf{G} = -b\mathbf{i} + a\mathbf{j}$ and $|\mathbf{G}| = \sqrt{a^2 + b^2}$.

(b) $\mathbf{G} = (\sqrt{x^2 + y^2})\mathbf{F} = (\sqrt{a^2 + b^2})\mathbf{F}$.

42. (a) From Exercise 41, part a, $-y\mathbf{i} + x\mathbf{j}$ is a vector tangent to the circle and pointing in a counterclockwise direction $\Rightarrow y\mathbf{i} - x\mathbf{j}$ is a vector tangent to the circle pointing in a clockwise direction $\Rightarrow \mathbf{G} = \frac{y\mathbf{i} - x\mathbf{j}}{\sqrt{x^2 + y^2}}$ is a unit vector tangent to the circle and pointing in a clockwise direction.

(b) $\mathbf{G} = -\mathbf{F}$

43. The slope of the line through (x, y) and the origin is $\frac{y}{x} \Rightarrow \mathbf{v} = x\mathbf{i} + y\mathbf{j}$ is a vector parallel to that line and pointing away from the origin $\Rightarrow \mathbf{F} = -\frac{x\mathbf{i} + y\mathbf{j}}{\sqrt{x^2 + y^2}}$ is the unit vector pointing toward the origin.

44. (a) From Exercise 43, $-\frac{x\mathbf{i}+y\mathbf{j}}{\sqrt{x^2+y^2}}$ is a unit vector through (x, y) pointing toward the origin and we want $|\mathbf{F}|$ to

$$\text{have magnitude } \sqrt{x^2+y^2} \Rightarrow \mathbf{F} = \sqrt{x^2+y^2} \left(-\frac{x\mathbf{i}+y\mathbf{j}}{\sqrt{x^2+y^2}} \right) = -x\mathbf{i} - y\mathbf{j}.$$

(b) We want $|\mathbf{F}| = \frac{C}{\sqrt{x^2+y^2}}$ where $C \neq 0$ is a constant $\Rightarrow \mathbf{F} = \frac{C}{\sqrt{x^2+y^2}} \left(-\frac{x\mathbf{i}+y\mathbf{j}}{\sqrt{x^2+y^2}} \right) = -C \left(\frac{x\mathbf{i}+y\mathbf{j}}{\sqrt{x^2+y^2}} \right)$.

45. Yes. The work and area have the same numerical value because work $= \int_C \mathbf{F} \cdot d\mathbf{r} = \int_C y\mathbf{i} \cdot d\mathbf{r}$

$$= \int_b^a [f(t)\mathbf{i}] \cdot \left[\mathbf{i} + \frac{df}{dt} \mathbf{j} \right] dt \quad \text{[On the path, } y \text{ equals } f(t)\text{]}$$

$$= \int_a^b f(t) dt = \text{Area under the curve} \quad \text{[because } f(t) > 0 \text{]}$$

46. $\mathbf{r} = x\mathbf{i} + y\mathbf{j} = x\mathbf{i} + f(x)\mathbf{j} \Rightarrow \frac{d\mathbf{r}}{dx} = \mathbf{i} + f'(x)\mathbf{j}$; $\mathbf{F} = \frac{k}{\sqrt{x^2+y^2}}(x\mathbf{i} + y\mathbf{j})$ has constant magnitude k and points away from

the origin $\Rightarrow \mathbf{F} \cdot \frac{d\mathbf{r}}{dx} = \frac{kx}{\sqrt{x^2+y^2}} + \frac{k \cdot y \cdot f'(x)}{\sqrt{x^2+y^2}} = \frac{kx+k \cdot f(x) \cdot f'(x)}{\sqrt{x^2+[f(x)]^2}} = k \frac{d}{dx} \sqrt{x^2+[f(x)]^2}$, by the chain rule

$$\Rightarrow \int_C \mathbf{F} \cdot \mathbf{T} ds = \int_C \mathbf{F} \cdot \frac{d\mathbf{r}}{dx} dx = \int_a^b k \frac{d}{dx} \sqrt{x^2+[f(x)]^2} dx = k \left[\sqrt{x^2+[f(x)]^2} \right]_a^b$$

$$= k \left(\sqrt{b^2+[f(b)]^2} - \sqrt{a^2+[f(a)]^2} \right), \text{ as claimed.}$$

47. $\mathbf{F} = -4t^3\mathbf{i} + 8t^2\mathbf{j} + 2\mathbf{k}$ and $\frac{d\mathbf{r}}{dt} = \mathbf{i} + 2t\mathbf{j} \Rightarrow \mathbf{F} \cdot \frac{d\mathbf{r}}{dt} = 12t^3 \Rightarrow \text{Flow} = \int_0^2 12t^3 dt = \left[3t^4 \right]_0^2 = 48$

48. $\mathbf{F} = 12t^2\mathbf{j} + 9t^2\mathbf{k}$ and $\frac{d\mathbf{r}}{dt} = 3\mathbf{j} + 4\mathbf{k} \Rightarrow \mathbf{F} \cdot \frac{d\mathbf{r}}{dt} = 72t^2 \Rightarrow \text{Flow} = \int_0^1 72t^2 dt = \left[24t^3 \right]_0^1 = 24$

49. $\mathbf{F} = (\cos t - \sin t)\mathbf{i} + (\cos t)\mathbf{k}$ and $\frac{d\mathbf{r}}{dt} = (-\sin t)\mathbf{i} + (\cos t)\mathbf{k} \Rightarrow \mathbf{F} \cdot \frac{d\mathbf{r}}{dt} = -\sin t \cos t + 1$

$$\Rightarrow \text{Flow} = \int_0^\pi (-\sin t \cos t + 1) dt = \left[\frac{1}{2} \cos^2 t + t \right]_0^\pi = \left(\frac{1}{2} + \pi \right) - \left(\frac{1}{2} + 0 \right) = \pi$$

50. $\mathbf{F} = (-2 \sin t)\mathbf{i} - (2 \cos t)\mathbf{j} + 2\mathbf{k}$ and $\frac{d\mathbf{r}}{dt} = (2 \sin t)\mathbf{i} + (2 \cos t)\mathbf{j} + 2\mathbf{k} \Rightarrow \mathbf{F} \cdot \frac{d\mathbf{r}}{dt} = -4 \sin^2 t - 4 \cos^2 t + 4 = 0$

$$\Rightarrow \text{Flow} = 0$$

51. $C_1: \mathbf{r} = (\cos t)\mathbf{i} + (\sin t)\mathbf{j} + t\mathbf{k}, 0 \leq t \leq \frac{\pi}{2} \Rightarrow \mathbf{F} = (2 \cos t)\mathbf{i} + 2t\mathbf{j} + (2 \sin t)\mathbf{k}$ and $\frac{d\mathbf{r}}{dt} = (-\sin t)\mathbf{i} + (\cos t)\mathbf{j} + \mathbf{k}$

$$\Rightarrow \mathbf{F} \cdot \frac{d\mathbf{r}}{dt} = -2 \cos t \sin t + 2t \cos t + 2 \sin t = -\sin 2t + 2t \cos t + 2 \sin t$$

$$\Rightarrow \text{Flow}_1 = \int_0^{\pi/2} (-\sin 2t + 2t \cos t + 2 \sin t) dt = \left[\frac{1}{2} \cos 2t + 2t \sin t + 2 \cos t - 2 \cos t \right]_0^{\pi/2} = -1 + \pi;$$

$C_2: \mathbf{r} = \mathbf{j} + \frac{\pi}{2}(1-t)\mathbf{k}, 0 \leq t \leq 1 \Rightarrow \mathbf{F} = \pi(1-t)\mathbf{j} + 2\mathbf{k}$ and $\frac{d\mathbf{r}}{dt} = -\frac{\pi}{2}\mathbf{k} \Rightarrow \mathbf{F} \cdot \frac{d\mathbf{r}}{dt} = -\pi$

$$\Rightarrow \text{Flow}_2 = \int_0^1 -\pi dt = \left[-\pi t \right]_0^1 = -\pi;$$

$$C_3: \mathbf{r} = t\mathbf{i} + (1-t)\mathbf{j}, 0 \leq t \leq 1 \Rightarrow \mathbf{F} = 2t\mathbf{i} + 2(1-t)\mathbf{k} \text{ and } \frac{d\mathbf{r}}{dt} = \mathbf{i} - \mathbf{j} \Rightarrow \mathbf{F} \cdot \frac{d\mathbf{r}}{dt} = 2t$$

$$\Rightarrow \text{Flow}_3 = \int_0^1 2t \, dt = \left[t^2 \right]_0^1 = 1 \Rightarrow \text{Circulation} = (-1 + \pi) - \pi + 1 = 0$$

52. $\mathbf{F} \cdot \frac{d\mathbf{r}}{dt} = x \frac{dx}{dt} + y \frac{dy}{dt} + z \frac{dz}{dt} = \frac{\partial f}{\partial x} \frac{dx}{dt} + \frac{\partial f}{\partial y} \frac{dy}{dt} + \frac{\partial f}{\partial z} \frac{dz}{dt}$, where $f(x, y, z) = \frac{1}{2}(x^2, y^2 + x^2) \Rightarrow \mathbf{F} \cdot \frac{d\mathbf{r}}{dt} = \frac{d}{dt}(f(\mathbf{r}(t)))$ by the chain rule $\Rightarrow \text{Circulation} = \int_C \mathbf{F} \cdot \frac{d\mathbf{r}}{dt} dt = \int_a^b \frac{d}{dt}(f(\mathbf{r}(t))) dt = f(\mathbf{r}(b)) - f(\mathbf{r}(a))$. Since C is an entire ellipse, $\mathbf{r}(b) = \mathbf{r}(a)$, thus the Circulation = 0.

53. Let $x = t$ be the parameter $\Rightarrow y = x^2 = t^2$ and $z = x = t \Rightarrow \mathbf{r} = t\mathbf{i} + t^2\mathbf{j} + t\mathbf{k}, 0 \leq t \leq 1$ from $(0, 0, 0)$ to $(1, 1, 1)$
 $\Rightarrow \frac{d\mathbf{r}}{dt} = \mathbf{i} + 2t\mathbf{j} + \mathbf{k}$ and $\mathbf{F} = xy\mathbf{i} + y\mathbf{j} - yz\mathbf{k} = t^3\mathbf{i} + t^2\mathbf{j} - t^3\mathbf{k} \Rightarrow \mathbf{F} \cdot \frac{d\mathbf{r}}{dt} = t^3 + 2t^3 - t^3 = 2t^3 \Rightarrow \text{Flow} = \int_0^1 2t^3 \, dt = \frac{1}{2}$

54. (a) $\mathbf{F} = \nabla(xy^2z^3) \Rightarrow \mathbf{F} \cdot \frac{d\mathbf{r}}{dt} = \frac{\partial f}{\partial x} \frac{dx}{dt} + \frac{\partial f}{\partial y} \frac{dy}{dt} + \frac{\partial f}{\partial z} \frac{dz}{dt} = \frac{df}{dt}$, where $f(x, y, z) = xy^2z^3 \Rightarrow \oint_C \mathbf{F} \cdot \frac{d\mathbf{r}}{dt} dt = \int_a^b \frac{d}{dt}(f(\mathbf{r}(t))) dt = f(\mathbf{r}(b)) - f(\mathbf{r}(a)) = 0$ since C is an entire ellipse.

(b) $\int_C \mathbf{F} \cdot \frac{d\mathbf{r}}{dt} dt = \int_{(1,1,1)}^{(2,1,-1)} \frac{d}{dt}(xy^2z^3) dt = \left[xy^2z^3 \right]_{(1,1,1)}^{(2,1,-1)} = (2)(1)^2(-1)^3 - (1)(1)^2(1)^3 = -2 - 1 = -3$

55-60. Example CAS commands:

Maple:

```
with( LinearAlgebra );#55
F:=r-><< r[1]*r[2]^6|3*r[1]*(r[1]*r[2]^5+2)>>;
r:=t-><< 2*cos(t)| sin(t) >>;
a,b:= 0.2*Pi;
dr:= map(diff,r(t),t); # (a)
F(r(t)); # (b)
q1:= simplify( F(r(t)) . dr ) assuming t::real; # (c)
q2:= Int( q1, t = a..b );
value( q2 );
```

Mathematica: (functions and bounds will vary):

Exercises 55 and 56 use vectors in 2 dimensions

```
Clear[x, y, t, f, r, v]
f[x_,y_]:= {x y^6, 3x(x y^5 + 2)}
{a, b} = {0, 2π};
x[t_]:= 2 Cos[t]
y[t_]:= Sin[t]
r[t_]:= {x[t], y[t]}
v[t_]:= r'[t]
integrand=f[x[t], y[t]]. v[t]//Simplify
Integrate[integrand, {t, a, b}]
N[%]
```

If the integration takes too long or cannot be done, use NIntegrate to integrate numerically. This is suggested for Exercises 57 - 60 that use vectors in 3 dimensions. Be certain to leave spaces between variables to be multiplied.

```

Clear[x, y, z, t, f, r, v]
f[x_, y_, z_] := [y + y z Cos[x, y, z], x^2 + x z Cos[x, y, z], z + x y Cos[x y z]]
[a, b] = {0, 2π};
x[t_] := 2 Cos[t]
y[t_] := 3 Sin[t]
z[t_] := 1
r[t_] := {x[t], y[t], z[t]}
v[t_] := r'[t]
integrand = f[x[t], y[t], z[t]] · v[t] / Simplify
NIntegrate[integrand (t, a, b)]

```

16.3 PATH INDEPENDENCE, POTENTIAL FUNCTIONS, AND CONSERVATIVE FIELDS

- $\frac{\partial P}{\partial y} = x = \frac{\partial N}{\partial z}, \frac{\partial M}{\partial z} = y = \frac{\partial P}{\partial x}, \frac{\partial N}{\partial x} = z = \frac{\partial M}{\partial y} \Rightarrow$ Conservative
- $\frac{\partial P}{\partial y} = x \cos z = \frac{\partial N}{\partial z}, \frac{\partial M}{\partial z} = y \cos z = \frac{\partial P}{\partial x}, \frac{\partial N}{\partial x} = \sin z = \frac{\partial M}{\partial y} \Rightarrow$ Conservative
- $\frac{\partial P}{\partial y} = -1 \neq 1 = \frac{\partial N}{\partial z} \Rightarrow$ Not Conservative
- $\frac{\partial N}{\partial x} = 1 \neq -1 = \frac{\partial M}{\partial y} \Rightarrow$ Not Conservative
- $\frac{\partial N}{\partial x} = 0 \neq 1 = \frac{\partial M}{\partial y} \Rightarrow$ Not Conservative
- $\frac{\partial P}{\partial y} = 0 = \frac{\partial N}{\partial z}, \frac{\partial M}{\partial z} = 0 = \frac{\partial P}{\partial x}, \frac{\partial N}{\partial x} = -e^x \sin y = \frac{\partial M}{\partial y} \Rightarrow$ Conservative
- $\frac{\partial f}{\partial x} = 2x \Rightarrow f(x, y, z) = x^2 + g(y, z) \Rightarrow \frac{\partial f}{\partial y} = \frac{\partial g}{\partial y} = 3y \Rightarrow g(y, z) = \frac{3y^2}{2} + h(z) \Rightarrow f(x, y, z) = x^2 + \frac{3y^2}{2} + h(z)$
 $\Rightarrow \frac{\partial f}{\partial z} = h'(z) = 4z \Rightarrow h(z) = 2z^2 + C \Rightarrow f(x, y, z) = x^2 + \frac{3y^2}{2} + 2z^2 + C$
- $\frac{\partial f}{\partial x} = y + z \Rightarrow f(x, y, z) = (y + z)x + g(y, z) \Rightarrow \frac{\partial f}{\partial y} = x + \frac{\partial g}{\partial y} = x + z \Rightarrow \frac{\partial g}{\partial y} = z \Rightarrow g(y, z) = zy + h(z)$
 $\Rightarrow f(x, y, z) = (y + z)x + zy + h(z) \Rightarrow \frac{\partial f}{\partial z} = x + y + h'(z) = x + y \Rightarrow h'(z) = 0 \Rightarrow h(z) = C \Rightarrow f(x, y, z)$
 $= (y + z)x + zy + C$
- $\frac{\partial f}{\partial x} = e^{y+2z} \Rightarrow f(x, y, z) = xe^{y+2z} + g(y, z) \Rightarrow \frac{\partial f}{\partial y} = xe^{y+2z} + \frac{\partial g}{\partial y} = xe^{y+2z} \Rightarrow \frac{\partial g}{\partial y} = 0 \Rightarrow f(x, y, z)$
 $= xe^{y+2z} + h(z) \Rightarrow \frac{\partial f}{\partial z} = 2xe^{y+2z} + h'(z) = 2xe^{y+2z} \Rightarrow h'(z) = 0 \Rightarrow h(z) = C \Rightarrow f(x, y, z) = xe^{y+2z} + C$
- $\frac{\partial f}{\partial x} = y \sin z \Rightarrow f(x, y, z) = xy \sin z + g(y, z) \Rightarrow \frac{\partial f}{\partial y} = x \sin z + \frac{\partial g}{\partial y} = x \sin z = \frac{\partial g}{\partial y} = 0 \Rightarrow g(y, z) = h(z)$
 $\Rightarrow f(x, y, z) = xy \sin z + h(z) \Rightarrow \frac{\partial f}{\partial z} = xy \cos z + h'(z) = xy \cos z \Rightarrow h'(z) = 0 \Rightarrow h(z) = C \Rightarrow f(x, y, z)$
 $= xy \sin z + C$

11. $\frac{\partial f}{\partial z} = \frac{z}{y^2+z^2} \Rightarrow f(x, y, z) = \frac{1}{2} \ln(y^2+z^2) + g(x, y) \Rightarrow \frac{\partial f}{\partial x} = \frac{\partial g}{\partial x} = \ln x + \sec^2(x+y) \Rightarrow g(x, y)$
 $= (x \ln x - x) + \tan(x+y) + h(y) \Rightarrow f(x, y, z) = \frac{1}{2} \ln(y^2+z^2) + (x \ln x - x) + \tan(x+y) + h(y)$
 $\Rightarrow \frac{\partial f}{\partial y} = \frac{y}{y^2+z^2} + \sec^2(x+y) + h'(y) = \sec^2(x+y) + \frac{y}{y^2+z^2} \Rightarrow h'(y) = 0 \Rightarrow h(y) = C \Rightarrow f(x, y, z)$
 $= \frac{1}{2} \ln(y^2+z^2) + (x \ln x - x) + \tan(x+y) + C$
12. $\frac{\partial f}{\partial x} = \frac{y}{1+x^2y^2} \Rightarrow f(x, y, z) = \tan^{-1}(xy) + g(y, z) \Rightarrow \frac{\partial f}{\partial y} = \frac{x}{1+x^2y^2} + \frac{\partial g}{\partial y} = \frac{x}{1+x^2y^2} + \frac{z}{\sqrt{1-y^2z^2}}$
 $\Rightarrow \frac{\partial g}{\partial y} = \frac{z}{\sqrt{1-y^2z^2}} \Rightarrow g(y, z) = \sin^{-1}(yz) + h(z) \Rightarrow f(x, y, z) = \tan^{-1}(xy) + \sin^{-1}(yz) + h(z)$
 $\Rightarrow \frac{\partial f}{\partial z} = \frac{y}{\sqrt{1-y^2z^2}} + h'(z) = \frac{y}{\sqrt{1-y^2z^2}} + \frac{1}{z} \Rightarrow h'(z) = \frac{1}{z} \Rightarrow h(z) = \ln|z| + C$
 $\Rightarrow f(x, y, z) = \tan^{-1}(xy) + \sin^{-1}(yz) + \ln|z| + C$
13. Let $\mathbf{F}(x, y, z) = 2x\mathbf{i} + 2y\mathbf{j} + 2z\mathbf{k} \Rightarrow \frac{\partial P}{\partial y} = 0 = \frac{\partial N}{\partial z}, \frac{\partial M}{\partial z} = 0 = \frac{\partial P}{\partial x}, \frac{\partial N}{\partial x} = 0 = \frac{\partial M}{\partial y} \Rightarrow M dx + N dy + P dz$ is exact;
 $\frac{\partial f}{\partial x} = 2x \Rightarrow f(x, y, z) = x^2 + g(y, z) \Rightarrow \frac{\partial f}{\partial y} = \frac{\partial g}{\partial y} = 2y \Rightarrow g(y, z) = y^2 + h(z) \Rightarrow f(x, y, z) = x^2 + y^2 + h(z)$
 $\Rightarrow \frac{\partial f}{\partial z} = h'(z) = 2z \Rightarrow h(z) = z^2 + C \Rightarrow f(x, y, z) = x^2 + y^2 + z^2 + C \Rightarrow \int_{(0,0,0)}^{(2,3,-6)} 2x dx + 2y dy + 2z dz$
 $= f(2, 3, -6) - f(0, 0, 0) = 2^2 + 3^2 + (-6)^2 = 49$
14. Let $\mathbf{F}(x, y, z) = yz\mathbf{i} + xz\mathbf{j} + xy\mathbf{k} \Rightarrow \frac{\partial P}{\partial y} = x = \frac{\partial N}{\partial z}, \frac{\partial M}{\partial z} = y = \frac{\partial P}{\partial x}, \frac{\partial N}{\partial x} = z = \frac{\partial M}{\partial y} \Rightarrow M dx + N dy + P dz$ is exact;
 $\frac{\partial f}{\partial x} = yz \Rightarrow f(x, y, z) = xyz + g(y, z) \Rightarrow \frac{\partial f}{\partial y} = xz + \frac{\partial g}{\partial y} = xz \Rightarrow \frac{\partial g}{\partial y} = 0 \Rightarrow g(y, z) = h(z)$
 $\Rightarrow f(x, y, z) = xyz + h(z) \Rightarrow \frac{\partial f}{\partial z} = xy + h'(z) = xy \Rightarrow h'(z) = 0 \Rightarrow h(z) = C \Rightarrow f(x, y, z) = xyz + C$
 $\Rightarrow \int_{(1,1,2)}^{(3,5,0)} yz dx + xz dy + xy dz = f(3, 5, 0) - f(1, 1, 2) = 0 - 2 = -2$
15. Let $\mathbf{F}(x, y, z) = 2xy\mathbf{i} + (x^2 - z^2)\mathbf{j} - 2yz\mathbf{k} \Rightarrow \frac{\partial P}{\partial y} = -2z = \frac{\partial N}{\partial z}, \frac{\partial M}{\partial z} = 0 = \frac{\partial P}{\partial x}, \frac{\partial N}{\partial x} = 2x = \frac{\partial M}{\partial y}$
 $\Rightarrow M dx + N dy + P dz$ is exact; $\frac{\partial f}{\partial x} = 2xy \Rightarrow f(x, y, z) = x^2y + g(y, z) \Rightarrow \frac{\partial f}{\partial y} = x^2 + \frac{\partial g}{\partial y} = x^2 - z^2 \Rightarrow \frac{\partial g}{\partial y} = -z^2$
 $\Rightarrow g(y, z) = -yz^2 + h(z) \Rightarrow f(x, y, z) = x^2y - yz^2 + h(z) \Rightarrow \frac{\partial f}{\partial z} = -2yz + h'(z) = -2yz \Rightarrow h'(z) = 0 \Rightarrow h(z) = C$
 $\Rightarrow f(x, y, z) = x^2y - yz^2 + C \Rightarrow \int_{(0,0,0)}^{(1,2,3)} 2xy dx + (x^2 - z^2) dy - 2yz dz = f(1, 2, 3) - f(0, 0, 0) = 2 - 2(3)^2$
 $= -16$
16. Let $\mathbf{F}(x, y, z) = 2x\mathbf{i} - y^2\mathbf{j} - \left(\frac{4}{1+z^2}\right)\mathbf{k} \Rightarrow \frac{\partial P}{\partial y} = 0 = \frac{\partial N}{\partial z}, \frac{\partial M}{\partial z} = 0 = \frac{\partial P}{\partial x}, \frac{\partial N}{\partial x} = 0 = \frac{\partial M}{\partial y}$
 $\Rightarrow M dx + N dy + P dz$ is exact; $\frac{\partial f}{\partial x} = 2x \Rightarrow f(x, y, z) = x^2 + g(y, z) \Rightarrow \frac{\partial f}{\partial y} = \frac{\partial g}{\partial y} = -y^2 \Rightarrow g(y, z) = -\frac{y^3}{3} + h(z)$
 $\Rightarrow f(x, y, z) = x^2 - \frac{y^3}{3} + h(z) \Rightarrow \frac{\partial f}{\partial z} = h'(z) = -\frac{4}{1+z^2} \Rightarrow h(z) = -4 \tan^{-1} z + C$

$$\begin{aligned} \Rightarrow f(x, y, z) &= x^2 - \frac{y^3}{3} - 4 \tan^{-1} z + C \Rightarrow \int_{(0,0,0)}^{(3,3,1)} 2x \, dx - y^2 \, dy - \frac{4}{1+z^2} \, dz = f(3, 3, 1) - f(0, 0, 0) \\ &= \left(9 - \frac{27}{3} - 4 \cdot \frac{\pi}{4}\right) - (0 - 0 - 0) = -\pi \end{aligned}$$

17. Let $\mathbf{F}(x, y, z) = (\sin y \cos x)\mathbf{i} + (\cos y \sin x)\mathbf{j} + \mathbf{k} \Rightarrow \frac{\partial P}{\partial y} = 0 = \frac{\partial N}{\partial z}, \frac{\partial M}{\partial z} = 0 = \frac{\partial P}{\partial x}, \frac{\partial N}{\partial x} = \cos y \cos x = \frac{\partial M}{\partial y}$
 $\Rightarrow M \, dx + N \, dy + P \, dz$ is exact; $\frac{\partial f}{\partial x} = \sin y \cos x \Rightarrow f(x, y, z) = \sin y \sin x + g(y, z) \Rightarrow \frac{\partial f}{\partial y} = \cos y \sin x + \frac{\partial g}{\partial y}$
 $= \cos y \sin x \Rightarrow \frac{\partial g}{\partial y} = 0 \Rightarrow g(y, z) = h(z) \Rightarrow f(x, y, z) = \sin y \sin x + h(z) \Rightarrow \frac{\partial f}{\partial z} = h'(z) = 1 \Rightarrow h(z) = z + C$
 $\Rightarrow f(x, y, z) = \sin y \sin x + z + C \Rightarrow \int_{(1,0,0)}^{(0,1,1)} \sin y \cos x \, dx + \cos y \sin x \, dy + dz = f(0, 1, 1) - f(1, 0, 0)$
 $= (0 + 1) - (0 + 0) = 1$

18. Let $\mathbf{F}(x, y, z) = (2 \cos y)\mathbf{i} + \left(\frac{1}{y} - 2x \sin y\right)\mathbf{j} + \left(\frac{1}{z}\right)\mathbf{k} \Rightarrow \frac{\partial P}{\partial y} = 0 = \frac{\partial N}{\partial z}, \frac{\partial M}{\partial z} = 0 = \frac{\partial P}{\partial x}, \frac{\partial N}{\partial x} = -2 \sin y = \frac{\partial M}{\partial y}$
 $\Rightarrow M \, dx + N \, dy + P \, dz$ is exact; $\frac{\partial f}{\partial x} = 2 \cos y \Rightarrow f(x, y, z) = 2x \cos y + g(y, z) \Rightarrow \frac{\partial f}{\partial y} = -2x \sin y + \frac{\partial g}{\partial y}$
 $= \frac{1}{y} - 2x \sin y \Rightarrow \frac{\partial g}{\partial y} = \frac{1}{y} \Rightarrow g(y, z) = \ln |y| + h(z) \Rightarrow f(x, y, z) = 2x \cos y + \ln |y| + h(z) \Rightarrow \frac{\partial f}{\partial z} = h'(z) = \frac{1}{z}$
 $\Rightarrow h(z) = \ln |z| + C \Rightarrow f(x, y, z) = 2x \cos y + \ln |y| + \ln |z| + C$
 $\Rightarrow \int_{(0,2,1)}^{(1,\pi/2,2)} 2 \cos y \, dx + \left(\frac{1}{y} - 2x \sin y\right) \, dy + \frac{1}{z} \, dz = f\left(1, \frac{\pi}{2}, 2\right) - f(0, 2, 1)$
 $= \left(2 \cdot 0 + \ln \frac{\pi}{2} + \ln 2\right) - (0 \cdot \cos 2 + \ln 2 + \ln 1) = \ln \frac{\pi}{2}$

19. Let $\mathbf{F}(x, y, z) = 3x^2\mathbf{i} + \left(\frac{z^2}{y}\right)\mathbf{j} + (2z \ln y)\mathbf{k} \Rightarrow \frac{\partial P}{\partial y} = \frac{2z}{y} = \frac{\partial N}{\partial z}, \frac{\partial M}{\partial z} = 0 = \frac{\partial P}{\partial x}, \frac{\partial N}{\partial x} = 0 = \frac{\partial M}{\partial y}$
 $\Rightarrow M \, dx + N \, dy + P \, dz$ is exact; $\frac{\partial f}{\partial x} = 3x^2 \Rightarrow f(x, y, z) = x^3 + g(y, z) \Rightarrow \frac{\partial f}{\partial y} = \frac{\partial g}{\partial y} = \frac{z^2}{y} \Rightarrow g(y, z) = z^2 \ln y + h(z)$
 $\Rightarrow f(x, y, z) = x^3 + z^2 \ln y + h(z) \Rightarrow \frac{\partial f}{\partial z} = 2z \ln y + h'(z) = 2z \ln y \Rightarrow h'(z) = 0 \Rightarrow h(z) = C$
 $\Rightarrow f(x, y, z) = x^3 + z^2 \ln y + C \Rightarrow \int_{(1,1,1)}^{(1,2,3)} 3x^2 \, dx + \frac{z^2}{y} \, dy + 2z \ln y \, dz = f(1, 2, 3) - f(1, 1, 1)$
 $= (1 + 9 \ln 2 + C) - (1 + 0 + C) = 9 \ln 2$

20. Let $\mathbf{F}(x, y, z) = (2x \ln y - yz)\mathbf{i} + \left(\frac{x^2}{y} - xz\right)\mathbf{j} - (xy)\mathbf{k} \Rightarrow \frac{\partial P}{\partial y} = -x = \frac{\partial N}{\partial z}, \frac{\partial M}{\partial z} = -y = \frac{\partial P}{\partial x}, \frac{\partial N}{\partial x} = \frac{2x}{y} - z = \frac{\partial M}{\partial y}$
 $\Rightarrow M \, dx + N \, dy + P \, dz$ is exact; $\frac{\partial f}{\partial x} = 2x \ln y - yz \Rightarrow f(x, y, z) = x^2 \ln y - xyz + g(y, z) \Rightarrow \frac{\partial f}{\partial y} = \frac{x^2}{y} - xz + \frac{\partial g}{\partial y}$
 $= \frac{x^2}{y} - xz \Rightarrow \frac{\partial g}{\partial y} = 0 \Rightarrow g(y, z) = h(z) \Rightarrow f(x, y, z) = x^2 \ln y - xyz + h(z) \Rightarrow \frac{\partial f}{\partial z} = -xy + h'(z) = -xy \Rightarrow h'(z) = 0$
 $\Rightarrow h(z) = C \Rightarrow f(x, y, z) = x^2 \ln y - xyz + C \Rightarrow \int_{(1,2,1)}^{(2,1,1)} (2x \ln y - yz) \, dx + \left(\frac{x^2}{y} - xz\right) \, dy - xy \, dz$
 $= f(2, 1, 1) - f(1, 2, 1) = (4 \ln 1 - 2 + C) - (\ln 2 - 2 + C) = -\ln 2$

21. Let $\mathbf{F}(x, y, z) = \left(\frac{1}{y}\right)\mathbf{i} + \left(\frac{1}{z} - \frac{x}{y^2}\right)\mathbf{j} - \left(\frac{y}{z^2}\right)\mathbf{k} \Rightarrow \frac{\partial P}{\partial y} = -\frac{1}{y^2} = \frac{\partial N}{\partial z}, \frac{\partial M}{\partial z} = 0 = \frac{\partial P}{\partial x}, \frac{\partial N}{\partial x} = -\frac{1}{y^2} = \frac{\partial M}{\partial y}$
 $\Rightarrow M \, dx + N \, dy + P \, dz$ is exact; $\frac{\partial f}{\partial x} = \frac{1}{y} \Rightarrow f(x, y, z) = \frac{x}{y} + g(y, z) \Rightarrow \frac{\partial f}{\partial y} = -\frac{x}{y^2} + \frac{\partial g}{\partial y} = \frac{1}{z} - \frac{x}{y^2}$

$$\begin{aligned} \Rightarrow \frac{\partial g}{\partial y} = \frac{1}{z} &\Rightarrow g(y, z) = \frac{y}{z} + h(z) \Rightarrow f(x, y, z) = \frac{x}{y} + \frac{y}{z} + h(z) \Rightarrow \frac{\partial f}{\partial z} = -\frac{y}{z^2} + h'(z) = -\frac{y}{z^2} \Rightarrow h'(z) = 0 \Rightarrow h(z) = C \\ \Rightarrow f(x, y, z) = \frac{x}{y} + \frac{y}{z} + C &\Rightarrow \int_{(1,1,1)}^{(2,2,2)} \frac{1}{y} dx + \left(\frac{1}{z} - \frac{x}{y^2}\right) dy - \frac{y}{z^2} dz = f(2, 2, 2) - f(1, 1, 1) = \left(\frac{2}{2} + \frac{2}{2} + C\right) - \left(\frac{1}{1} + \frac{1}{1} + C\right) \\ &= 0 \end{aligned}$$

22. Let $\mathbf{F}(x, y, z) = \frac{2x\mathbf{i} + 2y\mathbf{j} + 2z\mathbf{k}}{x^2 + y^2 + z^2}$ (and let $\rho^2 = x^2 + y^2 + z^2 \Rightarrow \frac{\partial \rho}{\partial x} = \frac{x}{\rho}, \frac{\partial \rho}{\partial y} = \frac{y}{\rho}, \frac{\partial \rho}{\partial z} = \frac{z}{\rho}$)

$$\begin{aligned} \Rightarrow \frac{\partial P}{\partial y} = -\frac{4yz}{\rho^4} = \frac{\partial N}{\partial z}, \frac{\partial M}{\partial z} = -\frac{4xz}{\rho^4} = \frac{\partial P}{\partial x}, \frac{\partial N}{\partial x} = -\frac{4xy}{\rho^4} = \frac{\partial M}{\partial y} &\Rightarrow M dx + N dy + P dz \text{ is exact;} \\ \frac{\partial f}{\partial x} = \frac{2x}{x^2 + y^2 + z^2} &\Rightarrow f(x, y, z) = \ln(x^2 + y^2 + z^2) + g(y, z) \Rightarrow \frac{\partial f}{\partial y} = \frac{2y}{x^2 + y^2 + z^2} + \frac{\partial g}{\partial y} = \frac{2y}{x^2 + y^2 + z^2} \\ \Rightarrow \frac{\partial g}{\partial y} = 0 &\Rightarrow g(y, z) = h(z) \Rightarrow f(x, y, z) = \ln(x^2 + y^2 + z^2) + h(z) \Rightarrow \frac{\partial f}{\partial z} = \frac{2z}{x^2 + y^2 + z^2} + h'(z) \\ &= \frac{2z}{x^2 + y^2 + z^2} \Rightarrow h'(z) = 0 \Rightarrow h(z) = C \Rightarrow f(x, y, z) = \ln(x^2 + y^2 + z^2) + C \\ \Rightarrow \int_{(-1,-1,-1)}^{(2,2,2)} \frac{2x dx + 2y dy + 2z dz}{x^2 + y^2 + z^2} &= f(2, 2, 2) - f(-1, -1, -1) = \ln 12 - \ln 3 = \ln 4 \end{aligned}$$

23. $\mathbf{r} = (\mathbf{i} + \mathbf{j} + \mathbf{k}) + t(\mathbf{i} + 2\mathbf{j} - 2\mathbf{k}) = (1+t)\mathbf{i} + (1+2t)\mathbf{j} + (1-2t)\mathbf{k}, 0 \leq t \leq 1 \Rightarrow dx = dt, dy = 2 dt, dz = -2 dt$

$$\Rightarrow \int_{(1,1,1)}^{(2,3,-1)} y dx + x dy + 4 dz = \int_0^1 (2t+1) dt + (t+1)(2 dt) + 4(-2) dt = \int_0^1 (4t-5) dt = \left[2t^2 - 5t\right]_0^1 = -3$$

24. $\mathbf{r} = t(3\mathbf{j} + 4\mathbf{k}), 0 \leq t \leq 1 \Rightarrow dx = 0, dy = 3 dt, dz = 4 dt \Rightarrow \int_{(0,0,0)}^{(0,3,4)} x^2 dx + yz dy + \left(\frac{y^2}{2}\right) dz$

$$= \int_0^1 (12t^2)(3 dt) + \left(\frac{9t^2}{2}\right)(4 dt) = \int_0^1 54t^2 dt = \left[18t^3\right]_0^1 = 18$$

25. $\frac{\partial P}{\partial y} = 0 = \frac{\partial N}{\partial z}, \frac{\partial M}{\partial z} = 2z = \frac{\partial P}{\partial x}, \frac{\partial N}{\partial x} = 0 = \frac{\partial M}{\partial y} \Rightarrow M dx + N dy + P dz$ is exact $\Rightarrow \mathbf{F}$ is conservative \Rightarrow path independence

26. $\frac{\partial P}{\partial y} = -\frac{yz}{(\sqrt{x^2 + y^2 + z^2})^3} = \frac{\partial N}{\partial z}, \frac{\partial M}{\partial z} = -\frac{xz}{(\sqrt{x^2 + y^2 + z^2})^3} = \frac{\partial P}{\partial x}, \frac{\partial N}{\partial x} = -\frac{xy}{(\sqrt{x^2 + y^2 + z^2})^3} = \frac{\partial M}{\partial y}$

$\Rightarrow M dx + N dy + P dz$ is exact $\Rightarrow \mathbf{F}$ is conservative \Rightarrow path independence

27. $\frac{\partial P}{\partial y} = 0 = \frac{\partial N}{\partial z}, \frac{\partial M}{\partial z} = 0 = \frac{\partial P}{\partial x}, \frac{\partial N}{\partial x} = -\frac{2x}{y^2} = \frac{\partial M}{\partial y} \Rightarrow \mathbf{F}$ is conservative \Rightarrow there exists an f so that $\mathbf{F} = \nabla f$;

$$\frac{\partial f}{\partial x} = \frac{2x}{y} \Rightarrow f(x, y) = \frac{x^2}{y} + g(y) \Rightarrow \frac{\partial f}{\partial y} = -\frac{x^2}{y^2} + g'(y) = \frac{1-x^2}{y^2} \Rightarrow g'(y) = \frac{1}{y^2} \Rightarrow g(y) = -\frac{1}{y} + C$$

$$\Rightarrow f(x, y) = \frac{x^2}{y} - \frac{1}{y} + C \Rightarrow \mathbf{F} = \nabla\left(\frac{x^2-1}{y}\right)$$

28. $\frac{\partial P}{\partial y} = \cos z = \frac{\partial N}{\partial z}, \frac{\partial M}{\partial z} = 0 = \frac{\partial P}{\partial x}, \frac{\partial N}{\partial x} = \frac{e^x}{y} = \frac{\partial M}{\partial y} \Rightarrow \mathbf{F}$ is conservative \Rightarrow there exists an f so that $\mathbf{F} = \nabla f$;

$$\frac{\partial f}{\partial x} = e^x \ln y \Rightarrow f(x, y, z) = e^x \ln y + g(y, z) \Rightarrow \frac{\partial f}{\partial y} = \frac{e^x}{y} + \frac{\partial g}{\partial y} = \frac{e^x}{y} + \sin z \Rightarrow \frac{\partial g}{\partial y} = \sin z \Rightarrow g(y, z)$$

$$= y \sin z + h(z) \Rightarrow f(x, y, z) = e^x \ln y + y \sin z + h(z) \Rightarrow \frac{\partial f}{\partial z} = y \cos z + h'(z) = y \cos z \Rightarrow h'(z) = 0$$

$$\Rightarrow h(z) = C \Rightarrow f(x, y, z) = e^x \ln y + y \sin z + C \Rightarrow \mathbf{F} = \nabla(e^x \ln y + y \sin z)$$

29. $\frac{\partial P}{\partial y} = 0 = \frac{\partial N}{\partial z}, \frac{\partial M}{\partial y} = 0 = \frac{\partial P}{\partial x}, \frac{\partial N}{\partial x} = 1 = \frac{\partial M}{\partial y} \Rightarrow \mathbf{F}$ is conservative \Rightarrow there exists an f so that $\mathbf{F} = \nabla f$;

$$\frac{\partial f}{\partial x} = x^2 + y \Rightarrow f(x, y, z) = \frac{1}{3}x^3 + xy + g(y, z) \Rightarrow \frac{\partial f}{\partial y} = x + \frac{\partial g}{\partial y} = y^2 + x \Rightarrow \frac{\partial g}{\partial y} = y^2 \Rightarrow g(y, z) = \frac{1}{3}y^3 + h(z)$$

$$\Rightarrow f(x, y, z) = \frac{1}{3}x^3 + xy + \frac{1}{3}y^3 + h(z) \Rightarrow \frac{\partial f}{\partial z} = h'(z) = ze^z \Rightarrow h(z) = ze^z - e^z + C$$

$$\Rightarrow f(x, y, z) = \frac{1}{3}x^3 + xy + \frac{1}{3}y^3 + ze^z - e^z + C \Rightarrow \mathbf{F} = \nabla\left(\frac{1}{3}x^3 + xy + \frac{1}{3}y^3 + ze^z - e^z\right)$$

(a) work $= \int_A^B \mathbf{F} \cdot d\mathbf{r} = \int_A^B \mathbf{F} \cdot d\mathbf{r} = \left[\frac{1}{3}x^3 + xy + \frac{1}{3}y^3 + ze^z - e^z\right]_{(1,0,0)}^{(1,0,1)} = \left(\frac{1}{3} + 0 + 0 + e - e\right) - \left(\frac{1}{3} + 0 + 0 - 1\right) = 1$

(b) work $= \int_A^B \mathbf{F} \cdot d\mathbf{r} = \left[\frac{1}{3}x^3 + xy + \frac{1}{3}y^3 + ze^z - e^z\right]_{(1,0,0)}^{(1,0,1)} = 1$

(c) work $= \int_A^B \mathbf{F} \cdot d\mathbf{r} = \left[\frac{1}{3}x^3 + xy + \frac{1}{3}y^3 + ze^z - e^z\right]_{(1,0,0)}^{(1,0,1)} = 1$

Note: Since \mathbf{F} is conservative, $\int_A^B \mathbf{F} \cdot d\mathbf{r}$ is independent of the path from $(1, 0, 0)$ to $(1, 0, 1)$.

30. $\frac{\partial P}{\partial y} = xe^{yz} + xye^{yz} + \cos y = \frac{\partial N}{\partial z}, \frac{\partial M}{\partial z} = ye^{yz} = \frac{\partial P}{\partial x}, \frac{\partial N}{\partial x} = ze^{yz} = \frac{\partial M}{\partial y} \Rightarrow \mathbf{F}$ is conservative \Rightarrow there exists an f so that $\mathbf{F} = \nabla f$;

$$\frac{\partial f}{\partial x} = e^{yz} \Rightarrow f(x, y, z) = xe^{yz} + g(y, z) \Rightarrow \frac{\partial f}{\partial y} = xze^{yz} + \frac{\partial g}{\partial y} = xze^{yz} + z \cos y \Rightarrow \frac{\partial g}{\partial y} = z \cos y$$

$$\Rightarrow g(y, z) = z \sin y + h(z) \Rightarrow f(x, y, z) = xe^{yz} + z \sin y + h(z) \Rightarrow \frac{\partial f}{\partial z} = xye^{yz} + \sin y + h'(z) = xye^{yz} + \sin y$$

$$\Rightarrow h'(z) = 0 \Rightarrow h(z) = C \Rightarrow f(x, y, z) = xe^{yz} + z \sin y + C \Rightarrow \mathbf{F} = \nabla(xe^{yz} + z \sin y)$$

(a) work $= \int_A^B \mathbf{F} \cdot d\mathbf{r} = \left[xe^{yz} + z \sin y\right]_{(1,0,1)}^{(1,\pi/2,0)} = (1+0) - (1+0) = 0$

(b) work $= \int_A^B \mathbf{F} \cdot d\mathbf{r} = \left[xe^{yz} + z \sin y\right]_{(1,0,1)}^{(1,\pi/2,0)} = 0$

(c) work $= \int_A^B \mathbf{F} \cdot d\mathbf{r} = \left[xe^{yz} + z \sin y\right]_{(1,0,1)}^{(1,\pi/2,0)} = 0$

Note: Since \mathbf{F} is conservative, $\int_A^B \mathbf{F} \cdot d\mathbf{r}$ is independent of the path from $(1, 0, 1)$ to $(1, \frac{\pi}{2}, 0)$.

31. (a) $\mathbf{F} = \nabla(x^3y^2) \Rightarrow \mathbf{F} = 3x^2y^2\mathbf{i} + 2x^3y\mathbf{j}$; let C_1 be the path from $(-1, 1)$ to $(0, 0) \Rightarrow x = t - 1$ and $y = -t + 1, 0 \leq t \leq 1 \Rightarrow \mathbf{F} = 3(t-1)^2(-t+1)^2\mathbf{i} + 2(t-1)^3(-t+1)\mathbf{j} = 3(t-1)^4\mathbf{i} - 2(t-1)^4\mathbf{j}$ and $\mathbf{r}_1 = (t-1)\mathbf{i} + (-t+1)\mathbf{j} \Rightarrow d\mathbf{r}_1 = dt\mathbf{i} - dt\mathbf{j} \Rightarrow \int_{C_1} \mathbf{F} \cdot d\mathbf{r}_1 = \int_0^1 [3(t-1)^4 + 2(t-1)^4] dt$

$$= \int_0^1 5(t-1)^4 dt = \left[(t-1)^5\right]_0^1 = 1$$

let C_2 be the path from $(0, 0)$ to $(1, 1) \Rightarrow x = t$ and $y = t, 0 \leq t \leq 1 \Rightarrow \mathbf{F} = 3t^4\mathbf{i} + 2t^4\mathbf{j}$ and $\mathbf{r}_2 = t\mathbf{i} + t\mathbf{j} \Rightarrow d\mathbf{r}_2 = dt\mathbf{i} + dt\mathbf{j} \Rightarrow \int_{C_2} \mathbf{F} \cdot d\mathbf{r}_2 = \int_0^1 (3t^4 + 2t^4) dt$

$$= \int_0^1 5t^4 dt = 1 \Rightarrow \int_C \mathbf{F} \cdot d\mathbf{r} = \int_{C_1} \mathbf{F} \cdot d\mathbf{r}_1 + \int_{C_2} \mathbf{F} \cdot d\mathbf{r}_2 = 2$$

(b) Since $f(x, y) = x^3 y^2$ is a potential function for \mathbf{F} , $\int_{(-1,1)}^{(1,1)} \mathbf{F} \cdot d\mathbf{r} = f(1, 1) - f(-1, 1) = 2$

32. $\frac{\partial P}{\partial y} = 0 = \frac{\partial N}{\partial z}$, $\frac{\partial M}{\partial z} = 0 = \frac{\partial P}{\partial x}$, $\frac{\partial N}{\partial x} = -2x \sin y = \frac{\partial M}{\partial y} \Rightarrow \mathbf{F}$ is conservative \Rightarrow there exists an f so that $\mathbf{F} = \nabla f$;
 $\frac{\partial f}{\partial x} = 2x \cos y \Rightarrow f(x, y, z) = x^2 \cos y + g(y, z) \Rightarrow \frac{\partial f}{\partial y} = -x^2 \sin y + \frac{\partial g}{\partial y} = -x^2 \sin y \Rightarrow \frac{\partial g}{\partial y} = 0 \Rightarrow g(y, z) = h(z)$
 $\Rightarrow f(x, y, z) = x^2 \cos y + h(z) \Rightarrow \frac{\partial f}{\partial z} = h'(z) = 0 \Rightarrow h(z) = C \Rightarrow f(x, y, z) = x^2 \cos y + C \Rightarrow \mathbf{F} = \nabla(x^2 \cos y)$

(a) $\int_C 2x \cos y \, dx - x^2 \sin y \, dy = \left[x^2 \cos y \right]_{(1,0)}^{(0,1)} = 0 - 1 = -1$

(b) $\int_C 2x \cos y \, dx - x^2 \sin y \, dy = \left[x^2 \cos y \right]_{(-1,\pi)}^{(1,0)} = 1 - (-1) = 2$

(c) $\int_C 2x \cos y \, dx - x^2 \sin y \, dy = \left[x^2 \cos y \right]_{(-1,0)}^{(1,0)} = 1 - 1 = 0$

(d) $\int_C 2x \cos y \, dx - x^2 \sin y \, dy = \left[x^2 \cos y \right]_{(1,0)}^{(1,0)} = 1 - 1 = 0$

33. (a) If the differential form is exact, then $\frac{\partial P}{\partial y} = \frac{\partial N}{\partial z} \Rightarrow 2ay = cy$ for all $y \Rightarrow 2a = c$, $\frac{\partial M}{\partial z} = \frac{\partial P}{\partial x} \Rightarrow 2cx = 2cx$ for all x , and $\frac{\partial N}{\partial x} = \frac{\partial M}{\partial y} \Rightarrow by = 2ay$ for all $y \Rightarrow b = 2a$ and $c = 2a$

(b) $\mathbf{F} = \nabla f \Rightarrow$ the differential form with $a = 1$ in part (a) is exact $\Rightarrow b = 2$ and $c = 2$

34. $\mathbf{F} = \nabla f \Rightarrow g(x, y, z) = \int_{(0,0,0)}^{(x,y,z)} \mathbf{F} \cdot d\mathbf{r} = \int_{(0,0,0)}^{(x,y,z)} \nabla f \cdot d\mathbf{r} = f(x, y, z) - f(0, 0, 0) \Rightarrow \frac{\partial g}{\partial x} = \frac{\partial f}{\partial x} - 0$, $\frac{\partial g}{\partial y} = \frac{\partial f}{\partial y} - 0$, and $\frac{\partial g}{\partial z} = \frac{\partial f}{\partial z} - 0 \Rightarrow \nabla g = \nabla f = \mathbf{F}$, as claimed

35. The path will not matter; the work along any path will be the same because the field is conservative.

36. The field is not conservative, for otherwise the work would be the same along C_1 and C_2 .

37. Let the coordinates of points A and B be (x_A, y_A, z_A) and (x_B, y_B, z_B) , respectively. The force $\mathbf{F} = a\mathbf{i} + b\mathbf{j} + c\mathbf{k}$ is conservative because all the partial derivatives of M, N , and P are zero. Therefore, the potential function is $f(x, y, z) = ax + by + cz + C$, and the work done by the force in moving a particle along any path from A to B is $f(B) - f(A) = f(x_B, y_B, z_B) - f(x_A, y_A, z_A)$
 $= (ax_B + by_B + cz_B + C) - (ax_A + by_A + cz_A + C) = a(x_B - x_A) + b(y_B - y_A) + c(z_B - z_A) = \mathbf{F} \cdot \overline{BA}$

38. (a) Let $-GmM = C \Rightarrow \mathbf{F} = C \left[\frac{x}{(x^2+y^2+z^2)^{3/2}} \mathbf{i} + \frac{y}{(x^2+y^2+z^2)^{3/2}} \mathbf{j} + \frac{z}{(x^2+y^2+z^2)^{3/2}} \mathbf{k} \right]$
 $\Rightarrow \frac{\partial P}{\partial y} = \frac{-3yzC}{(x^2+y^2+z^2)^{5/2}} = \frac{\partial N}{\partial z}$, $\frac{\partial M}{\partial z} = \frac{-3xzC}{(x^2+y^2+z^2)^{5/2}} = \frac{\partial P}{\partial x}$, $\frac{\partial N}{\partial x} = \frac{-3xyC}{(x^2+y^2+z^2)^{5/2}} = \frac{\partial M}{\partial y} \Rightarrow \mathbf{F} = \nabla f$ for some f ;
 $\frac{\partial f}{\partial x} = \frac{xC}{(x^2+y^2+z^2)^{3/2}} \Rightarrow f(x, y, z) = -\frac{C}{(x^2+y^2+z^2)^{1/2}} + g(y, z) \Rightarrow \frac{\partial f}{\partial y} = \frac{yC}{(x^2+y^2+z^2)^{3/2}} + \frac{\partial g}{\partial y}$

$$= \frac{yC}{(x^2+y^2+z^2)^{3/2}} \Rightarrow \frac{\partial g}{\partial y} = 0 \Rightarrow g(y, z) = h(z) \Rightarrow \frac{\partial f}{\partial z} = \frac{zC}{(x^2+y^2+z^2)^{3/2}} + h'(z) = \frac{zC}{(x^2+y^2+z^2)^{3/2}}$$

$$\Rightarrow h(z) = C_1 \Rightarrow f(x, y, z) = -\frac{C}{(x^2+y^2+z^2)^{1/2}} + C_1. \text{ Let } C_1 = 0 \Rightarrow f(x, y, z) = \frac{GmM}{(x^2+y^2+z^2)^{1/2}} \text{ is a potential}$$

function for \mathbf{F} .

- (b) If s is the distance of (x, y, z) from the origin, then $s = \sqrt{x^2 + y^2 + z^2}$. The work done by the gravitational field \mathbf{F} is work $= \int_{P_1}^{P_2} \mathbf{F} \cdot d\mathbf{r} = \left[\frac{GmM}{\sqrt{x^2+y^2+z^2}} \right]_{P_1}^{P_2} = \frac{GmM}{s_2} - \frac{GmM}{s_1} = GmM \left(\frac{1}{s_2} - \frac{1}{s_1} \right)$, as claimed.

16.4 GREEN'S THEOREM IN THE PLANE

1. $M = -y = -a \sin t$, $N = x = a \cos t$, $dx = -a \sin t dt$, $dy = a \cos t dt \Rightarrow \frac{\partial M}{\partial y} = 0$, $\frac{\partial M}{\partial x} = -1$, $\frac{\partial N}{\partial x} = 1$, and $\frac{\partial N}{\partial y} = 0$;

$$\text{Equation (3): } \oint_C M dy - N dx = \int_0^{2\pi} [(-a \sin t)(a \cos t) - (a \cos t)(-a \sin t)] dt = \int_0^{2\pi} 0 dt = 0;$$

$$\iint_R \left(\frac{\partial M}{\partial x} + \frac{\partial N}{\partial y} \right) dx dy = \iint_R 0 dx dy = 0, \text{ Flux}$$

$$\text{Equation (4): } \oint_C M dx + N dy = \int_0^{2\pi} [(-a \sin t)(-a \sin t) - (a \cos t)(a \cos t)] dt = \int_0^{2\pi} a^2 dt = 2\pi a^2;$$

$$\iint_R \left(\frac{\partial N}{\partial x} - \frac{\partial M}{\partial y} \right) dx dy = \int_{-a}^a \int_{-c}^{\sqrt{a^2-x^2}} 2 dy dx = \int_{-a}^a 4\sqrt{a^2-x^2} dx = 4 \left[\frac{x}{2} \sqrt{a^2-x^2} + \frac{a^2}{2} \sin^{-1} \frac{x}{a} \right]_{-a}^a$$

$$= 2a^2 \left(\frac{\pi}{2} + \frac{\pi}{2} \right) = 2a^2\pi, \text{ Circulation}$$

2. $M = y = a \sin t$, $N = 0$, $dx = -a \sin t dt$, $dy = a \cos t dt \Rightarrow \frac{\partial M}{\partial x} = 0$, $\frac{\partial M}{\partial y} = 1$, $\frac{\partial N}{\partial x} = 0$, and $\frac{\partial N}{\partial y} = 0$;

$$\text{Equation (3): } \oint_C M dy - N dx = \int_0^{2\pi} a^2 \sin t \cos t dt = a^2 \left[\frac{1}{2} \sin^2 t \right]_0^{2\pi} = 0; \iint_R 0 dx dy = 0, \text{ Flux}$$

$$\text{Equation (4): } \oint_C M dx + N dy = \int_0^{2\pi} (-a^2 \sin^2 t) dt = -a^2 \left[\frac{t}{2} - \frac{\sin 2t}{4} \right]_0^{2\pi} = -\pi a^2;$$

$$\iint_R \left(\frac{\partial N}{\partial x} - \frac{\partial M}{\partial y} \right) dx dy = \iint_R -1 dx dy = \int_0^{2\pi} \int_0^a -r dr d\theta = \int_0^{2\pi} -\frac{a^2}{2} d\theta = -\pi a^2, \text{ Circulation}$$

3. $M = 2x = 2a \cos t$, $N = -3y = -3a \sin t$, $dx = -a \sin t dt$, $dy = a \cos t dt \Rightarrow \frac{\partial M}{\partial x} = 2$, $\frac{\partial M}{\partial y} = 0$, $\frac{\partial N}{\partial x} = 0$, and $\frac{\partial N}{\partial y} = -3$;

$$\text{Equation (3): } \oint_C M dy - N dx = \int_0^{2\pi} [(2a \cos t)(a \cos t) + (3a \sin t)(-a \sin t)] dt$$

$$= \int_0^{2\pi} (2a^2 \cos^2 t - 3a^2 \sin^2 t) dt = 2a^2 \left[\frac{t}{2} + \frac{\sin 2t}{4} \right]_0^{2\pi} - 3a^2 \left[\frac{t}{2} - \frac{\sin 2t}{4} \right]_0^{2\pi} = 2\pi a^2 - 3\pi a^2 = -\pi a^2;$$

$$\iint_R \left(\frac{\partial M}{\partial x} + \frac{\partial N}{\partial y} \right) dx dy = \iint_R -1 dx dy = \int_0^{2\pi} \int_0^a -r dr d\theta = \int_0^{2\pi} -\frac{a^2}{2} d\theta = -\pi a^2, \text{ Flux}$$

$$\text{Equation (4): } \oint_C M dx + N dy = \int_0^{2\pi} [(2a \cos t)(-a \sin t) + (-3a \sin t)(a \cos t)] dt$$

$$= \int_0^{2\pi} (-2a^2 \sin t \cos t - 3a^2 \sin t \cos t) dt = -5a^2 \left[\frac{1}{2} \sin^2 t \right]_0^{2\pi} = 0; \iint_R 0 dx dy = 0, \text{ Circulation}$$

4. $M = -x^2y = -a^3 \cos^2 t$, $N = xy^2 = a^3 \cos t \sin^2 t$, $dx = -a \sin t dt$, $dy = a \cos t dt$
 $\Rightarrow \frac{\partial M}{\partial x} = -2xy$, $\frac{\partial M}{\partial y} = -x^2$, $\frac{\partial N}{\partial x} = y^2$, and $\frac{\partial N}{\partial y} = 2xy$;
Equation (3): $\oint_C M dy - N dx = \int_0^{2\pi} \left(-a^4 \cos^3 t \sin t + a^4 \cos t \sin^3 t \right) dt = \left[\frac{a^4}{4} \cos^4 t + \frac{a^4}{4} \sin^4 t \right]_0^{2\pi} = 0$;
 $\iint_R \left(\frac{\partial M}{\partial x} + \frac{\partial N}{\partial y} \right) dx dy = \iint_R (-2xy + 2xy) dx dy = 0$, Flux
Equation (4): $\oint_C M dx + N dy = \int_0^{2\pi} \left(a^4 \cos^2 t \sin^2 t + a^4 \cos^2 t \sin^2 t \right) dt = \int_0^{2\pi} \left(2a^4 \cos^2 t \sin^2 t \right) dt$
 $= \int_0^{2\pi} \frac{1}{2} a^4 \sin^2 2t dt = \frac{a^4}{4} \int_0^{4\pi} \sin^2 u du = \frac{a^4}{4} \left[\frac{u}{2} - \frac{\sin 2u}{4} \right]_0^{4\pi} = \frac{\pi a^4}{2}$; $\iint_R \left(\frac{\partial N}{\partial x} - \frac{\partial M}{\partial y} \right) dx dy = \iint_R (y^2 + x^2) dx dy$
 $= \int_0^{2\pi} \int_0^a r^2 \cdot r dr d\theta = \int_0^{2\pi} \frac{a^4}{4} d\theta = \frac{\pi a^4}{2}$, Circulation
5. $M = x - y$, $N = y - x \Rightarrow \frac{\partial M}{\partial x} = 1$, $\frac{\partial M}{\partial y} = -1$, $\frac{\partial N}{\partial x} = -1$, $\frac{\partial N}{\partial y} = 1 \Rightarrow \text{Flux} = \iint_R 2 dx dy = \int_0^1 \int_0^1 2 dx dy = 2$;
Circ = $\iint_R [-1 - (-1)] dx dy = 0$
6. $M = x^2 + 4y$, $N = x + y^2 \Rightarrow \frac{\partial M}{\partial x} = 2x$, $\frac{\partial M}{\partial y} = 4$, $\frac{\partial N}{\partial x} = 1$, $\frac{\partial N}{\partial y} = 2y \Rightarrow \text{Flux} = \iint_R (2x + 2y) dx dy$
 $= \int_0^1 \int_0^1 (2x + 2y) dx dy = \int_0^1 [x^2 + 2xy]_0^1 dy = \int_0^1 (1 + 2y) dy = [y + y^2]_0^1 = 2$; Circ = $\iint_R (1 - 4) dx dy$
 $= \int_0^1 \int_0^1 -3 dx dy = -3$
7. $M = y^2 - x^2$, $N = x^2 + y^2 \Rightarrow \frac{\partial M}{\partial x} = -2x$, $\frac{\partial M}{\partial y} = 2y$, $\frac{\partial N}{\partial x} = 2x$, $\frac{\partial N}{\partial y} = 2y \Rightarrow \text{Flux} = \iint_R (-2x + 2y) dx dy$
 $= \int_0^3 \int_0^x (-2x + 2y) dy dx = \int_0^3 (-2x^2 + x^2) dx = \left[-\frac{1}{3}x^3 \right]_0^3 = -9$; Circ = $\iint_R (2x - 2y) dx dy$
 $= \int_0^3 \int_0^x (2x - 2y) dy dx = \int_0^3 x^2 dx = 9$
8. $M = x + y$, $N = -(x^2 + y^2) \Rightarrow \frac{\partial M}{\partial x} = 1$, $\frac{\partial M}{\partial y} = 1$, $\frac{\partial N}{\partial x} = -2x$, $\frac{\partial N}{\partial y} = -2y \Rightarrow \text{Flux} = \iint_R (1 - 2y) dx dy$
 $= \int_0^1 \int_0^x (1 - 2y) dy dx = \int_0^1 (x - x^2) dx = \frac{1}{6}$; Circ = $\iint_R (-2x - 1) dx dy = \int_0^1 \int_0^x (-2x - 1) dy dx$
 $= \int_0^1 (-2x^2 - x) dx = -\frac{7}{6}$
9. $M = xy + y^2$, $N = x - y \Rightarrow \frac{\partial M}{\partial x} = y$, $\frac{\partial M}{\partial y} = x + 2y$, $\frac{\partial N}{\partial x} = 1$, $\frac{\partial N}{\partial y} = -1 \Rightarrow \text{Flux} = \iint_R (y + (-1)) dy dx$
 $= \int_0^1 \int_{x^2}^{\sqrt{x}} (y - 1) dy dx = \int_0^1 \left(\frac{1}{2}x - \sqrt{x} - \frac{1}{2}x^4 + x^2 \right) dx = -\frac{11}{60}$; Circ = $\iint_R (1 - (x + 2y)) dy dx$
 $= \int_0^1 \int_{x^2}^{\sqrt{x}} (1 - x - 2y) dy dx = \int_0^1 \left(\sqrt{x} - x^{3/2} - x - x^2 + x^3 + x^4 \right) dx = -\frac{7}{60}$

$$10. \quad M = x + 3y, N = 2x - y \Rightarrow \frac{\partial M}{\partial x} = 1, \frac{\partial M}{\partial y} = 3, \frac{\partial N}{\partial x} = 2, \frac{\partial N}{\partial y} = -1 \Rightarrow \text{Flux} = \iint_R (1 + (-1)) \, dy \, dx = 0$$

$$\text{Circ} = \iint_R (2 - 3) \, dy \, dx = \int_{-\sqrt{2}}^{\sqrt{2}} \int_{-\sqrt{(2-x^2)/2}}^{\sqrt{(2-x^2)/2}} (-1) \, dy \, dx = -\frac{2}{\sqrt{2}} \int_{-\sqrt{2}}^{\sqrt{2}} \sqrt{2-x^2} \, dx = -\pi\sqrt{2}$$

$$11. \quad M = x^3 y^2, N = \frac{1}{2} x^4 y \Rightarrow \frac{\partial M}{\partial x} = 3x^2 y^2, \frac{\partial M}{\partial y} = 2x^3 y, \frac{\partial N}{\partial x} = 2x^3 y, \frac{\partial N}{\partial y} = \frac{1}{2} x^4 \Rightarrow \text{Flux} = \iint_R \left(3x^2 y^2 + \frac{1}{2} x^4 \right) \, dy \, dx \\ = \int_0^2 \int_{x^2-x}^x \left(3x^2 y^2 + \frac{1}{2} x^4 \right) \, dy \, dx = \int_0^2 \left(3x^5 - \frac{7}{2} x^6 + 3x^7 - x^8 \right) \, dx = \frac{64}{9}; \text{Circ} = \iint_R \left(2x^3 y - 2x^3 y \right) \, dy \, dx = 0$$

$$12. \quad M = \frac{x}{1+y^2}, N = \tan^{-1} y \Rightarrow \frac{\partial M}{\partial x} = \frac{1}{1+y^2}, \frac{\partial M}{\partial y} = \frac{-2xy}{(1+y^2)^2}, \frac{\partial N}{\partial x} = 0, \frac{\partial N}{\partial y} = \frac{1}{1+y^2} \Rightarrow \text{Flux} = \iint_R \left(\frac{1}{1+y^2} + \frac{1}{1+y^2} \right) \, dx \, dy \\ = \int_{-1}^1 \int_{-\sqrt{1-y^2}}^{\sqrt{1-y^2}} \frac{2}{1+y^2} \, dx \, dy = \int_{-1}^1 \frac{4\sqrt{1-y^2}}{1+y^2} \, dx = 4\pi\sqrt{2} - 4\pi; \text{Circ} = \iint_R \left(0 - \left(\frac{-2xy}{(1+y^2)^2} \right) \right) \, dy \, dx \\ = \int_{-1}^1 \int_{-\sqrt{1-y^2}}^{\sqrt{1-y^2}} \left(\frac{2xy}{(1+y^2)^2} \right) \, dy \, dx = \int_{-1}^1 (0) \, dx = 0$$

$$13. \quad M = x + e^x \sin y, N = x + e^x \cos y \Rightarrow \frac{\partial M}{\partial x} = 1 + e^x \sin y, \frac{\partial M}{\partial y} = e^x \cos y, \frac{\partial N}{\partial x} = 1 + e^x \cos y, \frac{\partial N}{\partial y} = -e^x \sin y \\ \Rightarrow \text{Flux} = \iint_R \, dx \, dy = \int_{-\pi/4}^{\pi/4} \int_0^{\sqrt{\cos 2\theta}} r \, dr \, d\theta = \int_{-\pi/4}^{\pi/4} \left(\frac{1}{2} \cos 2\theta \right) \, d\theta = \left[\frac{1}{4} \sin 2\theta \right]_{-\pi/4}^{\pi/4} = \frac{1}{2}; \\ \text{Circ} = \iint_R \left(1 + e^x \cos y - e^x \cos y \right) \, dx \, dy = \iint_R \, dx \, dy = \int_{-\pi/4}^{\pi/4} \int_0^{\sqrt{\cos 2\theta}} r \, dr \, d\theta = \int_{-\pi/4}^{\pi/4} \left(\frac{1}{2} \cos 2\theta \right) \, d\theta = \frac{1}{2}$$

$$14. \quad M = \tan^{-1} \frac{y}{x}, N = \ln(x^2 + y^2) \Rightarrow \frac{\partial M}{\partial x} = \frac{-y}{x^2 + y^2}, \frac{\partial M}{\partial y} = \frac{x}{x^2 + y^2}, \frac{\partial N}{\partial x} = \frac{2x}{x^2 + y^2}, \frac{\partial N}{\partial y} = \frac{2y}{x^2 + y^2} \\ \Rightarrow \text{Flux} = \iint_R \left(\frac{-y}{x^2 + y^2} + \frac{2y}{x^2 + y^2} \right) \, dx \, dy = \int_0^{\pi} \int_1^2 \left(\frac{r \sin \theta}{r^2} \right) r \, dr \, d\theta = \int_0^{\pi} \sin \theta \, d\theta = 2; \\ \text{Circ} = \iint_R \left(\frac{2x}{x^2 + y^2} - \frac{x}{x^2 + y^2} \right) \, dx \, dy = \int_0^{\pi} \int_1^2 \left(\frac{r \cos \theta}{r^2} \right) r \, dr \, d\theta = \int_0^{\pi} \cos \theta \, d\theta = 0$$

$$15. \quad M = xy, N = y^2 \Rightarrow \frac{\partial M}{\partial x} = y, \frac{\partial M}{\partial y} = x, \frac{\partial N}{\partial x} = 0, \frac{\partial N}{\partial y} = 2y \Rightarrow \text{Flux} = \iint_R (y + 2y) \, dy \, dx = \int_0^1 \int_{x^2}^x 3y \, dy \, dx \\ = \int_0^1 \left(\frac{3x^2}{2} - \frac{3x^4}{2} \right) \, dx = \frac{1}{5}; \text{Circ} = \iint_R -x \, dy \, dx = \int_0^1 \int_{x^2}^x -x \, dy \, dx = \int_0^1 (-x^2 + x^3) \, dx = -\frac{1}{12}$$

$$16. \quad M = -\sin y, N = x \cos y \Rightarrow \frac{\partial M}{\partial x} = 0, \frac{\partial M}{\partial y} = -\cos y, \frac{\partial N}{\partial x} = \cos y, \frac{\partial N}{\partial y} = -x \sin y \\ \Rightarrow \text{Flux} = \iint_R (-x \sin y) \, dx \, dy = \int_0^{\pi/2} \int_0^{\pi/2} (-x \sin y) \, dx \, dy = \int_0^{\pi/2} \left(-\frac{\pi^2}{8} \sin y \right) \, dy = -\frac{\pi^2}{8}; \\ \text{Circ} = \iint_R [\cos y - (-\cos y)] \, dx \, dy = \int_0^{\pi/2} \int_0^{\pi/2} 2 \cos y \, dx \, dy = \int_0^{\pi/2} \pi \cos y \, dy = [\pi \sin y]_0^{\pi/2} = \pi$$

17. $M = 3xy - \frac{x}{1+y^2}$, $N = e^x + \tan^{-1} y \Rightarrow \frac{\partial M}{\partial x} = 3y - \frac{1}{1+y^2}$, $\frac{\partial N}{\partial y} = \frac{1}{1+y^2}$
 $\Rightarrow \text{Flux} = \iint_R \left(3y - \frac{1}{1+y^2} + \frac{1}{1+y^2} \right) dx dy = \iint_R 3y dx dy = \int_0^{2\pi} \int_0^{a(1+\cos\theta)} (3r \sin\theta)r dr d\theta$
 $= \int_0^{2\pi} a^3 (1+\cos\theta)^3 (\sin\theta) d\theta = \left[-\frac{a^3}{4} (1+\cos\theta)^4 \right]_0^{2\pi} = -4a^3 - (-4a^3) = 0$
18. $M = y + e^x \ln y$, $N = \frac{e^x}{y} \Rightarrow \frac{\partial M}{\partial y} = 1 + \frac{e^x}{y}$, $\frac{\partial N}{\partial x} = \frac{e^x}{y} \Rightarrow \text{Circ} = \iint_R \left[\frac{e^x}{y} - \left(1 + \frac{e^x}{y} \right) \right] dx dy = \iint_R (-1) dx dy$
 $= \int_{-1}^1 \int_{x^4+1}^{3-x^2} -dy dx = -\int_{-1}^1 \left[(3-x^2) - (x^4+1) \right] dx = \int_{-1}^1 (x^4 + x^2 - 2) dx = -\frac{44}{15}$
19. $M = 2xy^3$, $N = 4x^2y^2 \Rightarrow \frac{\partial M}{\partial y} = 6xy^2$, $\frac{\partial N}{\partial x} = 8xy^2 \Rightarrow \text{work} = \oint_C 2xy^3 dx + 4x^2y^2 dy = \iint_R (8xy^2 - 6xy^2) dx dy$
 $= \int_0^1 \int_0^{x^3} 2xy^2 dy dx = \int_0^1 \frac{2}{3} x^{10} dx = \frac{2}{33}$
20. $M = 4x - 2y$, $N = 2x - 4y \Rightarrow \frac{\partial M}{\partial y} = -2$, $\frac{\partial N}{\partial x} = 2 \Rightarrow \text{work} = \oint_C (4x - 2y) dx + (2x - 4y) dy$
 $= \iint_R [2 - (-2)] dx dy = 4 \iint_R dx dy = 4(\text{Area of the circle}) = 4(\pi \cdot 4) = 16\pi$
21. $M = y^2$, $N = x^2 \Rightarrow \frac{\partial M}{\partial y} = 2y$, $\frac{\partial N}{\partial x} = 2x \Rightarrow \oint_C y^2 dx + x^2 dy = \iint_R (2x - 2y) dy dx$
 $= \int_0^1 \int_0^{1-x} (2x - 2y) dy dx = \int_0^1 (-3x^2 + 4x - 1) dx = \left[-x^3 + 2x^2 - x \right]_0^1 = -1 + 2 - 1 = 0$
22. $M = 3y$, $N = 2x \Rightarrow \frac{\partial M}{\partial y} = 3$, $\frac{\partial N}{\partial x} = 2 \Rightarrow \oint_C 3y dx + 2x dy = \iint_R (2 - 3) dx dy = \int_0^\pi \int_0^{\sin x} (-1) dy dx$
 $= -\int_0^\pi \sin x dx = -2$
23. $M = 6y + x$, $N = y + 2x \Rightarrow \frac{\partial M}{\partial y} = 6$, $\frac{\partial N}{\partial x} = 2 \Rightarrow \oint_C (6y + x) dx + (y + 2x) dy = \iint_R (2 - 6) dy dx$
 $= -4(\text{Area of the circle}) = -16\pi$
24. $M = 2x + y^2$, $N = 2xy + 3y \Rightarrow \frac{\partial M}{\partial y} = 2y$, $\frac{\partial N}{\partial x} = 2y \Rightarrow \oint_C (2x + y^2) dx + (2xy + 3y) dy = \iint_R (2y - 2y) dx dy = 0$
25. $M = x = a \cos t$, $N = y = a \sin t \Rightarrow dx = -a \sin t dt$, $dy = a \cos t dt \Rightarrow \text{Area} = \frac{1}{2} \oint_C x dy - y dx$
 $= \frac{1}{2} \int_0^{2\pi} (a^2 \cos^2 t + a^2 \sin^2 t) dt = \frac{1}{2} \int_0^{2\pi} a^2 dt = \pi a^2$
26. $M = x = a \cos t$, $N = y = b \sin t \Rightarrow dx = -a \sin t dt$, $dy = b \cos t dt \Rightarrow \text{Area} = \frac{1}{2} \oint_C x dy - y dx$
 $= \frac{1}{2} \int_0^{2\pi} (ab \cos^2 t + ab \sin^2 t) dt = \frac{1}{2} \int_0^{2\pi} ab dt = \pi ab$

$$\begin{aligned}
 27. \quad M = x = \cos^3 t, N = y = \sin^3 t &\Rightarrow dx = -3 \cos^2 t \sin t dt, dy = 3 \sin^2 t \cos t dt \Rightarrow \text{Area} = \frac{1}{2} \oint_C x dy - y dx \\
 &= \frac{1}{2} \int_0^{2\pi} (3 \sin^2 t \cos^2 t) (\cos^2 t + \sin^2 t) dt = \frac{1}{2} \int_0^{2\pi} (3 \sin^2 t \cos^2 t) dt = \frac{3}{8} \int_0^{2\pi} \sin^2 2t dt = \frac{3}{16} \int_0^{4\pi} \sin^2 u du \\
 &= \frac{3}{16} \left[\frac{u}{2} - \frac{\sin 2u}{4} \right]_0^{4\pi} = \frac{3}{8} \pi
 \end{aligned}$$

$$\begin{aligned}
 28. \quad C_1: M = x = t, N = y = 0 &\Rightarrow dx = dt, dy = 0; C_2: M = x = (2\pi - t) - \sin(2\pi - t) = 2\pi - t + \sin t, \\
 N = y = 1 - \cos(2\pi - t) = 1 - \cos t &\Rightarrow dx = (\cos t - 1) dt, dy = \sin t dt \\
 \Rightarrow \text{Area} = \frac{1}{2} \oint_C x dy - y dx &= \frac{1}{2} \oint_{C_1} x dy - y dx + \frac{1}{2} \oint_{C_2} x dy - y dx \\
 &= \frac{1}{2} \int_0^{2\pi} (0) dt + \frac{1}{2} \int_0^{2\pi} [(2\pi - t + \sin t)(\sin t) - (1 - \cos t)(\cos t - 1)] dt = -\frac{1}{2} \int_0^{2\pi} (2 \cos t + t \sin t - 2 - 2\pi \sin t) dt \\
 &= -\frac{1}{2} [3 \sin t - t \cos t - 2t - 2\pi \cos t]_0^{2\pi} = 3\pi
 \end{aligned}$$

$$29. \quad (a) \quad M = f(x), N = g(y) \Rightarrow \frac{\partial M}{\partial y} = 0, \frac{\partial N}{\partial x} = 0 \Rightarrow \oint_C f(x) dx + g(y) dy = \iint_R \left(\frac{\partial N}{\partial x} - \frac{\partial M}{\partial y} \right) dx dy = \iint_R 0 dx dy = 0$$

$$\begin{aligned}
 (b) \quad M = ky, N = hx &\Rightarrow \frac{\partial M}{\partial y} = k, \frac{\partial N}{\partial x} = h \Rightarrow \oint_C ky dx + hx dy = \iint_R \left(\frac{\partial N}{\partial x} - \frac{\partial M}{\partial y} \right) dx dy \\
 &= \iint_R (h - k) dx dy = (h - k)(\text{Area of the region})
 \end{aligned}$$

$$\begin{aligned}
 30. \quad M = xy^2, N = x^2y + 2x &\Rightarrow \frac{\partial M}{\partial y} = 2xy, \frac{\partial N}{\partial x} = 2xy + 2 \Rightarrow \oint_C xy^2 dx + (x^2y + 2x) dy = \iint_R \left(\frac{\partial N}{\partial x} - \frac{\partial M}{\partial y} \right) dx dy \\
 &= \iint_R (2xy + 2 - 2xy) dx dy = 2 \iint_R dx dy = 2 \text{ times the area of the square}
 \end{aligned}$$

$$\begin{aligned}
 31. \quad \text{The integral is 0 for any simple closed plane curve } C. \text{ The reasoning: By the tangential form of Green's} \\
 \text{Theorem, with } M = 4x^3y \text{ and } N = x^4, \oint_C 4x^3y dx + x^4 dy &= \iint_R \left[\frac{\partial}{\partial x} (x^4) - \frac{\partial}{\partial y} (4x^3y) \right] dx dy \\
 &= \iint_R \underbrace{(4x^3 - 4x^3)}_0 dx dy = 0.
 \end{aligned}$$

$$\begin{aligned}
 32. \quad \text{The integral is 0 for any simple closed curve } C. \text{ The reasoning: By the normal form of Green's theorem, with} \\
 M = x^3 \text{ and } N = -y^3, \oint_C -y^3 dy + x^3 dx &= \iint_R \left[\underbrace{\frac{\partial}{\partial x} (-y^3)}_0 - \underbrace{\frac{\partial}{\partial y} (x^3)}_0 \right] dx dy = 0.
 \end{aligned}$$

$$\begin{aligned}
 33. \quad \text{Let } M = x \text{ and } N = 0 &\Rightarrow \frac{\partial M}{\partial x} = 1 \text{ and } \frac{\partial N}{\partial y} = 0 \Rightarrow \oint_C M dy - N dx = \iint_R \left(\frac{\partial M}{\partial x} + \frac{\partial N}{\partial y} \right) dx dy \Rightarrow \oint_C x dy \\
 \iint_R (1 + 0) dx dy &\Rightarrow \text{Area of } R = \iint_R dx dy = \oint_C x dy; \text{ similarly, } M = y \text{ and } N = 0 \Rightarrow \frac{\partial M}{\partial x} = 1 \text{ and } \frac{\partial N}{\partial x} = 0 \\
 \Rightarrow \oint_C M dx + N dy &= \iint_R \left(\frac{\partial N}{\partial x} + \frac{\partial M}{\partial y} \right) dy dx \Rightarrow \oint_C y dx = \iint_R (0 - 1) dy dx \Rightarrow -\oint_C y dx = \iint_R dx dy = \text{Area of } R
 \end{aligned}$$

34. $\int_a^b f(x) dx = \text{Area of } R = -\oint_C y dx$, from Exercise 33

35. Let $\delta(x, y) = 1 \Rightarrow \bar{x} = \frac{M_y}{M} = \frac{\iint_R x \delta(x, y) dA}{\iint_R \delta(x, y) dA} = \frac{\iint_R x dA}{\iint_R dA} = \frac{\iint_R x dA}{A} \Rightarrow A\bar{x} = \iint_R x dA = \iint_R (x+0) dx dy$
 $= \oint_C \frac{x^2}{2} dy$, $A\bar{x} = \iint_R x dA = \iint_R (0+x) dx dy = -\oint_C xy dx$, and $A\bar{x} = \iint_R x dA = \iint_R (\frac{2}{3}x + \frac{1}{3}x) dx dy$
 $= \oint_C \frac{1}{3}x^2 dy - \frac{1}{3}xy dx \Rightarrow \frac{1}{2}\oint_C x^2 dy = -\oint_C xy dx = \frac{1}{3}\oint_C x^2 dy - xy dx = A\bar{x}$

36. If $\delta(x, y) = 1$ then $I_y = \iint_R x^2 \delta(x, y) dA = \iint_R x^2 dA = \iint_R (x^2 + 0) dy dx = \frac{1}{3}\oint_C x^3 dy$,
 $\iint_R x^2 dA = \iint_R (0+x^2) dy dx = -\oint_C x^2 y dx$, and $\iint_R x^2 dA = \iint_R (\frac{3}{4}x^2 + \frac{1}{4}x^2) dy dx$
 $= \oint_C \frac{1}{4}x^3 dy - \frac{1}{4}x^2 y dx = \frac{1}{4}\oint_C x^3 dy - x^2 y dx \Rightarrow \frac{1}{3}\oint_C x^3 dy = -\oint_C x^2 y dx = \frac{1}{4}\oint_C x^3 dy - x^2 y dx = I_y$

37. $M = \frac{\partial f}{\partial y}$, $N = -\frac{\partial f}{\partial x} \Rightarrow \frac{\partial M}{\partial y} = \frac{\partial^2 f}{\partial y^2}$, $\frac{\partial N}{\partial x} = -\frac{\partial^2 f}{\partial x^2} \Rightarrow \oint_C \frac{\partial f}{\partial y} dx - \frac{\partial f}{\partial x} dy = \iint_R \left(-\frac{\partial^2 f}{\partial x^2} - \frac{\partial^2 f}{\partial y^2} \right) dx dy = 0$ for such curves C

38. $M = \frac{1}{4}x^2 y + \frac{1}{3}y^3$, $N = x \Rightarrow \frac{\partial M}{\partial y} = \frac{1}{4}x^2 + y^2$, $\frac{\partial N}{\partial x} = 1 \Rightarrow \text{Curl} = \frac{\partial N}{\partial x} - \frac{\partial M}{\partial y} = 1 - (\frac{1}{4}x^2 + y^2) > 0$ in the interior of the ellipse $\frac{1}{4}x^2 + y^2 = 1 \Rightarrow \text{work} = \oint_C \mathbf{F} \cdot d\mathbf{r} = \iint_R (1 - \frac{1}{4}x^2 - y^2) dx dy$ will be maximized on the region $R = \{(x, y) | \text{curl } \mathbf{F} \geq 0\}$ or over the region enclosed by $1 = \frac{1}{4}x^2 + y^2$

39. (a) $\nabla f = \left(\frac{2x}{x^2+y^2} \right) \mathbf{i} + \left(\frac{2y}{x^2+y^2} \right) \mathbf{j} \Rightarrow M = \frac{2x}{x^2+y^2}$, $N = \frac{2y}{x^2+y^2}$; since M, N are discontinuous at $(0, 0)$, we compute $\int_C \nabla f \cdot \mathbf{n} ds$ directly since Green's Theorem does not apply. Let $x = a \cos t$, $y = a \sin t$
 $\Rightarrow dx = -a \sin t dt$, $dy = a \cos t dt$, $M = \frac{2}{a} \cos t$, $N = \frac{2}{a} \sin t$, $0 \leq t \leq 2\pi$, so $\int_C \nabla f \cdot \mathbf{n} ds = \int_C M dy - N dx$
 $= \int_0^{2\pi} \left[\left(\frac{2}{a} \cos t \right) (a \cos t) - \left(\frac{2}{a} \sin t \right) (-a \sin t) \right] dt = \int_0^{2\pi} 2(\cos^2 t + \sin^2 t) dt = 4\pi$. Note that this holds for any $a > 0$, so $\int_C \nabla f \cdot \mathbf{n} ds = 4\pi$ for any circle C centered at $(0, 0)$ traversed counterclockwise and $\int_C \nabla f \cdot \mathbf{n} ds = -4\pi$ if C is traversed clockwise.

(b) If K does not enclose the point $(0, 0)$ we may apply Green's Theorem: $\int_C \nabla f \cdot \mathbf{n} ds = \int_C M dy - N dx$
 $= \iint_R \left(\frac{\partial M}{\partial x} + \frac{\partial N}{\partial y} \right) dx dy = \iint_R \left(\frac{2(y^2-x^2)}{(x^2+y^2)^2} + \frac{2(x^2-y^2)}{(x^2+y^2)^2} \right) dx dy = \iint_R 0 dx dy = 0$. If K does enclose the point $(0, 0)$ we proceed as follows:

Choose a small enough a so that the circle C centered at $(0, 0)$ of radius a lies entirely within K . Green's Theorem applies to the region R that lies between K and C . Thus, as before, $0 = \iint_R \left(\frac{\partial M}{\partial x} + \frac{\partial N}{\partial y} \right) dx dy$
 $= \int_K M dy - N dx + \int_C M dy - N dx$ where K is traversed counterclockwise and C is traversed clockwise.

Hence by part (a) $0 = \left[\int_K M \, dy - N \, dx \right] - 4\pi \Rightarrow 4\pi = \int_K M \, dy - N \, dx = \int_K \nabla f \cdot \mathbf{n} \, ds$. We have shown:

$$\int_K \nabla f \cdot \mathbf{n} \, ds = \begin{cases} 0 & \text{if } (0, 0) \text{ lies inside } K \\ 4\pi & \text{if } (0, 0) \text{ lies outside } K \end{cases}$$

40. Assume a particle has a closed trajectory in R and let C_1 be the path $\Rightarrow C_1$ encloses a simply connected region $R_1 \Rightarrow C_1$ is a simple closed curve. Then the flux over R_1 is $\oint_{C_1} \mathbf{F} \cdot \mathbf{n} \, ds = 0$, since the velocity vectors \mathbf{F} are

tangent to C_1 . But $0 = \oint_{C_1} \mathbf{F} \cdot \mathbf{n} \, ds = \oint_{C_1} M \, dy - N \, dx = \iint_{R_1} \left(\frac{\partial M}{\partial x} + \frac{\partial N}{\partial y} \right) dx \, dy \Rightarrow M_x + N_y = 0$, which is a

contradiction. Therefore, C_1 cannot be a closed trajectory.

$$\begin{aligned} 41. \int_{g_1(y)}^{g_2(y)} \frac{\partial N}{\partial x} dx \, dy &= N(g_2(y), y) - N(g_1(y), y) \Rightarrow \int_c^d \int_{g_1(y)}^{g_2(y)} \left(\frac{\partial N}{\partial x} dx \right) dy = \int_c^d [N(g_2(y), y) - N(g_1(y), y)] dy \\ &= \int_c^d N(g_2(y), y) dy - \int_c^d N(g_1(y), y) dy = \int_c^d N(g_2(y), y) dy + \int_d^c N(g_1(y), y) dy = \int_{C_2} N \, dy + \int_{C_1} N \, dy \\ &= \oint_C dy \Rightarrow \oint_C N \, dy = \iint_R \frac{\partial N}{\partial x} dx \, dy \end{aligned}$$

42. The curl of a conservative two-dimensional field is zero. The reasoning. A two-dimensional field $\mathbf{F} = M\mathbf{i} + N\mathbf{j}$ can be considered to be the restriction to the xy -plane of a three-dimensional field whose k component, P , is zero, and whose \mathbf{i} and \mathbf{j} components are independent of z . For such a field to be conservative, we must have $\frac{\partial N}{\partial x} = \frac{\partial M}{\partial y}$ by the component test in Section 16.3 $\Rightarrow \frac{\partial N}{\partial x} = \frac{\partial M}{\partial y}$, $\frac{\partial P}{\partial y} = \frac{\partial N}{\partial x}$, and $\frac{\partial M}{\partial z} = \frac{\partial P}{\partial x}$.

43-46. Example CAS commands:

Maple:

```
with( plots );#43
M := (x,y) -> 2*x-y;
N := (x,y) -> x+3*y;
C := x^2+4*y^2 = 4;
implicitplot( C, x=-2..2,y=2..2, scaling=constrained, title="#43(a)(Section 16.4)");
curlF_k:=D[1](N) - D[2](M):           #(b)
'curlF_k' = curlF_k(x,y);
top,bot:= solve( C, y);               #(c)
left,right:= -2, 2;
q1:= Int( Int( curlF_k(x,y),y=bot..top ), x=left..right );
value( q1 );
```

Mathematica: (functions and bounds will vary)

The **ImplicitPlot** command will be useful for 43 and 44, but is not needed for 45 and 46. In 46, the equation of the line from (0, 4) to (2, 0) must be determined first.

```
Clear[x, y, f]
<<Graphics`ImplicitPlot`
```



```

f[x_, y_]:= {2x - y, x + 3y}
curve= x^2 + 4y^2 ==4
ImplicitPlot[curve, {x, -3, 3}, {y, -2, 2}, AspectRatio -> Automatic, AxesLabel -> {x, y}];
ybonds= Solve[curve, y]
{y1, y2}=y/.bonds;
integrand:=D[f[x,y][[2]],x]-D[f[x,y][[1]],y]/Simplify
Integrate[integrand, {x, -2, 2}, {y, y1, y2}]
N[%]

```

Bounds for y are determined differently in 45 and 46. In 46, note equation of the line from $(0, 4)$ to $(2, 0)$.

```

Clear[x, y, f]
f[x_, y_]:= {x Exp[y], 4x^2 Log[y]}
ybound = 4 - 2x
Plot[{0, ybound}, {x, 0, 2.1}, AspectRatio -> Automatic, AxesLabel -> {x,y}];
integrand:=D[f[x, y][[2]],x]-D[f[x,y][[1]],y]/Simplify
Integrate[integrand, [x, 0, 2], {y, 0, ybound}]
N[%]

```

16.5 SURFACES AND AREA

- In cylindrical coordinates, let $x = r \cos \theta$, $y = r \sin \theta$, $z = \left(\sqrt{x^2 + y^2}\right)^2 = r^2$.
Then $\mathbf{r}(r, \theta) = (r \cos \theta)\mathbf{i} + (r \sin \theta)\mathbf{j} + r^2\mathbf{k}$, $0 \leq r \leq 2$, $0 \leq \theta \leq 2\pi$.
- In cylindrical coordinates, let $x = r \cos \theta$, $y = r \sin \theta$, $z = 9 - x^2 - y^2 = 9 - r^2$.
Then $\mathbf{r}(r, \theta) = (r \cos \theta)\mathbf{i} + (r \sin \theta)\mathbf{j} + (9 - r^2)\mathbf{k}$; $z \geq 0 \Rightarrow 9 - r^2 \geq 0 \Rightarrow r^2 \leq 9 \Rightarrow -3 \leq r \leq 3$, $0 \leq \theta \leq 2\pi$.
But $-3 \leq r \leq 0$ gives the same points as $0 \leq r \leq 3$, so let $0 \leq r \leq 3$.
- In cylindrical coordinates, let $x = r \cos \theta$, $y = r \sin \theta$, $z = \frac{\sqrt{x^2 + y^2}}{2} \Rightarrow z = \frac{r}{2}$.
Then $\mathbf{r}(r, \theta) = (r \cos \theta)\mathbf{i} + (r \sin \theta)\mathbf{j} + \left(\frac{r}{2}\right)\mathbf{k}$. For $0 \leq z \leq 3$, $0 \leq \frac{r}{2} \leq 3 \Rightarrow 0 \leq r \leq 6$; to get only the first octant, let $0 \leq \theta \leq \frac{\pi}{2}$.
- In cylindrical coordinates, let $x = r \cos \theta$, $y = r \sin \theta$, $z = 2\sqrt{x^2 + y^2} \Rightarrow z = 2r$.
Then $\mathbf{r}(r, \theta) = (r \cos \theta)\mathbf{i} + (r \sin \theta)\mathbf{j} + 2r\mathbf{k}$. For $2 \leq z \leq 4$, $2 \leq 2r \leq 4 \Rightarrow 1 \leq r \leq 2$, and let $0 \leq \theta \leq 2\pi$.
- In cylindrical coordinates, let $x = r \cos \theta$, $y = r \sin \theta$; since $x^2 + y^2 = r^2 \Rightarrow z^2 = 9 - (x^2 + y^2) = 9 - r^2 \Rightarrow z = \sqrt{9 - r^2}$, $z \geq 0$. Then $\mathbf{r}(r, \theta) = (r \cos \theta)\mathbf{i} + (r \sin \theta)\mathbf{j} + \sqrt{9 - r^2}\mathbf{k}$. Let $0 \leq \theta \leq 2\pi$. For the domain of r :

$$z = \sqrt{x^2 + y^2} \text{ and } x^2 + y^2 + z^2 = 9 \Rightarrow x^2 + y^2 + (\sqrt{x^2 + y^2})^2 = 9 \Rightarrow 2(x^2 + y^2) = 9 \Rightarrow 2r^2 = 9 \\ \Rightarrow r = \frac{3}{\sqrt{2}} \Rightarrow 0 \leq r \leq \frac{3}{\sqrt{2}}.$$

6. In cylindrical coordinates, $\mathbf{r}(r, \theta) = (r \cos \theta)\mathbf{i} + (r \sin \theta)\mathbf{j} + \sqrt{4 - r^2}\mathbf{k}$ (see Exercise 5 above with $x^2 + y^2 + z^2 = 4$, instead of $x^2 + y^2 + z^2 = 9$). For the first octant, let $0 \leq \theta \leq \frac{\pi}{2}$. For the domain of r :

$$z = \sqrt{x^2 + y^2} \text{ and } x^2 + y^2 + z^2 = 4 \Rightarrow x^2 + y^2 + (\sqrt{x^2 + y^2})^2 = 4 \Rightarrow 2(x^2 + y^2) = 4 \Rightarrow 2r^2 = 4 \Rightarrow r = \sqrt{2}.$$

Thus, let $\sqrt{2} \leq r \leq 2$ (to get the portion of the sphere between the cone and the xy -plane).

7. In spherical coordinates, $x = \rho \sin \phi \cos \theta$, $y = \rho \sin \phi \sin \theta$, $\rho = \sqrt{x^2 + y^2 + z^2} \Rightarrow \rho^2 = 3 \Rightarrow \rho = \sqrt{3}$
 $\Rightarrow z = \sqrt{3} \cos \phi$ for the sphere; $z = \frac{\sqrt{3}}{2} = \sqrt{3} \cos \phi \Rightarrow \cos \phi = \frac{1}{2} \Rightarrow \phi = \frac{\pi}{3}$; $z = -\frac{\sqrt{3}}{2} \Rightarrow -\frac{\sqrt{3}}{2} = \sqrt{3} \cos \phi$
 $\Rightarrow \cos \phi = -\frac{1}{2} \Rightarrow \phi = \frac{2\pi}{3}$. Then $\mathbf{r}(\phi, \theta) = (\sqrt{3} \sin \phi \cos \theta)\mathbf{i} + (\sqrt{3} \sin \phi \sin \theta)\mathbf{j} + (\sqrt{3} \cos \phi)\mathbf{k}$,
 $\frac{\pi}{3} \leq \phi \leq \frac{2\pi}{3}$ and $0 \leq \theta \leq 2\pi$.

8. In spherical coordinates, $x = \rho \sin \phi \cos \theta$, $y = \rho \sin \phi \sin \theta$, $\rho = \sqrt{x^2 + y^2 + z^2} \Rightarrow \rho^2 = 8 \Rightarrow \rho = \sqrt{8} = 2\sqrt{2}$
 $\Rightarrow x = 2\sqrt{2} \sin \phi \cos \theta$, $y = 2\sqrt{2} \sin \phi \sin \theta$, and $z = 2\sqrt{2} \cos \phi$. Thus let
 $\mathbf{r}(\phi, \theta) = (2\sqrt{2} \sin \phi \cos \theta)\mathbf{i} + (2\sqrt{2} \sin \phi \sin \theta)\mathbf{j} + (2\sqrt{2} \cos \phi)\mathbf{k}$; $z = -2 \Rightarrow -2 = 2\sqrt{2} \cos \phi$
 $\Rightarrow \cos \phi = -\frac{1}{\sqrt{2}} \Rightarrow \phi = \frac{3\pi}{4}$; $z = 2\sqrt{2} \Rightarrow 2\sqrt{2} = 2\sqrt{2} \cos \phi \Rightarrow \cos \phi = 1 \Rightarrow \phi = 0$. Thus $0 \leq \phi \leq \frac{3\pi}{4}$ and
 $0 \leq \theta \leq 2\pi$.

9. Since $z = 4 - y^2$, we can let \mathbf{r} be a function of x and $y \Rightarrow \mathbf{r}(x, y) = x\mathbf{i} + y\mathbf{j} + (4 - y^2)\mathbf{k}$. Then $z = 0$
 $\Rightarrow 0 = 4 - y^2 \Rightarrow y = \pm 2$. Thus, let $-2 \leq y \leq 2$ and $0 \leq x \leq 2$.

10. Since $y = x^2$, we can let \mathbf{r} be a function of x and $z \Rightarrow \mathbf{r}(x, z) = x\mathbf{i} + x^2\mathbf{j} + z\mathbf{k}$. Then $y = 2$
 $\Rightarrow x^2 = 2 \Rightarrow x = \pm\sqrt{2}$. Thus, let $-\sqrt{2} \leq x \leq \sqrt{2}$ and $0 \leq z \leq 3$.

11. When $x = 0$, let $y^2 + z^2 = 9$ be the circular section in the yz -plane. Use polar coordinates in the yz -plane
 $\Rightarrow y = 3 \cos \theta$ and $z = 3 \sin \theta$. Thus let $x = u$ and $\theta = v \Rightarrow \mathbf{r}(u, v) = u\mathbf{i} + (3 \cos v)\mathbf{j} + (3 \sin v)\mathbf{k}$ where
 $0 \leq u \leq 3$, and $0 \leq v \leq 2\pi$.

12. When $y = 0$, let $x^2 + z^2 = 4$ be the circular section in the xz -plane. Use polar coordinates in the xz -plane
 $\Rightarrow x = 2 \cos \theta$ and $z = 2 \sin \theta$. Thus let $y = u$ and $\theta = v \Rightarrow \mathbf{r}(u, v) = (2 \cos v)\mathbf{i} + u\mathbf{j} + (2 \sin v)\mathbf{k}$ where
 $-2 \leq u \leq 2$, and $0 \leq v \leq \pi$ (since we want the portion above the xy -plane).

13. (a) $x + y + z = 1 \Rightarrow z = 1 - x - y$. In cylindrical coordinates, let $x = r \cos \theta$ and $y = r \sin \theta$
 $\Rightarrow z = 1 - r \cos \theta - r \sin \theta \Rightarrow \mathbf{r}(r, \theta) = (r \cos \theta)\mathbf{i} + (r \sin \theta)\mathbf{j} + (1 - r \cos \theta - r \sin \theta)\mathbf{k}$, $0 \leq \theta \leq 2\pi$
and $0 \leq r \leq 3$.

(b) In a fashion similar to cylindrical coordinates, but working in the yz -plane instead of the xy -plane, let $y = u \cos v, z = u \sin v$ where $u = \sqrt{y^2 + z^2}$ and v is the angle formed by $(x, y, z), (x, 0, 0)$, and $(x, y, 0)$ with $(x, 0, 0)$ as vertex. Since $x + y + z = 1 \Rightarrow x = 1 - y - z \Rightarrow x = 1 - u \cos v - u \sin v$, then \mathbf{r} is a function of u and $v \Rightarrow \mathbf{r}(u, v) = (1 - u \cos v - u \sin v)\mathbf{i} + (u \cos v)\mathbf{j} + (u \sin v)\mathbf{k}, 0 \leq u \leq 3$ and $0 \leq v \leq 2\pi$.

14. (a) In a fashion similar to cylindrical coordinates, but working in the xz -plane instead of the xy -plane, let $x = u \cos v, z = u \sin v$ where $u = \sqrt{x^2 + z^2}$ and v is the angle formed by $(x, y, z), (y, 0, 0)$, and $(x, y, 0)$ with vertex $(y, 0, 0)$. Since $x - y + 2z = 2 \Rightarrow y = x + 2z - 2$, then $\mathbf{r}(u, v) = (u \cos v)\mathbf{i} + (u \cos v + 2u \sin v - 2)\mathbf{j} + (u \sin v)\mathbf{k}, 0 \leq u \leq \sqrt{3}$ and $0 \leq v \leq 2\pi$.

(b) In a fashion similar to cylindrical coordinates, but working in the yz -plane instead of the xy -plane, let $y = u \cos v, z = u \sin v$ where $u = \sqrt{y^2 + z^2}$ and v is the angle formed by $(x, y, z), (x, 0, 0)$, and $(x, y, 0)$ with vertex $(x, 0, 0)$. Since $x - y + 2z = 2 \Rightarrow x = y - 2z + 2$, then $\mathbf{r}(u, v) = (u \cos v - 2u \sin v + 2)\mathbf{i} + (u \cos v)\mathbf{j} + (u \sin v)\mathbf{k}, 0 \leq u \leq \sqrt{2}$ and $0 \leq v \leq 2\pi$.

15. Let $x = w \cos v$ and $z = w \sin v$. Then $(x - 2)^2 + z^2 = 4 \Rightarrow x^2 - 4x + z^2 = 0 \Rightarrow w^2 \cos^2 v - 4w \cos v + w^2 \sin^2 v = 0 \Rightarrow w^2 - 4w \cos v = 0 \Rightarrow w = 0$ or $w - 4 \cos v = 0 \Rightarrow w = 0$ or $w = 4 \cos v$. Now $w = 0 \Rightarrow x = 0$ and $y = 0$, which is a line not a cylinder. Therefore, let $w = 4 \cos v \Rightarrow x = (4 \cos v)(\cos v) = 4 \cos^2 v$ and $z = 4 \cos v \sin v$. Finally, let $y = u$. Then $\mathbf{r}(u, v) = (4 \cos^2 v)\mathbf{i} + u\mathbf{j} + (4 \cos v \sin v)\mathbf{k}, -\frac{\pi}{2} \leq v \leq \frac{\pi}{2}$ and $0 \leq u \leq 3$.

16. Let $y = w \cos v$ and $z = w \sin v$. Then $y^2 + (z - 5)^2 = 25 \Rightarrow y^2 + z^2 - 10z = 0 \Rightarrow w^2 \cos^2 v + w^2 \sin^2 v - 10w \sin v = 0 \Rightarrow w^2 - 10w \sin v = 0 \Rightarrow w(w - 10 \sin v) = 0 \Rightarrow w = 0$ or $w = 10 \sin v$. Now $w = 0 \Rightarrow y = 0$ and $z = 0$, which is a line not a cylinder. Therefore, let $w = 10 \sin v \Rightarrow y = 10 \sin v \cos v$ and $z = 10 \sin^2 v$. Finally, let $x = u$. Then $\mathbf{r}(u, v) = u\mathbf{i} + (10 \sin v \cos v)\mathbf{j} + (10 \sin^2 v)\mathbf{k}, 0 \leq u \leq 10$ and $0 \leq v \leq \pi$.

17. Let $x = r \cos \theta$ and $y = r \sin \theta$. Then $\mathbf{r}(r, \theta) = (r \cos \theta)\mathbf{i} + (r \sin \theta)\mathbf{j} + \left(\frac{2 - r \sin \theta}{2}\right)\mathbf{k}, 0 \leq r \leq 1$ and $0 \leq \theta \leq 2\pi \Rightarrow \mathbf{r}_r = (\cos \theta)\mathbf{i} + (\sin \theta)\mathbf{j} - \left(\frac{\sin \theta}{2}\right)\mathbf{k}$ and $\mathbf{r}_\theta = (-r \sin \theta)\mathbf{i} + (r \cos \theta)\mathbf{j} - \left(\frac{r \cos \theta}{2}\right)\mathbf{k}$

$$\begin{aligned} \Rightarrow \mathbf{r}_r \times \mathbf{r}_\theta &= \begin{vmatrix} \mathbf{i} & \mathbf{j} & \mathbf{k} \\ \cos \theta & \sin \theta & -\frac{\sin \theta}{2} \\ -r \sin \theta & r \cos \theta & -\frac{r \cos \theta}{2} \end{vmatrix} \\ &= \left(\frac{-r \sin \theta \cos \theta}{2} + \frac{(\sin \theta)(r \cos \theta)}{2}\right)\mathbf{i} + \left(\frac{r \sin^2 \theta}{2} + \frac{r \cos^2 \theta}{2}\right)\mathbf{j} + (r \cos^2 \theta + r \sin^2 \theta)\mathbf{k} = \frac{r}{2}\mathbf{j} + r\mathbf{k} \\ \Rightarrow |\mathbf{r}_r \times \mathbf{r}_\theta| &= \sqrt{\frac{r^2}{4} + r^2} = \frac{\sqrt{5}r}{2} \Rightarrow A = \int_0^{2\pi} \int_0^1 \frac{\sqrt{5}r}{2} dr d\theta = \int_0^{2\pi} \left[\frac{\sqrt{5}r^2}{4}\right]_0^1 d\theta = \int_0^{2\pi} d\theta = \frac{\pi\sqrt{5}}{2} \end{aligned}$$

18. Let $x = r \cos \theta$ and $y = r \sin \theta \Rightarrow z = -x = -r \cos \theta, 0 \leq r \leq 2$ and $0 \leq \theta \leq 2\pi$. Then $\mathbf{r}(r, \theta) = (r \cos \theta)\mathbf{i} + (r \sin \theta)\mathbf{j} - (r \cos \theta)\mathbf{k} \Rightarrow \mathbf{r}_r = (\cos \theta)\mathbf{i} + (\sin \theta)\mathbf{j} - (\cos \theta)\mathbf{k}$ and $\mathbf{r}_\theta = (-r \sin \theta)\mathbf{i} + (r \cos \theta)\mathbf{j} + (r \sin \theta)\mathbf{k}$

$$\begin{aligned} \Rightarrow \mathbf{r}_r \times \mathbf{r}_\theta &= \begin{vmatrix} \mathbf{i} & \mathbf{j} & \mathbf{k} \\ \cos \theta & \sin \theta & -\cos \theta \\ -r \sin \theta & r \cos \theta & r \sin \theta \end{vmatrix} \\ &= (r \sin^2 \theta + r \cos^2 \theta) \mathbf{i} + (r \sin \theta \cos \theta - r \sin \theta \cos \theta) \mathbf{j} + (r \cos^2 \theta + r \sin^2 \theta) \mathbf{k} = r \mathbf{i} + r \mathbf{k} \\ \Rightarrow |\mathbf{r}_r \times \mathbf{r}_\theta| &= \sqrt{r^2 + r^2} = r\sqrt{2} \Rightarrow A = \int_0^{2\pi} \int_0^2 r\sqrt{2} dr d\theta = \int_0^{2\pi} \left[\frac{r^2\sqrt{2}}{2} \right]_0^2 d\theta = \int_0^{2\pi} 2\sqrt{2} d\theta = 4\pi\sqrt{2} \end{aligned}$$

19. Let $x = r \cos \theta$ and $y = r \sin \theta \Rightarrow z = 2\sqrt{x^2 + y^2} = 2r, 1 \leq r \leq 3$ and $0 \leq \theta \leq 2\pi$. Then $\mathbf{r}(r, \theta) = (r \cos \theta) \mathbf{i} + (r \sin \theta) \mathbf{j} + 2r \mathbf{k} \Rightarrow \mathbf{r}_r = (\cos \theta) \mathbf{i} + (\sin \theta) \mathbf{j} + 2 \mathbf{k}$ and $\mathbf{r}_\theta = (-r \sin \theta) \mathbf{i} + (r \cos \theta) \mathbf{j}$

$$\begin{aligned} \Rightarrow \mathbf{r}_r \times \mathbf{r}_\theta &= \begin{vmatrix} \mathbf{i} & \mathbf{j} & \mathbf{k} \\ \cos \theta & \sin \theta & 2 \\ -r \sin \theta & r \cos \theta & 0 \end{vmatrix} = (-2r \cos \theta) \mathbf{i} - (2r \sin \theta) \mathbf{j} + (r \cos^2 \theta + r \sin^2 \theta) \mathbf{k} \\ \Rightarrow (-2r \cos \theta) \mathbf{i} - (2r \sin \theta) \mathbf{j} + r \mathbf{k} &\Rightarrow |\mathbf{r}_r \times \mathbf{r}_\theta| = \sqrt{4r^2 \cos^2 \theta + 4r^2 \sin^2 \theta + r^2} = \sqrt{5r^2} = r\sqrt{5} \\ \Rightarrow A &= \int_0^{2\pi} \int_1^3 r\sqrt{5} dr d\theta = \int_0^{2\pi} \left[\frac{r^2\sqrt{5}}{2} \right]_1^3 d\theta = \int_0^{2\pi} 4\sqrt{5} d\theta = 8\pi\sqrt{5} \end{aligned}$$

20. Let $x = r \cos \theta$ and $y = r \sin \theta \Rightarrow z = \frac{\sqrt{x^2 + y^2}}{3} = \frac{r}{3}, 3 \leq r \leq 4$ and $0 \leq \theta \leq 2\pi$. Then $\mathbf{r}(r, \theta) = (r \cos \theta) \mathbf{i} + (r \sin \theta) \mathbf{j} + \left(\frac{r}{3}\right) \mathbf{k} \Rightarrow \mathbf{r}_r = (\cos \theta) \mathbf{i} + (\sin \theta) \mathbf{j} + \left(\frac{1}{3}\right) \mathbf{k}$ and $\mathbf{r}_\theta = (-r \sin \theta) \mathbf{i} + (r \cos \theta) \mathbf{j}$

$$\begin{aligned} \Rightarrow \mathbf{r}_r \times \mathbf{r}_\theta &= \begin{vmatrix} \mathbf{i} & \mathbf{j} & \mathbf{k} \\ \cos \theta & \sin \theta & \frac{1}{3} \\ -r \sin \theta & r \cos \theta & 0 \end{vmatrix} = \left(-\frac{1}{3}r \cos \theta\right) \mathbf{i} - \left(\frac{1}{3}r \sin \theta\right) \mathbf{j} + (r \cos^2 \theta + r \sin^2 \theta) \mathbf{k} \\ &= \left(-\frac{1}{3}r \cos \theta\right) \mathbf{i} - \left(\frac{1}{3}r \sin \theta\right) \mathbf{j} + r \mathbf{k} \Rightarrow |\mathbf{r}_r \times \mathbf{r}_\theta| = \sqrt{\frac{1}{9}r^2 \cos^2 \theta + \frac{1}{9}r^2 \sin^2 \theta + r^2} = \sqrt{\frac{10r^2}{9}} = \frac{r\sqrt{10}}{3} \\ \Rightarrow A &= \int_0^{2\pi} \int_3^4 \frac{r\sqrt{10}}{3} dr d\theta = \int_0^{2\pi} \left[\frac{r^2\sqrt{10}}{6} \right]_3^4 d\theta = \int_0^{2\pi} \frac{7\sqrt{10}}{6} d\theta = \frac{7\pi\sqrt{10}}{3} \end{aligned}$$

21. Let $x = r \cos \theta$ and $y = r \sin \theta \Rightarrow r^2 = x^2 + y^2 = 1, 1 \leq z \leq 4$ and $0 \leq \theta \leq 2\pi$. Then $\mathbf{r}(z, \theta) = (\cos \theta) \mathbf{i} + (\sin \theta) \mathbf{j} + z \mathbf{k} \Rightarrow \mathbf{r}_z = \mathbf{k}$ and $\mathbf{r}_\theta = (-\sin \theta) \mathbf{i} + (\cos \theta) \mathbf{j}$

$$\begin{aligned} \Rightarrow \mathbf{r}_\theta \times \mathbf{r}_z &= \begin{vmatrix} \mathbf{i} & \mathbf{j} & \mathbf{k} \\ -\sin \theta & \cos \theta & 0 \\ 0 & 0 & 1 \end{vmatrix} = (\cos \theta) \mathbf{i} + (\sin \theta) \mathbf{j} \Rightarrow |\mathbf{r}_\theta \times \mathbf{r}_z| = \sqrt{\cos^2 \theta + \sin^2 \theta} = 1 \\ \Rightarrow A &= \int_0^{2\pi} \int_1^4 1 dr d\theta = \int_0^{2\pi} 3 d\theta = 6\pi \end{aligned}$$

22. Let $x = u \cos v$ and $z = u \sin v \Rightarrow u^2 = x^2 + z^2 = 10, -1 \leq y \leq 1, 0 \leq v \leq 2\pi$. Then $\mathbf{r}(y, v) = (u \cos v) \mathbf{i} + y \mathbf{j} + (u \sin v) \mathbf{k} = (\sqrt{10} \cos v) \mathbf{i} + y \mathbf{j} + (\sqrt{10} \sin v) \mathbf{k} \Rightarrow \mathbf{r}_v = (-\sqrt{10} \sin v) \mathbf{i} + (\sqrt{10} \cos v) \mathbf{k}$

$$\text{and } \mathbf{r}_y = \mathbf{j} \Rightarrow \mathbf{r}_v \times \mathbf{r}_y = \begin{vmatrix} \mathbf{i} & \mathbf{j} & \mathbf{k} \\ -\sqrt{10} \sin v & 0 & \sqrt{10} \cos v \\ 0 & 1 & 0 \end{vmatrix} = (-\sqrt{10} \cos v)\mathbf{i} - (\sqrt{10} \sin v)\mathbf{k} \Rightarrow |\mathbf{r}_v \times \mathbf{r}_y| = \sqrt{10}$$

$$\Rightarrow A = \int_0^{2\pi} \int_{-1}^1 \sqrt{10} \, du \, dv = \int_0^{2\pi} [\sqrt{10}u]_{-1}^1 \, dv = \int_0^{2\pi} 2\sqrt{10} \, dv = 4\pi\sqrt{10}$$

23. $z = 2 - x^2 - y^2$ and $z = \sqrt{x^2 + y^2} \Rightarrow z = 2 - z^2 \Rightarrow z^2 + z - 2 = 0 \Rightarrow z = -2$ or $z = 1$. Since $z = \sqrt{x^2 + y^2} \geq 0$, we get $z = 1$ where the cone intersects the paraboloid. When $x = 0$ and $y = 0, z = 2 \Rightarrow$ the vertex of the paraboloid is $(0, 0, 2)$. Therefore, z ranges from 1 to 2 on the “cap” $\Rightarrow r$ ranges from 1 (when $x^2 + y^2 = 1$) to 0 (when $x = 0$ and $y = 0$ at the vertex). Let $x = r \cos \theta, y = r \sin \theta$, and $z = 2 - r^2$. Then

$$\mathbf{r}(r, \theta) = (r \cos \theta)\mathbf{i} + (r \sin \theta)\mathbf{j} + (2 - r^2)\mathbf{k}, \quad 0 \leq r \leq 1, 0 \leq \theta \leq 2\pi \Rightarrow \mathbf{r}_r = (\cos \theta)\mathbf{i} + (\sin \theta)\mathbf{j} - 2r\mathbf{k} \text{ and}$$

$$\mathbf{r}_\theta = (-r \sin \theta)\mathbf{i} + (r \cos \theta)\mathbf{j} \Rightarrow \mathbf{r}_r \times \mathbf{r}_\theta = \begin{vmatrix} \mathbf{i} & \mathbf{j} & \mathbf{k} \\ \cos \theta & \sin \theta & -2r \\ -r \sin \theta & r \cos \theta & 0 \end{vmatrix}$$

$$= (2r^2 \cos \theta)\mathbf{i} + (2r^2 \sin \theta)\mathbf{j} + r\mathbf{k} \Rightarrow |\mathbf{r}_r \times \mathbf{r}_\theta| = \sqrt{4r^4 \cos^2 \theta + 4r^4 \sin^2 \theta + r^2} = r\sqrt{4r^2 + 1}$$

$$\Rightarrow A = \int_0^{2\pi} \int_0^1 r\sqrt{4r^2 + 1} \, dr \, d\theta = \int_0^{2\pi} \left[\frac{1}{12}(4r^2 + 1)^{3/2} \right]_0^1 \, d\theta = \int_0^{2\pi} \left(\frac{5\sqrt{5}-1}{12} \right) \, d\theta = \frac{\pi}{6}(5\sqrt{5}-1)$$

24. Let $x = r \cos \theta, y = r \sin \theta$ and $z = x^2 + y^2 = r^2$. Then $\mathbf{r}(r, \theta) = (r \cos \theta)\mathbf{i} + (r \sin \theta)\mathbf{j} + r^2\mathbf{k}, 1 \leq r \leq 2, 0 \leq \theta \leq 2\pi \Rightarrow \mathbf{r}_r = (\cos \theta)\mathbf{i} + (\sin \theta)\mathbf{j} + 2r\mathbf{k}$ and $\mathbf{r}_\theta = (-r \sin \theta)\mathbf{i} + (r \cos \theta)\mathbf{j}$

$$\Rightarrow \mathbf{r}_r \times \mathbf{r}_\theta = \begin{vmatrix} \mathbf{i} & \mathbf{j} & \mathbf{k} \\ \cos \theta & \sin \theta & 2r \\ -r \sin \theta & r \cos \theta & 0 \end{vmatrix} = (-2r^2 \cos \theta)\mathbf{i} - (2r^2 \sin \theta)\mathbf{j} + r\mathbf{k} \Rightarrow |\mathbf{r}_r \times \mathbf{r}_\theta|$$

$$= \sqrt{4r^4 \cos^2 \theta + 4r^4 \sin^2 \theta + r^2} = r\sqrt{4r^2 + 1} \Rightarrow A = \int_0^{2\pi} \int_1^2 r\sqrt{4r^2 + 1} \, dr \, d\theta = \int_0^{2\pi} \left[\frac{1}{12}(4r^2 + 1)^{3/2} \right]_1^2 \, d\theta$$

$$= \int_0^{2\pi} \left(\frac{17\sqrt{17}-5\sqrt{5}}{12} \right) \, d\theta = \frac{\pi}{6}(17\sqrt{17}-5\sqrt{5})$$

25. Let $x = \rho \sin \phi \cos \theta, y = \rho \sin \phi \sin \theta$, and $z = \rho \cos \phi \Rightarrow \rho = \sqrt{x^2 + y^2 + z^2} = \sqrt{2}$ on the sphere. Next, $x^2 + y^2 + z^2 = 2$ and $z = \sqrt{x^2 + y^2} \Rightarrow z^2 + z^2 = 2 \Rightarrow z^2 = 1 \Rightarrow z = 1$ since $z \geq 0 \Rightarrow \phi = \frac{\pi}{4}$. For the lower portion of the sphere cut by the cone, we get $\phi = \pi$. Then

$$\mathbf{r}(\phi, \theta) = (\sqrt{2} \sin \phi \cos \theta)\mathbf{i} + (\sqrt{2} \sin \phi \sin \theta)\mathbf{j} + (\sqrt{2} \cos \phi)\mathbf{k}, \quad \frac{\pi}{4} \leq \phi \leq \pi, 0 \leq \theta \leq 2\pi$$

$$\Rightarrow \mathbf{r}_\phi = (\sqrt{2} \sin \phi \cos \theta)\mathbf{i} + (\sqrt{2} \cos \phi \sin \theta)\mathbf{j} - (\sqrt{2} \sin \phi)\mathbf{k} \text{ and } \mathbf{r}_\theta = (-\sqrt{2} \sin \phi \sin \theta)\mathbf{i} + (\sqrt{2} \sin \phi \cos \theta)\mathbf{j}$$

$$\Rightarrow \mathbf{r}_\phi \times \mathbf{r}_\theta = \begin{vmatrix} \mathbf{i} & \mathbf{j} & \mathbf{k} \\ \sqrt{2} \cos \phi \cos \theta & \sqrt{2} \cos \phi \sin \theta & -\sqrt{2} \sin \phi \\ -\sqrt{2} \sin \phi \sin \theta & \sqrt{2} \sin \phi \cos \theta & 0 \end{vmatrix} = (2 \sin^2 \phi \cos \theta)\mathbf{i} + (2 \sin^2 \phi \sin \theta)\mathbf{j} + (2 \sin \phi \cos \phi)\mathbf{k}$$

$$\Rightarrow |\mathbf{r}_\phi \times \mathbf{r}_\theta| = \sqrt{4 \sin^4 \phi \cos^2 \theta + 4 \sin^4 \phi \sin^2 \theta + 4 \sin^2 \phi \cos^2 \phi} = \sqrt{4 \sin^2 \phi} = 2|\sin \phi| = 2 \sin \phi$$

$$\Rightarrow A = \int_0^{2\pi} \int_{\pi/4}^{\pi} 2 \sin \phi \, d\phi \, d\theta = \int_0^{2\pi} (2 + \sqrt{2}) \, d\theta = (4 + 2\sqrt{2})\pi$$

26. Let $x = \rho \sin \phi \cos \theta$, $y = \rho \sin \phi \sin \theta$, and $z = \rho \cos \phi \Rightarrow \rho = \sqrt{x^2 + y^2 + z^2} = 2$ on the sphere. Next, $z = -1 \Rightarrow -1 = 2 \cos \phi \Rightarrow \cos \phi = -\frac{1}{2} \Rightarrow \phi = \frac{2\pi}{3}$; $z = \sqrt{3} \Rightarrow \sqrt{3} = 2 \cos \phi \Rightarrow \cos \phi = \frac{\sqrt{3}}{2} \Rightarrow \phi = \frac{\pi}{6}$. Then $\mathbf{r}(\phi, \theta) = (2 \sin \phi \cos \theta)\mathbf{i} + (2 \sin \phi \sin \theta)\mathbf{j} + (2 \cos \phi)\mathbf{k}$, $\frac{\pi}{6} \leq \phi \leq \frac{2\pi}{3}$, $0 \leq \theta \leq 2\pi$

$$\Rightarrow \mathbf{r}_\phi = (2 \cos \phi \cos \theta)\mathbf{i} + (2 \cos \phi \sin \theta)\mathbf{j} - (2 \sin \phi)\mathbf{k} \text{ and } \mathbf{r}_\theta = (-2 \sin \phi \sin \theta)\mathbf{i} + (2 \sin \phi \cos \theta)\mathbf{j}$$

$$\Rightarrow \mathbf{r}_\phi \times \mathbf{r}_\theta = \begin{vmatrix} \mathbf{i} & \mathbf{j} & \mathbf{k} \\ 2 \cos \phi \cos \theta & 2 \cos \phi \sin \theta & -2 \sin \phi \\ -2 \sin \phi \sin \theta & 2 \sin \phi \cos \theta & 0 \end{vmatrix} = (4 \sin^2 \phi \cos \theta)\mathbf{i} + (4 \sin^2 \phi \sin \theta)\mathbf{j} + (4 \sin \phi \cos \phi)\mathbf{k}$$

$$\Rightarrow |\mathbf{r}_\phi \times \mathbf{r}_\theta| = \sqrt{16 \sin^4 \phi \cos^2 \theta + 16 \sin^4 \phi \sin^2 \theta + 16 \sin^2 \phi \cos^2 \phi}$$

$$\Rightarrow A = \int_0^{2\pi} \int_{\pi/6}^{2\pi/3} 4 \sin \phi \, d\phi \, d\theta = \int_0^{2\pi} (2 + 2\sqrt{3}) \, d\theta = (4 + 4\sqrt{3})\pi$$

27. The parametrization $\mathbf{r}(r, \theta) = (r \cos \theta)\mathbf{i} + (r \sin \theta)\mathbf{j} + r\mathbf{k}$

at $P_0 = (\sqrt{2}, \sqrt{2}, 2) \Rightarrow \theta = \frac{\pi}{4}, r = 2$,

$$\mathbf{r}_r = (\cos \theta)\mathbf{i} + (\sin \theta)\mathbf{j} + \mathbf{k} = \frac{\sqrt{2}}{2}\mathbf{i} + \frac{\sqrt{2}}{2}\mathbf{j} + \mathbf{k} \text{ and}$$

$$\mathbf{r}_\theta = (-r \sin \theta)\mathbf{i} + (r \cos \theta)\mathbf{j} = -\sqrt{2}\mathbf{i} + \sqrt{2}\mathbf{j}$$

$$\Rightarrow \mathbf{r}_r \times \mathbf{r}_\theta = \begin{vmatrix} \mathbf{i} & \mathbf{j} & \mathbf{k} \\ \sqrt{2}/2 & \sqrt{2}/2 & 1 \\ -\sqrt{2} & \sqrt{2} & 0 \end{vmatrix} = -\sqrt{2}\mathbf{i} - \sqrt{2}\mathbf{j} + 2\mathbf{k}$$

\Rightarrow the tangent plane is $0 = (-\sqrt{2}\mathbf{i} - \sqrt{2}\mathbf{j} + 2\mathbf{k}) \cdot [(x - \sqrt{2})\mathbf{i} + (y - \sqrt{2})\mathbf{j} + (z - 2)\mathbf{k}] \Rightarrow \sqrt{2}x + \sqrt{2}y - 2z = 0$, or $x + y - \sqrt{2}z = 0$. The parametrization $\mathbf{r}(r, \theta) \Rightarrow x = r \cos \theta, y = r \sin \theta$ and $z = r \Rightarrow x^2 + y^2 = r^2 = z^2$

\Rightarrow the surface is $z = \sqrt{x^2 + y^2}$.

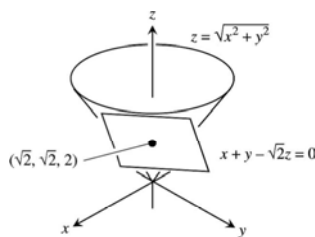

28. The parametrization $\mathbf{r}(\phi, \theta) = (4 \sin \phi \cos \theta)\mathbf{i} + (4 \sin \phi \sin \theta)\mathbf{j} + (4 \cos \phi)\mathbf{k}$ at

$P_0 = (\sqrt{2}, \sqrt{2}, 2\sqrt{3}) \Rightarrow \rho = 4$ and

$$z = 2\sqrt{3} = 4 \cos \phi \Rightarrow \phi = \frac{\pi}{6}; \text{ also } x = \sqrt{2} \text{ and } y = \sqrt{2}$$

$\Rightarrow \theta = \frac{\pi}{4}$. Then

$$\mathbf{r}_\phi = (4 \cos \phi \cos \theta)\mathbf{i} + (4 \cos \phi \sin \theta)\mathbf{j} - (4 \sin \phi)\mathbf{k}$$

$$= \sqrt{6}\mathbf{i} + \sqrt{6}\mathbf{j} - 2\mathbf{k} \text{ and}$$

$$\mathbf{r}_\theta = (-4 \sin \phi \sin \theta)\mathbf{i} + (4 \sin \phi \cos \theta)\mathbf{j} = -\sqrt{2}\mathbf{i} + \sqrt{2}\mathbf{j} \text{ at } P_0 \Rightarrow \mathbf{r}_\phi \times \mathbf{r}_\theta = \begin{vmatrix} \mathbf{i} & \mathbf{j} & \mathbf{k} \\ \sqrt{6} & \sqrt{6} & -2 \\ -\sqrt{2} & \sqrt{2} & 0 \end{vmatrix} = 2\sqrt{2}\mathbf{i} + 2\sqrt{2}\mathbf{j} + 4\sqrt{3}\mathbf{k}$$

\Rightarrow the tangent plane is $(2\sqrt{2}\mathbf{i} + 2\sqrt{2}\mathbf{j} + 4\sqrt{3}\mathbf{k}) \cdot [(x - \sqrt{2})\mathbf{i} + (y - \sqrt{2})\mathbf{j} + (z - 2\sqrt{3})\mathbf{k}] = 0$

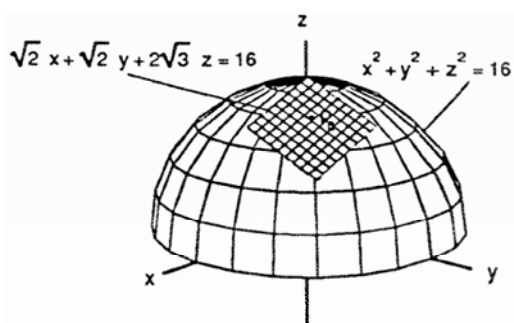

$\Rightarrow \sqrt{2}x + \sqrt{2}y + 2\sqrt{3}z = 16$, or $x + y + \sqrt{6}z = 8\sqrt{2}$. The parametrization
 $\Rightarrow x = 4 \sin \phi \cos \theta, y = 4 \sin \phi \sin \theta, z = 4 \cos \phi \Rightarrow$ the surface is $x^2 + y^2 + z^2 = 16, z \geq 0$.

29. The parametrization

$$\mathbf{r}(\theta, z) = (3 \sin 2\theta)\mathbf{i} + (6 \sin^2 \theta)\mathbf{j} + z\mathbf{k} \text{ at}$$

$$P_0 = \left(\frac{3\sqrt{3}}{2}, \frac{9}{2}, 0\right) \Rightarrow \theta = \frac{\pi}{3} \text{ and } z = 0. \text{ Then}$$

$$\mathbf{r}_\theta = (6 \cos 2\theta)\mathbf{i} + (12 \sin \theta \cos \theta)\mathbf{j} = -3\mathbf{i} + 3\sqrt{3}\mathbf{j} \text{ and}$$

$$\mathbf{r}_z = \mathbf{k} \text{ at } P_0 \Rightarrow \mathbf{r}_\theta \times \mathbf{r}_z = \begin{vmatrix} \mathbf{i} & \mathbf{j} & \mathbf{k} \\ -3 & 3\sqrt{3} & 0 \\ 0 & 0 & 1 \end{vmatrix} = 3\sqrt{3}\mathbf{i} + 3\mathbf{j}$$

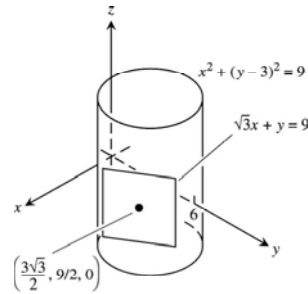

\Rightarrow the tangent plane is $(3\sqrt{3}\mathbf{i} + 3\mathbf{j}) \cdot \left[\left(x - \frac{3\sqrt{3}}{2}\right)\mathbf{i} + \left(y - \frac{9}{2}\right)\mathbf{j} + (z - 0)\mathbf{k}\right] = 0 \Rightarrow \sqrt{3}x + y = 9$. The parametrization

$$\begin{aligned} \Rightarrow x = 3 \sin 2\theta \text{ and } y = 6 \sin^2 \theta &\Rightarrow x^2 + y^2 = 9 \sin^2 2\theta + (6 \sin^2 \theta)^2 \\ &= 9(4 \sin^2 \theta \cos^2 \theta) + 36 \sin^4 \theta = 6(6 \sin^2 \theta) = 6y \Rightarrow x^2 + y^2 - 6y + 9 = 9 \Rightarrow x^2 + (y - 3)^2 = 9 \end{aligned}$$

30. The parametrization $\mathbf{r}(x, y) = x\mathbf{i} + y\mathbf{j} - x^2\mathbf{k}$ at

$$P_0 = (1, 2, -1) \Rightarrow \mathbf{r}_x = \mathbf{i} - 2x\mathbf{k} = \mathbf{i} - 2\mathbf{k} \text{ and } \mathbf{r}_y = \mathbf{j}$$

$$\text{at } P_0 \Rightarrow \mathbf{r}_x \times \mathbf{r}_y = \begin{vmatrix} \mathbf{i} & \mathbf{j} & \mathbf{k} \\ 1 & 0 & -2 \\ 0 & 1 & 0 \end{vmatrix} = 2\mathbf{i} + \mathbf{k} \Rightarrow \text{the tangent}$$

$$\text{plane is } (2\mathbf{i} + \mathbf{k}) \cdot [(x - 1)\mathbf{i} + (y - 2)\mathbf{j} + (z + 1)\mathbf{k}] = 0$$

$$\Rightarrow 2x + z = 1. \text{ The parametrization } \Rightarrow x = x, y = y$$

$$\text{and } z = -x^2 \Rightarrow \text{the surface is } z = -x^2$$

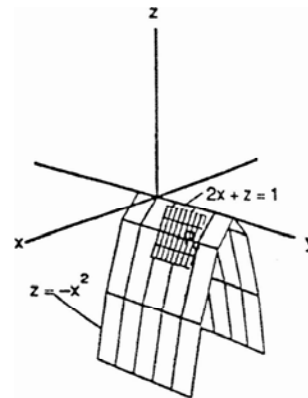

31. (a) An arbitrary point on the circle C is $(x, z) = (R + r \cos u, r \sin u) \Rightarrow (x, y, z)$ is on the torus with
 $x = (R + r \cos u) \cos v, y = (R + r \cos u) \sin v$, and $z = r \sin u, 0 \leq u \leq 2\pi, 0 \leq v \leq 2\pi$

(b) $\mathbf{r}_u = (-r \sin u \cos v)\mathbf{i} - (r \sin u \sin v)\mathbf{j} + (r \cos u)\mathbf{k}$ and $\mathbf{r}_v = (-(R + r \cos u) \sin v)\mathbf{i} + ((R + r \cos u) \cos v)\mathbf{j}$

$$\begin{aligned} \Rightarrow \mathbf{r}_u \times \mathbf{r}_v &= \begin{vmatrix} \mathbf{i} & \mathbf{j} & \mathbf{k} \\ -r \sin u \cos v & -r \sin u \sin v & r \cos u \\ -(R + r \cos u) \sin v & (R + r \cos u) \cos v & 0 \end{vmatrix} \\ &= -(R + r \cos u)(r \cos v \cos u)\mathbf{i} - (R + r \cos u)(r \sin v \cos u)\mathbf{j} + (-r \sin u)(R + r \cos u)\mathbf{k} \\ \Rightarrow |\mathbf{r}_u \times \mathbf{r}_v|^2 &= (R + r \cos u)^2 (r^2 \cos^2 v \cos^2 u + r^2 \sin^2 v \cos^2 u + r^2 \sin^2 u) \Rightarrow |\mathbf{r}_u \times \mathbf{r}_v| = r(R + r \cos u) \\ \Rightarrow A &= \int_0^{2\pi} \int_0^{2\pi} (rR + r^2 \cos u) du dv = \int_0^{2\pi} 2\pi rR dv = 4\pi^2 rR \end{aligned}$$

32. (a) The point (x, y, z) is on the surface for fixed $x = f(u)$ when $y = g(u)\sin\left(\frac{\pi}{2}-v\right)$ and $z = g(u)\cos\left(\frac{\pi}{2}-v\right) \Rightarrow x = f(u), y = g(u)\cos v$, and $z = g(u)\sin v \Rightarrow \mathbf{r}(u, v) = f(u)\mathbf{i} + (g(u)\cos v)\mathbf{j} + (g(u)\sin v)\mathbf{k}, 0 \leq v \leq 2\pi, a \leq u \leq b$
- (b) Let $u = y$ and $x = u^2 \Rightarrow f(u) = u^2$ and $g(u) = u \Rightarrow \mathbf{r}(u, v) = u^2\mathbf{i} + (u\cos v)\mathbf{j} + (u\sin v)\mathbf{k}, 0 \leq v \leq 2\pi, 0 \leq u$
33. (a) Let $w^2 + \frac{z^2}{c^2} = 1$ where $w = \cos \phi$ and $\frac{z}{c} = \sin \phi \Rightarrow \frac{x^2}{a^2} + \frac{y^2}{b^2} = \cos^2 \phi \Rightarrow \frac{x}{a} = \cos \phi \cos \theta$ and $\frac{y}{b} = \cos \phi \sin \theta \Rightarrow x = a \cos \theta \cos \phi, y = b \sin \theta \cos \phi$, and $z = c \sin \phi \Rightarrow \mathbf{r}(\theta, \phi) = (a \cos \theta \cos \phi)\mathbf{i} + (b \sin \theta \cos \phi)\mathbf{j} + (c \sin \phi)\mathbf{k}$
- (b) $\mathbf{r}_\theta = (-a \sin \theta \cos \phi)\mathbf{i} + (b \cos \theta \cos \phi)\mathbf{j}$ and $\mathbf{r}_\phi = (-a \cos \theta \sin \phi)\mathbf{i} - (b \sin \theta \sin \phi)\mathbf{j} + (c \cos \phi)\mathbf{k}$
- $$\Rightarrow \mathbf{r}_\theta \times \mathbf{r}_\phi = \begin{vmatrix} \mathbf{i} & \mathbf{j} & \mathbf{k} \\ -a \sin \theta \cos \phi & b \cos \theta \cos \phi & 0 \\ -a \cos \theta \sin \phi & -b \sin \theta \sin \phi & c \cos \phi \end{vmatrix}$$
- $$= (bc \cos \theta \cos^2 \phi)\mathbf{i} + (ac \sin \theta \cos^2 \phi)\mathbf{j} + (ab \sin \phi \cos \phi)\mathbf{k}$$
- $$\Rightarrow |\mathbf{r}_\theta \times \mathbf{r}_\phi|^2 = b^2 c^2 \cos^2 \theta \cos^4 \phi + a^2 c^2 \sin^2 \theta \cos^4 \phi + a^2 b^2 \sin^2 \phi \cos^2 \phi$$
- , and the result follows.
- $$A = \int_0^{2\pi} \int_0^{2\pi} |\mathbf{r}_\theta \times \mathbf{r}_\phi| d\phi d\theta = \int_0^{2\pi} \int_0^{2\pi} [a^2 b^2 \sin^2 \phi \cos^2 \phi + b^2 c^2 \cos^2 \theta \cos^4 \phi + a^2 c^2 \sin^2 \theta \cos^4 \phi]^{1/2} d\phi d\theta$$
34. (a) $\mathbf{r}(\theta, u) = (\cosh u \cos \theta)\mathbf{i} + (\cosh u \sin \theta)\mathbf{j} + (\sinh u)\mathbf{k}$
- (b) $\mathbf{r}(\theta, u) = (a \cosh u \cos \theta)\mathbf{i} + (b \cosh u \sin \theta)\mathbf{j} + (c \sinh u)\mathbf{k}$
35. $\mathbf{r}(\theta, u) = (5 \cosh u \cos \theta)\mathbf{i} + (5 \cosh u \sin \theta)\mathbf{j} + (5 \sinh u)\mathbf{k} \Rightarrow \mathbf{r}_\theta = (-5 \cosh u \sin \theta)\mathbf{i} + (5 \cosh u \cos \theta)\mathbf{j}$ and $\mathbf{r}_u = (5 \sinh u \cos \theta)\mathbf{i} + (5 \sinh u \sin \theta)\mathbf{j} + (5 \cosh u)\mathbf{k} \Rightarrow \mathbf{r}_\theta \times \mathbf{r}_u = \begin{vmatrix} \mathbf{i} & \mathbf{j} & \mathbf{k} \\ -5 \cosh u \sin \theta & 5 \cosh u \cos \theta & 0 \\ 5 \sinh u \cos \theta & 5 \sinh u \sin \theta & 5 \cosh u \end{vmatrix}$
- $$= (25 \cosh^2 u \cos \theta)\mathbf{i} + (25 \cosh^2 u \sin \theta)\mathbf{j} - (25 \cosh u \sinh u)\mathbf{k}$$
- . At the point
- $(x_0, y_0, 0)$
- , where
- $x_0^2 + y_0^2 = 25$
- we have
- $5 \sinh u = 0 \Rightarrow u = 0$
- and
- $x_0 = 25 \cos \theta, y_0 = 25 \sin \theta \Rightarrow$
- the tangent plane is
- $5(x_0\mathbf{i} + y_0\mathbf{j}) \cdot [(x - x_0)\mathbf{i} + (y - y_0)\mathbf{j} + z\mathbf{k}] = 0 \Rightarrow x_0 x - x_0^2 + y_0 y - y_0^2 = 0 \Rightarrow x_0 x + y_0 y = 25$
36. Let $\frac{z^2}{c^2} - w^2 = 1$ where $\frac{z}{c} = \cosh u$ and $w = \sinh u \Rightarrow w^2 = \frac{x^2}{a^2} + \frac{y^2}{b^2} \Rightarrow \frac{x}{a} = w \cos \theta$ and $\frac{y}{b} = w \sin \theta \Rightarrow x = a \sinh u \cos \theta, y = b \sinh u \sin \theta$, and $z = c \cosh u \Rightarrow \mathbf{r}(\theta, u) = (a \sinh u \cos \theta)\mathbf{i} + (b \sinh u \sin \theta)\mathbf{j} + (c \cosh u)\mathbf{k}, 0 \leq \theta \leq 2\pi, -\infty < u < \infty$
37. $\mathbf{p} = \mathbf{k}, \nabla f = 2x\mathbf{i} + 2y\mathbf{j} - \mathbf{k} \Rightarrow |\nabla f| = \sqrt{(2x)^2 + (2y)^2 + (-1)^2} = \sqrt{4x^2 + 4y^2 + 1}$ and $|\nabla f \cdot \mathbf{p}| = 1;$
 $z = 2 \Rightarrow x^2 + y^2 = 2$; thus $S = \iint_R \frac{|\nabla f|}{|\nabla f \cdot \mathbf{p}|} dA = \iint_R \sqrt{4x^2 + 4y^2 + 1} dx dy = \iint_R \sqrt{4r^2 \cos^2 \theta + 4r^2 \sin^2 \theta + 1} r dr d\theta$
 $= \int_0^{2\pi} \int_0^{\sqrt{2}} \sqrt{4r^2 + 1} r dr d\theta = \int_0^{2\pi} \left[\frac{1}{12} (4r^2 + 1)^{3/2} \right]_0^{\sqrt{2}} d\theta = \int_0^{2\pi} \frac{13}{6} d\theta = \frac{13}{3} \pi$

$$\begin{aligned}
 38. \quad \mathbf{p} = \mathbf{k}, \nabla f = 2x\mathbf{i} + 2y\mathbf{j} - \mathbf{k} &\Rightarrow |\nabla f| = \sqrt{4x^2 + 4y^2 + 1} \text{ and } |\nabla f \cdot \mathbf{p}| = 1; \quad 2 \leq x^2 + y^2 \leq 6 \Rightarrow S = \iint_R \frac{|\nabla f|}{|\nabla f \cdot \mathbf{p}|} dA \\
 &= \iint_R \sqrt{4x^2 + 4y^2 + 1} dx dy = \iint_R \sqrt{4r^2 + 1} r dr d\theta = \int_0^{2\pi} \int_{\sqrt{2}}^{\sqrt{6}} \sqrt{4r^2 + 1} r dr d\theta = \int_0^{2\pi} \left[\frac{1}{12} (4r^2 + 1)^{3/2} \right]_{\sqrt{2}}^{\sqrt{6}} d\theta \\
 &= \int_0^{2\pi} \frac{49}{6} d\theta = \frac{49}{3} \pi
 \end{aligned}$$

$$\begin{aligned}
 39. \quad \mathbf{p} = \mathbf{k}, \nabla f = \mathbf{i} + 2\mathbf{j} + 2\mathbf{k} &\Rightarrow |\nabla f| = 3 \text{ and } |\nabla f \cdot \mathbf{p}| = 2; \quad x = y^2 \text{ and } x = 2 - y^2 \text{ intersect at } (1, 1) \text{ and } (1, -1) \\
 \Rightarrow S = \iint_R \frac{|\nabla f|}{|\nabla f \cdot \mathbf{p}|} dA &= \iint_R \frac{3}{2} dx dy = \int_{-1}^1 \int_{y^2}^{2-y^2} \frac{3}{2} dx dy = \int_{-1}^1 (3 - 3y^2) dy = 4
 \end{aligned}$$

$$\begin{aligned}
 40. \quad \mathbf{p} = \mathbf{k}, \nabla f = 2x\mathbf{i} - 2\mathbf{k} &\Rightarrow |\nabla f| = \sqrt{4x^2 + 4} = 2\sqrt{x^2 + 1} \text{ and } |\nabla f \cdot \mathbf{p}| = 2 \Rightarrow S = \iint_R \frac{|\nabla f|}{|\nabla f \cdot \mathbf{p}|} dA \\
 &= \iint_R \frac{2\sqrt{x^2 + 1}}{2} dx dy = \int_0^{\sqrt{3}} \int_0^x \sqrt{x^2 + 1} dy dx = \int_0^{\sqrt{3}} x\sqrt{x^2 + 1} dx = \left[\frac{1}{3} (x^2 + 1)^{3/2} \right]_0^{\sqrt{3}} = \frac{1}{3} (4)^{3/2} - \frac{1}{3} = \frac{7}{3}
 \end{aligned}$$

$$\begin{aligned}
 41. \quad \mathbf{p} = \mathbf{k}, \nabla f = 2x\mathbf{i} - 2\mathbf{j} - 2\mathbf{k} &\Rightarrow |\nabla f| = \sqrt{(2x)^2 + (-2)^2 + (-2)^2} = \sqrt{4x^2 + 8} = 2\sqrt{x^2 + 2} \text{ and } |\nabla f \cdot \mathbf{p}| = 2 \\
 \Rightarrow S = \iint_R \frac{|\nabla f|}{|\nabla f \cdot \mathbf{p}|} dA &= \iint_R \frac{2\sqrt{x^2 + 2}}{2} dx dy = \int_0^2 \int_0^{3x} \sqrt{x^2 + 2} dy dx = \int_0^2 3x\sqrt{x^2 + 2} dx = \left[(x^2 + 2)^{3/2} \right]_0^2 = 6\sqrt{6} - 2\sqrt{2}
 \end{aligned}$$

$$\begin{aligned}
 42. \quad \mathbf{p} = \mathbf{k}, \nabla f = 2x\mathbf{i} + 2y\mathbf{j} + 2z\mathbf{k} &\Rightarrow |\nabla f| = \sqrt{4x^2 + 4y^2 + 4z^2} = \sqrt{8} = 2\sqrt{2} \text{ and } |\nabla f \cdot \mathbf{p}| = 2z; \quad x^2 + y^2 + z^2 = 2 \text{ and } \\
 z = \sqrt{x^2 + y^2} &\Rightarrow x^2 + y^2 = 1; \text{ thus, } S = \iint_R \frac{|\nabla f|}{|\nabla f \cdot \mathbf{p}|} dA = \iint_R \frac{2\sqrt{2}}{2z} dA = \sqrt{2} \iint_R \frac{1}{z} dA \\
 &= \sqrt{2} \iint_R \frac{1}{\sqrt{2 - (x^2 + y^2)}} dA = \sqrt{2} \int_0^{2\pi} \int_0^1 \frac{r dr d\theta}{\sqrt{2 - r^2}} = \sqrt{2} \int_0^{2\pi} (-1 + \sqrt{2}) d\theta = 2\pi(2 - \sqrt{2})
 \end{aligned}$$

$$\begin{aligned}
 43. \quad \mathbf{p} = \mathbf{k}, \nabla f = c\mathbf{i} - \mathbf{k} &\Rightarrow |\nabla f| = \sqrt{c^2 + 1} \text{ and } |\nabla f \cdot \mathbf{p}| = 1 \Rightarrow S = \iint_R \frac{|\nabla f|}{|\nabla f \cdot \mathbf{p}|} dA = \iint_R \sqrt{c^2 + 1} dx dy \\
 &= \int_0^{2\pi} \int_0^1 \sqrt{c^2 + 1} r dr d\theta = \int_0^{2\pi} \frac{\sqrt{c^2 + 1}}{2} d\theta = \pi\sqrt{c^2 + 1}
 \end{aligned}$$

$$\begin{aligned}
 44. \quad \mathbf{p} = \mathbf{k}, \nabla f = 2x\mathbf{i} + 2z\mathbf{j} &\Rightarrow |\nabla f| = \sqrt{(2x)^2 + (2z)^2} = 2 \text{ and } |\nabla f \cdot \mathbf{p}| = 2z \text{ for the upper surface, } z \geq 0 \\
 \Rightarrow S = \iint_R \frac{|\nabla f|}{|\nabla f \cdot \mathbf{p}|} dA &= \iint_R \frac{2}{2z} dA = \iint_R \frac{1}{\sqrt{1-x^2}} dx dy = 2 \int_{-1/2}^{1/2} \int_0^{1/2} \frac{1}{\sqrt{1-x^2}} dy dx = \int_{-1/2}^{1/2} \frac{1}{\sqrt{1-x^2}} dx \\
 &= \left[\sin^{-1} x \right]_{-1/2}^{1/2} = \frac{\pi}{6} - \left(-\frac{\pi}{6} \right) = \frac{\pi}{3}
 \end{aligned}$$

45. $\mathbf{p} = \mathbf{i}$, $\nabla f = \mathbf{i} + 2y\mathbf{j} + 2z\mathbf{k} \Rightarrow |\nabla f| = \sqrt{1^2 + (2y)^2 + (2z)^2} = \sqrt{1 + 4y^2 + 4z^2}$ and $|\nabla f \cdot \mathbf{p}| = 1$; $1 \leq y^2 + z^2 \leq 4$
 $\Rightarrow S = \iint_R \frac{|\nabla f|}{|\nabla f \cdot \mathbf{p}|} dA = \iint_R \sqrt{1 + 4y^2 + 4z^2} dy dz = \int_0^{2\pi} \int_1^2 \sqrt{1 + 4r^2} \cos^2 \theta + 4r^2 \sin^2 \theta r dr d\theta$
 $= \int_0^{2\pi} \int_1^2 \sqrt{1 + 4r^2} r dr d\theta = \int_0^{2\pi} \left[\frac{1}{12} (1 + 4r^2)^{3/2} \right]_1^2 d\theta = \int_0^{2\pi} \frac{1}{12} (17\sqrt{17} - 5\sqrt{5}) d\theta = \frac{\pi}{6} (17\sqrt{17} - 5\sqrt{5})$

46. $\mathbf{p} = \mathbf{j}$, $\nabla f = 2x\mathbf{i} + \mathbf{j} + 2z\mathbf{k} \Rightarrow |\nabla f| = \sqrt{4x^2 + 4z^2 + 1}$ and $|\nabla f \cdot \mathbf{p}| = 1$; $y = 0$ and $x^2 + y + z^2 = 2 \Rightarrow x^2 + z^2 = 2$;
 thus $S = \iint_R \frac{|\nabla f|}{|\nabla f \cdot \mathbf{p}|} dA = \iint_R \sqrt{4x^2 + 4z^2 + 1} dx dz = \int_0^{2\pi} \int_0^{\sqrt{2}} \sqrt{4r^2 + 1} r dr d\theta = \int_0^{2\pi} \frac{13}{6} d\theta = \frac{13}{3}\pi$

47. $\mathbf{p} = \mathbf{k}$, $\nabla f = (2x - \frac{2}{x})\mathbf{i} + \sqrt{15}\mathbf{j} - \mathbf{k} \Rightarrow |\nabla f| = \sqrt{(2x - \frac{2}{x})^2 + (\sqrt{15})^2 + (-1)^2} = \sqrt{4x^2 + 8 + \frac{4}{x^2}} = \sqrt{(2x + \frac{2}{x})^2}$
 $= 2x + \frac{2}{x}$, on $1 \leq x \leq 2$ and $|\nabla f \cdot \mathbf{p}| = 1 \Rightarrow S = \iint_R \frac{|\nabla f|}{|\nabla f \cdot \mathbf{p}|} dA = \iint_R (2x + 2x^{-1}) dx dy = \int_0^1 \int_1^2 (2x + 2x^{-1}) dx dy$
 $= \int_0^1 [x^2 + 2 \ln x]_1^2 dy = \int_0^1 (3 + 2 \ln 2) dy = 3 + 2 \ln 2$

48. $\mathbf{p} = \mathbf{k}$, $\nabla f = 3\sqrt{x}\mathbf{i} + 3\sqrt{y}\mathbf{j} - 3\mathbf{k} \Rightarrow |\nabla f| = \sqrt{9x + 9y + 9} = 3\sqrt{x + y + 1}$ and $|\nabla f \cdot \mathbf{p}| = 3$
 $\Rightarrow S = \iint_R \frac{|\nabla f|}{|\nabla f \cdot \mathbf{p}|} dA = \iint_R \sqrt{x + y + 1} dx dy = \int_0^1 \int_0^1 \sqrt{x + y + 1} dx dy = \int_0^1 \left[\frac{2}{3} (x + y + 1)^{3/2} \right]_0^1 dy$
 $= \int_0^1 \left[\frac{2}{3} (y + 2)^{3/2} - \frac{2}{3} (y + 1)^{3/2} \right] dy = \left[\frac{4}{15} (y + 2)^{5/2} - \frac{4}{15} (y + 1)^{5/2} \right]_0^1 = \frac{4}{15} [(3)^{5/2} - (2)^{5/2} - (2)^{5/2} + 1]$
 $= \frac{4}{15} (9\sqrt{3} - 8\sqrt{2} + 1)$

49. $f_x(x, y) = 2x$, $f_y(x, y) = 2y \Rightarrow \sqrt{f_x^2 + f_y^2 + 1} = \sqrt{4x^2 + 4y^2 + 1} \Rightarrow \text{Area} = \iint_R \sqrt{4x^2 + 4y^2 + 1} dx dy$
 $= \int_0^{2\pi} \int_0^{\sqrt{3}} \sqrt{4r^2 + 1} r dr d\theta = \frac{\pi}{6} (13\sqrt{13} - 1)$

50. $f_x(y, z) = -2y$, $f_z(y, z) = -2z \Rightarrow \sqrt{f_y^2 + f_z^2 + 1} = \sqrt{4y^2 + 4z^2 + 1} \Rightarrow \text{Area} = \iint_R \sqrt{4y^2 + 4z^2 + 1} dy dz$
 $= \int_0^{2\pi} \int_0^1 \sqrt{4r^2 + 1} r dr d\theta = \frac{\pi}{6} (5\sqrt{5} - 1)$

51. $f_x(x, y) = \frac{x}{\sqrt{x^2 + y^2}}$, $f_y(x, y) = \frac{y}{\sqrt{x^2 + y^2}} \Rightarrow \sqrt{f_x^2 + f_y^2 + 1} = \sqrt{\frac{x^2}{x^2 + y^2} + \frac{y^2}{x^2 + y^2} + 1} = \sqrt{2} \Rightarrow \text{Area} = \iint_{R_{xy}} \sqrt{2} dx dy$
 $= \sqrt{2}$ (Area between the ellipse and the circle) $= \sqrt{2}(6\pi - \pi) = 5\pi\sqrt{2}$

52. Over R_{xy} : $z = 2 - \frac{2}{3}x - 2y \Rightarrow f_x(x, y) = -\frac{2}{3}$, $f_y(x, y) = -2 \Rightarrow \sqrt{f_x^2 + f_y^2 + 1} = \sqrt{\frac{4}{9} + 4 + 1} = \frac{7}{3}$
 $\Rightarrow \text{Area} = \iint_{R_{xy}} \frac{7}{3} dA = \frac{7}{3}$ (Area of the shadow triangle in the xy -plane) $= \left(\frac{7}{3}\right)\left(\frac{3}{2}\right) = \frac{7}{2}$.

Over R_{xz} : $y = 1 - \frac{1}{3}x - \frac{1}{2}z \Rightarrow f_x(x, z) = -\frac{1}{3}, f_z(x, z) = -\frac{1}{2} \Rightarrow \sqrt{f_x^2 + f_z^2 + 1} = \sqrt{\frac{1}{9} + \frac{1}{4} + 1} = \frac{7}{6}$
 $\Rightarrow \text{Area} = \iint_{R_{xz}} \frac{7}{6} dA = \frac{7}{6}$ (Area of the shadow triangle in the xz -plane) $= \left(\frac{7}{6}\right)(3) = \frac{7}{2}$.

Over R_{yz} : $x = 3 - 3y - \frac{3}{2}z \Rightarrow f_y(y, z) = -3, f_z(y, z) = -\frac{3}{2} \Rightarrow \sqrt{f_y^2 + f_z^2 + 1} = \sqrt{9 + \frac{9}{4} + 1} = \frac{7}{2}$
 $\Rightarrow \text{Area} = \iint_{R_{yz}} \frac{7}{2} dA = \frac{7}{2}$ (Area of the shadow triangle in the yz -plane) $= \left(\frac{7}{2}\right)(1) = \frac{7}{2}$.

53. $y = \frac{2}{3}z^{3/2} \Rightarrow f_x(x, z) = 0, f_z(x, z) = z^{1/2} \Rightarrow \sqrt{f_x^2 + f_z^2 + 1} = \sqrt{z+1}; y = \frac{16}{3} \Rightarrow \frac{16}{3} = \frac{2}{3}z^{3/2} \Rightarrow z = 4$
 $\Rightarrow \text{Area} = \int_0^4 \int_0^1 \sqrt{z+1} dx dz = \int_0^4 \sqrt{z+1} dz = \frac{2}{3}(5\sqrt{5} - 1)$

54. $y = 4 - z \Rightarrow f_x(x, z) = 0, f_z(x, z) = -1 \Rightarrow \sqrt{f_x^2 + f_z^2 + 1} = \sqrt{2} \Rightarrow \text{Area} = \iint_{R_{xz}} \sqrt{2} dA = \int_0^2 \int_0^{4-z^2} \sqrt{2} dx dz$
 $= \sqrt{2} \int_0^2 (4 - z^2) dz = \frac{16\sqrt{2}}{3}$

55. $\mathbf{r}(x, y) = x\mathbf{i} + y\mathbf{j} + f(x, y)\mathbf{k} \Rightarrow \mathbf{r}_x(x, y) = \mathbf{i} + f_x(x, y)\mathbf{k}, \mathbf{r}_y(x, y) = \mathbf{j} + f_y(x, y)\mathbf{k}$

$$\Rightarrow \mathbf{r}_x \times \mathbf{r}_y = \begin{vmatrix} \mathbf{i} & \mathbf{j} & \mathbf{k} \\ 1 & 0 & f_x(x, y) \\ 0 & 1 & f_y(x, y) \end{vmatrix} = -f_x(x, y)\mathbf{i} - f_y(x, y)\mathbf{j} + \mathbf{k}$$

$$\Rightarrow |\mathbf{r}_x \times \mathbf{r}_y| = \sqrt{(-f_x(x, y))^2 + (-f_y(x, y))^2 + 1} = \sqrt{f_x(x, y)^2 + f_y(x, y)^2 + 1}$$

$$\Rightarrow d\sigma = \sqrt{f_x(x, y)^2 + f_y(x, y)^2 + 1} dA$$

56. S is obtained by rotating $y = f(x), a \leq x \leq b$ about the x -axis where $f(x) \geq 0$

(a) Let (x, y, z) be a point on S . Consider the cross section when $x = x^*$, the cross section is a circle with radius $r = f(x^*)$. The set of parametric equations for this circle are given by $y(\theta) = r \cos \theta = f(x^*) \cos \theta$ and $z(\theta) = r \sin \theta = f(x^*) \sin \theta$ where $0 \leq \theta \leq 2\pi$. Since x can take on any value between a and b we have $x(x, \theta) = x, y(x, \theta) = f(x) \cos \theta, z(x, \theta) = f(x) \sin \theta$ where $a \leq x \leq b$ and $0 \leq \theta \leq 2\pi$. Thus $\mathbf{r}(x, \theta) = x\mathbf{i} + f(x) \cos \theta \mathbf{j} + f(x) \sin \theta \mathbf{k}$

(b) $\mathbf{r}_x(x, \theta) = \mathbf{i} + f'(x) \cos \theta \mathbf{j} + f'(x) \sin \theta \mathbf{k}$ and $\mathbf{r}_\theta(x, \theta) = -f(x) \sin \theta \mathbf{j} + f(x) \cos \theta \mathbf{k}$

$$\Rightarrow \mathbf{r}_x \times \mathbf{r}_\theta = \begin{vmatrix} \mathbf{i} & \mathbf{j} & \mathbf{k} \\ 1 & f'(x) \cos \theta & f'(x) \sin \theta \\ 0 & -f(x) \sin \theta & f(x) \cos \theta \end{vmatrix} = f(x) \cdot f'(x) \mathbf{i} - f(x) \cos \theta \mathbf{j} - f(x) \sin \theta \mathbf{k}$$

$$\Rightarrow |\mathbf{r}_x \times \mathbf{r}_\theta| = \sqrt{(f(x) \cdot f'(x))^2 + (-f(x) \cos \theta)^2 + (-f(x) \sin \theta)^2} = f(x) \sqrt{1 + (f'(x))^2}$$

$$A = \int_a^b \int_0^{2\pi} f(x) \sqrt{1 + (f'(x))^2} d\theta dx = \int_a^b \left[\left(f(x) \sqrt{1 + (f'(x))^2} \right) \theta \right]_0^{2\pi} dx = \int_a^b 2\pi f(x) \sqrt{1 + (f'(x))^2} dx$$

16.6 SURFACE INTEGRALS

1. Let the parametrization be $\mathbf{r}(x, z) = x\mathbf{i} + x^2\mathbf{j} + z\mathbf{k} \Rightarrow \mathbf{r}_x = \mathbf{i} + 2x\mathbf{j}$ and $\mathbf{r}_z = \mathbf{k} \Rightarrow \mathbf{r}_x \times \mathbf{r}_z = \begin{vmatrix} \mathbf{i} & \mathbf{j} & \mathbf{k} \\ 1 & 2x & 0 \\ 0 & 0 & 1 \end{vmatrix}$

$$= 2x\mathbf{i} + \mathbf{j} \Rightarrow |\mathbf{r}_x \times \mathbf{r}_z| = \sqrt{4x^2 + 1} \Rightarrow \iint_S G(x, y, z) d\sigma = \int_0^3 \int_0^2 x\sqrt{4x^2 + 1} dx dz = \int_0^3 \left[\frac{1}{12}(4x^2 + 1)^{3/2} \right]_0^2 dz$$

$$= \int_0^3 \frac{1}{12}(17\sqrt{17} - 1) dz = \frac{17\sqrt{17} - 1}{4}$$

2. Let the parametrization be $\mathbf{r}(x, y) = x\mathbf{i} + y\mathbf{j} + \sqrt{4 - y^2}\mathbf{k}, -2 \leq y \leq 2 \Rightarrow \mathbf{r}_x = \mathbf{i}$ and $\mathbf{r}_y = \mathbf{j} - \frac{y}{\sqrt{4 - y^2}}\mathbf{k}$

$$\Rightarrow \mathbf{r}_x \times \mathbf{r}_y = \begin{vmatrix} \mathbf{i} & \mathbf{j} & \mathbf{k} \\ 1 & 0 & 0 \\ 0 & 1 & -\frac{y}{\sqrt{4 - y^2}} \end{vmatrix} = \frac{y}{\sqrt{4 - y^2}}\mathbf{j} + \mathbf{k} \Rightarrow |\mathbf{r}_x \times \mathbf{r}_y| = \sqrt{\frac{y^2}{4 - y^2} + 1} = \frac{2}{\sqrt{4 - y^2}}$$

$$\Rightarrow \iint_S G(x, y, z) d\sigma = \int_1^4 \int_{-2}^2 \sqrt{4 - y^2} \left(\frac{2}{\sqrt{4 - y^2}} \right) dy dx = 24$$

3. Let the parametrization be $\mathbf{r}(\phi, \theta) = (\sin \phi \cos \theta)\mathbf{i} + (\sin \phi \sin \theta)\mathbf{j} + (\cos \phi)\mathbf{k}$ (spherical coordinates with $\rho = 1$ on the sphere), $0 \leq \phi \leq \pi, 0 \leq \theta \leq 2\pi \Rightarrow \mathbf{r}_\phi = (\cos \phi \cos \theta)\mathbf{i} + (\cos \phi \sin \theta)\mathbf{j} - (\sin \phi)\mathbf{k}$ and

$$\mathbf{r}_\theta = (-\sin \phi \sin \theta)\mathbf{i} + (\sin \phi \cos \theta)\mathbf{j} \Rightarrow \mathbf{r}_\phi \times \mathbf{r}_\theta = \begin{vmatrix} \mathbf{i} & \mathbf{j} & \mathbf{k} \\ \cos \phi \cos \theta & \cos \phi \sin \theta & -\sin \phi \\ -\sin \phi \sin \theta & \sin \phi \cos \theta & 0 \end{vmatrix}$$

$$= (\sin^2 \phi \cos \theta)\mathbf{i} + (\sin^2 \phi \sin \theta)\mathbf{j} + (\sin \phi \cos \theta)\mathbf{k} \Rightarrow |\mathbf{r}_\phi \times \mathbf{r}_\theta| = \sqrt{\sin^4 \phi \cos^2 \theta + \sin^4 \phi \sin^2 \theta + \sin^2 \phi \cos^2 \phi}$$

$$= \sin \phi; x = \sin \phi \cos \theta \Rightarrow G(x, y, z) = \cos^2 \theta \sin^2 \phi \Rightarrow \iint_S G(x, y, z) d\sigma = \int_0^{2\pi} \int_0^\pi (\cos^2 \theta \sin^2 \phi)(\sin \phi) d\phi d\theta$$

$$= \int_0^{2\pi} \int_0^\pi (\cos^2 \theta)(1 - \cos^2 \phi)(\sin \phi) d\phi d\theta; \left[\begin{matrix} u = \cos \phi \\ du = -\sin \phi d\phi \end{matrix} \right] \rightarrow \int_0^{2\pi} \int_1^{-1} (\cos^2 \theta)(u^2 - 1) du d\theta$$

$$= \int_0^{2\pi} (\cos^2 \theta) \left[\frac{u^3}{3} - u \right]_1^{-1} d\theta = \frac{4}{3} \int_0^{2\pi} \cos^2 \theta d\theta = \frac{4}{3} \left[\frac{\theta}{2} + \frac{\sin 2\theta}{4} \right]_0^{2\pi} = \frac{4\pi}{3}$$

4. Let the parametrization be $\mathbf{r}(\phi, \theta) = (a \sin \phi \cos \theta)\mathbf{i} + (a \sin \phi \sin \theta)\mathbf{j} + (a \cos \phi)\mathbf{k}$ (spherical coordinates with $\rho = a, a \geq 0$, on the sphere), $0 \leq \phi \leq \frac{\pi}{2}$ (since $z \geq 0$), $0 \leq \theta \leq 2\pi$

$$\Rightarrow \mathbf{r}_\phi = (a \cos \phi \cos \theta)\mathbf{i} + (a \cos \phi \sin \theta)\mathbf{j} - (a \sin \phi)\mathbf{k} \text{ and } \mathbf{r}_\theta = (-a \sin \phi \sin \theta)\mathbf{i} + (a \sin \phi \cos \theta)\mathbf{j}$$

$$\Rightarrow \mathbf{r}_\phi \times \mathbf{r}_\theta = \begin{vmatrix} \mathbf{i} & \mathbf{j} & \mathbf{k} \\ a \cos \phi \cos \theta & a \cos \phi \sin \theta & -a \sin \phi \\ -a \sin \phi \sin \theta & a \sin \phi \cos \theta & 0 \end{vmatrix} = (a^2 \sin^2 \phi \cos \theta)\mathbf{i} + (a^2 \sin^2 \phi \sin \theta)\mathbf{j} + (a^2 \sin \phi \cos \phi)\mathbf{k}$$

$$\begin{aligned} \Rightarrow |\mathbf{r}_\phi \times \mathbf{r}_\theta| &= \sqrt{a^4 \sin^4 \phi \cos^2 \theta + a^4 \sin^4 \phi \sin^2 \theta + a^4 \sin^2 \phi \cos^2 \phi} = a^2 \sin \phi; z = a \cos \phi \\ \Rightarrow G(x, y, z) &= a^2 \cos^2 \phi \Rightarrow \iint_S G(x, y, z) d\sigma = \int_0^{2\pi} \int_0^{\pi/2} (a^2 \cos^2 \phi) (a^2 \sin \phi) d\phi d\theta = \frac{2}{3} \pi a^4 \end{aligned}$$

5. Let the parametrization be $\mathbf{r}(x, y) = x\mathbf{i} + y\mathbf{j} + (4 - x - y)\mathbf{k} \Rightarrow \mathbf{r}_x = \mathbf{i} - \mathbf{k}$ and $\mathbf{r}_y = \mathbf{j} - \mathbf{k} \Rightarrow \mathbf{r}_x \times \mathbf{r}_y = \begin{vmatrix} \mathbf{i} & \mathbf{j} & \mathbf{k} \\ 1 & 0 & -1 \\ 0 & 1 & -1 \end{vmatrix}$

$$\begin{aligned} &= \mathbf{i} + \mathbf{j} + \mathbf{k} \Rightarrow |\mathbf{r}_x \times \mathbf{r}_y| = \sqrt{3} \Rightarrow \iint_S F(x, y, z) d\sigma = \int_0^1 \int_0^1 (4 - x - y)\sqrt{3} dy dx = \int_0^1 \sqrt{3} \left[4y - xy - \frac{y^2}{2} \right]_0^1 dx \\ &= \int_0^1 \sqrt{3} \left(\frac{7}{2} - x \right) dx = \sqrt{3} \left[\frac{7}{2}x - \frac{x^2}{2} \right]_0^1 = 3\sqrt{3} \end{aligned}$$

6. Let the parametrization be $\mathbf{r}(r, \theta) = (r \cos \theta)\mathbf{i} + (r \sin \theta)\mathbf{j} + r\mathbf{k}$, $0 \leq r \leq 1$ (since $0 \leq z \leq 1$) and $0 \leq \theta \leq 2\pi$

$$\begin{aligned} \Rightarrow \mathbf{r}_r &= (\cos \theta)\mathbf{i} + (\sin \theta)\mathbf{j} + \mathbf{k} \text{ and } \mathbf{r}_\theta = (-r \sin \theta)\mathbf{i} + (r \cos \theta)\mathbf{j} \Rightarrow \mathbf{r}_r \times \mathbf{r}_\theta = \begin{vmatrix} \mathbf{i} & \mathbf{j} & \mathbf{k} \\ \cos \theta & \sin \theta & 1 \\ -r \sin \theta & r \cos \theta & 0 \end{vmatrix} \\ &= (-r \cos \theta)\mathbf{i} - (r \sin \theta)\mathbf{j} + r\mathbf{k} \Rightarrow |\mathbf{r}_r \times \mathbf{r}_\theta| = \sqrt{(-r \cos \theta)^2 + (-r \sin \theta)^2 + r^2} = r\sqrt{2}; z = r \text{ and } x = r \cos \theta \\ \Rightarrow F(x, y, z) &= r - r \cos \theta \Rightarrow \iint_S F(x, y, z) d\sigma = \int_0^{2\pi} \int_0^1 (r - r \cos \theta) (r\sqrt{2}) dr d\theta \\ &= \sqrt{2} \int_0^{2\pi} \int_0^1 (1 - \cos \theta) r^2 dr d\theta = \frac{2\pi\sqrt{2}}{3} \end{aligned}$$

7. Let the parametrization be $\mathbf{r}(r, \theta) = (r \cos \theta)\mathbf{i} + (r \sin \theta)\mathbf{j} + (1 - r^2)\mathbf{k}$, $0 \leq r \leq 1$ (since $0 \leq z \leq 1$) and $0 \leq \theta \leq 2\pi \Rightarrow \mathbf{r}_r = (\cos \theta)\mathbf{i} + (\sin \theta)\mathbf{j} - 2r\mathbf{k}$ and $\mathbf{r}_\theta = (-r \sin \theta)\mathbf{i} + (r \cos \theta)\mathbf{j}$

$$\begin{aligned} \Rightarrow \mathbf{r}_r \times \mathbf{r}_\theta &= \begin{vmatrix} \mathbf{i} & \mathbf{j} & \mathbf{k} \\ \cos \theta & \sin \theta & -2r \\ -r \sin \theta & r \cos \theta & 0 \end{vmatrix} = (2r^2 \cos \theta)\mathbf{i} + (2r^2 \sin \theta)\mathbf{j} + r\mathbf{k} \Rightarrow |\mathbf{r}_r \times \mathbf{r}_\theta| \\ &= \sqrt{(2r^2 \cos \theta)^2 + (2r^2 \sin \theta)^2 + r^2} = r\sqrt{1 + 4r^2}; z = 1 - r^2 \text{ and } x = r \cos \theta \Rightarrow H(x, y, z) = (r^2 \cos^2 \theta)\sqrt{1 + 4r^2} \\ \Rightarrow \iint_S H(x, y, z) d\sigma &= \int_0^{2\pi} \int_0^1 (r^2 \cos^2 \theta) (\sqrt{1 + 4r^2}) (r\sqrt{1 + 4r^2}) dr d\theta = \int_0^{2\pi} \int_0^1 r^3 (1 + 4r^2) \cos^2 \theta dr d\theta = \frac{11\pi}{12} \end{aligned}$$

8. Let the parametrization be $\mathbf{r}(\phi, \theta) = (2 \sin \phi \cos \theta)\mathbf{i} + (2 \sin \phi \sin \theta)\mathbf{j} + (2 \cos \phi)\mathbf{k}$ (spherical coordinates with $\rho = 2$ on the sphere), $0 \leq \phi \leq \frac{\pi}{4}$; $x^2 + y^2 + z^2 = 4$ and $z = \sqrt{x^2 + y^2} = z^2 + z^2 = 4 \Rightarrow z^2 = 2 \Rightarrow z = \sqrt{2}$ (since $z \geq 0$) $\Rightarrow 2 \cos \phi = \sqrt{2} \Rightarrow \cos \phi = \frac{\sqrt{2}}{2} \Rightarrow \phi = \frac{\pi}{4}$, $0 \leq \theta \leq 2\pi$; $\mathbf{r}_\phi = (2 \cos \phi \cos \theta)\mathbf{i} + (2 \cos \phi \sin \theta)\mathbf{j} - (2 \sin \phi)\mathbf{k}$

$$\begin{aligned} \text{and } \mathbf{r}_\theta &= (-2 \sin \phi \sin \theta)\mathbf{i} + (2 \sin \phi \cos \theta)\mathbf{j} \Rightarrow \mathbf{r}_\phi \times \mathbf{r}_\theta = \begin{vmatrix} \mathbf{i} & \mathbf{j} & \mathbf{k} \\ 2 \cos \phi \cos \theta & 2 \cos \phi \sin \theta & -2 \sin \phi \\ -2 \sin \phi \sin \theta & 2 \sin \phi \cos \theta & 0 \end{vmatrix} \\ &= (4 \sin^2 \phi \cos \theta)\mathbf{i} + (4 \sin^2 \phi \sin \theta)\mathbf{j} + (4 \sin \phi \cos \phi)\mathbf{k} \end{aligned}$$

$$\begin{aligned} \Rightarrow |\mathbf{r}_\phi \times \mathbf{r}_\theta| &= \sqrt{16 \sin^4 \phi \cos^2 \theta + 16 \sin^4 \phi \sin^2 \theta + 16 \sin^2 \phi \cos^2 \phi} = 4 \sin \phi; y = 2 \sin \phi \sin \theta \text{ and} \\ z = 2 \cos \phi &\Rightarrow H(x, y, z) = 4 \cos \phi \sin \phi \sin \theta \Rightarrow \iint_S H(x, y, z) d\sigma = \int_0^{2\pi} \int_0^{\pi/4} (4 \cos \phi \sin \phi \sin \theta)(4 \sin \phi) d\phi d\theta \\ &= \int_0^{2\pi} \int_0^{\pi/4} 16 \sin^2 \phi \cos \phi \sin \theta d\phi d\theta = 0 \end{aligned}$$

9. The bottom face S of the cube is in the xy -plane $\Rightarrow z = 0 \Rightarrow G(x, y, 0) = x + y$ and $f(x, y, z) = z = 0 \Rightarrow \mathbf{p} = \mathbf{k}$ and $\nabla f = \mathbf{k} \Rightarrow |\nabla f| = 1$ and $|\nabla f \cdot \mathbf{p}| = 1 \Rightarrow d\sigma = dx dy \Rightarrow \iint_S G d\sigma = \iint_R (x + y) dx dy = \int_0^a \int_0^a (x + y) dx dy$
 $= \int_0^a \left(\frac{a^2}{2} + ay\right) dy = a^3$. Because of symmetry, we also get a^3 over the face of the cube in the xz -plane and a^3 over the face of the cube in the yz -plane. Next, on the top of the cube, $G(x, y, z) = G(x, y, a) = x + y + a$ and $f(x, y, z) = z = a \Rightarrow \mathbf{p} = \mathbf{k}$ and $\nabla f = \mathbf{k} \Rightarrow |\nabla f| = 1$ and $|\nabla f \cdot \mathbf{p}| = 1 \Rightarrow d\sigma = dx dy$
 $\Rightarrow \iint_S G d\sigma = \iint_R (x + y + a) dx dy = \int_0^a \int_0^a (x + y + a) dx dy = \int_0^a \int_0^a (x + y) dx dy + \int_0^a \int_0^a a dx dy = 2a^3$. Because of symmetry, the integral is also $2a^3$ over each of the other two faces. Therefore,
 $\iint_{\text{cube}} (x + y + z) d\sigma = 3(a^3 + 2a^3) = 9a^3$.

10. On the face S in the xz -plane, we have $y = 0 \Rightarrow f(x, y, z) = y = 0$ and $G(x, y, z) = G(x, 0, z) = z \Rightarrow \mathbf{p} = \mathbf{j}$ and $\nabla f = \mathbf{j} \Rightarrow |\nabla f| = 1$ and $|\nabla f \cdot \mathbf{p}| = 1 \Rightarrow d\sigma = dx dz \Rightarrow \iint_S G d\sigma = \iint_S (y + z) d\sigma = \int_0^1 \int_0^2 z dx dz = \int_0^1 2z dz = 1$.
 On the face in the xy -plane, we have $z = 0 \Rightarrow f(x, y, z) = z = 0$ and $G(x, y, z) = G(x, y, 0) = y \Rightarrow \mathbf{p} = \mathbf{k}$ and $\nabla f = \mathbf{k} \Rightarrow |\nabla f| = 1$ and $|\nabla f \cdot \mathbf{p}| = 1 \Rightarrow d\sigma = dx dy \Rightarrow \iint_S G d\sigma = \iint_S y d\sigma = \int_0^1 \int_0^2 y dx dy = 1$.
 On the triangular face in the plane $x = 2$ we have $f(x, y, z) = x = 2$ and $G(x, y, z) = G(2, y, z) = y + z \Rightarrow \mathbf{p} = \mathbf{i}$ and $\nabla f = \mathbf{i} \Rightarrow |\nabla f| = 1$ and $|\nabla f \cdot \mathbf{p}| = 1 \Rightarrow d\sigma = dz dy \Rightarrow \iint_S G d\sigma = \iint_S (y + z) d\sigma$
 $= \int_0^1 \int_0^{1-y} (y + z) dz dy = \int_0^1 \frac{1}{2}(1 - y^2) dy = \frac{1}{3}$.
 On the triangular face in the yz -plane we have $x = 0 \Rightarrow f(x, y, z) = x = 0$ and $G(x, y, z) = G(0, y, z) = y + z \Rightarrow \mathbf{p} = \mathbf{i}$ and $\nabla f = \mathbf{i} \Rightarrow |\nabla f| = 1$ and $|\nabla f \cdot \mathbf{p}| = 1 \Rightarrow d\sigma = dz dy \Rightarrow \iint_S G d\sigma = \iint_S (y + z) d\sigma$
 $= \int_0^1 \int_0^{1-y} (y + z) dz dy = \frac{1}{3}$.
 Finally, on the sloped face, we have $y + z = 1 \Rightarrow f(x, y, z) = y + z = 1$ and $G(x, y, z) = y + z = 1 \Rightarrow \mathbf{p} = \mathbf{k}$ and $\nabla f = \mathbf{j} + \mathbf{k} \Rightarrow |\nabla f| = \sqrt{2}$ and $|\nabla f \cdot \mathbf{p}| = 1 \Rightarrow d\sigma = \sqrt{2} dx dy \Rightarrow \iint_S G d\sigma = \iint_S (y + z) d\sigma = \int_0^1 \int_0^2 \sqrt{2} dx dy = 2\sqrt{2}$.
 Therefore, $\iint_{\text{wedge}} G(x, y, z) d\sigma = 1 + 1 + \frac{1}{3} + \frac{1}{3} + 2\sqrt{2} = \frac{8}{3} + 2\sqrt{2}$

11. On the faces in the coordinate planes, $G(x, y, z) = 0 \Rightarrow$ the integral over these faces is 0.

On the face $x = a$, we have $f(x, y, z) = x = a$ and $G(x, y, z) = G(a, y, z) = ayz \Rightarrow \mathbf{p} = \mathbf{i}$ and

$$\nabla f = \mathbf{i} \Rightarrow |\nabla f| = 1 \text{ and } |\nabla f \cdot \mathbf{p}| = 1 \Rightarrow d\sigma = dy dz \Rightarrow \iint_S G d\sigma = \iint_S ayz d\sigma = \int_0^c \int_0^b ayz dy dz = \frac{ab^2c^2}{4}.$$

On the face $y = b$, we have $f(x, y, z) = y = b$ and $G(x, y, z) = G(x, b, z) = bxz \Rightarrow \mathbf{p} = \mathbf{j}$ and

$$\nabla f = \mathbf{j} \Rightarrow |\nabla f| = 1 \text{ and } |\nabla f \cdot \mathbf{p}| = 1 \Rightarrow d\sigma = dx dz \Rightarrow \iint_S G d\sigma = \iint_S bxz d\sigma = \int_0^c \int_0^b bxz dx dz = \frac{a^2bc^2}{4}.$$

On the face $z = c$, we have $f(x, y, z) = z = c$ and $G(x, y, z) = G(x, y, c) = cxy \Rightarrow \mathbf{p} = \mathbf{k}$ and

$$\nabla f = \mathbf{k} \Rightarrow |\nabla f| = 1 \text{ and } |\nabla f \cdot \mathbf{p}| = 1 \Rightarrow d\sigma = dy dx \Rightarrow \iint_S G d\sigma = \iint_S cxy d\sigma = \int_0^b \int_0^a cxy dx dy = \frac{a^2b^2c}{4}.$$

Therefore,
$$\iint_S G(x, y, z) d\sigma = \frac{abc(ab+ac+bc)}{4}.$$

12. On the face $x = a$, we have $f(x, y, z) = x = a$ and $G(x, y, z) = G(a, y, z) = ayz \Rightarrow \mathbf{p} = \mathbf{i}$ and

$$\nabla f = \mathbf{i} \Rightarrow |\nabla f| = 1 \text{ and } |\nabla f \cdot \mathbf{p}| = 1 \Rightarrow d\sigma = dz dy \Rightarrow \iint_S G d\sigma = \iint_S ayz d\sigma = \int_{-b}^b \int_{-c}^c ayz dz dy = 0. \text{ Because of the}$$

symmetry of G on all the other faces, all the integrals are 0, and $\iint_S G(x, y, z) d\sigma = 0.$

13. $f(x, y, z) = 2x + 2y + z = 2 \Rightarrow \nabla f = 2\mathbf{i} + 2\mathbf{j} + \mathbf{k}$ and $G(x, y, z) = x + y + (2 - 2x - 2y) = 2 - x - y \Rightarrow \mathbf{p} = \mathbf{k},$

$$|\nabla f| = 3 \text{ and } |\nabla f \cdot \mathbf{p}| = 1 \Rightarrow d\sigma = 3 dy dx; \quad z = 0 \Rightarrow 2x + 2y = 2 \Rightarrow y = 1 - x \Rightarrow \iint_S G d\sigma = \iint_S (2 - x - y) d\sigma$$

$$= 3 \int_0^1 \int_0^{1-x} (2 - x - y) dy dx = 3 \int_0^1 \left[(2-x)(1-x) - \frac{1}{2}(1-x)^2 \right] dx = 3 \int_0^1 \left(\frac{3}{2} - 2x + \frac{x^2}{2} \right) dx = 2$$

14. $f(x, y, z) = y^2 + 4z = 16 \Rightarrow \nabla f = 2y\mathbf{j} + 4\mathbf{k} \Rightarrow |\nabla f| = \sqrt{4y^2 + 16} = 2\sqrt{y^2 + 4}$ and $\mathbf{p} = \mathbf{k} \Rightarrow |\nabla f \cdot \mathbf{p}| = 4$

$$\Rightarrow d\sigma = \frac{2\sqrt{y^2+4}}{4} dx dy \Rightarrow \iint_S G d\sigma = \int_{-4}^4 \int_0^1 \left(x\sqrt{y^2+4} \right) \left(\frac{\sqrt{y^2+4}}{2} \right) dx dy = \int_{-4}^4 \int_0^1 \frac{x(y^2+4)}{2} dx dy$$

$$= \int_{-4}^4 \frac{1}{4} (y^2 + 4) dy = \frac{1}{2} \left[\frac{y^3}{3} + 4y \right]_0^4 = \frac{1}{2} \left(\frac{64}{3} + 16 \right) = \frac{56}{3}$$

15. $f(x, y, z) = x + y^2 - z = 0 \Rightarrow \nabla f = \mathbf{i} + 2y\mathbf{j} - \mathbf{k} \Rightarrow |\nabla f| = \sqrt{4y^2 + 2} = \sqrt{2}\sqrt{2y^2 + 1}$ and

$$\mathbf{p} = \mathbf{k} \Rightarrow |\nabla f \cdot \mathbf{p}| = 1 \Rightarrow d\sigma = \frac{\sqrt{2}\sqrt{2y^2+1}}{1} dx dy \Rightarrow \iint_S G d\sigma = \int_0^1 \int_0^y (x + y^2 - x) \sqrt{2}\sqrt{2y^2 + 1} dx dy$$

$$= \sqrt{2} \int_0^1 \int_0^y y^2 \sqrt{2y^2 + 1} dx dy = \sqrt{2} \int_0^1 y^3 \sqrt{2y^2 + 1} dy = \frac{6\sqrt{6} + \sqrt{2}}{30}$$

16. $f(x, y, z) = x^2 + y - z = 0 \Rightarrow \nabla f = 2x\mathbf{i} + \mathbf{j} - \mathbf{k} \Rightarrow |\nabla f| = \sqrt{4x^2 + 2} = \sqrt{2}\sqrt{2x^2 + 1}$ and $\mathbf{p} = \mathbf{k} \Rightarrow |\nabla f \cdot \mathbf{p}| = 1$

$$\Rightarrow d\sigma = \frac{\sqrt{2}\sqrt{2x^2+1}}{1} dx dy \Rightarrow \iint_S G d\sigma = \int_{-1}^1 \int_0^1 x\sqrt{2}\sqrt{2x^2 + 1} dx dy = \sqrt{2} \int_{-1}^1 \int_0^1 x\sqrt{2x^2 + 1} dx dy$$

$$= \frac{3\sqrt{6} - \sqrt{2}}{6} \int_0^1 dy = \frac{3\sqrt{6} - \sqrt{2}}{3}$$

$$\begin{aligned}
17. \quad f(x, y, z) = 2x + y + z = 2 &\Rightarrow \nabla f = 2\mathbf{i} + \mathbf{j} + \mathbf{k} \Rightarrow |\nabla f| = \sqrt{6} \text{ and } \mathbf{p} = \mathbf{k} \Rightarrow |\nabla f \cdot \mathbf{p}| = 1 \Rightarrow d\sigma = \frac{\sqrt{6}}{1} dy dx \\
&\Rightarrow \iint_S G d\sigma = \int_0^1 \int_{1-x}^{2-2x} xy(2-2x-y)\sqrt{6} dy dx = \sqrt{6} \int_0^1 \int_{1-x}^{2-2x} (2xy - 2x^2y - xy^2) dy dx \\
&= \sqrt{6} \int_0^1 \left(\frac{2}{3}x - 2x^2 + 2x^3 - \frac{2}{3}x^4 \right) dx = \frac{\sqrt{6}}{30}
\end{aligned}$$

$$\begin{aligned}
18. \quad f(x, y, z) = x + y = 1 &\Rightarrow \nabla f = \mathbf{i} + \mathbf{j} \Rightarrow |\nabla f| = \sqrt{2} \text{ and } \mathbf{p} = \mathbf{j} \Rightarrow |\nabla f \cdot \mathbf{p}| = 1 \Rightarrow d\sigma = \frac{\sqrt{2}}{1} dz dx \\
&\Rightarrow \iint_S G d\sigma = \int_0^1 \int_0^1 (x - (1-x) - z) \sqrt{2} dz dx = \sqrt{2} \int_0^1 \int_0^1 (2x - z - 1) dz dx = \sqrt{2} \int_0^1 \left(2x - \frac{3}{2} \right) dx = -\frac{\sqrt{2}}{2}
\end{aligned}$$

$$\begin{aligned}
19. \quad \text{Let the parametrization be } \mathbf{r}(x, y) = x\mathbf{i} + y\mathbf{j} + (4 - y^2)\mathbf{k}, \quad 0 \leq x \leq 1, -2 \leq y \leq 2; z = 0 \Rightarrow 0 = 4 - y^2 \\
\Rightarrow y = \pm 2; \mathbf{r}_x = \mathbf{i} \text{ and } \mathbf{r}_y = \mathbf{j} - 2y\mathbf{k} \Rightarrow \mathbf{r}_x \times \mathbf{r}_y = \begin{vmatrix} \mathbf{i} & \mathbf{j} & \mathbf{k} \\ 1 & 0 & 0 \\ 0 & 1 & -2y \end{vmatrix} = 2y\mathbf{j} + \mathbf{k} \Rightarrow \mathbf{F} \cdot \mathbf{n} d\sigma = \mathbf{F} \cdot \frac{\mathbf{r}_x \times \mathbf{r}_y}{|\mathbf{r}_x \times \mathbf{r}_y|} |\mathbf{r}_x \times \mathbf{r}_y| dy dx \\
= (2xy - 3z) dy dx = [2xy - 3(4 - y^2)] dy dx \Rightarrow \iint_S \mathbf{F} \cdot \mathbf{n} d\sigma = \int_0^1 \int_{-2}^2 (2xy + 3y^2 - 12) dy dx \\
= \int_0^1 [xy^2 + y^3 - 12y]_{-2}^2 dx = \int_0^1 (-32) dx = -32
\end{aligned}$$

$$\begin{aligned}
20. \quad \text{Let the parametrization be } \mathbf{r}(x, y) = x\mathbf{i} + x^2\mathbf{j} + z\mathbf{k}, \quad -1 \leq x \leq 1, 0 \leq z \leq 2 \Rightarrow \mathbf{r}_x = \mathbf{i} + 2x\mathbf{j} \text{ and } \mathbf{r}_z = \mathbf{k} \\
\Rightarrow \mathbf{r}_x \times \mathbf{r}_z = \begin{vmatrix} \mathbf{i} & \mathbf{j} & \mathbf{k} \\ 1 & 2x & 0 \\ 0 & 0 & 1 \end{vmatrix} = 2x\mathbf{i} - \mathbf{j} \Rightarrow \mathbf{F} \cdot \mathbf{n} d\sigma = \mathbf{F} \cdot \frac{\mathbf{r}_x \times \mathbf{r}_z}{|\mathbf{r}_x \times \mathbf{r}_z|} |\mathbf{r}_x \times \mathbf{r}_z| dz dx = -x^2 dz dx \\
\Rightarrow \iint_S \mathbf{F} \cdot \mathbf{n} d\sigma = \int_{-1}^1 \int_0^2 (-x^2) dz dx = -\frac{4}{3}
\end{aligned}$$

$$\begin{aligned}
21. \quad \text{Let the parametrization be } \mathbf{r}(\phi, \theta) = (a \sin \phi \cos \theta)\mathbf{i} + (a \sin \phi \sin \theta)\mathbf{j} + (a \cos \phi)\mathbf{k} \text{ (spherical coordinates with } \\
\rho = a, a \geq 0, \text{ on the sphere), } 0 \leq \phi \leq \frac{\pi}{2} \text{ (for the first octant), } 0 \leq \theta \leq \frac{\pi}{2} \text{ (for the first octant)} \\
\Rightarrow \mathbf{r}_\phi = (a \cos \phi \cos \theta)\mathbf{i} + (a \cos \phi \sin \theta)\mathbf{j} - (a \sin \phi)\mathbf{k} \text{ and } \mathbf{r}_\theta = (-a \sin \phi \sin \theta)\mathbf{i} + (a \sin \phi \cos \theta)\mathbf{j} \\
\Rightarrow \mathbf{r}_\phi \times \mathbf{r}_\theta = \begin{vmatrix} \mathbf{i} & \mathbf{j} & \mathbf{k} \\ a \cos \phi \cos \theta & a \cos \phi \sin \theta & -a \sin \phi \\ -a \sin \phi \sin \theta & a \sin \phi \cos \theta & 0 \end{vmatrix} = (a^2 \sin^2 \phi \cos \theta)\mathbf{i} + (a^2 \sin^2 \phi \sin \theta)\mathbf{j} + (a^2 \sin \phi \cos \phi)\mathbf{k} \\
\Rightarrow \mathbf{F} \cdot \mathbf{n} d\sigma = \mathbf{F} \cdot \frac{\mathbf{r}_\phi \times \mathbf{r}_\theta}{|\mathbf{r}_\phi \times \mathbf{r}_\theta|} |\mathbf{r}_\phi \times \mathbf{r}_\theta| d\theta d\phi = a^3 \cos^2 \phi \sin \phi d\theta d\phi \text{ since } \mathbf{F} = z\mathbf{k} = (a \cos \phi)\mathbf{k} \\
\Rightarrow \iint_S \mathbf{F} \cdot \mathbf{n} d\sigma = \int_0^{\pi/2} \int_0^{\pi/2} a^3 \cos^2 \phi \sin \phi d\phi d\theta = \frac{\pi a^3}{6}
\end{aligned}$$

$$\begin{aligned}
22. \quad \text{Let the parametrization be } \mathbf{r}(\phi, \theta) = (a \sin \phi \cos \theta)\mathbf{i} + (a \sin \phi \sin \theta)\mathbf{j} + (a \cos \phi)\mathbf{k} \text{ (spherical coordinates with } \\
\rho = a, a \geq 0, \text{ on the sphere), } 0 \leq \phi \leq \pi, 0 \leq \theta \leq 2\pi \\
\Rightarrow \mathbf{r}_\phi = (a \cos \phi \cos \theta)\mathbf{i} + (a \cos \phi \sin \theta)\mathbf{j} - (a \sin \phi)\mathbf{k} \text{ and } \mathbf{r}_\theta = (-a \sin \phi \sin \theta)\mathbf{i} + (a \sin \phi \cos \theta)\mathbf{j}
\end{aligned}$$

$$\begin{aligned} \Rightarrow \mathbf{r}_\phi \times \mathbf{r}_\theta &= \begin{vmatrix} \mathbf{i} & \mathbf{j} & \mathbf{k} \\ a \cos \phi \cos \theta & a \cos \phi \sin \theta & -a \sin \phi \\ -a \sin \phi \sin \theta & a \sin \phi \cos \theta & 0 \end{vmatrix} = (a^2 \sin^2 \phi \cos \theta) \mathbf{i} + (a^2 \sin^2 \phi \sin \theta) \mathbf{j} + (a^2 \sin \phi \cos \phi) \mathbf{k} \\ \Rightarrow \mathbf{F} \cdot \mathbf{n} \, d\sigma &= \mathbf{F} \cdot \frac{\mathbf{r}_\phi \times \mathbf{r}_\theta}{|\mathbf{r}_\phi \times \mathbf{r}_\theta|} |\mathbf{r}_\phi \times \mathbf{r}_\theta| \, d\theta \, d\phi = (a^3 \sin^3 \phi \cos^2 \theta + a^3 \sin^3 \phi \sin^2 \theta + a^3 \sin \phi \cos^2 \phi) \, d\theta \, d\phi \\ &= a^3 \sin \phi \, d\theta \, d\phi \text{ since } \mathbf{F} = x\mathbf{i} + y\mathbf{j} + z\mathbf{k} = (a \sin \phi \cos \theta)\mathbf{i} + (a \sin \phi \sin \theta)\mathbf{j} + (a \cos \phi)\mathbf{k} \\ \Rightarrow \iint_S \mathbf{F} \cdot \mathbf{n} \, d\sigma &= \int_0^{2\pi} \int_0^\pi a^3 \sin \phi \, d\phi \, d\theta = 4\pi a^3 \end{aligned}$$

23. Let the parametrization be $\mathbf{r}(x, y) = x\mathbf{i} + y\mathbf{j} + (2a - x - y)\mathbf{k}$, $0 \leq x \leq a$, $0 \leq y \leq a \Rightarrow \mathbf{r}_x = \mathbf{i} - \mathbf{k}$ and $\mathbf{r}_y = \mathbf{j} - \mathbf{k}$

$$\begin{aligned} \Rightarrow \mathbf{r}_x \times \mathbf{r}_y &= \begin{vmatrix} \mathbf{i} & \mathbf{j} & \mathbf{k} \\ 1 & 0 & -1 \\ 0 & 1 & -1 \end{vmatrix} = \mathbf{i} + \mathbf{j} + \mathbf{k} \Rightarrow \mathbf{F} \cdot \mathbf{n} \, d\sigma = \mathbf{F} \cdot \frac{\mathbf{r}_x \times \mathbf{r}_y}{|\mathbf{r}_x \times \mathbf{r}_y|} |\mathbf{r}_x \times \mathbf{r}_y| \, dy \, dx \\ &= [2xy + 2y(2a - x - y) + 2x(2a - x - y)] \, dy \, dx \text{ since } \mathbf{F} = 2xy\mathbf{i} + 2yz\mathbf{j} + 2xz\mathbf{k} \\ &= 2xy\mathbf{i} + 2y(2a - x - y)\mathbf{j} + 2x(2a - x - y)\mathbf{k} \Rightarrow \iint_S \mathbf{F} \cdot \mathbf{n} \, d\sigma \\ &= \int_0^a \int_0^a [2xy + 2y(2a - x - y) + 2x(2a - x - y)] \, dy \, dx = \int_0^a \int_0^a (4ay - 2y^2 + 4ax - 2x^2 - 2xy) \, dy \, dx \\ &= \int_0^a \left(\frac{4}{3}a^3 + 3a^2x - 2ax^2 \right) \, dx = \left(\frac{4}{3} + \frac{3}{2} - \frac{2}{3} \right) a^4 = \frac{13a^4}{6} \end{aligned}$$

24. Let the parametrization be $\mathbf{r}(\theta, z) = (\cos \theta)\mathbf{i} + (\sin \theta)\mathbf{j} + z\mathbf{k}$, $0 \leq z \leq a$, $0 \leq \theta \leq 2\pi$ (where $r = \sqrt{x^2 + y^2} = 1$ on the cylinder) $\Rightarrow \mathbf{r}_\theta = (-\sin \theta)\mathbf{i} + (\cos \theta)\mathbf{j}$ and $\mathbf{r}_z = \mathbf{k} \Rightarrow \mathbf{r}_\theta \times \mathbf{r}_z =$

$$\begin{aligned} \mathbf{r}_\theta \times \mathbf{r}_z &= \begin{vmatrix} \mathbf{i} & \mathbf{j} & \mathbf{k} \\ -\sin \theta & \cos \theta & 0 \\ 0 & 0 & 1 \end{vmatrix} = (\cos \theta)\mathbf{i} + (\sin \theta)\mathbf{j} \\ \Rightarrow \mathbf{F} \cdot \mathbf{n} \, d\sigma &= \mathbf{F} \cdot \frac{\mathbf{r}_\theta \times \mathbf{r}_z}{|\mathbf{r}_\theta \times \mathbf{r}_z|} |\mathbf{r}_\theta \times \mathbf{r}_z| \, dz \, d\theta = (\cos^2 \theta + \sin^2 \theta) \, dz \, d\theta = dz \, d\theta, \text{ since } \mathbf{F} = (\cos \theta)\mathbf{i} + (\sin \theta)\mathbf{j} + z\mathbf{k} \\ \Rightarrow \iint_S \mathbf{F} \cdot \mathbf{n} \, d\sigma &= \int_0^{2\pi} \int_0^a 1 \, dz \, d\theta = 2\pi a \end{aligned}$$

25. Let the parametrization be $\mathbf{r}(r, \theta) = (r \cos \theta)\mathbf{i} + (r \sin \theta)\mathbf{j} + r\mathbf{k}$, $0 \leq r \leq 1$ (since $0 \leq z \leq 1$) and $0 \leq \theta \leq 2\pi$

$$\begin{aligned} \Rightarrow \mathbf{r}_r &= (\cos \theta)\mathbf{i} + (\sin \theta)\mathbf{j} + \mathbf{k} \text{ and } \mathbf{r}_\theta = (-r \sin \theta)\mathbf{i} + (r \cos \theta)\mathbf{j} \Rightarrow \mathbf{r}_\theta \times \mathbf{r}_r = \begin{vmatrix} \mathbf{i} & \mathbf{j} & \mathbf{k} \\ -r \sin \theta & r \cos \theta & 0 \\ \cos \theta & \sin \theta & 1 \end{vmatrix} \\ &= (r \cos \theta)\mathbf{i} + (r \sin \theta)\mathbf{j} - r\mathbf{k} \Rightarrow \mathbf{F} \cdot \mathbf{n} \, d\sigma = \mathbf{F} \cdot \frac{\mathbf{r}_\theta \times \mathbf{r}_r}{|\mathbf{r}_\theta \times \mathbf{r}_r|} |\mathbf{r}_\theta \times \mathbf{r}_r| \, d\theta \, dr = (r^3 \sin \theta \cos^2 \theta + r^2) \, d\theta \, dr \text{ since} \\ \mathbf{F} &= (r^2 \sin \theta \cos \theta)\mathbf{i} - r\mathbf{k} \Rightarrow \iint_S \mathbf{F} \cdot \mathbf{n} \, d\sigma = \int_0^{2\pi} \int_0^1 (r^3 \sin \theta \cos^2 \theta + r^2) \, dr \, d\theta = \int_0^{2\pi} \left(\frac{1}{4} \sin \theta \cos^2 \theta + \frac{1}{3} \right) \, d\theta \\ &= \left[-\frac{1}{12} \cos^3 \theta + \frac{\theta}{3} \right]_0^{2\pi} = \frac{2\pi}{3} \end{aligned}$$

26. Let the parametrization be $\mathbf{r}(r, \theta) = (r \cos \theta)\mathbf{i} + (r \sin \theta)\mathbf{j} + 2r\mathbf{k}$, $0 \leq r \leq 1$ (since $0 \leq z \leq 2$) and $0 \leq \theta \leq 2\pi$

$$\begin{aligned} \Rightarrow \mathbf{r}_r &= (\cos \theta)\mathbf{i} + (\sin \theta)\mathbf{j} + 2\mathbf{k} \text{ and } \mathbf{r}_\theta = (-r \sin \theta)\mathbf{i} + (r \cos \theta)\mathbf{j} \Rightarrow \mathbf{r}_\theta \times \mathbf{r}_r = \begin{vmatrix} \mathbf{i} & \mathbf{j} & \mathbf{k} \\ -r \sin \theta & r \cos \theta & 0 \\ \cos \theta & \sin \theta & 2 \end{vmatrix} \\ &= (2r \cos \theta)\mathbf{i} + (2r \sin \theta)\mathbf{j} - r\mathbf{k} \Rightarrow \mathbf{F} \cdot \mathbf{n} \, d\sigma = \mathbf{F} \cdot \frac{\mathbf{r}_\theta \times \mathbf{r}_r}{|\mathbf{r}_\theta \times \mathbf{r}_r|} |\mathbf{r}_\theta \times \mathbf{r}_r| \, d\theta \, dr \\ &= (2r^3 \sin^2 \theta \cos \theta + 4r^3 \cos \theta \sin \theta + r) \, d\theta \, dr \text{ since } \mathbf{F} = (r^2 \sin^2 \theta)\mathbf{i} + (2r^2 \cos \theta)\mathbf{j} - \mathbf{k} \\ \Rightarrow \iint_S \mathbf{F} \cdot \mathbf{n} \, d\sigma &= \int_0^{2\pi} \int_0^1 (2r^3 \sin^2 \theta \cos \theta + 4r^3 \cos \theta \sin \theta + r) \, dr \, d\theta = \int_0^{2\pi} \left(\frac{1}{2} \sin^2 \theta \cos \theta + \cos \theta \sin \theta + \frac{1}{2} \right) d\theta \\ &= \left[\frac{1}{6} \sin^3 \theta + \frac{1}{2} \sin^2 \theta + \frac{1}{2} \theta \right]_0^{2\pi} = \pi \end{aligned}$$

27. Let the parametrization be $\mathbf{r}(r, \theta) = (r \cos \theta)\mathbf{i} + (r \sin \theta)\mathbf{j} + r\mathbf{k}$, $1 \leq r \leq 2$ (since $1 \leq z \leq 2$) and $0 \leq \theta \leq 2\pi$

$$\begin{aligned} \Rightarrow \mathbf{r}_r &= (\cos \theta)\mathbf{i} + (\sin \theta)\mathbf{j} + \mathbf{k} \text{ and } \mathbf{r}_\theta = (-r \sin \theta)\mathbf{i} + (r \cos \theta)\mathbf{j} \Rightarrow \mathbf{r}_\theta \times \mathbf{r}_r = \begin{vmatrix} \mathbf{i} & \mathbf{j} & \mathbf{k} \\ -r \sin \theta & r \cos \theta & 0 \\ \cos \theta & \sin \theta & 1 \end{vmatrix} \\ &= (r \cos \theta)\mathbf{i} + (r \sin \theta)\mathbf{j} - r\mathbf{k} \Rightarrow \mathbf{F} \cdot \mathbf{n} \, d\sigma = \mathbf{F} \cdot \frac{\mathbf{r}_\theta \times \mathbf{r}_r}{|\mathbf{r}_\theta \times \mathbf{r}_r|} |\mathbf{r}_\theta \times \mathbf{r}_r| \, d\theta \, dr = (-r^2 \cos^2 \theta - r^2 \sin^2 \theta - r^3) \, d\theta \, dr \\ &= (-r^2 - r^3) \, d\theta \, dr \text{ since } \mathbf{F} = (-r \cos \theta)\mathbf{i} - (r \sin \theta)\mathbf{j} + r^2\mathbf{k} \Rightarrow \iint_S \mathbf{F} \cdot \mathbf{n} \, d\sigma = \int_0^{2\pi} \int_1^2 (-r^2 - r^3) \, dr \, d\theta = -\frac{73\pi}{6} \end{aligned}$$

28. Let the parametrization be $\mathbf{r}(r, \theta) = (r \cos \theta)\mathbf{i} + (r \sin \theta)\mathbf{j} + r^2\mathbf{k}$, $0 \leq r \leq 1$ (since $0 \leq z \leq 1$) and $0 \leq \theta \leq 2\pi$

$$\begin{aligned} \Rightarrow \mathbf{r}_r &= (\cos \theta)\mathbf{i} + (\sin \theta)\mathbf{j} + 2r\mathbf{k} \text{ and } \mathbf{r}_\theta = (-r \sin \theta)\mathbf{i} + (r \cos \theta)\mathbf{j} \Rightarrow \mathbf{r}_\theta \times \mathbf{r}_r = \begin{vmatrix} \mathbf{i} & \mathbf{j} & \mathbf{k} \\ -r \sin \theta & r \cos \theta & 0 \\ \cos \theta & \sin \theta & 2r \end{vmatrix} \\ &= (2r^2 \cos \theta)\mathbf{i} + (2r^2 \sin \theta)\mathbf{j} - r\mathbf{k} \Rightarrow \mathbf{F} \cdot \mathbf{n} \, d\sigma = \mathbf{F} \cdot \frac{\mathbf{r}_\theta \times \mathbf{r}_r}{|\mathbf{r}_\theta \times \mathbf{r}_r|} |\mathbf{r}_\theta \times \mathbf{r}_r| \, d\theta \, dr = (8r^3 \cos^2 \theta + 8r^3 \sin^2 \theta - 2r) \, d\theta \, dr \\ &= (8r^3 - 2r) \, d\theta \, dr \text{ since } \mathbf{F} = (4r \cos \theta)\mathbf{i} + (4r \sin \theta)\mathbf{j} + 2\mathbf{k} \Rightarrow \iint_S \mathbf{F} \cdot \mathbf{n} \, d\sigma = \int_0^{2\pi} \int_0^1 (8r - 2r) \, dr \, d\theta = 2\pi \end{aligned}$$

29. $g(x, y, z) = z$, $\mathbf{p} = \mathbf{k} \Rightarrow \nabla g = \mathbf{k} \Rightarrow |\nabla g| = 1$ and $|\nabla g \cdot \mathbf{p}| = 1 \Rightarrow \text{Flux} = \iint_S \mathbf{F} \cdot \mathbf{n} \, d\sigma = \iint_R (\mathbf{F} \cdot \mathbf{k}) \, dA$

$$= \int_0^2 \int_0^3 3 \, dy \, dx = 18$$

30. $g(x, y, z) = y$, $\mathbf{p} = -\mathbf{j} \Rightarrow \nabla g = \mathbf{j} \Rightarrow |\nabla g| = 1$ and $|\nabla g \cdot \mathbf{p}| = 1 \Rightarrow \text{Flux} = \iint_S \mathbf{F} \cdot \mathbf{n} \, d\sigma = \iint_R (\mathbf{F} \cdot -\mathbf{j}) \, dA$

$$= \int_{-1}^2 \int_2^7 2 \, dz \, dx = \int_{-1}^2 2(7-2) \, dx = 10(2+1) = 30$$

$$31. \nabla g = 2x\mathbf{i} + 2y\mathbf{j} + 2z\mathbf{k} \Rightarrow |\nabla g| = \sqrt{4x^2 + 4y^2 + 4z^2} = 2a; \mathbf{n} = \frac{2x\mathbf{i} + 2y\mathbf{j} + 2z\mathbf{k}}{2\sqrt{x^2 + y^2 + z^2}} = \frac{x\mathbf{i} + y\mathbf{j} + z\mathbf{k}}{a} \Rightarrow \mathbf{F} \cdot \mathbf{n} = \frac{z^2}{a};$$

$$|\nabla g \cdot \mathbf{k}| = 2z \Rightarrow d\sigma = \frac{2a}{2z} dA \Rightarrow \text{Flux} = \iint_S \left(\frac{z^2}{a}\right) \left(\frac{a}{z}\right) dA = \iint_S z dA = \iint_S \sqrt{a^2 - (x^2 + y^2)} dx dy$$

$$= \int_0^{\pi/2} \int_0^a \sqrt{a^2 - r^2} r dr d\theta = \frac{\pi a^3}{6}$$

$$32. \nabla g = 2x\mathbf{i} + 2y\mathbf{j} + 2z\mathbf{k} \Rightarrow |\nabla g| = \sqrt{4x^2 + 4y^2 + 4z^2} = 2a; \mathbf{n} = \frac{2x\mathbf{i} + 2y\mathbf{j} + 2z\mathbf{k}}{2\sqrt{x^2 + y^2 + z^2}} = \frac{x\mathbf{i} + y\mathbf{j} + z\mathbf{k}}{a} \Rightarrow \mathbf{F} \cdot \mathbf{n} = \frac{-xy}{a} + \frac{xy}{a} = 0;$$

$$|\nabla g \cdot \mathbf{k}| = 2z \Rightarrow d\sigma = \frac{2a}{2z} dA \Rightarrow \text{Flux} = \iint_S \mathbf{F} \cdot \mathbf{n} d\sigma = \iint_S 0 d\sigma = 0$$

$$33. \text{From Exercise 31, } \mathbf{n} = \frac{x\mathbf{i} + y\mathbf{j} + z\mathbf{k}}{a} \text{ and } d\sigma = \frac{a}{z} dA \Rightarrow \mathbf{F} \cdot \mathbf{n} = \frac{xy}{a} - \frac{xy}{a} + \frac{z}{a} = \frac{z}{a} \Rightarrow \text{Flux} = \iint_R \left(\frac{z}{a}\right) \left(\frac{a}{z}\right) dA = \iint_R 1 dA = \frac{\pi a^2}{4}$$

$$34. \text{From Exercise 31, } \mathbf{n} = \frac{x\mathbf{i} + y\mathbf{j} + z\mathbf{k}}{a} \text{ and } d\sigma = \frac{a}{z} dA \Rightarrow \mathbf{F} \cdot \mathbf{n} = \frac{zx^2}{a} + \frac{zy^2}{a} + \frac{z^3}{a} = z \left(\frac{x^2 + y^2 + z^2}{a}\right) = az$$

$$\Rightarrow \text{Flux} = \iint_R (za) \left(\frac{a}{z}\right) = \iint_R a^2 dx dy = a^2 (\text{Area of } R) = \frac{1}{4} \pi a^4 dx dy$$

$$35. \text{From Exercise 31, } \mathbf{n} = \frac{x\mathbf{i} + y\mathbf{j} + z\mathbf{k}}{a} \text{ and } d\sigma = \frac{a}{z} dA \Rightarrow \mathbf{F} \cdot \mathbf{n} = \frac{x^2}{a} + \frac{y^2}{a} + \frac{z^2}{a} = a \Rightarrow \text{Flux} = \iint_R a \left(\frac{a}{z}\right) dA = \iint_R \frac{a^2}{z} dA$$

$$= \iint_R \frac{a^2}{\sqrt{a^2 - (x^2 + y^2)}} dA = \int_0^{\pi/2} \int_0^a \frac{a^2}{\sqrt{a^2 - r^2}} r dr d\theta = \int_0^{\pi/2} a^2 \left[-\sqrt{a^2 - r^2}\right]_0^a d\theta = \frac{\pi a^3}{2}$$

$$36. \text{From Exercise 31, } \mathbf{n} = \frac{x\mathbf{i} + y\mathbf{j} + z\mathbf{k}}{a} \text{ and } d\sigma = \frac{a}{z} dA \Rightarrow \mathbf{F} \cdot \mathbf{n} = \frac{\left(\frac{x^2}{a}\right) + \left(\frac{y^2}{a}\right) + \left(\frac{z^3}{a}\right)}{\sqrt{x^2 + y^2 + z^2}} = \frac{\left(\frac{a^2}{a}\right)}{a} = 1$$

$$\Rightarrow \text{Flux} = \iint_R \frac{a}{z} dx dy = \iint_R \frac{a}{\sqrt{a^2 - (x^2 + y^2)}} dx dy = \int_0^{\pi/2} \int_0^a \frac{a}{\sqrt{a^2 - r^2}} r dr d\theta = \frac{\pi a^2}{2}$$

$$37. g(x, y, z) = y^2 + z = 4 \Rightarrow \nabla g = 2y\mathbf{j} + \mathbf{k} \Rightarrow |\nabla g| = \sqrt{4y^2 + 1} \Rightarrow \mathbf{n} = \frac{2y\mathbf{j} + \mathbf{k}}{\sqrt{4y^2 + 1}} \Rightarrow \mathbf{F} \cdot \mathbf{n} = \frac{2xy - 3z}{\sqrt{4y^2 + 1}};$$

$$\mathbf{p} = \mathbf{k} \Rightarrow |\nabla g \cdot \mathbf{p}| = 1 \Rightarrow d\sigma = \sqrt{4y^2 + 1} dA \Rightarrow \text{Flux} = \iint_R \left(\frac{2xy - 3z}{\sqrt{4y^2 + 1}}\right) \sqrt{4y^2 + 1} dA = \iint_R (2xy - 3z) dA;$$

$$z = 0 \text{ and } z = 4 - y^2 \Rightarrow y^2 = 4 \Rightarrow \text{Flux} = \iint_R [2xy - 3(4 - y^2)] dA = \int_0^1 \int_{-2}^2 (2xy - 12 + 3y^2) dy dx$$

$$= \int_0^1 [xy^2 - 12y + y^3]_{-2}^2 dx = \int_0^1 (-32) dx = -32$$

$$38. g(x, y, z) = x^2 + y^2 - z = 0 \Rightarrow \nabla g = 2x\mathbf{i} + 2y\mathbf{j} - \mathbf{k} \Rightarrow |\nabla g| = \sqrt{4x^2 + 4y^2 + 1} = \sqrt{4(x^2 + y^2) + 1}$$

$$\Rightarrow \mathbf{n} = \frac{2x\mathbf{i} + 2y\mathbf{j} - \mathbf{k}}{\sqrt{4(x^2 + y^2) + 1}} \Rightarrow \mathbf{F} \cdot \mathbf{n} = \frac{8x^2 + 8y^2 - 2}{\sqrt{4(x^2 + y^2) + 1}}; \mathbf{p} = \mathbf{k} \Rightarrow |\nabla g \cdot \mathbf{p}| = 1 \Rightarrow d\sigma = \sqrt{4(x^2 + y^2) + 1} dA$$

$$\Rightarrow \text{Flux} = \iint_R \left(\frac{8x^2 + 8y^2 - 2}{\sqrt{4(x^2 + y^2) + 1}} \right) \sqrt{4(x^2 + y^2) + 1} dA = \iint_R (8x^2 + 8y^2 - 2) dA; z = 1 \text{ and } x^2 + y^2 = z$$

$$\Rightarrow x^2 + y^2 = 1 \Rightarrow \text{Flux} = \int_0^{2\pi} \int_0^1 (8r^2 - 2) r dr d\theta = 2\pi$$

$$39. g(x, y, z) = y - e^x = 0 \Rightarrow \nabla g = -e^x \mathbf{i} + \mathbf{j} \Rightarrow |\nabla g| = \sqrt{e^{2x} + 1} \Rightarrow \mathbf{n} = \frac{e^x \mathbf{i} - \mathbf{j}}{\sqrt{e^{2x} + 1}} \Rightarrow \mathbf{F} \cdot \mathbf{n} = \frac{-2e^x - 2y}{\sqrt{e^{2x} + 1}};$$

$$\mathbf{p} = \mathbf{i} \Rightarrow |\nabla g \cdot \mathbf{p}| = e^x \Rightarrow d\sigma = \frac{\sqrt{e^{2x} + 1}}{e^x} dA \Rightarrow \text{Flux} = \iint_R \left(\frac{-2e^x - 2y}{\sqrt{e^{2x} + 1}} \right) \left(\frac{\sqrt{e^{2x} + 1}}{e^x} \right) dA = \iint_R \frac{-2e^x - 2e^x}{e^x} dA$$

$$= \iint_R (-4) dA = \int_0^1 \int_1^2 (-4) dy dz = -4$$

$$40. g(x, y, z) = y - \ln x = 0 \Rightarrow \nabla g = -\frac{1}{x} \mathbf{i} + \mathbf{j} \Rightarrow |\nabla g| = \sqrt{\frac{1}{x^2} + 1} = \frac{\sqrt{1+x^2}}{x} \text{ since } 1 \leq x \leq e \Rightarrow \mathbf{n} = \frac{\left(-\frac{1}{x} \mathbf{i} + \mathbf{j}\right)}{\left(\frac{\sqrt{1+x^2}}{x}\right)} = \frac{-\mathbf{i} + x\mathbf{j}}{\sqrt{1+x^2}}$$

$$\Rightarrow \mathbf{F} \cdot \mathbf{n} = \frac{2xy}{\sqrt{1+x^2}}; \mathbf{p} = \mathbf{j} \Rightarrow |\nabla g \cdot \mathbf{p}| = 1 \Rightarrow d\sigma = \frac{\sqrt{1+x^2}}{x} dA \Rightarrow \text{Flux} = \iint_R \left(\frac{2xy}{\sqrt{1+x^2}} \right) \left(\frac{\sqrt{1+x^2}}{x} \right) dA$$

$$= \int_0^1 \int_1^e 2y dx dz = \int_1^e \int_0^1 2 \ln x dz dx = \int_1^e 2 \ln x dx = 2 [x \ln x - x]_1^e = 2(e - e) - 2(0 - 1) = 2$$

$$41. \text{ On the face } z = a: g(x, y, z) = z \Rightarrow \nabla g = \mathbf{k} \Rightarrow |\nabla g| = 1; \mathbf{n} = \mathbf{k} \Rightarrow \mathbf{F} \cdot \mathbf{n} = 2xz = 2ax \text{ since } z = a; d\sigma = dx dy$$

$$\Rightarrow \text{Flux} = \iint_R 2ax dx dy = \int_0^a \int_0^a 2ax dx dy = a^4.$$

$$\text{On the face } z = 0: g(x, y, z) = z \Rightarrow \nabla g = \mathbf{k} \Rightarrow |\nabla g| = 1; \mathbf{n} = -\mathbf{k} \Rightarrow \mathbf{F} \cdot \mathbf{n} = -2xz = 0 \text{ since } z = 0;$$

$$d\sigma = dx dy \Rightarrow \text{Flux} = \iint_R 0 dx dy = 0.$$

$$\text{On the face } x = a: g(x, y, z) = x \Rightarrow \nabla g = \mathbf{i} \Rightarrow |\nabla g| = 1; \mathbf{n} = \mathbf{i} \Rightarrow \mathbf{F} \cdot \mathbf{n} = 2xy = 2ay \text{ since } x = a;$$

$$d\sigma = dy dz \Rightarrow \text{Flux} = \int_0^a \int_0^a 2ay dy dz = a^4.$$

$$\text{On the face } x = 0: g(x, y, z) = x \Rightarrow \nabla g = \mathbf{i} \Rightarrow |\nabla g| = 1; \mathbf{n} = -\mathbf{i} \Rightarrow \mathbf{F} \cdot \mathbf{n} = -2xy = 0 \text{ since } x = 0 \Rightarrow \text{Flux} = 0.$$

$$\text{On the face } y = a: g(x, y, z) = y \Rightarrow \nabla g = \mathbf{j} \Rightarrow |\nabla g| = 1; \mathbf{n} = \mathbf{j} \Rightarrow \mathbf{F} \cdot \mathbf{n} = 2yz = 2az \text{ since } y = a;$$

$$d\sigma = dz dx \Rightarrow \text{Flux} = \int_0^a \int_0^a 2az dz dx = a^4.$$

$$\text{On the face } y = 0: g(x, y, z) = y \Rightarrow \nabla g = \mathbf{j} \Rightarrow |\nabla g| = 1; \mathbf{n} = -\mathbf{j} \Rightarrow \mathbf{F} \cdot \mathbf{n} = -2yz = 0 \text{ since } y = 0 \Rightarrow \text{Flux} = 0.$$

$$\text{Therefore, Total Flux} = 3a^4.$$

$$42. \text{ Across the cap: } g(x, y, z) = x^2 + y^2 + z^2 = 25 \Rightarrow \nabla g = 2x\mathbf{i} + 2y\mathbf{j} + 2z\mathbf{k} \Rightarrow |\nabla g| = \sqrt{4x^2 + 4y^2 + 4z^2} = 10$$

$$\Rightarrow \mathbf{n} = \frac{\nabla g}{|\nabla g|} = \frac{x\mathbf{i} + y\mathbf{j} + z\mathbf{k}}{5} \Rightarrow \mathbf{F} \cdot \mathbf{n} = \frac{x^2 z}{5} + \frac{y^2 z}{5} + \frac{z}{5}; \mathbf{p} = \mathbf{k} \Rightarrow |\nabla g \cdot \mathbf{p}| = 2z \text{ since } z \geq 0 \Rightarrow d\sigma = \frac{10}{2z} dA$$

$$\Rightarrow \text{Flux}_{\text{cap}} = \iint_{\text{cap}} \mathbf{F} \cdot \mathbf{n} d\sigma = \iint_R \left(\frac{x^2 z}{5} + \frac{y^2 z}{5} + \frac{z}{5} \right) \left(\frac{5}{z} \right) dA = \iint_R (x^2 + y^2 + 1) dx dy = \int_0^{2\pi} \int_0^4 (r^2 + 1) r dr d\theta$$

$$= \int_0^{2\pi} 72 d\theta = 144\pi.$$

Across the bottom: $g(x, y, z) = z = 3 \Rightarrow \nabla g = \mathbf{k} \Rightarrow |\nabla g| = 1 \Rightarrow \mathbf{n} = -\mathbf{k} \Rightarrow \mathbf{F} \cdot \mathbf{n} = -1; \mathbf{p} = \mathbf{k} \Rightarrow |\nabla g \cdot \mathbf{p}| = 1$
 $\Rightarrow d\sigma = dA \Rightarrow \text{Flux}_{\text{bottom}} = \iint_{\text{bottom}} \mathbf{F} \cdot \mathbf{n} d\sigma = \iint_R -1 dA = -1(\text{Area of the circular region}) = -16\pi$. Therefore,
 $\text{Flux} = \text{Flux}_{\text{cap}} + \text{Flux}_{\text{bottom}} = 128\pi$

43. $\nabla f = 2x\mathbf{i} + 2y\mathbf{j} + 2z\mathbf{k} \Rightarrow |\nabla f| = \sqrt{4x^2 + 4y^2 + 4z^2} = 2a; \mathbf{p} = \mathbf{k} \Rightarrow |\nabla f \cdot \mathbf{p}| = 2z$ since $z \geq 0 \Rightarrow d\sigma = \frac{2a}{2z} dA$
 $= \frac{a}{z} dA; M = \iint_S \delta d\sigma = \frac{\delta}{8}$ (surface area of sphere) $= \frac{\delta\pi a^2}{2}; M_{xy} = \iint_S z\delta_z d\sigma = \delta \iint_R z\left(\frac{a}{z}\right) dA = a\delta \iint_R dA$
 $= a\delta \int_0^{\pi/2} \int_0^a r dr d\theta = \frac{\delta\pi a^3}{4} \Rightarrow \bar{z} = \frac{M_{xy}}{M} = \left(\frac{\delta\pi a^3}{4}\right)\left(\frac{2}{\delta\pi a^2}\right) = \frac{a}{2}$. Because of symmetry, $\bar{x} = \bar{y} = \frac{a}{2}$
 \Rightarrow the centroid is $\left(\frac{a}{2}, \frac{a}{2}, \frac{a}{2}\right)$.

44. $\nabla f = 2y\mathbf{j} + 2z\mathbf{k} \Rightarrow |\nabla f| = \sqrt{4y^2 + 4z^2} = \sqrt{4(y^2 + z^2)} = 6; \mathbf{p} = \mathbf{k} \Rightarrow |\nabla f \cdot \mathbf{k}| = 2z$ since $z \geq 0 \Rightarrow d\sigma = \frac{6}{2z} dA$
 $= \frac{3}{z} dA; M = \iint_S 1 d\sigma = \int_{-3}^3 \int_0^3 \frac{3}{z} dx dy = \int_{-3}^3 \int_0^3 \frac{3}{\sqrt{9-y^2}} dx dy = 9\pi; M_{xy} = \iint_S z d\sigma = \int_{-3}^3 \int_0^3 z\left(\frac{3}{z}\right) dx dy = 54;$
 $M_{xz} = \iint_S y d\sigma = \int_{-3}^3 \int_0^3 y\left(\frac{3}{z}\right) dx dy = \int_{-3}^3 \int_0^3 \frac{3y}{\sqrt{9-y^2}} dx dy = 0; M_{yz} = \iint_S x d\sigma = \int_{-3}^3 \int_0^3 \frac{3x}{\sqrt{9-y^2}} dx dy = \frac{27}{2}\pi$.
 Therefore, $\bar{x} = \frac{(\frac{27}{2}\pi)}{9\pi} = \frac{3}{2}, \bar{y} = 0$, and $\bar{z} = \frac{54}{9\pi} = \frac{6}{\pi}$

45. Because of symmetry, $\bar{x} = \bar{y} = 0; M = \iint_S \delta d\sigma = \delta \iint_S d\sigma = (\text{Area of } S)\delta = 3\pi\sqrt{2}\delta; \nabla f = 2x\mathbf{i} + 2y\mathbf{j} - 2z\mathbf{k}$
 $\Rightarrow |\nabla f| = \sqrt{4x^2 + 4y^2 + 4z^2} = 2\sqrt{x^2 + y^2 + z^2}; \mathbf{p} = \mathbf{k} \Rightarrow |\nabla f \cdot \mathbf{p}| = 2z \Rightarrow d\sigma = \frac{2\sqrt{x^2 + y^2 + z^2}}{2z} dA$
 $= \frac{\sqrt{x^2 + y^2 + (x^2 + y^2)}}{z} dA = \frac{\sqrt{2}\sqrt{x^2 + y^2}}{z} dA \Rightarrow M_{xy} = \delta \iint_R z\left(\frac{\sqrt{2}\sqrt{x^2 + y^2}}{z}\right) dA = \delta \iint_R \sqrt{2}\sqrt{x^2 + y^2} dA$
 $= \delta \int_0^{2\pi} \int_1^2 \sqrt{2}r^2 dr d\theta = \frac{14\pi\sqrt{2}\delta}{3} \Rightarrow \bar{z} = \frac{(\frac{14\pi\sqrt{2}\delta}{3})}{3\pi\sqrt{2}\delta} = \frac{14}{9} \Rightarrow (\bar{x}, \bar{y}, \bar{z}) = \left(0, 0, \frac{14}{9}\right)$. Next, $I_z = \iint_S (x^2 + y^2)\delta d\sigma$
 $= \iint_R (x^2 + y^2)\left(\frac{\sqrt{2}\sqrt{x^2 + y^2}}{z}\right)\delta dA = \delta\sqrt{2} \iint_R (x^2 + y^2) dA = \delta\sqrt{2} \int_0^{2\pi} \int_1^2 r^3 dr d\theta = \frac{15\pi\sqrt{2}}{2}\delta \Rightarrow R_z = \sqrt{\frac{I_z}{M}} = \frac{\sqrt{10}}{2}$

46. $f(x, y, z) = 4x^2 + 4y^2 - z^2 = 0 \Rightarrow \nabla f = 8x\mathbf{i} + 8y\mathbf{j} - 2z\mathbf{k} \Rightarrow |\nabla f| = \sqrt{64x^2 + 64y^2 + 4z^2}$
 $= 2\sqrt{16x^2 + 16y^2 + z^2} = 2\sqrt{4z^2 + z^2} = 2\sqrt{5} z$ since $z \geq 0; \mathbf{p} = \mathbf{k} \Rightarrow |\nabla f \cdot \mathbf{p}| = 2z \Rightarrow d\sigma = \frac{2\sqrt{5}z}{2z} dA = \sqrt{5} dA$
 $\Rightarrow I_z = \iint_S (x^2 + y^2)\delta d\sigma = \delta\sqrt{5} \iint_R (x^2 + y^2) dx dy = \delta\sqrt{5} \int_{-\pi/2}^{\pi/2} \int_0^{2\cos\theta} r^3 dr d\theta = \frac{3\sqrt{5}\pi\delta}{2}$

47. (a) Let the diameter lie on the z -axis and let $f(x, y, z) = x^2 + y^2 + z^2 = a^2, z \geq 0$ be the upper hemisphere
 $\Rightarrow \nabla f = 2x\mathbf{i} + 2y\mathbf{j} + 2z\mathbf{k} \Rightarrow |\nabla f| = \sqrt{4x^2 + 4y^2 + 4z^2} = 2a, a > 0; \mathbf{p} = \mathbf{k} \Rightarrow |\nabla f \cdot \mathbf{p}| = 2z$ since $z \geq 0$
 $\Rightarrow d\sigma = \frac{a}{z} dA \Rightarrow I_z = \iint_S (x^2 + y^2)\left(\frac{a}{z}\right) d\sigma = a\delta \iint_R \frac{x^2 + y^2}{\sqrt{a^2 - (x^2 + y^2)}} dA = a\delta \int_0^{2\pi} \int_0^a \frac{r^2}{\sqrt{a^2 - r^2}} r dr d\theta$

$$= a\delta \int_0^{2\pi} \left[-r^2 \sqrt{a^2 - r^2} - \frac{2}{3} (a^2 - r^2)^{3/2} \right]_0^a d\theta = a\delta \int_0^{2\pi} \frac{2}{3} a^3 d\theta = \frac{4\pi}{3} a^4 \delta \Rightarrow \text{the moment of inertia is}$$

$\frac{8\pi}{3} a^4 \delta$ for the whole sphere

(b) $I_L = I_{c.m.} + mh^2$, where m is the mass of the body and h is the distance between the parallel lines; now,

$$I_{c.m.} = \frac{8\pi}{3} a^4 \delta \text{ (from part a) and } \frac{m}{2} = \iint_S \delta \, d\sigma = \delta \iint_R \left(\frac{a}{z} \right) dA = a\delta \iint_R \frac{1}{\sqrt{a^2 - (x^2 + y^2)}} dy \, dx$$

$$= a\delta \int_0^{2\pi} \int_0^a \frac{1}{\sqrt{a^2 - r^2}} r \, dr \, d\theta = a\delta \int_0^{2\pi} \left[-\sqrt{a^2 - r^2} \right]_0^a d\theta = a\delta \int_0^{2\pi} a \, d\theta = 2\pi a^2 \delta \text{ and } h = a$$

$$\Rightarrow I_L = \frac{8\pi}{3} a^4 \delta + 4\pi a^2 \delta a^2 = \frac{20\pi}{3} a^4 \delta$$

48. Let $z = \frac{h}{a} \sqrt{x^2 + y^2}$ be the cone from $z = 0$ to $z = h$, $h > 0$. Because of symmetry, $\bar{x} = 0$ and $\bar{y} = 0$;

$$z = \frac{h}{a} \sqrt{x^2 + y^2} \Rightarrow f(x, y, z) = \frac{h^2}{a^2} (x^2 + y^2) - z^2 = 0 \Rightarrow \nabla f = \frac{2xh^2}{a^2} \mathbf{i} + \frac{2yh^2}{a^2} \mathbf{j} - 2z\mathbf{k}$$

$$\Rightarrow |\nabla f| = \sqrt{\frac{4x^2h^4}{a^4} + \frac{4y^2h^4}{a^4} + 4z^2} = 2\sqrt{\frac{h^4}{a^4} (x^2 + y^2) + \frac{h^2}{a^2} (x^2 + y^2)} = 2\sqrt{\left(\frac{h^2}{a^2}\right) (x^2 + y^2) \left(\frac{h^2}{a^2} + 1\right)} = 2\sqrt{z^2 \left(\frac{h^2 + a^2}{a^2}\right)}$$

$$= \left(\frac{2z}{a}\right) \sqrt{h^2 + a^2} \text{ since } z \geq 0; \mathbf{p} = \mathbf{k} \Rightarrow |\nabla f \cdot \mathbf{p}| = 2z \Rightarrow d\sigma = \frac{\left(\frac{2z}{a}\right) \sqrt{h^2 + a^2}}{2z} dA = \frac{\sqrt{h^2 + a^2}}{a} dA;$$

$$M = \iint_S d\sigma = \iint_R \frac{\sqrt{h^2 + a^2}}{a} dA = \frac{\sqrt{h^2 + a^2}}{a} (\pi a^2) = \pi a \sqrt{h^2 + a^2}; M_{xy} = \iint_S z \, d\sigma = \iint_R z \left(\frac{\sqrt{h^2 + a^2}}{a}\right) dA$$

$$= \frac{\sqrt{h^2 + a^2}}{a} \iint_R \frac{h}{a} \sqrt{x^2 + y^2} \, dx \, dy = \frac{h\sqrt{h^2 + a^2}}{a^2} \int_0^{2\pi} \int_0^a r^2 \, dr \, d\theta = \frac{2\pi ah\sqrt{h^2 + a^2}}{3} \Rightarrow \bar{z} = \frac{M_{xy}}{M} = \frac{2h}{3} \Rightarrow \text{the centroid is}$$

$$\left(0, 0, \frac{2h}{3}\right)$$

16.7 STOKES' THEOREM

$$1. \text{ curl } \mathbf{F} = \nabla \times \mathbf{F} = \begin{vmatrix} \mathbf{i} & \mathbf{j} & \mathbf{k} \\ \frac{\partial}{\partial x} & \frac{\partial}{\partial y} & \frac{\partial}{\partial z} \\ x^2 & 2x & z^2 \end{vmatrix} = 0\mathbf{i} + 0\mathbf{j} + (2 - 0)\mathbf{k} = 2\mathbf{k} \text{ and } \mathbf{n} = \mathbf{k} \Rightarrow \text{curl } \mathbf{F} \cdot \mathbf{n} = 2 \Rightarrow d\sigma = dx \, dy$$

$$\Rightarrow \oint_C \mathbf{F} \cdot d\mathbf{r} = \iint_R 2 \, dA = 2(\text{Area of the ellipse}) = 4\pi$$

$$2. \text{ curl } \mathbf{F} = \nabla \times \mathbf{F} = \begin{vmatrix} \mathbf{i} & \mathbf{j} & \mathbf{k} \\ \frac{\partial}{\partial x} & \frac{\partial}{\partial y} & \frac{\partial}{\partial z} \\ 2y & 3x & -z^2 \end{vmatrix} = 0\mathbf{i} + 0\mathbf{j} + (3 - 2)\mathbf{k} = \mathbf{k} \text{ and } \mathbf{n} = \mathbf{k} \Rightarrow \text{curl } \mathbf{F} \cdot \mathbf{n} = 1 \Rightarrow d\sigma = dx \, dy$$

$$\Rightarrow \oint_C \mathbf{F} \cdot d\mathbf{r} = \iint_R dx \, dy = \text{Area of circle} = 9\pi$$

$$3. \operatorname{curl} \mathbf{F} = \nabla \times \mathbf{F} = \begin{vmatrix} \mathbf{i} & \mathbf{j} & \mathbf{k} \\ \frac{\partial}{\partial x} & \frac{\partial}{\partial y} & \frac{\partial}{\partial z} \\ y & xz & x^2 \end{vmatrix} = -x\mathbf{i} - 2x\mathbf{j} + (z-1)\mathbf{k} \text{ and } \mathbf{n} = \frac{\mathbf{i}+\mathbf{j}+\mathbf{k}}{\sqrt{3}} \Rightarrow \operatorname{curl} \mathbf{F} \cdot \mathbf{n} = \frac{1}{\sqrt{3}}(-x-2x+z-1)$$

$$\Rightarrow d\sigma = \frac{\sqrt{3}}{1} dA \Rightarrow \oint_C \mathbf{F} \cdot d\mathbf{r} = \iint_R \frac{1}{\sqrt{3}}(-3x+z-1)\sqrt{3} dA = \int_0^1 \int_0^{1-x} [-3x+(1-x-y)-1] dy dx$$

$$= \int_0^1 \int_0^{1-x} (-4x-y) dy dx = \int_0^1 -\left[4x(1-x) + \frac{1}{2}(1-x)^2\right] dx = -\int_0^1 \left(\frac{1}{2} + 3x - \frac{7}{2}x^2\right) dx = -\frac{5}{6}$$

$$4. \operatorname{curl} \mathbf{F} = \nabla \times \mathbf{F} = \begin{vmatrix} \mathbf{i} & \mathbf{j} & \mathbf{k} \\ \frac{\partial}{\partial x} & \frac{\partial}{\partial y} & \frac{\partial}{\partial z} \\ y^2+z^2 & x^2+z^2 & x^2+y^2 \end{vmatrix} = (2y-2z)\mathbf{i} + (2z-2x)\mathbf{j} + (2x-2y)\mathbf{k} \text{ and } \mathbf{n} = \frac{\mathbf{i}+\mathbf{j}+\mathbf{k}}{\sqrt{3}}$$

$$\Rightarrow \operatorname{curl} \mathbf{F} \cdot \mathbf{n} = \frac{1}{\sqrt{3}}(2y-2z+2z-2x+2x-2y) = 0 \Rightarrow \oint_C \mathbf{F} \cdot d\mathbf{r} = \iint_S 0 d\sigma = 0$$

$$5. \operatorname{curl} \mathbf{F} = \nabla \times \mathbf{F} = \begin{vmatrix} \mathbf{i} & \mathbf{j} & \mathbf{k} \\ \frac{\partial}{\partial x} & \frac{\partial}{\partial y} & \frac{\partial}{\partial z} \\ y^2+z^2 & x^2+y^2 & x^2+y^2 \end{vmatrix} = 2y\mathbf{i} + (2z-2x)\mathbf{j} + (2x-2y)\mathbf{k} \text{ and } \mathbf{n} = \mathbf{k} \Rightarrow \operatorname{curl} \mathbf{F} \cdot \mathbf{n} = 2x-2y$$

$$\Rightarrow d\sigma = dx dy \Rightarrow \oint_C \mathbf{F} \cdot d\mathbf{r} = \int_{-1}^1 \int_{-1}^1 (2x-2y) dx dy = \int_{-1}^1 [x^2 - 2xy]_{-1}^1 dy = \int_{-1}^1 -4y dy = 0$$

$$6. \operatorname{curl} \mathbf{F} = \nabla \times \mathbf{F} = \begin{vmatrix} \mathbf{i} & \mathbf{j} & \mathbf{k} \\ \frac{\partial}{\partial x} & \frac{\partial}{\partial y} & \frac{\partial}{\partial z} \\ x^2y^3 & 1 & z \end{vmatrix} = 0\mathbf{i} + 0\mathbf{j} - 3x^2y^2\mathbf{k} \text{ and } \mathbf{n} = \frac{2xi+2yj+2zk}{2\sqrt{x^2+y^2+z^2}} = \frac{xi+yj+zk}{4} \Rightarrow \operatorname{curl} \mathbf{F} \cdot \mathbf{n} = -\frac{3}{4}x^2y^2z;$$

$$d\sigma = \frac{4}{z} dA \quad (\text{Section 16.6, Example 6, with } a=4) \Rightarrow \oint_C \mathbf{F} \cdot d\mathbf{r} = \iint_R \left(-\frac{3}{4}x^2y^2z\right)\left(\frac{4}{z}\right) dA$$

$$= -3 \int_0^{2\pi} \int_0^2 (r^2 \cos^2 \theta)(r^2 \sin^2 \theta) r dr d\theta = -3 \int_0^{2\pi} \left[\frac{r^6}{6}\right]_0^2 (\cos \theta \sin \theta)^2 d\theta = -32 \int_0^{2\pi} \frac{1}{4} \sin^2 2\theta d\theta$$

$$= -4 \int_0^{4\pi} \sin^2 u du = -4 \left[\frac{u}{2} - \frac{\sin 2u}{4}\right]_0^{4\pi} = -8\pi$$

$$7. x = 3 \cos t \text{ and } y = 2 \sin t \Rightarrow \mathbf{F} = (2 \sin t)\mathbf{i} + (9 \cos^2 t)\mathbf{j} + (9 \cos^2 t + 16 \sin^4 t) \sin e^{\sqrt{(6 \sin t \cos t)(0)}} \mathbf{k} \text{ at the base of}$$

the shell; $\mathbf{r} = (3 \cos t)\mathbf{i} + (2 \sin t)\mathbf{j} \Rightarrow d\mathbf{r} = (-3 \sin t)\mathbf{i} + (2 \cos t)\mathbf{j} \Rightarrow \mathbf{F} \cdot \frac{d\mathbf{r}}{dt} = -6 \sin^2 t + 18 \cos^3 t$

$$\Rightarrow \iint_S \nabla \times \mathbf{F} \cdot \mathbf{n} d\sigma = \int_0^{2\pi} \left(-6 \sin^2 t + 18 \cos^3 t\right) dt = \left[-3t + \frac{3}{2} \sin 2t + 6(\sin t)(\cos^2 t + 2)\right]_0^{2\pi} = -6\pi$$

$$8. \text{curl } \mathbf{F} = \nabla \times \mathbf{F} = \begin{vmatrix} \mathbf{i} & \mathbf{j} & \mathbf{k} \\ \frac{\partial}{\partial x} & \frac{\partial}{\partial y} & \frac{\partial}{\partial z} \\ -z + \frac{1}{2+x} & \tan^{-1} y & x + \frac{1}{4+z} \end{vmatrix} = -2\mathbf{j}; f(x, y, z) = 4x^2 + y + z^2 \Rightarrow \nabla f = 8x\mathbf{i} + \mathbf{j} + 2z\mathbf{k}$$

$$\Rightarrow \mathbf{n} = \frac{\nabla f}{|\nabla f|} \text{ and } \mathbf{p} = \mathbf{j} \Rightarrow |\nabla f \cdot \mathbf{p}| = 1 \Rightarrow d\sigma = \frac{|\nabla f|}{|\nabla f \cdot \mathbf{p}|} dA = |\nabla f| dA; \nabla \times \mathbf{F} \cdot \mathbf{n} = \frac{1}{|\nabla f|} (-2\mathbf{j} \cdot \nabla f) = \frac{-2}{|\nabla f|}$$

$$\Rightarrow \nabla \times \mathbf{F} \cdot \mathbf{n} d\sigma = -2 dA \Rightarrow \iint_S \nabla \times \mathbf{F} \cdot \mathbf{n} d\sigma = \iint_R -2 dA = -2 (\text{Area of } R) = -2(\pi \cdot 1 \cdot 2) = -4\pi, \text{ where } R \text{ is the}$$

elliptic region in the xz -plane enclosed by $4x^2 + z^2 = 4$.

$$9. \text{Flux of } \nabla \times \mathbf{F} = \iint_S \nabla \times \mathbf{F} \cdot \mathbf{n} d\sigma = \oint_C \mathbf{F} \cdot d\mathbf{r}, \text{ so let } C \text{ be parametrized by } \mathbf{r} = (a \cos t)\mathbf{i} + (a \sin t)\mathbf{j}, 0 \leq t \leq 2\pi$$

$$\Rightarrow \frac{d\mathbf{r}}{dt} = (-a \sin t)\mathbf{i} + (a \cos t)\mathbf{j} \Rightarrow \mathbf{F} \cdot \frac{d\mathbf{r}}{dt} = ay \sin t + ax \cos t = a^2 \sin^2 t + a^2 \cos^2 t = a^2$$

$$\Rightarrow \text{Flux of } \nabla \times \mathbf{F} = \oint_C \mathbf{F} \cdot d\mathbf{r} = \int_0^{2\pi} a^2 dt = 2\pi a^2$$

$$10. \nabla \times (y\mathbf{i}) = \begin{vmatrix} \mathbf{i} & \mathbf{j} & \mathbf{k} \\ \frac{\partial}{\partial x} & \frac{\partial}{\partial y} & \frac{\partial}{\partial z} \\ y & 0 & 0 \end{vmatrix} = -\mathbf{k}; \mathbf{n} = \frac{\nabla f}{|\nabla f|} = \frac{2x\mathbf{i} + 2y\mathbf{j} + 2z\mathbf{k}}{2\sqrt{x^2 + y^2 + z^2}} = x\mathbf{i} + y\mathbf{j} + z\mathbf{k} \Rightarrow \nabla \times (y\mathbf{i}) \cdot \mathbf{n} = -z; d\sigma = \frac{1}{z} dA$$

$$(\text{Section 16.6, Example 6, with } a = 1) \Rightarrow \iint_S \nabla \times (y\mathbf{i}) \cdot \mathbf{n} d\sigma = \iint_R (-z) \left(\frac{1}{z} dA\right) = -\iint_R dA = -\pi, \text{ where } R \text{ is the disk}$$

$x^2 + y^2 \leq 1$ in the xy -plane.

11. For the upper hemisphere with $z \geq 0$, the boundary C is the unit circle of radius 1 centered at the origin in the xy -plane. An outward normal on the upper hemisphere corresponds to counterclockwise circulation around the boundary, so the boundary can be parametrized as $\mathbf{r}(\theta) = (\cos \theta)\mathbf{i} + (\sin \theta)\mathbf{j} + 0\mathbf{k}$, with $0 \leq \theta \leq 2\pi$. Thus

$d\mathbf{r} = (-\sin \theta d\theta)\mathbf{i} + (\cos \theta d\theta)\mathbf{j}$. For the field $\mathbf{A} = (y + \sqrt{z})\mathbf{i} + e^{xyz}\mathbf{j} + (\cos xz)\mathbf{k}$, the flux of $\mathbf{F} = \nabla \times \mathbf{A}$ across the upper hemisphere is, by Stokes' Theorem, equal to the circulation of \mathbf{A} on the boundary. Since $z = 0$ and $y = \sin \theta$ on the boundary, the field \mathbf{A} on the boundary is $(\sin \theta)\mathbf{i} + \mathbf{j} + \mathbf{k}$. The circulation of \mathbf{A} on C is

$$\begin{aligned} \oint_C \mathbf{A} \cdot d\mathbf{r} &= \oint_C ((\sin \theta)\mathbf{i} + \mathbf{j} + \mathbf{k}) \cdot ((-\sin \theta d\theta)\mathbf{i} + (\cos \theta d\theta)\mathbf{j}) = \int_0^{2\pi} (\cos \theta - \sin^2 \theta) d\theta \\ &= \int_0^{2\pi} \left(\cos \theta + \frac{1}{2}(\cos 2\theta - 1)\right) d\theta = -\pi \end{aligned}$$

12. Since the outward normal on the bottom hemisphere corresponds to clockwise circulation on the boundary, the flux of \mathbf{F} through the bottom hemisphere will be π and the total flux through the sphere will be 0.

$$13. \nabla \times \mathbf{F} = \begin{vmatrix} \mathbf{i} & \mathbf{j} & \mathbf{k} \\ \frac{\partial}{\partial x} & \frac{\partial}{\partial y} & \frac{\partial}{\partial z} \\ 2z & 3x & 5y \end{vmatrix} = 5\mathbf{i} + 2\mathbf{j} + 3\mathbf{k}; \mathbf{r}_r = (\cos \theta)\mathbf{i} + (\sin \theta)\mathbf{j} - 2r\mathbf{k} \text{ and } \mathbf{r}_\theta = (-r \sin \theta)\mathbf{i} + (r \cos \theta)\mathbf{j}$$

$$\Rightarrow \mathbf{r}_r \times \mathbf{r}_\theta = \begin{vmatrix} \mathbf{i} & \mathbf{j} & \mathbf{k} \\ \cos \theta & \sin \theta & -2r \\ -r \sin \theta & r \cos \theta & 0 \end{vmatrix} = (2r^2 \cos \theta)\mathbf{i} + (2r^2 \sin \theta)\mathbf{j} + r\mathbf{k}; \mathbf{n} = \frac{\mathbf{r}_r \times \mathbf{r}_\theta}{|\mathbf{r}_r \times \mathbf{r}_\theta|} \text{ and } d\sigma = |\mathbf{r}_r \times \mathbf{r}_\theta| dr d\theta$$

$$\begin{aligned} \Rightarrow \nabla \times \mathbf{F} \cdot \mathbf{n} \, d\sigma &= (\nabla \times \mathbf{F}) \cdot (\mathbf{r}_r \times \mathbf{r}_\theta) \, dr \, d\theta = (10r^2 \cos \theta + 4r^2 \sin \theta + 3r) \, dr \, d\theta \Rightarrow \iint_S \nabla \times \mathbf{F} \cdot \mathbf{n} \, d\sigma \\ &= \int_0^{2\pi} \int_0^2 (10r^2 \cos \theta + 4r^2 \sin \theta + 3r) \, dr \, d\theta = \int_0^{2\pi} \left[\frac{10}{3} r^3 \cos \theta + \frac{4}{3} r^3 \sin \theta + \frac{3}{2} r^2 \right]_0^2 \, d\theta \\ &= \int_0^{2\pi} \left(\frac{80}{3} \cos \theta + \frac{32}{3} \sin \theta + 6 \right) \, d\theta = 6(2\pi) = 12\pi \end{aligned}$$

$$14. \quad \nabla \times \mathbf{F} = \begin{vmatrix} \mathbf{i} & \mathbf{j} & \mathbf{k} \\ \frac{\partial}{\partial x} & \frac{\partial}{\partial y} & \frac{\partial}{\partial z} \\ y-z & z-x & x+z \end{vmatrix} = \mathbf{i} - 2\mathbf{j} - 2\mathbf{k}; \mathbf{r}_r \times \mathbf{r}_\theta = (2r^2 \cos \theta)\mathbf{i} + (2r^2 \sin \theta)\mathbf{j} + r\mathbf{k} \text{ and}$$

$$\begin{aligned} \nabla \times \mathbf{F} \cdot \mathbf{n} \, d\sigma &= (\nabla \times \mathbf{F}) \cdot (\mathbf{r}_r \times \mathbf{r}_\theta) \, dr \, d\theta \text{ (see Exercise 13 above)} \\ \Rightarrow \iint_S \nabla \times \mathbf{F} \cdot \mathbf{n} \, d\sigma &= \int_0^{2\pi} \int_0^3 (-2r^2 \cos \theta - 4r^2 \sin \theta - 2r) \, dr \, d\theta = \int_0^{2\pi} \left[-\frac{2}{3} r^3 \cos \theta - \frac{4}{3} r^3 \sin \theta - r^2 \right]_0^3 \, d\theta \\ &= \int_0^{2\pi} (-18 \cos \theta - 36 \sin \theta - 9) \, d\theta = -9(2\pi) = -18\pi \end{aligned}$$

$$15. \quad \nabla \times \mathbf{F} = \begin{vmatrix} \mathbf{i} & \mathbf{j} & \mathbf{k} \\ \frac{\partial}{\partial x} & \frac{\partial}{\partial y} & \frac{\partial}{\partial z} \\ x^2 y & 2y^3 z & 3z \end{vmatrix} = -2y^3 \mathbf{i} + 0\mathbf{j} - x^2 \mathbf{k}; \mathbf{r}_r \times \mathbf{r}_\theta = \begin{vmatrix} \mathbf{i} & \mathbf{j} & \mathbf{k} \\ \cos \theta & \sin \theta & 1 \\ -r \sin \theta & r \cos \theta & 0 \end{vmatrix} = (-r \cos \theta)\mathbf{i} - (r \sin \theta)\mathbf{j} + r\mathbf{k} \text{ and}$$

$$\begin{aligned} \nabla \times \mathbf{F} \cdot \mathbf{n} \, d\sigma &= (\nabla \times \mathbf{F}) \cdot (\mathbf{r}_r \times \mathbf{r}_\theta) \, dr \, d\theta \text{ (see Exercise 13 above)} \Rightarrow \iint_S \nabla \times \mathbf{F} \cdot \mathbf{n} \, d\sigma = \iint_R (2ry^3 \cos \theta - rx^2) \, dr \, d\theta \\ &= \int_0^{2\pi} \int_0^1 (2r^4 \sin^3 \theta \cos \theta - r^3 \cos^2 \theta) \, dr \, d\theta = \int_0^{2\pi} \left(\frac{2}{5} \sin^3 \theta \cos \theta - \frac{1}{4} \cos^2 \theta \right) \, d\theta = \left[\frac{1}{10} \sin^4 \theta - \frac{1}{4} \left(\frac{\theta}{2} + \frac{\sin 2\theta}{4} \right) \right]_0^{2\pi} \\ &= -\frac{\pi}{4} \end{aligned}$$

$$16. \quad \nabla \times \mathbf{F} = \begin{vmatrix} \mathbf{i} & \mathbf{j} & \mathbf{k} \\ \frac{\partial}{\partial x} & \frac{\partial}{\partial y} & \frac{\partial}{\partial z} \\ x-y & y-z & z-x \end{vmatrix} = \mathbf{i} + \mathbf{j} + \mathbf{k}; \mathbf{r}_r \times \mathbf{r}_\theta = \begin{vmatrix} \mathbf{i} & \mathbf{j} & \mathbf{k} \\ \cos \theta & \sin \theta & -1 \\ -r \sin \theta & r \cos \theta & 0 \end{vmatrix} = (r \cos \theta)\mathbf{i} + (r \sin \theta)\mathbf{j} + r\mathbf{k} \text{ and}$$

$$\begin{aligned} \nabla \times \mathbf{F} \cdot \mathbf{n} \, d\sigma &= (\nabla \times \mathbf{F}) \cdot (\mathbf{r}_r \times \mathbf{r}_\theta) \, dr \, d\theta \text{ (see Exercise 13 above)} \\ \Rightarrow \iint_S \nabla \times \mathbf{F} \cdot \mathbf{n} \, d\sigma &= \int_0^{2\pi} \int_0^5 (r \cos \theta + r \sin \theta + r) \, dr \, d\theta = \int_0^{2\pi} \left[(\cos \theta + \sin \theta + 1) \frac{r^2}{2} \right]_0^5 \, d\theta = \left(\frac{25}{2} \right) (2\pi) = 25\pi \end{aligned}$$

$$17. \quad \nabla \times \mathbf{F} = \begin{vmatrix} \mathbf{i} & \mathbf{j} & \mathbf{k} \\ \frac{\partial}{\partial x} & \frac{\partial}{\partial y} & \frac{\partial}{\partial z} \\ 3y & 5-2x & z^2-2 \end{vmatrix} = 0\mathbf{i} + 0\mathbf{j} - 5\mathbf{k}; \mathbf{r}_\phi \times \mathbf{r}_\theta = \begin{vmatrix} \mathbf{i} & \mathbf{j} & \mathbf{k} \\ \sqrt{3} \cos \phi \cos \theta & \sqrt{3} \cos \phi \sin \theta & -\sqrt{3} \sin \phi \\ -\sqrt{3} \sin \phi \sin \theta & \sqrt{3} \sin \phi \cos \theta & 0 \end{vmatrix}$$

$$\begin{aligned} &= (3 \sin^2 \phi \cos \theta)\mathbf{i} + (3 \sin^2 \phi \sin \theta)\mathbf{j} + (3 \sin \phi \cos \phi)\mathbf{k}; \nabla \times \mathbf{F} \cdot \mathbf{n} \, d\sigma = (\nabla \times \mathbf{F}) \cdot (\mathbf{r}_\phi \times \mathbf{r}_\theta) \, d\phi \, d\theta \text{ (see Exercise 13} \\ \text{above)} \Rightarrow \iint_S \nabla \times \mathbf{F} \cdot \mathbf{n} \, d\sigma &= \int_0^{2\pi} \int_0^{\pi/2} (-15 \cos \phi \sin \phi) \, d\phi \, d\theta = \int_0^{2\pi} \left[\frac{15}{2} \cos^2 \phi \right]_0^{\pi/2} \, d\theta = \int_0^{2\pi} -\frac{15}{2} \, d\theta = -15\pi \end{aligned}$$

$$\begin{aligned}
18. \quad \nabla \times \mathbf{F} &= \begin{vmatrix} \mathbf{i} & \mathbf{j} & \mathbf{k} \\ \frac{\partial}{\partial x} & \frac{\partial}{\partial y} & \frac{\partial}{\partial z} \\ y^2 & z^2 & x \end{vmatrix} = -2z\mathbf{i} - \mathbf{j} - 2y\mathbf{k}; \quad \mathbf{r}_\phi \times \mathbf{r}_\theta = \begin{vmatrix} \mathbf{i} & \mathbf{j} & \mathbf{k} \\ 2\cos\phi\cos\theta & 2\cos\phi\sin\theta & -2\sin\phi \\ -2\sin\phi\sin\theta & 2\sin\phi\cos\theta & 0 \end{vmatrix} \\
&= (4\sin^2\phi\cos\theta)\mathbf{i} + (4\sin^2\phi\sin\theta)\mathbf{j} + (4\sin\phi\cos\phi)\mathbf{k}; \quad \nabla \times \mathbf{F} \cdot \mathbf{n} \, d\sigma = (\nabla \times \mathbf{F}) \cdot (\mathbf{r}_\phi \times \mathbf{r}_\theta) \, d\phi \, d\theta \quad (\text{see Exercise 13 above}) \\
&\Rightarrow \iint_S \nabla \times \mathbf{F} \cdot \mathbf{n} \, d\sigma = \iint_R (-8z\sin^2\phi\cos\theta - 4\sin^2\phi\sin\theta - 8y\sin\phi\cos\theta) \, d\phi \, d\theta \\
&= \int_0^{2\pi} \int_0^{\pi/2} (-16\sin^2\phi\cos\phi\cos\theta - 4\sin^2\phi\sin\theta - 16\sin\theta\cos\theta) \, d\phi \, d\theta \\
&= \int_0^{2\pi} \left[-\frac{16}{3}\sin^3\phi\cos\theta - 4\left(\frac{\phi}{2} - \frac{\sin 2\phi}{4}\right)(\sin\theta) - 16\left(\frac{\phi}{2} - \frac{\sin 2\phi}{4}\right)(\sin\theta\cos\theta) \right]_0^{\pi/2} d\theta \\
&= \int_0^{2\pi} \left(-\frac{16}{3}\cos\theta - \pi\sin\theta - 4\pi\sin\theta\cos\theta \right) d\theta = \left[-\frac{16}{3}\sin\theta + \pi\cos\theta - 2\pi\sin^2\theta \right]_0^{2\pi} = 0
\end{aligned}$$

19. We first compute the circulation of $\mathbf{F} = y\mathbf{i} - x\mathbf{j} + x^2\mathbf{k}$ on the curve C given by

$$\begin{aligned}
\mathbf{r}(t) &= (2\cos t)\mathbf{i} + (2\sin t)\mathbf{j} + (3 - 2\cos^3 t)\mathbf{k} \quad \text{for } 0 \leq t \leq 2\pi. \quad \text{On } C \quad \mathbf{F} = (2\sin t)\mathbf{i} - (2\cos t)\mathbf{j} + (4\cos^2 t)\mathbf{k}, \text{ and} \\
d\mathbf{r} &= (-2\sin t \, dt)\mathbf{i} + (2\cos t \, dt)\mathbf{j} - (6\sin t \cos^2 t \, dt)\mathbf{k}.
\end{aligned}$$

$$\begin{aligned}
\oint_C \mathbf{F} \cdot d\mathbf{r} &= \oint_C ((2\sin t)\mathbf{i} - (2\cos t)\mathbf{j} + (4\cos^2 t)\mathbf{k}) \cdot ((-2\sin t \, dt)\mathbf{i} + (2\cos t \, dt)\mathbf{j} - (6\sin t \cos^2 t \, dt)\mathbf{k}) \\
&= -4 \int_0^{2\pi} (\sin^2 t + \cos^2 t + 6\sin t \cos^4 t) \, dt = -4 \int_0^{2\pi} (1 + 6\sin t \cos^4 t) \, dt = -8\pi.
\end{aligned}$$

Now we find the flux of $\nabla \times \mathbf{F}$ across the surface S . Note that counterclockwise circulation on C corresponds to inward normals on the cylindrical portion of S and upward normals on the base disk.

For the field $\mathbf{F} = y\mathbf{i} - x\mathbf{j} + x^2\mathbf{k}$, $\nabla \times \mathbf{F} = (-2x)\mathbf{j} - 2\mathbf{k}$.

On the base disk, the unit upward normal is \mathbf{k} so $\nabla \times \mathbf{F} \cdot \mathbf{n} = ((-2x)\mathbf{j} - 2\mathbf{k}) \cdot \mathbf{k} = -2$. The integral of the constant -2 over a disk of area 4π is -8π , so to verify Stokes' Theorem in this case it remains to show that the flux across the cylindrical portion of S is 0.

We'll reuse the parameter t and parametrize the cylinder by $\mathbf{s}(t, z) = (2\cos t)\mathbf{i} + (2\sin t)\mathbf{j} + z\mathbf{k}$ with

$0 \leq z \leq 3 - 2\cos^3 t$. An inward unit normal is $(-\cos t)\mathbf{i} + (-\sin t)\mathbf{j}$ and the area element is $d\sigma = 2 \, dz \, dt$. On the cylinder the field $\nabla \times \mathbf{F} = (-4\cos t)\mathbf{j} - 2\mathbf{k}$. Thus

$$\begin{aligned}
\iint_S \nabla \times \mathbf{F} \cdot \mathbf{n} \, d\sigma &= \iint_S ((-4\cos t)\mathbf{j} - 2\mathbf{k}) \cdot ((-\cos t)\mathbf{i} + (-\sin t)\mathbf{j}) \, d\sigma \\
&= \int_0^{2\pi} \int_0^{3-2\cos^3 t} (4\sin t \cos t) \, 2 \, dz \, dt = 8 \int_0^{2\pi} (\sin t \cos t)(3 - 2\cos^3 t) \, dt \\
&= 8 \int_0^{2\pi} \left(3\sin t \cos t - 2\sin t \cos^4 t \right) dt = 8 \left(\frac{3}{2}\sin^2 t + \frac{2}{5}\cos^5 t \right) \Big|_0^{2\pi} = 0
\end{aligned}$$

20. The boundary C of the paraboloid S given by $z = 4 - x^2 - y^2$ is the circle of radius 2 centered at the origin in the xy -plane. An upward normal on the paraboloid corresponds to counterclockwise circulation around C , so we can parametrize C by $\mathbf{r}(t) = (2\cos t)\mathbf{i} + (2\sin t)\mathbf{j}$ for $0 \leq t \leq 2\pi$, with $d\mathbf{r} = (-2\sin t \, dt)\mathbf{i} + (2\cos t \, dt)\mathbf{j}$. On C the field $\mathbf{F} = 2xy\mathbf{i} + x\mathbf{j} + (y+z)\mathbf{k}$ is equal to $(8\cos t \sin t)\mathbf{i} + (2\cos t)\mathbf{j} + (2\sin t)\mathbf{k}$.

$$\begin{aligned} \oint_C \mathbf{F} \cdot d\mathbf{r} &= \oint_C ((8 \cos t \sin t)\mathbf{i} + (2 \cos t)\mathbf{j} + (2 \sin t)\mathbf{k}) \cdot ((-2 \sin t) dt \mathbf{i} + (2 \cos t) dt \mathbf{j}) \\ &= 4 \int_0^{2\pi} (-4 \cos t \sin^2 t + \cos^2 t) dt = 4 \left[-\frac{4}{3} \sin^3 t + \frac{1}{4} \sin 2t + \frac{1}{2} t \right]_0^{2\pi} = 4\pi \end{aligned}$$

Now for comparison we integrate $\nabla \times \mathbf{F} = \mathbf{i} + (1 - 2x)\mathbf{k}$ over the paraboloid S . We can parametrize the paraboloid as $\mathbf{s}(u, t) = (u \cos t)\mathbf{i} + (u \sin t)\mathbf{j} + (4 - u^2)\mathbf{k}$ with $0 \leq u \leq 2$ and $0 \leq t \leq 2\pi$. Thus on S the field $\nabla \times \mathbf{F}$ is equal to $\mathbf{i} + (1 - 2u \cos t)\mathbf{k}$.

First we find the vector area element:

$$\begin{aligned} \mathbf{s}_u \times \mathbf{s}_t &= ((\cos t)\mathbf{i} + (\sin t)\mathbf{j} + (-2u)\mathbf{k}) \times ((-u \sin t)\mathbf{i} + (u \cos t)\mathbf{j} + 0\mathbf{k}) \\ &= (2u^2 \cos t)\mathbf{i} + (2u^2 \sin t)\mathbf{j} + u\mathbf{k} \end{aligned}$$

which is upward, as we require. The integral of the outward component of the field is then

$$\begin{aligned} \iint_S (\nabla \times \mathbf{F}) \cdot (\mathbf{s}_u \times \mathbf{s}_t) du dt &= \int_0^{2\pi} \int_0^2 (\mathbf{i} + (1 - 2u \cos t)\mathbf{k}) \cdot ((2u^2 \cos t)\mathbf{i} + (2u^2 \sin t)\mathbf{j} + u\mathbf{k}) du dt \\ &= \int_0^{2\pi} \int_0^2 u du dt = \int_0^{2\pi} \left[\frac{u^2}{2} \right]_0^2 dt = 4\pi \end{aligned}$$

Thus the circulation of \mathbf{F} around the boundary of the paraboloid is equal to the flux of $\nabla \times \mathbf{F}$ through the paraboloid.

21. (a) $\mathbf{F} = 2x\mathbf{i} + 2y\mathbf{j} + 2z\mathbf{k} \Rightarrow \text{curl } \mathbf{F} = \mathbf{0} \Rightarrow \oint_C \mathbf{F} \cdot d\mathbf{r} = \iint_S \nabla \times \mathbf{F} \cdot \mathbf{n} d\sigma = \iint_S 0 d\sigma = 0$
 (b) Let $f(x, y, z) = x^2 y^2 z^3 \Rightarrow \nabla \times \mathbf{F} = \nabla \times \nabla f = \mathbf{0} \Rightarrow \text{curl } \mathbf{F} = \mathbf{0} \Rightarrow \oint_C \mathbf{F} \cdot d\mathbf{r} = \iint_S \nabla \times \mathbf{F} \cdot \mathbf{n} d\sigma = \iint_S 0 d\sigma = 0$
 (c) $\mathbf{F} = \nabla \times (x\mathbf{i} + y\mathbf{j} + z\mathbf{k}) = \mathbf{0} \Rightarrow \nabla \times \mathbf{F} = \mathbf{0} \Rightarrow \oint_C \mathbf{F} \cdot d\mathbf{r} = \iint_S \nabla \times \mathbf{F} \cdot \mathbf{n} d\sigma = \iint_S 0 d\sigma = 0$
 (d) $\mathbf{F} = \nabla f \Rightarrow \nabla \times \mathbf{F} = \nabla \times \nabla f = \mathbf{0} \Rightarrow \oint_C \mathbf{F} \cdot d\mathbf{r} = \iint_S \nabla \times \mathbf{F} \cdot \mathbf{n} d\sigma = \iint_S 0 d\sigma = 0$

22. $\mathbf{F} = \nabla f = \frac{1}{2}(x^2 + y^2 + z^2)^{-3/2} (2x)\mathbf{i} - \frac{1}{2}(x^2 + y^2 + z^2)^{-3/2} (2y)\mathbf{j} - \frac{1}{2}(x^2 + y^2 + z^2)^{-3/2} (2z)\mathbf{k}$
 $= -x(x^2 + y^2 + z^2)^{-3/2} \mathbf{i} - y(x^2 + y^2 + z^2)^{-3/2} \mathbf{j} - z(x^2 + y^2 + z^2)^{-3/2} \mathbf{k}$

(a) $\mathbf{r} = (a \cos t)\mathbf{i} + (a \sin t)\mathbf{j}, 0 \leq t \leq 2\pi \Rightarrow \frac{d\mathbf{r}}{dt} = (-a \sin t)\mathbf{i} + (a \cos t)\mathbf{j}$
 $\Rightarrow \mathbf{F} \cdot \frac{d\mathbf{r}}{dt} = -x(x^2 + y^2 + z^2)^{-3/2} (-a \sin t) - y(x^2 + y^2 + z^2)^{-3/2} (a \cos t)$
 $= \left(-\frac{a \cos t}{a^3}\right)(-a \sin t) - \left(\frac{a \sin t}{a^3}\right)(a \cos t) = 0 \Rightarrow \oint_C \mathbf{F} \cdot d\mathbf{r} = 0$

(b) $\oint_C \mathbf{F} \cdot d\mathbf{r} = \iint_S \nabla \times \mathbf{F} \cdot \mathbf{n} d\sigma = \iint_S \nabla \times \nabla f \cdot \mathbf{n} d\sigma = \iint_S \mathbf{0} \cdot \mathbf{n} d\sigma = \iint_S 0 d\sigma = 0$

23. Let $\mathbf{F} = 2y\mathbf{i} + 3z\mathbf{j} - x\mathbf{k} \Rightarrow \nabla \times \mathbf{F} = \begin{vmatrix} \mathbf{i} & \mathbf{j} & \mathbf{k} \\ \frac{\partial}{\partial x} & \frac{\partial}{\partial y} & \frac{\partial}{\partial z} \\ 2y & 3z & -x \end{vmatrix} = -3\mathbf{i} + \mathbf{j} - 2\mathbf{k}; \mathbf{n} = \frac{2\mathbf{i} + 2\mathbf{j} + \mathbf{k}}{3} \Rightarrow \nabla \times \mathbf{F} \cdot \mathbf{n} = -2$
 $\Rightarrow \oint_C 2y \, dx + 3z \, dy - x \, dz = \oint_C \mathbf{F} \cdot d\mathbf{r} = \iint_S \nabla \times \mathbf{F} \cdot \mathbf{n} \, d\sigma = \iint_S -2 \, d\sigma = -2 \iint_S d\sigma$, where $\iint_S d\sigma$ is the area of the region enclosed by C on the plane S : $2x + 2y + z = 2$

24. $\nabla \times \mathbf{F} = \begin{vmatrix} \mathbf{i} & \mathbf{j} & \mathbf{k} \\ \frac{\partial}{\partial x} & \frac{\partial}{\partial y} & \frac{\partial}{\partial z} \\ x & y & z \end{vmatrix} = \mathbf{0}$

25. Suppose $\mathbf{F} = M\mathbf{i} + N\mathbf{j} + P\mathbf{k}$ exists such that $\nabla \times \mathbf{F} = \left(\frac{\partial P}{\partial y} - \frac{\partial N}{\partial z}\right)\mathbf{i} + \left(\frac{\partial M}{\partial z} - \frac{\partial P}{\partial x}\right)\mathbf{j} + \left(\frac{\partial N}{\partial x} - \frac{\partial M}{\partial y}\right)\mathbf{k} = x\mathbf{i} + y\mathbf{j} + z\mathbf{k}$.

Then $\frac{\partial}{\partial x} \left(\frac{\partial P}{\partial y} - \frac{\partial N}{\partial z}\right) = \frac{\partial}{\partial x}(x) \Rightarrow \frac{\partial^2 P}{\partial x \partial y} - \frac{\partial^2 N}{\partial x \partial z} = 1$.

Likewise, $\frac{\partial}{\partial y} \left(\frac{\partial M}{\partial z} - \frac{\partial P}{\partial x}\right) = \frac{\partial}{\partial y}(y) \Rightarrow \frac{\partial^2 M}{\partial y \partial z} - \frac{\partial^2 P}{\partial y \partial x} = 1$ and $\frac{\partial}{\partial z} \left(\frac{\partial N}{\partial x} - \frac{\partial M}{\partial y}\right) = \frac{\partial}{\partial z}(z) \Rightarrow \frac{\partial^2 N}{\partial z \partial x} - \frac{\partial^2 M}{\partial z \partial y} = 1$.

Summing the calculated equations $\Rightarrow \left(\frac{\partial^2 P}{\partial x \partial y} - \frac{\partial^2 P}{\partial y \partial x}\right) + \left(\frac{\partial^2 N}{\partial z \partial x} - \frac{\partial^2 N}{\partial x \partial z}\right) + \left(\frac{\partial^2 M}{\partial y \partial z} - \frac{\partial^2 M}{\partial z \partial y}\right) = 3$ or $0 = 3$

(assuming the second mixed partials are equal). This result is a contradiction, so there is no field \mathbf{F} such that $\text{curl } \mathbf{F} = x\mathbf{i} + y\mathbf{j} + z\mathbf{k}$.

26. Yes: If $\nabla \times \mathbf{F} = \mathbf{0}$, then the circulation of \mathbf{F} around the boundary C of any oriented surface S in the domain of \mathbf{F} is zero. The reason is this: By Stokes' theorem, circulation $= \oint_C \mathbf{F} \cdot d\mathbf{r} = \iint_S \nabla \times \mathbf{F} \cdot \mathbf{n} \, d\sigma = \iint_S \mathbf{0} \cdot \mathbf{n} \, d\sigma = 0$.

27. $r = \sqrt{x^2 + y^2} \Rightarrow r^4 = (x^2 + y^2)^2 \Rightarrow \mathbf{F} = \nabla(r^4) = 4x(x^2 + y^2)\mathbf{i} + 4y(x^2 + y^2)\mathbf{j} = M\mathbf{i} + N\mathbf{j}$
 $\Rightarrow \oint_C \nabla(r^4) \cdot \mathbf{n} \, ds = \oint_C \mathbf{F} \cdot \mathbf{n} \, ds = \oint_C M \, dy - N \, dx = \iint_R \left(\frac{\partial M}{\partial x} + \frac{\partial N}{\partial y}\right) dx \, dy$
 $= \iint_R \left[4(x^2 + y^2) + 8x^2 + 4(x^2 + y^2) + 8y^2\right] dA = \iint_R 16(x^2 + y^2) dA = 16 \iint_R x^2 \, dA + 16 \iint_R y^2 \, dA$
 $= 16I_y + 16I_x$.

28. $\frac{\partial P}{\partial y} = 0, \frac{\partial N}{\partial z} = 0, \frac{\partial M}{\partial z} = 0, \frac{\partial P}{\partial x} = 0, \frac{\partial N}{\partial x} = \frac{y^2 - x^2}{(x^2 + y^2)^2}, \frac{\partial M}{\partial y} = \frac{y^2 - x^2}{(x^2 + y^2)^2} \Rightarrow \text{curl } \mathbf{F} = \left[\frac{y^2 - x^2}{(x^2 + y^2)^2} - \frac{y^2 - x^2}{(x^2 + y^2)^2} \right] \mathbf{k} = \mathbf{0}$.

However, $x^2 + y^2 = 1 \Rightarrow \mathbf{r} = (\cos t)\mathbf{i} + (\sin t)\mathbf{j} \Rightarrow \frac{d\mathbf{r}}{dt} = (-\sin t)\mathbf{i} + (\cos t)\mathbf{j}$

$\Rightarrow \mathbf{F} = (-\sin t)\mathbf{i} + (\cos t)\mathbf{j} \Rightarrow \mathbf{F} \cdot \frac{d\mathbf{r}}{dt} = \sin^2 t + \cos^2 t = 1 \Rightarrow \oint_C \mathbf{F} \cdot d\mathbf{r} = \int_0^{2\pi} 1 \, dt = 2\pi$ which is not zero.

16.8 THE DIVERGENCE THEOREM AND A UNIFIED THEORY

$$1. \mathbf{F} = \frac{-y\mathbf{i} + x\mathbf{j}}{\sqrt{x^2 + y^2}} \Rightarrow \operatorname{div} \mathbf{F} = \frac{xy - xy}{(x^2 + y^2)^{3/2}} = 0$$

$$2. \mathbf{F} = x\mathbf{i} + y\mathbf{j} \Rightarrow \operatorname{div} \mathbf{F} = 1 + 1 = 2$$

$$3. \mathbf{F} = -\frac{GM(x\mathbf{i} + y\mathbf{j} + z\mathbf{k})}{(x^2 + y^2 + z^2)^{3/2}}$$

$$\begin{aligned} \Rightarrow \operatorname{div} \mathbf{F} &= -GM \left[\frac{(x^2 + y^2 + z^2)^{3/2} - 3x^2(x^2 + y^2 + z^2)^{1/2}}{(x^2 + y^2 + z^2)^3} \right] - GM \left[\frac{(x^2 + y^2 + z^2)^{3/2} - 3y^2(x^2 + y^2 + z^2)^{1/2}}{(x^2 + y^2 + z^2)^3} \right] \\ &\quad - GM \left[\frac{(x^2 + y^2 + z^2)^{3/2} - 3z^2(x^2 + y^2 + z^2)^{1/2}}{(x^2 + y^2 + z^2)^3} \right] = -GM \left[\frac{3(x^2 + y^2 + z^2)^2 - 3(x^2 + y^2 + z^2)(x^2 + y^2 + z^2)}{(x^2 + y^2 + z^2)^{7/2}} \right] = 0 \end{aligned}$$

$$4. z = a^2 - r^2 \text{ in cylindrical coordinates} \Rightarrow z = a^2 - (x^2 + y^2) \Rightarrow \mathbf{v} = (a^2 - x^2 - y^2)\mathbf{k} \Rightarrow \operatorname{div} \mathbf{v} = 0$$

$$5. \frac{\partial}{\partial x}(y - x) = -1, \frac{\partial}{\partial y}(z - y) = -1, \frac{\partial}{\partial z}(y - x) = 0 \Rightarrow \nabla \cdot \mathbf{F} = -2 \Rightarrow \text{Flux} = \int_{-1}^1 \int_{-1}^1 \int_{-1}^1 -2 \, dx \, dy \, dz = -2(2^3) = -16$$

$$6. \frac{\partial}{\partial x}(x^2) = 2x, \frac{\partial}{\partial y}(y^2) = 2y, \frac{\partial}{\partial z}(z^2) = 2z \Rightarrow \nabla \cdot \mathbf{F} = 2x + 2y + 2z$$

$$\begin{aligned} \text{(a) Flux} &= \int_0^1 \int_0^1 \int_0^1 (2x + 2y + 2z) \, dx \, dy \, dz = \int_0^1 \int_0^1 [x^2 + 2x(y + z)]_0^1 \, dy \, dz = \int_0^1 \int_0^1 (1 + 2y + 2z) \, dy \, dz \\ &= \int_0^1 [y(1 + 2z) + y^2]_0^1 \, dz = \int_0^1 (2 + 2z) \, dz = [2z + z^2]_0^1 = 3 \end{aligned}$$

$$\begin{aligned} \text{(b) Flux} &= \int_{-1}^1 \int_{-1}^1 \int_{-1}^1 (2x + 2y + 2z) \, dx \, dy \, dz = \int_{-1}^1 \int_{-1}^1 [x^2 + 2x(y + z)]_{-1}^1 \, dy \, dz = \int_{-1}^1 \int_{-1}^1 (4y + 4z) \, dy \, dz \\ &= \int_{-1}^1 [2y^2 + 4yz]_{-1}^1 \, dz = \int_{-1}^1 8z \, dz = [4z^2]_{-1}^1 = 0 \end{aligned}$$

$$\text{(c) In cylindrical coordinates, Flux} = \iiint_D (2x + 2y + 2z) \, dx \, dy \, dz$$

$$\begin{aligned} &= \int_0^1 \int_0^{2\pi} \int_0^2 (2r \cos \theta + 2r \sin \theta + 2z) r \, dr \, d\theta \, dz = \int_0^1 \int_0^{2\pi} \left[\frac{2}{3} r^3 \cos \theta + \frac{2}{3} r^3 \sin \theta + zr^2 \right]_0^2 \, d\theta \, dz \\ &= \int_0^1 \int_0^{2\pi} \left(\frac{16}{3} \cos \theta + \frac{16}{3} \sin \theta + 4z \right) \, d\theta \, dz = \int_0^1 \left[\frac{16}{3} \sin \theta - \frac{16}{3} \cos \theta + 4z\theta \right]_0^{2\pi} \, dz = \int_0^1 8\pi z \, dz = [4\pi z^2]_0^1 = 4\pi \end{aligned}$$

$$7. \frac{\partial}{\partial x}(y) = 0, \frac{\partial}{\partial y}(xy) = x, \frac{\partial}{\partial z}(-z) = -1 \Rightarrow \nabla \cdot \mathbf{F} = x - 1; z = x^2 + y^2 \Rightarrow z = r^2 \text{ in cylindrical coordinates}$$

$$\Rightarrow \text{Flux} = \iiint_D (x - 1) \, dz \, dy \, dx = \int_0^{2\pi} \int_0^2 \int_0^{r^2} (r \cos \theta - 1) \, dz \, r \, dr \, d\theta = \int_0^{2\pi} \int_0^2 (r^3 \cos \theta - r^2) \, r \, dr \, d\theta$$

$$= \int_0^{2\pi} \left[\frac{r^5}{5} \cos \theta - \frac{r^4}{4} \right]_0^2 \, d\theta = \int_0^{2\pi} \left(\frac{32}{5} \cos \theta - 4 \right) \, d\theta = \left[\frac{32}{5} \sin \theta - 4\theta \right]_0^{2\pi} = -8\pi$$

8. $\frac{\partial}{\partial x}(x^2) = 2x, \frac{\partial}{\partial y}(xz) = 0, \frac{\partial}{\partial z}(3z) = 3 \Rightarrow \nabla \cdot \mathbf{F} = 2x + 3 \Rightarrow \text{Flux} = \iiint_D (2x+3) dV$
 $= \int_0^{2\pi} \int_0^\pi \int_0^2 (2\rho \sin \phi \cos \theta + 3)(\rho^2 \sin \phi) d\rho d\phi d\theta = \int_0^{2\pi} \int_0^\pi \left[\frac{\rho^4}{2} \sin \phi \cos \theta + \rho^3 \right]_0^2 \sin \phi d\phi d\theta$
 $= \int_0^{2\pi} \int_0^\pi (8 \sin \phi \cos \theta + 8) \sin \phi d\phi d\theta = \int_0^{2\pi} \left[8 \left(\frac{\phi}{2} - \frac{\sin 2\phi}{4} \right) \cos \theta - 8 \cos \phi \right]_0^\pi d\theta = \int_0^{2\pi} (4\pi \cos \theta + 16) d\theta = 32\pi$
9. $\frac{\partial}{\partial x}(x^2) = 2x, \frac{\partial}{\partial y}(-2xy) = -2x, \frac{\partial}{\partial z}(3xz) = 3x \Rightarrow \text{Flux} = \iiint_D 3x dx dy dz$
 $= \int_0^{\pi/2} \int_0^{\pi/2} \int_0^2 (3\rho \sin \phi \cos \theta)(\rho^2 \sin \phi) d\rho d\phi d\theta = \int_0^{\pi/2} \int_0^{\pi/2} 12 \sin^2 \phi \cos \theta d\phi d\theta = \int_0^{\pi/2} 3\pi \cos \theta d\theta = 3\pi$
10. $\frac{\partial}{\partial x}(6x^2 + 2xy) = 12x + 2y, \frac{\partial}{\partial y}(2y + x^2z) = 2, \frac{\partial}{\partial z}(4x^2y^3) = 0 \Rightarrow \nabla \cdot \mathbf{F} = 12x + 2y + 2$
 $\Rightarrow \text{Flux} = \iiint_D (12x + 2y + 2) dV = \int_0^3 \int_0^{\pi/2} \int_0^2 (12r \cos \theta + 2r \sin \theta + 2) r dr d\theta dz$
 $= \int_0^3 \int_0^{\pi/2} \left(32 \cos \theta + \frac{16}{3} \sin \theta + 4 \right) d\theta dz = \int_0^3 \left(32 + 2\pi + \frac{16}{3} \right) dz = 112 + 6\pi$
11. $\frac{\partial}{\partial x}(2xz) = 2z, \frac{\partial}{\partial y}(-xy) = -x, \frac{\partial}{\partial z}(-z^2) = -2z \Rightarrow \nabla \cdot \mathbf{F} = -x \Rightarrow \text{Flux} = \iiint_D -x dV$
 $= \int_0^2 \int_0^{\sqrt{16-4x^2}} \int_0^{4-y} (-x) dz dy dx = \int_0^2 \int_0^{\sqrt{16-4x^2}} (xy - 4x) dy dx = \int_0^2 \left[\frac{1}{2} x (16 - 4x^2) - 4x\sqrt{16 - 4x^2} \right] dx$
 $= \left[4x^2 - \frac{1}{2}x^4 + \frac{1}{3}(16 - 4x^2)^{3/2} \right]_0^2 = -\frac{40}{3}$
12. $\frac{\partial}{\partial x}(x^3) = 3x^2, \frac{\partial}{\partial y}(y^3) = 3y^2, \frac{\partial}{\partial z}(z^3) = 3z^2 \Rightarrow \nabla \cdot \mathbf{F} = 3x^2 + 3y^2 + 3z^2 \Rightarrow \text{Flux} = \iiint_D 3(x^2 + y^2 + z^2) dV$
 $= 3 \int_0^{2\pi} \int_0^\pi \int_0^a \rho^2 (\rho^2 \sin \phi) d\rho d\phi d\theta = 3 \int_0^{2\pi} \int_0^\pi \frac{a^5}{5} \sin \phi d\phi d\theta = 3 \int_0^{2\pi} \frac{2a^5}{5} d\theta = \frac{12\pi a^5}{5}$
13. Let $\rho = \sqrt{x^2 + y^2 + z^2}$. Then $\frac{\partial \rho}{\partial x} = \frac{x}{\rho}, \frac{\partial \rho}{\partial y} = \frac{y}{\rho}, \frac{\partial \rho}{\partial z} = \frac{z}{\rho} \Rightarrow \frac{\partial}{\partial x}(\rho x) = \left(\frac{\partial \rho}{\partial x} \right) x + \rho = \frac{x^2}{\rho} + \rho,$
 $\frac{\partial}{\partial y}(\rho y) = \left(\frac{\partial \rho}{\partial y} \right) y + \rho = \frac{y^2}{\rho} + \rho, \frac{\partial}{\partial z}(\rho z) = \left(\frac{\partial \rho}{\partial z} \right) z + \rho = \frac{z^2}{\rho} + \rho \Rightarrow \nabla \cdot \mathbf{F} = \frac{x^2 + y^2 + z^2}{\rho} + 3\rho = 4\rho,$ since
 $\rho = \sqrt{x^2 + y^2 + z^2} \Rightarrow \text{Flux} = \iiint_D 4\rho dV = \int_0^{2\pi} \int_0^\pi \int_1^{\sqrt{2}} (4\rho)(\rho^2 \sin \phi) d\rho d\phi d\theta = \int_0^{2\pi} \int_0^\pi 3 \sin \phi d\phi d\theta$
 $= \int_0^{2\pi} 6 d\theta = 12\pi$

14. Let $\rho = \sqrt{x^2 + y^2 + z^2}$. Then $\frac{\partial \rho}{\partial x} = \frac{x}{\rho}$, $\frac{\partial \rho}{\partial y} = \frac{y}{\rho}$, $\frac{\partial \rho}{\partial z} = \frac{z}{\rho} \Rightarrow \frac{\partial}{\partial x} \left(\frac{x}{\rho} \right) = \frac{1}{\rho} - \left(\frac{x}{\rho^2} \right) \frac{\partial \rho}{\partial x} = \frac{1}{\rho} - \frac{x^2}{\rho^3}$. Similarly,

$$\frac{\partial}{\partial y} \left(\frac{y}{\rho} \right) = \frac{1}{\rho} - \frac{y^2}{\rho^3} \text{ and } \frac{\partial}{\partial z} \left(\frac{z}{\rho} \right) = \frac{1}{\rho} - \frac{z^2}{\rho^3} \Rightarrow \nabla \cdot \mathbf{F} = \frac{3}{\rho} - \frac{x^2 + y^2 + z^2}{\rho^3} = \frac{2}{\rho}$$

$$\Rightarrow \text{Flux} = \iiint_D \frac{2}{\rho} dV = \int_0^{2\pi} \int_0^\pi \int_1^2 \left(\frac{2}{\rho} \right) (\rho^2 \sin \phi) d\rho d\phi d\theta = \int_0^{2\pi} \int_0^\pi 3 \sin \phi d\phi d\theta = \int_0^{2\pi} 6 d\theta = 12\pi$$

15. $\frac{\partial}{\partial x} (5x^3 + 12xy^2) = 15x^2 + 12y^2$, $\frac{\partial}{\partial y} (y^3 + e^y \sin z) = 3y^2 + e^y \sin z$, $\frac{\partial}{\partial z} (5z^3 + e^y \cos z) = 15z^2 - e^y \sin z$

$$\Rightarrow \nabla \cdot \mathbf{F} = 15x^2 + 15y^2 + 15z^2 = 15\rho^2 \Rightarrow \text{Flux} = \iiint_D 15\rho^2 dV = \int_0^{2\pi} \int_0^\pi \int_1^{\sqrt{2}} (15\rho^2) (\rho^2 \sin \phi) d\rho d\phi d\theta$$

$$= \int_0^{2\pi} \int_0^\pi (12\sqrt{2} - 3) \sin \phi d\phi d\theta = \int_0^{2\pi} (24\sqrt{2} - 6) d\theta = (48\sqrt{2} - 12)\pi$$

16. $\frac{\partial}{\partial x} \left[\ln(x^2 + y^2) \right] = \frac{2x}{x^2 + y^2}$, $\frac{\partial}{\partial y} \left(-\frac{2z}{x} \tan^{-1} \frac{y}{x} \right) = \left(-\frac{2z}{x} \right) \left[\frac{\left(\frac{1}{x} \right)}{1 + \left(\frac{y}{x} \right)^2} \right] = -\frac{2z}{x^2 + y^2}$, $\frac{\partial}{\partial z} \left(z\sqrt{x^2 + y^2} \right) = \sqrt{x^2 + y^2}$

$$\Rightarrow \nabla \cdot \mathbf{F} = \frac{2x}{x^2 + y^2} - \frac{2z}{x^2 + y^2} + \sqrt{x^2 + y^2} \Rightarrow \text{Flux} = \iiint_D \left(\frac{2x}{x^2 + y^2} - \frac{2z}{x^2 + y^2} + \sqrt{x^2 + y^2} \right) dz dy dx$$

$$= \int_0^{2\pi} \int_1^{\sqrt{2}} \int_{-1}^2 \left(\frac{2r \cos \theta}{r^2} - \frac{2z}{r^2} + r \right) dz r dr d\theta = \int_0^{2\pi} \int_1^{\sqrt{2}} \left(6 \cos \theta - \frac{3}{r} + 3r^2 \right) dr d\theta$$

$$= \int_0^{2\pi} \left[6(\sqrt{2} - 1) \cos \theta - 3 \ln \sqrt{2} + 2\sqrt{2} - 1 \right] d\theta = 2\pi \left(-\frac{3}{2} \ln 2 + 2\sqrt{2} - 1 \right)$$

17. (a) $\frac{\partial}{\partial x}(x) = 1$, $\frac{\partial}{\partial y}(y) = 1$, $\frac{\partial}{\partial z}(z) = 1 \Rightarrow \nabla \cdot \mathbf{F} = 3 \Rightarrow \text{Flux} = \iiint_D 3 dV = 3 \iiint_D dV = 3$ (Volume of the solid)

(b) If \mathbf{F} is orthogonal to \mathbf{n} at every point of S , then $\mathbf{F} \cdot \mathbf{n} = 0$ everywhere $\Rightarrow \text{Flux} = \iint_S \mathbf{F} \cdot \mathbf{n} d\sigma = 0$. But the

flux is 3 (Volume of the solid) $\neq 0$, so \mathbf{F} is not orthogonal to \mathbf{n} at every point.

18. Yes, the outward flux through the top is 5. The reason is this: Since $\nabla \cdot \mathbf{F} = \nabla \cdot (x\mathbf{i} - 2y\mathbf{j} + (z+3)\mathbf{k}) = 1 - 2 + 1 = 0$, the outward flux across the closed cubelike surface is 0 by the Divergence Theorem. The flux across the top is therefore the negative of the flux across the sides and base. Routine calculations show that the sum of these latter fluxes is -5 . (The flux across the sides that lie in the xz -plane and the yz -plane are 0, while the flux across the xy -plane is -3 .) Therefore the flux across the top is 5.

19. For the field $\mathbf{F} = (y \cos 2x)\mathbf{i} + (y^2 \sin 2x)\mathbf{j} + (x^2 y + x)\mathbf{k}$, $\nabla \cdot \mathbf{F} = -2y \sin 2x + 2y \sin 2x + 1 = 1$. If \mathbf{F} were the curl of a field \mathbf{A} whose component functions have continuous second partial derivatives, then we would have $\text{div } \mathbf{F} = \text{div}(\text{curl } \mathbf{A}) = \nabla \cdot (\nabla \times \mathbf{A}) = 0$. Since $\text{div } \mathbf{F} = 1$, \mathbf{F} is not the curl of such a field.

20. From the Divergence Theorem, $\iint_S \nabla f \cdot \mathbf{n} d\sigma = \iiint_D \nabla \cdot \nabla f dV = \iiint_D \left(\frac{\partial^2 f}{\partial x^2} + \frac{\partial^2 f}{\partial y^2} + \frac{\partial^2 f}{\partial z^2} \right) dV$. Now,

$$f(x, y, z) = \ln \sqrt{x^2 + y^2 + z^2} = \frac{1}{2} \ln(x^2 + y^2 + z^2) \Rightarrow \frac{\partial f}{\partial x} = \frac{x}{x^2 + y^2 + z^2}, \frac{\partial f}{\partial y} = \frac{y}{x^2 + y^2 + z^2}, \frac{\partial f}{\partial z} = \frac{z}{x^2 + y^2 + z^2}$$

$$\Rightarrow \frac{\partial^2 f}{\partial x^2} = \frac{-x^2 + y^2 + z^2}{(x^2 + y^2 + z^2)^2}, \frac{\partial^2 f}{\partial y^2} = \frac{x^2 - y^2 + z^2}{(x^2 + y^2 + z^2)^2}, \frac{\partial^2 f}{\partial z^2} = \frac{x^2 + y^2 - z^2}{(x^2 + y^2 + z^2)^2}, \Rightarrow \frac{\partial^2 f}{\partial x^2} + \frac{\partial^2 f}{\partial y^2} + \frac{\partial^2 f}{\partial z^2} = \frac{x^2 + y^2 + z^2}{(x^2 + y^2 + z^2)^2} = \frac{1}{x^2 + y^2 + z^2}$$

$$\begin{aligned} \Rightarrow \iint_S \nabla f \cdot \mathbf{n} \, d\sigma &= \iiint_D \frac{dV}{x^2+y^2+z^2} = \int_0^{\pi/2} \int_0^{\pi/2} \int_0^a \frac{\rho^2 \sin \phi}{\rho^2} \, d\rho \, d\phi \, d\theta = \int_0^{\pi/2} \int_0^{\pi/2} a \sin \phi \, d\phi \, d\theta \\ &= \int_0^{\pi/2} [-a \cos \phi]_0^{\pi/2} \, d\theta = \int_0^{\pi/2} a \, d\theta = \frac{\pi a}{2} \end{aligned}$$

21. The integral's value never exceeds the surface area of S . Since $|\mathbf{F}| \leq 1$, we have $|\mathbf{F} \cdot \mathbf{n}| = |\mathbf{F}| |\mathbf{n}| \leq (1)(1) = 1$ and

$$\begin{aligned} \iint_D \nabla \cdot \mathbf{F} \, d\sigma &= \iint_S \mathbf{F} \cdot \mathbf{n} \, d\sigma && \text{[Divergence Theorem]} \\ &\leq \iint_S |\mathbf{F} \cdot \mathbf{n}| \, d\sigma && \text{[A property of integrals]} \\ &\leq \iint_S (1) \, d\sigma && \text{[}|\mathbf{F} \cdot \mathbf{n}| \leq 1\text{]} \\ &= \text{Area of } S. \end{aligned}$$

22. $\nabla \cdot \mathbf{F} = -2x - 4y - 6z + 12 \Rightarrow \text{Flux} = \int_0^a \int_0^b \int_0^1 (-2x - 4y - 6z + 12) \, dz \, dy \, dx = \int_0^a \int_0^b (-2x - 4y + 9) \, dy \, dx = \int_0^a (-2xb - 2b^2 + 9b) \, dx = -a^2b - 2ab^2 + 9ab = ab(-a - 2b + 9) = f(a, b); \frac{\partial f}{\partial a} = -2ab - 2b^2 + 9b$ and $\frac{\partial f}{\partial b} = -a^2 - 4ab + 9a$ so that $\frac{\partial f}{\partial a} = 0$ and $\frac{\partial f}{\partial b} = 0 \Rightarrow b(-2a - 2b + 9) = 0$ and $a(-a - 4b + 9) = 0 \Rightarrow b = 0$ or $-2a - 2b + 9 = 0$, and $a = 0$ or $-a - 4b + 9 = 0$. Now $b = 0$ or $a = 0 \Rightarrow \text{Flux} = 0; -2a - 2b + 9 = 0$ and $-a - 4b + 9 = 0 \Rightarrow 3a - 9 = 0 \Rightarrow a = 3 \Rightarrow b = \frac{3}{2}$ so that $f\left(3, \frac{3}{2}\right) = \frac{27}{2}$ is the maximum flux.

23. By the Divergence Theorem, the net outward flux of the field $\mathbf{F} = xy\mathbf{i} + (\sin xz + y^2)\mathbf{j} + (e^{xy^2} + x)\mathbf{k}$ over the surface S will be equal to the integral of $\nabla \cdot \mathbf{F} = y + 2y = 3y$ over the region D bounded by S . We will integrate using the area in the xz -plane bounded by $z = 0$ and $z = 1 - x^2$ as the base. The y height at any point (x, z) will be $2 - z$. Thus the integral of $\text{div } \mathbf{F}$ over D is

$$\begin{aligned} \int_{-1}^1 \int_0^{1-x^2} \int_0^{2-z} 3y \, dy \, dz \, dx &= \int_{-1}^1 \int_0^{1-x^2} \left[\frac{3}{2} y^2 \right]_0^{2-z} \, dz \, dx = \int_{-1}^1 \int_0^{1-x^2} \frac{3}{2} (2-z)^2 \, dz \, dx \\ &= \int_{-1}^1 \left[-\frac{1}{2} (2-z)^3 \right]_0^{1-x^2} \, dx = \int_{-1}^1 4 - \frac{1}{2} (x^2 + 1)^3 \, dx = \left(\frac{7}{2} x - \frac{1}{3} x^3 - \frac{3}{10} x^5 - \frac{1}{14} x^7 \right) \Big|_{-1}^1 = \frac{184}{35} \end{aligned}$$

24. The field $\mathbf{F} = (x\mathbf{i} + y\mathbf{j} + z\mathbf{k}) / (x^2 + y^2 + z^2)^{3/2}$ is discussed in Example 5 in Section 16.8, where we show that the flux of \mathbf{F} across any closed surface enclosing the origin is 4π . Note that the divergence of \mathbf{F} is not defined at the origin, so we need an argument like that shown in Example 5.

25. (a) $\text{div}(\mathbf{gF}) = \nabla \cdot \mathbf{gF} = \frac{\partial}{\partial x}(gM) + \frac{\partial}{\partial y}(gN) + \frac{\partial}{\partial z}(gP) = \left(g \frac{\partial M}{\partial x} + M \frac{\partial g}{\partial x} \right) + \left(g \frac{\partial N}{\partial y} + N \frac{\partial g}{\partial y} \right) + \left(g \frac{\partial P}{\partial z} + P \frac{\partial g}{\partial z} \right)$
 $= \left(M \frac{\partial g}{\partial x} + N \frac{\partial g}{\partial y} + P \frac{\partial g}{\partial z} \right) + g \left(\frac{\partial M}{\partial x} + \frac{\partial N}{\partial y} + \frac{\partial P}{\partial z} \right) = g \nabla \cdot \mathbf{F} + \nabla g \cdot \mathbf{F}$

$$\begin{aligned}
 \text{(b)} \quad \nabla \times (\mathbf{gF}) &= \left[\frac{\partial}{\partial y}(gP) - \frac{\partial}{\partial z}(gN) \right] \mathbf{i} + \left[\frac{\partial}{\partial z}(gM) - \frac{\partial}{\partial x}(gP) \right] \mathbf{j} + \left[\frac{\partial}{\partial x}(gN) - \frac{\partial}{\partial y}(gM) \right] \mathbf{k} \\
 &= \left(P \frac{\partial g}{\partial y} + g \frac{\partial P}{\partial y} - N \frac{\partial g}{\partial z} - g \frac{\partial N}{\partial z} \right) \mathbf{i} + \left(M \frac{\partial g}{\partial z} + g \frac{\partial M}{\partial z} - P \frac{\partial g}{\partial x} - g \frac{\partial P}{\partial x} \right) \mathbf{j} + \left(N \frac{\partial g}{\partial x} + g \frac{\partial N}{\partial x} - M \frac{\partial g}{\partial y} - g \frac{\partial M}{\partial y} \right) \mathbf{k} \\
 &= \left(P \frac{\partial g}{\partial y} - N \frac{\partial g}{\partial z} \right) \mathbf{i} + \left(g \frac{\partial P}{\partial y} - g \frac{\partial N}{\partial z} \right) \mathbf{i} + \left(M \frac{\partial g}{\partial z} - P \frac{\partial g}{\partial x} \right) \mathbf{j} + \left(g \frac{\partial M}{\partial z} - g \frac{\partial P}{\partial x} \right) \mathbf{j} + \left(N \frac{\partial g}{\partial x} - M \frac{\partial g}{\partial y} \right) \mathbf{k} + \left(g \frac{\partial N}{\partial x} - g \frac{\partial M}{\partial y} \right) \mathbf{k} \\
 &= g \nabla \times \mathbf{F} + \nabla g \times \mathbf{F}
 \end{aligned}$$

26. (a) Let $\mathbf{F}_1 = M_1\mathbf{i} + N_1\mathbf{j} + P_1\mathbf{k}$ and $\mathbf{F}_2 = M_2\mathbf{i} + N_2\mathbf{j} + P_2\mathbf{k}$

$$\begin{aligned}
 &\Rightarrow a\mathbf{F}_1 + b\mathbf{F}_2 = (aM_1 + bM_2)\mathbf{i} + (aN_1 + bN_2)\mathbf{j} + (aP_1 + bP_2)\mathbf{k} \\
 &\Rightarrow \nabla \cdot (a\mathbf{F}_1 + b\mathbf{F}_2) = \left(a \frac{\partial M_1}{\partial x} + b \frac{\partial M_2}{\partial x} \right) + \left(a \frac{\partial N_1}{\partial y} + b \frac{\partial N_2}{\partial y} \right) + \left(a \frac{\partial P_1}{\partial z} + b \frac{\partial P_2}{\partial z} \right) \\
 &= a \left(\frac{\partial M_1}{\partial x} + \frac{\partial N_1}{\partial y} + \frac{\partial P_1}{\partial z} \right) + b \left(\frac{\partial M_2}{\partial x} + \frac{\partial N_2}{\partial y} + \frac{\partial P_2}{\partial z} \right) = a(\nabla \cdot \mathbf{F}_1) + b(\nabla \cdot \mathbf{F}_2)
 \end{aligned}$$

(b) Define \mathbf{F}_1 and \mathbf{F}_2 as in part a

$$\begin{aligned}
 &\Rightarrow \nabla \times (a\mathbf{F}_1 + b\mathbf{F}_2) = \left[\left(a \frac{\partial P_1}{\partial y} + b \frac{\partial P_2}{\partial y} \right) - \left(a \frac{\partial N_1}{\partial z} + b \frac{\partial N_2}{\partial z} \right) \right] \mathbf{i} + \left[\left(a \frac{\partial M_1}{\partial z} + b \frac{\partial M_2}{\partial z} \right) - \left(a \frac{\partial P_1}{\partial x} + b \frac{\partial P_2}{\partial x} \right) \right] \mathbf{j} \\
 &\quad + \left[\left(a \frac{\partial N_1}{\partial x} + b \frac{\partial N_2}{\partial x} \right) - \left(a \frac{\partial M_1}{\partial y} + b \frac{\partial M_2}{\partial y} \right) \right] \mathbf{k} \\
 &= a \left[\left(\frac{\partial P_1}{\partial y} - \frac{\partial N_1}{\partial z} \right) \mathbf{i} + \left(\frac{\partial M_1}{\partial z} - \frac{\partial P_1}{\partial x} \right) \mathbf{j} + \left(\frac{\partial N_1}{\partial x} - \frac{\partial M_1}{\partial y} \right) \mathbf{k} \right] + b \left[\left(\frac{\partial P_2}{\partial y} - \frac{\partial N_2}{\partial z} \right) \mathbf{i} + \left(\frac{\partial M_2}{\partial z} - \frac{\partial P_2}{\partial x} \right) \mathbf{j} + \left(\frac{\partial N_2}{\partial x} - \frac{\partial M_2}{\partial y} \right) \mathbf{k} \right] \\
 &= a \nabla \times \mathbf{F}_1 + b \nabla \times \mathbf{F}_2
 \end{aligned}$$

(c) $\mathbf{F}_1 \times \mathbf{F}_2 = \begin{vmatrix} \mathbf{i} & \mathbf{j} & \mathbf{k} \\ M_1 & N_1 & P_1 \\ M_2 & N_2 & P_2 \end{vmatrix} = (N_1P_2 - P_1N_2)\mathbf{i} - (M_1P_2 - P_1M_2)\mathbf{j} + (M_1N_2 - N_1M_2)\mathbf{k}$

$$\begin{aligned}
 &\Rightarrow \nabla \cdot (\mathbf{F}_1 \times \mathbf{F}_2) = \nabla \cdot \left[(N_1P_2 - P_1N_2)\mathbf{i} - (M_1P_2 - P_1M_2)\mathbf{j} + (M_1N_2 - N_1M_2)\mathbf{k} \right] \\
 &= \frac{\partial}{\partial x}(N_1P_2 - P_1N_2) - \frac{\partial}{\partial y}(M_1P_2 - P_1M_2) + \frac{\partial}{\partial z}(M_1N_2 - N_1M_2) \\
 &= \left(P_2 \frac{\partial N_1}{\partial x} + N_1 \frac{\partial P_2}{\partial x} - N_2 \frac{\partial P_1}{\partial x} - P_1 \frac{\partial N_2}{\partial x} \right) - \left(M_1 \frac{\partial P_2}{\partial y} + P_2 \frac{\partial M_1}{\partial y} - P_1 \frac{\partial M_2}{\partial y} - M_2 \frac{\partial P_1}{\partial y} \right) \\
 &\quad + \left(M_1 \frac{\partial N_2}{\partial z} + N_2 \frac{\partial M_1}{\partial z} - N_1 \frac{\partial M_2}{\partial z} - M_2 \frac{\partial N_1}{\partial z} \right) \\
 &= M_2 \left(\frac{\partial P_1}{\partial y} - \frac{\partial N_1}{\partial z} \right) + N_2 \left(\frac{\partial M_1}{\partial z} - \frac{\partial P_1}{\partial x} \right) + P_2 \left(\frac{\partial N_1}{\partial x} - \frac{\partial M_1}{\partial y} \right) + M_1 \left(\frac{\partial N_2}{\partial z} - \frac{\partial P_2}{\partial y} \right) + N_1 \left(\frac{\partial P_2}{\partial x} - \frac{\partial M_2}{\partial z} \right) + P_1 \left(\frac{\partial M_2}{\partial y} - \frac{\partial N_2}{\partial x} \right) \\
 &= \mathbf{F}_2 \cdot \nabla \times \mathbf{F}_1 - \mathbf{F}_1 \cdot \nabla \times \mathbf{F}_2
 \end{aligned}$$

27. Let $\mathbf{F}_1 = M_1\mathbf{i} + N_1\mathbf{j} + P_1\mathbf{k}$ and $\mathbf{F}_2 = M_2\mathbf{i} + N_2\mathbf{j} + P_2\mathbf{k}$.

(a) $\mathbf{F}_1 \times \mathbf{F}_2 = (N_1P_2 - P_1N_2)\mathbf{i} + (P_1M_2 - M_1P_2)\mathbf{j} + (M_1N_2 - N_1M_2)\mathbf{k}$

$$\begin{aligned}
 &\Rightarrow \nabla \times (\mathbf{F}_1 \times \mathbf{F}_2) = \left[\frac{\partial}{\partial y}(M_1N_2 - N_1M_2) - \frac{\partial}{\partial z}(P_1M_2 - M_1P_2) \right] \mathbf{i} + \left[\frac{\partial}{\partial z}(N_1P_2 - P_1N_2) - \frac{\partial}{\partial x}(M_1N_2 - N_1M_2) \right] \mathbf{j} \\
 &\quad + \left[\frac{\partial}{\partial x}(P_1M_2 - M_1P_2) - \frac{\partial}{\partial y}(N_1P_2 - P_1N_2) \right] \mathbf{k}
 \end{aligned}$$

consider the \mathbf{i} -component only: $\frac{\partial}{\partial y}(M_1N_2 - N_1M_2) - \frac{\partial}{\partial z}(P_1M_2 - M_1P_2)$

$$\begin{aligned}
 &= N_2 \frac{\partial M_1}{\partial y} + M_1 \frac{\partial N_2}{\partial y} - M_2 \frac{\partial N_1}{\partial y} - N_1 \frac{\partial M_2}{\partial y} - M_2 \frac{\partial P_1}{\partial z} - P_1 \frac{\partial M_2}{\partial z} + P_2 \frac{\partial M_1}{\partial z} + M_1 \frac{\partial P_2}{\partial z} \\
 &= \left(N_2 \frac{\partial M_1}{\partial y} + P_2 \frac{\partial M_1}{\partial z} \right) - \left(N_1 \frac{\partial M_2}{\partial y} + P_1 \frac{\partial M_2}{\partial z} \right) + \left(\frac{\partial N_2}{\partial y} + \frac{\partial P_2}{\partial z} \right) M_1 - \left(\frac{\partial N_1}{\partial y} + \frac{\partial P_1}{\partial z} \right) M_2
 \end{aligned}$$

$$= \left(M_2 \frac{\partial M_1}{\partial x} + N_2 \frac{\partial M_1}{\partial y} + P_2 \frac{\partial M_1}{\partial z} \right) - \left(M_1 \frac{\partial M_2}{\partial x} + N_1 \frac{\partial M_2}{\partial y} + P_1 \frac{\partial M_2}{\partial z} \right) + \left(\frac{\partial M_2}{\partial x} + \frac{\partial N_2}{\partial y} + \frac{\partial P_2}{\partial z} \right) M_1 - \left(\frac{\partial M_1}{\partial x} + \frac{\partial N_1}{\partial y} + \frac{\partial P_1}{\partial z} \right) M_2$$

Now, **i**-comp of $(\mathbf{F}_2 \cdot \nabla) \mathbf{F}_1 = \left(M_2 \frac{\partial}{\partial x} + N_2 \frac{\partial}{\partial y} + P_2 \frac{\partial}{\partial z} \right) M_1 = \left(M_2 \frac{\partial M_1}{\partial x} + N_2 \frac{\partial M_1}{\partial y} + P_2 \frac{\partial M_1}{\partial z} \right)$;

likewise, **i**-comp of $(\mathbf{F}_1 \cdot \nabla) \mathbf{F}_2 = \left(M_1 \frac{\partial M_2}{\partial x} + N_1 \frac{\partial M_2}{\partial y} + P_1 \frac{\partial M_2}{\partial z} \right)$;

i comp of $(\nabla \cdot \mathbf{F}_2) \mathbf{F}_1 = \left(\frac{\partial M_2}{\partial x} + \frac{\partial N_2}{\partial y} + \frac{\partial P_2}{\partial z} \right) M_1$ and **i**-comp of $(\nabla \cdot \mathbf{F}_1) \mathbf{F}_2 = \left(\frac{\partial M_1}{\partial x} + \frac{\partial N_1}{\partial y} + \frac{\partial P_1}{\partial z} \right) M_2$.

Similar results hold for the **j** and **k** components of $\nabla \times (\mathbf{F}_1 \times \mathbf{F}_2)$. In summary, since the corresponding components are equal, we have the result $\nabla \times (\mathbf{F}_1 \times \mathbf{F}_2) = (\mathbf{F}_2 \cdot \nabla) \mathbf{F}_1 - (\mathbf{F}_1 \cdot \nabla) \mathbf{F}_2 + (\nabla \cdot \mathbf{F}_2) \mathbf{F}_1 - (\nabla \cdot \mathbf{F}_1) \mathbf{F}_2$

(b) Here again we consider only the **i**-component of each expression. Thus, the **i**-comp of $\nabla (\mathbf{F}_1 \cdot \mathbf{F}_2)$

$$= \frac{\partial}{\partial x} (M_1 M_2 + N_1 N_2 + P_1 P_2) = \left(M_1 \frac{\partial M_2}{\partial x} + M_2 \frac{\partial M_1}{\partial x} + N_1 \frac{\partial N_2}{\partial x} + N_2 \frac{\partial N_1}{\partial x} + P_1 \frac{\partial P_2}{\partial x} + P_2 \frac{\partial P_1}{\partial x} \right)$$

i-comp of $(\mathbf{F}_1 \cdot \nabla) \mathbf{F}_2 = \left(M_1 \frac{\partial M_2}{\partial x} + N_1 \frac{\partial M_2}{\partial y} + P_1 \frac{\partial M_2}{\partial z} \right)$,

i-comp of $(\mathbf{F}_2 \cdot \nabla) \mathbf{F}_1 = \left(M_2 \frac{\partial M_1}{\partial x} + N_2 \frac{\partial M_1}{\partial y} + P_2 \frac{\partial M_1}{\partial z} \right)$,

i-comp of $\mathbf{F}_1 \times (\nabla \times \mathbf{F}_2) = N_1 \left(\frac{\partial N_2}{\partial x} - \frac{\partial M_2}{\partial y} \right) - P_1 \left(\frac{\partial M_2}{\partial z} - \frac{\partial P_2}{\partial x} \right)$, and

i-comp of $\mathbf{F}_2 \times (\nabla \times \mathbf{F}_1) = N_2 \left(\frac{\partial N_1}{\partial x} - \frac{\partial M_1}{\partial y} \right) - P_2 \left(\frac{\partial M_1}{\partial z} - \frac{\partial P_1}{\partial x} \right)$.

Since corresponding components are equal, we see that

$$\nabla (\mathbf{F}_1 \cdot \mathbf{F}_2) = (\mathbf{F}_1 \cdot \nabla) \mathbf{F}_2 + (\mathbf{F}_2 \cdot \nabla) \mathbf{F}_1 + \mathbf{F}_1 \times (\nabla \times \mathbf{F}_2) + \mathbf{F}_2 \times (\nabla \times \mathbf{F}_1), \text{ as claimed.}$$

28. (a) From the Divergence Theorem, $\iint_S \nabla f \cdot \mathbf{n} d\sigma = \iiint_D \nabla \cdot \nabla f dV = \iiint_D (\nabla^2 f) dV = \iiint_D 0 dV = 0$

(b) From the Divergence Theorem, $\iint_S f \nabla f \cdot \mathbf{n} d\sigma = \iiint_D \nabla \cdot f \nabla f dV$. Now,

$$\begin{aligned} f \nabla f &= \left(f \frac{\partial f}{\partial x} \right) \mathbf{i} + \left(f \frac{\partial f}{\partial y} \right) \mathbf{j} + \left(f \frac{\partial f}{\partial z} \right) \mathbf{k} \Rightarrow \nabla \cdot f \nabla f = \left[f \frac{\partial^2 f}{\partial x^2} + \left(\frac{\partial f}{\partial x} \right)^2 \right] + \left[f \frac{\partial^2 f}{\partial y^2} + \left(\frac{\partial f}{\partial y} \right)^2 \right] + \left[f \frac{\partial^2 f}{\partial z^2} + \left(\frac{\partial f}{\partial z} \right)^2 \right] \\ &= f \nabla^2 f + |\nabla f|^2 = 0 + |\nabla f|^2 \text{ since } f \text{ is harmonic} \Rightarrow \iint_S f \nabla f \cdot \mathbf{n} d\sigma = \iiint_D |\nabla f|^2 dV, \text{ as claimed.} \end{aligned}$$

29. $\iint_S f \nabla g \cdot \mathbf{n} d\sigma = \iiint_D \nabla \cdot f \nabla g dV = \iiint_D \nabla \cdot \left(f \frac{\partial g}{\partial x} \mathbf{i} + f \frac{\partial g}{\partial y} \mathbf{j} + f \frac{\partial g}{\partial z} \mathbf{k} \right) dV$

$$= \iiint_D \left(f \frac{\partial^2 g}{\partial x^2} + \frac{\partial f}{\partial x} \frac{\partial g}{\partial x} + f \frac{\partial^2 g}{\partial y^2} + \frac{\partial f}{\partial y} \frac{\partial g}{\partial y} + f \frac{\partial^2 g}{\partial z^2} + \frac{\partial f}{\partial z} \frac{\partial g}{\partial z} \right) dV$$

$$= \iiint_D \left[f \left(\frac{\partial^2 g}{\partial x^2} + \frac{\partial^2 g}{\partial y^2} + \frac{\partial^2 g}{\partial z^2} \right) + \left(\frac{\partial f}{\partial x} \frac{\partial g}{\partial x} + \frac{\partial f}{\partial y} \frac{\partial g}{\partial y} + \frac{\partial f}{\partial z} \frac{\partial g}{\partial z} \right) \right] dV = \iiint_D \left(f \nabla^2 g + \nabla f \cdot \nabla g \right) dV$$

30. By Exercise 29, $\iint_S f \nabla g \cdot \mathbf{n} \, d\sigma = \iiint_D (f \nabla^2 g + \nabla f \cdot \nabla g) \, dV$ and by interchanging the roles of f and g ,

$$\iint_S g \nabla f \cdot \mathbf{n} \, d\sigma = \iiint_D (g \nabla^2 f + \nabla g \cdot \nabla f) \, dV. \text{ Subtracting the second equation from the first yields:}$$

$$\iint_S (f \nabla g - g \nabla f) \cdot \mathbf{n} \, d\sigma = \iiint_D (f \nabla^2 g - g \nabla^2 f) \, dV \text{ since } \nabla f \cdot \nabla g = \nabla g \cdot \nabla f.$$

31. (a) The integral $\iiint_D p(t, x, y, z) \, dV$ represents the mass of the fluid at any time t . The equation says that the instantaneous rate of change of mass is flux of the fluid through the surface S enclosing the region D : the mass decreases if the flux is outward (so the fluid flows out of D), and increases if the flow is inward (interpreting \mathbf{n} as the outward pointing unit normal to the surface).

(b) $\iiint_D \frac{\partial p}{\partial t} \, dV = \frac{d}{dt} \iiint_D p \, dV = - \iint_S p \mathbf{v} \cdot \mathbf{n} \, d\sigma = - \iiint_D \nabla \cdot p \mathbf{v} \, dV \Rightarrow \frac{\partial p}{\partial t} = - \nabla \cdot p \mathbf{v}$

Since the law is to hold for all regions D , $\nabla \cdot p \mathbf{v} + \frac{\partial p}{\partial t} = 0$, as claimed

32. (a) ∇T points in the direction of maximum change of the temperature, so if the solid is heating up at the point the temperature is greater in a region surrounding the point $\Rightarrow \nabla T$ points away from the point $\Rightarrow -\nabla T$ points toward the point $\Rightarrow -\nabla T$ points in the direction the heat flows.

(b) Assuming the Law of Conservation of Mass (Exercise 31) with $-k \nabla T = p \mathbf{v}$ and $c \rho T = p$, we have

$$\frac{d}{dt} \iiint_D c \rho T \, dV = - \iint_S -k \nabla T \cdot \mathbf{n} \, d\sigma \Rightarrow \text{the continuity equation, } \nabla \cdot (-k \nabla T) + \frac{\partial}{\partial t} (c \rho T) = 0$$

$$\Rightarrow c \rho \frac{\partial T}{\partial t} = - \nabla \cdot (-k \nabla T) = k \nabla^2 T \Rightarrow \frac{\partial T}{\partial t} = \frac{k}{c \rho} \nabla^2 T = K \nabla^2 T, \text{ as claimed}$$

CHAPTER 16 PRACTICE EXERCISES

1. Path 1: $\mathbf{r} = t\mathbf{i} + t\mathbf{j} + t\mathbf{k} \Rightarrow x = t, y = t, z = t, 0 \leq t \leq 1 \Rightarrow f(g(t), h(t), k(t)) = 3 - 3t^2$ and $\frac{dx}{dt} = 1, \frac{dy}{dt} = 1,$

$$\frac{dz}{dt} = 1 \Rightarrow \sqrt{\left(\frac{dx}{dt}\right)^2 + \left(\frac{dy}{dt}\right)^2 + \left(\frac{dz}{dt}\right)^2} dt = \sqrt{3} dt \Rightarrow \int_C f(x, y, z) \, ds = \int_0^1 \sqrt{3} (3 - 3t^2) \, dt = 2\sqrt{3}$$

Path 2: $\mathbf{r}_1 = t\mathbf{i} + t\mathbf{j}, 0 \leq t \leq 1 \Rightarrow x = t, y = t, z = 0 \Rightarrow f(g(t), h(t), k(t)) = 2t - 3t^2 + 3$ and $\frac{dx}{dt} = 1, \frac{dy}{dt} = 1,$

$$\frac{dz}{dt} = 0 \Rightarrow \sqrt{\left(\frac{dx}{dt}\right)^2 + \left(\frac{dy}{dt}\right)^2 + \left(\frac{dz}{dt}\right)^2} dt = \sqrt{2} dt \Rightarrow \int_{C_1} f(x, y, z) \, ds = \int_0^1 \sqrt{2} (2t - 3t^2 + 3) \, dt = 3\sqrt{2};$$

$\mathbf{r}_2 = \mathbf{i} + \mathbf{j} + t\mathbf{k} \Rightarrow x = 1, y = 1, z = t \Rightarrow f(g(t), h(t), k(t)) = 2 - 2t$ and $\frac{dx}{dt} = 0, \frac{dy}{dt} = 0, \frac{dz}{dt} = 1$

$$\Rightarrow \sqrt{\left(\frac{dx}{dt}\right)^2 + \left(\frac{dy}{dt}\right)^2 + \left(\frac{dz}{dt}\right)^2} dt = dt \Rightarrow \int_{C_2} f(x, y, z) \, ds = \int_0^1 (2 - 2t) \, dt = 1$$

$$\Rightarrow \int_C f(x, y, z) \, ds = \int_{C_1} f(x, y, z) \, ds + \int_{C_2} f(x, y, z) \, ds = 3\sqrt{2} + 1$$

2. Path 1: $\mathbf{r}_1 = t\mathbf{i} \Rightarrow x = t, y = 0, z = 0 \Rightarrow f(g(t), h(t), k(t)) = t^2$ and $\frac{dx}{dt} = 1, \frac{dy}{dt} = 0, \frac{dz}{dt} = 0$

$$\Rightarrow \sqrt{\left(\frac{dx}{dt}\right)^2 + \left(\frac{dy}{dt}\right)^2 + \left(\frac{dz}{dt}\right)^2} dt = dt \Rightarrow \int_{C_1} f(x, y, z) \, ds = \int_0^1 t^2 \, dt = \frac{1}{3};$$

$\mathbf{r}_2 = \mathbf{i} + t\mathbf{j} \Rightarrow x = 1, y = t, z = 0 \Rightarrow f(g(t), h(t), k(t)) = 1 + t$ and $\frac{dx}{dt} = 0, \frac{dy}{dt} = 1, \frac{dz}{dt} = 0$

$$\Rightarrow \sqrt{\left(\frac{dx}{dt}\right)^2 + \left(\frac{dy}{dt}\right)^2 + \left(\frac{dz}{dt}\right)^2} dt = dt \Rightarrow \int_{C_2} f(x, y, z) ds = \int_0^1 (1+t) dt = \frac{3}{2};$$

$$\mathbf{r}_3 = \mathbf{i} + \mathbf{j} + t\mathbf{k} \Rightarrow x = 1, y = 1, z = t \Rightarrow f(g(t), h(t), k(t)) = 2 - t \text{ and } \frac{dx}{dt} = 0, \frac{dy}{dt} = 0, \frac{dz}{dt} = 1$$

$$\Rightarrow \sqrt{\left(\frac{dx}{dt}\right)^2 + \left(\frac{dy}{dt}\right)^2 + \left(\frac{dz}{dt}\right)^2} dt = dt \Rightarrow \int_{C_3} f(x, y, z) ds = \int_0^1 (2-t) dt = \frac{3}{2}$$

$$\Rightarrow \int_{\text{Path 1}} f(x, y, z) ds = \int_{C_1} f(x, y, z) ds + \int_{C_2} f(x, y, z) ds + \int_{C_3} f(x, y, z) ds = \frac{10}{3}$$

$$\text{Path 2: } \mathbf{r}_4 = t\mathbf{i} + t\mathbf{j} \Rightarrow x = t, y = t, z = 0 \Rightarrow f(g(t), h(t), k(t)) = t^2 + t \text{ and } \frac{dx}{dt} = 1, \frac{dy}{dt} = 1, \frac{dz}{dt} = 0$$

$$\Rightarrow \sqrt{\left(\frac{dx}{dt}\right)^2 + \left(\frac{dy}{dt}\right)^2 + \left(\frac{dz}{dt}\right)^2} dt = \sqrt{2} dt \Rightarrow \int_{C_4} f(x, y, z) ds = \int_0^1 \sqrt{2}(t^2 + t) dt = \frac{5}{6}\sqrt{2};$$

$$\mathbf{r}_3 = \mathbf{i} + \mathbf{j} + t\mathbf{k} \text{ (see above)} \Rightarrow \int_{C_3} f(x, y, z) ds = \frac{3}{2}$$

$$\Rightarrow \int_{\text{Path 2}} f(x, y, z) ds = \int_{C_3} f(x, y, z) ds + \int_{C_4} f(x, y, z) ds = \frac{5}{6}\sqrt{2} + \frac{3}{2} = \frac{5\sqrt{2}+9}{6}$$

$$\text{Path 3: } \mathbf{r}_5 = t\mathbf{k} \Rightarrow x = 0, y = 0, z = t, 0 \leq t \leq 1 \Rightarrow f(g(t), h(t), k(t)) = -t \text{ and } \frac{dx}{dt} = 0, \frac{dy}{dt} = 0, \frac{dz}{dt} = 1$$

$$\Rightarrow \sqrt{\left(\frac{dx}{dt}\right)^2 + \left(\frac{dy}{dt}\right)^2 + \left(\frac{dz}{dt}\right)^2} dt = dt \Rightarrow \int_{C_5} f(x, y, z) ds = \int_0^1 -t dt = -\frac{1}{2};$$

$$\mathbf{r}_6 = t\mathbf{j} + \mathbf{k} \Rightarrow x = 0, y = t, z = 1, 0 \leq t \leq 1 \Rightarrow f(g(t), h(t), k(t)) = t - 1 \text{ and } \frac{dx}{dt} = 0, \frac{dy}{dt} = 1, \frac{dz}{dt} = 0$$

$$\Rightarrow \sqrt{\left(\frac{dx}{dt}\right)^2 + \left(\frac{dy}{dt}\right)^2 + \left(\frac{dz}{dt}\right)^2} dt = dt \Rightarrow \int_{C_6} f(x, y, z) ds = \int_0^1 (t-1) dt = -\frac{1}{2};$$

$$\mathbf{r}_7 = t\mathbf{i} + \mathbf{j} + \mathbf{k} \Rightarrow x = t, y = 1, z = 1, 0 \leq t \leq 1 \Rightarrow f(g(t), h(t), k(t)) = t^2 \text{ and } \frac{dx}{dt} = 1, \frac{dy}{dt} = 0, \frac{dz}{dt} = 0$$

$$\Rightarrow \sqrt{\left(\frac{dx}{dt}\right)^2 + \left(\frac{dy}{dt}\right)^2 + \left(\frac{dz}{dt}\right)^2} dt = dt \Rightarrow \int_{C_7} f(x, y, z) ds = \int_0^1 t^2 dt = \frac{1}{3}$$

$$\Rightarrow \int_{\text{Path 3}} f(x, y, z) ds = \int_{C_5} f(x, y, z) ds + \int_{C_6} f(x, y, z) ds + \int_{C_7} f(x, y, z) ds = -\frac{1}{2} - \frac{1}{2} + \frac{1}{3} = -\frac{2}{3}$$

3. $\mathbf{r} = (a \cos t)\mathbf{j} + (a \sin t)\mathbf{k} \Rightarrow x = 0, y = a \cos t, z = a \sin t \Rightarrow f(g(t), h(t), k(t)) = \sqrt{a^2 \sin^2 t} = a |\sin t|$ and

$$\frac{dx}{dt} = 0, \frac{dy}{dt} = -a \sin t, \frac{dz}{dt} = a \cos t \Rightarrow \sqrt{\left(\frac{dx}{dt}\right)^2 + \left(\frac{dy}{dt}\right)^2 + \left(\frac{dz}{dt}\right)^2} dt = a dt$$

$$\Rightarrow \int_c f(x, y, z) ds = \int_0^{2\pi} a^2 |\sin t| dt = \int_0^{\pi} a^2 \sin t dt + \int_{\pi}^{2\pi} (-a^2 \sin t) dt = 4a^2$$

4. $\mathbf{r} = (\cos t + t \sin t)\mathbf{i} + (\sin t - t \cos t)\mathbf{j} \Rightarrow x = \cos t + t \sin t, y = \sin t - t \cos t, z = 0$

$$\Rightarrow f(g(t), h(t), k(t)) = \sqrt{(\cos t + t \sin t)^2 + (\sin t - t \cos t)^2} = \sqrt{1+t^2} \text{ and}$$

$$\frac{dx}{dt} = -\sin t + \sin t + t \cos t = t \cos t, \frac{dy}{dt} = \cos t - \cos t + t \sin t = t \sin t, \frac{dz}{dt} = 0 \Rightarrow \sqrt{\left(\frac{dx}{dt}\right)^2 + \left(\frac{dy}{dt}\right)^2 + \left(\frac{dz}{dt}\right)^2} dt$$

$$= \sqrt{t^2 \cos^2 t + t^2 \sin^2 t} dt = |t| dt = t dt \text{ since } 0 \leq t \leq \sqrt{3} \Rightarrow \int_c f(x, y, z) ds = \int_0^{\sqrt{3}} t \sqrt{1+t^2} dt = \frac{7}{3}$$

5. $\frac{\partial P}{\partial y} = -\frac{1}{2}(x+y+z)^{-3/2} = \frac{\partial N}{\partial z}, \frac{\partial M}{\partial z} = -\frac{1}{2}(x+y+z)^{-3/2} = \frac{\partial P}{\partial x}, \frac{\partial N}{\partial x} = -\frac{1}{2}(x+y+z)^{-3/2} = \frac{\partial M}{\partial y}$
 $\Rightarrow M dx + N dy + P dz$ is exact; $\frac{\partial f}{\partial x} = \frac{1}{\sqrt{x+y+z}} \Rightarrow f(x, y, z) = 2\sqrt{x+y+z} + g(y, z) \Rightarrow \frac{\partial f}{\partial y} = \frac{1}{\sqrt{x+y+z}} + \frac{\partial g}{\partial y}$
 $= \frac{1}{\sqrt{x+y+z}} \Rightarrow \frac{\partial g}{\partial y} = 0 \Rightarrow g(y, z) = h(z) \Rightarrow f(x, y, z) = 2\sqrt{x+y+z} + h(z) \Rightarrow \frac{\partial f}{\partial z} = \frac{1}{\sqrt{x+y+z}} + h'(z)$
 $= \frac{1}{\sqrt{x+y+z}} \Rightarrow h'(z) = 0 \Rightarrow h(z) = C \Rightarrow f(x, y, z) = 2\sqrt{x+y+z} + C \Rightarrow \int_{(-1,1,1)}^{(4,-3,0)} \frac{dx+dy+dz}{\sqrt{x+y+z}}$
 $= f(4, -3, 0) - f(-1, 1, 1) = 2\sqrt{1} - 2\sqrt{1} = 0$
6. $\frac{\partial P}{\partial y} = -\frac{1}{2\sqrt{yz}} = \frac{\partial N}{\partial z}, \frac{\partial M}{\partial z} = 0 = \frac{\partial P}{\partial x}, \frac{\partial N}{\partial x} = 0 = \frac{\partial M}{\partial y} \Rightarrow M dx + N dy + P dz$ is exact; $\frac{\partial f}{\partial x} = 1$
 $\Rightarrow f(x, y, z) = x + g(y, z) \Rightarrow \frac{\partial f}{\partial y} = \frac{\partial g}{\partial y} = -\sqrt{\frac{z}{y}} \Rightarrow g(y, z) = -2\sqrt{yz} + h(z) \Rightarrow f(x, y, z) = x - 2\sqrt{yz} + h(z)$
 $\Rightarrow \frac{\partial f}{\partial z} = -\sqrt{\frac{y}{z}} + h'(z) = -\sqrt{\frac{y}{z}} \Rightarrow h'(z) = 0 \Rightarrow h(z) = C \Rightarrow f(x, y, z) = x - 2\sqrt{yz} + C$
 $\Rightarrow \int_{(1,1,1)}^{(10,3,3)} dx - \sqrt{\frac{z}{y}} dy - \sqrt{\frac{y}{z}} dz = f(10, 3, 3) - f(1, 1, 1) = (10 - 2 \cdot 3) - (1 - 2 \cdot 1) = 4 + 1 = 5$
7. $\frac{\partial M}{\partial z} = -y \cos z \neq y \cos z = \frac{\partial P}{\partial x} \Rightarrow \mathbf{F}$ is not conservative; $\mathbf{r} = (2 \cos t)\mathbf{i} + (2 \sin t)\mathbf{j} - \mathbf{k}, 0 \leq t \leq 2\pi$
 $\Rightarrow d\mathbf{r} = (-2 \sin t)\mathbf{i} - (2 \cos t)\mathbf{j} \Rightarrow \int_C \mathbf{F} \cdot d\mathbf{r} = \int_0^{2\pi} [-(-2 \sin t)(\sin(-1))(-2 \sin t) + (2 \cos t)(\sin(-1))(-2 \cos t)] dt$
 $= 4 \sin(1) \int_0^{2\pi} (\sin^2 t + \cos^2 t) dt = 8\pi \sin(1)$
8. $\frac{\partial P}{\partial y} = 0 = \frac{\partial N}{\partial z}, \frac{\partial M}{\partial z} = 0 = \frac{\partial P}{\partial x}, \frac{\partial N}{\partial x} = 3x^2 = \frac{\partial M}{\partial y} \Rightarrow \mathbf{F}$ is conservative $\Rightarrow \int_C \mathbf{F} \cdot d\mathbf{r} = 0$
9. Let $M = 8x \sin y$ and $N = -8y \cos x \Rightarrow \frac{\partial M}{\partial y} = 8x \cos y$ and $\frac{\partial N}{\partial x} = 8y \sin x \Rightarrow \int_C 8x \sin y dx - 8y \cos x dy$
 $= \iint_R (8y \sin x - 8x \cos y) dy dx = \int_0^{\pi/2} \int_0^{\pi/2} (8y \sin x - 8x \cos y) dy dx = \int_0^{\pi/2} (\pi^2 \sin x - 8x) dx = -\pi^2 + \pi^2 = 0$
10. Let $M = y^2$ and $N = x^2 \Rightarrow \frac{\partial M}{\partial y} = 2y$ and $\frac{\partial N}{\partial x} = 2x \Rightarrow \int_C y^2 dx + x^2 dy = \iint_R (2x - 2y) dx dy$
 $= \int_0^{2\pi} \int_0^2 (2r \cos \theta - 2r \sin \theta) r dr d\theta = \int_0^{2\pi} \frac{16}{3} (\cos \theta - \sin \theta) d\theta = 0$
11. Let $z = 1 - x - y \Rightarrow f_x(x, y) = -1$ and $f_y(x, y) = -1 \Rightarrow \sqrt{f_x^2 + f_y^2 + 1} = \sqrt{3} \Rightarrow \text{Surface Area} = \iint_R \sqrt{3} dx dy$
 $= \sqrt{3} (\text{Area of the circular region in the } xy\text{-plane}) = \pi\sqrt{3}$
12. $\nabla f = -3\mathbf{i} + 2y\mathbf{j} + 2z\mathbf{k}, \mathbf{p} = \mathbf{i} \Rightarrow |\nabla f| = \sqrt{9 + 4y^2 + 4z^2}$ and $|\nabla f \cdot \mathbf{p}| = 3$
 $\Rightarrow \text{Surface Area} = \iint_R \frac{\sqrt{9 + 4y^2 + 4z^2}}{3} dy dz = \int_0^{2\pi} \int_0^{\sqrt{3}} \frac{\sqrt{9 + 4r^2}}{3} r dr d\theta = \frac{1}{3} \int_0^{2\pi} \left(\frac{7}{4}\sqrt{21} - \frac{9}{4} \right) d\theta = \frac{\pi}{6} (7\sqrt{21} - 9)$

13. $\nabla f = 2x\mathbf{i} + 2y\mathbf{j} + 2z\mathbf{k}$, $\mathbf{p} = \mathbf{k} \Rightarrow |\nabla f| = \sqrt{4x^2 + 4y^2 + 4z^2} = 2\sqrt{x^2 + y^2 + z^2} = 2$ and $|\nabla f \cdot \mathbf{p}| = |2z| = 2z$ since $z \geq 0 \Rightarrow$ Surface Area $= \iint_R \frac{2}{2z} dA = \iint_R \frac{1}{z} dA = \iint_R \frac{1}{\sqrt{1-x^2-y^2}} dx dy = \int_0^{2\pi} \int_0^{1/\sqrt{2}} \frac{1}{\sqrt{1-r^2}} r dr d\theta$
 $= \int_0^{2\pi} \left[-\sqrt{1-r^2} \right]_0^{1/\sqrt{2}} d\theta = \int_0^{2\pi} \left(1 - \frac{1}{\sqrt{2}} \right) d\theta = 2\pi \left(1 - \frac{1}{\sqrt{2}} \right)$

14. (a) $\nabla f = 2x\mathbf{i} + 2y\mathbf{j} + 2z\mathbf{k}$, $\mathbf{p} = \mathbf{k} \Rightarrow |\nabla f| = \sqrt{4x^2 + 4y^2 + 4z^2} = 2\sqrt{x^2 + y^2 + z^2} = 4$ and $|\nabla f \cdot \mathbf{p}| = 2z$ since $z \geq 0 \Rightarrow$ Surface Area $= \iint_R \frac{4}{2z} dA = \iint_R \frac{2}{z} dA = 2 \int_0^{\pi/2} \int_0^{2\cos\theta} \frac{2}{\sqrt{4-r^2}} r dr d\theta = 4\pi - 8$

(b) $\mathbf{r} = 2 \cos \theta \Rightarrow d\mathbf{r} = -2 \sin \theta d\theta$; $ds^2 = r^2 d\theta^2 + dr^2$ (Arc length in polar coordinates)
 $\Rightarrow ds^2 = (2 \cos \theta)^2 d\theta^2 + dr^2 = 4 \cos^2 \theta d\theta^2 + 4 \sin^2 \theta d\theta^2 = 4 d\theta^2 \Rightarrow ds = 2 d\theta$; the height of the cylinder is $z = \sqrt{4-r^2} = \sqrt{4-4\cos^2 \theta} = 2|\sin \theta| = 2 \sin \theta$ if $0 \leq \theta \leq \frac{\pi}{2}$
 \Rightarrow Surface Area $= \int_{-\pi/2}^{\pi/2} h ds = 2 \int_0^{\pi/2} (2 \sin \theta)(2 d\theta) = 8$

15. $f(x, y, z) = \frac{x}{a} + \frac{y}{b} + \frac{z}{c} = 1 \Rightarrow \nabla f = \left(\frac{1}{a}\right)\mathbf{i} + \left(\frac{1}{b}\right)\mathbf{j} + \left(\frac{1}{c}\right)\mathbf{k} \Rightarrow |\nabla f| = \sqrt{\frac{1}{a^2} + \frac{1}{b^2} + \frac{1}{c^2}}$ and $\mathbf{p} = \mathbf{k} \Rightarrow |\nabla f \cdot \mathbf{p}| = \frac{1}{c}$ since $c > 0 \Rightarrow$ Surface Area $= \iint_R \frac{\sqrt{\frac{1}{a^2} + \frac{1}{b^2} + \frac{1}{c^2}}}{\left(\frac{1}{c}\right)} dA = c \sqrt{\frac{1}{a^2} + \frac{1}{b^2} + \frac{1}{c^2}} \iint_R dA = \frac{1}{2} abc \sqrt{\frac{1}{a^2} + \frac{1}{b^2} + \frac{1}{c^2}}$, since the area of the triangular region R is $\frac{1}{2} ab$. To check this result, let $\mathbf{v} = a\mathbf{i} + c\mathbf{k}$ and $\mathbf{w} = -a\mathbf{i} + b\mathbf{j}$; the area can be found by computing $\frac{1}{2} |\mathbf{v} \times \mathbf{w}|$.

16. (a) $\nabla f = 2y\mathbf{j} - \mathbf{k}$, $\mathbf{p} = \mathbf{k} \Rightarrow |\nabla f| = \sqrt{4y^2 + 1}$ and $|\nabla f \cdot \mathbf{p}| = 1 \Rightarrow d\sigma = \sqrt{4y^2 + 1} dx dy$
 $\Rightarrow \iint_S g(x, y, z) d\sigma = \iint_R \frac{yz}{\sqrt{4y^2 + 1}} \sqrt{4y^2 + 1} dx dy = \iint_R y(y^2 - 1) dx dy = \int_{-1}^1 \int_0^3 (y^3 - y) dx dy$
 $= \int_{-1}^1 3(y^3 - y) dy = 3 \left[\frac{y^4}{4} - \frac{y^2}{2} \right]_{-1}^1 = 0$

(b) $\iint_S g(x, y, z) d\sigma = \iint_R \frac{z}{\sqrt{4y^2 + 1}} \sqrt{4y^2 + 1} dx dy = \int_{-1}^1 \int_0^3 (y^2 - 1) dx dy = \int_{-1}^1 3(y^2 - 1) dy = 3 \left[\frac{y^3}{3} - y \right]_{-1}^1 = -4$

17. $\nabla f = 2y\mathbf{j} + 2z\mathbf{k}$, $\mathbf{p} = \mathbf{k} \Rightarrow |\nabla f| = \sqrt{4y^2 + 4z^2} = 2\sqrt{y^2 + z^2} = 10$ and $|\nabla f \cdot \mathbf{p}| = 2z$ since $z \geq 0$
 $\Rightarrow d\sigma = \frac{10}{2z} dx dy = \frac{5}{z} dx dy = \iint_S g(x, y, z) d\sigma = \iint_R (x^4 y) (y^2 + z^2) \left(\frac{5}{z}\right) dx dy$
 $= \iint_R (x^4 y) (25) \left(\frac{5}{\sqrt{25-y^2}}\right) dx dy = \int_0^4 \int_0^1 \frac{125y}{\sqrt{25-y^2}} x^4 dx dy = \int_0^4 \frac{25y}{\sqrt{25-y^2}} dy = 50$

18. Define the coordinate system so that the origin is at the center of the earth, the z -axis is the earth's axis (north is the positive z direction), and the xz -plane contains the earth's prime meridian. Let S denote the surface

which is Wyoming so then S is part of the surface $z = (R^2 - x^2 - y^2)^{1/2}$. Let R_{xy} be the projection of S onto the xy -plane. The surface area of Wyoming is $\iint_S 1 d\sigma = \iint_{R_{xy}} \sqrt{1 + \left(\frac{\partial z}{\partial x}\right)^2 + \left(\frac{\partial z}{\partial y}\right)^2} dA$

$$= \iint_{R_{xy}} \sqrt{\frac{x^2}{R^2 - x^2 - y^2} + \frac{y^2}{R^2 - x^2 - y^2} + 1} dA = \iint_{R_{xy}} \frac{R}{(R^2 - x^2 - y^2)^{1/2}} dA = \int_{\theta_1}^{\theta_2} \int_{R \sin 45^\circ}^{R \sin 49^\circ} R (R^2 - r^2)^{-1/2} r dr d\theta$$

(where θ_1 and θ_2 are the radian equivalent to $104^\circ 3'$ and $111^\circ 3'$, respectively) $= \int_{\theta_1}^{\theta_2} \left[-R (R^2 - r^2)^{1/2} \right]_{R \sin 45^\circ}^{R \sin 49^\circ} d\theta$

$$= \int_{\theta_1}^{\theta_2} \left[R (R^2 - R^2 \sin^2 45^\circ)^{1/2} - R (R^2 - R^2 \sin^2 49^\circ)^{1/2} \right] d\theta = (\theta_2 - \theta_1) R^2 (\cos 45^\circ - \cos 49^\circ)$$

$$= \frac{7\pi}{180} R^2 (\cos 45^\circ - \cos 49^\circ) = \frac{7\pi}{180} (3959)^2 (\cos 45^\circ - \cos 49^\circ) \approx 97,751 \text{ sq. mi.}$$

19. A possible parametrization is $\mathbf{r}(\phi, \theta) = (6 \sin \phi \cos \theta)\mathbf{i} + (6 \sin \phi \sin \theta)\mathbf{j} + (6 \cos \phi)\mathbf{k}$ (spherical coordinates); now $\rho = 6$ and $z = -3 \Rightarrow -3 = 6 \cos \phi \Rightarrow \cos \phi = -\frac{1}{2} \Rightarrow \phi = \frac{2\pi}{3}$ and $z = 3\sqrt{3} \Rightarrow 3\sqrt{3} = 6 \cos \phi \Rightarrow \cos \phi = \frac{\sqrt{3}}{2} \Rightarrow \phi = \frac{\pi}{6} \Rightarrow \frac{\pi}{6} \leq \phi \leq \frac{2\pi}{3}$; also $0 \leq \theta \leq 2\pi$

20. A possible parametrization is $\mathbf{r}(r, \theta) = (r \cos \theta)\mathbf{i} + (r \sin \theta)\mathbf{j} - \left(\frac{r^2}{2}\right)\mathbf{k}$ (cylindrical coordinates); now $r = \sqrt{x^2 + y^2} \Rightarrow z = -\frac{r^2}{2}$ and $-2 \leq z \leq 0 \Rightarrow -2 \leq -\frac{r^2}{2} \leq 0 \Rightarrow 4 \geq r^2 \geq 0 \Rightarrow 0 \leq r \leq 2$ since $r \geq 0$; also $0 \leq \theta \leq 2\pi$

21. A possible parametrization is $\mathbf{r}(r, \theta) = (r \cos \theta)\mathbf{i} + (r \sin \theta)\mathbf{j} + (1+r)\mathbf{k}$ (cylindrical coordinates); now $r = \sqrt{x^2 + y^2} \Rightarrow z = 1+r$ and $1 \leq z \leq 3 \Rightarrow 1 \leq 1+r \leq 3 \Rightarrow 0 \leq r \leq 2$; also $0 \leq \theta \leq 2\pi$

22. A possible parametrization is $\mathbf{r}(x, y) = x\mathbf{i} + y\mathbf{j} + \left(3 - x - \frac{y}{2}\right)\mathbf{k}$ for $0 \leq x \leq 2$ and $0 \leq y \leq 2$

23. Let $x = u \cos v$ and $z = u \sin v$, where $u = \sqrt{x^2 + z^2}$ and v is the angle in the xz -plane with the x -axis $\Rightarrow \mathbf{r}(u, v) = (u \cos v)\mathbf{i} + 2u^2\mathbf{j} + (u \sin v)\mathbf{k}$ is a possible parametrization; $0 \leq y \leq 2 \Rightarrow 2u^2 \leq 2 \Rightarrow u^2 \leq 1 \Rightarrow 0 \leq u \leq 1$ since $u \geq 0$; also, for just the upper half of the paraboloid, $0 \leq v \leq \pi$

24. A possible parametrization is $(\sqrt{10} \sin \phi \cos \theta)\mathbf{i} + (\sqrt{10} \sin \phi \sin \theta)\mathbf{j} + (\sqrt{10} \cos \phi)\mathbf{k}$, $0 \leq \phi \leq \frac{\pi}{2}$ and $0 \leq \theta \leq \frac{\pi}{2}$

25. $\mathbf{r}_u = \mathbf{i} + \mathbf{j}$, $\mathbf{r}_v = \mathbf{i} - \mathbf{j} + \mathbf{k} \Rightarrow \mathbf{r}_u \times \mathbf{r}_v = \begin{vmatrix} \mathbf{i} & \mathbf{j} & \mathbf{k} \\ 1 & 1 & 0 \\ 1 & -1 & 1 \end{vmatrix} = \mathbf{i} - \mathbf{j} - 2\mathbf{k} \Rightarrow |\mathbf{r}_u \times \mathbf{r}_v| = \sqrt{6}$

$$\Rightarrow \text{Surface Area} = \int \int_{R_{uv}} |\mathbf{r}_u \times \mathbf{r}_v| du dv = \int_0^1 \int_0^1 \sqrt{6} du dv = \sqrt{6}$$

$$\begin{aligned}
 26. \quad \iint_S (xy - z^2) d\sigma &= \int_0^1 \int_0^1 [(u+v)(u-v) - v^2] \sqrt{6} du dv = \sqrt{6} \int_0^1 \int_0^1 (u^2 - 2v^2) du dv \\
 &= \sqrt{6} \int_0^1 \left[\frac{u^2}{3} - 2uv^2 \right]_0^1 dv = \sqrt{6} \int_0^1 \left(\frac{1}{3} - 2v^2 \right) dv = \sqrt{6} \left[\frac{1}{3}v - \frac{2}{3}v^3 \right]_0^1 = -\frac{\sqrt{6}}{3} = -\sqrt{\frac{2}{3}}
 \end{aligned}$$

$$\begin{aligned}
 27. \quad \mathbf{r}_r &= (\cos \theta)\mathbf{i} + (\sin \theta)\mathbf{j}, \mathbf{r}_\theta = (-r \sin \theta)\mathbf{i} + (r \cos \theta)\mathbf{j} + \mathbf{k} \Rightarrow \mathbf{r}_r \times \mathbf{r}_\theta = \begin{vmatrix} \mathbf{i} & \mathbf{j} & \mathbf{k} \\ \cos \theta & \sin \theta & 0 \\ -r \sin \theta & r \cos \theta & 1 \end{vmatrix} \\
 &= (\sin \theta)\mathbf{i} - (\cos \theta)\mathbf{j} + r\mathbf{k} \Rightarrow |\mathbf{r}_r \times \mathbf{r}_\theta| = \sqrt{\sin^2 \theta + \cos^2 \theta + r^2} = \sqrt{1+r^2} \Rightarrow \text{Surface Area} = \iint_{R_{r\theta}} |\mathbf{r}_r \times \mathbf{r}_\theta| dr d\theta \\
 &= \int_0^{2\pi} \int_0^1 \sqrt{1+r^2} dr d\theta = \int_0^{2\pi} \left[\frac{r}{2}\sqrt{1+r^2} + \frac{1}{2} \ln(r + \sqrt{1+r^2}) \right]_0^1 d\theta = \int_0^{2\pi} \left[\frac{1}{2}\sqrt{2} + \frac{1}{2} \ln(1 + \sqrt{2}) \right] d\theta \\
 &= \pi \left[\sqrt{2} + \ln(1 + \sqrt{2}) \right]
 \end{aligned}$$

$$\begin{aligned}
 28. \quad \iint_S \sqrt{x^2 + y^2 + 1} d\sigma &= \int_0^{2\pi} \int_0^1 \sqrt{r^2 \cos^2 \theta + r^2 \sin^2 \theta + 1} \sqrt{1+r^2} dr d\theta = \int_0^{2\pi} \int_0^1 (1+r^2) dr d\theta \\
 &= \int_0^{2\pi} \left[r + \frac{r^3}{3} \right]_0^1 d\theta = \int_0^{2\pi} \frac{4}{3} d\theta = \frac{8}{3}\pi
 \end{aligned}$$

$$29. \quad \frac{\partial P}{\partial y} = 0 = \frac{\partial N}{\partial z}, \frac{\partial M}{\partial z} = 0 = \frac{\partial P}{\partial x}, \frac{\partial N}{\partial x} = 0 = \frac{\partial M}{\partial y} \Rightarrow \text{Conservative}$$

$$30. \quad \frac{\partial P}{\partial y} = \frac{-3zy}{(x^2+y^2+z^2)^{-5/2}} = \frac{\partial N}{\partial z}, \frac{\partial M}{\partial z} = \frac{-3xz}{(x^2+y^2+z^2)^{-5/2}} = \frac{\partial P}{\partial x}, \frac{\partial N}{\partial x} = \frac{-3xy}{(x^2+y^2+z^2)^{-5/2}} = \frac{\partial M}{\partial y} \Rightarrow \text{Conservative}$$

$$31. \quad \frac{\partial P}{\partial y} = 0 \neq ye^z = \frac{\partial N}{\partial z} \Rightarrow \text{Not Conservative}$$

$$32. \quad \frac{\partial P}{\partial y} = \frac{x}{(x+yz)^2} = \frac{\partial N}{\partial z}, \frac{\partial M}{\partial z} = \frac{-y}{(x+yz)^2} = \frac{\partial P}{\partial x}, \frac{\partial N}{\partial x} = \frac{-z}{(x+yz)^2} = \frac{\partial M}{\partial y} \Rightarrow \text{Conservative}$$

$$\begin{aligned}
 33. \quad \frac{\partial f}{\partial x} = 2 &\Rightarrow f(x, y, z) = 2x + g(y, z) \Rightarrow \frac{\partial f}{\partial y} = \frac{\partial g}{\partial y} = 2y + z \Rightarrow g(y, z) = y^2 + zy + h(z) \Rightarrow f(x, y, z) \\
 &= 2x + y^2 + zy + h(z) \Rightarrow \frac{\partial f}{\partial z} = y + h'(z) = y + 1 \Rightarrow h'(z) = 1 \Rightarrow h(z) = z + C \Rightarrow f(x, y, z) = 2x + y^2 + zy + z + C
 \end{aligned}$$

$$\begin{aligned}
 34. \quad \frac{\partial f}{\partial x} = z \cos xz &\Rightarrow f(x, y, z) = \sin xz + g(y, z) \Rightarrow \frac{\partial f}{\partial y} = \frac{\partial g}{\partial y} = e^y \Rightarrow g(y, z) = e^y + h(z) \Rightarrow f(x, y, z) \\
 &= \sin xz + e^y + h(z) \Rightarrow \frac{\partial f}{\partial z} = x \cos xz + h'(z) = x \cos xz \Rightarrow h'(z) = 0 \Rightarrow h(z) = C \Rightarrow f(x, y, z) = \sin xz + e^y + C
 \end{aligned}$$

$$\begin{aligned}
 35. \quad \text{Over Path 1: } \mathbf{r} &= t\mathbf{i} + t\mathbf{j} + t\mathbf{k}, 0 \leq t \leq 1 \Rightarrow x = t, y = t, z = t \text{ and } d\mathbf{r} = (\mathbf{i} + \mathbf{j} + \mathbf{k}) dt \Rightarrow \mathbf{F} = 2t^2\mathbf{i} + \mathbf{j} + t^2\mathbf{k} \\
 &\Rightarrow \mathbf{F} \cdot d\mathbf{r} = (3t^2 + 1) dt \Rightarrow \text{Work} = \int_0^1 (3t^2 + 1) dt = 2;
 \end{aligned}$$

$$\text{Over Path 2: } \mathbf{r}_1 = t\mathbf{i} + t\mathbf{j}, 0 \leq t \leq 1 \Rightarrow x = t, y = t, z = 0 \text{ and } d\mathbf{r}_1 = (\mathbf{i} + \mathbf{j})dt \Rightarrow \mathbf{F}_1 = 2t^2\mathbf{i} + \mathbf{j} + t^2\mathbf{k}$$

$$\Rightarrow \mathbf{F}_1 \cdot d\mathbf{r}_1 = (2t^2 + 1) dt \Rightarrow \text{Work}_1 = \int_0^1 (2t^2 + 1) dt = \frac{5}{3}; \mathbf{r}_2 = \mathbf{i} + \mathbf{j} + t\mathbf{k}, 0 \leq t \leq 1 \Rightarrow x = 1, y = 1, z = t \text{ and}$$

$$d\mathbf{r}_2 = \mathbf{k} dt \Rightarrow \mathbf{F}_2 = 2\mathbf{i} + \mathbf{j} + \mathbf{k} \Rightarrow \mathbf{F}_2 \cdot d\mathbf{r}_2 = dt \Rightarrow \text{Work}_2 = \int_0^1 dt = 1 \Rightarrow \text{Work} = \text{Work}_1 + \text{Work}_2 = \frac{5}{3} + 1 = \frac{8}{3}$$

36. Over Path 1: $\mathbf{r} = t\mathbf{i} + t\mathbf{j} + t\mathbf{k}, 0 \leq t \leq 1 \Rightarrow x = t, y = t, z = t$ and $d\mathbf{r} = (\mathbf{i} + \mathbf{j} + \mathbf{k}) dt \Rightarrow \mathbf{F} = 2t^2\mathbf{i} + t^2\mathbf{j} + \mathbf{k}$

$$\Rightarrow \mathbf{F} \cdot d\mathbf{r} = (3t^2 + 1) dt \Rightarrow \text{Work} = \int_0^1 (3t^2 + 1) dt = 2;$$

Over Path 2: Since f is conservative, $\oint_C \mathbf{F} \cdot d\mathbf{r} = 0$ around any simply closed curve C . Thus consider

$$\int_{\text{curve}} \mathbf{F} \cdot d\mathbf{r} = \int_{C_1} \mathbf{F} \cdot d\mathbf{r} + \int_{C_2} \mathbf{F} \cdot d\mathbf{r}, \text{ where } C_1 \text{ is the path from } (0, 0, 0) \text{ to } (1, 1, 0) \text{ to } (1, 1, 1) \text{ and } C_2 \text{ is the}$$

path from $(1, 1, 1)$ to $(0, 0, 0)$. Now, from Path 1 above, $\int_{C_2} \mathbf{F} \cdot d\mathbf{r} = -2 \Rightarrow 0 = \int_{\text{curve}} \mathbf{F} \cdot d\mathbf{r} = \int_{C_1} \mathbf{F} \cdot d\mathbf{r} + (-2)$

$$\Rightarrow \int_{C_1} \mathbf{F} \cdot d\mathbf{r} = 2$$

37. (a) $\mathbf{r} = (e^t \cos t)\mathbf{i} + (e^t \sin t)\mathbf{j} \Rightarrow x = e^t \cos t, y = e^t \sin t$ from $(1, 0)$ to $(e^{2\pi}, 0) \Rightarrow 0 \leq t \leq 2\pi$

$$\Rightarrow \frac{d\mathbf{r}}{dt} = (e^t \cos t - e^t \sin t)\mathbf{i} + (e^t \sin t + e^t \cos t)\mathbf{j} \text{ and } \mathbf{F} = \frac{x\mathbf{i} + y\mathbf{j}}{(x^2 + y^2)^{3/2}} = \frac{(e^t \cos t)\mathbf{i} + (e^t \sin t)\mathbf{j}}{(e^{2t} \cos^2 t + e^{2t} \sin^2 t)^{3/2}}$$

$$= \left(\frac{\cos t}{e^{2t}}\right)\mathbf{i} + \left(\frac{\sin t}{e^{2t}}\right)\mathbf{j} \Rightarrow \mathbf{F} \cdot \frac{d\mathbf{r}}{dt} = \left(\frac{\cos^2 t}{e^t} - \frac{\sin t \cos t}{e^t} + \frac{\sin^2 t}{e^t} + \frac{\sin t \cos t}{e^t}\right) = e^{-t} \Rightarrow \text{Work} = \int_0^{2\pi} e^{-t} dt = 1 - e^{-2\pi}$$

(b) $\mathbf{F} = \frac{x\mathbf{i} + y\mathbf{j}}{(x^2 + y^2)^{3/2}} \Rightarrow \frac{\partial f}{\partial x} = \frac{x}{(x^2 + y^2)^{3/2}} \Rightarrow f(x, y, z) = -(x^2 + y^2)^{-1/2} + g(y, z) \Rightarrow \frac{\partial f}{\partial y} = \frac{y}{(x^2 + y^2)^{3/2}} + \frac{\partial g}{\partial y}$

$$= \frac{y}{(x^2 + y^2)^{3/2}} \Rightarrow g(y, z) = C \Rightarrow f(x, y, z) = -(x^2 + y^2)^{-1/2} \text{ is a potential function for } \mathbf{F}$$

$$\Rightarrow \int_C \mathbf{F} \cdot d\mathbf{r} = f(e^{2\pi}, 0) - f(1, 0) = 1 - e^{-2\pi}$$

38. (a) $\mathbf{F} = \nabla(x^2 z e^y) \Rightarrow \mathbf{F}$ is conservative $\Rightarrow \oint_C \mathbf{F} \cdot d\mathbf{r} = 0$ for any closed path C

(b) $\int_C \mathbf{F} \cdot d\mathbf{r} = \int_{(1, 0, 0)}^{(1, 0, 2\pi)} \nabla(x^2 z e^y) \cdot d\mathbf{r} = (x^2 z e^y) \Big|_{(1, 0, 0)}^{(1, 0, 2\pi)} - (x^2 z e^y) \Big|_{(1, 0, 0)} = 2\pi - 0 = 2\pi$

39. $\nabla \times \mathbf{F} = \begin{vmatrix} \mathbf{i} & \mathbf{j} & \mathbf{k} \\ \frac{\partial}{\partial x} & \frac{\partial}{\partial y} & \frac{\partial}{\partial z} \\ y^2 & -y & 3z^2 \end{vmatrix} = -2y\mathbf{k};$ unit normal to the plane is $\mathbf{n} = \frac{2\mathbf{i} + 6\mathbf{j} - 3\mathbf{k}}{\sqrt{4 + 36 + 9}} = \frac{2}{7}\mathbf{i} + \frac{6}{7}\mathbf{j} - \frac{3}{7}\mathbf{k}$

$$\Rightarrow \nabla \times \mathbf{F} \cdot \mathbf{n} = \frac{6}{7}y; \mathbf{p} = \mathbf{k} \text{ and } f(x, y, z) = 2x + 6y - 3z \Rightarrow |\nabla f \cdot \mathbf{p}| = 3 \Rightarrow d\sigma = \frac{|\nabla f|}{|\nabla f \cdot \mathbf{p}|} dA = \frac{7}{3} dA$$

$$\Rightarrow \oint_C \mathbf{F} \cdot d\mathbf{r} = \iint_R \frac{6}{7} y d\sigma = \iint_R \left(\frac{6}{7} y\right) \left(\frac{7}{3} dA\right) = \iint_R 2y dA = \int_0^{2\pi} \int_0^1 2r \sin \theta r dr d\theta = \int_0^{2\pi} \frac{2}{3} \sin \theta d\theta = 0$$

$$40. \nabla \times \mathbf{F} = \begin{vmatrix} \mathbf{i} & \mathbf{j} & \mathbf{k} \\ \frac{\partial}{\partial x} & \frac{\partial}{\partial y} & \frac{\partial}{\partial z} \\ x^2 + y & x + y & 4y^2 - z \end{vmatrix} = 8y\mathbf{i}; \text{ the circle lies in the plane } f(x, y, z) = y + z = 0 \text{ with unit normal}$$

$$\mathbf{n} = \frac{1}{\sqrt{2}}\mathbf{j} + \frac{1}{\sqrt{2}}\mathbf{k} \Rightarrow \nabla \times \mathbf{F} \cdot \mathbf{n} = 0 \Rightarrow \oint_C \mathbf{F} \cdot d\mathbf{r} = \iint_R \nabla \times \mathbf{F} \cdot \mathbf{n} \, d\sigma = \iint_R 0 \, d\sigma = 0$$

$$41. \text{ (a) } \mathbf{r} = \sqrt{2}t\mathbf{i} + \sqrt{2}t\mathbf{j} + (4 - t^2)\mathbf{k}, 0 \leq t \leq 1 \Rightarrow x = \sqrt{2}t, y = \sqrt{2}t, z = 4 - t^2 \Rightarrow \frac{dx}{dt} = \sqrt{2}, \frac{dy}{dt} = \sqrt{2}, \frac{dz}{dt} = -2t$$

$$\Rightarrow \sqrt{\left(\frac{dx}{dt}\right)^2 + \left(\frac{dy}{dt}\right)^2 + \left(\frac{dz}{dt}\right)^2} dt = \sqrt{4 + 4t^2} dt \Rightarrow M = \int_C \delta(x, y, z) \, ds = \int_0^1 3t\sqrt{4 + 4t^2} dt = \left[\frac{1}{4}(4 + 4t)^{3/2}\right]_0^1$$

$$= 4\sqrt{2} - 2$$

$$\text{ (b) } M = \int_C \delta(x, y, z) \, ds = \int_0^1 \sqrt{4 + 4t^2} dt = \left[t\sqrt{1 + t^2} + \ln\left(t + \sqrt{1 + t^2}\right)\right]_0^1 = \sqrt{2} + \ln(1 + \sqrt{2})$$

$$42. \mathbf{r} = t\mathbf{i} + 2t\mathbf{j} + \frac{2}{3}t^{3/2}\mathbf{k}, 0 \leq t \leq 2 \Rightarrow x = t, y = 2t, z = \frac{2}{3}t^{3/2} \Rightarrow \frac{dx}{dt} = 1, \frac{dy}{dt} = 2, \frac{dz}{dt} = t^{1/2}$$

$$\Rightarrow \sqrt{\left(\frac{dx}{dt}\right)^2 + \left(\frac{dy}{dt}\right)^2 + \left(\frac{dz}{dt}\right)^2} dt = \sqrt{t + 5} dt \Rightarrow M = \int_C \delta(x, y, z) \, ds = \int_0^2 3\sqrt{5 + t}\sqrt{t + 5} dt = \int_0^2 3(t + 5) dt = 36;$$

$$M_{yz} = \int_C x\delta \, ds = \int_0^2 3t(t + 5) dt = 38; M_{xz} = \int_C y\delta \, ds = \int_0^2 6t(t + 5) dt = 76; M_{xy} = \int_C z\delta \, ds$$

$$= \int_0^2 2t^{3/2}(t + 5) dt = \frac{144}{7}\sqrt{2} \Rightarrow \bar{x} = \frac{M_{yz}}{M} = \frac{38}{36} = \frac{19}{18}, \bar{y} = \frac{M_{xz}}{M} = \frac{76}{36} = \frac{19}{9}, \bar{z} = \frac{M_{xy}}{M} = \frac{\left(\frac{144}{7}\sqrt{2}\right)}{36} = \frac{4}{7}\sqrt{2}$$

$$43. \mathbf{r} = t\mathbf{i} + \left(\frac{2\sqrt{2}}{3}t^{3/2}\right)\mathbf{j} + \left(\frac{t^2}{2}\right)\mathbf{k}, 0 \leq t \leq 2 \Rightarrow x = t, y = \frac{2\sqrt{2}}{3}t^{3/2}, z = \frac{t^2}{2} \Rightarrow \frac{dx}{dt} = 1, \frac{dy}{dt} = \sqrt{2}t^{1/2}, \frac{dz}{dt} = t$$

$$\Rightarrow \sqrt{\left(\frac{dx}{dt}\right)^2 + \left(\frac{dy}{dt}\right)^2 + \left(\frac{dz}{dt}\right)^2} dt = \sqrt{1 + 2t + t^2} dt = \sqrt{(t + 1)^2} dt = |t + 1| dt = (t + 1) dt \text{ on the domain given.}$$

$$\text{Then } M = \int_C \delta \, ds = \int_0^2 \left(\frac{1}{t+1}\right)(t+1) dt = \int_0^2 dt = 2; M_{yz} = \int_C x\delta \, ds = \int_0^2 t\left(\frac{1}{t+1}\right)(t+1) dt = \int_0^2 t dt = 2;$$

$$M_{xz} = \int_C y\delta \, ds = \int_0^2 \left(\frac{2\sqrt{2}}{3}t^{3/2}\right)\left(\frac{1}{t+1}\right)(t+1) dt = \int_0^2 \frac{2\sqrt{2}}{3}t^{3/2} dt = \frac{32}{15}; M_{xy} = \int_C z\delta \, ds$$

$$= \int_0^2 \left(\frac{t^2}{2}\right)\left(\frac{1}{t+1}\right)(t+1) dt = \int_0^2 \frac{t^2}{2} dt = \frac{4}{3} \Rightarrow \bar{x} = \frac{M_{yz}}{M} = \frac{2}{2} = 1; \bar{y} = \frac{M_{xz}}{M} = \frac{\left(\frac{32}{15}\right)}{2} = \frac{16}{15}; \bar{z} = \frac{M_{xy}}{M} = \frac{\left(\frac{4}{3}\right)}{2} = \frac{2}{3};$$

$$I_x = \int_C (y^2 + z^2) \delta \, ds = \int_0^2 \left(\frac{8}{9}t^3 + \frac{t^4}{4}\right) dt = \frac{232}{45}; I_y = \int_C (x^2 + z^2) \delta \, ds = \int_0^2 \left(t^2 + \frac{t^4}{4}\right) dt = \frac{64}{15};$$

$$I_z = \int_C (y^2 + x^2) \delta \, ds = \int_0^2 \left(t^2 + \frac{8}{9}t^3\right) dt = \frac{56}{9}$$

$$44. \bar{z} = 0 \text{ because the arch is in the } xy\text{-plane, and } \bar{x} = 0 \text{ because the mass is distributed symmetrically with}$$

$$\text{respect to the } y\text{-axis; } \mathbf{r}(t) = (a \cos t)\mathbf{i} + (a \sin t)\mathbf{j}, 0 \leq t \leq \pi \Rightarrow ds = \sqrt{\left(\frac{dx}{dt}\right)^2 + \left(\frac{dy}{dt}\right)^2 + \left(\frac{dz}{dt}\right)^2} dt$$

$$= \sqrt{(-a \sin t)^2 + (a \cos t)^2} dt = a dt, \text{ since } a \geq 0; M = \int_C \delta \, ds = \int_C (2a - y) \, ds = \int_0^\pi (2a - a \sin t) a dt$$

$$= 2a^2\pi - 2a^2; M_{xz} = \int_C y\delta \, dt = \int_C y(2a - y) \, ds = \int_0^\pi (a \sin t)(2a - a \sin t) \, dt = \int_0^\pi (2a^2 \sin t - a^2 \sin^2 t) \, dt$$

$$= \left[-2a^2 \cos t - a^2 \left(\frac{t}{2} - \frac{\sin 2t}{4} \right) \right]_0^\pi = 4a^2 - \frac{a^2\pi}{2} \Rightarrow \bar{y} = \frac{(4a^2 - \frac{a^2\pi}{2})}{2a^2\pi - 2a^2} = \frac{8 - \pi}{4\pi - 4} \Rightarrow (\bar{x}, \bar{y}, \bar{z}) = \left(0, \frac{8 - \pi}{4\pi - 4}, 0 \right)$$

45. $\mathbf{r}(t) = (e^t \cos t)\mathbf{i} + (e^t \sin t)\mathbf{j} + e^t\mathbf{k}, 0 \leq t \leq \ln 2 \Rightarrow x = e^t \cos t, y = e^t \sin t, z = e^t \Rightarrow \frac{dx}{dt} = (e^t \cos t - e^t \sin t),$

$$\frac{dy}{dt} = (e^t \sin t + e^t \cos t), \frac{dz}{dt} = e^t \Rightarrow \sqrt{\left(\frac{dx}{dt}\right)^2 + \left(\frac{dy}{dt}\right)^2 + \left(\frac{dz}{dt}\right)^2} dt$$

$$= \sqrt{(e^t \cos t - e^t \sin t)^2 + (e^t \sin t + e^t \cos t)^2 + (e^t)^2} dt = \sqrt{3e^{2t}} dt = \sqrt{3}e^t dt; M = \int_C \delta \, ds = \int_0^{\ln 2} \sqrt{3} e^t dt$$

$$= \sqrt{3}; M_{xy} = \int_C z\delta \, ds = \int_0^{\ln 2} (\sqrt{3} e^t)(e^t) dt = \int_0^{\ln 2} \sqrt{3} e^{2t} dt = \frac{3\sqrt{3}}{2} \Rightarrow \bar{z} = \frac{M_{xy}}{M} = \frac{(\frac{3\sqrt{3}}{2})}{\sqrt{3}} = \frac{3}{2};$$

$$I_z = \int_C (x^2 + y^2) \delta \, ds = \int_0^{\ln 2} (e^{2t} \cos^2 t + e^{2t} \sin^2 t)(\sqrt{3} e^t) dt = \int_0^{\ln 2} \sqrt{3} e^{3t} dt = \frac{7\sqrt{3}}{3}$$

46. $\mathbf{r}(t) = (2 \sin t)\mathbf{i} + (2 \cos t)\mathbf{j} + 3t\mathbf{k}, 0 \leq t \leq 2\pi \Rightarrow x = 2 \sin t, y = 2 \cos t, z = 3t \Rightarrow \frac{dx}{dt} = 2 \cos t, \frac{dy}{dt} = -2 \sin t,$

$$\frac{dz}{dt} = 3 \Rightarrow \sqrt{\left(\frac{dx}{dt}\right)^2 + \left(\frac{dy}{dt}\right)^2 + \left(\frac{dz}{dt}\right)^2} dt = \sqrt{4 + 9} dt = \sqrt{13} dt; M = \int_C \delta \, ds = \int_0^{2\pi} \delta \sqrt{13} dt = 2\pi\delta\sqrt{13};$$

$$M_{xy} = \int_C z\delta \, ds = \int_0^{2\pi} (3t)(\delta\sqrt{13}) dt = 6\delta\pi^2\sqrt{13}; M_{yz} = \int_C x\delta \, ds = \int_0^{2\pi} (2 \sin t)(\delta\sqrt{13}) dt = 0;$$

$$M_{xz} = \int_C y\delta \, ds = \int_0^{2\pi} (2 \cos t)(\delta\sqrt{13}) dt = 0 \Rightarrow \bar{x} = \bar{y} = 0 \text{ and } \bar{z} = \frac{M_{xy}}{M} = \frac{6\delta\pi^2\sqrt{13}}{2\delta\pi\sqrt{13}} = 3\pi \Rightarrow (0, 0, 3\pi) \text{ is the center of mass}$$

47. Because of symmetry $\bar{x} = \bar{y} = 0$. Let $f(x, y, z) = x^2 + y^2 + z^2 = 25 \Rightarrow \nabla f = 2x\mathbf{i} + 2y\mathbf{j} + 2z\mathbf{k}$

$$\Rightarrow |\nabla f| = \sqrt{4x^2 + 4y^2 + 4z^2} = 10 \text{ and } \mathbf{p} = \mathbf{k} \Rightarrow |\nabla f \cdot \mathbf{p}| = 2z, \text{ since } z \geq 0 \Rightarrow M = \iint_R \delta(x, y, z) \, d\sigma$$

$$= \iint_R z \left(\frac{10}{2z}\right) dA = \iint_R 5 \, dA = 5 \text{ (Area of the circular region)} = 80\pi; M_{xy} = \iint_R z\delta \, d\sigma = \iint_R 5z \, dA$$

$$= \iint_R 5\sqrt{25 - x^2 - y^2} \, dx \, dy = \int_0^{2\pi} \int_0^4 (5\sqrt{25 - r^2}) r \, dr \, d\theta = \int_0^{2\pi} \frac{490}{3} d\theta = \frac{980}{3}\pi \Rightarrow \bar{z} = \frac{(\frac{980}{3}\pi)}{80\pi} = \frac{49}{12}$$

$$\Rightarrow (\bar{x}, \bar{y}, \bar{z}) = \left(0, 0, \frac{49}{12} \right); I_z = \iint_R (x^2 + y^2) \delta \, d\sigma = \iint_R 5(x^2 + y^2) \, dx \, dy = \int_0^{2\pi} \int_0^4 5r^3 \, dr \, d\theta = \int_0^{2\pi} 320 \, d\theta$$

$$= 640\pi$$

48. On the face $z = 1: g(x, y, z) = z = 1$ and $\mathbf{p} = \mathbf{k} \Rightarrow \nabla g = \mathbf{k} \Rightarrow |\nabla g| = 1$ and $|\nabla g \cdot \mathbf{p}| = 1 \Rightarrow d\sigma = dA$

$$\Rightarrow I = \iint_R (x^2 + y^2) \, dA = 2 \int_0^{\pi/4} \int_0^{\sec \theta} r^3 \, dr \, d\theta = \frac{2}{3}; \text{ On the face } z = 0: g(x, y, z) = z = 0 \Rightarrow \nabla g = \mathbf{k} \text{ and } \mathbf{p} = \mathbf{k}$$

$$\Rightarrow |\nabla g| = 1 \Rightarrow |\nabla g \cdot \mathbf{p}| = 1 \Rightarrow d\sigma = dA \Rightarrow I = \iint_R (x^2 + y^2) \, dA = \frac{2}{3}; \text{ On the face } y = 0: g(x, y, z) = y = 0$$

$$\Rightarrow \nabla g = \mathbf{j} \text{ and } \mathbf{p} = \mathbf{j} \Rightarrow |\nabla g| = 1 \Rightarrow |\nabla g \cdot \mathbf{p}| = 1 \Rightarrow d\sigma = dA \Rightarrow I = \iint_R (x^2 + 0) \, dA = \int_0^1 \int_0^1 x^2 \, dx \, dz = \frac{1}{3}; \text{ On the face}$$

$$\begin{aligned}
y=1: g(x, y, z) = y=1 &\Rightarrow \nabla g = \mathbf{j} \text{ and } \mathbf{p} = \mathbf{j} \Rightarrow |\nabla g| = 1 \Rightarrow |\nabla g \cdot \mathbf{p}| = 1 \Rightarrow d\sigma = dA \Rightarrow I = \iint_R (x^2 + 1^2) dA \\
&= \int_0^1 \int_0^1 (x^2 + 1) dx dz = \frac{4}{3}; \text{ On the face } x=1: g(x, y, z) = x=1 \Rightarrow \nabla g = \mathbf{i} \text{ and } \mathbf{p} = \mathbf{i} \Rightarrow |\nabla g| = 1 \Rightarrow |\nabla g \cdot \mathbf{p}| = 1 \\
&\Rightarrow d\sigma = dA \Rightarrow I = \iint_R (1^2 + y^2) dA = \int_0^1 \int_0^1 (1 + y^2) dy dz = \frac{4}{3}; \text{ On the face } x=0: g(x, y, z) = x=0 \Rightarrow \nabla g = \mathbf{i} \\
\text{and } \mathbf{p} = \mathbf{i} &\Rightarrow |\nabla g| = 1 \Rightarrow |\nabla g \cdot \mathbf{p}| = 1 \Rightarrow d\sigma = dA \Rightarrow I = \iint_R (0^2 + y^2) dA = \int_0^1 \int_0^1 y^2 dy dz = \frac{1}{3} \\
&\Rightarrow I_z = \frac{2}{3} + \frac{2}{3} + \frac{1}{3} + \frac{4}{3} + \frac{4}{3} + \frac{1}{3} = \frac{14}{3}
\end{aligned}$$

$$49. M = 2xy + x \text{ and } N = xy - y \Rightarrow \frac{\partial M}{\partial x} = 2y + 1, \frac{\partial M}{\partial y} = 2x, \frac{\partial N}{\partial x} = y, \frac{\partial N}{\partial y} = x - 1$$

$$\Rightarrow \text{Flux} = \iint_R \left(\frac{\partial M}{\partial x} + \frac{\partial N}{\partial y} \right) dx dy = \iint_R (2y + 1 + x - 1) dy dx = \int_0^1 \int_0^1 (2y + x) dy dx = \frac{3}{2};$$

$$\text{Circ} = \iint_R \left(\frac{\partial N}{\partial x} - \frac{\partial M}{\partial y} \right) dx dy = \iint_R (y - 2x) dy dx = \int_0^1 \int_0^1 (y - 2x) dy dx = -\frac{1}{2}$$

$$50. M = y - 6x^2 \text{ and } N = x + y^2 \Rightarrow \frac{\partial M}{\partial x} = -12x, \frac{\partial M}{\partial y} = 1, \frac{\partial N}{\partial x} = 1, \frac{\partial N}{\partial y} = 2y$$

$$\Rightarrow \text{Flux} = \iint_R \left(\frac{\partial M}{\partial x} + \frac{\partial N}{\partial y} \right) dx dy = \iint_R (-12x + 2y) dx dy = \int_0^1 \int_0^1 (-12x + 2y) dx dy = \int_0^1 (4y^2 + 2y - 6) dy = -\frac{11}{3};$$

$$\text{Circ} = \iint_R \left(\frac{\partial N}{\partial x} - \frac{\partial M}{\partial y} \right) dx dy = \iint_R (1 - 1) dx dy = 0$$

$$51. M = -\frac{\cos y}{x} \text{ and } N = \ln x \sin y \Rightarrow \frac{\partial M}{\partial y} = \frac{\sin y}{x} \text{ and } \frac{\partial N}{\partial x} = \frac{\sin y}{x} \Rightarrow \oint_C \ln x \sin y dy - \frac{\cos y}{x} dx$$

$$= \iint_R \left(\frac{\partial N}{\partial x} - \frac{\partial M}{\partial y} \right) dx dy = \iint_R \left(\frac{\sin y}{x} - \frac{\sin y}{x} \right) dx dy = 0$$

$$52. (a) \text{ Let } M = x \text{ and } N = y \Rightarrow \frac{\partial M}{\partial x} = 1, \frac{\partial M}{\partial y} = 0, \frac{\partial N}{\partial x} = 0, \frac{\partial N}{\partial y} = 1$$

$$\Rightarrow \text{Flux} = \iint_R \left(\frac{\partial M}{\partial x} + \frac{\partial N}{\partial y} \right) dx dy = \iint_R (1 + 1) dx dy = 2 \iint_R dx dy = 2(\text{Area of the region})$$

(b) Let C be a closed curve to which Green's Theorem applies and let \mathbf{n} be the unit normal vector to C . Let $\mathbf{F} = x\mathbf{i} + y\mathbf{j}$ and assume \mathbf{F} is orthogonal to \mathbf{n} at every point of C . Then the flux density of \mathbf{F} at every point of C is 0 since $\mathbf{F} \cdot \mathbf{n} = 0$ at every point of $C \Rightarrow \frac{\partial M}{\partial x} + \frac{\partial N}{\partial y} = 0$ at every point of C

$$\Rightarrow \text{Flux} = \iint_R \left(\frac{\partial M}{\partial x} + \frac{\partial N}{\partial y} \right) dx dy = \iint_R 0 dx dy = 0. \text{ But part (a) above states that the flux is}$$

$2(\text{Area of the region}) \Rightarrow$ the area of the region would be 0 \Rightarrow contradiction. Therefore, \mathbf{F} cannot be orthogonal to \mathbf{n} at every point of C .

$$53. \frac{\partial}{\partial x}(2xy) = 2y, \frac{\partial}{\partial y}(2yz) = 2z, \frac{\partial}{\partial z}(2xz) = 2x \Rightarrow \nabla \cdot \mathbf{F} = 2y + 2z + 2x \Rightarrow \text{Flux} = \iiint_D (2x + 2y + 2z) dV$$

$$= \int_0^1 \int_0^1 \int_0^1 (2x + 2y + 2z) dx dy dz = \int_0^1 \int_0^1 (1 + 2y + 2z) dy dz = \int_0^1 (2 + 2z) dz = 3$$

54. $\frac{\partial}{\partial x}(xz) = z, \frac{\partial}{\partial z}(yz) = z, \frac{\partial}{\partial z}(1) = 0 \Rightarrow \nabla \cdot \mathbf{F} = 2z \Rightarrow \text{Flux} = \iiint_D 2z r dr d\theta dz$

$$\int_0^{2\pi} \int_0^4 \int_3^{\sqrt{25-r^2}} 2z dz r dr d\theta = \int_0^{2\pi} \int_0^4 r(16-r^2) dr d\theta = \int_0^{2\pi} 64 d\theta = 128\pi$$

55. $\frac{\partial}{\partial x}(-2x) = -2, \frac{\partial}{\partial y}(-3y) = -3, \frac{\partial}{\partial z}(z) = 1 \Rightarrow \nabla \cdot \mathbf{F} = -4; x^2 + y^2 + z^2 = 2$ and $x^2 + y^2 = z \Rightarrow z = 1$

$$\Rightarrow x^2 + y^2 = 1 \Rightarrow \text{Flux} = \iiint_D -4 dV = -4 \int_0^{2\pi} \int_{r^2}^1 \int_{r^2}^{\sqrt{2-r^2}} dz r dr d\theta = -4 \int_0^{2\pi} \int_0^1 (r\sqrt{2-r^2} - r) dr d\theta$$

$$= -4 \int_0^{2\pi} \left(-\frac{7}{12} + \frac{2}{3}\sqrt{2}\right) d\theta = \frac{2}{3}\pi(7-8\sqrt{2})$$

56. $\frac{\partial}{\partial x}(6x+y) = 6, \frac{\partial}{\partial y}(-x-z) = 0, \frac{\partial}{\partial z}(4yz) = 4y \Rightarrow \nabla \cdot \mathbf{F} = 6+4y; z = \sqrt{x^2+y^2} = r$

$$\Rightarrow \text{Flux} = \iiint_D (6+4y) dV = \int_0^{\pi/2} \int_0^1 \int_0^r (6+4r \sin \theta) dz r dr d\theta = \int_0^{\pi/2} \int_0^1 (6r^2 + 4r^3 \sin \theta) dr d\theta$$

$$= \int_0^{\pi/2} (2 + \sin \theta) d\theta = \pi + 1$$

57. $\mathbf{F} = y\mathbf{i} + z\mathbf{j} + x\mathbf{k} \Rightarrow \nabla \cdot \mathbf{F} = 0 \Rightarrow \text{Flux} = \iint_S \mathbf{F} \cdot \mathbf{n} d\sigma = \iiint_D \nabla \cdot \mathbf{F} dV = 0$

58. $\mathbf{F} = 3xz^2\mathbf{i} + y\mathbf{j} - z^3\mathbf{k} \Rightarrow \nabla \cdot \mathbf{F} = 3z^2 + 1 - 3z^2 = 1 \Rightarrow \text{Flux} = \iint_S \mathbf{F} \cdot \mathbf{n} d\sigma = \iiint_D \nabla \cdot \mathbf{F} dV$

$$= \int_0^4 \int_0^{\sqrt{16-x^2}/2} \int_0^{y/2} 1 dz dy dx = \int_0^4 \left(\frac{16-x^2}{16}\right) dx = \left[x - \frac{x^3}{48}\right]_0^4 = \frac{8}{3}$$

59. $\mathbf{F} = xy^2\mathbf{i} + x^2y\mathbf{j} + y\mathbf{k} \Rightarrow \nabla \cdot \mathbf{F} = y^2 + x^2 + 0 \Rightarrow \text{Flux} = \iint_S \mathbf{F} \cdot \mathbf{n} d\sigma = \iiint_D \nabla \cdot \mathbf{F} dV$

$$= \iiint_D (x^2 + y^2) dV = \int_0^{2\pi} \int_0^1 \int_{-1}^1 r^2 dz r dr d\theta = \int_0^{2\pi} \int_0^1 2r^3 dr d\theta = \int_0^{2\pi} \frac{1}{2} d\theta = \pi$$

60. (a) $\mathbf{F} = (3z+1)\mathbf{k} \Rightarrow \nabla \cdot \mathbf{F} = 3 \Rightarrow \text{Flux across the hemisphere} = \iint_S \mathbf{F} \cdot \mathbf{n} d\sigma = \iiint_D \nabla \cdot \mathbf{F} dV = \iiint_D 3 dV$

$$= 3\left(\frac{1}{2}\right)\left(\frac{4}{3}\pi a^3\right) = 2\pi a^3$$

(b) $f(x, y, z) = x^2 + y^2 + z^2 - a^2 = 0 \Rightarrow \nabla f = 2x\mathbf{i} + 2y\mathbf{j} + 2z\mathbf{k} \Rightarrow |\nabla f| = \sqrt{4x^2 + 4y^2 + 4z^2} = \sqrt{4a^2} = 2a$ since

$$a \geq 0 \Rightarrow \mathbf{n} = \frac{2x\mathbf{i} + 2y\mathbf{j} + 2z\mathbf{k}}{2a} = \frac{x\mathbf{i} + y\mathbf{j} + z\mathbf{k}}{a} \Rightarrow \mathbf{F} \cdot \mathbf{n} = (3z+1)\left(\frac{z}{a}\right); \mathbf{p} = \mathbf{k} \Rightarrow \nabla f \cdot \mathbf{p} = \nabla f \cdot \mathbf{k} = 2z \Rightarrow |\nabla f \cdot \mathbf{p}| = 2z$$

$$\text{since } z \geq 0 \Rightarrow d\sigma = \frac{|\nabla f|}{|\nabla f \cdot \mathbf{p}|} = \frac{2a}{2z} dA = \frac{a}{z} dA \Rightarrow \iint_S \mathbf{F} \cdot \mathbf{n} d\sigma = \iint_{R_{xy}} (3z+1)\left(\frac{z}{a}\right)\left(\frac{a}{z}\right) dA = \iint_{R_{xy}} (3z+1) dx dy$$

$$= \iint_{R_{xy}} \left(3\sqrt{a^2 - x^2 - y^2} + 1\right) dx dy = \int_0^{2\pi} \int_0^a \left(3\sqrt{a^2 - r^2} + 1\right) r dr d\theta = \int_0^{2\pi} \left(\frac{a^2}{2} + a^3\right) d\theta = \pi a^2 + 2\pi a^3,$$

which is the flux across the hemisphere. Across the base we find $\mathbf{F} = [3(0)+1]\mathbf{k} = \mathbf{k}$ since $z = 0$ in the

$$\begin{aligned}
 xy\text{-plane} &\Rightarrow \mathbf{n} = -\mathbf{k} \text{ (outward normal)} \Rightarrow \mathbf{F} \cdot \mathbf{n} = -1 \Rightarrow \text{Flux across the base} = \iint_S \mathbf{F} \cdot \mathbf{n} \, d\sigma \\
 &= \iint_{R_{xy}} (-1) \, dx \, dy = -\pi a^2. \text{ Therefore, the total flux across the closed surface is} \\
 &\left(\pi a^2 + 2\pi a^3\right) - \pi a^2 = 2\pi a^3.
 \end{aligned}$$

CHAPTER 16 ADDITIONAL AND ADVANCED EXERCISES

- $dx = (-2 \sin t + 2 \sin 2t) \, dt$ and $dy = (2 \cos t - 2 \cos 2t) \, dt$; Area $= \frac{1}{2} \oint_C x \, dy - y \, dx$
 $= \frac{1}{2} \int_0^{2\pi} [(2 \cos t - \cos 2t)(2 \cos t - 2 \cos 2t) - (2 \sin t - \sin 2t)(-2 \sin t + 2 \sin 2t)] \, dt$
 $= \frac{1}{2} \int_0^{2\pi} [6 - (6 \cos t \cos 2t + 6 \sin t \sin 2t)] \, dt = \frac{1}{2} \int_0^{2\pi} (6 - 6 \cos t) \, dt = 6\pi$
- $dx = (-2 \sin t - 2 \sin 2t) \, dt$ and $dy = (2 \cos t - 2 \cos 2t) \, dt$; Area $= \frac{1}{2} \oint_C x \, dy - y \, dx$
 $= \frac{1}{2} \int_0^{2\pi} [(2 \cos t + \cos 2t)(2 \cos t - 2 \cos 2t) - (2 \sin t - \sin 2t)(-2 \sin t - 2 \sin 2t)] \, dt$
 $= \frac{1}{2} \int_0^{2\pi} [2 - 2(\cos t \cos 2t - \sin t \sin 2t)] \, dt = \frac{1}{2} \int_0^{2\pi} (2 - 2 \cos 3t) \, dt = \frac{1}{2} \left[2t - \frac{2}{3} \sin 3t \right]_0^{2\pi} = 2\pi$
- $dx = \cos 2t \, dt$ and $dy = \cos t \, dt$; Area $= \frac{1}{2} \oint_C x \, dy - y \, dx = \frac{1}{2} \int_0^\pi (\frac{1}{2} \sin 2t \cos t - \sin t \cos 2t) \, dt$
 $= \frac{1}{2} \int_0^\pi [\sin t \cos^2 t - (\sin t)(2 \cos^2 t - 1)] \, dt = \frac{1}{2} \int_0^\pi (-\sin t \cos^2 t + \sin t) \, dt = \frac{1}{2} \left[\frac{1}{3} \cos^3 t - \cos t \right]_0^\pi = -\frac{1}{3} + 1 = \frac{2}{3}$
- $dx = (-2a \sin t - 2a \cos 2t) \, dt$ and $dy = (b \cos t) \, dt$; Area $= \frac{1}{2} \oint_C x \, dy - y \, dx$
 $= \frac{1}{2} \int_0^{2\pi} [(2ab \cos^2 t - ab \cos t \sin 2t) - (-2ab \sin^2 t - 2ab \sin t \cos 2t)] \, dt$
 $= \frac{1}{2} \int_0^{2\pi} [2ab - 2ab \cos^2 t \sin t + 2ab(\sin t)(2 \cos^2 t - 1)] \, dt = \frac{1}{2} \int_0^{2\pi} (2ab + 2ab \cos^2 t \sin t - 2ab \sin t) \, dt$
 $= \frac{1}{2} \left[2abt - \frac{2}{3} ab \cos^3 t + 2ab \cos t \right]_0^{2\pi} = 2\pi ab$
- (a) $\mathbf{F}(x, y, z) = z\mathbf{i} + x\mathbf{j} + y\mathbf{k}$ is $\mathbf{0}$ only at the point $(0, 0, 0)$, and $\text{curl } \mathbf{F}(x, y, z) = \mathbf{i} + \mathbf{j} + \mathbf{k}$ is never $\mathbf{0}$.

(b) $\mathbf{F}(x, y, z) = z\mathbf{i} + y\mathbf{k}$ is $\mathbf{0}$ only on the line $x = t, y = 0, z = 0$ and $\text{curl } \mathbf{F}(x, y, z) = \mathbf{i} + \mathbf{j}$ is never $\mathbf{0}$.

(c) $\mathbf{F}(x, y, z) = z\mathbf{i}$ is $\mathbf{0}$ only when $z = 0$ (the xy -plane) and $\text{curl } \mathbf{F}(x, y, z) = \mathbf{j}$ is never $\mathbf{0}$.
- $\mathbf{F} = yz^2\mathbf{i} + xz^2\mathbf{j} + 2xyz\mathbf{k}$ and $\mathbf{n} = \frac{x\mathbf{i} + y\mathbf{j} + z\mathbf{k}}{\sqrt{x^2 + y^2 + z^2}} = \frac{x\mathbf{i} + y\mathbf{j} + z\mathbf{k}}{R}$, so \mathbf{F} is parallel to \mathbf{n} when $yz = \frac{cx^2}{R}, xz = \frac{cy}{R}$,
and $2xyz = \frac{cz}{R} \Rightarrow \frac{yz^2}{x} = \frac{xz^2}{y} = 2xy \Rightarrow y^2 = x^2 \Rightarrow y = \pm x$ and $z^2 = \pm \frac{c}{R} = 2x^2 \Rightarrow z = \pm \sqrt{2}x$. Also,
 $x^2 + y^2 + z^2 = R^2 \Rightarrow x^2 + x^2 + 2x^2 = R^2 \Rightarrow 4x^2 = R^2 \Rightarrow x = \pm \frac{R}{2}$. Thus the points are: $\left(\frac{R}{2}, \frac{R}{2}, \frac{\sqrt{2}R}{2}\right)$,

$$\left(\frac{R}{2}, \frac{R}{2}, -\frac{\sqrt{2}R}{2}\right), \left(-\frac{R}{2}, -\frac{R}{2}, \frac{\sqrt{2}R}{2}\right), \left(-\frac{R}{2}, -\frac{R}{2}, -\frac{\sqrt{2}R}{2}\right), \left(\frac{R}{2}, -\frac{R}{2}, \frac{\sqrt{2}R}{2}\right), \left(\frac{R}{2}, -\frac{R}{2}, -\frac{\sqrt{2}R}{2}\right),$$

$$\left(-\frac{R}{2}, \frac{R}{2}, \frac{\sqrt{2}R}{2}\right), \left(-\frac{R}{2}, \frac{R}{2}, -\frac{\sqrt{2}R}{2}\right)$$

7. Set up the coordinate system so that $(a, b, c) = (0, R, 0) \Rightarrow \delta(x, y, z) = \sqrt{x^2 + (y-R)^2 + z^2}$
 $= \sqrt{x^2 + y^2 + z^2 - 2Ry + R^2} = \sqrt{2R^2 - 2Ry}$; let $f(x, y, z) = x^2 + y^2 + z^2 - R^2$ and $\mathbf{p} = \mathbf{i}$
 $\Rightarrow \nabla f = 2x\mathbf{i} + 2y\mathbf{j} + 2z\mathbf{k} \Rightarrow |\nabla f| = 2\sqrt{x^2 + y^2 + z^2} = 2R \Rightarrow d\sigma = \frac{|\nabla f|}{|\nabla f \cdot \mathbf{i}|} dz dy = \frac{2R}{2x} dz dy$
 $\Rightarrow \text{Mass} = \iint_S \delta(x, y, z) d\sigma = \iint_{R_{yz}} \sqrt{2R^2 - 2Ry} \left(\frac{R}{x}\right) dz dy = R \iint_{R_{yz}} \frac{\sqrt{2R^2 - 2Ry}}{\sqrt{R^2 - y^2 - z^2}} dz dy$
 $= 4R \int_{-R}^R \int_0^{\sqrt{R^2 - y^2}} \frac{\sqrt{2R^2 - 2Ry}}{\sqrt{R^2 - y^2 - z^2}} dz dy = 4R \int_{-R}^R \sqrt{2R^2 - 2Ry} \sin^{-1} \left(\frac{z}{\sqrt{R^2 - y^2}} \right) \Big|_0^{\sqrt{R^2 - y^2}} dy$
 $= 2\pi R \int_{-R}^R \sqrt{2R^2 - 2Ry} dy = 2\pi R \left(\frac{-1}{3R}\right) (2R^2 - 2Ry)^{3/2} \Big|_{-R}^R = \frac{16\pi R^3}{3}$

8. $\mathbf{r}(r, \theta) = (r \cos \theta)\mathbf{i} + (r \sin \theta)\mathbf{j} + \theta\mathbf{k}, 0 \leq r \leq 1, 0 \leq \theta \leq 2\pi \Rightarrow \mathbf{r}_r \times \mathbf{r}_\theta = \begin{vmatrix} \mathbf{i} & \mathbf{j} & \mathbf{k} \\ \cos \theta & \sin \theta & 0 \\ -r \sin \theta & r \cos \theta & 1 \end{vmatrix}$
 $= (\sin \theta)\mathbf{i} - (\cos \theta)\mathbf{j} + r\mathbf{k} \Rightarrow |\mathbf{r}_r \times \mathbf{r}_\theta| = \sqrt{1 + r^2}; \delta = 2\sqrt{x^2 + y^2} = 2\sqrt{r^2 \cos^2 \theta + r^2 \sin^2 \theta} = 2r$
 $\Rightarrow \text{Mass} = \iint_S \delta(x, y, z) d\sigma = \int_0^{2\pi} \int_0^1 2r\sqrt{1+r^2} dr d\theta = \int_0^{2\pi} \left[\frac{2}{3}(1+r^2)^{3/2} \right]_0^1 d\theta = \int_0^{2\pi} \frac{2}{3}(2\sqrt{2} - 1) d\theta$
 $= \frac{4\pi}{3}(2\sqrt{2} - 1)$

9. $M = x^2 + 4xy$ and $N = -6y \Rightarrow \frac{\partial M}{\partial x} = 2x + 4y$ and $\frac{\partial N}{\partial y} = -6 \Rightarrow \text{Flux} = \int_0^b \int_0^a (2x + 4y - 6) dx dy$
 $= \int_0^b (a^2 + 4ay - 6a) dy = a^2b + 2ab^2 - 6ab$. We want to minimize
 $f(a, b) = a^2b + 2ab^2 - 6ab = ab(a + 2b - 6)$. Thus, $f_a(a, b) = 2ab + 2b^2 - 6b = 0$ and
 $f_b(a, b) = a^2 + 4ab - 6a = 0 \Rightarrow b(2a + 2b - 6) = 0 \Rightarrow b = 0$ or $b = -a + 3$. Now $b = 0 \Rightarrow a^2 - 6a = 0 \Rightarrow a = 0$
or $a = 6 \Rightarrow (0, 0)$ and $(6, 0)$ are critical points. On the other hand, $b = -a + 3 \Rightarrow a^2 + 4a(-a + 3) - 6a = 0$
 $\Rightarrow -3a^2 + 6a = 0 \Rightarrow a = 0$ or $a = 2 \Rightarrow (0, 3)$ and $(2, 1)$ are also critical points. The flux at $(0, 0) = 0$, the flux at
 $(6, 0) = 0$, the flux at $(0, 3) = 0$ and the flux at $(2, 1) = -4$. Therefore, the flux is minimized at $(2, 1)$ with
value -4 .

10. A plane through the origin has equation $ax + by + cz = 0$. Consider first the case when $c \neq 0$. Assume the plane is given by $z = ax + by$ and let $f(x, y, z) = x^2 + y^2 + z^2 = 4$. Let C denote the circle of intersection of the plane with the sphere. By Stokes' Theorem, $\oint_C \mathbf{F} \cdot d\mathbf{r} = \iint_S \nabla \times \mathbf{F} \cdot \mathbf{n} d\sigma$, where \mathbf{n} is a unit normal to the plane. Let

$\mathbf{r}(x, y) = x\mathbf{i} + y\mathbf{j} + (ax + by)\mathbf{k}$ be a parametrization of the surface. Then $\mathbf{r}_x \times \mathbf{r}_y = \begin{vmatrix} \mathbf{i} & \mathbf{j} & \mathbf{k} \\ 1 & 0 & a \\ 0 & 1 & b \end{vmatrix} = -a\mathbf{i} - b\mathbf{j} + \mathbf{k}$

$\Rightarrow d\sigma = |\mathbf{r}_x \times \mathbf{r}_y| dx dy = \sqrt{a^2 + b^2 + 1} dx dy$. Also, $\nabla \times \mathbf{F} = \begin{vmatrix} \mathbf{i} & \mathbf{j} & \mathbf{k} \\ \frac{\partial}{\partial x} & \frac{\partial}{\partial y} & \frac{\partial}{\partial z} \\ z & x & y \end{vmatrix} = \mathbf{i} + \mathbf{j} + \mathbf{k}$ and $\mathbf{n} = \frac{a\mathbf{i} + b\mathbf{j} - \mathbf{k}}{\sqrt{a^2 + b^2 + 1}}$

$\Rightarrow \iint_S \nabla \times \mathbf{F} \cdot \mathbf{n} d\sigma = \iint_{R_{xy}} \frac{a+b-1}{\sqrt{a^2 + b^2 + 1}} \sqrt{a^2 + b^2 + 1} dx dy = \iint_{R_{xy}} (a+b-1) dx dy = (a+b-1) \iint_{R_{xy}} dx dy$. Now

$x^2 + y^2 + (ax + by)^2 = 4 \Rightarrow \left(\frac{a^2+1}{4}\right)x^2 + \left(\frac{b^2+1}{4}\right)y^2 + \left(\frac{ab}{2}\right)xy = 1 \Rightarrow$ the region R_{xy} is the interior of the ellipse

$Ax^2 + Bxy + Cy^2 = 1$ in the xy -plane, where $A = \frac{a^2+1}{4}$, $B = \frac{ab}{2}$, and $C = \frac{b^2+1}{4}$. The area of the ellipse is

$\frac{2\pi}{\sqrt{4AC-B^2}} = \frac{4\pi}{\sqrt{a^2+b^2+1}} \Rightarrow \oint_C \mathbf{F} \cdot d\mathbf{r} = h(a, b) = \frac{4\pi(a+b-1)}{\sqrt{a^2+b^2+1}}$. Thus we optimize $H(a, b) = \frac{(a+b-1)^2}{a^2+b^2+1}$:

$\frac{\partial H}{\partial a} = \frac{2(a+b-1)(b^2+1+a-ab)}{(a^2+b^2+1)^2} = 0$ and $\frac{\partial H}{\partial b} = \frac{2(a+b-1)(a^2+1+b-ab)}{(a^2+b^2+1)^2} = 0 \Rightarrow a+b-1=0$, or $b^2+1+a-ab=0$ and

$a^2+1+b-ab=0 \Rightarrow a+b-1=0$, or $a^2-b^2+(b-a)=0 \Rightarrow a+b-1=0$, or $(a-b)(a+b-1)=0$

$\Rightarrow a+b-1=0$ or $a=b$. The critical values $a+b-1=0$ give a saddle. If $a=b$, then $0 = b^2+1+a-ab$

$\Rightarrow a^2+1+a-a^2=0 \Rightarrow a=-1 \Rightarrow b=-1$. Thus, the point $(a, b) = (-1, -1)$ gives a local extremum for

$\oint_C \mathbf{F} \cdot d\mathbf{r} \Rightarrow z = -x - y \Rightarrow x + y + z = 0$ is the desired plane, if $c \neq 0$.

Note: Since $h(-1, -1)$ is negative, the circulation about \mathbf{n} is clockwise, so $-\mathbf{n}$ is the correct pointing normal for the counterclockwise circulation. Thus $\iint_S \nabla \times \mathbf{F} \cdot (-\mathbf{n}) d\sigma$ actually gives the maximum circulation.

If $c = 0$, one can see that the corresponding problem is equivalent to the calculation above when $b = 0$, which does not lead to a local extreme.

11. (a) Partition the string into small pieces. Let $\Delta_i s$ be the length of the i^{th} piece. Let (x_i, y_i) be a point in the i^{th} piece. The work done by gravity in moving the i^{th} piece to the x -axis is approximately

$W_i = (gx_i y_i \Delta_i s) y_i$ where $x_i y_i \Delta_i s$ is approximately the mass of the i^{th} piece. The total work done by

gravity in moving the string to the x -axis is $\sum_i W_i = \sum_i gx_i y_i^2 \Delta_i s \Rightarrow \text{Work} = \int_C gxy^2 ds$

(b) $\text{Work} = \int_C gxy^2 ds = \int_0^{\pi/2} g(2 \cos t)(4 \sin^2 t) \sqrt{4 \sin^2 t + 4 \cos^2 t} dt = 16g \int_0^{\pi/2} \cos t \sin^2 t dt$
 $= \left[16g \left(\frac{\sin^3 t}{3} \right) \right]_0^{\pi/2} = \frac{16}{3} g$

(c) $\bar{x} = \frac{\int_C x(xy) ds}{\int_C xy ds}$ and $\bar{y} = \frac{\int_C y(xy) ds}{\int_C xy ds}$; the mass of the string is $\int_C xy ds$ and the weight of the string is

$g \int_C xy ds$. Therefore, the work done in moving the point mass at (\bar{x}, \bar{y}) to the x -axis is

$W = \left(g \int_C xy ds \right) \bar{y} = g \int_C xy^2 ds = \frac{16}{3} g$.

12. (a) Partition the sheet into small pieces. Let $\Delta_i\sigma$ be the area of the i^{th} piece and select a point (x_i, y_i, z_i) in the i^{th} piece. The mass of the i^{th} piece is approximately $x_i y_i \Delta_i\sigma$. The work done by gravity in moving the i^{th} piece to the xy -plane is approximately $(gx_i y_i \Delta_i\sigma)z_i = gx_i y_i z_i \Delta_i\sigma \Rightarrow \text{Work} = \iint_S gxyz \, d\sigma$.

$$\begin{aligned} \text{(b)} \quad \iint_S gxyz \, d\sigma &= g \iint_{R_{xy}} xy(1-x-y)\sqrt{1+(-1)^2+(-1)^2} \, dA = \sqrt{3}g \int_0^1 \int_0^{1-x} (xy - x^2y - xy^2) \, dy \, dx \\ &= \sqrt{3}g \int_0^1 \left[\frac{1}{2}xy^2 - \frac{1}{2}x^2y^2 - \frac{1}{3}xy^3 \right]_0^{1-x} dx = \sqrt{3}g \int_0^1 \left[\frac{1}{6}x - \frac{1}{2}x^2 + \frac{1}{2}x^3 - \frac{1}{6}x^4 \right] dx \\ &= \sqrt{3}g \left[\frac{1}{12}x^2 - \frac{1}{6}x^3 + \frac{1}{6}x^4 - \frac{1}{30}x^5 \right]_0^1 = \sqrt{3}g \left(\frac{1}{12} - \frac{1}{30} \right) = \frac{\sqrt{3}g}{20} \end{aligned}$$

- (c) The center of mass of the sheet is the point $(\bar{x}, \bar{y}, \bar{z})$ where $\bar{z} = \frac{M_{xy}}{M}$ with $M_{xy} = \iint_S xyz \, d\sigma$ and

$$M = \iint_S xy \, d\sigma. \text{ The work done by gravity in moving the point mass at } (\bar{x}, \bar{y}, \bar{z}) \text{ to the } xy\text{-plane is}$$

$$gM\bar{z} = gM \left(\frac{M_{xy}}{M} \right) = gM_{xy} = \iint_S gxyz \, d\sigma = \frac{\sqrt{3}g}{20}.$$

13. (a) Partition the sphere $x^2 + y^2 + (z-2)^2 = 1$ into small pieces. Let $\Delta_i\sigma$ be the surface area of the i^{th} piece and let (x_i, y_i, z_i) be a point on the i^{th} piece. The force due to pressure on the i^{th} piece is approximately $w(4-z_i)\Delta_i\sigma$. The total force on S is approximately $\sum_i w(4-z_i)\Delta_i\sigma$. This gives the actual force to be

$$\iint_S w(4-z) \, d\sigma.$$

- (b) The upward buoyant force is a result of the \mathbf{k} -component of the force on the ball due to liquid pressure. The force on the ball at (x, y, z) is $w(4-z)(-\mathbf{n}) = w(z-4)\mathbf{n}$, where \mathbf{n} is the outer unit normal at (x, y, z) . Hence the \mathbf{k} -component of this force is $w(z-4)\mathbf{n} \cdot \mathbf{k} = w(z-4)\mathbf{k} \cdot \mathbf{n}$. The (magnitude of the) buoyant force on the ball is obtained by adding up all these \mathbf{k} -components to obtain $\iint_S w(z-4)\mathbf{k} \cdot \mathbf{n} \, d\sigma$.

- (c) The Divergence Theorem says $\iint_S w(z-4)\mathbf{k} \cdot \mathbf{n} \, d\sigma = \iiint_D \text{div}(w(z-4)\mathbf{k}) \, dV = \iiint_D w \, dV$, where D is

$$x^2 + y^2 + (z-2)^2 \leq 1 \Rightarrow \iint_S w(z-4)\mathbf{k} \cdot \mathbf{n} \, d\sigma = w \iiint_D 1 \, dV = \frac{4}{3}\pi w, \text{ the weight of the fluid if it were to occupy the region } D.$$

14. The surface S is $z = \sqrt{x^2 + y^2}$ from $z = 1$ to $z = 2$. Partition S into small pieces and let $\Delta_i\sigma$ be the area of the i^{th} piece. Let (x_i, y_i, z_i) be a point on the i^{th} piece. Then the magnitude of the force on the i^{th} piece due to liquid pressure is approximately $F_i = w(2-z_i)\Delta_i\sigma \Rightarrow$ the total force on S is approximately

$$\begin{aligned} \sum_i F_i &= \sum w(2-z_i)\Delta_i\sigma \Rightarrow \text{the actual force is } \iint_S w(2-z) \, d\sigma = \iint_{R_{xy}} w \left(2 - \sqrt{x^2 + y^2} \right) \sqrt{1 + \frac{x^2}{x^2+y^2} + \frac{y^2}{x^2+y^2}} \, dA \\ &= \iint_{R_{xy}} \sqrt{2}w \left(2 - \sqrt{x^2 + y^2} \right) \, dA = \int_0^{2\pi} \int_1^2 \sqrt{2}w(2-r)r \, dr \, d\theta = \int_0^{2\pi} \sqrt{2}w \left[r^2 - \frac{1}{3}r^3 \right]_1^2 \, d\theta = \int_0^{2\pi} \frac{2\sqrt{2}w}{3} \, d\theta = \frac{4\sqrt{2}\pi w}{3} \end{aligned}$$

15. Assume that S is a surface to which Stokes' Theorem applies. Then $\oint_C \mathbf{E} \cdot d\mathbf{r} = \iint_S (\nabla \times \mathbf{E}) \cdot \mathbf{n} \, d\sigma$
 $= \iint_S \left(-\frac{\partial \mathbf{B}}{\partial t}\right) \cdot \mathbf{n} \, d\sigma = -\frac{\partial}{\partial t} \iint_S \mathbf{B} \cdot \mathbf{n} \, d\sigma$. Thus the voltage around a loop equals the negative of the rate of change of magnetic flux through the loop.

16. According to Gauss's Law, $\iint_S \mathbf{F} \cdot \mathbf{n} \, d\sigma = 4\pi GmM$ for any surface enclosing the origin. But if $\mathbf{F} = \nabla \times \mathbf{H}$ then the integral over such a closed surface would have to be 0 by the Divergence Theorem since $\text{div } \mathbf{F} = 0$.

17. $\oint_C f \nabla g \cdot d\mathbf{r} = \iint_S \nabla \times (f \nabla g) \cdot \mathbf{n} \, d\sigma$ (Stokes' Theorem)
 $= \iint_S (f \nabla \times \nabla g + \nabla f \times \nabla g) \cdot \mathbf{n} \, d\sigma$ (Section 16.8, Exercise 19b)
 $= \iint_S [(f)(\mathbf{0}) + \nabla f \times \nabla g] \cdot \mathbf{n} \, d\sigma$ (Section 16.7, Equation 8)
 $= \iint_S (\nabla f \times \nabla g) \cdot \mathbf{n} \, d\sigma$

18. $\nabla \times \mathbf{F}_1 = \nabla \times \mathbf{F}_2 \Rightarrow \nabla \times (\mathbf{F}_2 - \mathbf{F}_1) = \mathbf{0} \Rightarrow \mathbf{F}_2 - \mathbf{F}_1$ is conservative $\Rightarrow \mathbf{F}_2 - \mathbf{F}_1 = \nabla f$; also, $\nabla \cdot \mathbf{F}_1 = \nabla \cdot \mathbf{F}_2 \Rightarrow \nabla \cdot (\mathbf{F}_2 - \mathbf{F}_1) = 0 \Rightarrow \nabla^2 f = 0$ (so f is harmonic). Finally, on the surface S , $\nabla f \cdot \mathbf{n} = (\mathbf{F}_2 - \mathbf{F}_1) \cdot \mathbf{n} = \mathbf{F}_2 \cdot \mathbf{n} - \mathbf{F}_1 \cdot \mathbf{n} = 0$. Now, $\nabla \cdot (f \nabla f) = \nabla f \cdot \nabla f + f \nabla^2 f$ so the Divergence Theorem gives
 $\iiint_D |\nabla f|^2 \, dV + \iiint_D f \nabla^2 f \, dV = \iiint_D \nabla \cdot (f \nabla f) \, dV = \iint_S f \nabla f \cdot \mathbf{n} \, d\sigma = 0$, and since $\nabla^2 f = 0$ we have
 $\iiint_D |\nabla f|^2 \, dV + 0 = 0 \Rightarrow \iiint_D |\mathbf{F}_2 - \mathbf{F}_1|^2 \, dV = 0 = \iint_S f \nabla f \cdot \mathbf{n} \, d\sigma = 0$, as claimed.

19. False; let $\mathbf{F} = y\mathbf{i} + x\mathbf{j} \neq \mathbf{0} \Rightarrow \nabla \cdot \mathbf{F} = \frac{\partial}{\partial x}(y) + \frac{\partial}{\partial y}(x) = 0$ and $\nabla \times \mathbf{F} = \begin{vmatrix} \mathbf{i} & \mathbf{j} & \mathbf{k} \\ \frac{\partial}{\partial x} & \frac{\partial}{\partial y} & \frac{\partial}{\partial z} \\ x & y & 0 \end{vmatrix} = 0\mathbf{i} + 0\mathbf{j} + 0\mathbf{k} = \mathbf{0}$

20. $|\mathbf{r}_u \times \mathbf{r}_v|^2 = |\mathbf{r}_u|^2 |\mathbf{r}_v|^2 \sin^2 \theta = |\mathbf{r}_u|^2 |\mathbf{r}_v|^2 (1 - \cos^2 \theta) = |\mathbf{r}_u|^2 |\mathbf{r}_v|^2 - |\mathbf{r}_u|^2 |\mathbf{r}_v|^2 \cos^2 \theta = |\mathbf{r}_u|^2 |\mathbf{r}_v|^2 - (\mathbf{r}_u \cdot \mathbf{r}_v)^2$
 $\Rightarrow |\mathbf{r}_u \times \mathbf{r}_v|^2 = EG - F^2 \Rightarrow d\sigma = |\mathbf{r}_u \times \mathbf{r}_v| \, du \, dv = \sqrt{EG - F^2} \, du \, dv$

21. $\mathbf{r} = x\mathbf{i} + y\mathbf{j} + z\mathbf{k} \Rightarrow \nabla \cdot \mathbf{r} = 1 + 1 + 1 = 3 \Rightarrow \iiint_D \nabla \cdot \mathbf{r} \, dV = 3 \iiint_D dV = 3V \Rightarrow V = \frac{1}{3} \iiint_D \nabla \cdot \mathbf{r} \, dV = \frac{1}{3} \iint_S \mathbf{r} \cdot \mathbf{n} \, d\sigma$, by the Divergence Theorem

CHAPTER 17 SECOND-ORDER DIFFERENTIAL EQUATIONS

17.1 SECOND-ORDER LINEAR EQUATIONS

- $y'' - y' - 12y = 0 \Rightarrow r^2 - r - 12 = 0 \Rightarrow (r - 4)(r + 3) = 0 \Rightarrow r = 4 \text{ or } r = -3 \Rightarrow y = c_1 e^{4x} + c_2 e^{-3x}$
- $3y'' - y' = 0 \Rightarrow 3r^2 - r = 0 \Rightarrow r(3r - 1) = 0 \Rightarrow r = 0 \text{ or } r = \frac{1}{3} \Rightarrow y = c_1 e^{0 \cdot x} + c_2 e^{\frac{1}{3}x} \Rightarrow y = c_1 + c_2 e^{\frac{1}{3}x}$
- $y'' + 3y' - 4y = 0 \Rightarrow r^2 + 3r - 4 = 0 \Rightarrow (r + 4)(r - 1) = 0 \Rightarrow r = -4 \text{ or } r = 1 \Rightarrow y = c_1 e^{-4x} + c_2 e^x$
- $y'' - 9y = 0 \Rightarrow r^2 - 9 = 0 \Rightarrow (r - 3)(r + 3) = 0 \Rightarrow r = 3 \text{ or } r = -3 \Rightarrow y = c_1 e^{3x} + c_2 e^{-3x}$
- $y'' - 4y = 0 \Rightarrow r^2 - 4 = 0 \Rightarrow (r - 2)(r + 2) = 0 \Rightarrow r = 2 \text{ or } r = -2 \Rightarrow y = c_1 e^{2x} + c_2 e^{-2x}$
- $y'' - 64y = 0 \Rightarrow r^2 - 64 = 0 \Rightarrow (r - 8)(r + 8) = 0 \Rightarrow r = 8 \text{ or } r = -8 \Rightarrow y = c_1 e^{8x} + c_2 e^{-8x}$
- $2y'' - y' - 3y = 0 \Rightarrow 2r^2 - r - 3 = 0 \Rightarrow (2r - 3)(r + 1) = 0 \Rightarrow r = \frac{3}{2} \text{ or } r = -1 \Rightarrow y = c_1 e^{\frac{3}{2}x} + c_2 e^{-x}$
- $9y'' - y = 0 \Rightarrow 9r^2 - 1 = 0 \Rightarrow (3r - 1)(3r + 1) = 0 \Rightarrow r = \frac{1}{3} \text{ or } r = -\frac{1}{3} \Rightarrow y = c_1 e^{\frac{1}{3}x} + c_2 e^{-\frac{1}{3}x}$
- $8y'' - 10y' - 3y = 0 \Rightarrow 8r^2 - 10r - 3 = 0 \Rightarrow (4r + 1)(2r - 3) = 0 \Rightarrow r = -\frac{1}{4} \text{ or } r = \frac{3}{2} \Rightarrow y = c_1 e^{-\frac{1}{4}x} + c_2 e^{\frac{3}{2}x}$
- $3y'' - 20y' + 12y = 0 \Rightarrow 3r^2 - 20r + 12 = 0 \Rightarrow (3r - 2)(r - 6) = 0 \Rightarrow r = \frac{2}{3} \text{ or } r = 6 \Rightarrow y = c_1 e^{\frac{2}{3}x} + c_2 e^{6x}$
- $y'' + 9y = 0 \Rightarrow r^2 + 9 = 0 \Rightarrow r = 0 \pm 3i \Rightarrow y = e^{0 \cdot x}(c_1 \cos 3x + c_2 \sin 3x) \Rightarrow y = c_1 \cos 3x + c_2 \sin 3x$
- $y'' + 4y' + 5y = 0 \Rightarrow r^2 + 4r + 5 = 0 \Rightarrow r = \frac{-4 \pm \sqrt{4^2 - 4(1)(5)}}{2(1)} = -2 \pm i \Rightarrow y = e^{-2x}(c_1 \cos x + c_2 \sin x)$
- $y'' + 25y = 0 \Rightarrow r^2 + 25 = 0 \Rightarrow r = 0 \pm 5i \Rightarrow y = e^{0 \cdot x}(c_1 \cos 5x + c_2 \sin 5x) \Rightarrow y = c_1 \cos 5x + c_2 \sin 5x$
- $y'' + y = 0 \Rightarrow r^2 + 1 = 0 \Rightarrow r = 0 \pm i \Rightarrow y = e^{0 \cdot x}(c_1 \cos x + c_2 \sin x) \Rightarrow y = c_1 \cos x + c_2 \sin x$
- $y'' - 2y' + 5y = 0 \Rightarrow r^2 - 2r + 5 = 0 \Rightarrow r = \frac{-(-2) \pm \sqrt{(-2)^2 - 4(1)(5)}}{2(1)} = 1 \pm 2i \Rightarrow y = e^x(c_1 \cos 2x + c_2 \sin 2x)$
- $y'' + 16y = 0 \Rightarrow r^2 + 16 = 0 \Rightarrow r = 0 \pm 4i \Rightarrow y = e^{0 \cdot x}(c_1 \cos 4x + c_2 \sin 4x) \Rightarrow y = c_1 \cos 4x + c_2 \sin 4x$
- $y'' + 2y' + 4y = 0 \Rightarrow r^2 + 2r + 4 = 0 \Rightarrow r = \frac{-2 \pm \sqrt{2^2 - 4(1)(4)}}{2(1)} = -1 \pm \sqrt{3}i \Rightarrow y = e^{-x}(c_1 \cos \sqrt{3}x + c_2 \sin \sqrt{3}x)$
- $y'' - 2y' + 3y = 0 \Rightarrow r^2 - 2r + 3 = 0 \Rightarrow r = \frac{-(-2) \pm \sqrt{(-2)^2 - 4(1)(3)}}{2(1)} = 1 \pm \sqrt{2}i \Rightarrow y = e^x(c_1 \cos \sqrt{2}x + c_2 \sin \sqrt{2}x)$
- $y'' + 4y' + 9y = 0 \Rightarrow r^2 + 4r + 9 = 0 \Rightarrow r = \frac{-4 \pm \sqrt{4^2 - 4(1)(9)}}{2(1)} = -2 \pm \sqrt{5}i \Rightarrow y = e^{-2x}(c_1 \cos \sqrt{5}x + c_2 \sin \sqrt{5}x)$

1004 Chapter 17 Second-Order Differential Equations

20. $4y'' - 4y' + 13y = 0 \Rightarrow 4r^2 - 4r + 13 = 0 \Rightarrow r = \frac{-(-4) \pm \sqrt{(-4)^2 - 4(4)(13)}}{2(4)} = \frac{1}{2} \pm \sqrt{3}i$
 $\Rightarrow y = e^{\frac{1}{2}x} (c_1 \cos \sqrt{3}x + c_2 \sin \sqrt{3}x)$
21. $y'' = 0 \Rightarrow r^2 = 0 \Rightarrow r = 0$, repeated twice $\Rightarrow y = c_1 e^{0 \cdot x} + c_2 x e^{0 \cdot x} \Rightarrow y = c_1 + c_2 x$
22. $y'' + 8y' + 16y = 0 \Rightarrow r^2 + 8r + 16 = 0 \Rightarrow (r + 4)^2 = 0 \Rightarrow r = -4$, repeated twice $\Rightarrow y = c_1 e^{-4x} + c_2 x e^{-4x}$
23. $\frac{d^2y}{dx^2} + 4\frac{dy}{dx} + 4y = 0 \Rightarrow r^2 + 4r + 4 = 0 \Rightarrow (r + 2)^2 = 0 \Rightarrow r = -2$, repeated twice $\Rightarrow y = c_1 e^{-2x} + c_2 x e^{-2x}$
24. $\frac{d^2y}{dx^2} - 6\frac{dy}{dx} + 9y = 0 \Rightarrow r^2 - 6r + 9 = 0 \Rightarrow (r - 3)^2 = 0 \Rightarrow r = 3$, repeated twice $\Rightarrow y = c_1 e^{3x} + c_2 x e^{3x}$
25. $\frac{d^2y}{dx^2} + 6\frac{dy}{dx} + 9y = 0 \Rightarrow r^2 + 6r + 9 = 0 \Rightarrow (r + 3)^2 = 0 \Rightarrow r = -3$, repeated twice $\Rightarrow y = c_1 e^{-3x} + c_2 x e^{-3x}$
26. $4\frac{d^2y}{dx^2} - 12\frac{dy}{dx} + 9y = 0 \Rightarrow 4r^2 - 12r + 9 = 0 \Rightarrow (2r - 3)^2 = 0 \Rightarrow r = \frac{3}{2}$, repeated twice $\Rightarrow y = c_1 e^{\frac{3}{2}x} + c_2 x e^{\frac{3}{2}x}$
27. $4\frac{d^2y}{dx^2} + 4\frac{dy}{dx} + y = 0 \Rightarrow 4r^2 + 4r + 1 = 0 \Rightarrow (2r + 1)^2 = 0 \Rightarrow r = -\frac{1}{2}$, repeated twice $\Rightarrow y = c_1 e^{-\frac{1}{2}x} + c_2 x e^{-\frac{1}{2}x}$
28. $4\frac{d^2y}{dx^2} - 4\frac{dy}{dx} + y = 0 \Rightarrow 4r^2 - 4r + 1 = 0 \Rightarrow (2r - 1)^2 = 0 \Rightarrow r = \frac{1}{2}$, repeated twice $\Rightarrow y = c_1 e^{\frac{1}{2}x} + c_2 x e^{\frac{1}{2}x}$
29. $9\frac{d^2y}{dx^2} + 6\frac{dy}{dx} + y = 0 \Rightarrow 9r^2 + 6r + 1 = 0 \Rightarrow (3r + 1)^2 = 0 \Rightarrow r = -\frac{1}{3}$, repeated twice $\Rightarrow y = c_1 e^{-\frac{1}{3}x} + c_2 x e^{-\frac{1}{3}x}$
30. $9\frac{d^2y}{dx^2} - 12\frac{dy}{dx} + 4y = 0 \Rightarrow 9r^2 - 12r + 4 = 0 \Rightarrow (3r - 2)^2 = 0 \Rightarrow r = \frac{2}{3}$, repeated twice $\Rightarrow y = c_1 e^{\frac{2}{3}x} + c_2 x e^{\frac{2}{3}x}$
31. $y'' + 6y' + 5y = 0, y(0) = 0, y'(0) = 3 \Rightarrow r^2 + 6r + 5 = 0 \Rightarrow (r + 5)(r + 1) = 0 \Rightarrow r = -5$ or $r = -1$
 $\Rightarrow y = c_1 e^{-5x} + c_2 e^{-x} \Rightarrow y' = -5c_1 e^{-5x} - c_2 e^{-x}; y(0) = 0 \Rightarrow c_1 + c_2 = 0$, and $y'(0) = 3 \Rightarrow -5c_1 - c_2 = 3$
 $\Rightarrow c_1 = -\frac{3}{4}$ and $c_2 = \frac{3}{4} \Rightarrow y = -\frac{3}{4}e^{-5x} + \frac{3}{4}e^{-x}$
32. $y'' + 16y = 0, y(0) = 2, y'(0) = -2 \Rightarrow r^2 + 16 = 0 \Rightarrow r = 0 \pm 4i \Rightarrow y = c_1 \cos 4x + c_2 \sin 4x$
 $\Rightarrow y' = -4c_1 \sin 4x + 4c_2 \cos 4x; y(0) = 2 \Rightarrow c_1 = 2$, and $y'(0) = -2 \Rightarrow 4c_2 = -2 \Rightarrow c_1 = 2$ and $c_2 = -\frac{1}{2}$
 $\Rightarrow y = 2 \cos 4x - \frac{1}{2} \sin 4x$
33. $y'' + 12y = 0, y(0) = 0, y'(0) = 1 \Rightarrow r^2 + 12 = 0 \Rightarrow r = 0 \pm 2\sqrt{3}i \Rightarrow y = c_1 \cos 2\sqrt{3}x + c_2 \sin 2\sqrt{3}x$
 $\Rightarrow y' = -2\sqrt{3}c_1 \sin 2\sqrt{3}x + 2\sqrt{3}c_2 \cos 2\sqrt{3}x; y(0) = 0 \Rightarrow c_1 = 0$, and $y'(0) = 1 \Rightarrow 2\sqrt{3}c_2 = 1$
 $\Rightarrow c_1 = 0$ and $c_2 = \frac{1}{2\sqrt{3}} \Rightarrow y = \frac{1}{2\sqrt{3}} \sin 2\sqrt{3}x$
34. $12y'' + 5y' - 2y = 0, y(0) = 1, y'(0) = -1 \Rightarrow 12r^2 + 5r - 2 = 0 \Rightarrow (4r - 1)(3r + 2) = 0 \Rightarrow r = \frac{1}{4}$ or $r = -\frac{2}{3}$
 $\Rightarrow y = c_1 e^{(1/4)x} + c_2 e^{-(2/3)x} \Rightarrow y' = \frac{1}{4}c_1 e^{(1/4)x} - \frac{2}{3}c_2 e^{-(2/3)x}; y(0) = 1 \Rightarrow c_1 + c_2 = 1$, and $y'(0) = -1$
 $\Rightarrow \frac{1}{4}c_1 - \frac{2}{3}c_2 = -1 \Rightarrow c_1 = -\frac{4}{11}$ and $c_2 = \frac{15}{11} \Rightarrow y = -\frac{4}{11}e^{(1/4)x} + \frac{15}{11}e^{-(2/3)x}$
35. $y'' + 8y = 0, y(0) = -1, y'(0) = 2 \Rightarrow r^2 + 8 = 0 \Rightarrow r = 0 \pm 2\sqrt{2}i \Rightarrow y = c_1 \cos 2\sqrt{2}x + c_2 \sin 2\sqrt{2}x$
 $\Rightarrow y' = -2\sqrt{2}c_1 \sin 2\sqrt{2}x + 2\sqrt{2}c_2 \cos 2\sqrt{2}x; y(0) = -1 \Rightarrow c_1 = -1$, and $y'(0) = 2 \Rightarrow 2\sqrt{2}c_2 = 2$
 $\Rightarrow c_1 = -1$ and $c_2 = \frac{1}{\sqrt{2}} \Rightarrow y = -\cos 2\sqrt{2}x + \frac{1}{\sqrt{2}} \sin 2\sqrt{2}x$

36. $y'' + 4y' + 4y = 0, y(0) = 0, y'(0) = 1 \Rightarrow r^2 + 4r + 4 = 0 \Rightarrow (r + 2)^2 = 0 \Rightarrow r = -2$ repeated twice
 $\Rightarrow y = c_1 e^{-2x} + c_2 x e^{-2x} \Rightarrow y' = -2c_1 e^{-2x} + c_2 e^{-2x} - 2c_2 x e^{-2x}; y(0) = 0 \Rightarrow c_1 = 0$, and
 $y'(0) = 1 \Rightarrow -2c_1 + c_2 = 1 \Rightarrow c_1 = 0$ and $c_2 = 1 \Rightarrow y = x e^{-2x}$
37. $y'' - 4y' + 4y = 0, y(0) = 1, y'(0) = 0 \Rightarrow r^2 - 4r + 4 = 0 \Rightarrow (r - 2)^2 = 0 \Rightarrow r = 2$ repeated twice
 $\Rightarrow y = c_1 e^{2x} + c_2 x e^{2x} \Rightarrow y' = 2c_1 e^{2x} + c_2 e^{2x} + 2c_2 x e^{2x}; y(0) = 1 \Rightarrow c_1 = 1$, and $y'(0) = 0 \Rightarrow 2c_1 + c_2 = 0$
 $\Rightarrow c_1 = 1$ and $c_2 = -2 \Rightarrow y = e^{2x} - 2x e^{2x}$
38. $4y'' - 4y' + y = 0, y(0) = 4, y'(0) = 4 \Rightarrow 4r^2 - 4r + 1 = 0 \Rightarrow (2r - 1)^2 = 0 \Rightarrow r = \frac{1}{2}$ repeated twice
 $\Rightarrow y = c_1 e^{\frac{1}{2}x} + c_2 x e^{\frac{1}{2}x} \Rightarrow y' = \frac{1}{2}c_1 e^{\frac{1}{2}x} + c_2 e^{\frac{1}{2}x} + \frac{1}{2}c_2 x e^{\frac{1}{2}x}; y(0) = 4 \Rightarrow c_1 = 4$,
and $y'(0) = 4 \Rightarrow \frac{1}{2}c_1 + c_2 = 4 \Rightarrow c_1 = 4$ and $c_2 = 2 \Rightarrow y = 4e^{\frac{1}{2}x} + 2x e^{\frac{1}{2}x}$
39. $4\frac{d^2y}{dx^2} + 12\frac{dy}{dx} + 9y = 0, y(0) = 2, \frac{dy}{dx}(0) = 1 \Rightarrow 4r^2 + 12r + 9 = 0 \Rightarrow (2r + 3)^2 = 0 \Rightarrow r = -\frac{3}{2}$ repeated twice
 $\Rightarrow y = c_1 e^{-\frac{3}{2}x} + c_2 x e^{-\frac{3}{2}x} \Rightarrow \frac{dy}{dx} = -\frac{3}{2}c_1 e^{-\frac{3}{2}x} + c_2 e^{-\frac{3}{2}x} - \frac{3}{2}c_2 x e^{-\frac{3}{2}x}; y(0) = 2 \Rightarrow c_1 = 2$, and $\frac{dy}{dx}(0) = 1$
 $\Rightarrow -\frac{3}{2}c_1 + c_2 = 1 \Rightarrow c_1 = 2$ and $c_2 = 4 \Rightarrow y = 2e^{-\frac{3}{2}x} + 4x e^{-\frac{3}{2}x}$
40. $9\frac{d^2y}{dx^2} - 12\frac{dy}{dx} + 4y = 0, y(0) = -1, \frac{dy}{dx}(0) = 1 \Rightarrow 9r^2 - 12r + 4 = 0 \Rightarrow (3r - 2)^2 = 0 \Rightarrow r = \frac{2}{3}$ repeated twice
 $\Rightarrow y = c_1 e^{\frac{2}{3}x} + c_2 x e^{\frac{2}{3}x} \Rightarrow \frac{dy}{dx} = \frac{2}{3}c_1 e^{\frac{2}{3}x} + c_2 e^{\frac{2}{3}x} + \frac{2}{3}c_2 x e^{\frac{2}{3}x}; y(0) = -1 \Rightarrow c_1 = -1$, and $\frac{dy}{dx}(0) = 1$
 $\Rightarrow \frac{2}{3}c_1 + c_2 = 1 \Rightarrow c_1 = -1$ and $c_2 = \frac{5}{3} \Rightarrow y = -e^{\frac{2}{3}x} + \frac{5}{3}x e^{\frac{2}{3}x}$
41. $y'' - 2y' - 3y = 0 \Rightarrow r^2 - 2r - 3 = 0 \Rightarrow (r - 3)(r + 1) = 0 \Rightarrow r = 3$ or $r = -1 \Rightarrow y = c_1 e^{3x} + c_2 e^{-x}$
42. $6y'' - y' - y = 0 \Rightarrow 6r^2 - r - 1 = 0 \Rightarrow (2r - 1)(3r + 1) = 0 \Rightarrow r = \frac{1}{2}$ or $r = -\frac{1}{3} \Rightarrow y = c_1 e^{\frac{1}{2}x} + c_2 e^{-\frac{1}{3}x}$
43. $4y'' + 4y' + y = 0 \Rightarrow 4r^2 + 4r + 1 = 0 \Rightarrow (2r + 1)^2 = 0 \Rightarrow r = -\frac{1}{2}$ repeated twice $\Rightarrow y = c_1 e^{-\frac{1}{2}x} + c_2 x e^{-\frac{1}{2}x}$
44. $9y'' + 12y' + 4y = 0 \Rightarrow 9r^2 + 12r + 4 = 0 \Rightarrow (3r + 2)^2 = 0 \Rightarrow r = -\frac{2}{3}$ repeated twice $\Rightarrow y = c_1 e^{-\frac{2}{3}x} + c_2 x e^{-\frac{2}{3}x}$
45. $4y'' + 20y = 0 \Rightarrow 4r^2 + 20 = 0 \Rightarrow r = 0 \pm 5i \Rightarrow y = e^{0x} (c_1 \cos \sqrt{5}x + c_2 \sin \sqrt{5}x) \Rightarrow y = c_1 \cos \sqrt{5}x + c_2 \sin \sqrt{5}x$
46. $y'' + 2y' + 2y = 0 \Rightarrow r^2 + 2r + 2 = 0 \Rightarrow r = \frac{-2 \pm \sqrt{(2)^2 - 4(1)(2)}}{2(1)} = -1 \pm i \Rightarrow y = e^{-x}(c_1 \cos x + c_2 \sin x)$
47. $25y'' + 10y' + y = 0 \Rightarrow 25r^2 + 10r + 1 = 0 \Rightarrow (5r + 1)^2 = 0 \Rightarrow r = -\frac{1}{5}$ repeated twice $\Rightarrow y = c_1 e^{-\frac{1}{5}x} + c_2 x e^{-\frac{1}{5}x}$
48. $6y'' + 13y' - 5y = 0 \Rightarrow 6r^2 + 13r - 5 = 0 \Rightarrow (3r - 1)(2r + 5) = 0 \Rightarrow r = \frac{1}{3}$ or $r = -\frac{5}{2} \Rightarrow y = c_1 e^{\frac{1}{3}x} + c_2 e^{-\frac{5}{2}x}$
49. $4y'' + 4y' + 5y = 0 \Rightarrow 4r^2 + 4r + 5 = 0 \Rightarrow r = \frac{-4 \pm \sqrt{(4)^2 - 4(4)(5)}}{2(4)} = -\frac{1}{2} \pm i \Rightarrow y = e^{-\frac{1}{2}x}(c_1 \cos x + c_2 \sin x)$
50. $y'' + 4y' + 6y = 0 \Rightarrow r^2 + 4r + 6 = 0 \Rightarrow r = \frac{-4 \pm \sqrt{(4)^2 - 4(1)(6)}}{2(1)} = -2 \pm \sqrt{2}i \Rightarrow y = e^{-2x}(c_1 \cos \sqrt{2}x + c_2 \sin \sqrt{2}x)$
51. $16y'' - 24y' + 9y = 0 \Rightarrow 16r^2 - 24r + 9 = 0 \Rightarrow (4r - 3)^2 = 0 \Rightarrow r = \frac{3}{4}$ repeated twice $\Rightarrow y = c_1 e^{\frac{3}{4}x} + c_2 x e^{\frac{3}{4}x}$

1006 Chapter 17 Second-Order Differential Equations

52. $6y'' - 5y' - 6y = 0 \Rightarrow 6r^2 - 5r - 6 = 0 \Rightarrow (2r - 3)(3r + 2) = 0 \Rightarrow r = \frac{3}{2}$ or $r = -\frac{2}{3} \Rightarrow y = c_1 e^{\frac{3}{2}x} + c_2 e^{-\frac{2}{3}x}$

53. $9y'' + 24y' + 16y = 0 \Rightarrow 9r^2 + 24r + 16 = 0 \Rightarrow (3r + 4)^2 = 0 \Rightarrow r = -\frac{4}{3}$ repeated twice $\Rightarrow y = c_1 e^{-\frac{4}{3}x} + c_2 x e^{-\frac{4}{3}x}$

54. $4y'' + 16y' + 52y = 0 \Rightarrow 4r^2 + 16r + 52 = 0 \Rightarrow r = \frac{-16 \pm \sqrt{(16)^2 - 4(4)(52)}}{2(4)} = -2 \pm 3i \Rightarrow y = e^{-2x}(c_1 \cos 3x + c_2 \sin 3x)$

55. $6y'' - 5y' - 4y = 0 \Rightarrow 6r^2 - 5r - 4 = 0 \Rightarrow (3r - 4)(2r + 1) = 0 \Rightarrow r = \frac{4}{3}$ or $r = -\frac{1}{2} \Rightarrow y = c_1 e^{\frac{4}{3}x} + c_2 e^{-\frac{1}{2}x}$

56. $y'' - 2y' + 2y = 0, y(0) = 0, y'(0) = 2 \Rightarrow r^2 - 2r + 2 = 0 \Rightarrow r = \frac{-(-2) \pm \sqrt{(-2)^2 - 4(1)(2)}}{2(1)} = 1 \pm i$
 $\Rightarrow y = e^x(c_1 \cos x + c_2 \sin x) \Rightarrow y' = e^x(c_1 \cos x + c_2 \sin x) + e^x(-c_1 \sin x + c_2 \cos x); y(0) = 0 \Rightarrow c_1 = 0$, and
 $y'(0) = 2 \Rightarrow c_1 + c_2 = 2 \Rightarrow c_1 = 0$ and $c_2 = 2 \Rightarrow y = 2e^x \sin x$

57. $y'' + 2y' + y = 0, y(0) = 1, y'(0) = 1 \Rightarrow r^2 + 2r + 1 = 0 \Rightarrow (r + 1)^2 = 0 \Rightarrow r = -1$, repeated twice
 $\Rightarrow y = c_1 e^{-x} + c_2 x e^{-x} \Rightarrow y' = -c_1 e^{-x} - c_2 x e^{-x} + c_2 e^{-x}; y(0) = 1 \Rightarrow c_1 = 1$, and $y'(0) = 1 \Rightarrow -c_1 + c_2 = 1$
 $\Rightarrow c_1 = 1$ and $c_2 = 2 \Rightarrow y = e^{-x} + 2x e^{-x}$

58. $4y'' - 4y' + y = 0, y(0) = -1, y'(0) = 2 \Rightarrow 4r^2 - 4r + 1 = 0 \Rightarrow (2r - 1)^2 = 0 \Rightarrow r = \frac{1}{2}$, repeated twice
 $\Rightarrow y = c_1 e^{\frac{1}{2}x} + c_2 x e^{\frac{1}{2}x} \Rightarrow y' = \frac{1}{2}c_1 e^{\frac{1}{2}x} + \frac{1}{2}c_2 x e^{\frac{1}{2}x} + c_2 e^{\frac{1}{2}x}; y(0) = -1 \Rightarrow c_1 = -1$, and $y'(0) = 2$
 $\Rightarrow \frac{1}{2}c_1 + c_2 = 2 \Rightarrow c_1 = -1$ and $c_2 = \frac{5}{2} \Rightarrow y = -e^{\frac{1}{2}x} + \frac{5}{2}x e^{\frac{1}{2}x}$

59. $3y'' + y' - 14y = 0, y(0) = 2, y'(0) = -1 \Rightarrow 3r^2 + r - 14 = 0 \Rightarrow (3r + 7)(r - 2) = 0 \Rightarrow r = -\frac{7}{3}$ or $r = 2$
 $\Rightarrow y = c_1 e^{-\frac{7}{3}x} + c_2 e^{2x} \Rightarrow y' = -\frac{7}{3}c_1 e^{-\frac{7}{3}x} + 2c_2 e^{2x}; y(0) = 2 \Rightarrow c_1 + c_2 = 2$, and $y'(0) = -1 \Rightarrow -\frac{7}{3}c_1 + 2c_2 = -1$
 $\Rightarrow c_1 = \frac{15}{13}$ and $c_2 = \frac{11}{13} \Rightarrow y = \frac{15}{13}e^{-(7/3)x} + \frac{11}{13}e^{2x}$

60. $4y'' + 4y' + 5y = 0, y(\pi) = 1, y'(\pi) = 0 \Rightarrow 4r^2 + 4r + 5 = 0 \Rightarrow r = \frac{-4 \pm \sqrt{(4)^2 - 4(4)(5)}}{2(4)} = -\frac{1}{2} \pm i$
 $\Rightarrow y = e^{-\frac{1}{2}x}(c_1 \cos x + c_2 \sin x) \Rightarrow y' = -\frac{1}{2}e^{-\frac{1}{2}x}(c_1 \cos x + c_2 \sin x) + e^{-\frac{1}{2}x}(-c_1 \sin x + c_2 \cos x); y(\pi) = 1$
 $\Rightarrow -e^{-\frac{\pi}{2}}c_1 = 1$, and $y'(\pi) = 0 \Rightarrow -\frac{1}{2}e^{-\frac{\pi}{2}}c_1 + e^{-\frac{\pi}{2}}c_2 = 0 \Rightarrow c_1 = -e^{\frac{\pi}{2}}$ and $c_2 = -\frac{1}{2}e^{\frac{\pi}{2}}$
 $\Rightarrow y = e^{-\frac{1}{2}x}(-e^{\frac{\pi}{2}} \cos x - \frac{1}{2}e^{\frac{\pi}{2}} \sin x)$

61. Let r_1 and r_2 be real roots with $r_1 \neq r_2$. If $e^{r_1 x}$ and $e^{r_2 x}$ are linearly independent, then $e^{r_1 x}$ is not a constant multiple of $e^{r_2 x}$ (and vice versa). Assume that $e^{r_1 x}$ is a constant multiple of $e^{r_2 x}$, then for some nonzero constant c , $e^{r_1 x} = c e^{r_2 x} \Rightarrow \frac{e^{r_1 x}}{e^{r_2 x}} = c \Rightarrow e^{r_1 x - r_2 x} = c \Rightarrow e^{(r_1 - r_2)x} = c$. Since $r_1 \neq r_2$, c is not a constant, which is a contradiction. Thus $e^{r_1 x}$ and $e^{r_2 x}$ are linearly independent.

62. Let r be the only repeated real root. If e^{rx} and $x e^{rx}$ are linearly independent, then e^{rx} is not a constant multiple of $x e^{rx}$ (and vice versa). Assume that $x e^{rx}$ is a constant multiple of e^{rx} , then for some nonzero constant c , $x e^{rx} = c e^{rx} \Rightarrow x e^{rx} - c e^{rx} = 0 \Rightarrow e^{rx}(x - c) = 0 \Rightarrow e^{rx} = 0$ or $x - c = 0$. Since $e^{rx} \neq 0 \Rightarrow x = c$, thus c is not a constant, which is a contradiction. Thus e^{rx} and $x e^{rx}$ are linearly independent.

63. Let $r_1 = \alpha + i\beta$ and $r_2 = \alpha - i\beta$ be complex roots. If $e^{\alpha x} \cos \beta x$ and $e^{\alpha x} \sin \beta x$ are linearly independent, then $e^{\alpha x} \cos \beta x$ is not a constant multiple of $e^{\alpha x} \sin \beta x$ (and vice versa). Assume that $e^{\alpha x} \cos \beta x$ is a constant multiple of $e^{\alpha x} \sin \beta x$, then for some nonzero constant c , $e^{\alpha x} \cos \beta x = c e^{\alpha x} \sin \beta x \Rightarrow e^{\alpha x} \cos \beta x - c e^{\alpha x} \sin \beta x = 0 \Rightarrow e^{\alpha x} (\cos \beta x - c \sin \beta x) = 0 \Rightarrow e^{\alpha x} = 0$ or $\cos \beta x - c \sin \beta x = 0$. Since $e^{\alpha x} \neq 0 \Rightarrow c = \cot \beta x$, thus c is not a constant, which is a contradiction. Thus $e^{\alpha x} \cos \beta x$ and $e^{\alpha x} \sin \beta x$ are linearly independent.
64. Let y_1 and y_2 be linearly independent solutions of $P(x)y'' + Q(x)y' + R(x)y = 0$. Let $y_3 = y_1 + y_2 \Rightarrow y_3' = y_1' + y_2' \Rightarrow y_3'' = y_1'' + y_2''$. Then $P(x)y_3'' + Q(x)y_3' + R(x)y_3 = P(x)(y_1'' + y_2'') + Q(x)(y_1' + y_2') + R(x)(y_1 + y_2) = P(x)y_1'' + P(x)y_2'' + Q(x)y_1' + Q(x)y_2' + R(x)y_1 + R(x)y_2 = P(x)y_1'' + Q(x)y_1' + R(x)y_1 + P(x)y_2'' + Q(x)y_2' + R(x)y_2 = 0 + 0 = 0$. Let $y_4 = y_1 - y_2 \Rightarrow y_4' = y_1' - y_2' \Rightarrow y_4'' = y_1'' - y_2''$. Then $P(x)y_4'' + Q(x)y_4' + R(x)y_4 = P(x)(y_1'' - y_2'') + Q(x)(y_1' - y_2') + R(x)(y_1 - y_2) = P(x)y_1'' - P(x)y_2'' + Q(x)y_1' - Q(x)y_2' + R(x)y_1 - R(x)y_2 = P(x)y_1'' + Q(x)y_1' + R(x)y_1 - [P(x)y_2'' + Q(x)y_2' + R(x)y_2] = 0 - 0 = 0$. Thus y_3 and y_4 are both solutions. Suppose that y_3 is a constant multiple of y_4 , then there is a nonzero constant c such that $y_3 = c y_4$. $\Rightarrow y_1 + y_2 = c(y_1 - y_2)$. If we solve this equation for y_1 we obtain $y_1 = -\frac{1+c}{1-c}y_2 \Rightarrow y_1$ is a constant multiple of y_2 , which is a contradiction since y_1 and y_2 are linearly independent $\Rightarrow y_1 + y_2$ and $y_1 - y_2$ are linearly independent.
65. (a) $y'' + 4y = 0, y(0) = 0, y(\pi) = 1 \Rightarrow r^2 + 4 = 0 \Rightarrow r = 0 \pm 2i \Rightarrow y = e^{0 \cdot x}(c_1 \cos 2x + c_2 \sin 2x) \Rightarrow y = c_1 \cos 2x + c_2 \sin 2x; y(0) = 0 \Rightarrow c_1 = 0$, and $y(\pi) = 1 \Rightarrow c_1 = 1 \Rightarrow$ no solution
- (b) $y'' + 4y = 0, y(0) = 0, y(\pi) = 0 \Rightarrow r^2 + 4 = 0 \Rightarrow r = 0 \pm 2i \Rightarrow y = e^{0 \cdot x}(c_1 \cos 2x + c_2 \sin 2x) \Rightarrow y = c_1 \cos 2x + c_2 \sin 2x; y(0) = 0 \Rightarrow c_1 = 0$, and $y(\pi) = 0 \Rightarrow c_1 = 0 \Rightarrow c_1 = 0, c_2$ can be any real number $\Rightarrow y = c_2 \sin 2x$
66. Let a, b , and c be positive constants, then $r = \frac{-b \pm \sqrt{b^2 - 4ac}}{2a} = -\frac{b}{2a} \pm \frac{\sqrt{b^2 - 4ac}}{2a}$. There are three cases to consider.
- Case I: Two distinct real solutions $\Rightarrow b^2 - 4ac > 0$. Since a, b , and c are positive $\Rightarrow 4ac > 0$ and $b > 0 \Rightarrow -4ac < 0$ and $-b < 0 \Rightarrow 0 < b^2 - 4ac < b^2 \Rightarrow 0 < \sqrt{b^2 - 4ac} < b \Rightarrow -b + \sqrt{b^2 - 4ac} < 0$ and $-b - \sqrt{b^2 - 4ac} < 0$. Since $2a > 0 \Rightarrow \frac{-b \pm \sqrt{b^2 - 4ac}}{2a} < 0$. Thus $r_1 = \frac{-b + \sqrt{b^2 - 4ac}}{2a} < 0$ and $r_2 = \frac{-b - \sqrt{b^2 - 4ac}}{2a} < 0$. The general solution to the differential equation is $y = c_1 e^{r_1 x} + c_2 e^{r_2 x}$. $\lim_{x \rightarrow \infty} (c_1 e^{r_1 x} + c_2 e^{r_2 x}) = 0 + 0 = 0$.
- Case II: One repeated real solution $\Rightarrow b^2 - 4ac = 0$. Since a, b , and c are positive $\Rightarrow 2a > 0$ and $-b < 0 \Rightarrow r = -\frac{b}{2a} < 0$. The general solution to the differential equation is $y = c_1 e^{rx} + c_2 x e^{rx}$. Since $r < 0 \Rightarrow -r > 0$. $\lim_{x \rightarrow \infty} (c_1 e^{rx} + c_2 x e^{rx}) = \lim_{x \rightarrow \infty} (c_1 e^{rx} + \frac{c_2 x}{e^{-rx}}) = \lim_{x \rightarrow \infty} (c_1 e^{rx}) + \lim_{x \rightarrow \infty} (\frac{c_2 x}{e^{-rx}}) = 0 + \lim_{x \rightarrow \infty} (\frac{c_2}{-r e^{-rx}}) = 0$, using L'Hopital's rule to evaluate the limit of the second expression.
- Case III: Two complex, nonreal solutions $\Rightarrow b^2 - 4ac < 0 \Rightarrow 4ac - b^2 > 0$. Since a, b , and c are positive $\Rightarrow 2a > 0$ and $-b < 0 \Rightarrow -\frac{b}{2a} < 0$. The roots are $r_1 = -\frac{b}{2a} + \frac{\sqrt{4ac - b^2}}{2a}i$ and $r_2 = -\frac{b}{2a} - \frac{\sqrt{4ac - b^2}}{2a}i$, thus $\alpha = -\frac{b}{2a} < 0$ and $\beta = \frac{\sqrt{4ac - b^2}}{2a} > 0$. The general solution to the differential equation is $y = e^{\alpha x}(c_1 \cos \beta x + c_2 \sin \beta x)$. Since $-1 \leq \sin \beta x \leq 1$ and $-1 \leq \cos \beta x \leq 1 \Rightarrow -|c_2| \leq c_2 \sin \beta x \leq |c_2|$ and $-|c_1| \leq c_1 \cos \beta x \leq |c_1| \Rightarrow -|c_1| - |c_2| \leq c_1 \cos \beta x + c_2 \sin \beta x \leq |c_1| + |c_2| \Rightarrow e^{\alpha x}(-|c_1| - |c_2|) \leq e^{\alpha x}(c_1 \cos \beta x + c_2 \sin \beta x) \leq e^{\alpha x}(|c_1| + |c_2|) \lim_{x \rightarrow \infty} [e^{\alpha x}(-|c_1| - |c_2|)] = (-|c_1| - |c_2|) \lim_{x \rightarrow \infty} e^{\alpha x} = 0$ and $\lim_{x \rightarrow \infty} [e^{\alpha x}(|c_1| + |c_2|)] = (|c_1| + |c_2|) \lim_{x \rightarrow \infty} e^{\alpha x} = 0$ thus by the Sandwich theorem, $\lim_{x \rightarrow \infty} [e^{\alpha x}(c_1 \cos \beta x + c_2 \sin \beta x)] = 0$.

17.2 NONHOMOGENEOUS LINEAR EQUATIONS

- $y'' - 3y' - 10y = -3 \Rightarrow r^2 - 3r - 10 = 0 \Rightarrow (r - 5)(r + 2) = 0 \Rightarrow r = 5 \text{ or } r = -2 \Rightarrow y_c = c_1e^{5x} + c_2e^{-2x}; y_p = A$
 $\Rightarrow y_p' = 0 \Rightarrow y_p'' = 0 \Rightarrow 0 - 3(0) - 10A = -3 \Rightarrow A = \frac{3}{10} \Rightarrow y = c_1e^{5x} + c_2e^{-2x} + \frac{3}{10}$
- $y'' - 3y' - 10y = 2x - 3 \Rightarrow r^2 - 3r - 10 = 0 \Rightarrow (r - 5)(r + 2) = 0 \Rightarrow r = 5 \text{ or } r = -2 \Rightarrow y_c = c_1e^{5x} + c_2e^{-2x};$
 $y_p = Ax + B \Rightarrow y_p' = A \Rightarrow y_p'' = 0 \Rightarrow 0 - 3A - 10(Ax + B) = 2x - 3 \Rightarrow -10Ax + (-3A - 10B) = 2x - 3$
 $\Rightarrow -10A = 2, -3A - 10B = -3 \Rightarrow A = -\frac{1}{5}, B = \frac{9}{25} \Rightarrow y = c_1e^{5x} + c_2e^{-2x} - \frac{1}{5}x + \frac{9}{25}$
- $y'' - y' = \sin x \Rightarrow r^2 - r = 0 \Rightarrow r(r - 1) = 0 \Rightarrow r = 0 \text{ or } r = 1 \Rightarrow y_c = c_1e^{0 \cdot x} + c_2e^x = c_1 + c_2e^x;$
 $y_p = A \sin x + B \cos x \Rightarrow y_p' = A \cos x - B \sin x \Rightarrow y_p'' = -A \sin x - B \cos x$
 $\Rightarrow -A \sin x - B \cos x - (A \cos x - B \sin x) = \sin x \Rightarrow (-A + B)\sin x + (-A - B)\cos x = \sin x$
 $\Rightarrow -A + B = 1, -A - B = 0 \Rightarrow A = -\frac{1}{2}, B = \frac{1}{2} \Rightarrow y = c_1 + c_2e^x - \frac{1}{2} \sin x + \frac{1}{2} \cos x$
- $y'' + 2y' + y = x^2 \Rightarrow r^2 + 2r + 1 = 0 \Rightarrow (r + 1)^2 = 0 \Rightarrow r = -1 \text{ repeated twice} \Rightarrow y_c = c_1e^{-x} + c_2xe^{-x};$
 $y_p = Ax^2 + Bx + C \Rightarrow y_p' = 2Ax + B \Rightarrow y_p'' = 2A \Rightarrow (Ax^2 + Bx + C) + 2(2Ax + B) + 2A = x^2$
 $\Rightarrow Ax^2 + (4A + B)x + (2A + 2B + C) = x^2 \Rightarrow A = 1, 4A + B = 0, 2A + 2B + C = 0 \Rightarrow A = 1, B = -4,$
 $C = 6 \Rightarrow y = c_1e^{-x} + c_2xe^{-x} + x^2 - 4x + 6$
- $y'' + y = \cos 3x \Rightarrow r^2 + 1 = 0 \Rightarrow r = 0 \pm i \Rightarrow y_c = e^{0 \cdot x}(c_1 \cos x + c_2 \sin x) = c_1 \cos x + c_2 \sin x;$
 $y_p = A \sin 3x + B \cos 3x \Rightarrow y_p' = 3A \cos 3x - 3B \sin 3x \Rightarrow y_p'' = -9A \sin 3x - 9B \cos 3x$
 $\Rightarrow -9A \sin 3x - 9B \cos 3x + (A \sin 3x + B \cos 3x) = \cos 3x \Rightarrow -8A \sin x - 8B \cos x = \cos 3x$
 $\Rightarrow -8A = 0, -8B = 1 \Rightarrow A = 0, B = -\frac{1}{8} \Rightarrow y = c_1 \cos x + c_2 \sin x - \frac{1}{8} \cos 3x$
- $y'' + y = e^{2x} \Rightarrow r^2 + 1 = 0 \Rightarrow r = 0 \pm i \Rightarrow y_c = e^{0 \cdot x}(c_1 \cos x + c_2 \sin x) = c_1 \cos x + c_2 \sin x;$
 $y_p = Ae^{2x} \Rightarrow y_p' = 2Ae^{2x} \Rightarrow y_p'' = 4Ae^{2x} \Rightarrow 4Ae^{2x} + Ae^{2x} = e^{2x} \Rightarrow 5Ae^{2x} = e^{2x} \Rightarrow 5A = 1$
 $\Rightarrow A = \frac{1}{5} \Rightarrow y = c_1 \cos x + c_2 \sin x + \frac{1}{5}e^{2x}$
- $y'' - y' - 2y = 20 \cos x \Rightarrow r^2 - r - 2 = 0 \Rightarrow (r - 2)(r + 1) = 0 \Rightarrow r = 2 \text{ or } r = -1 \Rightarrow y_c = c_1e^{2x} + c_2e^{-x};$
 $y_p = A \sin x + B \cos x \Rightarrow y_p' = A \cos x - B \sin x \Rightarrow y_p'' = -A \sin x - B \cos x$
 $\Rightarrow -A \sin x - B \cos x - (A \cos x - B \sin x) - 2(A \sin x + B \cos x) = 20 \cos x$
 $\Rightarrow (-3A + B)\sin x + (-A - 3B)\cos x = 20 \cos x \Rightarrow -3A + B = 0, -A - 3B = 20 \Rightarrow A = -2, B = -6$
 $\Rightarrow y = c_1e^{2x} + c_2e^{-x} - 2 \sin x - 6 \cos x$
- $y'' + y = 2x + 3e^x \Rightarrow r^2 + 1 = 0 \Rightarrow r = 0 \pm i \Rightarrow y_c = c_1 \cos x + c_2 \sin x; y_p = Ax + B + Ce^x \Rightarrow y_p' = A + Ce^x$
 $\Rightarrow y_p'' = Ce^x \Rightarrow Ce^x + (Ax + B + Ce^x) = 2x + 3e^x \Rightarrow Ax + B + 2Ce^x = 2x + 3e^x \Rightarrow A = 2, B = 0, 2C = 3$
 $\Rightarrow A = 2, B = 0, C = \frac{3}{2} \Rightarrow y = c_1 \cos x + c_2 \sin x + 2x + \frac{3}{2}e^x$
- $y'' - y = e^x + x^2 \Rightarrow r^2 - 1 = 0 \Rightarrow (r - 1)(r + 1) = 0 \Rightarrow r = 1 \text{ or } r = -1 \Rightarrow y_c = c_1e^x + c_2e^{-x};$
 $y_p = Axe^x + Bx^2 + Cx + D \Rightarrow y_p' = Ae^x + Axe^x + 2Bx + C \Rightarrow y_p'' = 2Ae^x + Axe^x + 2B$
 $\Rightarrow (2Ae^x + Axe^x + 2B) - (Axe^x + Bx^2 + Cx + D) = e^x + x^2 \Rightarrow 2Ae^x - Bx^2 - Cx + (2B - D) = e^x + x^2$
 $\Rightarrow 2A = 1, -B = 1, -C = 0, 2B - D = 0 \Rightarrow A = \frac{1}{2}, B = -1, C = 0, D = -2$
 $\Rightarrow y = c_1e^x + c_2e^{-x} + \frac{1}{2}xe^x - x^2 - 2$

10. $y'' + 2y' + y = 6\sin 2x \Rightarrow r^2 + 2r + 1 = 0 \Rightarrow (r + 1)^2 = 0 \Rightarrow r = -1$, repeated twice $\Rightarrow y_c = c_1e^{-x} + c_2xe^{-x}$;
 $y_p = A \sin 2x + B \cos 2x \Rightarrow y_p' = 2A \cos 2x - 2B \sin 2x \Rightarrow y_p'' = -4A \sin 2x - 4B \cos 2x$
 $\Rightarrow -4A \sin 2x - 4B \cos 2x + 2(2A \cos 2x - 2B \sin 2x) + (A \sin 2x + B \cos 2x) = 6\sin 2x$
 $\Rightarrow (-3A - 4B)\sin 2x + (4A - 3B)\cos 2x = 6\sin 2x \Rightarrow -3A - 4B = 6, 4A - 3B = 0 \Rightarrow A = -\frac{24}{25}, B = -\frac{18}{25}$
 $\Rightarrow y = c_1e^{-x} + c_2xe^{-x} - \frac{24}{25}\sin 2x - \frac{18}{25}\cos 2x$
11. $y'' - y' - 6y = e^{-x} - 7\cos x \Rightarrow r^2 - r - 6 = 0 \Rightarrow (r - 3)(r + 2) = 0 \Rightarrow r = 3$ or $r = -2 \Rightarrow y_c = c_1e^{3x} + c_2e^{-2x}$;
 $y_p = Ae^{-x} + B \sin x + C \cos x \Rightarrow y_p' = -Ae^{-x} + B \cos x - C \sin x \Rightarrow y_p'' = Ae^{-x} - B \sin x - C \cos x$
 $\Rightarrow Ae^{-x} - B \sin x - C \cos x - (-Ae^{-x} + B \cos x - C \sin x) - 6(Ae^{-x} + B \sin x + C \cos x) = e^{-x} - 7\cos x$
 $\Rightarrow -4Ae^{-x} + (-7B + C)\sin x + (-B - 7C)\cos x = e^{-x} - 7\cos x \Rightarrow -4A = 1, -7B + C = 0, -B - 7C = -7$
 $\Rightarrow A = -\frac{1}{4}, B = \frac{7}{50}, C = \frac{49}{50} \Rightarrow y = c_1e^{3x} + c_2e^{-2x} - \frac{1}{4}e^{-x} + \frac{7}{50}\sin x + \frac{49}{50}\cos x$
12. $y'' + 3y' + 2y = e^{-x} + e^{-2x} - x \Rightarrow r^2 + 3r + 2 = 0 \Rightarrow (r + 1)(r + 2) = 0 \Rightarrow r = -1$ or $r = -2 \Rightarrow y_c = c_1e^{-x} + c_2e^{-2x}$;
 $y_p = Ax e^{-x} + Bx e^{-2x} + Cx + D \Rightarrow y_p' = Ae^{-x} - Ax e^{-x} + B e^{-2x} - 2Bx e^{-2x} + C$
 $\Rightarrow y_p'' = -2Ae^{-x} + Ax e^{-x} - 4B e^{-2x} + 4Bx e^{-2x} \Rightarrow -2Ae^{-x} + Ax e^{-x} - 4B e^{-2x} + 4Bx e^{-2x}$
 $+ 3(Ae^{-x} - Ax e^{-x} + B e^{-2x} - 2Bx e^{-2x} + C) + 2(Ax e^{-x} + Bx e^{-2x} + Cx + D) = e^{-x} + e^{-2x} - x$
 $\Rightarrow Ax e^{-x} - B e^{-2x} + 2Cx + (3C + 2D) = e^{-x} + e^{-2x} - x \Rightarrow A = 1, -B = 1, 2C = -1, 3C + 2D = 0$
 $\Rightarrow A = 1, B = -1, C = -\frac{1}{2}, D = \frac{1}{4} \Rightarrow y = c_1e^{-x} + c_2e^{-2x} + x e^{-x} - x e^{-2x} - \frac{1}{2}x + \frac{1}{4}$
13. $\frac{d^2y}{dx^2} + 5\frac{dy}{dx} = 15x^2 \Rightarrow r^2 + 5r = 0 \Rightarrow r(r + 5) = 0 \Rightarrow r = 0$ or $r = -5 \Rightarrow y_c = c_1e^{0x} + c_2e^{-5x} = c_1 + c_2e^{-5x}$;
 $y_p = Ax^3 + Bx^2 + Cx \Rightarrow y_p' = 3Ax^2 + 2Bx + C \Rightarrow y_p'' = 6Ax + 2B \Rightarrow 6Ax + 2B + 5(3Ax^2 + 2Bx + C) = 15x^2$
 $\Rightarrow 15Ax^2 + (6A + 10B)x + (2B + 5C) = 15x^2 \Rightarrow 15A = 15, 6A + 10B = 0, 2B + 5C = 0 \Rightarrow A = 1, B = -\frac{3}{5}, C = \frac{6}{25}$
 $\Rightarrow y = c_1 + c_2e^{-5x} + x^3 - \frac{3}{5}x^2 + \frac{6}{25}x$
14. $\frac{d^2y}{dx^2} - \frac{dy}{dx} = -8x + 3 \Rightarrow r^2 - r = 0 \Rightarrow r(r - 1) = 0 \Rightarrow r = 0$ or $r = 1 \Rightarrow y_c = c_1e^{0x} + c_2e^{1x} = c_1 + c_2e^x$;
 $y_p = Ax^2 + Bx \Rightarrow y_p' = 2Ax + B \Rightarrow y_p'' = 2Ax \Rightarrow 2A - (2Ax + B) = -8x + 3 \Rightarrow -2Ax + (2A - B) = -8x + 3$
 $\Rightarrow -2A = -8, 2A - B = 3 \Rightarrow A = 4, B = 5 \Rightarrow y = c_1 + c_2e^x + 4x^2 + 5x$
15. $\frac{d^2y}{dx^2} - 3\frac{dy}{dx} = e^{3x} - 12x \Rightarrow r^2 - 3r = 0 \Rightarrow r(r - 3) = 0 \Rightarrow r = 0$ or $r = 3 \Rightarrow y_c = c_1e^{0x} + c_2e^{3x} = c_1 + c_2e^{3x}$;
 $y_p = Ax e^{3x} + Bx^2 + Cx \Rightarrow y_p' = Ae^{3x} + 3Axe^{3x} + 2Bx + C \Rightarrow y_p'' = 6Ae^{3x} + 9Axe^{3x} + 2B$
 $\Rightarrow 6Ae^{3x} + 9Axe^{3x} + 2B - 3(Ae^{3x} + 3Axe^{3x} + 2Bx + C) = e^{3x} - 12x \Rightarrow 3Ae^{3x} - 6Bx + (2B - 3C) = e^{3x} - 12x$
 $\Rightarrow 3A = 1, -6B = 12, 2B - 3C = 0 \Rightarrow A = \frac{1}{3}, B = 2, C = \frac{4}{3} \Rightarrow y = c_1 + c_2e^{3x} + \frac{1}{3}x e^{3x} + 2x^2 + \frac{4}{3}x$
16. $\frac{d^2y}{dx^2} + 7\frac{dy}{dx} = 42x^2 + 5x + 1 \Rightarrow r^2 + 7r = 0 \Rightarrow r(r + 7) = 0 \Rightarrow r = 0$ or $r = -7 \Rightarrow y_c = c_1e^{0x} + c_2e^{-7x} = c_1 + c_2e^{-7x}$;
 $y_p = Ax^3 + Bx^2 + Cx \Rightarrow y_p' = 3Ax^2 + 2Bx + C \Rightarrow y_p'' = 6Ax + 2B$
 $\Rightarrow 6Ax + 2B + 7(3Ax^2 + 2Bx + C) = 42x^2 + 5x + 1 \Rightarrow 21Ax^2 + (6A + 14B)x + (2B + 7C) = 42x^2 + 5x + 1$
 $\Rightarrow 21A = 42, 6A + 14B = 5, 2B + 7C = 1 \Rightarrow A = 2, B = -\frac{1}{2}, C = \frac{2}{7} \Rightarrow y = c_1 + c_2e^{-7x} + 2x^3 - \frac{1}{2}x^2 + \frac{2}{7}x$
17. $y'' + y' = x, \Rightarrow r^2 + r = 0 \Rightarrow r(r + 1) = 0 \Rightarrow r = 0$ or $r = -1 \Rightarrow y_c = c_1e^{0x} + c_2e^{-x} = c_1 + c_2e^{-x} \Rightarrow y_1 = 1, y_2 = e^{-x}$
 $\Rightarrow v_1' = \begin{vmatrix} 0 & e^{-x} \\ x & -e^{-x} \end{vmatrix} = \frac{-xe^{-x}}{-e^{-x}} = x$ and $v_2' = \begin{vmatrix} 1 & 0 \\ 0 & x \end{vmatrix} = \frac{x}{-e^{-x}} = -xe^x \Rightarrow v_1 = \int x dx = \frac{1}{2}x^2$ and
 $v_2 = \int -xe^x dx = -xe^x + e^x \Rightarrow y_p = \frac{1}{2}x^2(1) + (-xe^x + e^x)e^{-x} = \frac{1}{2}x^2 - x + 1 \Rightarrow y = c_1 + c_2e^{-x} + \frac{1}{2}x^2 - x$

$$18. y'' + y = \tan x, -\frac{\pi}{2} < x < \frac{\pi}{2} \Rightarrow r^2 + 1 = 0 \Rightarrow r = 0 \pm i \Rightarrow y_c = c_1 \cos x + c_2 \sin x \Rightarrow y_1 = \cos x, y_2 = \sin x$$

$$\Rightarrow v_1' = \frac{\begin{vmatrix} 0 & \sin x \\ \tan x & \cos x \end{vmatrix}}{\begin{vmatrix} \cos x & \sin x \\ -\sin x & \cos x \end{vmatrix}} = \frac{-\sin x \tan x}{1} = -\sin x \cdot \frac{\sin x}{\cos x} = -\frac{\sin^2 x}{\cos x} \text{ and } v_2' = \frac{\begin{vmatrix} \cos x & 0 \\ -\sin x & \tan x \end{vmatrix}}{\begin{vmatrix} \cos x & \sin x \\ -\sin x & \cos x \end{vmatrix}} = \frac{\cos x \tan x}{1} = \cos x \cdot \frac{\sin x}{\cos x} = \sin x$$

$$\Rightarrow v_1 = -\int \frac{\sin^2 x}{\cos x} dx = \int \frac{\cos^2 x - 1}{\cos x} dx = \int \left(\frac{\cos^2 x}{\cos x} - \frac{1}{\cos x} \right) dx = \int (\cos x - \sec x) dx = \sin x - \ln|\sec x + \tan x| \text{ and}$$

$$v_2 = \int \sin x dx = -\cos x \Rightarrow y_p = (\sin x - \ln|\sec x + \tan x|)(\cos x) + (-\cos x)(\sin x) = -(\cos x) \ln|\sec x + \tan x|$$

$$\Rightarrow y = c_1 \cos x + c_2 \sin x - (\cos x) \ln|\sec x + \tan x|$$

$$19. y'' + y = \sin x \Rightarrow r^2 + 1 = 0 \Rightarrow r = 0 \pm i \Rightarrow y_c = c_1 \cos x + c_2 \sin x \Rightarrow y_1 = \cos x, y_2 = \sin x$$

$$\Rightarrow v_1' = \frac{\begin{vmatrix} 0 & \sin x \\ \sin x & \cos x \end{vmatrix}}{\begin{vmatrix} \cos x & \sin x \\ -\sin x & \cos x \end{vmatrix}} = \frac{-\sin^2 x}{1} = -\sin^2 x \text{ and } v_2' = \frac{\begin{vmatrix} \cos x & 0 \\ -\sin x & \sin x \end{vmatrix}}{\begin{vmatrix} \cos x & \sin x \\ -\sin x & \cos x \end{vmatrix}} = \frac{\sin x \cos x}{1} = \sin x \cos x$$

$$\Rightarrow v_1 = \int -\sin^2 x dx = \int \frac{\cos 2x - 1}{2} dx = \frac{1}{4} \sin 2x - \frac{1}{2} x, \text{ and } v_2 = \int \sin x \cos x dx = \frac{1}{2} \sin^2 x$$

$$\Rightarrow y_p = \left(\frac{1}{4} \sin 2x - \frac{1}{2} x \right) (\cos x) + \left(\frac{1}{2} \sin^2 x \right) (\sin x) = \frac{1}{2} \sin x \cos^2 x - \frac{1}{2} x \cos x + \frac{1}{2} \sin x - \frac{1}{2} \sin x \cos^2 x$$

$$= -\frac{1}{2} x \cos x + \frac{1}{2} \sin x \Rightarrow y = c_1 \cos x + c_2 \sin x - \frac{1}{2} x \cos x$$

$$20. y'' + 2y' + y = e^x \Rightarrow r^2 + 2r + 1 = 0 \Rightarrow (r + 1)^2 = 0 \Rightarrow r = -1, \text{ repeated twice} \Rightarrow y_c = c_1 e^{-x} + c_2 x e^{-x}$$

$$\Rightarrow y_1 = e^{-x}, y_2 = x e^{-x}$$

$$\Rightarrow v_1' = \frac{\begin{vmatrix} 0 & x e^{-x} \\ e^x & e^{-x} - x e^{-x} \end{vmatrix}}{\begin{vmatrix} e^{-x} & x e^{-x} \\ -e^{-x} & e^{-x} - x e^{-x} \end{vmatrix}} = \frac{-x e^{-2x}}{e^{-2x}} = -x e^{2x} \text{ and } v_2' = \frac{\begin{vmatrix} e^{-x} & 0 \\ -e^{-x} & e^x \end{vmatrix}}{\begin{vmatrix} e^{-x} & x e^{-x} \\ -e^{-x} & e^{-x} - x e^{-x} \end{vmatrix}} = \frac{1}{e^{-2x}} = e^{2x} \Rightarrow v_1 = -\int x e^{2x} dx = -\frac{1}{2} x e^{2x} + \frac{1}{4} e^{2x}$$

$$\text{and } v_2 = \int e^{2x} dx = \frac{1}{2} e^{2x} \Rightarrow y_p = \left(-\frac{1}{2} x e^{2x} + \frac{1}{4} e^{2x} \right) (e^{-x}) + \left(\frac{1}{2} e^{2x} \right) (x e^{-x}) = \frac{1}{4} e^x \Rightarrow y = c_1 e^{-x} + c_2 x e^{-x} + \frac{1}{4} e^x$$

$$21. y'' + 2y' + y = e^{-x} \Rightarrow r^2 + 2r + 1 = 0 \Rightarrow (r + 1)^2 = 0 \Rightarrow r = -1, \text{ repeated twice} \Rightarrow y_c = c_1 e^{-x} + c_2 x e^{-x}$$

$$\Rightarrow y_1 = e^{-x}, y_2 = x e^{-x}$$

$$\Rightarrow v_1' = \frac{\begin{vmatrix} 0 & x e^{-x} \\ e^{-x} & e^{-x} - x e^{-x} \end{vmatrix}}{\begin{vmatrix} e^{-x} & x e^{-x} \\ -e^{-x} & e^{-x} - x e^{-x} \end{vmatrix}} = \frac{-x e^{-2x}}{e^{-2x}} = -x \text{ and } v_2' = \frac{\begin{vmatrix} e^{-x} & 0 \\ -e^{-x} & e^{-x} \end{vmatrix}}{\begin{vmatrix} e^{-x} & x e^{-x} \\ -e^{-x} & e^{-x} - x e^{-x} \end{vmatrix}} = \frac{e^{-2x}}{e^{-2x}} = 1 \Rightarrow v_1 = -\int x dx = -\frac{1}{2} x^2$$

$$\text{and } v_2 = \int 1 dx = x \Rightarrow y_p = \left(-\frac{1}{2} x^2 \right) (e^{-x}) + (x)(x e^{-x}) = \frac{1}{2} x^2 e^{-x} \Rightarrow y = c_1 e^{-x} + c_2 x e^{-x} + \frac{1}{2} x^2 e^{-x}$$

$$22. y'' - y = x \Rightarrow r^2 - 1 = 0 \Rightarrow (r - 1)(r + 1) = 0 \Rightarrow r = 1 \text{ or } r = -1 \Rightarrow y_c = c_1 e^x + c_2 e^{-x} \Rightarrow y_1 = e^x, y_2 = e^{-x}$$

$$\Rightarrow v_1' = \frac{\begin{vmatrix} 0 & e^{-x} \\ x & -e^{-x} \end{vmatrix}}{\begin{vmatrix} e^x & e^{-x} \\ e^x & -e^{-x} \end{vmatrix}} = \frac{-x e^{-x}}{-2} = \frac{1}{2} x e^{-x} \text{ and } v_2' = \frac{\begin{vmatrix} e^x & 0 \\ e^x & x \end{vmatrix}}{\begin{vmatrix} e^x & e^{-x} \\ e^x & -e^{-x} \end{vmatrix}} = \frac{x e^x}{-2} = -\frac{1}{2} x e^x \Rightarrow v_1 = \frac{1}{2} \int x e^{-x} dx = -\frac{1}{2} x e^{-x} - \frac{1}{2} e^{-x}$$

$$\text{and } v_2 = -\frac{1}{2} \int x e^x dx = -\frac{1}{2} x e^x + \frac{1}{2} e^x \Rightarrow y_p = \left(-\frac{1}{2} x e^{-x} - \frac{1}{2} e^{-x} \right) e^x + \left(-\frac{1}{2} x e^x + \frac{1}{2} e^x \right) e^{-x} = -x$$

$$\Rightarrow y = c_1 e^x + c_2 e^{-x} - x$$

$$23. y'' - y = e^x \Rightarrow r^2 - 1 = 0 \Rightarrow (r - 1)(r + 1) = 0 \Rightarrow r = 1 \text{ or } r = -1 \Rightarrow y_c = c_1 e^x + c_2 e^{-x} \Rightarrow y_1 = e^x, y_2 = e^{-x}$$

$$\Rightarrow v_1' = \frac{\begin{vmatrix} 0 & e^{-x} \\ e^x & -e^{-x} \end{vmatrix}}{\begin{vmatrix} e^x & e^{-x} \\ e^x & -e^{-x} \end{vmatrix}} = \frac{-1}{-2} = \frac{1}{2} \text{ and } v_2' = \frac{\begin{vmatrix} e^x & 0 \\ e^x & e^x \end{vmatrix}}{\begin{vmatrix} e^x & e^{-x} \\ e^x & -e^{-x} \end{vmatrix}} = \frac{e^{2x}}{-2} = -\frac{1}{2} e^{2x} \Rightarrow v_1 = \int \frac{1}{2} dx = \frac{1}{2} x \text{ and } v_2 = -\frac{1}{2} \int e^{2x} dx = -\frac{1}{4} e^{2x}$$

$$\Rightarrow y_p = \left(\frac{1}{2} x \right) e^x + \left(-\frac{1}{4} e^{2x} \right) e^{-x} = \frac{1}{2} x e^x - \frac{1}{4} e^x \Rightarrow y = c_1 e^x + c_2 e^{-x} + \frac{1}{2} x e^x$$

$$24. y'' - y = \sin x \Rightarrow r^2 - 1 = 0 \Rightarrow (r-1)(r+1) = 0 \Rightarrow r = 1 \text{ or } r = -1 \Rightarrow y_c = c_1 e^x + c_2 e^{-x} \Rightarrow y_1 = e^x, y_2 = e^{-x}$$

$$\Rightarrow v_1' = \frac{\begin{vmatrix} 0 & e^{-x} \\ \sin x & -e^{-x} \end{vmatrix}}{\begin{vmatrix} e^x & e^{-x} \\ e^x & -e^{-x} \end{vmatrix}} = \frac{-e^{-x} \sin x}{-2} = \frac{1}{2} e^{-x} \sin x \text{ and } v_2' = \frac{\begin{vmatrix} e^x & 0 \\ e^x & \sin x \end{vmatrix}}{\begin{vmatrix} e^x & e^{-x} \\ e^x & -e^{-x} \end{vmatrix}} = \frac{e^x \sin x}{-2} = -\frac{1}{2} e^x \sin x$$

$$\Rightarrow v_1 = \frac{1}{2} \int e^{-x} \sin x \, dx = -\frac{1}{4} e^{-x} \cos x - \frac{1}{4} e^{-x} \sin x \text{ and } v_2 = -\frac{1}{2} \int e^x \sin x \, dx = \frac{1}{4} e^x \cos x - \frac{1}{4} e^x \sin x$$

$$\Rightarrow y_p = \left(-\frac{1}{4} e^{-x} \cos x - \frac{1}{4} e^{-x} \sin x\right) e^x + \left(\frac{1}{4} e^x \cos x - \frac{1}{4} e^x \sin x\right) e^{-x} = -\frac{1}{2} \sin x \Rightarrow y = c_1 e^x + c_2 e^{-x} e^x - \frac{1}{2} \sin x$$

$$25. y'' + 4y' + 5y = 10 \Rightarrow r^2 + 4r + 5 = 0 \Rightarrow r = \frac{-4 \pm \sqrt{4^2 - 4(1)(5)}}{2(1)} = -2 \pm i \Rightarrow y = e^{-2x}(c_1 \cos x + c_2 \sin x)$$

$$\Rightarrow y_1 = e^{-2x} \cos x, y_2 = e^{-2x} \sin x \Rightarrow v_1' = \frac{\begin{vmatrix} 0 & e^{-2x} \sin x \\ 10 & e^{-2x} \cos x - 2e^{-2x} \sin x \end{vmatrix}}{\begin{vmatrix} e^{-2x} \cos x & e^{-2x} \sin x \\ -e^{-2x} \sin x - 2e^{-2x} \cos x & e^{-2x} \cos x - 2e^{-2x} \sin x \end{vmatrix}} = \frac{-10e^{-2x} \sin x}{e^{-4x}} = -10e^{2x} \sin x$$

$$\text{and } v_2' = \frac{\begin{vmatrix} e^{-2x} \cos x & 0 \\ -e^{-2x} \sin x - 2e^{-2x} \cos x & 10 \end{vmatrix}}{\begin{vmatrix} e^{-2x} \cos x & e^{-2x} \sin x \\ -e^{-2x} \sin x - 2e^{-2x} \cos x & e^{-2x} \cos x - 2e^{-2x} \sin x \end{vmatrix}} = \frac{10e^{-2x} \cos x}{e^{-4x}} = 10e^{2x} \cos x$$

$$\Rightarrow v_1 = -\int 10e^{2x} \sin x \, dx = 2e^{2x} \cos x - 4e^{2x} \sin x \text{ and } v_2 = \int 10e^{2x} \cos x \, dx = 2e^{2x} \sin x + 4e^{2x} \cos x$$

$$\Rightarrow y_p = (2e^{2x} \cos x - 4e^{2x} \sin x)(e^{-2x} \cos x) + (2e^{2x} \sin x + 4e^{2x} \cos x)(e^{-2x} \sin x) = 2 \Rightarrow y = e^{-2x}(c_1 \cos x + c_2 \sin x) + 2$$

$$26. y'' - y' = 2^x \Rightarrow r^2 - r = 0 \Rightarrow r(r-1) = 0 \Rightarrow r = 0 \text{ or } r = 1 \Rightarrow y_c = c_1 e^{0x} + c_2 e^x = c_1 + c_2 e^x \Rightarrow y_1 = 1, y_2 = e^x$$

$$\Rightarrow v_1' = \frac{\begin{vmatrix} 0 & e^x \\ 2^x & e^x \end{vmatrix}}{\begin{vmatrix} 1 & e^x \\ 0 & e^x \end{vmatrix}} = \frac{-2^x e^x}{e^x} = -2^x \text{ and } v_2' = \frac{\begin{vmatrix} 1 & 0 \\ 0 & 2^x \end{vmatrix}}{\begin{vmatrix} 1 & e^x \\ 0 & e^x \end{vmatrix}} = \frac{2^x}{e^x} = \left(\frac{2}{e}\right)^x \Rightarrow v_1 = -\int 2^x \, dx = \frac{1}{\ln 2} 2^x \text{ and}$$

$$v_2 = \int \left(\frac{2}{e}\right)^x \, dx = \frac{1}{\ln 2 - 1} \left(\frac{2}{e}\right)^x \Rightarrow y_p = \left(\frac{1}{\ln 2} 2^x\right)(1) + \left(\frac{1}{\ln 2 - 1} \left(\frac{2}{e}\right)^x\right) e^x = \left(\frac{1}{\ln 2} + \frac{1}{\ln 2 - 1}\right) 2^x = \frac{\ln 2 - 1}{\ln 2(\ln 2 - 1)} 2^x$$

$$\Rightarrow y = c_1 + c_2 e^x + \frac{\ln 2 - 1}{\ln 2(\ln 2 - 1)} 2^x$$

$$27. \frac{d^2 y}{dx^2} + y = \sec x, -\frac{\pi}{2} < x < \frac{\pi}{2} \Rightarrow r^2 + 1 = 0 \Rightarrow r = 0 \pm i \Rightarrow y_c = c_1 \cos x + c_2 \sin x \Rightarrow y_1 = \cos x, y_2 = \sin x$$

$$\Rightarrow v_1' = \frac{\begin{vmatrix} 0 & \sin x \\ \sec x & \cos x \end{vmatrix}}{\begin{vmatrix} \cos x & \sin x \\ -\sin x & \cos x \end{vmatrix}} = \frac{-\sin x \sec x}{1} = -\tan x \text{ and } v_2' = \frac{\begin{vmatrix} \cos x & 0 \\ -\sin x & \sec x \end{vmatrix}}{\begin{vmatrix} \cos x & \sin x \\ -\sin x & \cos x \end{vmatrix}} = \frac{1}{1} = \sin x \Rightarrow v_1 = \int -\tan x \, dx$$

$$= -\int \frac{\sin x}{\cos x} \, dx = \ln|\cos x| \text{ and } v_2 = \int 1 \, dx = x \Rightarrow y_p = (\ln|\cos x|)(\cos x) + (x)(\sin x) = \cos x \ln|\cos x| + x \sin x$$

$$\Rightarrow y = c_1 \cos x + c_2 \sin x + \cos x \ln|\cos x| + x \sin x$$

$$28. \frac{d^2 y}{dx^2} - \frac{dy}{dx} = e^x \cos x \Rightarrow r^2 - r = 0 \Rightarrow r(r-1) = 0 \Rightarrow r = 0 \text{ or } r = 1 \Rightarrow y_c = c_1 e^{0x} + c_2 e^x = c_1 + c_2 e^x$$

$$\Rightarrow y_1 = 1, y_2 = e^x \Rightarrow v_1' = \frac{\begin{vmatrix} 0 & e^x \\ e^x \cos x & e^x \end{vmatrix}}{\begin{vmatrix} 1 & e^x \\ 0 & e^x \end{vmatrix}} = \frac{-e^{2x} \cos x}{e^x} = -e^x \cos x \text{ and } v_2' = \frac{\begin{vmatrix} 1 & 0 \\ 0 & e^x \cos x \end{vmatrix}}{\begin{vmatrix} 1 & e^x \\ 0 & e^x \end{vmatrix}} = \frac{e^x \cos x}{e^x} = \cos x$$

$$\Rightarrow v_1 = -\int e^x \cos x \, dx = -\frac{1}{2} e^x \sin x - \frac{1}{2} e^x \cos x \text{ and } v_2 = \int \cos x \, dx = \sin x$$

$$\Rightarrow y_p = \left(-\frac{1}{2} e^x \sin x - \frac{1}{2} e^x \cos x\right)(1) + (\sin x)(e^x) = \frac{1}{2} e^x \sin x - \frac{1}{2} e^x \cos x \Rightarrow y = c_1 + c_2 e^x + \frac{1}{2} e^x \sin x - \frac{1}{2} e^x \cos x$$

$$29. y'' - 5y' = x e^{5x}, y_p = Ax^2 e^{5x} + Bx e^{5x} \Rightarrow y_p' = 5Ax^2 e^{5x} + 2Ax e^{5x} + 5Bx e^{5x} + B e^{5x}$$

$$\Rightarrow y_p'' = 25Ax^2 e^{5x} + 20Ax e^{5x} + 2Ae^{5x} + 25Bx e^{5x} + 10B e^{5x}$$

$$\Rightarrow (25Ax^2 e^{5x} + 20Ax e^{5x} + 2Ae^{5x} + 25Bx e^{5x} + 10B e^{5x}) - 5(5Ax^2 e^{5x} + 2Ax e^{5x} + 5Bx e^{5x} + B e^{5x}) = x e^{5x}$$

$$\Rightarrow 10Ax e^{5x} + (2A + 5B) e^{5x} = x e^{5x} \Rightarrow 10A = 1, 2A + 5B = 0 \Rightarrow A = \frac{1}{10}, B = -\frac{1}{25} \Rightarrow y_p = \frac{1}{10} x^2 e^{5x} - \frac{1}{25} x e^{5x};$$

$$r^2 - 5r = 0 \Rightarrow r(r-5) = 0 \Rightarrow r = 0 \text{ or } r = 5 \Rightarrow y_c = c_1 e^{0x} + c_2 e^{5x} = c_1 + c_2 e^{5x}$$

$$\Rightarrow y = c_1 + c_2 e^{5x} + \frac{1}{10} x^2 e^{5x} - \frac{1}{25} x e^{5x}$$

30. $y'' - y' = \cos x + \sin x$, $y_p = A \cos x + B \sin x \Rightarrow y'_p = -A \sin x + B \cos x \Rightarrow y''_p = -A \cos x - B \sin x$
 $\Rightarrow -A \cos x - B \sin x - (-A \sin x + B \cos x) = \cos x + \sin x \Rightarrow (A - B) \sin x + (-A - B) \cos x = \cos x + \sin x$
 $\Rightarrow A - B = 1, -A - B = 1 \Rightarrow A = 0, B = -1 \Rightarrow y_p = -\sin x; r^2 - r = 0 \Rightarrow r(r - 1) = 0 \Rightarrow r = 0 \text{ or } r = 1$
 $\Rightarrow y_c = c_1 e^{0 \cdot x} + c_2 e^x = c_1 + c_2 e^x \Rightarrow y = c_1 + c_2 e^x - \sin x$

31. $y'' + y = 2 \cos x + \sin x$, $y_p = Ax \sin x + Bx \cos x \Rightarrow y'_p = Ax \cos x + A \sin x - Bx \sin x + B \cos x$
 $\Rightarrow y''_p = -Ax \sin x + 2A \cos x - Bx \cos x - 2B \sin x$
 $\Rightarrow (-Ax \sin x + 2A \cos x - Bx \cos x - 2B \sin x) + (Ax \sin x + Bx \cos x) = \cos x + \sin x$
 $\Rightarrow -2B \sin x + 2A \cos x = 2 \cos x + \sin x \Rightarrow -2B = 1, 2A = 2 \Rightarrow A = 1, B = -\frac{1}{2} \Rightarrow y_p = x \sin x - \frac{1}{2} x \cos x;$
 $r^2 + 1 = 0 \Rightarrow r = 0 \pm i \Rightarrow y_c = c_1 \cos x + c_2 \sin x \Rightarrow y = c_1 \cos x + c_2 \sin x + x \sin x - \frac{1}{2} x \cos x$

32. $y'' + y' - 2y = x e^x$, $y_p = Ax^2 e^x + Bx e^x \Rightarrow y'_p = Ax^2 e^x + 2Ax e^x + Bx e^x + B e^x$
 $\Rightarrow y''_p = Ax^2 e^x + 4Ax e^x + 2Ae^x + Bx e^x + 2B e^x$
 $\Rightarrow (Ax^2 e^x + 4Ax e^x + 2Ae^x + Bx e^x + 2B e^x) + (Ax^2 e^x + 2Ax e^x + Bx e^x + B e^x) - 2(Ax^2 e^x + Bx e^x) = x e^x$
 $\Rightarrow 6Ax e^x + (2A + 3B) e^x = x e^x \Rightarrow 6A = 1, 2A + 3B = 0 \Rightarrow A = \frac{1}{6}, B = -\frac{1}{9} \Rightarrow y_p = \frac{1}{6} x^2 e^x - \frac{1}{9} x e^x;$
 $r^2 + r - 2 = 0 \Rightarrow (r + 2)(r - 1) = 0 \Rightarrow r = -2 \text{ or } r = 1 \Rightarrow y_c = c_1 e^{-2x} + c_2 e^x \Rightarrow y = c_1 e^{-2x} + c_2 e^x + \frac{1}{6} x^2 e^x - \frac{1}{9} x e^x$

33. $\frac{d^2 y}{dx^2} - \frac{dy}{dx} = e^x + e^{-x} \Rightarrow r^2 - r = 0 \Rightarrow r(r - 1) = 0 \Rightarrow r = 0 \text{ or } r = 1 \Rightarrow y_c = c_1 e^{0 \cdot x} + c_2 e^x = c_1 + c_2 e^x$

(a) $y_1 = 1, y_2 = e^x \Rightarrow v'_1 = \frac{\begin{vmatrix} 0 & e^x \\ e^x + e^{-x} & e^x \end{vmatrix}}{\begin{vmatrix} 1 & e^x \\ 0 & e^x \end{vmatrix}} = \frac{-e^{2x} - 1}{e^x} = -e^x - e^{-x}$ and $v'_2 = \frac{\begin{vmatrix} 1 & 0 \\ 0 & e^x + e^{-x} \end{vmatrix}}{\begin{vmatrix} 1 & e^x \\ 0 & e^x \end{vmatrix}} = \frac{e^x + e^{-x}}{e^x} = 1 + e^{-2x}$

$\Rightarrow v_1 = \int (-e^x - e^{-x}) dx = -e^x + e^{-x}$ and $v_2 = \int (1 + e^{-2x}) dx = x - \frac{1}{2} e^{-2x}$

$\Rightarrow y_p = (-e^x + e^{-x})(1) + (x - \frac{1}{2} e^{-2x})(e^x) = -e^x + x e^x + \frac{1}{2} e^{-x} \Rightarrow y = c_1 + c_2 e^x x e^x + \frac{1}{2} e^{-x}$

(b) $y_p = Ax e^x + B e^{-x} \Rightarrow y'_p = Ax e^x + A e^x - B e^{-x} \Rightarrow y''_p = Ax e^x + 2A e^x + B e^{-x}$

$\Rightarrow (Ax e^x + 2A e^x + B e^{-x}) - (Ax e^x + A e^x - B e^{-x}) = e^x + e^{-x} \Rightarrow A e^x + 2B e^{-x} = e^x + e^{-x}$

$\Rightarrow A = 1, 2B = 1 \Rightarrow A = 1, B = \frac{1}{2} \Rightarrow y = c_1 + c_2 e^x + x e^x + \frac{1}{2} e^{-x}$

34. $\frac{d^2 y}{dx^2} - 4 \frac{dy}{dx} + 4y = 2e^{2x} \Rightarrow r^2 - 4r + 4 = 0 \Rightarrow (r - 2)^2 = 0 \Rightarrow r = 2, \text{ repeated twice} \Rightarrow y_c = c_1 e^{2x} + c_2 x e^{2x}$

(a) $y_1 = e^{2x}, y_2 = x e^{2x} \Rightarrow v'_1 = \frac{\begin{vmatrix} 0 & x e^{2x} \\ 2e^{2x} & e^{2x} + 2x e^{2x} \end{vmatrix}}{\begin{vmatrix} e^{2x} & x e^{2x} \\ 2e^{2x} & e^{2x} + 2x e^{2x} \end{vmatrix}} = \frac{-2x e^{4x}}{e^{4x}} = -2x$ and $v'_2 = \frac{\begin{vmatrix} e^{2x} & 0 \\ 2e^{2x} & 2e^{2x} \end{vmatrix}}{\begin{vmatrix} e^{2x} & x e^{2x} \\ 2e^{2x} & e^{2x} + 2x e^{2x} \end{vmatrix}} = \frac{2e^{4x}}{e^{4x}} = 2$

$\Rightarrow v_1 = \int (-2x) dx = -x^2$ and $v_2 = \int 2 dx = 2x \Rightarrow y_p = (-x^2)(e^{2x}) + (2x)(x e^{2x}) = x^2 e^x$

$\Rightarrow y = c_1 e^{2x} + c_2 x e^{2x} + x^2 e^x$

(b) $y_p = Ax^2 e^{2x} \Rightarrow y'_p = 2Ax e^{2x} + 2Ax^2 e^{2x} \Rightarrow y''_p = 2A e^{2x} + 8Ax e^{2x} + 4Ax^2 e^{2x}$

$\Rightarrow (2A e^{2x} + 8Ax e^{2x} + 4Ax^2 e^{2x}) - 4(2Ax e^{2x} + 2Ax^2 e^{2x}) + 4Ax^2 e^{2x} = 2e^{2x} \Rightarrow 2A e^{2x} = 2e^{2x}$

$\Rightarrow 2A = 2 \Rightarrow A = 1 \Rightarrow y = c_1 e^{2x} + c_2 x e^{2x} + x^2 e^x$

35. $\frac{d^2 y}{dx^2} - 4 \frac{dy}{dx} - 5y = e^x + 4 \Rightarrow r^2 - 4r - 5 = 0 \Rightarrow (r - 5)(r + 1) = 0 \Rightarrow r = 5 \text{ or } r = -1 \Rightarrow y_c = c_1 e^{5x} + c_2 e^{-x}$

(a) $y_1 = e^{5x}, y_2 = e^{-x} \Rightarrow v'_1 = \frac{\begin{vmatrix} 0 & e^{-x} \\ e^x + 4 & -e^{-x} \end{vmatrix}}{\begin{vmatrix} e^{5x} & e^{-x} \\ 5e^{5x} & -e^{-x} \end{vmatrix}} = \frac{-1 - 4e^{-x}}{-6e^{4x}} = \frac{1}{6} e^{-4x} + \frac{2}{3} e^{-5x}$ and $v'_2 = \frac{\begin{vmatrix} e^{5x} & 0 \\ e^{5x} & e^x + 4 \end{vmatrix}}{\begin{vmatrix} e^{5x} & e^{-x} \\ 5e^{5x} & -e^{-x} \end{vmatrix}} = \frac{e^{6x} + 4e^{5x}}{-6e^{4x}} = -\frac{1}{6} e^{2x} - \frac{2}{3} e^x$

$\Rightarrow v_1 = \int (\frac{1}{6} e^{-4x} + \frac{2}{3} e^{-5x}) dx = -\frac{1}{24} e^{-4x} - \frac{2}{15} e^{-5x}$ and $v_2 = \int (-\frac{1}{6} e^{2x} - \frac{2}{3} e^x) dx = -\frac{1}{12} e^{2x} - \frac{2}{3} e^x$

$\Rightarrow y_p = (-\frac{1}{24} e^{-4x} - \frac{2}{15} e^{-5x})(e^{5x}) + (-\frac{1}{12} e^{2x} - \frac{2}{3} e^x)(e^{-x}) = -\frac{1}{8} e^x - \frac{4}{5} \Rightarrow y = c_1 e^{5x} + c_2 e^{-x} - \frac{1}{8} e^x - \frac{4}{5}$

(b) $y_p = Ae^x + B \Rightarrow y'_p = Ae^x \Rightarrow y''_p = Ae^x \Rightarrow Ae^x - 4Ae^x + -5(Ae^x + B) = e^x + 4 \Rightarrow -8Ae^x - 5B = e^x + 4$

$\Rightarrow -8A = 1, -5B = 4 \Rightarrow A = -\frac{1}{8}, B = -\frac{4}{5} \Rightarrow y = c_1 e^{5x} + c_2 e^{-x} - \frac{1}{8} e^x - \frac{4}{5}$

$$36. \frac{d^2y}{dx^2} - 9\frac{dy}{dx} = 9e^{9x} \Rightarrow r^2 - 9r = 0 \Rightarrow r(r-9) = 0 \Rightarrow r = 0 \text{ or } r = 9 \Rightarrow y_c = c_1e^{0 \cdot x} + c_2e^{9x} = c_1 + c_2e^{9x}$$

$$(a) y_1 = 1, y_2 = e^{9x} \Rightarrow v_1' = \frac{\begin{vmatrix} 0 & e^{9x} \\ 9e^{9x} & 9e^{9x} \end{vmatrix}}{\begin{vmatrix} 1 & e^{9x} \\ 0 & 9e^{9x} \end{vmatrix}} = \frac{-9e^{18x}}{9e^{9x}} = -e^{9x} \text{ and } v_2' = \frac{\begin{vmatrix} 1 & 0 \\ 0 & 9e^{9x} \end{vmatrix}}{\begin{vmatrix} 1 & e^{9x} \\ 0 & 9e^{9x} \end{vmatrix}} = \frac{9e^{9x}}{9e^{9x}} = 1$$

$$\Rightarrow v_1 = \int (-e^{9x}) dx = -\frac{1}{9}e^{9x} \text{ and } v_2 = \int (1) dx = x \Rightarrow y_p = \left(-\frac{1}{9}e^{9x}\right)(1) + (x)(e^{9x}) = -\frac{1}{9}e^{9x} + xe^{9x}$$

$$\Rightarrow y = c_1 + c_2e^{9x} + xe^{9x}$$

$$(b) y_p = Ax e^{9x} \Rightarrow y_p' = 9Ax e^{9x} + A e^{9x} \Rightarrow y_p'' = 81Ax e^{9x} + 18A e^{9x}$$

$$\Rightarrow (81Ax e^{9x} + 18A e^{9x}) - 9(9Ax e^{9x} + A e^{9x}) = 9e^{9x} \Rightarrow 9A e^{9x} = 9e^{9x} \Rightarrow 9A = 9 \Rightarrow A = 1$$

$$\Rightarrow y = c_1 + c_2e^{9x} + xe^{9x}$$

$$37. y'' + y = \cot x, 0 < x < \pi \Rightarrow r^2 + 1 = 0 \Rightarrow r = 0 \pm i \Rightarrow y_c = c_1 \cos x + c_2 \sin x \Rightarrow y_1 = \cos x, y_2 = \sin x$$

$$\Rightarrow v_1' = \frac{\begin{vmatrix} 0 & \sin x \\ \cot x & \cos x \end{vmatrix}}{\begin{vmatrix} \cos x & \sin x \\ -\sin x & \cos x \end{vmatrix}} = \frac{-\sin x \cot x}{1} = -\sin x \frac{\cos x}{\sin x} = -\cos x \text{ and } v_2' = \frac{\begin{vmatrix} \cos x & 0 \\ -\sin x & \cot x \end{vmatrix}}{\begin{vmatrix} \cos x & \sin x \\ -\sin x & \cos x \end{vmatrix}} = \frac{\cos x \cot x}{1} = \cos x \cdot \frac{\cos x}{\sin x} = \frac{\cos^2 x}{\sin x}$$

$$\Rightarrow v_1 = -\int \cos x dx = -\sin x \text{ and } v_2 = \int \frac{\cos^2 x}{\sin x} dx = \int \frac{1 - \sin^2 x}{\sin x} dx = \int \left(\frac{1}{\sin x} - \frac{\sin^2 x}{\sin x}\right) dx = \int (\csc x - \sin x) dx$$

$$= \ln|\csc x + \cot x| - \sin x \Rightarrow y_p = (\sin x)(\cos x) + (\ln|\csc x + \cot x| - \sin x)(\sin x) = -(\sin x) \ln|\csc x + \cot x|$$

$$\Rightarrow y = c_1 \cos x + c_2 \sin x - (\sin x) \ln|\csc x + \cot x|$$

$$38. y'' + y = \csc x, 0 < x < \pi \Rightarrow r^2 + 1 = 0 \Rightarrow r = 0 \pm i \Rightarrow y_c = c_1 \cos x + c_2 \sin x \Rightarrow y_1 = \cos x, y_2 = \sin x$$

$$\Rightarrow v_1' = \frac{\begin{vmatrix} 0 & \sin x \\ \csc x & \cos x \end{vmatrix}}{\begin{vmatrix} \cos x & \sin x \\ -\sin x & \cos x \end{vmatrix}} = \frac{-\sin x \csc x}{1} = -\sin x \frac{1}{\sin x} = -1 \text{ and } v_2' = \frac{\begin{vmatrix} \cos x & 0 \\ -\sin x & \csc x \end{vmatrix}}{\begin{vmatrix} \cos x & \sin x \\ -\sin x & \cos x \end{vmatrix}} = \frac{\cos x \csc x}{1} = \cos x \cdot \frac{1}{\sin x} = \frac{\cos x}{\sin x}$$

$$\Rightarrow v_1 = \int (-1) dx = -x \text{ and } v_2 = \int \frac{\cos x}{\sin x} dx = \ln|\sin x| \Rightarrow y_p = (-x)(\cos x) + (\ln|\sin x|)(\sin x)$$

$$= -x \cos x + (\sin x) \ln|\sin x| \Rightarrow y = c_1 \cos x + c_2 \sin x - x \cos x + (\sin x) \ln|\sin x|$$

$$39. y'' - 8y' = e^{8x} \Rightarrow r^2 - 8r = 0 \Rightarrow r(r-8) = 0 \Rightarrow r = 0 \text{ or } r = 8 \Rightarrow y_c = c_1e^{0 \cdot x} + c_2e^{8x} = c_1 + c_2e^{8x};$$

$$y_p = Ax e^{8x} \Rightarrow y_p' = Ae^{8x} + 8Ax e^{8x} \Rightarrow y_p'' = 16Ae^{8x} + 64Ax e^{8x} \Rightarrow (16Ae^{8x} + 64Ax e^{8x}) - 8(Ae^{8x} + 8Ax e^{8x}) = e^{8x}$$

$$\Rightarrow 8Ae^{8x} = e^{8x} \Rightarrow 8A = 1 \Rightarrow A = \frac{1}{8} \Rightarrow y = c_1 + c_2e^{8x} + \frac{1}{8}x e^{8x}$$

$$40. y'' + 4y = \sin x \Rightarrow r^2 + 4 = 0 \Rightarrow r = 0 \pm 2i \Rightarrow y_c = e^{0 \cdot x}(c_1 \cos 2x + c_2 \sin 2x) = c_1 \cos 2x + c_2 \sin 2x;$$

$$y_p = A \sin x + B \cos x \Rightarrow y_p' = A \cos x - B \sin x \Rightarrow y_p'' = -A \sin x - B \cos x$$

$$\Rightarrow (-A \sin x - B \cos x) + 4(A \sin x + B \cos x) = \sin x \Rightarrow 3A \sin x + 3B \cos x = \sin x \Rightarrow 3A = 1, 3B = 0$$

$$\Rightarrow A = \frac{1}{3}, B = 0 \Rightarrow y = c_1 \cos 2x + c_2 \sin 2x + \frac{1}{3} \sin x$$

$$41. y'' - y' = x^3 \Rightarrow r^2 - r = 0 \Rightarrow r(r-1) = 0 \Rightarrow r = 0 \text{ or } r = 1 \Rightarrow y_c = c_1e^{0 \cdot x} + c_2e^x = c_1 + c_2e^x;$$

$$y_p = Ax^4 + Bx^3 + Cx^2 + Dx \Rightarrow y_p' = 4Ax^3 + 3Bx^2 + 2Cx + D \Rightarrow y_p'' = 12Ax^2 + 6Bx + 2C$$

$$\Rightarrow (12Ax^2 + 6Bx + 2C) - (4Ax^3 + 3Bx^2 + 2Cx + D) = x^3$$

$$\Rightarrow -4Ax^3 + (12A - 3B)x^2 + (6B - 2C)x + (2C - D) = x^3 \Rightarrow -4A = 1, 12A - 3B = 0, 6B - 2C = 0, 2C - D = 0$$

$$\Rightarrow A = -\frac{1}{4}, B = -1, C = -3, D = -6 \Rightarrow y = c_1 + c_2e^x - \frac{1}{4}x^4 - x^3 - 3x^2 - 6x$$

$$42. y'' + 4y' + 5y = x + 2 \Rightarrow r^2 + 4r + 5 = 0 \Rightarrow r = \frac{-4 \pm \sqrt{4^2 - 4(1)(5)}}{2(1)} = -2 \pm i \Rightarrow y_c = e^{-2x}(c_1 \cos x + c_2 \sin x)$$

$$y_p = Ax + B \Rightarrow y_p' = A \Rightarrow y_p'' = 0 \Rightarrow 0 + 4A + 5(Ax + B) = x + 2 \Rightarrow 5Ax + (4A + 5B) = x + 2 \Rightarrow 5A = 1,$$

$$4A + 5B = 2 \Rightarrow A = \frac{1}{5}, B = \frac{6}{25} \Rightarrow y = e^{-2x}(c_1 \cos x + c_2 \sin x) + \frac{1}{5}x + \frac{6}{25}$$

43. $y'' + 2y' = x^2 - e^x \Rightarrow r^2 + 2r = 0 \Rightarrow r(r+2) = 0 \Rightarrow r = 0$ or $r = -2 \Rightarrow y_c = c_1 e^{0 \cdot x} + c_2 e^{-2x} = c_1 + c_2 e^{-2x}$;
 $y_p = Ax^3 + Bx^2 + Cx + De^x \Rightarrow y'_p = 3Ax^2 + 2Bx + C + De^x \Rightarrow y''_p = 6Ax + 2B + De^x$
 $\Rightarrow (6Ax + 2B + De^x) + 2(3Ax^2 + 2Bx + C + De^x) = x^2 - e^x \Rightarrow 6Ax^2 + (6A + 4B)x + (2B + 2C) + 3De^x = x^2 - e^x$
 $\Rightarrow 6A = 1, 6A + 4B = 0, 2B + 2C = 0, 3D = -1 \Rightarrow A = \frac{1}{6}, B = -\frac{1}{4}, C = \frac{1}{8}, D = -\frac{1}{3}$
 $\Rightarrow y = c_1 + c_2 e^{-2x} + \frac{1}{6}x^3 - \frac{1}{4}x^2 + \frac{1}{8}x - \frac{1}{3}e^x$
44. $y'' + 9y = 9x - \cos x \Rightarrow r^2 + 9 = 0 \Rightarrow r = 0 \pm 3i \Rightarrow y_c = e^{0 \cdot x}(c_1 \cos 3x + c_2 \sin 3x) = c_1 \cos 3x + c_2 \sin 3x$;
 $y_p = Ax + B + C \sin x + D \cos x \Rightarrow y'_p = A + C \cos x - D \sin x \Rightarrow y''_p = -C \sin x - D \cos x$
 $\Rightarrow (-C \sin x - D \cos x) + 9(Ax + B + C \sin x + D \cos x) = 9x - \cos x \Rightarrow 9Ax + 9B + 8C \sin x + 8D \cos x = 9x - \cos x$
 $\Rightarrow 9A = 9, 9B = 0, 8C = 0, 8D = -1 \Rightarrow A = 1, B = 0, C = 0, D = -\frac{1}{8} \Rightarrow y = c_1 \cos 3x + c_2 \sin 3x + x - \frac{1}{8} \cos x$
45. $\frac{d^2 y}{dx^2} + y = \sec x \tan x, -\frac{\pi}{2} < x < \frac{\pi}{2} \Rightarrow r^2 + 1 = 0 \Rightarrow r = 0 \pm i \Rightarrow y_c = c_1 \cos x + c_2 \sin x \Rightarrow y_1 = \cos x, y_2 = \sin x$
 $\Rightarrow v'_1 = \frac{\begin{vmatrix} 0 & \sin x \\ \sec x \tan x & \cos x \end{vmatrix}}{\begin{vmatrix} \cos x & \sin x \\ -\sin x & \cos x \end{vmatrix}} = \frac{-\sin x \sec x \tan x}{1} = -\tan^2 x$ and $v'_2 = \frac{\begin{vmatrix} \cos x & 0 \\ -\sin x & \sec x \tan x \end{vmatrix}}{\begin{vmatrix} \cos x & \sin x \\ -\sin x & \cos x \end{vmatrix}} = \frac{\cos x \sec x \tan x}{1} = \tan x$
 $\Rightarrow v_1 = \int -\tan^2 x dx = \int (1 - \sec^2 x) dx = x - \tan x$ and $v_2 = \int \tan x dx = \int \frac{\sin x}{\cos x} dx = -\ln|\cos x|$
 $\Rightarrow y_p = (x - \tan x)(\cos x) + (-\ln|\cos x|)(\sin x) = x \cos x - \sin x - (\sin x) \ln|\cos x|$
 $\Rightarrow y = c_1 \cos x + c_2 \sin x + x \cos x - (\sin x) \ln|\cos x|$
46. $y'' - 3y' + 2y = e^x - 2e^{2x} \Rightarrow r^2 - 3r + 2 = 0 \Rightarrow (r-1)(r-2) = 0 \Rightarrow r = 1$ or $r = 2 \Rightarrow y_c = c_1 e^x + c_2 e^{2x}$;
 $y_p = Ax e^{2x} + Bx e^x \Rightarrow y'_p = 2Ax e^{2x} + A e^{2x} + Bx e^x + B e^x \Rightarrow y''_p = 4Ax e^{2x} + 4A e^{2x} + Bx e^x + 2B e^x$
 $\Rightarrow (4Ax e^{2x} + 4A e^{2x} + Bx e^x + 2B e^x) - 3(2Ax e^{2x} + A e^{2x} + Bx e^x + B e^x) + 2(Ax e^{2x} + Bx e^x) = e^x - 2e^{2x}$
 $\Rightarrow A e^{2x} - B e^x = e^x - 2e^{2x} \Rightarrow A = -2, -B = 1 \Rightarrow A = -2, B = -1 \Rightarrow y = c_1 e^x + c_2 e^{2x} - 2x e^{2x} - x e^x$
47. $y' - 3y = e^x \Rightarrow r - 3 = 0 \Rightarrow r = 3 \Rightarrow y_c = c_1 e^{3x}; y_p = Ae^x \Rightarrow y'_p = Ae^x \Rightarrow Ae^x - 3Ae^x = e^x \Rightarrow -2Ae^x = e^x$
 $\Rightarrow -2A = 1 \Rightarrow A = -\frac{1}{2} \Rightarrow y = c_1 e^{3x} - \frac{1}{2} e^x$
48. $y' + 4y = x \Rightarrow r + 4 = 0 \Rightarrow r = -4 \Rightarrow y_c = c_1 e^{-4x}; y_p = Ax + B \Rightarrow y'_p = A \Rightarrow A + 4(Ax + B) = x$
 $\Rightarrow 4Ax + (A + 4B) = x \Rightarrow 4A = 1, A + 4B = 0 \Rightarrow A = \frac{1}{4}, B = -\frac{1}{16} \Rightarrow y = c_1 e^{-4x} + \frac{1}{4}x - \frac{1}{16}$
49. $y' - 3y = 5e^{3x} \Rightarrow r - 3 = 0 \Rightarrow r = 3 \Rightarrow y_c = c_1 e^{3x}; y_p = Ax e^{3x} \Rightarrow y'_p = 3Ax e^{3x} + A e^{3x}$
 $\Rightarrow (3Ax e^{3x} + A e^{3x}) - 3Ax e^{3x} = 5e^{3x} \Rightarrow A e^{3x} = 5e^{3x} \Rightarrow A = 5 \Rightarrow y = c_1 e^{3x} + 5x e^{3x}$
50. $y' + y = \sin x \Rightarrow r + 1 = 0 \Rightarrow r = -1 \Rightarrow y_c = c_1 e^{-x}; y_p = A \sin x + B \cos x \Rightarrow y'_p = A \cos x - B \sin x$
 $\Rightarrow (A \cos x - B \sin x) + (A \sin x + B \cos x) = \sin x \Rightarrow (A - B) \sin x + (A + B) \cos x = \sin x \Rightarrow A - B = 1, A + B = 0$
 $\Rightarrow A = \frac{1}{2}, B = -\frac{1}{2} \Rightarrow y = c_1 e^{-x} + \frac{1}{2} \sin x - \frac{1}{2} \cos x$
51. $\frac{d^2 y}{dx^2} + y = \sec^2 x, -\frac{\pi}{2} < x < \frac{\pi}{2}, y(0) = y'(0) = 1 \Rightarrow r^2 + 1 = 0 \Rightarrow r = 0 \pm i \Rightarrow y_c = c_1 \cos x + c_2 \sin x$
 $\Rightarrow y_1 = \cos x, y_2 = \sin x$
 $\Rightarrow v'_1 = \frac{\begin{vmatrix} 0 & \sin x \\ \sec^2 x & \cos x \end{vmatrix}}{\begin{vmatrix} \cos x & \sin x \\ -\sin x & \cos x \end{vmatrix}} = \frac{-\sin x \sec^2 x}{1} = -\sec x \tan x$ and $v'_2 = \frac{\begin{vmatrix} \cos x & 0 \\ -\sin x & \sec^2 x \end{vmatrix}}{\begin{vmatrix} \cos x & \sin x \\ -\sin x & \cos x \end{vmatrix}} = \frac{\cos x \sec^2 x}{1} = \sec x$
 $\Rightarrow v_1 = \int -\sec x \tan x dx = -\sec x$ and $v_2 = \int \sec x dx = \ln|\sec x + \tan x|$
 $\Rightarrow y_p = (-\sec x)(\cos x) + (\ln|\sec x + \tan x|)(\sin x) = -1 + (\sin x) \ln|\sec x + \tan x|$
 $\Rightarrow y = c_1 \cos x + c_2 \sin x - 1 + (\sin x) \ln|\sec x + \tan x|; y(0) = 1 \Rightarrow 1 = c_1 - 1 \Rightarrow c_1 = 2;$

$$\frac{dy}{dx} = -c_1 \sin x + c_2 \cos x + (\cos x) \ln |\sec x + \tan x| + (\sin x) \sec x, y'(0) = 1 \Rightarrow 1 = c_2$$

$$\Rightarrow y = 2 \cos x + \sin x - 1 + (\sin x) \ln |\sec x + \tan x|$$

52. $\frac{d^2y}{dx^2} + y = e^{2x}, y(0) = 0, y'(0) = \frac{2}{5} \Rightarrow r^2 + 1 = 0 \Rightarrow r = 0 \pm i \Rightarrow y_c = c_1 \cos x + c_2 \sin x$
 $y_p = A e^{2x} \Rightarrow y'_p = 2A e^{2x} \Rightarrow y''_p = 4A e^{2x} \Rightarrow 4A e^{2x} + A e^{2x} = e^{2x} \Rightarrow 5A e^{2x} = e^{2x} \Rightarrow 5A = 1 \Rightarrow A = \frac{1}{5}$
 $\Rightarrow y = c_1 \cos x + c_2 \sin x + \frac{1}{5} e^{2x} \Rightarrow y' = -c_1 \sin x + c_2 \cos x + \frac{2}{5} e^{2x}; y(0) = 0 \Rightarrow c_1 + \frac{1}{5} = 0 \Rightarrow c_1 = -\frac{1}{5};$
 $y'(0) = \frac{2}{5} \Rightarrow c_2 + \frac{2}{5} = \frac{2}{5} \Rightarrow c_2 = 0 \Rightarrow y = -\frac{1}{5} \cos x + \frac{1}{5} e^{2x}$
53. $y'' + y' = x, y_p = \frac{x^2}{2} - x, y(0) = 0, y'(0) = 0; y_p = \frac{x^2}{2} - x \Rightarrow y'_p = x - 1 \Rightarrow y''_p = 1 \Rightarrow y'' + y' = 1 + x - 1 = x$
 $\Rightarrow x = x \Rightarrow y_p$ satisfies the differential equation. $y'' + y' = 0 \Rightarrow r^2 + r = 0 \Rightarrow r(r + 1) = 0 \Rightarrow r = 0$ or $r = -1$
 $\Rightarrow y_c = c_1 e^{0x} + c_2 e^{-x} = c_1 + c_2 e^{-x} \Rightarrow y = c_1 + c_2 e^{-x} + \frac{x^2}{2} - x \Rightarrow y' = -c_2 e^{-x} + x - 1;$
 $y(0) = 0 \Rightarrow 0 = c_1 + c_2, y'(0) = 0 \Rightarrow -c_2 - 1 = 0 \Rightarrow c_1 = 1, c_2 = -1 \Rightarrow y = 1 - e^{-x} + \frac{x^2}{2} - x$
54. $y'' + y = x, y_p = 2 \sin x + x, y(0) = 0, y'(0) = 0; y_p = 2 \sin x + x \Rightarrow y'_p = 2 \cos x + 1 \Rightarrow y''_p = -2 \sin x$
 $\Rightarrow y'' + y = (-2 \sin x) + (2 \sin x + x) = x \Rightarrow x = x \Rightarrow y_p$ satisfies the differential equation. $y'' + y = 0 \Rightarrow r^2 + 1 = 0$
 $\Rightarrow r = 0 \pm i \Rightarrow y_c = c_1 \cos x + c_2 \sin x \Rightarrow y = c_1 \cos x + c_2 \sin x + 2 \sin x + x \Rightarrow y' = -c_1 \sin x + c_2 \cos x + 2 \cos x + 1;$
 $y(0) = 0 \Rightarrow 0 = c_1; y'(0) = 0 \Rightarrow 0 = c_2 + 3 \Rightarrow c_2 = -3 \Rightarrow y = -3 \sin x + 2 \sin x + x = -\sin x + x$
55. $\frac{1}{2} y'' + y' + y = 4e^x (\cos x - \sin x), y_p = 2e^x \cos x, y(0) = 0, y'(0) = 1; y_p = 2e^x \cos x \Rightarrow y'_p = 2e^x \cos x - 2e^x \sin x$
 $\Rightarrow y''_p = -4e^x \sin x \Rightarrow \frac{1}{2} y'' + y' + y = \frac{1}{2} (-4e^x \sin x) + (2e^x \cos x - 2e^x \sin x) + 2e^x \cos x = 4e^x \cos x - 4e^x \sin x$
 $\Rightarrow 4e^x \cos x - 4e^x \sin x = 4e^x (\cos x - \sin x) \Rightarrow y_p$ satisfies the differential equation. $\frac{1}{2} y'' + y' + y = 0 \Rightarrow \frac{1}{2} r^2 + r + 1 = 0$
 $\Rightarrow r = \frac{-1 \pm \sqrt{1^2 - 4(\frac{1}{2})(1)}}{2(\frac{1}{2})} = -1 \pm i \Rightarrow y_c = e^{-x} (c_1 \cos x + c_2 \sin x) \Rightarrow y = e^{-x} (c_1 \cos x + c_2 \sin x) + 2e^x \cos x$
 $\Rightarrow y' = -e^{-x} (c_1 \cos x + c_2 \sin x) + e^{-x} (-c_1 \sin x + c_2 \cos x) + 2e^x \cos x - 2e^x \sin x; y(0) = 0 \Rightarrow c_1 + 2 = 0 \Rightarrow c_1 = -2;$
 $y'(0) = 1 \Rightarrow -c_1 + c_2 + 2 = 1 \Rightarrow c_2 = -3 \Rightarrow y = e^{-x} (-2 \cos x - 3 \sin x) + 2e^x \cos x = 2(e^x - e^{-x}) \cos x - 3e^{-x} \sin x$
56. $y'' - y' - 2y = 1 - 2x, y_p = x - 1, y(0) = 0, y'(0) = 1; y_p = x - 1 \Rightarrow y'_p = 1 \Rightarrow y''_p = 0$
 $\Rightarrow y'' - y' - 2y = 0 - 1 - 2(x - 1) = 1 - 2x \Rightarrow 1 - 2x = 1 - 2x \Rightarrow y_p$ satisfies the differential equation.
 $y'' - y' - 2y = 0 \Rightarrow r^2 - r - 2 = 0 \Rightarrow (r - 2)(r + 1) = 0 \Rightarrow r = 2$ or $r = -1 \Rightarrow y_c = c_1 e^{2x} + c_2 e^{-x}$
 $\Rightarrow y = c_1 e^{2x} + c_2 e^{-x} + x - 1 \Rightarrow y' = 2c_1 e^{2x} - c_2 e^{-x} + 1; y(0) = 0 \Rightarrow c_1 + c_2 - 1 = 0 \Rightarrow c_1 + c_2 = 1,$
 $y'(0) = 1 \Rightarrow 2c_1 - c_2 + 1 = 1 \Rightarrow 2c_1 - c_2 = 0. \text{ Thus } c_1 + c_2 = 1, 2c_1 - c_2 = 0 \Rightarrow c_1 = \frac{1}{3}, c_2 = \frac{2}{3}$
 $\Rightarrow y = \frac{1}{3} e^{2x} + \frac{2}{3} e^{-x} + x - 1$
57. $y'' - 2y' + y = 2e^x, y_p = x^2 e^x, y(0) = 1, y'(0) = 0; y_p = x^2 e^x \Rightarrow y'_p = x^2 e^x + 2x e^x \Rightarrow y''_p = x^2 e^x + 4x e^x + 2e^x$
 $\Rightarrow y'' - 2y' + y = (x^2 e^x + 4x e^x + 2e^x) - 2(x^2 e^x + 2x e^x) + x^2 e^x = x^2 e^x \Rightarrow x^2 e^x = x^2 e^x \Rightarrow y_p$ satisfies the differential equation. $y'' - 2y' + y = 0 \Rightarrow r^2 - 2r + 1 = 0 \Rightarrow (r - 1)^2 = 0 \Rightarrow r = 1, \text{ repeated twice} \Rightarrow y_c = c_1 e^x + c_2 x e^x$
 $\Rightarrow y = c_1 e^x + c_2 x e^x + x^2 e^x \Rightarrow y' = c_1 e^x + c_2 x e^x + c_2 e^x + x^2 e^x + 2x e^x; y(0) = 1 \Rightarrow c_1 = 1; y'(0) = 0 \Rightarrow c_1 + c_2 = 0$
 $\Rightarrow c_2 = -1 \Rightarrow y = e^x - x e^x + x^2 e^x$
58. $y'' - 2y' + y = x^{-1} e^x, x > 0, y_p = x e^x \ln x, y(1) = e, y'(1) = 0; y_p = x e^x \ln x \Rightarrow y'_p = e^x + x e^x \ln x + e^x \ln x$
 $\Rightarrow y''_p = 2e^x + x e^x \ln x + e^x \ln x + \frac{e^x}{x}$
 $\Rightarrow y'' - 2y' + y = (2e^x + x e^x \ln x + e^x \ln x + \frac{e^x}{x}) - 2(e^x + x e^x \ln x + e^x \ln x) + x e^x \ln x = \frac{e^x}{x} \Rightarrow \frac{e^x}{x} = x^{-1} e^x$
 $\Rightarrow y_p$ satisfies the differential equation. $y'' - 2y' + y = 0 \Rightarrow r^2 - 2r + 1 = 0 \Rightarrow (r - 1)^2 = 0 \Rightarrow r = 1, \text{ repeated twice}$
 $\Rightarrow y_c = c_1 e^x + c_2 x e^x \Rightarrow y = c_1 e^x + c_2 x e^x + x e^x \ln x \Rightarrow y' = c_1 e^x + c_2 x e^x + c_2 e^x + e^x + x e^x \ln x + e^x \ln x;$

1016 Chapter 17 Second-Order Differential Equations

$$y(1) = e \Rightarrow c_1 e + c_2 e = e, y'(1) = 0 \Rightarrow c_1 e + 2c_2 e + e = 0 \Rightarrow c_1 e + 2c_2 e = -e \Rightarrow c_1 + c_2 = 1, c_1 + 2c_2 = -1$$

$$\Rightarrow c_1 = 3, c_2 = -2 \Rightarrow y = 3e^x - 2xe^x + x e^x \ln x$$

59. $x^2 y'' + 2xy' - 2y = x^2, y_1 = x^{-2}, y_2 = x$

$$\Rightarrow v_1' = \frac{\begin{vmatrix} 0 & x \\ \frac{x^2}{x^2} & 1 \end{vmatrix}}{\begin{vmatrix} x^{-2} & x \\ -2x^{-3} & 1 \end{vmatrix}} = \frac{-x}{3x^{-2}} = -\frac{1}{3}x^3 \text{ and } v_2' = \frac{\begin{vmatrix} x^{-2} & 0 \\ -2x^{-3} & \frac{x^2}{x^2} \end{vmatrix}}{\begin{vmatrix} x^{-2} & x \\ -2x^{-3} & 1 \end{vmatrix}} = \frac{x^{-2}}{3x^{-2}} = \frac{1}{3}$$

$$\Rightarrow v_1 = \int -\frac{1}{3}x^3 dx = -\frac{1}{12}x^4 \text{ and } v_2 = \int \frac{1}{3} dx = \frac{1}{3}x \Rightarrow y_p = \left(-\frac{1}{12}x^4\right)(x^{-2}) + \left(\frac{1}{3}x\right)(x) = \frac{1}{4}x^2$$

60. $x^2 y'' + xy' - y = x, y_1 = x^{-1}, y_2 = x$

$$\Rightarrow v_1' = \frac{\begin{vmatrix} 0 & x \\ \frac{x}{x^2} & 1 \end{vmatrix}}{\begin{vmatrix} x^{-1} & x \\ -x^{-2} & 1 \end{vmatrix}} = \frac{-1}{2x^{-1}} = -\frac{1}{2}x \text{ and } v_2' = \frac{\begin{vmatrix} x^{-1} & 0 \\ -x^{-2} & \frac{x}{x^2} \end{vmatrix}}{\begin{vmatrix} x^{-1} & x \\ -x^{-2} & 1 \end{vmatrix}} = \frac{x^{-2}}{2x^{-1}} = \frac{1}{2}x^{-1}$$

$$\Rightarrow v_1 = \int -\frac{1}{2}x dx = -\frac{1}{4}x^2 \text{ and } v_2 = \int \frac{1}{2}x^{-1} dx = \frac{1}{2}\ln|x| \Rightarrow y_p = \left(-\frac{1}{4}x^2\right)(x^{-1}) + \left(\frac{1}{2}\ln|x|\right)(x) = -\frac{1}{4}x + \frac{1}{2}x \ln|x|$$

17.3 APPLICATIONS

- $mg = 16 \Rightarrow m = \frac{16}{32}; k = 1; \delta = 1 \Rightarrow \frac{16}{32} \frac{d^2y}{dt^2} + 1 \frac{dy}{dt} + 1y = 0 \Rightarrow \frac{1}{2} \frac{d^2y}{dt^2} + \frac{dy}{dt} + y = 0, y(0) = 2, y'(0) = 2$
- $mg = 8 \text{ lb} \Rightarrow m = \frac{8}{32}; 8 = k \cdot 4 \Rightarrow k = 2; \delta = 1.5 \Rightarrow \frac{8}{32} \frac{d^2y}{dt^2} + 1.5 \frac{dy}{dt} + 2y = 0 \Rightarrow \frac{1}{4} \frac{d^2y}{dt^2} + \frac{3}{2} \frac{dy}{dt} + 2y = 0, y(0) = -2, y'(0) = 3$
- $20 = k \cdot \frac{1}{2} \Rightarrow k = 40; w = 25 \text{ lb} \Rightarrow m = \frac{25}{32}; \delta = 0 \Rightarrow \frac{25}{32} \frac{d^2y}{dt^2} + 0 \cdot \frac{dy}{dt} + 40y = 0$. If $w = 25 \text{ lb}$, it stretches the spring $25 = 40x \Rightarrow x = \frac{5}{8} \text{ ft} \Rightarrow$ spring is now stretched $\frac{6+5}{12} - \frac{5}{8} = \frac{7}{24} \text{ ft}$ below equilibrium $\Rightarrow y(0) = \frac{7}{24}$; initial velocity is $v_0 \frac{\text{in}}{\text{sec}} = \frac{v_0}{12} \frac{\text{ft}}{\text{sec}} \Rightarrow y'(0) = \frac{v_0}{12}$. Thus we have $\frac{25}{32} \frac{d^2y}{dt^2} + 40y = 0, y(0) = \frac{7}{24}, y'(0) = \frac{v_0}{12}$
- $w = 10 \text{ lb} \Rightarrow m = \frac{10}{32}; 10 = k \cdot \left(\frac{2}{12}\right) \Rightarrow k = 60 \frac{\text{lb}}{\text{ft}}; \delta = \frac{20}{\sqrt{g}} = \frac{20}{\sqrt{32}} \Rightarrow \frac{10}{32} \frac{d^2y}{dt^2} + \frac{20}{\sqrt{32}} \frac{dy}{dt} + 60y = 0$
 $\Rightarrow \frac{10}{32} \frac{d^2y}{dt^2} + \frac{5}{\sqrt{2}} \frac{dy}{dt} + 60y = 0, y(0) = \frac{1}{4}, y'(0) = 0$
- $E(t) = 20\cos t; R \frac{dq}{dt} = 4 \frac{dq}{dt}; \frac{1}{C}q = 10q; L \frac{di}{dt} = 2 \frac{d^2q}{dt^2} \Rightarrow 2 \frac{d^2q}{dt^2} + 4 \frac{dq}{dt} + 10q = 20\cos t, q(0) = 2, q'(0) = 3$
- $L = 2, R = 12, C = \frac{1}{16}, E(t) = 300 \Rightarrow 2 \frac{d^2q}{dt^2} + 12 \frac{dq}{dt} + 16q = 300, q(0) = 0, q'(0) = 0$
- $mg = 16 \Rightarrow m = \frac{16}{32}; k = 1; \text{resistance} = \text{velocity} \Rightarrow \delta = 1 \Rightarrow \frac{1}{2} \frac{d^2y}{dt^2} + 1 \frac{dy}{dt} + 1y = 0, y(0) = 2, y'(0) = 2$
 $\Rightarrow \frac{1}{2}r^2 + r + 1 = 0 \Rightarrow r^2 + 2r + 2 = 0 \Rightarrow r = \frac{-2 \pm \sqrt{2^2 - 4(1)(2)}}{2(1)} = -1 \pm i \Rightarrow y = e^{-t}(c_1 \cos t + c_2 \sin t)$
 $\Rightarrow y' = e^{-t}(-c_1 \sin t + c_2 \cos t) - e^{-t}(c_1 \cos t + c_2 \sin t); y(0) = 2 \Rightarrow c_1 = 2; y'(0) = 2 \Rightarrow c_2 - c_1 = 2 \Rightarrow c_2 = 4$
 $\Rightarrow y(t) = e^{-t}(2 \cos t + 4 \sin t)$. At $t = \pi, y = e^{-\pi}(2 \cos \pi + 4 \sin \pi) = -2e^{-\pi} \approx -0.0864 \Rightarrow 0.0864 \text{ ft above equilibrium}$.
- $w = 8 \Rightarrow m = \frac{8}{32}; 8 = k \cdot 4 \Rightarrow k = 2; \text{resistance} = 1.5 v \Rightarrow \delta = 1.5 \Rightarrow \frac{1}{4} \frac{d^2y}{dt^2} + 1.5 \frac{dy}{dt} + 2y = 0, y(0) = -2, y'(0) = 3$
 $\Rightarrow \frac{1}{4}r^2 + 1.5r + 2 = 0 \Rightarrow r^2 + 6r + 8 = 0 \Rightarrow (r+4)(r+2) \Rightarrow r = -4 \text{ or } r = -2 \Rightarrow y = c_1 e^{-4t} + c_2 e^{-2t}$
 $\Rightarrow y' = -4c_1 e^{-4t} - 2c_2 e^{-2t}; y(0) = -2 \Rightarrow c_1 + c_2 = -2; y'(0) = 3 \Rightarrow -4c_1 - 2c_2 = 3 \Rightarrow c_1 = \frac{1}{2}, c_2 = -\frac{5}{2}$
 $\Rightarrow y(t) = \frac{1}{2}e^{-4t} - \frac{5}{2}e^{-2t}$. At $t = 2, y = \frac{1}{2}e^{-8} - \frac{5}{2}e^{-2} \approx -0.0456 \Rightarrow 0.0456 \text{ ft above equilibrium}$.

9. $20 = k \cdot \frac{1}{2} \Rightarrow k = 40$; $w = 25 \text{ lb} \Rightarrow m = \frac{25}{32}$; $\delta = 0 \Rightarrow \frac{25}{32} \frac{d^2y}{dt^2} + 0 \cdot \frac{dy}{dt} + 40y = 0$. If $w = 25 \text{ lb}$, it stretches the spring $25 = 40x \Rightarrow x = \frac{5}{8} \text{ ft} \Rightarrow$ spring is now stretched $\frac{6+5}{12} - \frac{5}{8} = \frac{7}{24} \text{ ft}$ below equilibrium $\Rightarrow y(0) = \frac{7}{24}$; initial velocity is $v_0 \frac{\text{in}}{\text{sec}} = \frac{v_0}{12} \frac{\text{ft}}{\text{sec}} \Rightarrow y'(0) = \frac{v_0}{12}$. Thus we have $\frac{25}{32} \frac{d^2y}{dt^2} + 40y = 0$, $y(0) = \frac{7}{24}$, $y'(0) = \frac{v_0}{12} \Rightarrow \frac{25}{32}r^2 + 40 = 0 \Rightarrow r^2 + \frac{256}{5} = 0$
 $\Rightarrow r = 0 \pm \frac{16}{\sqrt{5}}i \Rightarrow y = e^{0t} \left(c_1 \cos\left(\frac{16}{\sqrt{5}}t\right) + c_2 \sin\left(\frac{16}{\sqrt{5}}t\right) \right) = c_1 \cos\left(\frac{16}{\sqrt{5}}t\right) + c_2 \sin\left(\frac{16}{\sqrt{5}}t\right)$, $y(0) = \frac{7}{24} \Rightarrow c_1 = \frac{7}{24}$;
 $y' = -\frac{16}{\sqrt{5}}c_1 \sin\left(\frac{16}{\sqrt{5}}t\right) + \frac{16}{\sqrt{5}}c_2 \cos\left(\frac{16}{\sqrt{5}}t\right)$, $y'(0) = \frac{v_0}{12} \Rightarrow \frac{16}{\sqrt{5}}c_2 = \frac{v_0}{12} \Rightarrow c_2 = \frac{v_0\sqrt{5}}{192}$
 $\Rightarrow y(t) = \frac{7}{24} \cos\left(\frac{16}{\sqrt{5}}t\right) + \frac{v_0\sqrt{5}}{192} \sin\left(\frac{16}{\sqrt{5}}t\right)$ (in feet) or $y(t) = \frac{7}{2} \cos\left(\frac{16}{\sqrt{5}}t\right) + \frac{v_0\sqrt{5}}{16} \sin\left(\frac{16}{\sqrt{5}}t\right)$ (in inches)
10. $m = 1$, $k = \frac{25}{4}$, $\delta = 3 \Rightarrow 1 \cdot \frac{d^2y}{dt^2} + 3 \frac{dy}{dt} + \frac{25}{4}y = 0$, $y(0) = -1$, $y'(0) = 3 \Rightarrow r^2 + 3r + \frac{25}{4} = 0$
 $\Rightarrow 4r^2 + 12r + 25 = 0 \Rightarrow r = \frac{-12 \pm \sqrt{12^2 - 4(4)(25)}}{2(4)} = -\frac{3}{2} \pm 2i \Rightarrow y = e^{-\frac{3}{2}t} (c_1 \cos 2t + c_2 \sin 2t)$
 $\Rightarrow y' = e^{-\frac{3}{2}t} \left(\left(-\frac{3}{2}c_1 + 2c_2\right) \cos 2t + \left(-2c_1 - \frac{3}{2}c_2\right) \sin 2t \right)$; $y(0) = -1 \Rightarrow c_1 = -1$, $y'(0) = 3 \Rightarrow -\frac{3}{2}c_1 + 2c_2 = 3$
 $\Rightarrow c_1 = -1$, $c_2 = \frac{3}{4} \Rightarrow y(t) = e^{-\frac{3}{2}t} (-\cos 2t + \frac{3}{4} \sin 2t)$
11. $mg = 10 \Rightarrow m = \frac{5}{16}$; $10 = k \cdot \frac{1}{6} \Rightarrow k = 60$; $\delta = \frac{40}{\sqrt{32}} = 5\sqrt{2} \Rightarrow \frac{5}{16} \frac{d^2y}{dt^2} + 5\sqrt{2} \frac{dy}{dt} + 60y = 0$, $y(0) = \frac{1}{4}$, $y'(0) = 0$
 $\Rightarrow \frac{5}{16}r^2 + 5\sqrt{2}r + 60 = 0 \Rightarrow r^2 + 16\sqrt{2}r + 192 = 0 \Rightarrow r = \frac{-16\sqrt{2} \pm \sqrt{(16\sqrt{2})^2 - 4(1)(192)}}{2(1)} = -8\sqrt{2} \pm 8i$
 $\Rightarrow y = e^{-8\sqrt{2}t} (c_1 \cos 8t + c_2 \sin 8t) \Rightarrow y' = e^{-8\sqrt{2}t} \left((-8\sqrt{2}c_1 + 8c_2) \cos 8t + (-8c_1 - 8\sqrt{2}c_2) \sin 8t \right)$;
 $y(0) = \frac{1}{4} \Rightarrow c_1 = \frac{1}{4}$, $y'(0) = 0 \Rightarrow -8\sqrt{2}c_1 + 8c_2 = 0 \Rightarrow c_1 = \frac{1}{4}$, $c_2 = \frac{\sqrt{2}}{4} \Rightarrow y = e^{-8\sqrt{2}t} \left(\frac{1}{4} \cos 8t + \frac{\sqrt{2}}{4} \sin 8t \right)$
Solve $y(t) = 0 \Rightarrow e^{-8\sqrt{2}t} \left(\frac{1}{4} \cos 8t + \frac{\sqrt{2}}{4} \sin 8t \right) = 0 \Rightarrow \frac{1}{4} \cos 8t + \frac{\sqrt{2}}{4} \sin 8t = 0 \Rightarrow \tan 8t = -\frac{1}{\sqrt{2}} \Rightarrow t \approx 0.3157 \text{ sec}$
12. $w = mg$; $mg = k \cdot \frac{1}{2} \Rightarrow k = 2mg = 64m$; $\delta = 0 \Rightarrow m \frac{d^2y}{dt^2} + 0 \cdot \frac{dy}{dt} + 64my = 0$, $y(0) = \frac{1}{6}$, $y'(0) = \frac{1}{6} \Rightarrow mr^2 + 64m = 0$,
 $\Rightarrow r^2 + 64 = 0 \Rightarrow r = 0 \pm 8i \Rightarrow y = e^{0t} (c_1 \cos 8t + c_2 \sin 8t) = c_1 \cos 8t + c_2 \sin 8t \Rightarrow y' = -8c_1 \sin 8t + 8c_2 \cos 8t$
 $y(0) = \frac{1}{6} \Rightarrow c_1 = \frac{1}{6}$, $y'(0) = \frac{1}{6} \Rightarrow 8c_2 = \frac{1}{6} \Rightarrow c_1 = \frac{1}{6}$, $c_2 = \frac{1}{48} \Rightarrow y(t) = \frac{1}{6} \cos 8t + \frac{1}{48} \sin 8t$
(a) Solve $y(t) = 0 \Rightarrow \frac{1}{6} \cos 8t + \frac{1}{48} \sin 8t = 0 \Rightarrow \tan 8t = -8 \Rightarrow t \approx -0.1808$, first positive solution is $t = -0.1808 + \frac{\pi}{8}$
 $\approx 0.2119 \text{ sec}$
(b) $y' = -\frac{4}{3} \sin 8t + \frac{1}{6} \cos 8t$, solve $y'(t) = 0 \Rightarrow -\frac{4}{3} \sin 8t + \frac{1}{6} \cos 8t = 0 \Rightarrow \tan 8t = \frac{1}{8} \Rightarrow t \approx 0.4082 \text{ sec}$
 $\Rightarrow y(0.4082) \approx 0.1680 \text{ ft}$
(c) $y'' = -\frac{32}{3} \cos 8t - \frac{4}{3} \sin 8t$, solve $y''(t) = 0 \Rightarrow -\frac{32}{3} \cos 8t - \frac{4}{3} \sin 8t = 0 \Rightarrow \tan 8t = -8 \Rightarrow t = \frac{\tan^{-1}(-8)}{8}$, first positive solution where maximum occurs is at $t = \frac{\tan^{-1}(-8)}{8} + \frac{\pi}{4} \Rightarrow y' \left(\frac{\tan^{-1}(-8)}{8} + \frac{\pi}{4} \right)$
 $= -\frac{4}{3} \sin 8 \left(\frac{\tan^{-1}(-8)}{8} + \frac{\pi}{4} \right) + \frac{1}{6} \cos 8 \left(\frac{\tan^{-1}(-8)}{8} + \frac{\pi}{4} \right) = -\frac{4}{3} \sin (\tan^{-1}(-8) + 2\pi) + \frac{1}{6} \cos ((\tan^{-1}(-8) + 2\pi))$
 $= -\frac{4}{3} [\sin (\tan^{-1}(-8)) \cos 2\pi + \cos (\tan^{-1}(-8)) \sin 2\pi] + \frac{1}{6} [\cos (\tan^{-1}(-8)) \cos 2\pi - \sin (\tan^{-1}(-8)) \sin 2\pi]$
 $= -\frac{4}{3} \left[-\frac{8}{\sqrt{65}} + 0 \right] + \frac{1}{6} \left[\frac{1}{\sqrt{65}} - 0 \right] = \frac{65}{6\sqrt{65}} = \frac{1}{6} \sqrt{65} \frac{\text{ft}}{\text{sec}} \Rightarrow 12 \left(\frac{1}{6} \sqrt{65} \right) = 2\sqrt{65} \frac{\text{in}}{\text{sec}}$. Note that $2\sqrt{2g+1} = 2\sqrt{65}$
when $g = 32$.
13. First weight: $w = 10 \text{ lb} \Rightarrow m = \frac{5}{16}$; $10 = k \cdot \left(\frac{5}{6}\right) \Rightarrow k = 12 \frac{\text{lb}}{\text{ft}}$; $\delta = 0 \Rightarrow \frac{5}{16} \frac{d^2y}{dt^2} + 0 \cdot \frac{dy}{dt} + 12y = 0$, $y(0) = \frac{1}{6}$, $y'(0) = -\frac{1}{3}$
 $\Rightarrow \frac{5}{16}r^2 + 12 = 0 \Rightarrow 5r^2 + 192 = 0 \Rightarrow r = 0 \pm \frac{8\sqrt{15}}{5}i \Rightarrow y = e^{0t} \left(c_1 \cos \frac{8\sqrt{15}}{5}t + c_2 \sin \frac{8\sqrt{15}}{5}t \right)$
 $= c_1 \cos \frac{8\sqrt{15}}{5}t + c_2 \sin \frac{8\sqrt{15}}{5}t \Rightarrow y' = -\frac{8\sqrt{15}}{5}c_1 \sin \frac{8\sqrt{15}}{5}t + \frac{8\sqrt{15}}{5}c_2 \cos \frac{8\sqrt{15}}{5}t$; $y(0) = \frac{1}{6} \Rightarrow c_1 = \frac{1}{6}$, $y'(0) = -\frac{1}{3}$
 $\Rightarrow \frac{8\sqrt{15}}{5}c_2 = -\frac{1}{3} \Rightarrow c_1 = \frac{1}{6}$, $c_2 = -\frac{\sqrt{15}}{72} \Rightarrow y = \frac{1}{6} \cos \frac{8\sqrt{15}}{5}t - \frac{\sqrt{15}}{72} \sin \frac{8\sqrt{15}}{5}t$. The amplitude is $C = \sqrt{\left(\frac{1}{6}\right)^2 + \left(-\frac{\sqrt{15}}{72}\right)^2}$
 $= \frac{\sqrt{159}}{72}$.

Second weight: $x = c_3 \cos \omega t + c_4 \sin \omega t$, $x(0) = \frac{\sqrt{159}}{72}$, $x'(0) = 2 \Rightarrow x' = -\omega c_3 \sin \omega t + \omega c_4 \cos \omega t$; $x(0) = \frac{\sqrt{159}}{72}$
 $\Rightarrow c_3 = \frac{\sqrt{159}}{72}$, $x'(0) = 2 \Rightarrow \omega c_4 = 2 \Rightarrow c_3 = \frac{\sqrt{159}}{72}$, $c_4 = \frac{2}{\omega} \Rightarrow x = \frac{\sqrt{159}}{72} \cos \omega t + \frac{2}{\omega} \sin \omega t$. Since amplitude of second
spring = $2C \Rightarrow 2\left(\frac{\sqrt{159}}{72}\right) = \sqrt{\left(\frac{\sqrt{159}}{72}\right)^2 + \left(\frac{2}{\omega}\right)^2} \Rightarrow \omega = \frac{48}{\sqrt{53}} \Rightarrow \frac{48}{\sqrt{53}} = \sqrt{\frac{k}{m}} = \sqrt{\frac{12}{m}} \Rightarrow m = \frac{53}{192} \Rightarrow mg = \left(\frac{53}{192}\right)32$
 $= 8.8333 \text{ lbs}$

14. First spring: $m_1 g = k_1 \cdot \frac{1}{4} \Rightarrow k_1 = 128m_1$; $\delta_1 = 0 \Rightarrow m_1 \frac{d^2 y}{dt^2} + 0 \cdot \frac{dy}{dt} + 128m_1 y = 0$, $y(0) = \frac{1}{12}$, $y'(0) = 0$
 $\Rightarrow m_1 r^2 + 128m_1 = 0 \Rightarrow r^2 + 128 = 0 \Rightarrow r = 0 \pm 8\sqrt{2}i \Rightarrow y = e^{0t} (c_1 \cos 8\sqrt{2}t + c_2 \sin 8\sqrt{2}t)$
 $= c_1 \cos 8\sqrt{2}t + c_2 \sin 8\sqrt{2}t \Rightarrow y' = -8\sqrt{2}c_1 \sin 8\sqrt{2}t + 8\sqrt{2}c_2 \cos 8\sqrt{2}t$; $y(0) = \frac{1}{12} \Rightarrow c_1 = \frac{1}{12}$, $y'(0) = 0$
 $\Rightarrow 8\sqrt{2}c_2 = 0 \Rightarrow c_2 = 0 \Rightarrow y(t) = \frac{1}{12} \cos 8\sqrt{2}t$

Second spring: $m_2 g = k_2 \cdot \frac{3}{4} \Rightarrow k_2 = \frac{128}{3}m_2$; $\delta_2 = 0 \Rightarrow m_2 \frac{d^2 x}{dt^2} + 0 \cdot \frac{dx}{dt} + \frac{128}{3}m_2 x = 0$, $x(0) = \frac{1}{12}$, $x'(0) = 0$
 $\Rightarrow \frac{d^2 x}{dt^2} + \frac{128}{3}x = 0 \Rightarrow r^2 + \frac{128}{3} = 0 \Rightarrow r = 0 \pm 8\sqrt{\frac{2}{3}}i \Rightarrow x = e^{0t} (c_3 \cos 8\sqrt{\frac{2}{3}}t + c_4 \sin 8\sqrt{\frac{2}{3}}t)$
 $= c_3 \cos 8\sqrt{\frac{2}{3}}t + c_4 \sin 8\sqrt{\frac{2}{3}}t \Rightarrow y' = -8\sqrt{\frac{2}{3}}c_3 \sin 8\sqrt{\frac{2}{3}}t + 8\sqrt{\frac{2}{3}}c_4 \cos 8\sqrt{\frac{2}{3}}t$; $x(0) = \frac{1}{12} \Rightarrow c_3 = \frac{1}{12}$, $x'(0) = 0$
 $\Rightarrow 8\sqrt{\frac{2}{3}}c_4 = 0 \Rightarrow c_4 = 0 \Rightarrow x(t) = \frac{1}{12} \cos 8\sqrt{\frac{2}{3}}t$

Equal velocities $\Rightarrow y' = x' \Rightarrow -\frac{2\sqrt{2}}{3} \sin 8\sqrt{2}t = -\frac{2}{3} \sqrt{\frac{2}{3}} \sin 8\sqrt{\frac{2}{3}}t \Rightarrow t \approx 0.2237 \text{ sec}$

15. $mg = 16 \Rightarrow m = \frac{1}{2}$; $16 = k \cdot 4 \Rightarrow k = 4$; $\delta = 0 \Rightarrow \frac{1}{2} \frac{d^2 y}{dt^2} + 0 \cdot \frac{dy}{dt} + 4y = 0$, $y(0) = 5$, $y'(0) = 0 \Rightarrow \frac{1}{2}r^2 + 4 = 0$
 $\Rightarrow r^2 + 8 = 0 \Rightarrow r = 0 \pm 2\sqrt{2}i \Rightarrow y = e^{0t} (c_1 \cos 2\sqrt{2}t + c_2 \sin 2\sqrt{2}t) = c_1 \cos 2\sqrt{2}t + c_2 \sin 2\sqrt{2}t$
 $\Rightarrow y' = -2\sqrt{2}c_1 \sin 2\sqrt{2}t + 2\sqrt{2}c_2 \cos 2\sqrt{2}t$; $y(0) = 5 \Rightarrow c_1 = 5$, $y'(0) = 0 \Rightarrow 2\sqrt{2}c_2 = 0 \Rightarrow c_2 = 0$
 $\Rightarrow y(t) = 5 \cos 2\sqrt{2}t$. The amplitude is $C = \sqrt{5^2 + 0^2} = 5$
 $y = c_3 \cos 2\sqrt{2}t + c_4 \sin 2\sqrt{2}t$, $y(0) = 5$, $y'(0) = v_0 \Rightarrow y' = -2\sqrt{2}c_3 \sin 2\sqrt{2}t + 2\sqrt{2}c_4 \cos 2\sqrt{2}t$; $y(0) = 5 \Rightarrow c_3 = 5$
 $y'(0) = v_0 \Rightarrow 2\sqrt{2}c_4 = v_0 \Rightarrow c_4 = \frac{v_0}{2\sqrt{2}} \Rightarrow y(t) = 5 \cos 2\sqrt{2}t + \frac{v_0}{2\sqrt{2}} \sin 2\sqrt{2}t$, and the new amplitude is $2 \cdot 5$
 $\Rightarrow 10 = \sqrt{5^2 + \left(\frac{v_0}{2\sqrt{2}}\right)^2} \Rightarrow v_0 = 10\sqrt{6} \approx 24.4949 \frac{\text{ft}}{\text{sec}}$

16. $mg = 8 \Rightarrow m = \frac{1}{4}$; $8 = k \cdot \frac{3}{12} \Rightarrow k = 32$; $\delta = 2 \Rightarrow \frac{1}{4} \frac{d^2 y}{dt^2} + 2 \frac{dy}{dt} + 32y = 0$, $y(0) = 0$, $y'(0) = \frac{1}{3} \Rightarrow \frac{1}{4}r^2 + 2r + 32 = 0$
 $\Rightarrow r^2 + 8r + 128 = 0 \Rightarrow r = \frac{-8 \pm \sqrt{8^2 - 4(1)(128)}}{2(1)} = -4 \pm 4\sqrt{7}i \Rightarrow y = e^{-4t} (c_1 \cos 4\sqrt{7}t + c_2 \sin 4\sqrt{7}t)$
 $\Rightarrow y' = e^{-4t} [(-4c_1 + 4\sqrt{7}c_2) \cos 4\sqrt{7}t + (-4\sqrt{7}c_1 - 4c_2) \sin 4\sqrt{7}t]$; $y(0) = 0 \Rightarrow c_1 = 0$, $y'(0) = \frac{1}{3}$
 $\Rightarrow -4c_1 + 4\sqrt{7}c_2 = \frac{1}{3} \Rightarrow c_1 = 0$, $c_2 = \frac{1}{12\sqrt{7}} \Rightarrow y(t) = \frac{1}{12\sqrt{7}} e^{-4t} \sin 4\sqrt{7}t$. Solve $y(t) = 0 \Rightarrow \frac{1}{12\sqrt{7}} e^{-4t} \sin 4\sqrt{7}t = 0$
 $\Rightarrow \sin 4\sqrt{7}t = 0 \Rightarrow t = \frac{\pi}{4\sqrt{7}} \approx 0.2969 \text{ sec}$

17. δ decreases by 90% in 10 sec \Rightarrow 10% remains $\Rightarrow e^{-10b} = \frac{1}{10} \Rightarrow b = -\frac{1}{10} \ln\left(\frac{1}{10}\right) = \frac{\ln 10}{10} \Rightarrow 2b = \frac{\delta}{m} \Rightarrow \delta = \frac{\ln 10}{5} m$
period = 2 sec $\Rightarrow 2 = \frac{2\pi}{\omega^2 - b^2} \Rightarrow 4 = \frac{4\pi^2}{\omega^2 - b^2} \Rightarrow \omega^2 = \pi^2 + b^2 = \pi^2 + \left(\frac{\ln 10}{10}\right)^2 = \frac{100\pi^2 + (\ln 10)^2}{100} \Rightarrow \frac{k}{m} = \frac{100\pi^2 + (\ln 10)^2}{100}$
 $k = \frac{100\pi^2 + (\ln 10)^2}{100} m \Rightarrow m \frac{d^2 y}{dt^2} + \left(\frac{\ln 10}{5} m\right) \frac{dy}{dt} + \left(\frac{100\pi^2 + (\ln 10)^2}{100} m\right) y = 0$. When $y = \frac{1}{4}$ and $y' = -2$, then
 $m \frac{d^2 y}{dt^2} + \left(\frac{\ln 10}{5} m\right)(-2) + \left(\frac{100\pi^2 + (\ln 10)^2}{100} m\right)\left(\frac{1}{4}\right) = 0 \Rightarrow \frac{d^2 y}{dt^2} = \frac{2 \ln 10}{5} - \frac{100\pi^2 + (\ln 10)^2}{400} \approx -1.5596 \frac{\text{ft}}{\text{sec}^2}$

18. $mg = 10 \Rightarrow m = \frac{5}{16}$; $10 = k \cdot 2 \Rightarrow k = 5$; $\delta = \frac{10}{\sqrt{32}} = \frac{5\sqrt{2}}{4} \Rightarrow \frac{5}{16} \frac{d^2y}{dt^2} + \frac{5\sqrt{2}}{4} \frac{dy}{dt} + 5y = 0$, $y(0) = \frac{1}{2}$, $y'(0) = 0$
 $\Rightarrow \frac{5}{16}r^2 + \frac{5\sqrt{2}}{4}r + 5 = 0 \Rightarrow r^2 + 4\sqrt{2}r + 16 = 0 \Rightarrow r = \frac{-4\sqrt{2} \pm \sqrt{(4\sqrt{2})^2 - 4(1)(16)}}{2(1)} = -2\sqrt{2} \pm 2\sqrt{2}i$
 $\Rightarrow y(t) = e^{-2\sqrt{2}t} (c_1 \cos 2\sqrt{2}t + c_2 \sin 2\sqrt{2}t)$
 $\Rightarrow y' = e^{-2\sqrt{2}t} [(-2\sqrt{2}c_1 + 2\sqrt{2}c_2) \cos 2\sqrt{2}t + (-2\sqrt{2}c_1 - 2\sqrt{2}c_2) \sin 2\sqrt{2}t]$; $y(0) = \frac{1}{2} \Rightarrow c_1 = \frac{1}{2}$,
 $y'(0) = 0 \Rightarrow -2\sqrt{2}c_1 + 2\sqrt{2}c_2 = 0 \Rightarrow c_1 = \frac{1}{2}$, $c_2 = \frac{1}{2} \Rightarrow y = e^{-2\sqrt{2}t} (\frac{1}{2} \cos 2\sqrt{2}t + \frac{1}{2} \sin 2\sqrt{2}t)$
 To find maximum, solve $y'(t) = 0 \Rightarrow y'(t) = -2\sqrt{2}e^{-2\sqrt{2}t} \sin 2\sqrt{2}t \Rightarrow -2\sqrt{2}e^{-2\sqrt{2}t} \sin 2\sqrt{2}t = 0$
 $\Rightarrow \sin 2\sqrt{2}t = 0 \Rightarrow t = 0, \frac{\pi}{2\sqrt{2}}, \frac{\pi}{\sqrt{2}}$, and at $t = \frac{\pi}{2\sqrt{2}}$, $y(\frac{\pi}{2\sqrt{2}}) \approx -0.02161 \text{ ft} \approx -0.2593 \text{ in}$ (above equilibrium)
19. $L = \frac{1}{5}$, $R = 1$, $C = \frac{5}{6}$, $E(t) = 0 \Rightarrow \frac{1}{5} \frac{d^2q}{dt^2} + 1 \cdot \frac{dq}{dt} + \frac{6}{5}q = 0$, $q(0) = 2$, $q'(0) = 4 \Rightarrow \frac{1}{5}r^2 + r + \frac{6}{5} = 0$
 $\Rightarrow r^2 + 5r + 6 = 0 \Rightarrow (r+3)(r+2) = 0 \Rightarrow r = -3$ or $r = -2 \Rightarrow q(t) = c_1 e^{-3t} + c_2 e^{-2t} \Rightarrow q' = -3c_1 e^{-3t} - 2c_2 e^{-2t}$
 $q(0) = 2 \Rightarrow c_1 + c_2 = 2$; $q'(0) = 4 \Rightarrow -3c_1 - 2c_2 = 4 \Rightarrow c_1 = -8$, $c_2 = 10 \Rightarrow q = -8e^{-3t} + 10e^{-2t}$
 $\lim_{t \rightarrow \infty} q = \lim_{t \rightarrow \infty} (-8e^{-3t} + 10e^{-2t}) = 0$
20. $\frac{1}{C}q = 10q$; $R \frac{dq}{dt} = 4 \frac{dq}{dt}$; $L \frac{d^2q}{dt^2} = 2 \frac{d^2q}{dt^2}$, $E(t) = 0 \Rightarrow 2 \frac{d^2q}{dt^2} + 4 \frac{dq}{dt} + 10q = 0$, $q(0) = 2$, $q'(0) = 3 \Rightarrow 2r^2 + 4r + 10 = 0$
 $\Rightarrow r^2 + 2r + 5 = 0 \Rightarrow r = \frac{-2 \pm \sqrt{2^2 - 4(1)(5)}}{2(1)} = -1 \pm 2i \Rightarrow q(t) = e^{-t} (c_1 \cos 2t + c_2 \sin 2t)$
 $\Rightarrow q' = e^{-t} ((-c_1 + 2c_2) \cos 2t + (-2c_1 - c_2) \sin 2t)$; $q(0) = 2 \Rightarrow c_1 + c_2 = 2$; $q'(0) = 3 \Rightarrow -c_1 + 2c_2 = 3$
 $\Rightarrow c_1 = \frac{1}{3}$, $c_2 = \frac{5}{3} \Rightarrow q(t) = e^{-t} (\frac{1}{3} \cos 2t + \frac{5}{3} \sin 2t)$
21. $mg = 16 \Rightarrow m = \frac{16}{32}$; $16 = k \cdot 4 \Rightarrow k = 4$; $\delta = 4.5$; $f(t) = 4 + e^{-2t} \Rightarrow \frac{1}{2} \frac{d^2y}{dt^2} + 4.5 \frac{dy}{dt} + 4y = 4 + e^{-2t}$, $y(0) = 2$, $y'(0) = 4$
 $\Rightarrow \frac{1}{2}r^2 + 4.5r + 4 = 0 \Rightarrow r^2 + 9r + 8 = 0 \Rightarrow (r+8)(r+1) = 0 \Rightarrow r = -8$ or $r = -1 \Rightarrow y_c = c_1 e^{-8t} + c_2 e^{-t}$;
 $y_p = A + Be^{-2t} \Rightarrow y'_p = -2Be^{-2t} \Rightarrow y''_p = 4Be^{-2t} \Rightarrow \frac{1}{2}(4Be^{-2t}) + 4.5(-2Be^{-2t}) + 4(A + Be^{-2t}) = 4 + e^{-2t}$
 $\Rightarrow 4A - 3Be^{-2t} = 4 + e^{-2t} \Rightarrow 4A = 4$, $-3B = 1 \Rightarrow A = 1$, $B = -\frac{1}{3} \Rightarrow y(t) = c_1 e^{-8t} + c_2 e^{-t} + 1 - \frac{1}{3}e^{-2t}$
 $\Rightarrow y' = -8c_1 e^{-8t} - c_2 e^{-t} + \frac{2}{3}e^{-2t}$; $y(0) = 2 \Rightarrow c_1 + c_2 + \frac{2}{3} = 2 \Rightarrow c_1 + c_2 = \frac{4}{3}$, $y'(0) = 4 \Rightarrow -8c_1 - c_2 + \frac{2}{3} = 4$
 $\Rightarrow -8c_1 - c_2 = \frac{10}{3} \Rightarrow c_1 = -\frac{2}{3}$, $c_2 = 2 \Rightarrow y(t) = -\frac{2}{3}e^{-8t} + 2e^{-t} + 1 - \frac{1}{3}e^{-2t}$
22. $m = 10$; $k = 140$; $\delta = 90$; $f(t) = 5 \sin t \Rightarrow 10 \frac{d^2y}{dt^2} + 90 \frac{dy}{dt} + 140y = 5 \sin t$, $y(0) = 0$, $y'(0) = -1 \Rightarrow 10r^2 + 90r + 140 = 0$
 $\Rightarrow r^2 + 9r + 14 = 0 \Rightarrow (r+2)(r+7) = 0 \Rightarrow r = -2$ or $r = -7 \Rightarrow y_c = c_1 e^{-2t} + c_2 e^{-7t}$; $y_p = A \sin t + B \cos t$
 $\Rightarrow y'_p = A \cos t - B \sin t \Rightarrow y''_p = -A \sin t - B \cos t$
 $\Rightarrow 10(-A \sin t - B \cos t) + 90(A \cos t - B \sin t) + 140(A \sin t + B \cos t) = 5 \sin t$
 $\Rightarrow (130A - 90B) \sin t + (90A + 130B) \cos t = 5 \sin t \Rightarrow A = \frac{13}{500}$, $B = -\frac{9}{500}$
 $\Rightarrow y(t) = c_1 e^{-2t} + c_2 e^{-7t} + \frac{13}{500} \sin t - \frac{9}{500} \cos t \Rightarrow y' = -2c_1 e^{-2t} - 7c_2 e^{-7t} + \frac{13}{500} \cos t + \frac{9}{500} \sin t$;
 $y(0) = 0 \Rightarrow c_1 + c_2 - \frac{9}{500} = 0$, $y'(0) = -1 \Rightarrow -2c_1 - 7c_2 + \frac{13}{500} = -1 \Rightarrow c_1 + c_2 = \frac{9}{500}$, $-2c_1 - 7c_2 = -\frac{513}{500}$
 $\Rightarrow c_1 = -\frac{9}{50}$, $c_2 = \frac{99}{500} \Rightarrow y(t) = -\frac{9}{50} e^{-2t} + \frac{99}{500} e^{-7t} + \frac{13}{500} \sin t - \frac{9}{500} \cos t$
23. $m = 2 \Rightarrow mg = 2(9.8) = 19.6$; $19.6 = k \cdot 1.96 \Rightarrow k = 10$; $\delta = 4$; $f(t) = 20 \cos t \Rightarrow 2 \frac{d^2y}{dt^2} + 4 \frac{dy}{dt} + 10y = 20 \cos t$,
 $y(0) = 2$, $y'(0) = 3 \Rightarrow 2r^2 + 4r + 10 = 0 \Rightarrow r = \frac{-4 \pm \sqrt{4^2 - 4(2)(10)}}{2(2)} = -1 \pm 2i \Rightarrow y_c = e^{-t} (c_1 \cos 2t + c_2 \sin 2t)$
 $y_p = A \sin t + B \cos t \Rightarrow y'_p = A \cos t - B \sin t \Rightarrow y''_p = -A \sin t - B \cos t$
 $\Rightarrow 2(-A \sin t - B \cos t) + 4(A \cos t - B \sin t) + 10(A \sin t + B \cos t) = 20 \cos t$
 $\Rightarrow (8A - 4B) \sin t + (4A + 8B) \cos t = 20 \cos t \Rightarrow 8A - 4B = 0$, $4A + 8B = 20 \Rightarrow A = 1$, $B = 2$
 $\Rightarrow y(t) = e^{-t} (c_1 \cos 2t + c_2 \sin 2t) + \sin t + 2 \cos t \Rightarrow y' = e^{-t} ((-c_1 + 2c_2) \cos 2t + (-2c_1 - c_2) \sin 2t) + \cos t - 2 \sin t$;

1020 Chapter 17 Second-Order Differential Equations

$$y(0) = 2 \Rightarrow c_1 + 2 = 2, y'(0) = 3 \Rightarrow -c_1 + 2c_2 + 1 = 3 \Rightarrow c_1 = 0, -c_1 + 2c_2 = 2 \Rightarrow c_1 = 0, c_2 = 1$$

$$\Rightarrow y(t) = e^{-t} \sin 2t + \sin t + 2 \cos t; y(\pi) = -2 \Rightarrow 2 \text{ m above equilibrium}$$

24. $mg = 8 \Rightarrow m = \frac{8}{32}$; $8 = k \cdot 4 \Rightarrow k = 2$; $\delta = 1.5$; $f(t) = 6 + e^{-t} \Rightarrow \frac{1}{4} \frac{d^2y}{dt^2} + 1.5 \frac{dy}{dt} + 2y = 6 + e^{-t}, y(0) = -2, y'(0) = 3$
 $\Rightarrow \frac{1}{4}r^2 + 1.5r + 2 = 0 \Rightarrow r^2 + 6r + 8 = 0 \Rightarrow (r + 2)(r + 4) = 0 \Rightarrow r = -2 \text{ or } r = -4 \Rightarrow y_c = c_1 e^{-2t} + c_2 e^{-4t}$;
 $y_p = A + B e^{-t} \Rightarrow y_p' = -B e^{-t} \Rightarrow y_p'' = B e^{-t} \Rightarrow \frac{1}{4}(B e^{-t}) + 1.5(-B e^{-t}) + 2(A + B e^{-t}) = 6 + e^{-t}$
 $\Rightarrow 2A + \frac{3}{4}B e^{-t} = 6 + e^{-t} \Rightarrow 2A = 6, \frac{3}{4}B = 1 \Rightarrow A = 3, B = \frac{4}{3} \Rightarrow y(t) = c_1 e^{-2t} + c_2 e^{-4t} + 3 + \frac{4}{3} e^{-t}$
 $\Rightarrow y' = -2c_1 e^{-2t} - 4c_2 e^{-4t} - \frac{4}{3} e^{-t}; y(0) = -2 \Rightarrow c_1 + c_2 + \frac{13}{3} = -2 \Rightarrow c_1 + c_2 = -\frac{19}{3}, y'(0) = 3$
 $\Rightarrow -2c_1 - 4c_2 - \frac{4}{3} = 3 \Rightarrow -2c_1 - 4c_2 = \frac{13}{3} \Rightarrow c_1 = -\frac{21}{2}, c_2 = \frac{25}{6} \Rightarrow y(t) = -\frac{21}{2} e^{-2t} + \frac{25}{6} e^{-4t} + 3 + \frac{4}{3} e^{-t}$;
 $y(2) \approx 2.98953 \Rightarrow 2.99 \text{ ft below equilibrium}$

25. $L = 10, R = 10, C = \frac{1}{500}, E(t) = 100 \Rightarrow 10 \frac{d^2q}{dt^2} + 10 \frac{dq}{dt} + 500q = 100, q(0) = 10, q'(0) = 0 \Rightarrow 10r^2 + 10r + 500 = 0$
 $\Rightarrow r^2 + r + 50 = 0 \Rightarrow r = \frac{-1 \pm \sqrt{1^2 - 4(1)(50)}}{2(1)} = -\frac{1}{2} \pm \frac{\sqrt{199}}{2} i \Rightarrow q_c = e^{-\frac{1}{2}t} \left(c_1 \cos \frac{\sqrt{199}}{2} t + c_2 \sin \frac{\sqrt{199}}{2} t \right)$
 $q_p = A \Rightarrow q_p' = 0 \Rightarrow q_p'' = 0 \Rightarrow 10(0) + 10(0) + 500A = 100 \Rightarrow 500A = 100 \Rightarrow A = \frac{1}{5}$
 $\Rightarrow q(t) = e^{-\frac{1}{2}t} \left(c_1 \cos \frac{\sqrt{199}}{2} t + c_2 \sin \frac{\sqrt{199}}{2} t \right) + \frac{1}{5} \Rightarrow q' = e^{-\frac{1}{2}t} \left[\left(-\frac{1}{2}c_1 + \frac{\sqrt{199}}{2}c_2 \right) \cos \frac{\sqrt{199}}{2} t + \left(-\frac{\sqrt{199}}{2}c_1 - \frac{1}{2}c_2 \right) \sin \frac{\sqrt{199}}{2} t \right]$
 $q(0) = 10 \Rightarrow c_1 + \frac{1}{5} = 10 \Rightarrow c_1 = \frac{49}{5}, q'(0) = 0 \Rightarrow -\frac{1}{2}c_1 + \frac{\sqrt{199}}{2}c_2 = 0 \Rightarrow c_1 = \frac{49}{5}, c_2 = \frac{49\sqrt{199}}{995}$
 $\Rightarrow q(t) = e^{-\frac{1}{2}t} \left(\frac{49}{5} \cos \frac{\sqrt{199}}{2} t + \frac{49\sqrt{199}}{995} \sin \frac{\sqrt{199}}{2} t \right) + \frac{1}{5}$

26. $R \frac{dq}{dt} = 4 \frac{dq}{dt}; \frac{1}{C} q = 10q; L \frac{di}{dt} = 2 \frac{d^2q}{dt^2}, E(t) = 20 \cos t \Rightarrow 2 \frac{d^2q}{dt^2} + 4 \frac{dq}{dt} + 10q = 0, q(0) = 2, q'(0) = 3 \Rightarrow 2r^2 + 4r + 10 = 0$
 $\Rightarrow r^2 + 2r + 5 = 0 \Rightarrow r = \frac{-2 \pm \sqrt{2^2 - 4(1)(5)}}{2(1)} = -1 \pm 2i \Rightarrow q_c = e^{-t}(c_1 \cos 2t + c_2 \sin 2t); q_p = A \sin t + B \cos t$
 $\Rightarrow q_p' = A \cos t - B \sin t \Rightarrow q_p'' = -A \sin t - B \cos t$
 $\Rightarrow 2(-A \sin t - B \cos t) + 4(A \cos t - B \sin t) + 10(A \sin t + B \cos t) = 20 \cos t$
 $\Rightarrow (8A - 4B) \sin t + (4A + 8B) \cos t = 20 \cos t \Rightarrow 8A - 4B = 0, 4A + 8B = 20 \Rightarrow A = 1, B = 2$
 $\Rightarrow q(t) = e^{-t}(c_1 \cos 2t + c_2 \sin 2t) + \sin t + 2 \cos t \Rightarrow q' = e^{-t}((-c_1 + 2c_2) \cos 2t + (-2c_1 - c_2) \sin 2t) + \cos t - 2 \sin t$;
 $q(0) = 2 \Rightarrow c_1 + 2 = 2; q'(0) = 3 \Rightarrow -c_1 + 2c_2 + 1 = 3 \Rightarrow c_2 = 1 \Rightarrow q(t) = 2e^{-t} \sin 2t + \sin t + 2 \cos t; y(10) \approx -2.222$
 $\Rightarrow 2.222 \text{ ft above equilibrium}$

17.4 EULER EQUATIONS

- $x^2 y'' + 2x y' - 2y = 0 \Rightarrow r^2 + (2 - 1)r - 2 = 0 \Rightarrow r^2 + r - 2 = 0 \Rightarrow (r - 1)(r + 2) = 0 \Rightarrow r = 1 \text{ or } r = -2$
 $\Rightarrow y = c_1 e^x + c_2 e^{-2x} = c_1 e^{\ln x} + c_2 e^{-2 \ln x} \Rightarrow y = c_1 x + \frac{c_2}{x^2}$
- $x^2 y'' + x y' - 4y = 0 \Rightarrow r^2 + (1 - 1)r - 4 = 0 \Rightarrow r^2 - 4 = 0 \Rightarrow (r - 2)(r + 2) = 0 \Rightarrow r = 2 \text{ or } r = -2$
 $\Rightarrow y = c_1 e^{2x} + c_2 e^{-2x} = c_1 e^{2 \ln x} + c_2 e^{-2 \ln x} \Rightarrow y = c_1 x^2 + \frac{c_2}{x^2}$
- $x^2 y'' - 6y = 0 \Rightarrow r^2 + (0 - 1)r - 6 = 0 \Rightarrow r^2 - r - 6 = 0 \Rightarrow (r - 3)(r + 2) = 0 \Rightarrow r = 3 \text{ or } r = -2$
 $\Rightarrow y = c_1 e^{3x} + c_2 e^{-2x} = c_1 e^{3 \ln x} + c_2 e^{-2 \ln x} \Rightarrow y = c_1 x^3 + \frac{c_2}{x^2}$
- $x^2 y'' + x y' - y = 0 \Rightarrow r^2 + (1 - 1)r - 1 = 0 \Rightarrow r^2 - 1 = 0 \Rightarrow (r - 1)(r + 1) = 0 \Rightarrow r = 1 \text{ or } r = -1$
 $\Rightarrow y = c_1 e^x + c_2 e^{-x} = c_1 e^{\ln x} + c_2 e^{-\ln x} \Rightarrow y = c_1 x + \frac{c_2}{x}$
- $x^2 y'' - 5x y' + 8y = 0 \Rightarrow r^2 + (-5 - 1)r + 8 = 0 \Rightarrow r^2 - 6r + 8 = 0 \Rightarrow (r - 4)(r - 2) = 0 \Rightarrow r = 4 \text{ or } r = 2$
 $\Rightarrow y = c_1 e^{4x} + c_2 e^{2x} = c_1 e^{4 \ln x} + c_2 e^{2 \ln x} \Rightarrow y = c_1 x^4 + c_2 x^2$

$$6. \quad 2x^2y'' + 7xy' + 2y = 0 \Rightarrow 2r^2 + (7-2)r + 2 = 0 \Rightarrow 2r^2 + 5r + 2 = 0 \Rightarrow (2r+1)(r+2) = 0 \Rightarrow r = -\frac{1}{2} \text{ or } r = -2 \\ \Rightarrow y = c_1e^{-\frac{1}{2}z} + c_2e^{-2z} = c_1e^{-\frac{1}{2}\ln x} + c_2e^{-2\ln x} \Rightarrow y = \frac{c_1}{\sqrt{x}} + \frac{c_2}{x^2}$$

$$7. \quad 3x^2y'' + 4xy' = 0 \Rightarrow 3r^2 + (4-3)r = 0 \Rightarrow 3r^2 + r = 0 \Rightarrow r(3r+1) = 0 \Rightarrow r = 0 \text{ or } r = -\frac{1}{3} \Rightarrow y = c_1e^{0z} + c_2e^{-\frac{1}{3}z} \\ = c_1e^{0\ln x} + c_2e^{-\frac{1}{3}\ln x} \Rightarrow y = c_1 + \frac{c_2}{\sqrt[3]{x}}$$

$$8. \quad x^2y'' + 6xy' + 4y = 0 \Rightarrow r^2 + (6-1)r + 4 = 0 \Rightarrow r^2 + 5r + 4 = 0 \Rightarrow (r+1)(r+4) = 0 \Rightarrow r = -1 \text{ or } r = -4 \\ \Rightarrow y = c_1e^{-z} + c_2e^{-4z} = c_1e^{-\ln x} + c_2e^{-4\ln x} \Rightarrow y = \frac{c_1}{x} + \frac{c_2}{x^4}$$

$$9. \quad x^2y'' - xy' + y = 0 \Rightarrow r^2 + (-1-1)r + 1 = 0 \Rightarrow r^2 - 2r + 1 = 0 \Rightarrow (r-1)^2 = 0 \Rightarrow r = 1, \text{ repeated twice} \\ \Rightarrow y = c_1e^z + c_2ze^z = c_1e^{\ln x} + c_2 \ln x e^{\ln x} \Rightarrow y = c_1x + c_2x \ln x$$

$$10. \quad x^2y'' - xy' + 2y = 0 \Rightarrow r^2 + (-1-1)r + 2 = 0 \Rightarrow r^2 - 2r + 2 = 0 \Rightarrow r = \frac{-(-2) \pm \sqrt{(-2)^2 - 4(1)(2)}}{2(1)} = 1 \pm i \\ \Rightarrow y = e^z(c_1 \cos z + c_2 \sin z) = e^{\ln x}(c_1 \cos(\ln x) + c_2 \sin(\ln x)) \Rightarrow y = x(c_1 \cos(\ln x) + c_2 \sin(\ln x))$$

$$11. \quad x^2y'' - xy' + 5y = 0 \Rightarrow r^2 + (-1-1)r + 5 = 0 \Rightarrow r^2 - 2r + 5 = 0 \Rightarrow r = \frac{-(-2) \pm \sqrt{(-2)^2 - 4(1)(5)}}{2(1)} = 1 \pm 2i \\ \Rightarrow y = e^z(c_1 \cos 2z + c_2 \sin 2z) = e^{\ln x}(c_1 \cos(2 \ln x) + c_2 \sin(2 \ln x)) \Rightarrow y = x(c_1 \cos(2 \ln x) + c_2 \sin(2 \ln x))$$

$$12. \quad x^2y'' + 7xy' + 13y = 0 \Rightarrow r^2 + (7-1)r + 13 = 0 \Rightarrow r^2 + 6r + 13 = 0 \Rightarrow r = \frac{-6 \pm \sqrt{(6)^2 - 4(1)(13)}}{2(1)} = -3 \pm 2i \\ \Rightarrow y = e^{-3z}(c_1 \cos 2z + c_2 \sin 2z) = e^{-3\ln x}(c_1 \cos(2 \ln x) + c_2 \sin(2 \ln x)) \Rightarrow y = \frac{1}{x^3}(c_1 \cos(2 \ln x) + c_2 \sin(2 \ln x))$$

$$13. \quad x^2y'' + 3xy' + 10y = 0 \Rightarrow r^2 + (3-1)r + 10 = 0 \Rightarrow r^2 + 2r + 10 = 0 \Rightarrow r = \frac{-2 \pm \sqrt{(2)^2 - 4(1)(10)}}{2(1)} = -1 \pm 3i \\ \Rightarrow y = e^{-z}(c_1 \cos 3z + c_2 \sin 3z) = e^{-\ln x}(c_1 \cos(3 \ln x) + c_2 \sin(3 \ln x)) \Rightarrow y = \frac{1}{x}(c_1 \cos(3 \ln x) + c_2 \sin(3 \ln x))$$

$$14. \quad x^2y'' - 5xy' + 10y = 0 \Rightarrow r^2 + (-5-1)r + 10 = 0 \Rightarrow r^2 - 6r + 10 = 0 \Rightarrow r = \frac{-(-6) \pm \sqrt{(-6)^2 - 4(1)(10)}}{2(1)} = 3 \pm i \\ \Rightarrow y = e^{3z}(c_1 \cos z + c_2 \sin z) = e^{3\ln x}(c_1 \cos(\ln x) + c_2 \sin(\ln x)) \Rightarrow y = x^3(c_1 \cos(\ln x) + c_2 \sin(\ln x))$$

$$15. \quad 4x^2y'' + 8xy' + 5y = 0 \Rightarrow r^2 + (8-4)r + 5 = 0 \Rightarrow 4r^2 + 4r + 5 = 0 \Rightarrow r = \frac{-4 \pm \sqrt{(4)^2 - 4(4)(5)}}{2(4)} = -\frac{1}{2} \pm i \\ \Rightarrow y = e^{-\frac{1}{2}z}(c_1 \cos z + c_2 \sin z) = e^{-\frac{1}{2}\ln x}(c_1 \cos(\ln x) + c_2 \sin(\ln x)) \Rightarrow y = \frac{1}{\sqrt{x}}(c_1 \cos(\ln x) + c_2 \sin(\ln x))$$

$$16. \quad 4x^2y'' - 4xy' + 5y = 0 \Rightarrow 4r^2 + (-4-4)r + 5 = 0 \Rightarrow 4r^2 - 8r + 5 = 0 \Rightarrow r = \frac{-(-8) \pm \sqrt{(-8)^2 - 4(4)(5)}}{2(4)} = 1 \pm \frac{1}{2}i \\ \Rightarrow y = e^z(c_1 \cos(\frac{1}{2}z) + c_2 \sin(\frac{1}{2}z)) = e^{\ln x}(c_1 \cos(\frac{1}{2} \ln x) + c_2 \sin(\frac{1}{2} \ln x)) \Rightarrow y = x(c_1 \cos(\frac{1}{2} \ln x) + c_2 \sin(\frac{1}{2} \ln x))$$

$$17. \quad x^2y'' + 3xy' + y = 0 \Rightarrow r^2 + (3-1)r + 1 = 0 \Rightarrow r^2 + 2r + 1 = 0 \Rightarrow (r+1)^2 = 0 \Rightarrow r = -1, \text{ repeated twice} \\ \Rightarrow y = c_1e^{-z} + c_2ze^{-z} = c_1e^{-\ln x} + c_2 \ln x e^{-\ln x} \Rightarrow y = \frac{c_1}{x} + \frac{c_2 \ln x}{x}$$

$$18. \quad x^2y'' - 3xy' + 9y = 0 \Rightarrow r^2 + (-3-1)r + 9 = 0 \Rightarrow r^2 - 4r + 9 = 0 \Rightarrow r = \frac{-(-4) \pm \sqrt{(-4)^2 - 4(1)(9)}}{2(1)} = 2 \pm \sqrt{5}i \\ \Rightarrow y = e^{2z}(c_1 \cos(\sqrt{5}z) + c_2 \sin(\sqrt{5}z)) = e^{2\ln x}(c_1 \cos(\sqrt{5} \ln x) + c_2 \sin(\sqrt{5} \ln x)) \\ \Rightarrow y = x^2(c_1 \cos(\sqrt{5} \ln x) + c_2 \sin(\sqrt{5} \ln x))$$

1022 Chapter 17 Second-Order Differential Equations

19. $x^2y'' + xy' = 0 \Rightarrow r^2 + (1-1)r = 0 \Rightarrow r^2 = 0 \Rightarrow r = 0$, repeated twice $\Rightarrow y = c_1e^{0z} + c_2ze^{0z} = c_1e^{0\ln x} + c_2 \ln x e^{0\ln x}$
 $\Rightarrow y = c_1 + c_2 \ln x$
20. $4x^2y'' + y = 0 \Rightarrow 4r^2 + (0-4)r + 1 = 0 \Rightarrow 4r^2 - 4r + 1 = 0 \Rightarrow (2r-1)^2 = 0 \Rightarrow r = \frac{1}{2}$, repeated twice
 $\Rightarrow y = c_1e^{\frac{1}{2}z} + c_2ze^{\frac{1}{2}z} = c_1e^{\frac{1}{2}\ln x} + c_2 \ln x e^{\frac{1}{2}\ln x} \Rightarrow y = c_1\sqrt{x} + c_2\sqrt{x} \ln x$
21. $9x^2y'' + 15xy' + y = 0 \Rightarrow 9r^2 + (15-9)r + 1 = 0 \Rightarrow 9r^2 + 6r + 1 = 0 \Rightarrow (3r+1)^2 = 0 \Rightarrow r = -\frac{1}{3}$, repeated twice
 $\Rightarrow y = c_1e^{-\frac{1}{3}z} + c_2ze^{-\frac{1}{3}z} = c_1e^{-\frac{1}{3}\ln x} + c_2 \ln x e^{-\frac{1}{3}\ln x} \Rightarrow y = \frac{c_1}{\sqrt[3]{x}} + \frac{c_2 \ln x}{\sqrt[3]{x}}$
22. $16x^2y'' - 8xy' + 9y = 0 \Rightarrow 16r^2 + (-8-16)r + 9 = 0 \Rightarrow 16r^2 - 24r + 9 = 0 \Rightarrow (4r-3)^2 = 0 \Rightarrow r = \frac{3}{4}$, repeated twice
 $\Rightarrow y = c_1e^{\frac{3}{4}z} + c_2ze^{\frac{3}{4}z} = c_1e^{\frac{3}{4}\ln x} + c_2 \ln x e^{\frac{3}{4}\ln x} \Rightarrow y = c_1x^{3/4} + c_2x^{3/4} \ln x$
23. $16x^2y'' + 56xy' + 25y = 0 \Rightarrow 16r^2 + (56-16)r + 25 = 0 \Rightarrow 16r^2 + 40r + 25 = 0 \Rightarrow (4r+5)^2 = 0 \Rightarrow r = -\frac{5}{4}$, repeated twice
 $\Rightarrow y = c_1e^{-\frac{5}{4}z} + c_2ze^{-\frac{5}{4}z} = c_1e^{-\frac{5}{4}\ln x} + c_2 \ln x e^{-\frac{5}{4}\ln x} \Rightarrow y = \frac{c_1}{x^{5/4}} + \frac{c_2 \ln x}{x^{5/4}}$
24. $4x^2y'' - 16xy' + 25y = 0 \Rightarrow 4r^2 + (-16-4)r + 25 = 0 \Rightarrow 4r^2 - 20r + 25 = 0 \Rightarrow (2r-5)^2 = 0 \Rightarrow r = \frac{5}{2}$, repeated twice
 $\Rightarrow y = c_1e^{\frac{5}{2}z} + c_2ze^{\frac{5}{2}z} = c_1e^{\frac{5}{2}\ln x} + c_2 \ln x e^{\frac{5}{2}\ln x} \Rightarrow y = c_1x^{5/2} + c_2x^{5/2} \ln x$
25. $x^2y'' + 3xy' - 3y = 0, y(1) = 1, y'(1) = -1 \Rightarrow r^2 + (3-1)r - 3 = 0 \Rightarrow r^2 + 2r - 3 = 0 \Rightarrow (r-1)(r+3) = 0$
 $\Rightarrow r = 1$ or $r = -3 \Rightarrow y = c_1e^z + c_2e^{-3z} = c_1e^{\ln x} + c_2e^{-3\ln x} \Rightarrow y = c_1x + \frac{c_2}{x^3} \Rightarrow y' = c_1 - \frac{3c_2}{x^4};$
 $y(1) = 1 \Rightarrow c_1 + c_2 = 1; y'(1) = -1 \Rightarrow c_1 - 3c_2 = -1 \Rightarrow c_1 = \frac{1}{2}, c_2 = \frac{1}{2} \Rightarrow y = \frac{1}{2}x + \frac{1}{2x^3}$
26. $6x^2y'' + 7xy' - 2y = 0, y(1) = 0, y'(1) = 1 \Rightarrow 6r^2 + (7-6)r - 2 = 0 \Rightarrow 6r^2 + r - 2 = 0 \Rightarrow (2r-1)(3r+2) = 0$
 $\Rightarrow r = \frac{1}{2}$ or $r = -\frac{2}{3} \Rightarrow y = c_1e^{\frac{1}{2}z} + c_2e^{-\frac{2}{3}z} = c_1e^{\frac{1}{2}\ln x} + c_2e^{-\frac{2}{3}\ln x} \Rightarrow y = c_1\sqrt{x} + \frac{c_2}{x^{2/3}} \Rightarrow y' = \frac{c_1}{2\sqrt{x}} - \frac{2c_2}{3x^{5/3}};$
 $y(1) = 0 \Rightarrow c_1 + c_2 = 0; y'(1) = 1 \Rightarrow \frac{1}{2}c_1 - \frac{2}{3}c_2 = 1 \Rightarrow c_1 = \frac{6}{7}, c_2 = -\frac{6}{7} \Rightarrow y = \frac{6}{7}\sqrt{x} - \frac{6}{7x^{2/3}}$
27. $x^2y'' - xy' + y = 0, y(1) = 1, y'(1) = 1 \Rightarrow r^2 + (-1-1)r + 1 = 0 \Rightarrow r^2 - 2r + 1 = 0 \Rightarrow (r-1)^2 = 0 \Rightarrow r = 1$, repeated twice
 $\Rightarrow y = c_1e^z + c_2ze^z = c_1e^{\ln x} + c_2 \ln x e^{\ln x} \Rightarrow y = c_1x + c_2x \ln x \Rightarrow y' = c_1 + c_2 \ln x + c_2;$
 $y(1) = 1 \Rightarrow c_1 = 1; y'(1) = 1 \Rightarrow c_1 + c_2 = 1 \Rightarrow c_1 = 1, c_2 = 0 \Rightarrow y = x$
28. $x^2y'' + 7xy' + 9y = 0, y(1) = 1, y'(1) = 0 \Rightarrow r^2 + (7-1)r + 9 = 0 \Rightarrow r^2 + 6r + 9 = 0 \Rightarrow (r+3)^2 = 0 \Rightarrow r = -3$, repeated twice
 $\Rightarrow y = c_1e^{-3z} + c_2ze^{-3z} = c_1e^{-3\ln x} + c_2 \ln x e^{-3\ln x} \Rightarrow y = \frac{c_1}{x^3} + \frac{c_2 \ln x}{x^3} \Rightarrow y' = -\frac{3c_1}{x^4} + c_2 \frac{1-3\ln x}{x^4};$
 $y(1) = 1 \Rightarrow c_1 = 1; y'(1) = 0 \Rightarrow -3c_1 + c_2 = 0 \Rightarrow c_1 = 1, c_2 = 3 \Rightarrow y = \frac{1}{x^3} + \frac{3\ln x}{x^3}$
29. $x^2y'' - xy' + 2y = 0, y(1) = -1, y'(1) = 1 \Rightarrow r^2 + (-1-1)r + 2 = 0 \Rightarrow r^2 - 2r + 2 = 0 \Rightarrow r = \frac{-(-2) \pm \sqrt{(-2)^2 - 4(1)(2)}}{2(1)}$
 $= 1 \pm i \Rightarrow y = e^z(c_1 \cos z + c_2 \sin z) = e^{\ln x}(c_1 \cos(\ln x) + c_2 \sin(\ln x)) \Rightarrow y = x(c_1 \cos(\ln x) + c_2 \sin(\ln x))$
 $\Rightarrow y' = (c_1 + c_2)\cos(\ln x) + (c_2 - c_1)\sin(\ln x); y(1) = -1 \Rightarrow c_1 = -1; y'(1) = 1 \Rightarrow c_1 + c_2 = 1 \Rightarrow c_1 = -1, c_2 = 2$
 $\Rightarrow y = x(-\cos(\ln x) + 2\sin(\ln x))$
30. $x^2y'' + 3xy' + 5y = 0, y(1) = 1, y'(1) = 0 \Rightarrow r^2 + (3-1)r + 5 = 0 \Rightarrow r^2 + 2r + 5 = 0 \Rightarrow r = \frac{-2 \pm \sqrt{(2)^2 - 4(1)(5)}}{2(1)}$
 $= -1 \pm 2i \Rightarrow y = e^{-z}(c_1 \cos 2z + c_2 \sin 2z) = e^{-\ln x}(c_1 \cos(2 \ln x) + c_2 \sin(2 \ln x)) \Rightarrow y = \frac{1}{x}(c_1 \cos(2 \ln x) + c_2 \sin(2 \ln x))$
 $\Rightarrow y' = -\frac{1}{x^2}((c_1 - 2c_2)\cos(2 \ln x) + (2c_1 + c_2)\sin(2 \ln x)); y(1) = 1 \Rightarrow c_1 = 1; y'(1) = 0 \Rightarrow -c_1 + 2c_2 = 0 \Rightarrow c_1 = 1,$
 $c_2 = \frac{1}{2} \Rightarrow y = \frac{1}{x}(\cos(2 \ln x) + \frac{1}{2}\sin(2 \ln x))$

17.5 POWER-SERIES SOLUTIONS

$$1. \quad y'' + 2y' = 0 \Rightarrow \sum_{n=2}^{\infty} n(n-1)c_n x^{n-2} + 2 \sum_{n=1}^{\infty} n c_n x^{n-1} = 0 \Rightarrow \sum_{n=2}^{\infty} n(n-1)c_n x^{n-2} + \sum_{n=1}^{\infty} 2n c_n x^{n-1} = 0$$

<u>power of x</u>	<u>coefficient equation</u>	
x^0	$2(1)c_2 + 2(1)c_1 = 0$	$\Rightarrow c_2 = -c_1$
x^1	$3(2)c_3 + 2(2)c_2 = 0$	$\Rightarrow c_3 = -\frac{2}{3}c_2 = \frac{2}{3}c_1$
x^2	$4(3)c_4 + 2(3)c_3 = 0$	$\Rightarrow c_4 = -\frac{1}{2}c_3 = -\frac{1}{3}c_1$
x^3	$5(4)c_5 + 2(4)c_4 = 0$	$\Rightarrow c_5 = -\frac{2}{5}c_4 = \frac{2}{15}c_1$
x^4	$6(5)c_6 + 2(5)c_5 = 0$	$\Rightarrow c_6 = -\frac{1}{3}c_5 = -\frac{2}{45}c_1$
\vdots	\vdots	\vdots
x^n	$(n+2)(n+1)c_{n+2} + 2(n+1)c_{n+1} = 0$	$\Rightarrow c_{n+2} = -\frac{2}{n+2}c_{n+1}$

or $c_n = -\frac{2}{n}c_{n-1} = \left(-\frac{2}{n}\right)\left(-\frac{2}{n-1}c_{n-2}\right) = \left(-\frac{2}{n}\right)\left(-\frac{2}{n-1}\right)\left(-\frac{2}{n-2}c_{n-3}\right) = \frac{(-2)^{n-1}}{n!}c_1, n \geq 2$. Thus

$$y = c_0 + c_1x - c_1x^2 + \frac{2}{3}c_1x^3 - \frac{1}{3}c_1x^4 + \frac{2}{15}c_1x^5 - \frac{2}{45}c_1x^6 + \dots = c_0 + c_1\left(x - x^2 + \frac{2}{3}x^3 - \frac{1}{3}x^4 + \frac{2}{15}x^5 - \frac{2}{45}x^6 + \dots\right)$$

$$\text{or } y = c_0 + \frac{c_1}{2} - \frac{c_1}{2} + \frac{c_1}{2}(2x) - \frac{c_1}{2}\frac{(2x)^2}{2!} + \frac{c_1}{2}\frac{(2x)^3}{3!} - \frac{c_1}{2}\frac{(2x)^4}{4!} + \frac{c_1}{2}\frac{(2x)^5}{5!} - \frac{c_1}{2}\frac{(2x)^6}{6!} + \dots$$

$$y = \left(c_0 + \frac{c_1}{2}\right) - \frac{c_1}{2}\left(1 - (2x) + \frac{(2x)^2}{2!} - \frac{(2x)^3}{3!} + \frac{(2x)^4}{4!} - \frac{(2x)^5}{5!} + \frac{(2x)^6}{6!} + \dots\right) = \left(c_0 + \frac{c_1}{2}\right) - \frac{c_1}{2}\sum_{n=0}^{\infty} \frac{(-2x)^n}{n!}$$

$$= \left(c_0 + \frac{c_1}{2}\right) - \frac{c_1}{2}e^{-2x} = a + be^{-2x}, \text{ where } a = c_0 + \frac{c_1}{2} \text{ and } b = -\frac{c_1}{2}$$

$$2. \quad y'' + 2y' + y = 0 \Rightarrow \sum_{n=2}^{\infty} n(n-1)c_n x^{n-2} + 2 \sum_{n=1}^{\infty} n c_n x^{n-1} + \sum_{n=0}^{\infty} c_n x^n = 0$$

$$\Rightarrow \sum_{n=2}^{\infty} n(n-1)c_n x^{n-2} + \sum_{n=1}^{\infty} 2n c_n x^{n-1} + \sum_{n=0}^{\infty} c_n x^n = 0$$

<u>power of x</u>	<u>coefficient equation</u>	
x^0	$2(1)c_2 + 2(1)c_1 + c_0 = 0$	$\Rightarrow c_2 = -c_1 - \frac{1}{2}c_0$
x^1	$3(2)c_3 + 2(2)c_2 + c_1 = 0$	$\Rightarrow c_3 = -\frac{2}{3}c_2 - \frac{1}{6}c_1 = \frac{1}{2}c_1 + \frac{1}{3}c_0$
x^2	$4(3)c_4 + 2(3)c_3 + c_2 = 0$	$\Rightarrow c_4 = -\frac{1}{2}c_3 - \frac{1}{12}c_2 = -\frac{1}{6}c_1 - \frac{1}{8}c_0$
x^3	$5(4)c_5 + 2(4)c_4 + c_3 = 0$	$\Rightarrow c_5 = -\frac{2}{5}c_4 - \frac{1}{20}c_3 = \frac{1}{24}c_1 + \frac{1}{30}c_0$
x^4	$6(5)c_6 + 2(5)c_5 + c_4 = 0$	$\Rightarrow c_6 = -\frac{1}{3}c_5 - \frac{1}{30}c_4 = -\frac{1}{120}c_1 - \frac{1}{144}c_0$
\vdots	\vdots	\vdots
x^n	$(n+2)(n+1)c_{n+2} + 2(n+1)c_{n+1} + c_n = 0$	$\Rightarrow c_{n+2} = -\frac{2}{n+2}c_{n+1} - \frac{1}{(n+2)(n+1)}c_n$

$$y = c_0 + c_1x + \left(-c_1 - \frac{1}{2}c_0\right)x^2 + \left(\frac{1}{2}c_1 + \frac{1}{3}c_0\right)x^3 + \left(-\frac{1}{6}c_1 - \frac{1}{8}c_0\right)x^4 + \left(\frac{1}{24}c_1 + \frac{1}{30}c_0\right)x^5 + \left(-\frac{1}{120}c_1 - \frac{1}{144}c_0\right)x^6 + \dots$$

$$= c_0 - \frac{1}{2}c_0x^2 + \frac{1}{3}c_0x^3 - \frac{1}{8}c_0x^4 + \frac{1}{30}c_0x^5 - \frac{1}{144}c_0x^6 + \dots + c_1x - c_1x^2 + \frac{1}{2}c_1x^3 - \frac{1}{6}c_1x^4 + \frac{1}{24}c_1x^5 - \frac{1}{120}c_1x^6 + \dots$$

$$= c_0\left(1 - \frac{1}{2}x^2 + \frac{1}{3}x^3 - \frac{1}{8}x^4 + \frac{1}{30}x^5 - \frac{1}{144}x^6 + \dots\right) + c_1\left(x - x^2 + \frac{1}{2}x^3 - \frac{1}{6}x^4 + \frac{1}{24}x^5 - \frac{1}{120}x^6 + \dots\right)$$

Note that in each coefficient equation, the coefficient of c_1 can be given by $\frac{(-1)^{n-1}}{(n-1)!}$. To find the coefficient of c_0 , note that:

$$-\frac{1}{2} = -\left(1 - \frac{1}{2}\right) = -\left(\frac{1!}{1!} - \frac{1}{2!}\right), \frac{1}{3} = \frac{1}{2} - \frac{1}{6} = \frac{1}{2!} - \frac{1}{3!}, -\frac{1}{8} = -\left(\frac{1}{6} - \frac{1}{24}\right) = -\left(\frac{1}{3!} - \frac{1}{4!}\right), \frac{1}{30} = \frac{1}{24} - \frac{1}{120} = \frac{1}{4!} - \frac{1}{5!}$$

so the coefficient of c_0 can be given by $(-1)^{n-1}\left[\frac{1}{(n-1)!} - \frac{1}{n!}\right] = \frac{(-1)^{n-1}}{(n-1)!} + \frac{(-1)^n}{n!}$. Thus $c_n = \left[\frac{(-1)^{n-1}}{(n-1)!} + \frac{(-1)^n}{n!}\right]c_0 + \frac{(-1)^{n-1}}{(n-1)!}c_1$

$$\text{or } c_n = \frac{(-1)^n}{n!}c_0 + \frac{(-1)^{n-1}}{(n-1)!}(c_0 + c_1) \text{ for } n \geq 2. \text{ Thus } y = c_0 + c_1x + \sum_{n=2}^{\infty} \left(\frac{(-1)^n}{n!}c_0 + \frac{(-1)^{n-1}}{(n-1)!}(c_0 + c_1)\right)x^n$$

$$= c_0 + c_1x + c_0 \sum_{n=2}^{\infty} \frac{(-1)^n}{n!}x^n + c_0 \sum_{n=2}^{\infty} \frac{(-1)^{n-1}}{(n-1)!}x^n + c_1 \sum_{n=2}^{\infty} \frac{(-1)^{n-1}}{(n-1)!}x^n$$

$$= c_0 - c_0x + c_0 \sum_{n=2}^{\infty} \frac{(-1)^n}{n!}x^n + c_0x + c_0 \sum_{n=2}^{\infty} \frac{(-1)^{n-1}}{(n-1)!}x^n + c_1x + c_1 \sum_{n=2}^{\infty} \frac{(-1)^{n-1}}{(n-1)!}x^n$$

$$= c_0 \sum_{n=0}^{\infty} \frac{(-1)^n}{n!}x^n + c_0x \sum_{n=1}^{\infty} \frac{(-1)^{n-1}}{(n-1)!}x^{n-1} + c_1x \sum_{n=1}^{\infty} \frac{(-1)^{n-1}}{(n-1)!}x^{n-1} = c_0 \sum_{n=0}^{\infty} \frac{(-1)^n}{n!}x^n + (c_0 + c_1)x \sum_{n=1}^{\infty} \frac{(-1)^{n-1}}{(n-1)!}x^{n-1}$$

$$= c_0 \sum_{n=0}^{\infty} \frac{(-1)^n}{n!}x^n + (c_0 + c_1)x \sum_{k=0}^{\infty} \frac{(-1)^k}{k!}x^k = c_0e^{-x} + (c_0 + c_1)xe^{-x} = ae^{-x} + bxe^{-x}, \text{ where } a = c_0 \text{ and } b = c_0 + c_1$$

$$3. \quad y'' + 4y = 0 \Rightarrow \sum_{n=2}^{\infty} n(n-1)c_n x^{n-2} + 4 \sum_{n=0}^{\infty} c_n x^n = 0 \Rightarrow \sum_{n=2}^{\infty} n(n-1)c_n x^{n-2} + \sum_{n=0}^{\infty} 4c_n x^n = 0$$

<u>power of x</u>	<u>coefficient equation</u>	
x^0	$2(1)c_2 + 4c_0 = 0$	$\Rightarrow c_2 = -2c_0$
x^1	$3(2)c_3 + 4c_1 = 0$	$\Rightarrow c_3 = -\frac{2}{3}c_1$
x^2	$4(3)c_4 + 4c_2 = 0$	$\Rightarrow c_4 = -\frac{1}{3}c_2 = \frac{2}{3}c_0$
x^3	$5(4)c_5 + 4c_3 = 0$	$\Rightarrow c_5 = -\frac{1}{5}c_3 = \frac{2}{15}c_1$
x^4	$6(5)c_6 + 4c_4 = 0$	$\Rightarrow c_6 = -\frac{2}{15}c_4 = -\frac{4}{45}c_0$
\vdots	\vdots	\vdots
x^n	$(n+2)(n+1)c_{n+2} + 4c_n = 0$	$\Rightarrow c_{n+2} = -\frac{4}{(n+2)(n+1)}c_n$

$$\begin{aligned} y &= c_0 + c_1x - 2c_0x^2 - \frac{2}{3}c_1x^3 + \frac{2}{3}c_0x^4 + \frac{2}{15}c_1x^5 - \frac{4}{45}c_0x^6 + \dots \\ &= c_0 - 2c_0x^2 + \frac{2}{3}c_0x^4 - \frac{4}{45}c_0x^6 + \dots + c_1x - \frac{2}{3}c_1x^3 + \frac{2}{15}c_1x^5 + \dots \\ &= c_0 \left(1 - \frac{(2x)^2}{2!} + \frac{(2x)^4}{4!} - \frac{(2x)^6}{6!} + \dots \right) + \frac{c_1}{2} \left(2x - \frac{(2x)^3}{3!} + \frac{(2x)^5}{5!} + \dots \right) = c_0 \sum_{n=0}^{\infty} \frac{(-1)^n}{(2n)!} (2x)^{2n} + \frac{c_1}{2} \sum_{n=0}^{\infty} \frac{(-1)^n}{(2n+1)!} (2x)^{2n+1} \\ &= c_0 \cos 2x + \frac{c_1}{2} \sin 2x = a \cos 2x + b \sin 2x, \text{ where } a = c_0 \text{ and } b = \frac{c_1}{2} \end{aligned}$$

$$4. \quad y'' - 3y' + 2y = 0 \Rightarrow \sum_{n=2}^{\infty} n(n-1)c_n x^{n-2} - 3 \sum_{n=1}^{\infty} n c_n x^{n-1} + 2 \sum_{n=0}^{\infty} c_n x^n = 0$$

$$\Rightarrow \sum_{n=2}^{\infty} n(n-1)c_n x^{n-2} - \sum_{n=1}^{\infty} 3n c_n x^{n-1} + \sum_{n=0}^{\infty} 2c_n x^n = 0$$

<u>power of x</u>	<u>coefficient equation</u>	
x^0	$2(1)c_2 - 3(1)c_1 + 2c_0 = 0$	$\Rightarrow c_2 = \frac{3}{2}c_1 - c_0$
x^1	$3(2)c_3 - 3(2)c_2 + 2c_1 = 0$	$\Rightarrow c_3 = c_2 - \frac{1}{3}c_1 = \frac{7}{6}c_1 - c_0$
x^2	$4(3)c_4 - 3(3)c_3 + 2c_2 = 0$	$\Rightarrow c_4 = \frac{3}{4}c_3 - \frac{1}{6}c_2 = \frac{5}{8}c_1 - \frac{7}{12}c_0$
x^3	$5(4)c_5 - 3(4)c_4 + 2c_3 = 0$	$\Rightarrow c_5 = \frac{3}{5}c_4 - \frac{1}{10}c_3 = \frac{31}{120}c_1 - \frac{1}{4}c_0$
x^4	$6(5)c_6 - 3(5)c_5 + 2c_4 = 0$	$\Rightarrow c_6 = \frac{1}{2}c_5 - \frac{1}{15}c_4 = \frac{7}{80}c_1 - \frac{31}{360}c_0$
\vdots	\vdots	\vdots
x^n	$(n+2)(n+1)c_{n+2} - 3(n+1)c_{n+1} + 2c_n = 0$	$\Rightarrow c_{n+2} = \frac{3}{n+2}c_{n+1} - \frac{2}{(n+2)(n+1)}c_n$

$$\begin{aligned} y &= c_0 + c_1x + \left(\frac{3}{2}c_1 - c_0\right)x^2 + \left(\frac{7}{6}c_1 - c_0\right)x^3 + \left(\frac{5}{8}c_1 - \frac{7}{12}c_0\right)x^4 + \left(\frac{31}{120}c_1 - \frac{1}{4}c_0\right)x^5 + \left(\frac{7}{80}c_1 - \frac{31}{360}c_0\right)x^6 + \dots \\ &= c_0 - c_0x^2 - c_0x^3 - \frac{7}{12}c_0x^4 - \frac{1}{4}c_0x^5 - \frac{31}{360}c_0x^6 + \dots + c_1x + \frac{3}{2}c_1x^2 + \frac{7}{6}c_1x^3 + \frac{5}{8}c_1x^4 + \frac{31}{120}c_1x^5 + \frac{7}{80}c_1x^6 + \dots \\ &= c_0 \left(1 - x^2 - \frac{1}{3}x^3 - \frac{7}{12}x^4 - \frac{1}{4}x^5 - \frac{31}{360}x^6 - \dots \right) + c_1 \left(x + \frac{3}{2}x^2 + \frac{7}{6}x^3 + \frac{5}{8}x^4 + \frac{31}{120}x^5 + \frac{7}{80}x^6 + \dots \right) \end{aligned}$$

Note that if we use the techniques of Section 17.2, our solution is $y = a e^x + b e^{2x} = a \sum_{n=0}^{\infty} \frac{x^n}{n!} + b \sum_{n=0}^{\infty} \frac{(2x)^n}{n!}$. Thus

$$(a + b) + (a + 2b)x + \dots = c_0 + c_1x + \left(\frac{3}{2}c_1 - c_0\right)x^2 + \left(\frac{7}{6}c_1 - c_0\right)x^3 + \left(\frac{5}{8}c_1 - \frac{7}{12}c_0\right)x^4 + \left(\frac{31}{120}c_1 - \frac{1}{4}c_0\right)x^5 + \dots$$

If the series are equivalent, then take $c_0 = a + b$ and $c_1 = a + 2b$ and substitute in our first series for c_0 and c_1 to obtain

$$\begin{aligned} y &= (a + b) + (a + 2b)x + \left(\frac{3}{2}(a + 2b) - (a + b)\right)x^2 + \left(\frac{7}{6}(a + 2b) - (a + b)\right)x^3 + \left(\frac{5}{8}(a + 2b) - \frac{7}{12}(a + b)\right)x^4 \\ &\quad + \left(\frac{31}{120}(a + 2b) - \frac{1}{4}(a + b)\right)x^5 + \left(\frac{7}{80}(a + 2b) - \frac{31}{360}(a + b)\right)x^6 + \dots \\ &= (a + b) + (a + 2b)x + \left(\frac{1}{2}a + 2b\right)x^2 + \left(\frac{1}{6}a + \frac{4}{3}b\right)x^3 + \left(\frac{1}{24}a + \frac{2}{3}b\right)x^4 + \left(\frac{1}{120}a + \frac{4}{15}b\right)x^5 + \left(\frac{1}{720}a + \frac{4}{45}b\right)x^6 + \dots \\ &= a + ax + \frac{1}{2}ax^2 + \frac{1}{6}ax^3 + \frac{1}{24}ax^4 + \frac{1}{120}ax^5 + \frac{1}{720}ax^6 + \dots + b + 2bx + 2bx^2 + \frac{4}{3}bx^3 + \frac{2}{3}bx^4 + \frac{4}{15}bx^5 + \frac{4}{45}bx^6 + \dots \\ &= a \left(1 + x + \frac{1}{2!}x^2 + \frac{1}{3!}x^3 + \frac{1}{4!}x^4 + \frac{1}{5!}x^5 + \frac{1}{6!}x^6 + \dots \right) + b \left(1 + 2x + \frac{(2x)^2}{2!} + \frac{(2x)^3}{3!} + \frac{(2x)^4}{4!} + \frac{(2x)^5}{5!} + \frac{(2x)^6}{6!} + \dots \right) \\ &= a \sum_{n=0}^{\infty} \frac{x^n}{n!} + b \sum_{n=0}^{\infty} \frac{(2x)^n}{n!} = a e^x + b e^{2x} \end{aligned}$$

$$5. \quad x^2 y'' - 2xy' + 2y = 0 \Rightarrow x^2 \sum_{n=2}^{\infty} n(n-1)c_n x^{n-2} - 2x \sum_{n=1}^{\infty} n c_n x^{n-1} + 2 \sum_{n=0}^{\infty} c_n x^n = 0$$

$$\Rightarrow \sum_{n=2}^{\infty} n(n-1)c_n x^n - \sum_{n=1}^{\infty} 2n c_n x^n + \sum_{n=0}^{\infty} 2c_n x^n = 0$$

<u>power of x</u>	<u>coefficient equation</u>	
x^0	$2c_0 = 0$	$\Rightarrow c_0 = 0$
x^1	$-2(1)c_1 + 2c_1 = 0$	$\Rightarrow 0 = 0$
x^2	$2(1)c_2 - 2(2)c_2 + 2c_2 = 0$	$\Rightarrow 0 = 0$
x^3	$3(2)c_3 - 2(3)c_3 + 2c_3 = 0$	$\Rightarrow c_3 = 0$
x^4	$4(3)c_4 - 2(4)c_4 + 2c_4 = 0$	$\Rightarrow c_4 = 0$
\vdots	\vdots	\vdots
x^n	$n(n-1)c_n - 2n c_n + 2c_n = 0$	$\Rightarrow c_n = 0, n \geq 3$

$$y = c_1 x + c_2 x^2$$

$$6. \quad y'' - xy' + y = 0 \Rightarrow \sum_{n=2}^{\infty} n(n-1)c_n x^{n-2} - x \sum_{n=1}^{\infty} n c_n x^{n-1} + \sum_{n=0}^{\infty} c_n x^n = 0$$

$$\Rightarrow \sum_{n=2}^{\infty} n(n-1)c_n x^{n-2} - \sum_{n=1}^{\infty} n c_n x^n + \sum_{n=0}^{\infty} c_n x^n = 0$$

<u>power of x</u>	<u>coefficient equation</u>	
x^0	$2(1)c_2 + c_0 = 0$	$\Rightarrow c_2 = -\frac{1}{2}c_0$
x^1	$3(2)c_3 - (1)c_1 + c_1 = 0$	$\Rightarrow c_3 = 0$
x^2	$4(3)c_4 - (2)c_2 + c_2 = 0$	$\Rightarrow c_4 = \frac{1}{12}c_2 = -\frac{1}{24}c_0$
x^3	$5(4)c_5 - (3)c_3 + c_3 = 0$	$\Rightarrow c_5 = \frac{1}{10}c_3 = 0$
x^4	$6(5)c_6 - (4)c_4 + c_4 = 0$	$\Rightarrow c_6 = \frac{2}{15}c_4 = -\frac{1}{180}c_0$
\vdots	\vdots	\vdots
x^n	$(n+2)(n+1)c_{n+2} - n c_n + c_n = 0$	$\Rightarrow c_{n+2} = -\frac{n-1}{(n+2)(n+1)}c_n$

$$y = c_0 + c_1 x - \frac{1}{2}c_0 x^2 - \frac{1}{24}c_0 x^4 - \frac{1}{180}c_0 x^6 + \dots = c_0 \left(1 - \frac{1}{2}x^2 - \frac{1}{24}x^4 - \frac{1}{180}x^6 + \dots \right) + c_1 x$$

$$7. \quad (1+x)y'' - y = 0 \Rightarrow (1+x) \sum_{n=2}^{\infty} n(n-1)c_n x^{n-2} - \sum_{n=0}^{\infty} c_n x^n = 0$$

$$\Rightarrow \sum_{n=2}^{\infty} n(n-1)c_n x^{n-2} + \sum_{n=2}^{\infty} n(n-1)c_n x^{n-1} - \sum_{n=0}^{\infty} c_n x^n = 0$$

<u>power of x</u>	<u>coefficient equation</u>	
x^0	$2(1)c_2 - c_0 = 0$	$\Rightarrow c_2 = \frac{1}{2}c_0$
x^1	$3(2)c_3 + 2(1)c_2 - c_1 = 0$	$\Rightarrow c_3 = -\frac{1}{3}c_2 + \frac{1}{6}c_1 = \frac{1}{6}c_1 - \frac{1}{6}c_0$
x^2	$4(3)c_4 + 3(2)c_3 - c_2 = 0$	$\Rightarrow c_4 = -\frac{1}{2}c_3 + \frac{1}{12}c_2 = -\frac{1}{12}c_1 + \frac{1}{8}c_0$
x^3	$5(4)c_5 + 4(3)c_4 - c_3 = 0$	$\Rightarrow c_5 = -\frac{3}{5}c_4 + \frac{1}{12}c_3 = \frac{7}{120}c_1 - \frac{1}{12}c_0$
x^4	$6(5)c_6 + 5(4)c_5 - c_4 = 0$	$\Rightarrow c_6 = -\frac{2}{3}c_5 + \frac{1}{30}c_4 = -\frac{1}{24}c_1 + \frac{43}{720}c_0$
\vdots	\vdots	\vdots
x^n	$(n+2)(n+1)c_{n+2} + n(n+1)c_{n+1} - c_n = 0$	$\Rightarrow c_{n+2} = -\frac{n}{(n+2)}c_{n+1} + \frac{1}{(n+2)(n+1)}c_n$

$$y = c_0 + c_1 x + \frac{1}{2}c_0 x^2 + \left(\frac{1}{6}c_1 - \frac{1}{6}c_0\right)x^3 + \left(-\frac{1}{12}c_1 + \frac{1}{8}c_0\right)x^4 + \left(\frac{7}{120}c_1 - \frac{1}{12}c_0\right)x^5 + \left(-\frac{1}{24}c_1 + \frac{43}{720}c_0\right)x^6 + \dots$$

$$= c_0 \left(1 + \frac{1}{2}x^2 - \frac{1}{6}x^3 + \frac{1}{8}x^4 - \frac{1}{12}x^5 + \frac{43}{720}x^6 + \dots \right) + c_1 \left(x + \frac{1}{6}x^3 - \frac{1}{12}x^4 + \frac{7}{120}x^5 - \frac{1}{24}x^6 + \dots \right)$$

$$8. (1 - x^2)y'' - 4xy' + 6y = 0 \Rightarrow (1 - x^2) \sum_{n=2}^{\infty} n(n-1)c_n x^{n-2} - 4x \sum_{n=1}^{\infty} n c_n x^{n-1} + 6 \sum_{n=0}^{\infty} c_n x^n = 0$$

$$\Rightarrow \sum_{n=2}^{\infty} n(n-1)c_n x^{n-2} - \sum_{n=2}^{\infty} n(n-1)c_n x^n - \sum_{n=1}^{\infty} 4n c_n x^n + \sum_{n=0}^{\infty} 6c_n x^n = 0$$

<u>power of x</u>	<u>coefficient equation</u>	
x^0	$2(1)c_2 + 6c_0 = 0$	$\Rightarrow c_2 = -3c_0$
x^1	$3(2)c_3 - 4(1)c_1 + 6c_1 = 0$	$\Rightarrow c_3 = -\frac{1}{3}c_1$
x^2	$4(3)c_4 - 2(1)c_2 - 4(2)c_2 + 6c_2 = 0$	$\Rightarrow c_4 = \frac{1}{3}c_2 = -c_0$
x^3	$5(4)c_5 - 3(2)c_3 - 4(3)c_3 + 6c_3 = 0$	$\Rightarrow c_5 = \frac{3}{5}c_3 = -\frac{1}{5}c_1$
x^4	$6(5)c_6 - 4(3)c_4 - 4(4)c_4 + 6c_4 = 0$	$\Rightarrow c_6 = \frac{11}{15}c_4 = -\frac{11}{15}c_0$
\vdots	\vdots	\vdots
x^n	$(n+2)(n+1)c_{n+2} - n(n-1)c_n - 4nc_n + 6c_n = 0$	$\Rightarrow c_{n+2} = \frac{n^2+3n-6}{(n+2)(n+1)}c_n$

$$y = c_0 + c_1x - 3c_0x^2 - \frac{1}{3}c_1x^3 - c_0x^4 - \frac{1}{5}c_1x^5 - \frac{11}{15}c_0x^6 - \dots$$

$$= c_0(1 - 3x^2 - x^4 - \frac{11}{15}x^6 - \dots) + c_1(x - \frac{1}{3}x^3 - \frac{1}{5}x^5 - \dots)$$

$$9. (x^2 - 1)y'' + 2xy' - 2y = 0 \Rightarrow (x^2 - 1) \sum_{n=2}^{\infty} n(n-1)c_n x^{n-2} + 2x \sum_{n=1}^{\infty} n c_n x^{n-1} - 2 \sum_{n=0}^{\infty} c_n x^n = 0$$

$$\Rightarrow \sum_{n=2}^{\infty} n(n-1)c_n x^n - \sum_{n=2}^{\infty} n(n-1)c_n x^{n-2} + \sum_{n=1}^{\infty} 2n c_n x^n - \sum_{n=0}^{\infty} 2c_n x^n = 0$$

<u>power of x</u>	<u>coefficient equation</u>	
x^0	$-2(1)c_2 - 2c_0 = 0$	$\Rightarrow c_2 = -c_0$
x^1	$-3(2)c_3 + 2(1)c_1 - 2c_1 = 0$	$\Rightarrow c_3 = 0$
x^2	$2(1)c_2 - 4(3)c_4 + 2(2)c_2 - 2c_2 = 0$	$\Rightarrow c_4 = \frac{1}{3}c_2 = -\frac{1}{3}c_0$
x^3	$3(2)c_3 - 5(4)c_5 + 2(3)c_3 - 2c_3 = 0$	$\Rightarrow c_5 = \frac{1}{2}c_3 = 0$
x^4	$4(3)c_4 - 6(5)c_6 + 2(4)c_4 - 2c_4 = 0$	$\Rightarrow c_6 = \frac{3}{5}c_4 = -\frac{1}{5}c_0$
\vdots	\vdots	\vdots
x^n	$n(n-1)c_n - (n+2)(n+1)c_{n+2} + 2nc_n - 2c_n = 0$	$\Rightarrow c_{n+2} = \frac{n-1}{(n+1)}c_n$

$$y = c_0 + c_1x - c_0x^2 - \frac{1}{3}c_0x^4 - \frac{1}{5}c_0x^6 - \dots = c_0(1 - x^2 - \frac{1}{3}x^4 - \frac{1}{5}x^6 - \dots) + c_1x$$

$$10. y'' + y' - x^2y = 0 \Rightarrow \sum_{n=2}^{\infty} n(n-1)c_n x^{n-2} + \sum_{n=1}^{\infty} n c_n x^{n-1} - x^2 \sum_{n=0}^{\infty} c_n x^n = 0$$

$$\Rightarrow \sum_{n=2}^{\infty} n(n-1)c_n x^{n-2} + \sum_{n=1}^{\infty} n c_n x^{n-1} - \sum_{n=0}^{\infty} c_n x^{n+2} = 0$$

<u>power of x</u>	<u>coefficient equation</u>	
x^0	$2(1)c_2 + (1)c_1 = 0$	$\Rightarrow c_2 = -\frac{1}{2}c_1$
x^1	$3(2)c_3 + (2)c_2 = 0$	$\Rightarrow c_3 = -\frac{1}{3}c_2 = \frac{1}{6}c_1$
x^2	$4(3)c_4 + (3)c_3 - c_0 = 0$	$\Rightarrow c_4 = -\frac{1}{4}c_3 + \frac{1}{12}c_0 = -\frac{1}{24}c_1 + \frac{1}{12}c_0$
x^3	$5(4)c_5 + (4)c_4 - c_1 = 0$	$\Rightarrow c_5 = -\frac{1}{5}c_4 + \frac{1}{20}c_1 = \frac{1}{120}c_1 + \frac{1}{30}c_0$
x^4	$6(5)c_6 + (5)c_5 - c_2 = 0$	$\Rightarrow c_6 = -\frac{1}{6}c_5 + \frac{1}{30}c_2 = -\frac{13}{720}c_1 - \frac{1}{180}c_0$
\vdots	\vdots	\vdots
x^n	$(n+2)(n+1)c_{n+2} + (n+1)c_{n+1} - c_{n-2} = 0$	$\Rightarrow c_{n+2} = -\frac{1}{(n+2)}c_{n+1} + \frac{1}{(n+2)(n+1)}c_{n-2}$

$$y = c_0 + c_1x - \frac{1}{2}c_0x^2 + \frac{1}{6}c_1x^3 + (-\frac{1}{24}c_1 + \frac{1}{12}c_0)x^4 + (\frac{1}{120}c_1 + \frac{1}{30}c_0)x^5 + (-\frac{13}{720}c_1 - \frac{1}{180}c_0)x^6 + \dots$$

$$= c_0(1 - \frac{1}{2}x^2 + \frac{1}{12}x^4 - \frac{1}{180}x^6 + \dots) + c_1(x + \frac{1}{6}x^3 - \frac{1}{24}x^4 + \frac{1}{120}x^5 - \frac{13}{720}x^6 + \dots)$$

$$11. (x^2 - 1)y'' - 6y = 0 \Rightarrow (x^2 - 1) \sum_{n=2}^{\infty} n(n-1)c_n x^{n-2} - 6 \sum_{n=0}^{\infty} c_n x^n = 0$$

$$\Rightarrow \sum_{n=2}^{\infty} n(n-1)c_n x^n - \sum_{n=2}^{\infty} n(n-1)c_n x^{n-2} - \sum_{n=0}^{\infty} 6c_n x^n = 0$$

<u>power of x</u>	<u>coefficient equation</u>	
x^0	$-2(1)c_2 - 6c_0 = 0$	$\Rightarrow c_2 = -3c_0$
x^1	$-3(2)c_3 - 6c_1 = 0$	$\Rightarrow c_3 = -c_1$
x^2	$2(1)c_2 - 4(3)c_4 - 6c_2 = 0$	$\Rightarrow c_4 = -\frac{1}{3}c_2 = c_0$
x^3	$3(2)c_3 - 5(4)c_5 - 6c_3 = 0$	$\Rightarrow c_5 = 0$
x^4	$4(3)c_4 - 6(5)c_6 - 6c_4 = 0$	$\Rightarrow c_6 = -\frac{1}{5}c_4 = -\frac{1}{5}c_0$
\vdots	\vdots	\vdots
x^n	$n(n-1)c_n - (n+2)(n+1)c_{n+2} - 6c_n = 0$	$\Rightarrow c_{n+2} = -\frac{n-3}{(n+1)}c_n$

$$y = c_0 + c_1x - 3c_0x^2 - c_1x^3 + c_0x^4 - \frac{1}{5}c_0x^6 - \dots = c_0(1 - 3x^2 + x^4 - \frac{1}{5}x^6 + \dots) + c_1(x - x^3)$$

$$12. xy'' - (x+2)y' + 2y = 0 \Rightarrow x \sum_{n=2}^{\infty} n(n-1)c_n x^{n-2} - (x+2) \sum_{n=1}^{\infty} n c_n x^{n-1} + 2 \sum_{n=0}^{\infty} c_n x^n = 0$$

$$\Rightarrow \sum_{n=2}^{\infty} n(n-1)c_n x^{n-1} - \sum_{n=1}^{\infty} n c_n x^n - \sum_{n=1}^{\infty} 2n c_n x^{n-1} + \sum_{n=0}^{\infty} 2c_n x^n = 0$$

<u>power of x</u>	<u>coefficient equation</u>	
x^0	$-2(1)c_1 + 2c_0 = 0$	$\Rightarrow c_1 = c_0$
x^1	$2(1)c_2 - (1)c_1 - 2(2)c_2 + 2c_1 = 0$	$\Rightarrow c_2 = \frac{1}{2}c_1 = \frac{1}{2}c_0$
x^2	$3(2)c_3 - (2)c_2 - 2(3)c_3 + 2c_2 = 0$	$\Rightarrow 0 = 0$
x^3	$4(3)c_4 - (3)c_3 - 2(4)c_4 + 2c_3 = 0$	$\Rightarrow c_4 = \frac{1}{4}c_3$
x^4	$5(4)c_5 - (4)c_4 - 2(5)c_5 + 2c_4 = 0$	$\Rightarrow c_5 = \frac{1}{5}c_4 = \frac{1}{20}c_3$
\vdots	\vdots	\vdots
x^n	$(n+1)n c_{n+1} - n c_n - 2(n+1)c_{n+1} + 2c_n = 0$	$\Rightarrow c_{n+1} = \frac{1}{(n+1)}c_n$

$$y = c_0 + c_0x + \frac{1}{2}c_0x^2 + c_3x^3 + \frac{1}{4}c_3x^4 + \frac{1}{20}c_3x^5 + \dots = c_0(1 + x + \frac{1}{2}x^2) + c_3(x^3 + \frac{1}{4}x^4 + \frac{1}{20}x^5 + \dots)$$

$$13. (x^2 - 1)y'' + 4xy' + 2y = 0 \Rightarrow (x^2 - 1) \sum_{n=2}^{\infty} n(n-1)c_n x^{n-2} + 4x \sum_{n=1}^{\infty} n c_n x^{n-1} + 2 \sum_{n=0}^{\infty} c_n x^n = 0$$

$$\Rightarrow \sum_{n=2}^{\infty} n(n-1)c_n x^n - \sum_{n=2}^{\infty} n(n-1)c_n x^{n-2} + \sum_{n=1}^{\infty} 4n c_n x^n + \sum_{n=0}^{\infty} 2c_n x^n = 0$$

<u>power of x</u>	<u>coefficient equation</u>	
x^0	$-2(1)c_2 + 2c_0 = 0$	$\Rightarrow c_2 = c_0$
x^1	$-3(2)c_3 + 4(1)c_1 + 2c_1 = 0$	$\Rightarrow c_3 = c_1$
x^2	$2(1)c_2 - 4(3)c_4 + 4(2)c_2 + 2c_2 = 0$	$\Rightarrow c_4 = c_2 = c_0$
x^3	$3(2)c_3 - 5(4)c_5 + 4(3)c_3 + 2c_3 = 0$	$\Rightarrow c_5 = c_3 = c_1$
x^4	$4(3)c_4 - 6(5)c_6 + 4(4)c_4 + 2c_4 = 0$	$\Rightarrow c_6 = c_4 = c_0$
\vdots	\vdots	\vdots
x^n	$n(n-1)c_n - (n+2)(n+1)c_{n+2} + 4nc_n + 2c_n = 0$	$\Rightarrow c_{n+2} = c_n$

$$y = c_0 + c_1x + c_0x^2 + c_3x^3 + c_1x^4 + c_1x^5 + c_0x^6 - \dots = c_0(1 + x^2 + x^4 + x^6 + \dots) + c_1(x + x^3 + x^5 + \dots)$$

$$14. y'' - 2xy' + 4y = 0 \Rightarrow \sum_{n=2}^{\infty} n(n-1)c_n x^{n-2} - 2x \sum_{n=1}^{\infty} n c_n x^{n-1} + 4 \sum_{n=0}^{\infty} c_n x^n = 0$$

$$\Rightarrow \sum_{n=2}^{\infty} n(n-1)c_n x^{n-2} - \sum_{n=1}^{\infty} 2n c_n x^n + \sum_{n=0}^{\infty} 4c_n x^n = 0$$

<u>power of x</u>	<u>coefficient equation</u>	
x^0	$2(1)c_2 + 4c_0 = 0$	$\Rightarrow c_2 = -2c_0$
x^1	$3(2)c_3 - 2(1)c_1 + 4c_1 = 0$	$\Rightarrow c_3 = -\frac{1}{3}c_1$
x^2	$4(3)c_4 - 2(2)c_2 + 4c_2 = 0$	$\Rightarrow c_4 = 0$
x^3	$5(4)c_5 - 2(3)c_3 + 4c_3 = 0$	$\Rightarrow c_5 = \frac{1}{10}c_3 = -\frac{1}{30}c_1$
x^4	$6(5)c_6 - 2(4)c_4 + 4c_4 = 0$	$\Rightarrow c_6 = \frac{2}{15}c_4 = 0$
\vdots	\vdots	\vdots
x^n	$(n+2)(n+1)c_{n+2} - 2n c_n + 4c_n = 0$	$\Rightarrow c_{n+2} = \frac{2(n-1)}{(n+2)(n+1)}c_n$

$$y = c_0 + c_1x - 2c_0x^2 - \frac{1}{3}c_1x^3 - \frac{1}{30}c_1x^5 - \dots = c_0(1 - 2x^2) + c_1(x - \frac{1}{3}x^3 - \frac{1}{30}x^5 - \dots)$$

$$15. y'' - 2xy' + 3y = 0 \Rightarrow \sum_{n=2}^{\infty} n(n-1)c_n x^{n-2} - 2x \sum_{n=1}^{\infty} n c_n x^{n-1} + 3 \sum_{n=0}^{\infty} c_n x^n = 0$$

$$\Rightarrow \sum_{n=2}^{\infty} n(n-1)c_n x^{n-2} - \sum_{n=1}^{\infty} 2n c_n x^n + \sum_{n=0}^{\infty} 3c_n x^n = 0$$

<u>power of x</u>	<u>coefficient equation</u>	
x^0	$2(1)c_2 + 3c_0 = 0$	$\Rightarrow c_2 = -\frac{3}{2}c_0$
x^1	$3(2)c_3 - 2(1)c_1 + 3c_1 = 0$	$\Rightarrow c_3 = -\frac{1}{6}c_1$
x^2	$4(3)c_4 - 2(2)c_2 + 3c_2 = 0$	$\Rightarrow c_4 = \frac{1}{12}c_2 = -\frac{1}{8}c_0$
x^3	$5(4)c_5 - 2(3)c_3 + 3c_3 = 0$	$\Rightarrow c_5 = \frac{3}{20}c_3 = -\frac{1}{40}c_1$
x^4	$6(5)c_6 - 2(4)c_4 + 3c_4 = 0$	$\Rightarrow c_6 = \frac{1}{6}c_4 = -\frac{1}{48}c_0$
\vdots	\vdots	\vdots
x^n	$(n+2)(n+1)c_{n+2} - 2n c_n + 3c_n = 0$	$\Rightarrow c_{n+2} = \frac{2n-3}{(n+2)(n+1)}c_n$

$$y = c_0 + c_1x - \frac{3}{2}c_0x^2 - \frac{1}{6}c_1x^3 - \frac{1}{8}c_0x^4 - \frac{1}{40}c_1x^5 - \frac{1}{48}c_0x^6 - \dots$$

$$= c_0(1 - \frac{3}{2}x^2 - \frac{1}{8}x^4 - \frac{1}{48}x^6 - \dots) + c_1(x - \frac{1}{6}x^3 - \frac{1}{40}x^5 - \dots)$$

$$16. (1-x^2)y'' - xy' + 4y = 0 \Rightarrow (1-x^2) \sum_{n=2}^{\infty} n(n-1)c_n x^{n-2} - x \sum_{n=1}^{\infty} n c_n x^{n-1} + 4 \sum_{n=0}^{\infty} c_n x^n = 0$$

$$\Rightarrow \sum_{n=2}^{\infty} n(n-1)c_n x^{n-2} - \sum_{n=2}^{\infty} n(n-1)c_n x^n - \sum_{n=1}^{\infty} n c_n x^n + \sum_{n=0}^{\infty} 4c_n x^n = 0$$

<u>power of x</u>	<u>coefficient equation</u>	
x^0	$2(1)c_2 + 4c_0 = 0$	$\Rightarrow c_2 = -2c_0$
x^1	$3(2)c_3 - (1)c_1 + 4c_1 = 0$	$\Rightarrow c_3 = -\frac{1}{2}c_1$
x^2	$4(3)c_4 - 2(1)c_2 - (2)c_2 + 4c_2 = 0$	$\Rightarrow c_4 = 0$
x^3	$5(4)c_5 - 3(2)c_3 - (3)c_3 + 4c_3 = 0$	$\Rightarrow c_5 = \frac{1}{4}c_3 = -\frac{1}{8}c_1$
x^4	$6(5)c_6 - 4(3)c_4 - (4)c_4 + 4c_4 = 0$	$\Rightarrow c_6 = \frac{2}{5}c_4 = 0$
\vdots	\vdots	\vdots
x^n	$(n+2)(n+1)c_{n+2} - n(n-1)c_n - n c_n + 4c_n = 0$	$\Rightarrow c_{n+2} = \frac{n-2}{(n+1)}c_n$

$$y = c_0 + c_1x - 2c_0x^2 - \frac{1}{2}c_1x^3 - \frac{1}{8}c_1x^5 - \dots = c_0(1 - x^2) + c_1(x - \frac{1}{2}x^3 - \frac{1}{8}x^5 - \dots)$$

$$17. \quad y'' - xy' + 3y = 0 \Rightarrow \sum_{n=2}^{\infty} n(n-1)c_n x^{n-2} - x \sum_{n=1}^{\infty} n c_n x^{n-1} + 3 \sum_{n=0}^{\infty} c_n x^n = 0$$

$$\Rightarrow \sum_{n=2}^{\infty} n(n-1)c_n x^{n-2} - \sum_{n=1}^{\infty} n c_n x^n + \sum_{n=0}^{\infty} 3c_n x^n = 0$$

<u>power of x</u>	<u>coefficient equation</u>	
x^0	$2(1)c_2 + 3c_0 = 0$	$\Rightarrow c_2 = -\frac{3}{2}c_0$
x^1	$3(2)c_3 - (1)c_1 + 3c_1 = 0$	$\Rightarrow c_3 = -\frac{1}{3}c_1$
x^2	$4(3)c_4 - (2)c_2 + 3c_2 = 0$	$\Rightarrow c_4 = -\frac{1}{12}c_2 = \frac{1}{8}c_0$
x^3	$5(4)c_5 - (3)c_3 + 3c_3 = 0$	$\Rightarrow c_5 = 0$
x^4	$6(5)c_6 - (4)c_4 + 3c_4 = 0$	$\Rightarrow c_6 = \frac{1}{30}c_4 = \frac{1}{240}c_0$
\vdots	\vdots	\vdots
x^n	$(n+2)(n+1)c_{n+2} - n c_n + 3c_n = 0$	$\Rightarrow c_{n+2} = \frac{n-3}{(n+2)(n+1)}c_n$

$$y = c_0 + c_1x - \frac{3}{2}c_0x^2 - \frac{1}{6}c_1x^3 + \frac{1}{8}c_0x^4 + \frac{1}{240}c_0x^6 - \dots = c_0\left(1 - \frac{3}{2}x^2 + \frac{1}{8}x^4 + \frac{1}{240}x^6 + \dots\right) + c_1\left(x - \frac{1}{3}x^3\right)$$

$$18. \quad x^2y'' - 4xy' + 6y = 0 \Rightarrow x^2 \sum_{n=2}^{\infty} n(n-1)c_n x^{n-2} - 4x \sum_{n=1}^{\infty} n c_n x^{n-1} + 6 \sum_{n=0}^{\infty} c_n x^n = 0$$

$$\Rightarrow \sum_{n=2}^{\infty} n(n-1)c_n x^n - \sum_{n=1}^{\infty} 4n c_n x^n + \sum_{n=0}^{\infty} 6c_n x^n = 0$$

<u>power of x</u>	<u>coefficient equation</u>	
x^0	$6c_0 = 0$	$\Rightarrow c_0 = 0$
x^1	$-4(1)c_1 + 6c_1 = 0$	$\Rightarrow c_1 = 0$
x^2	$2(1)c_2 - 4(2)c_2 + 6c_2 = 0$	$\Rightarrow 0 = 0$
x^3	$3(2)c_3 - 4(3)c_3 + 6c_3 = 0$	$\Rightarrow 0 = 0$
x^4	$4(3)c_4 - 4(4)c_4 + 6c_4 = 0$	$\Rightarrow c_4 = 0$
\vdots	\vdots	\vdots
x^n	$n(n-1)c_n - 4n c_n + 6c_n = 0$	$\Rightarrow c_n = 0$

$$y = c_2x^2 + c_3x^3$$